

The background of the cover is a nighttime photograph of a bridge over a body of water. The bridge has several towers and is illuminated with warm yellow and white lights. The lights create long, shimmering reflections on the dark water below. The sky is a deep, dark blue.

F. Shkrudnev

N. Levashov's
«SvetL Broom»
in A. Khatybov's
«Bath School»

Book 2. The Bath School

Life goes on...

BERSERKER

BOOKS



Feodor Shkrudnev

Life goes on...

**N. Levashov's «SvetL Broom» in A.
Khatybov's «Bath School» and a
Labour Spade**

**The continuation of the third volume
of the monograph «The Mirror of My Soul»,
not completed by Bicolai Levashov**

**BOOK 2. The Bath School
(who and in what way is wahsed in the bath)**

Translated from Russian by Alla Khabenskaya

Saint-Petersburg 2017

Foreword

One of Man's missions on being on the Earth is the cognition of the world around him and adaptation to it with the purpose of his development and improvement of life in the Rational orientation direction. In this process, Man's quality such as Creative always manifests itself. A Creative person always calls into being what there was not before, and responds to one of humanity's needs. Alas, the creative is not taught anywhere, and the inquiring minds are trying to find ways to solution of tasks entrusted on them by themselves. That's why it's of great importance here the example of the strategy of the specific creative personality unfolded in time and space, and having made a significant contribution to the development of our civilization in this direction. And such a personality is Levashov Nicolai Viktorovich, who during his short life played the most complicated "chess game" with the System, starting with the debut and finishing with the mate to the System. He came out of it as a winner, he called for an army of followers and admirers, among whom the author of this book.

But, as shown by another **genius** – **A.M. Khatybov**, it is not sufficient to know about the Truth, so that to implement it into practice; in addition, you have **to transform** your **brain** so that it could be receptive to New knowledge. And for this, first, you have to take the "Bath" and have a good "washing." So that the washing process would be a success, the author of this book suggests taking a "broom" and a "big spade", explaining why you still have to take the "Bath" and why you need a "broom" and a "big spade" there. But you have to be able to get into the "Bath", so the author tells you how to do it or what to do so that you are **WOULD NOT BE FORGOTTEN** to be invited. Neither the official science, nor we, its users, practically knew anything *what the Brain really is, but thanks to N. V. Levashov and A.M. Khatybov, and now the author of the book, we have penetrated into the secret of the holy of holies.*

A man gets used to the knowledge that is given to him by science in the process of Cognition very quickly, whereby it often becomes a brake in his development, blocking the Reason. Realizing this, the author warns readers – **DO NOT BE AFRAID** of breaking the stereotypes, make use of your intuition, imagination and fantasy as integral instruments of

your own development, since the Reason in its potential is as infinite as the Cosmos itself, and the Consciousness, Reason and Matter are inseparable parts of the single reflecting the Law of unity of all. And all this in general is aimed at shaping *the concept of a new worldview*.

The goal is signified and understandable. But when there come out works similar to the one that the author of this book has done, those who first come across the New knowledge have the question: who is this author, what has he showed his worth to take the liberty of writing about the questions which Science has not been able to answer so far?

The answers to the first questions are easy to find by going to the website of F.D. Shkrudnev. There you can know about his contribution to the development and implementation of New Technologies left to us by N.V. Levashov. Different categories of readers will have different questions: people of science will pay attention to the author's degree, the level of scientific substantiation of the text of the book, the author's language, the way of material presentation, the evidence basis, rather broad scope of topics (from the physics of the Cell, Brain and to Physics of Energies) and, necessarily, – for the availability of scientific publications in the "HAC" (the Higher Attestation Commission) and in foreign publications, etc. Readers, not burdened with academic degrees and titles, will pay attention to the language with a lot of so far incomprehensible terms and words. They will pay attention to a large number of illustrations typical of popular publications, the wideness of the scope of problems that are explained by the same language, and the presence of extra something, of which we have never been heard, because much of what is written contradicts their personal experience and knowledge. But all this is connected with knowledge about Man and the world in which he lives in the whole range of functioning of his systems and subsystems.

So it is accepted in our world (where every gopher is an agronomist!) – The majority initially have an aversion to unusual information (I have not heard about it before, so this can not be), i.e. it is simply impossible what the author writes about. "Agronomists" immediately postpone further reading and pronounce their verdict: nonsense or delirium! But those who want to sort out gradually get interested, that turns into the belief that you have to finish reading and get at the meaning of all this unusual information. There are many who starting to read the books of N.V. Levashov (written intelligibly), come to articles by Khatybov A.M. (Somewhat more complicated, but understandable), then to the "Fundamentals of the

Mankind Formation"; the work, which has already revealed a lot to some of us. And now all this must be combined together so that it would be clear to everyone. The author of the book has taken this burden on himself. It should be noted that this is a very difficult task for any person who first gets down to its solving. Shkrudnev F.D. has been a success.

To make the book a continuation of what Nicolai Viktorovich left us and find its readers, the author had to find **his own style and form of presentation, his language, his vision and understanding of the problem**, because adjusting to someone and "writing for someone" means, immediately doom yourself and your work to failure. Here such complexities had to be overcome to make the book work. **And the book works**. It will depend on the it how fast New knowledge can capture the people's consciousness, the more so, that access to new knowledge is mainly possible through the Internet – through the sites on which they are presented in articles and books. But before that the New knowledge will have to go through three stages of implantation in accordance with the law of preservation of stupidity. **The 1-st stage: it can not be, because it can not be ever; the 2-nd stage: in this there is something ..; the 3-d stage: and who did not know ...** Until the stupidity of the first two stages is expressed, the third one will not come.

So, the 1st stage: It can not be...

It is created not only by those who are not yet grown up for new knowledge, but exactly those who, by their social status, should implement everything New and useful for the society – they are representatives of Science.

We call New knowledge the New Science, the founders of which are such Russian scientists as Levashov N.V, Khatybov A.M, Morozov N.A. etc. And here arise the questions at the level of a layman: why, if the New knowledge is true, it is not being imbedded? And what is real science then? If there is something to say about modern science, then it is a huge hierarchical system consisting of a large number of "pyramids" (see a one-dollar piece of paper), below the tops of which are the leading figures of science (academicians, managers from science) and their surroundings, serving the interests of those who are at the top of the pyramid. On the lower floors are those who agree with the rules of ascending to the top of the pyramid. At the very top are the rulers of people's destinies, as they think of themselves.

The system of pyramids is a sort of cobweb that holds in leash everyone who stands lower on the hierarchy. Even ordinary references in the thesis to the coryphaeus in this science are required, which have not created anything new for a long time, but they **keep** in their hands, especially the new growth, pushing down all those who do not fit into the pyramid and want to be independent of it. Independent creative work **is not welcome** here. That's why **they do not teach creative work** in kindergarten, at school, or universities again considering this as the privilege of the selected. Levashov N.V. and Khatybov A.M. did not fit into this pyramid. From the first steps they were **outcasts**, which is sufficiently detailed in the book. This is one of the reasons why it is so difficult to introduce something new. The real science, as its history shows, is done by **enlightened dilettanti** who are not narrow specialists in a certain branch of science, they do not have the "necessary" knowledge, they have no restrictions on anything, and they see the problem as it really is. Such dilettanti are possessed with the idea of knowing the problem which they get down to. They do not have official degrees or ranks, they do not hurry and do their work thoroughly, working for the future, without thinking about rewards and glory, they always go not in the way that the coryphaeus set, so no one "catches them up". The "dilettanti" do not have stereotypes and stamps, which are taught from the kindergarten, there are no prohibitions, there is no taboo on these or other thoughts, they have no indisputable authority, and in their work they **do not look back** at every opinion of **the real amateurs** from science, more so from the committee to fight pseudoscience.

The question is often asked: what would have happened if there had not been a certain scientist, had his theory been created or not? If there had not been M.V. Lomonosov, who discovered the law of conservation of energy and matter in **1748**, Lavoisier would have discovered it in a hundred years, then Mayer – in **1841**, the English Joule and Grove – in **1843**, Helmholtz – in **1847.**, and also later – the Danish engineer Kolding, since there was **a need** for the discovery of these laws, eliminating many of the contradictions that arise on the path of researcher workers. If there had not been N.V. Levashov, there would not be **such integrated information** that he left to us and which for many of us becomes our Knowledge.

It is necessary to know and understand that science, like any complex system, develops according to special **laws** that can **be known** and used for its **planned development**. But so far it is considered in science that everything depends on the talent, natural abilities, human genius, his habits, and similar stupidities. However, a man becomes a genius after solving an

important problem, not earlier. In the future, more often, as history shows, the "genius" no longer makes discoveries and rests on primary laurels, and his bibliographers invent one story from his life more beautiful than the other, casting a gloss in the image of a newly made genius. Here the psychologists are zealous and when studying the creative work of a scientist, as a rule, do not have any idea about him, they have never solved any complicated scientific problem by themselves, except for "psychological" cubes, squares, and the like. That's why Nicolai Viktorovich himself wrote his autobiography in advance, having stated in it in normal Russian what is important for him, as a scientist and a personality, a historical one now. About his strategy, as a creative personality, is sufficiently detailed in the book. True, "serious" scholars do not read such books, where there is no senselessness, but there is information they do not even know about, and which is expressed in "unscientific language", and therefore it is unreliable. And what then should be the language of science, so that such books could be read by everyone?

Most of the representatives of science believe that it should be strictly "scientific", logical, not to cause multiplicity in reading, i.e. be clear only to specialists. And if earlier, before the reforms of the Russian language, the word carried an image in itself, then since 1918 the Russian language has become imageless thanks to the reforms of Lunacharsky A. and C^o. Read the textbook on electrical engineering of the late 19th century, and you will see that there was another scientific language, i.e. a real Russian language. It is not by chance that **ordinary** people try to read popular literature, which is often loose interpretation from scientific language into Russian, permitting inaccuracies and fictions. And is there any single, general scientific language?

Nowadays, in each scientific area, a professional language has been developed that is intelligible only to its apologists, so the nuclear physicist does not understand the physics of celestial mechanics, etc. It turns out that there is no general scientific language. So is it worth inventing a bicycle when it's already created – is it the Great and Mighty Russian Language? Is it time to write science in Russian, in normal Russian? A great number of loan words from English, French, German and Greek, which are secondary languages, does not solve the problem at all, because you still need to know the translations of these loans. It comes to the point of absurdity.

Thus, so that the child in the form of a new theory, invention and other intellectual product could step into life, you have to learn to write in normal

Russian, which is many times richer than any other language, as the author of the book writes in one of the chapters. And do not invent a parallel language, in which only a small group of scientists communicates.

The 2-nd stage. In this there is something...

If you follow the pace of the introduction of this or that knowledge by the science you might not get it, since New knowledge should supersede some obsolete, which means to doubt it. But it will not be allowed by those who control science and carefully watch out for the established "order". At best, it is allowed to correct some knowledge for which someone has got a degree, a title, bonuses, honor, and the like attributes of success. And it also happens that they simply miss a major discovery, such as the scientific discovery "*The phenomenon of thermoelastic equilibrium in phase transformations of the martensitic type – the Kurdyumov effect*". The discovery was done by compatriots – G.V. Kurdyumov and L.G. Khandros on March 8, 1948, but the diploma for the discovery number 239 the authors got in 1980, i.e. in 32 years. In other words, sometimes it takes quite a time to be told at the top: in this there is something! It is clear now that it is necessary to change the very system of Science (RAS), its structure, so that it would not be the lot of the selected and not consist of pyramids, and that would not be temptation to climb up on it, and everyone wishing to work in science, would work honestly, knowing that everyone would be heard.

Let's go back to the book that is before us – it should be noted that the book has come of. Hence, the second stage of implementation is coming: *there is something in this* ... And I believe that soon the time will come when the majority will say about New Knowledge: **And who did not know that!**

*Candidate of Technical Sciences,
Professor, I.M. Kondrakov*

Introduction, or the wish in the reality ...

The only person who you should compare yourself with is you in the past. And the only person you should be better is you at present.

The principal quality of knowledge, science, the process of the reality perception is *open-mindedness* to changes, continuous *variability* in the mode of *thinking* and its content. The activity of the mind is the driving force of knowledge! The abundance of fruit is the result! As **N. Levashov** used to say, sooner or later there come out research workers who give up seeking innovations in the old tracks, who begin disturbing once established formulations of the nature laws, making scientific concepts lose their universality. Perhaps the point is that, by his conclusions, **N. Levashov** brought us close to unraveling the fact that has been stirring the minds of people, since the depths of centuries that the development of mankind is under the invisible control of a **CERTAIN FOREIGN POWER, HAVING ITS LOYAL SERVANTS** amid mankind itself. They are those "throttles and servants of darkness" (dark forces) that control the development of the "official" science, carefully ensuring that ordinary people would not be able to free themselves from the delusion of the parasitic satanic system that has trapped their consciousness with the psyche-information web. And it is to this hostile force that various occult and religious societies, orthodox religions and official scientific structures like the pseudo-scientific commission of the Russian Academy of Sciences serve. Fulfilling the will of their masters, they subject to persecution the researchers of new knowledge, not fitting into their canons in order to hamper the development of Mankind. But the point is that they will never fulfill this task. I think that after reading the first book of my narrative, the reader has already begun to realize it. The present day science is entirely built on faith in the authority of its predecessors, the importance of tradition, and the "objectivity" of the truth achieved. For all that, few people are embarrassed by the fact that the number of scientists who has observed the birth of new particles is smaller by orders of magnitude than people who personally watched, for example, the Holy Fire (when it was possible to watch it) or those who outlived their own presentiments - I'm not talking about the burning problem of

"improbable" coincidences which everyone comes across in one's life and which increasingly become the subject of scientific study. Like any faith, the belief in the omnipotence of physical laws is in principle unfounded - following the Kantian "scandal for philosophy".¹ One can say this was a "scandal for science". For the last three centuries **FAITH IN SCIENCE** has really had a nearly religious character: *"Belief in the truth of scientific knowledge in the second half and the end of the XIX century often outweighed the religious faith"*.

Today, alas, our schools and universities teach not so much the movement forward, dynamics, development, as stops, finals, "completed" knowledge. Science is presented as a built temple, although, in my deep conviction, we have not yet gone beyond the "zero cycle", the foundation, the origin point. Scientific work begins with the processes that are going on in our consciousness, and **OUR CONSCIOUSNESS IN THE PROCESS OF KNOWLEDGE DOES NOT HAVE TO STAGNATE IN THE KNOWN**, it must follow the path of modernization and renovation, and not along the path of some teachers, the so-called "scientists", university professors, with their courses of lectures rather closing, than opening new ways. Nothing happens by chance, everything has an initial cause. Any phenomenon has many sides, and this leads to unjustified discussions, in which opponents defend their curtailed "truth" from their "point of view". All this is a typical consequence of the differentiation of knowledge, replacing the integrity and unity of consciousness-being with its primitive "truths". Alas, human practice is largely built on this shaky ground: an accessible part of reality is taken for the whole reality. This applies to all spheres of human activity, replacing the completeness of reality with schemes and models, taken for science and truthfulness. New paradigms in science are born every time when there are contradictions of the old and new knowledge and there cannot be in another way. Difficulties inevitably arising with an attempt to replace old ideas with new ones indicate that **IN THE DEVELOPMENT OF SCIENCE FAR FROM EVERYTHING LIES IN THE FIELD OF SCIENCE**. Formal evidence and logic are just one layer of ideas, but there are lots of others. When it comes to changing paradigms, not the ideas are changing, but the way of thinking, the quality of consciousness. In order for Ptolemy's system to yield to the Copernican system, it was not the logic of his followers that was required, but a change in the world outlook. I do not think

¹ After J. Berkeley, **J. Kant** called the scandal for philosophy the impossibility to prove the existence of the world outside us theoretically.

that among scientists there are fewer ignoramuses and charlatans than, say, among those who today call themselves psychics, clairvoyants, etc.. What I'm sure of is that so far, unfortunately, **ROMANTICS AND FANTASTS ARE DOING SCIENCE, AND CYNICS AND FEUDALS ARE USING IT**, and this applies not only to the fruits of science, but also to the fruits made by science - the titles, awards, social status, positions, prizes, honor... The claims of science to universality and globality are, at a minimum, incorrect and unrealizable, and its "spiritual dimension", once seemed to be radiant, *has become much faded and rusted after the numerous obscenities of "scientific and technological progress"*. If scientists are judged not by their declarations, but by their deeds, then God's image of science is fading right before our eyes, for atomic bombs and poisonous gases are unlikely to be able to compensate computers, televisions and refrigerators. The most dangerous principle for mankind, due to which ignorance, obscurantism, backwardness in science have always flourished is first condemnation, and then investigation. How good it is that facts can not be forbidden!! They can only be hushed up. But not forever... *You can hide the truth from everyone - but not for long. You can hide the truth for a long time - but not from everyone. BUT IT IS IMPOSSIBLE TO HIDE THE TRUTH FROM EVERYONE – AND FOREVER!* It is impossible to count (or rather declare) phenomena, proved on the basis of countless experiments, not trust in worthy researchers and witnesses, reliable well-known facts and experiments, if they confirm something that the "scientists" for some reason did not want or could not perceive and recognize – such a position is not quite scientific. And unworthy. It rather looks like the position of the ostrich... But, unfortunately, such obstacles arise nowadays. This is one of the forms of fanaticism, very aggressive and most dangerous. Aggressive negation of scientifically proved facts, well known throughout the world is a symptomatic phenomenon... Here are well – known examples:

How ridiculous it seemed for the "scientists" when they were told that the "Nautilus" of Jules Verne was not just a fiction, but a fully realizable fact!

1. *Socrates* had to drink cicuta (poison), because he was free from the superstitions of his time.

2. **Anaxagoras** was persecuted, since he dared to teach that the sun is much larger than Peloponnese².

3. **Vasco Núñez de Balboa** was the first European to see the Pacific on September 23, 1513, having overcome the jungle and mountains of the Panama Isthmus with great difficulties. He was awarded for his feat a loop - hanging on a false denunciation.

4. In 1600, **the great Giordano Bruno** said: "I am a member of a non-existing academy, and I do not have colleagues among the holy father's obscurantism!" The result was tragic - he was burned alive. After all, you can not say that the universe is infinite, filled with an infinite number of worlds and is divine in its totality!

5. **Galileo** aroused the indignation of the professors of Florence by saying that there was a kind of planet of Jupiter and the moons of this planet that he had discovered. "The leading lights in science" tried in vain, seeking renunciation and exposing Galileo to sophisticated tortures for his assertion that the Earth is round and revolves around its axis. As you know, Galileo "under the curtain" gave up his renunciation. "And yet it spins!" The play, organized by the masters of the minds of that era, failed.

6. **Cardinals, astronomers and scientists** in the times of Giordano Bruno and Galileo refused to look through the telescope, since the apparatus could not show what it could not (and most important, it must not!) be. And also because they were afraid to be forced to recognize their previous conception of the Universe as erroneous. Everyone could clearly see that the sun revolves around the Earth! How can one object to evidence?

7. In the 16th century **the Spaniard Miguel Servet** nearly solved the riddle of blood circulation, but did not have time – he was also burned in fire. Therefore, this discovery was made much later...

8. **In Italy**, a "crusade" was declared against those who were the first to wear glasses, since it was believed that "glasses are devilry!"

9. **Columbus** was cursed and excommunicated from the church in Salamanca for claiming that the Earth is round. All the "scientists" of that time believed that his journey was an insane undertaking, because he would fall off the edge of the Earth! .. But for some reason he did not fall down.

10. **Galvani** at his time was scornfully called "a frogs' dance teacher" by the "scientists" for his experiments on the effect of electric current on the neuromuscular tissue of a frog.

² Peloponnese – the medieval name of the southern part of the Balkan Peninsula, connected with it by the Corinthian Isthmus.

11. When in England gas lighting was already introduced, **French engineer Lebrue** presented a lighting project for Paris, having created gas lamps in his laboratory, and invited the public for the examination. But they only laughed at him, and no one came to see it. The "scientists" of that time incited the people, stirring them up against the bold inventor. As a result of this persecution on December 2, 1804, Lebrue was brutally murdered by fanatics-hirelings of those in power. And the capital of France, now often called the "city of light", got gas lighting only 14 years later - in 1818. **Even then, the ruling clan was afraid of light!..**

12. **At one time Paris Academy of Sciences** stated that neither hypnosis nor telepathy exist, despite hundreds of experiments and facts convincingly proving the opposite. In such situations they say: "The worse for the facts!" Here is a quotation from the sketch of Art. Zweig "Frans Anton Mesmer": "Since 1820 in every village, every city of France, Europe and America amateur magnetizers have been showing in the crowded halls the examples of the most striking influence on people, neither half-educated nor even a quarter educated person will deny them. But Paris Academy, the one that rejected the lightning rod from Franklin and the Jenner vaccine, that called the Fulton steam vessel a utopia, persists in its senseless arrogance, turns its head away and claims that it sees nothing and has not seen. And so it lasts exactly one hundred years... "

13. **In the newspaper "Moscow Provincial News"** in 1848 a note was written that read: "The petty bourgeois Nikifor Nikitin for the seditious speeches about the flight to the moon to be send to the village of Baikonur..." As they say, "Comments are unnecessary!"

14. **Alexander Graham Bell**, the inventor of the phone (he received the patent in 1876), was persecuted and even arrested for "trying to get money for the implementation of his false claims." "Even if this idea was feasible, it would have no practical value, except for circus tricks," they wrote about him in the newspapers of that time...

15. On March 11, 1878, **physicist Dumonsel** demonstrated Edison phonograph to members of French Academy of Sciences. When the apparatus began to repeat the first phrase recorded by him, one member of the Academy, imbued with the proud consciousness of the "scientific immutability" of his convictions, the traditions of orthodox physics (of that time), rushed to the researcher and grabbed him by the throat, shouting: "We will not let ourselves be deceived by the ventriloquist! "And even after the "scientist "was thoroughly acquainted with the principle of the apparatus, he

still officially declared that this was a fraud, since" no apparatus can convey the sound of a human voice. " "It just can not be..." A familiar song!

16. But the same **Edison**, April 22, 1887, said: "Personally, I am not engaged in the invention of flying ships, as I prefer to devote my time to objects of commercial value, and, at best, an airship will be just an amusing toy. "

17. *The astrophysicist Zoeller* (who died in Leipzig in 1882) showed great courage when he spoke publicly for the truth of the paranormal. "The great men of science" reacted in a way that became very common in the scientific struggle – they declared him crazy. Simply, cheap, convenient and nothing to be proved, either!

18. 1. In 1885, when they decided to build the first railway in Bavaria, *the church and scientific medical "luminaries"* stated that it was, firstly, "the machinations of the devil", and secondly, they oppose it, because "iron roads, if they can really be built, cause serious damage to the health of people, because such a rapid movement would cause concussion of the brain in passengers, and in those who will look at moving trains – dizziness and mental illness! "And they demanded in order to avoid all this – enclosing the railway with two high fences!

19. *Napoleon Bonaparte* called *Fulton*, the builder of a wheeled steamer, crazy. "He wants to send my army to England with the help of boiling water!"

20. *But Fulton* just continued the work of *John Fisk*. The "great scientists" of that time managed to bring this inventor to suicide...

21. *The discovery of radioactive disintegration* was also met with mockery. One of the so-called "scientists" stated that "apparently, the atoms of radium suffer more than others from suicidal-mania (the desire for suicide). Such statements can hardly be considered serious scientific arguments against facts...

22. *The great chemist Lavoisier* together with Paris Academy of Sciences in the late 18th century "knew" that: "meteorites are a fairy tale, because after all, it is clear to the child that there can be no stones in the sky! Therefore, they can not fall from the sky... And the fact that they were found warm – nonsense! Just someone warmed them up!.. "Similar" objections "are not uncommon now. It is necessary to somehow interfere with the development of knowledge! Now, it is clear to us, who is still "necessary for" and what for.

23. *And only the meteor shower* in France in the beginning of the 19th century made the "immortal" Academy lift the dogmatic ban and

allow the emergence of the science of meteorites. For all that, two university professors at Princeton found themselves victims of the meteorite fall and brought its fragments for more accurate research into their university...

24. **And how selflessly** "the scientists" laughed at Edison's "fire in the flasks"...

25. **And how much these "luminaries"** were sure that Marconi would never be able to transmit sound through the air ...

26. **At Morse** and his apparatus "men of science" also laughed heartily!

27. **And what did the "all-knowing"** think of the invention of the television tube? They "knew" that transmitting images through empty space was a wild idea!

28. Was it really possible to take seriously the **Wright brothers** when they tried to build a car that could fly, although it was heavier than air! It was clear to everyone that it would definitely fall! "Outstanding scientists" of the time, of course, said that the Wright brothers were crazy (as it should be in such cases). And "theoretically proved" that this machine could not fly. But it flew nevertheless... (This was not even reported in the newspapers – they thought that no one would believe... anyway, or maybe they did not want to admit their defeat...)

29. **American astronomer S. Newcomb** at the turn of the last century "proved" in a lengthy memorandum that there could be no aircraft - i.e. they could not fly! Also known physicist Helmholtz stated that "Zeppelin" would not fly... All this made it very difficult to work on the device, slowed the beginning of the development of aeronautics.

I took these examples from the report of a remarkable scientist, **Varvara Mikhailovna Ivanova-Kissen** (died on January 17, 1998), a lecturer of MSUIR (Moscow State University of International Relations), who for many years studied unexplainable phenomena of the human psyche. She tirelessly recorded various anomalous phenomena and tried to analyze them from the scientific and philosophical positions. And it was she, the first in the USSR, who declared a person a single energy information complex, which made it possible to take the first step toward explaining mystical and paranormal phenomena. One of the directions of her activity was the development of the principles of controlled psychography, which allows **ANY MAN TO DERIVE KNOWLEDGE** from a truly inexhaustible source of knowledge – the noosphere, information fields, to which we already have practical confirmation thanks to the works of **N. Levashov, A. Khatybov**, and the results of practical application of **"SvetL" Programs** for rather a

long period. But as in the above-mentioned hisTorical examples, there were "forces" in the native land, which did not like very much the research activity of V. Ivanova. She was fired from MSUIR for activities "incompatible with the ideological doctrine of the USSR". Then her laboratory at the Scientific and Technical Society of Radio Engineering was destroyed, and all the research materials disappeared without a trace. Apparently, it was then (and is now) profitable for someone ***to spread and maintain this kind of obscurantism***. And to whom? And what for? Who and what are behind all this? Where do the threads lead? Who manipulates them? What are their aims? Who is that invisible "evil genius"? Who makes profit? Has no one drawn a lesson from the "civilization" development on this planet? And we again and again perpetrate all the same mistakes, the same **CRIMES AGAINST OURSELVES?..** It seems to us that if we climbed a couple more steps up the ladder of the evolution – we have already reached its peak! ***We "know all the laws of nature" – and not a step further! "Science does not allow us!"*** What kind of "science" is it? Whose science is it? Where does it lead to, being so much curtailed?

The most surprising in all this endless chain of facts that have not taught us anything is the terrifying inhumanity of the inhabitants of the Earth of each historical period in relation to themselves! It seems that we are only interested in one thing: to make the course of our development as hard and slow as possible, to create as many obstacles as only possible so that to prevent the best people, the most daring, honest and decisive, to help us move forward! ***I am going to tell you all about it in my books.***

Nothing happens by chance, everything has an original cause. In my opinion, one of the most important ideas in understanding the ongoing is that the perception of information about the world depends not only on the world, but **MAINLY ON THE LEVEL OF OUR CONSCIOUSNESS**. This means ***that the world for each observer is subjective***, because it is completely determined by the level and abilities of perception and storage of information that are present in the mind. The concept of the person's freedom's degree is associated exclusively with the level of self-awareness, self-control. A person is free as much as he controls himself, or more precisely, as much as his Brain controls itself. Consciousness dependence on the surroundings infringes our freedom and in pathological cases leads to ***self-zombifying – the state more or less characteristic of the majority of those who live***. One of the most important things in life is to understand the reality and to constantly change our images in accordance with it, because exactly these images determine our actions and feelings, and the more precise they are,

the easier it is to reach the intended, if, of course, we are able to intend or to plan. It is human to think that what he does not like is wrong, and then arguments for objections are easy to find, and it only prevents him from understanding and planning correctly. **JUST TO HAVE A WISH IS NOT ENOUGH** – you should ask yourself what you intend to do in order to achieve the desired. This is the key moment. **A Great Man** is a person who is either able to perceive the world around him, or tries to change this world according to his own perception. This is the image of **Nikolai Levashov** as I remember him.

Man creates his own theories only because his "instincts" are thought to already include certain tendencies to think correctly from the very beginning. *For example, in my opinion, the Reality consists of physics plus extra something; for example, the Reason...*

I am perfectly aware of the fact that a number of the ideas outlined in this and my other books **MIGHT CAUSE SKEPTICAL ATTITUDE** of professionals, but this happens to everything, for example, "terrain maps", which sooner or later need clarification and revision. I am absolutely not claiming for the "last word", I see my task in showing the complementarities of **DIFFERENT WAYS OF REALITY PERCEPTION**, the more so, in the development of human culture and science about the world around us, "windows into the world", pierced in different spheres, require matching the pictures under observation. This directly relates to understanding the works of **N. Levashov, A. Khatybov** and, for example, **N. Morozov or A. Luchin** concerning the pictures of physical reality. Even people with highly developed potential of their Brains who see the "invisible", can not coherently and clearly describe what they see (usually they are able to tell or depict not more than 30-40% of what they saw, as I noticed) because their "super vision" is not equipped with adequate "maps of the terrain," corresponding to the new observed worlds, even having theoretical knowledge of the works of the authors. In fact, **THEY SEE, BUT DO NOT KNOW** – it is adequate to the sight of Neanderthals, who are wielding sticks in an unknown, mysterious world (no matter how offensive it is, even for me). And here the main thing is not to replace the observed with myths and fairy tales of a different degree of insight. I ran into such a thing when I set the task of portraying the work of the Generator, recently transferred from France to Russia. Each of the participants (observers) **SAW** its operation at the same time **ABSOLUTELY IN A DIFFERENT WAY**. But, of course, there were some details in the work of the Generator, which all participants

of the observation saw equally. This did not allow the Brain of the observers to make up stories.

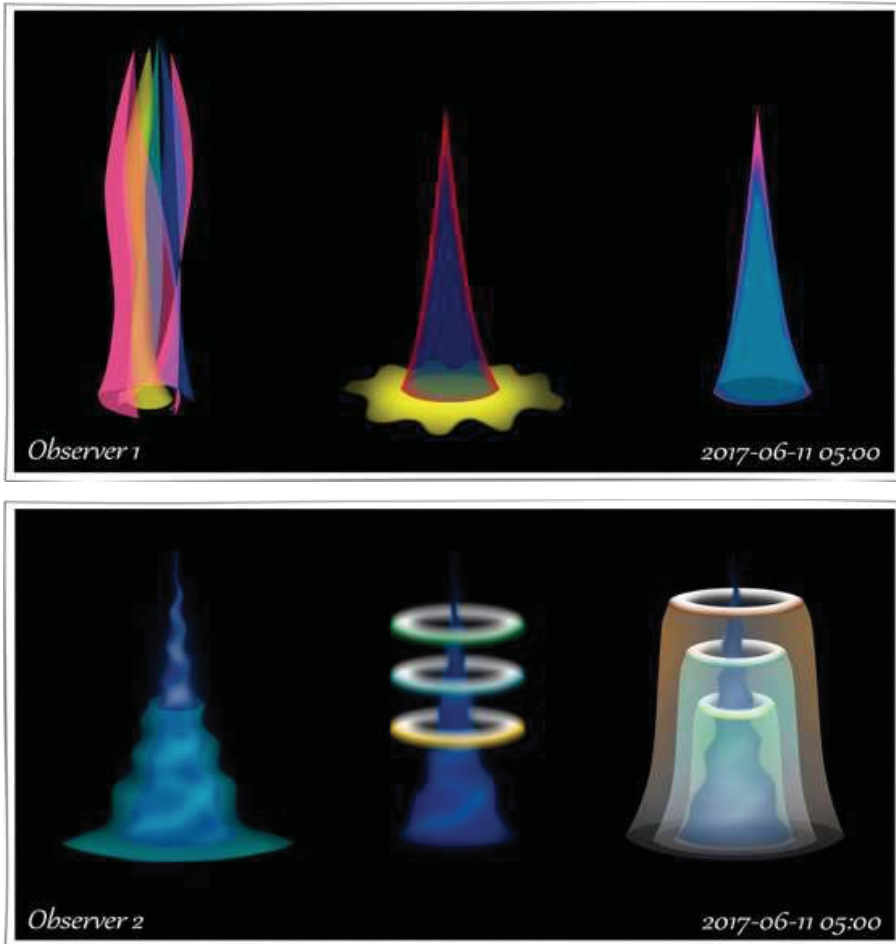

The seriousness of the success was in the fact that such an opportunity to see could be achieved by the observers in rather a short time only thanks to the interaction of the Brain with "**SvetL**" Programs. Without fundamentally new approaches, without opening new levels of reality and the apparatus of their description, one is not able to go beyond empiricism and another fairy tale (although the results of science can to some extent be called another "digitized tale").

The work of human consciousness is not limited to the search of logical operations, and neurons by no means play the role of logical switches by analogy with the computers design. The work of consciousness is based on completely different principles that allow you to make decisions in uncertain situations, with a lack of information and with great, for some reason or

other, unused potential of the Brain. Information space, forms and principles of the Brain formation and existence are a single whole. But to understand and apply all this, we need an instrumental base that allows us to understand the true principles of the Space and Time design. Modern science, including the entire practicality of "shamans from constant pseudoscience" and their equals, do not have this kind of tool base.

Of course, you could describe what you saw as a combination of objects or states, or as information, an organizing structure and state in interaction with something (in relation to the solution of some problem). Then objects and states become just manifestations of information, which, is in reality, in fact. And this allows us to depict such information "on paper". This is what **N. Levashov** did when "drawing" his pictures.

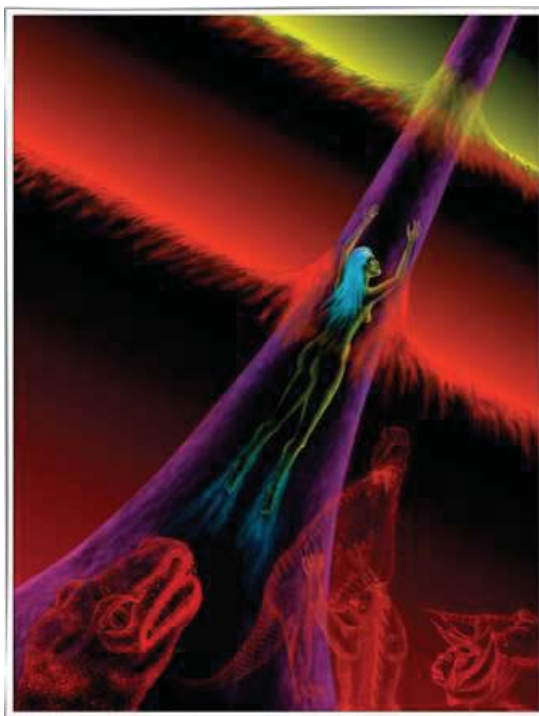

Breakthrough

And if the information really is to replace matter as the most primary substance of the Cosmos, then we can expect even greater reward ... From the modern point of view, the Brain (matter) "gives birth" to thoughts (mental information) ... But if matter is a form of organized information, then consciousness is no longer as mysterious as it seems to us. Now

physicists themselves have started talking about the appearance of matter as "a form of primary and organized information" – **VERILY, "IN THE BEGINNING WAS WORD"!** In both cases, we are dealing with a virtual world, something reminiscent of the all-generating "world-wide computer network».

It's like confirming the fact that everything in this world is governable. What is bad in the scheme for the "foundations of being"? I will tell you about this in the pages of this book. I will also tell you about the so-called "opening the Brain" and enlightenment. By enlightenment, I mean bringing in some key information from an inaccessible source – and it does not matter the way you call it. If man did not possess the gift of thought adapted to his needs, he could never get any knowledge. The more we learn to "rest" on logic, the higher the brain's intellectual activity and its focus on the objective world and the amount of classical information collected about it by our Brain, the lower the degree of initial confusion of consciousness with the environment, and the higher the possibility of "grasping" the higher levels of reality. Exactly in this is the strong point of **Programs "SvetL"** about which you knew when reading the first book and which allows many people to realize all this in the realities of the present day. The development of the **Programs, AS WELL AS LOFTY CREATIVE WORK, WAS "ILLOGICAL"**, because – *only overcoming "impossible" or "not allowed", you can create something really grandiose.* The convergence of the various directions of the world conception is largely facilitated by the continuous expansion of the science boundaries, as well as its gradual, step by step, **REJECTION OF THE OUT-DATED "FUNDAMENTAL PRINCIPLES"** and the criteria of "scientific character". I am convinced that the "religious vestiges" of science, which compel scientists to defend "dead doctrines", are gradually becoming obsolete, just as the sacredly preserved church absolutes of "true faith". Despite the enormous efforts of the academic orthodox to combat "anti-science", I have never been able to find clearly formulated criteria separating pseudoscience from bold scientific hypotheses of a paradigmatic nature. I'd like to clarify here; **the Paradigm** is practically a scientific picture of the world. On the basis of this term, a new paradigm of scientific knowledge has arisen, and to be more precise, this implies recognized scientific achievements, which for a certain time give the scientific community a model of posing problems and their solutions ". As **N. Levashov** used to say, for any science, the scene and the subject of the research, methods of analyzing phenomena are necessary. It is precisely in the absence of these that an

enormous army of ignoramuses and unconcealed charlatans are speculating, profiting on the darkness and ignorance of the majority (unfortunately) of today's living people.

In the process of evolution and progress of scientific cognition, **THE REPLACEMENT OF THE OLD CONCEPTS WITH NEW ONES**; less common theories – with more general and fundamental theories **TAKES PLACE**. And this eventually and inevitably leads to the change of the scientific pictures of the world, but, for all that, there remains the principle of continuity, common to the development of all scientific knowledge. The old picture of the world is not discarded entirely, but continues to retain its significance, only the limits of its applicability are specified. What, in fact, **N. Levashov, and A. Khatybov** used to write about in their works, but at the same time subjecting to severe criticism existing scientific postulates. And today it is being done, but, unfortunately, by too few real scientists and researchers. The scientific image of the world comes into contact with other, unscientific and out-of-scientific images, keeping traces of concrete definitions, or rather, logical operations, revealing the content of concepts (definitions) in the designs and daily notions, individual and public consciousness. For all that, the reverse effect takes place, as well: common ideas become the scientific subjects of research. Therefore, the study of the scientific picture of the world in the culture of modern society gives grounds for the philosophical analysis of the social significance of science itself as a phenomenon of culture; and the study of the dynamic socio-cultural process leads to a change in the Man's world perception, world relation, and worldview. This is the strong point of **N. Levashov's** works, **BEING THE START STEP**, in a completely new, revolutionary understanding of the new knowledge of Man and the new science. These works, in my opinion, are the most influential reconstructions of the logic of the development of science in the second half of the XX-th and the beginning of the XXI-st century, or, if you like, the **SCIENTIFIC REVOLUTIONS IN EVERY DIRECTION**, studied by them. But the scientific picture of the world, discovered by **N. Levashov**, is not just a form of systematization of knowledge, but, primarily, is the research program that determines the formulation of tasks of empirical and theoretical analysis and the choice of means for their solution.

I am more than sure that in the course of the science development and practice (especially, practice and, as an example, the development and application of "**SvetL**" Programs today), the scientific picture of the world will be amended, corrected and improved, but this picture will **NEVER GET**

THE CHARACTER OF THE ABSOLUTE TRUTH. First of all, because it is search and cognition, cognition and search for the new and the promising for the good.

I thought of these books as practical. A theoretical book is read and put on the shelf, but practical one is not only read, but followed in life. I really want it, but it is for you, readers, to judge.

Chapter 1. His checkmate to the System

*The main obstacle to Knowledge
is not a lie but likeness of the Truth.*

Willy-nilly Man has to admit that his life is not limited to his personality from birth to death, and that the goal he is conscious of is the goal attainable! That in the pursuit of it, in the awareness and in the greatest realization of the whole truth (in his life and in the life of the World) it has always been his life work, inseparable from the life of the whole World.

Everything that is associated with the name of **Nicolai Viktorovich Levashov** is a dominant theme of all the chapters of my books. Everything I am writing here is about him. Later, I am going to write about the events that are directly related to his name and that took place in his time and have been taking place after he **IS GONE**. Those who have come across this name for the first time and have known about his works, I very much recommend reading the three parts of his book "**The Mirror of My Soul**". Here are his words from the annotation to this book, from which, in my opinion, much, including my actions is becoming clear: "Of course, everything I described would be subjective, it would reflect the world surrounding me with my own eyes. But, with all this, I will try to reflect everything as objectively as possible. And since this is *my life story, no one will do it better than me*. And if something is wrong, it will be my distortion of my own life story, and it will still be better than the distortions made by someone else. " Comments, as they say, are **NOT NEEDED**. Take the above as my own words, as well.

"The true knowledge is to know that we know what we know and do not know what we do not know," said Confucius. "The false one is to think that we know what we do not know, and we do not know what we know." And we can not give a more precise definition of that false knowledge that reigns in us and that can be refuted if **TO BE RESTED ON THE TRUTH**, and not on the conjectures of all those who seek to be "involved". The falsity of such knowledge was revealed by Nicolai Viktorovich Levashov. Therefore, a desire was born to write **A CHAPTER FULLY DEVOTED TO HIM**, to expound the information that is not presented in his books, but which would complement the already existing information about him. Time has just come

for this presentation, and the collected material has developed into a chapter in a natural way. It is known that, what N. Levashov did and described, from the point of view of those literate enough and authoritative in the scientific world, – **CAN NOT BE!** But the results of his work prove the opposite.

In 2013, in Moscow I met **Igor Mikhailovich Kondrakov**. He lives in the same town as Nicolai's relatives, knows his family well and regularly comes to see his mother. During our meeting we began talking about Levashov. I asked him to collect the most complete information about Nicolai Viktorovich so that I could use it later when writing what I had already planned.



Everything could be of interest: reminiscences of close people, photographs, as well as pictures painted by Nicolai and left to his mother – **Valentina Petrovna**, sister **Marina and Vladimir**, his brother. Each such a thing could enrich our knowledge about this Man. Igor Mikhailovich agreed and did a very great work in this direction. The material he collected we "put" into this chapter together (but not everything). I have already mentioned that this book would be written as a continuation of the fundamental and remarkable work *"The Mirror of My Soul"* and it would be written not only by me, but also by other people who knew N. Levashov. The presented material is organic, expedient, and most important, complements to what is already known about this Man.

I asked myself many times whether I had the right to make public the information about **N. Levashov's** personal life that became known to me for various reasons. And here, take my word for it, – for the years of keeping up with him I learned a lot about this Man and, mainly, from his stories,

memories of himself and the people around him, the examples he gave, which confirmed this or that event, and, of course, everything concerning the technologies being developed. But when I witnessed how some facts from Nickolai's personal life with some kind of sensuality "were being slumped" by those who called themselves friends of his, it deeply hurt my feelings. ***Everyone has the right to his private life, which can become public only with his approval.***



It is like the situation when with certain self-interest the personal letters of two people are made "public" without their permission. As for me, I will write only about the facts that were "agreed" upon in due course with Nicolai's mother – **Valentina Petrovna**, and with **Nicolai**, and also about some facts not related to private life of **Svetlana and Nicolai**.

There are things that can already be public today and there are things that are too early to talk about. For example, today we can talk about the technologies of the so-called "destruction" (retaliation), which had be already applied during the life of Nicolay, and after his passing away. I have already told you something about this and will tell you more. And the private life of Svetlana and Nicolai, his family relationships with his close relatives, to which a certain group of people persistently shows idle curiosity – all this is only a family matter and, in my opinion, **SHOULD NOT BE GIVEN PUBLICITY**. Everything that Nicolai considered necessary to tell, he wrote in the first and second volumes of "**The Mirror of My Soul**". The position

that I adhere to in life and writing this book is that we really know those who have been well estimated. However, very few people are worthy of being estimated. But a really outstanding man, in my opinion, should not strive for being estimated. He perfectly understands that there are only a few who can objectively gauge him, both friends and enemies, and that each of these few has his own likes and dislikes that prevent them from giving his talents as much attention as they deserve. This is an answer to readers' questions that might "appear" after reading this chapter.

From my point of view, it's senseless to focus on studying any facts heard from someone or found on the Internet or voiced by some "competent" people. It is necessary to concentrate one's efforts on understanding the whole and through this prism look at particulars. **N. Levashov** used to tell me, and not only me, that one could not draw any conclusions on the basis of the problem, which one can see only as the top of an iceberg. Conclusions can be made only when **SEEING THE WHOLE** of **THE PROBLEM** (the whole of the iceberg). Unfortunately, among those whom I knew in Levashov's "surroundings" there were very few people who could see on a large scale. I was always amazed at the haste in the conclusions on certain issues and, especially, in the conclusions on specific personalities. There were two questions that I asked many people to which I had not got intelligible answers up to this day. **The first one:** – different people were acquainted with Nicolai, including those who in one way or another represented medicine. I am saying it with full confidence that these were literate and worthy people (but I'd rather keep silent about some representatives of "medicine"), who had read all the works of Levashov. Why did none of them, from the moment of **N. Levashov's** return to his homeland, bring up a question on creating a Complex that would make people healthier and "relieve" Nicolai from long hours of help to those who he **COULD NOT JUST REFUSE TO**? Why, in a rather short period after my acquaintance with him, I, having at that time very vague knowledge in medicine and in the "design" of Man, "brought up" this question and realized what lay on the surface? And **the second question:** – why only at **N. Levashov's** funeral was he named for the first time by me (!) **an Outstanding Russian Scientist**? They gave him various "titles: White Hierarch, Academician, physicist, and Healer – but none of them answered to the true essence of N. Levashov. Only "**Outstanding Russian Scientist N. Levashov**" fully revealed the whole essence of this Man. This title deservedly conformed to N. Levashov, harmoniously coincided with his

essence, did not cause rejection and, we can surely say now, it has firmly taken root in our life.

After his passing away, there immediately appeared people, in the main, "admirers" who "suddenly", for whatever reasons, received a "connection" (in some form) with Nicolai. They "take counsel with him ..." and after that they operate on allegedly given advice «right from Levashov himself". Usually this "connection" takes place "at night" and in a dream. It's always funny and excites nothing but regret. There are many who expect him to "return" to the Earth in one form or another, but mostly through the next incarnation in order to help them and the whole of humanity in solving their problems. But unfortunately, few of them realize that this will not happen, because there is no expediency in it. And the desire to find out "what Nicolai is busy with today", does not show anything but their own ignorance. These people, perhaps, "leafed through" the works of Levashov, but did not even bother to look into them. But unjustly. There is everything written there and, answered why. The reason why people remember and perceive so little out of the read is that they think too little, without bothering themselves about that. Of course, there are many good and useful books in the world available to any reader. But the books of N. Levashov, A. Khatybov and some others are good only for those people **WHO KNOW HOW TO READ THEM**. The ability to read these books is not at all equivalent to literacy.

1.1. The image

February 8, 2017 marked the **56th anniversary** of Nikolay Viktorovich Levashov's birthday. The very date always says little about the Man. There are lots of people who celebrate their birthdays and anniversaries every day, of whom you usually know only about their age and not more. In Nature there is such a process, called sedimentation. And Human life is somewhat like this process, in the long run of which is the remain of one's life – all the accomplished Deeds and Actions, the Heritage that Man has left behind. The rate of sedimentation depends on the Mass and the Volume of the Accomplished within the life, as well as on the Form and Density of the Accomplished... Hence, it is clear that lifespan not yet a criterion by which one can judge a Person as a whole.



The maternity hospital where N. Levashov was born

Nikolay Viktorovich was born, like all of us, under the System, against which he had to fight all his life, but not as a dissident, but as a creative Man with the aim of transforming it. Here, from this position, I want to show the strategy of his Life and his Creative Work – the struggle of the Person bringing new Knowledge to people, against the System for which such people are dangerous and it does not need them. Nicolai initially possessed qualities, which he wrote about in his works.

His life can be considered as a "chess game" with the System. It was a true Grandmaster's party, where he went out of victorious. Ask yourself the questions: "How could Nicolai ever" show up "on the Earth at the moment when the System was beginning to realize its main purpose – *calling into being the main genotype of the Brain to form the "golden million"*? Who "helped" him in this incarnation? And what for was the **DECISION** made to "send" him **EXACTLY AT THAT TIME** so that he would begin to play his "chess" party"?



The first attempt to take away his life was made by the System, when Nicolai was only a few weeks old. His mother, leaving the house for a while, asked his father who had just come home from work to dandle the baby in his arms. The tired father sat down and dozed off. He woke up in a few minutes and did not find the baby in his arms. He got scared, looked down and saw a strange picture – the baby's body was hanging vertically, head down over the stone floor, as if someone or something was holding the baby by the legs, not allowing it to fall down the floor (with all the consequences of it). (That was the **SECOND WINNING MOVE**, which showed much). When this kind of things happens, you realize that even then, initially – with the invaders' arrival and the "conquest" of the Earth – there were forces capable in one way or another to counteract the system **THROUGH SPECIFIC PEOPLE** (evidence of this can be found in the history when delving into it without any preconception).

The first move could not be described, since it is set forth in the **"Fundamentals of the Mankind Formation"** (those interested, can read it), but I am explaining it just like for the "kindergarten". "Up there" gathered good "kind men" in order to take a decision on the "inexpediency of continuing a hostile experiment", which Ebrs were carrying out on the Earth and planned to "finish" it victoriously **by December 2012**. Among those "kind men" there was the Entity, which was called (conditionally) **Illian**. A plan for the termination of this experiment was worked out, but

there was a need in those who would implement the plan on the Earth. It was necessary to transmit the information so that it "would turn" into the knowledge of those who received and perceived it. That was extremely important and necessary. It is necessary for people to begin to understand what is happening, to comprehend the new and take an active part in all relevant events. The question arises – who will go? Here, the decision is taken independently under personal responsibility in accordance with personal resources. There is no situation here when a person takes upon himself a task and takes over a high position in hope of gaining some concomitant benefits or position in society, but has no idea of its solutions. As they say, we have what we have. Sometimes the best decision is not to take any decision.

Illian's decision is accepted and 'approved'. The process of transformation of the Entity is realized. Do you think the Entity of such a level, its Brain, could foresee the development of events and what they could "result in"? I think, it could. And nevertheless, Illian, **HIMSELF TAKES SUCH A DECISION**. If we consider everything in the context of the events taking place, and not the way they are presented to us, then the decision to move the Entity (the Brain) of Radomir (Christ), at one time was taken by him himself (who could foresee the development of events both with his crucifixion, and his "ascension") and realized, as well. I do not compare Levashov and Christ. In no way. Just each of them had **HIS OWN SPECIFIC MISSION**, which was realized. I am more than sure of this. Everyone has his own mission. It is important to understand it. Here's an explanation for you – why the baby "hung" head down and did not die. And if you carefully analyze the events that begin to "unfold" from the birth of Nicolai, as the return of everything on the Earth, and the Earth itself, to its original (Native) state, *which was 18 thousand years ago*, then you begin to understand both the happening and much more.

1.2. The Start

I will repeat myself a little in what had already been written by Nicolai³ – I think it is useful in understanding what is going to be said below. Look at

³ N. Levashov. "The mirror of My Soul". Book 1.

this photo – an ordinary boy with some perkiness in his eyes. He does not know yet what he is to accomplish and experience in his life, so he looks clearly and sincerely at our world and us.

His childhood did not differ much from the childhood of most children. Nicolai was a Jack of all trades, so he was always the leader in the team, although he was younger than some of his friends. Neighbors often complained of **Levash** inventions, that made the children again and again disappear with him in the ravine. Once testing the parachute properties of umbrellas, the children figured it all out – they caught enough, as well as their umbrellas... and not only from the "laws of aerodynamics", but also from their parents. As a result, like all inquisitive children, he used to have his arms and legs all in wounds, are bandaged.



The ravine of a mountain river

Once Nicolai had an unpleasant incident. His mom's stepfather left his car with the engine turned on, and Nicolai accidentally touched the exhaust pipe. As a result – a severe burn, and in the photographs of this period, a three-year-old Kolya is standing with a bandaged leg. But the main thing is that there were no tears and that this burn skinned over in 2-3 days, although usually it takes a couple of weeks.

"Window to the outside world" recently new residents made of fiberglass, but the view remained the same. In the rest, the house has changed little: the same basement and the same dampness. The old residents live out their time, and have not improved their living conditions. All neighbors still remember Nicolai well and deeply grieve over his early death. It was here, under the conditions described, that "the formation and tempering" began, and, to be more precise, the character and fighting qualities of Nicolai were being revived here.





The house in which the family lived, and which is well described by Nicolai in his books



The hydrant to get water



**From left to right:
Nicolai and Vladimir Levashovs, Olga and Vladimir Kozyrevs**



Young investigators on the shore of the pond near Zmeica mountain

Only after getting an apartment in the town of Mineralnye Vody, the family significantly improved their living conditions, and another stage of life began. Nicolai made friends with Vladimir Kozyrev, who had similar interests – both loved to observe and explore the animal world, while reading a lot. The friends spent a lot of time near the pond near Zmeyka mountain where they caught the future "exhibits" of flora and fauna for their research laboratory.

Nicolai made friends mainly with the children from his porch. At the same time he was cheerful and thoughtful, as if he would go into himself, but he always listened to his friends and often smiled. He took the information critically, trying to figure out everything, especially when the information was imposed from outside. He often called Olga Kozyreva a little "witch" (old Russian- a learned woman), and that she could develop her potential. Since then, she has never wanted anything bad for anyone, since her words quickly turned into a reality. And Volodya, after his talks with Nicolai, asked him to open his Brain, since he had good inborn qualities, but very poor health at the same time, so he was refused.

As Olga recollects, Nicolai was a highly spiritual person and **NEVER TOLD A LIE**. Once the children were naughty at home, but Nicolai was not involved in this play. Valentina Petrovna made him stand in the corner, where he stood until dark. When they remembered him, they asked him why he did not admit his fault. He replied that he had had nothing to do with that play, so he did not ask for forgiveness and "pardon".



Nicolai went to an ordinary high school, but much more important is the fact that he learned a lot outside school. His parents subscribed him to the magazine "Young Technician", in which contests were regularly held to

solve a number of technical problems in which he actively participated and from time to time got diplomas for the best inventions. His father was a builder, so, obviously, because of this Nicolai made up his mind to invent a machine for painting large horizontal surfaces.

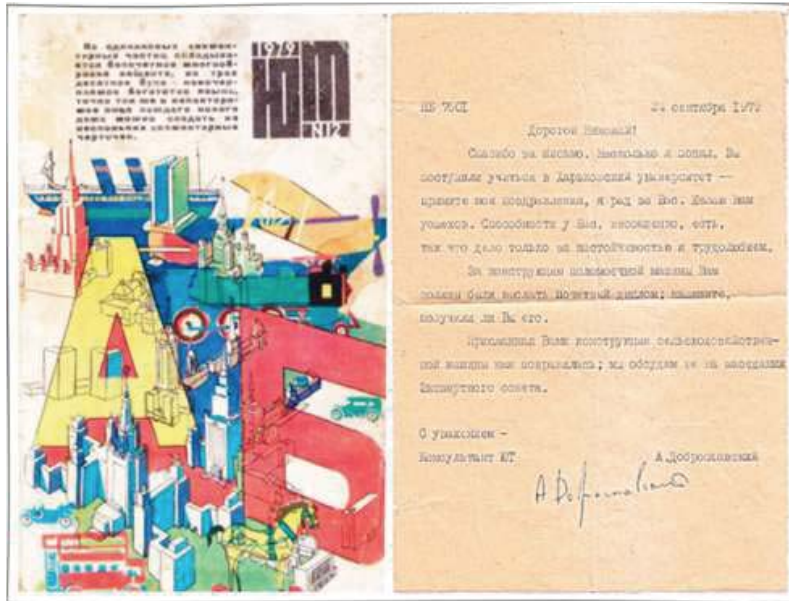

Later he put in applications to the State Committee for Inventions and Discoveries under the Council of Ministers of the USSR. They are **VERY SERIOUS APPLICATIONS** even for today. **Firstly**, they are absolutely correctly executed, and **secondly**, apart from the application materials, he put into real shape constructions for his inventions. Unfortunately, it is not known whether they passed the examination or not, but Igor Mikhailovich Kondrakov, as a patent expert, assured that if they passed the examination, they were given the "S" labels, and they had to issue author's certificates. Here is a fragment of one of the applications.

Practice shows that majority of creative personalities, in particular, inventors often do not know where to turn to with their idea and how to have it patented. The inventive activity in the USSR was put on a high level, but legally it was at a very low level. And different type of dishonest people sometimes made use of it, ***stealing the idea from the inventors and giving it out for their own***. Often the inventor remained with his idea for the rest of his life, trusting no one, with an ephemeral hope that once it might eventually be appreciated and implemented. Alas, ideas have the quality of "aging".

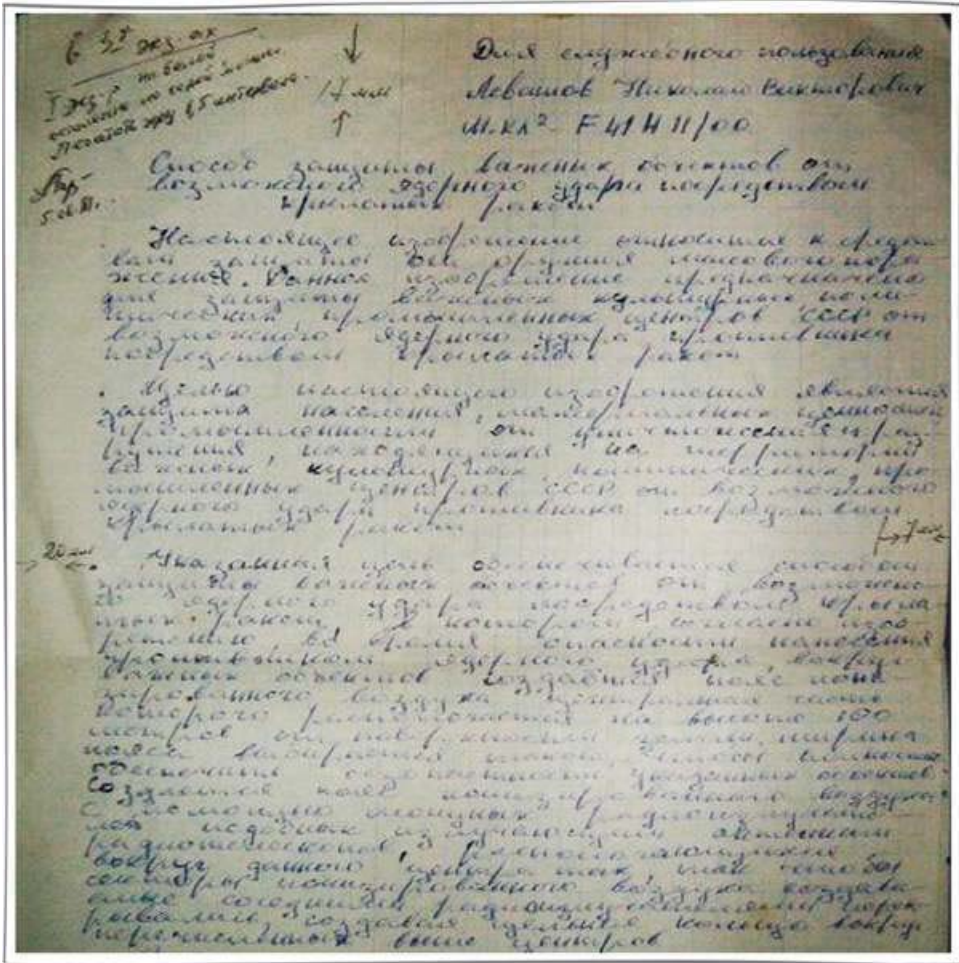

Nicolai was growing up, "beginning" to understand that *not everything in this world is good and just*. Before each Person at a certain period of life, there arises a question: *what is next?* What to do, what to devote your life to? Or maybe you should not break a lance, and live like everyone does?

You and me, dear readers, until 2012 had lived in the System, which dictated to everyone its rules of being in it. **THE SYSTEM IS DESTROYED**, but there **REMAINS THE AUTOMOTOR STYLE** of the people's actions. Whether we want it or not, it does not depend on us. But I am writing here about in what way and exactly what for N. Levashov rose in opposition to the System. Of course, I am writing in a simple way, so that everything could be clear, however, after reading the previous chapters of the

first book, you will see (or have already seen) a deeper picture of what had been and through what we, now living, had to go through.

For the "recalcitrants" during this period, there began a big "chess game" with the System, which carefully "watched" so that no "figure" fell out of her control. And for Nicolai it was a great "chess game", **WHICH HAD BEGUN LONG BEFORE HIS BIRTH** (incarnation on the Earth). He realized very early that childhood had been over, and there came an adult life in which there would be other "ravines", other worries and other "games" with invisible "mills," for which the sword and spear of Don Quixote would be no good. These "mills" grinded all those who began to fight them. But in order to successfully confront them, it was necessary to have a strategy and tactics, allowing you to count your actions on many moves forward, like in chess game. In fact, for those who do not know, the chess game theory distinguishes three stages in the chess game: *debut*, *mittelshpil* and *endshpil*. **Debut** – the initial stage of the party, the first 10-15 moves. In the life strategy of the creative Personality⁴, three stages are also distinguished and one more is added – *postendshpil*. What qualities a creative Personality should have in this case, in my opinion, is very well told by **I.M. Kondrakov** in his "**Lessons**"⁵, which are posted on the resources of "RNTO".

1.3. The Debut

Beginning with school, the System brought up and taught a Person, and then, through the created circumstances, "made" him choose in life what it (the System) needed, in accordance with the task it solved. It did not need talented by nature with their own opinion about choosing the Purpose of Life, the Worthy Goal, for which one can devote life without expecting any rewards or merits from the System. It needs those who fit in it well and choose the path **THAT THE SYSTEM NEEDS**. It annihilates the recalcitrant or isolates them from the society – there are prisons (for N. Morozov and his like), "sharashka" in the USSR (for Korolev S.P., Tupolev A., Kondratyev, etc.). All this we know from our history, which is sometimes useful to know.

⁴ G. Altshuller, I. Vertkin. How to become a genius. Live strategy of a creative personality. — Belarus, 1994. — p.479.

⁵ I. Kondrakov **Lessons of Knowledge**

Nicholay got standard preschool and school education – like everyone else. Only in the family he had different upbringing, and he began to reveal those principles that were in his Entity and with which he "came" to the Earth. Like many of us, he was eager to get a higher education, hoping to find answers to constantly arising questions. At school, he did not get answers to them – school program was **NOT ENOUGH** for him. His Entity **RUSHED TO** to recover to its potential. Therefore, there was nothing surprising that, simultaneously, he was busy self-educating, that is why he knew biology, chemistry, physics, literature and history.

Since childhood, Nicolai was fond of drawing, painting and moulding. At home there was a collection of his drawings, sketches and several pictures made in oil. At one time he went to an art studio, taking a great interest in painting and sculpture. Nicolai painted a series of portraits of relatives and friends, which now decorate the apartments of his parents and relatives. Some pictures are still not public. But I think that is not for long. Nicolai liked to paint portraits; it was both creative work and a kind of relaxation. Getting ready for the next picture, he carefully primed the canvas, marked the composition, etc.





Farthers's portrait



Mother's portrait



Brother's portrait



Sister's portrait

It should be noted that **Valentina Petrovna** is also endowed with the talent of an artist. There are a number of her paintings and sketches. She perfectly did tapestry work. Her Mother taught her this art. When she was carrying Nicolay, she made "Winter Landscape" in tapestry style. All this was told to us by Valentina Petrovna.



The beginning of N. Levashov's conscious research work can be considered the end of school education and the wish to enter biology faculty in Irkutsk, which he eventually failed to do. Later after entering Kharkov University, Radio physics Faculty he also tried to get answers to certain

questions. Once, having solved the current task, he turned to one of the leading specialists in lasers, since, a specialist is someone who knows the subject better. And, as many inventors say, everything went according to the classical scheme: ***"If you want to ruin a new idea to the root, turn to specialists!"*** Nicolai writes: *"...I set out my idea to him and showed the prepared drawings. He listened to me for about ten minutes, looked at the drawings and said: "I do not know what's wrong here, but it's wrong. All this is metaphysics".*

As a rule, a specialist who has **A NUMBER OF METHODS** in the creative set, which has been successfully used by him in solving problems, gets used to thinking in a stereotyped way (he is one of those 98% stereotype-thinking out of 100%, at the age when in science there can be done something, but the world outlook that has developed by this time hinders). Therefore, for a specialist to step over a barrier of common and personal experience that makes a psychological inertia is difficult and sometimes unconceivable.



Kharkiv University

O However, when N. Levashov turned to Professor Tretyakov, a true scientist who is among the **2% of non-standard-minded people at any age**, he replied: "Young man, I congratulate you, you discovered nonlinear optics, but unfortunately for you, it had been recently discovered by Japanese". "Metaphysics" turned out to be the discovery of nonlinear optics... "⁶

In the period of the first discoveries it is **VERY IMPORTANT** to meet a mentor from among creative people who, based on his life experience, could suggest how best a creative person should act at the beginning of his career: *not to dwell on existing knowledge, but to go further.*

As Nicolai said, he always kept in mind the words of the true scientist: "Never find yourself on the " rails "of this or that theory. Their creators were not fools, and squeezed out of their ideas everything they could. If you do not want to pick up "crumbs" of their ideas – you should always be **not "inside" of their ideas, but outside them**, only then you will be able to see their omissions and, may go further and leave them behind." Actually, this applies not only to science, but also to politics and, the main thing, – to the possibility of assessing the happening. Man, by virtue of the limitations of his reason and his own imperfection, can not always correctly assess what is happening and sometimes what seems obvious evil can in reality turn out to be a great blessing ... It is possible to evaluate objectively only from the **OUTSIDE** of the **SYSTEM**, which is to be evaluated.

All those were the next "blows" of the System at the inquisitive student, as if warning that it would be better to do everything like everyone else. Of course, everything that concerns the Ebr Control System ("the stopped one") and the New (Native) one, which "has entered full rights", I am writing in a



⁶ **Nonlinear optics** is a division of optics in which a set of optical phenomena observed in the interaction of light fields with a substance that has a nonlinear response of the polarization vector to the electric field vector of a light wave is investigated.

simplified way. You just need to understand that at that time the Ebr Control System worked to "full effect", and resistance to it was almost impossible.

* * *

N.Levashov's student's life passed the same way as that of the most students; several times he went with the student's constuction team to work, in order to earn some money. One of such trips was to Urengoy. Valentina Petrovna bought him a good jacket, which he took with him. Since childhood Nicolai had mastered to do a lot of things about the house, in particular, he was an **EXCELENT** cook. With what enthusiasm he told me how he made this or that dish when I visited him! Stories about "tasty and healthy food" were good unloading of the Brain after the information I had got from him at our meetings. His **COOKING QUALITIES** were particularly useful in the student construction team when, in order to feed everyone, he got up early – as early as four o'clock in the morning – and personally went to the local market, as he said, to buy food for the whole team.

Once, while cooking, his favorite jacket caught fire, which he could not save... By the way, since childhood he had been indifferent to fashion, clothes, and was more occupied with his inner world. But this does not mean that he looked slovenly. His clothes were always neat, and the order in the apartment was perfect.



Nicolai was not a spoiled child. Valentina Petovna since childhood, trained her children to master all the household duties. Later, all the skills

mastered by Nicolai were useful, since. most of his independent life he had to do everything himself – from keeping the house to making food.

His childhood closest friends told me that he had **REVEALED HIS SUPERNATURAL ABILITIES VERY EARLY**. Once, his friend Volodya Kozyrev' mother, closing the door, splintered the bones of the little finger. Nicolai "in a remote way" restored them in a short time. The first obvious discovery of himself, as it follows from his biography, was the influence of his thoughts on the operation of the devices, in particular, his camera and the flash. Nicolai found the cause and began to manage by his impact. And then he began to look for the answers to the arising questions in different literature: esoteric, palmistry and so on. Together with his groupmates he carried out a number of interesting studies that revealed his potential and move towards the first worthy life goal – the **PERCEPTION OF HIS SELF** and application of this Knowledge in solving some problems, in particular, healing people.



What can be more delicious than lemonade under the conditions of a student's construction team?!

While studying at the University he showed himself as an extraordinary personality. On the part of "support" of Levashov, in opposition to the System, everything was done so that a talented student, was not offered to stay at the faculty of the university and take up a thesis. Thus, through trained career traps, the control was exercised over all creative

individuals. He was sent to the army, believing that this would limit his ability to cognize.

However, this was a miscalculation, too. He additionally went through a good school of life. The army is a perfect school for men and few young men regret going through it. It was in the army that Nicolai performed his first experiments, in particular, the impact on people's consciousness, and some others, which showed his great s potentialities and made him believe in the rightness of the chosen path. Here he was first noticed when he pointed out the reason for the failure of the electronic unit, just "looking through" the structure itself without even analyzing it. And then during the exercises he warned the senior officers against staying in the area where they were, because could have died; and thus, saved their lives. To their question: "How did you know that?" He said that **"...COULD SEE THE FUTURE AND THE PAST."**

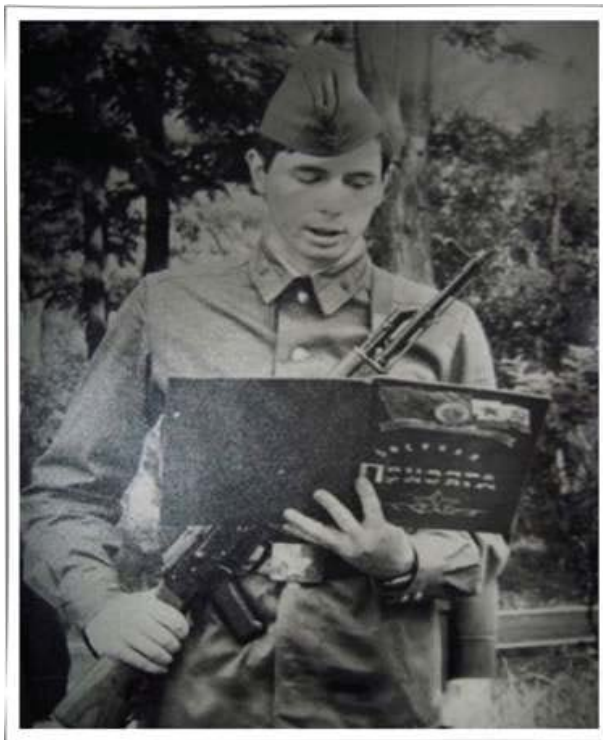

Nikolay takes a military oath

At the beginning of the creative path a long way to the cherished aim scares many talented individuals. The System also contributes to it. It creates conditions and offers a shorter way through the career ladder: work under the well-known chef, thesis defense for the Candidate's, and then Master's

degree, etc. As a result, life annuity is guaranteed in the form of good earnings, honor, rewards, academic degrees, titles and other attributes of a "successful" life. There is an active upbringing of consumer ideals: prestigious position, work, apartment, wife from the upper layers of the System, etc. A Creative Personality chooses a different course – He makes a life program to achieve the Goal, which is being corrected in the course. But moving towards the goal always means more than achieving it. And there are few people in the world who understands this. You can not make one big step that will immediately provide you with the desired goal. Any desired goal is achieved through many minor and quite ordinary steps. And Nicolai knew and understood this. From N. levashov's biography everyone knows what books he planned to write. But not everyone knows that he planned to write four volumes on Russian history, one of which – on the **North Caucasus – Ruskolan**⁷.

Nicholas creates his Moral Code, from which he does not depart until the end of his life. Confirmation of this – his books, his Technologies, which I am convinced in not by hearsay, and his very life. However, this required giving up many "temptations of a successful life", so the creative Personality reduces his needs, working for the goal. If the creative Personality does not agree with the System's "rules of the game" he is dislodged "to the side of life". Therefore, many of them had to play outside the rules of the system and become "freelancers", often making themselves live misery life, such as **K.E. Tsiolkovsky**. Additional means had to be earned, usually by choosing profession or occupation independent of the System. There was also a period when Nicolai did not have permanent housing, he sometimes had to stay at his friends' or relatives', but in general he earned his living by **HEALING**, curing people of diseases, without doing it **MAIN OCCUPATION OF HIS LIFE**, though before March 2012 he had been helping many people (me, in particular), which made him economically and morally independent. For all that, he found new methods of treatment, and continued to cognize himself and develop (or rather restore) his own potential (getting out of the body, traveling through time, coming out to telepathic sessions with other civilizations, cultivating human organs), creating the necessary structures of the Brain, which he then folded into more compact structures; and much

⁷ **Ruskolan** is one of the major state entities of the Slavs in the Azov Sea area, which existed 16 centuries ago, whose history is completely forgotten, "thanks to" German professorate who wrote Russian history for Peter I.

more, which enabled him to **DEVELOP HIS BRAIN UNLIMITLY**. I just reminded readers of the way Nicolai went to his Goal and which he himself described in detail in his book "**The Mirror of My Soul**".

1.4. The Quest

Sooner or later, there arises a question of making a family. Not every woman can make up a "party" to a creative Personality, because she will have to resign herself to the oncoming hardships, when there might be non-recognition and rejection of the results of her husband's work, persecutions, colleagues' envy, shortage of money, while the less capable organize their lives to excite envy of many people and much more. This is a rare type of women, but they exist. I'll just "retell" the sequence of events as I was told by Nicolai. He met a girl, fell in love, got married, but her relatives rose up against their marriage, when the first persecution against Nicolai began. The marriage broke up. Later, when Nicolai became famous, the chosen one, who "had obeyed" to her relatives, was sorry about that, but it was too late. Alas, in order to become a general's wife, you have to spend half of your life in garrisons, starting with the "position" of the lieutenant's wife, and undergo hardships of the army life.



These are little-known photos of both of them

In the initial period of non-recognition, as a rule, there comes loneliness, because very few people understand the creative Personality and do not want to deal with the one "not of this world". Then you have to change the incentives: work for the sake of work. And on the part of relatives and friends during this period, salutary voice-advice is heard – to give up everything and live like everyone else. But everyone wants to live like humans, but live as they are able to. There are always available Eskimos who are ready to teach the Papuans how to live under a terrible heat. Then the next step was taken – the change of the surroundings for the associates or people who share your ideas and views.

In 1988, Nicolai had to leave Kharkov after he had left his job, which did not have any prospects for him. The second reason for the move was his acquaintance with a woman named **Mzia Solomoniya**, which, as Nicolai believed that time, would become his companion.



She, possessing extrasensory abilities, focused on her ambitions, which put an end to this temporary alliance. Mzia's Entity was able to leave the body, travel through the Cosmos, etc. But betrayal is betrayal. I do not know all the details, but probably it is not necessary. This episode is mentioned only for the sake of completeness.

The problem of finding a companion for a creative person is a serious problem. The system always solved the relationship through a woman, which

was recreated by the ebrs as **ONE OF THE TOOL OF THE CONTROL AND GOVERNING.**

This is a special long talk, which allows us to understand everything that is happening before our eyes to a woman today, within the framework of the transformation of the Human Life Support System. I do not in any way like to hurt the feeling of the fair sex. But this is an objective fact, which they themselves must take into account both in terms of their health and in their development. It might intrigue you in this chapter. But in my next book, which I am going to write (and there is no doubt about it), I will tell you everything that (thanks to the works of A. Khatybov, talks with Nicolai and other people), I managed to learn about the woman as such! In the world there are three most changeable creatures: a stream, a crowd and a woman... Nicolai in this matter was very correct and careful. He only slightly uncovered the essence of the control, when describing the so-called *"institute of Jewish brides"*, which had been used both for the control and for "directing" the powerful of this world, and those who were of some significance for the System in matters of influence on the events taking place. And so far, try to pay attention to such things, which are all in full view of everyone, but of which few people think. *Why are all the biological cycles of a woman linked with the Moon phases (lunar calendar)? Why are the "names" of major hurricanes and tsunamis almost always feminine?* Apparently, it's not just by chance that everything relating to destruction and annihilation is given a female name? **"Mother", "Matter" and "Materialism"** are one-root words. The **Moon** is female. **Tatyana** is the first atomic bomb. All particularly dangerous and poisonous animals, reptiles, fish, etc. are five female names: Viper, Cobra, Gyurza, and vice versa, Zoya is a "particularly poisonous snake". Dangerous snakes: – **an anaconda**, dangerous predators – **a shark**, the most dangerous – **killer whale**. I got carried away a little, but I see that if I add something else I will just be beaten!

Let's go on. Finally, Nicolay manages to solve the "woman problem" – he meets Svetlana, who becomes not only his wife, but also his close associate. About everything that linked them here and before, no one can say better than Nicolay and she in **the book "Revelation"**.



1.5. The Mittelspiel

Mittelspiel is a battle, a decisive clash with the enemy forces. The most important thing in mittelspil is tactics. Here in the struggle for winning a large number of figures are involved which makes this stage of the game difficult for any chess player.

Coming back to Kharkov after the army and getting a job in the All-Union Scientific Research Institute of Technical Aesthetics, he spent time experimenting, since the work allowed it to do. During this period, among the employees of the department there were also his supporters, to whom he demonstrated his abilities, and even "remade" the Brain of some of them. These were "trials" and, of course, safe for Man options to develop their own potential.

During this period, the system usually "tunes" for a quick success – a promising theme for the research work under the leadership of a well-known chief and then up the "ladder". It is prestigious, and mainly, it quickly leads to the scientific community, where you will be needed if you do what the System requires. You need publications – well, go ahead! But it is desirable to do together with the chief or with the scientist known in academic circles. Everything that goes beyond the framework of generally accepted paradigms is not welcomed until it is approved by the "luminary of science". The

reaction of the creative Personality to this is the readiness to work into the "desk".

And then events follow one after another like a funnel, entirely capturing him, with his large-scale need to learn and implement these Knowledge in practice.

Nicolay begins to "try" his resources on a different level. ***Already at the level of the Creator.*** This period it is important not to be distracted in order to present evidence – who is "stronger", smarter, etc., and go on working on self-improvement and your Goal. After all, the result is important in the end. The result is the only criterion of the truth. Only a self-sufficient person is not inclined to ambition, self-promotion, leadership, the desire to be always in the center of attention.

The System "remembers" about Nicolai's potential , so after "looking attentively" at him, it makes the first "suggestions". I want to clarify that **by the System** it is meant the Old Control System, which that time was still powerful, and everything that happened after its implantation to specific people who solved their tasks in the framework of the processes leading to the ultimate goal, marked by the year of 2012. We have already talked about this goal of the ebrs and their system.

If the creative Person refuses the offer of "cooperation", it is warned that everything can end badly.

On December 18, 1987 N. Levashov came from Kharkov to Moscow, where a new round of life and trials began. Having discovered an extensive parasitic structure, he eliminates it and receives a direct response from its masters through an attempt to eliminate him from above. Similar, but in a somewhat different performance and other direction, much later was the blow of the System **through the death of his father**. After the Chernobyl events, knowing about his potential, the System again offers him its conditions: to work for himself and, when necessary, for the System, carrying out its individual commissions with all the prescribed bonuses of a full life as a reward, plus some kind of freedom of action, but within a strict framework of the allowed. The next refusal brings about a move to physically eliminate the creative Person (they do not even think about the scale of the Personality!).

Contacts with specialists in science demonstrated that in the field of his activity scientific research and investigations are conducted by the method of trials without sober consideration of errors and with a one-sided

interpretation of the results. The reaction of the scientific workers to Nicolai's comments on his arguments and assumptions "Well, when you work as long as I did, you will not believe all kind of nonsense your subordinates tell you; to see the internal organs, a person must radiate an enormous amount of X-radiation, which is simply impossible!!" – turned out to be all classical. I heard it often enough and still hear it, but I take it quite easy now.

Nicolai realized that his discoveries **WOULD NOT BE PERCEIVED** by the orthodox science, although at first he naively believed that for true scientists the Truth was important, since it is the Truth, the striving for the Truth that makes Man free. But for the majority, the incentive was and is their own position on the career ladder...

Nicolai's response to the System's actions and blows was rapid restructuring of his Brain structures and the operational development of a new tactic for combating the ebr and their System, depending on their impact. The Ebrs themselves created situations to get new information about their secret weapons – *"beating determined his consciousness"*. Nicolai defines his global goal: the fight against parasitism as a phenomenon. Many civilizations suffered this "disease", so this goal was relevant for the whole Cosmos. It was a super-goal, to which he went for the rest of his life.

1.6. The Intermediate move

Nikolai "receives" the **Third Appeal to Mankind from the Coalition Group of Observers**, which was transmitted through N. Roerich to the leaders of a number of states, but received no response. He used the appeal in his books, but the transmitted warning was implemented in the specific response actions.

The appeal of the CGO contained information that in 5000 years the destruction of the Midgard-Earth civilization by the cyclone of antimatter would become inevitable. The antimatter cyclone arose as a result of the closing of two Spaces having the same qualitative composition of primary matter, but the order of the arrangement of matter in these spaces is the opposite, as a result of which the matter of one space becomes antimatter for the other. The ejection of the normal matter of one space into another becomes a disaster for the latter.

In order to avoid a catastrophe in the future, it was necessary at least to stop further **ADVANCEMENT** of the anti-matter **CYCLONE** in our space and at the same time **NOT CREATE** the problem for any other spaces. Antimatter for our universe is a native matter for the universe from which it comes into ours. Therefore, the only space for which there will be no harm is the native space.

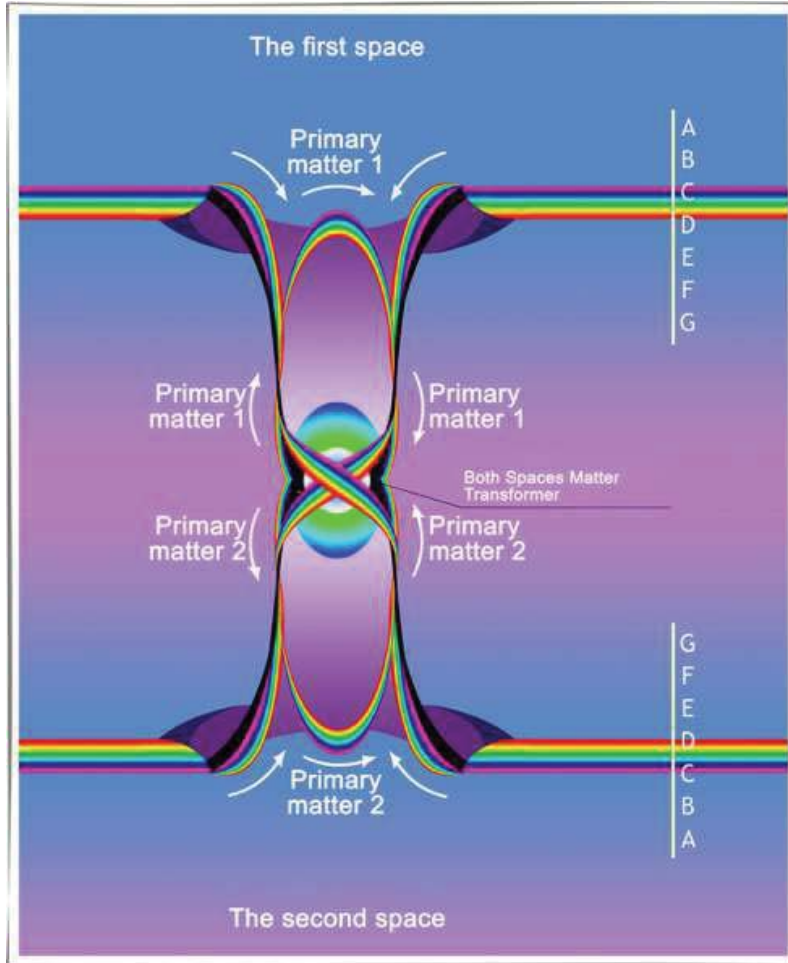

The obvious way to prevent the advancement of this antimatter cyclone in our space was to return it to its native space. This is a standard solution, although not an easy one. There is a physical contradiction: so that an anticyclone out of antimatter does not arise when the spaces with the same qualitative composition of matter are closed, matter PM1 must not fall from space 1 to space 2, and it must find itself in the neighboring space 2, so that the laws of the universe are not violated, i.e. a cyclone must form. Conversely,

the matter PM2 from space 2 should not find itself in the space 1, and it must find itself in space 1, so as not to violate the laws of the universe.

Let's formulate the Ideal Final Result: ***The matter of each space returns by itself to its space without entering the second, while retaining its own qualities for its space.***

To return the matter PM1 (sequences **ABCDEF**) and PM2 (sequences **GFE**) of each space back, it is necessary to change the sequence of each matter after the point of spaces closure. And this is possible, if we decompose the original matter into its components, as they are qualitatively the same, or turn them so that they change their sequence each time they enter the neighboring space. Möbius band makes it possible to do it. One of the variants of such a solution is shown in the drawing.

Nicolay creates a matter converter between the two spaces, like a huge number eight, in the center of which is placed the matter converter of both spaces. "The eight is created by Möbius band, which is formed by the curvatures of both spaces. Moving in such a curved space, any matter, passing through the zero point, is completely disintegrated into primary matter, and after passing through it, the latter creates a new matter, harmonious with the other space. But the curvature of the space in the form of the eight does not allow this matter to escape the transition point, and this matter, moving along the Möbius band of the eight, returns to the transition point and again passes through the transition point to our space and is already moving along the Möbius band in our space. In short, the **ANTIMATTER IS IN THE TRAP**. Occasionally appearing in one space, or another, this antimatter is tied to the point of transition of this curvature of space in the form of the eight, and its movement in our space ceases."

All this was decided outside the framework of the Supersystem. These were cosmic tasks, the solution of which could not be subordinated to the prevailing then **Ebr System**. Even today, in my opinion, the global understanding of the solution of such problems lies **BEYOND THE FRAMEWORK OF PERCEPTION OF THE MAJORITY OF PEOPLE**. Only units, both on one side (light) and on the other side (dark), someone needed to understand the possibilities in this direction. Such an understanding has always been expressed (from the times "before the invasion") in signs and images. Before the invasion (**18000 years ago**), this could be done by some Personalities who had reached a certain level of their Brain development. After the invasion and before of Levashov's "showing

up”, no one could do it, not even his Friends, who by some of their potentials surpass Nicolai (I emphasize it– only by some).

The confirmation to this is the sign "**Cross**", which was "presented" only to those who were able to **FOLD** or **UNFOLD** the **SPACE**, and this sign existed on the Earth even before the Ebr invasion. Then later its meaning **WAS DISTORTED**, but still there remained *some significance, mystery and solemnity* about it, which is used today, mainly by the Church and in other religious matters.

Here is **the ring of N. Levashov**, that in his symbolism (signs) carried his resources. *I was fortunate to make certain of it not by words but in deeds.* What a person is able to, if, of course, he is prepared for this, using this ring in interaction with his Brain (and if it is Levashov's Brain), is beyond the perception of the most people. If you paid attention, then that practically at all meetings with his readers, Nicolai was



with this ring on. And this, believe me, was not accidental. From the tale of this ring, or rather its "motion" in relation to its "owners", I know that it always (whatever way it happened) is at the right time and in the hands of someone **WHO IS CONDESCENDED TO APPLY IT** in reality. Where, who with and why is this ring now – I will let myself not to make it public. I know that soon everything will be exactly as it should be, in accordance with our plans and agreements with Nicolai. Everything is good in its season.

* * *

There is always a contradiction in front of the creative Personality: it is necessary that people should know about his new ideas, but for their realization there have to be publications, but it runs counter to the generally accepted paradigms of "classical" science, therefore publications are impossible. The contradiction resolves itself with the production of a certain number of copies of books or articles, as K.E. Tsiolkovsky did in his time. He made 1000 copies of his brochure on jet propulsion with his own money, thanks to which he succeeded in upholding the national priority in the field of the theory of jet propulsion. This was also helped by his friend A. Chizhevsky.

The system "deprives" him of directly turning to people with his ideas that are contrary to the orthodox science, but at first does not prevent him from showing himself. It needs complete information about the activities of the creative Personality. **N. Levashov** makes his first attempts to promote his findings: seminars in Arkhangelsk in 1991, showing up on TV programs, application of the results, newsletters, meetings with his supporters. Nicolai realized that in order to achieve his supreme goal, a result is needed, i.e. the success, organized by himself. V.A. Sukhomlinsky⁸ meant this in one time. Only in this case it is possible to arouse people's interest in your ideas. This, in fact, is being used in promotion of **Technologies and Programs "SvetL"**. He told me then: *"Success in this we must organize ourselves, not hoping for anyone"*.

N. Levashov's theory is not "sucked out of a finger", but based on reality, has *well-grounded practical evidence* with all its unexpectedness and unusualness. Recently coming out, after the publication of his books, new sensational discoveries in physics perfectly confirm and illustrate his theory.

One of the first concepts that immediately turned my world outlook upside down is time in the aspect touched upon in the talks with Nicolai. Even then physicists made a shocking statement – time **DOES NOT EXIST**. For a Man, time definitely exists: we wake up in the morning, move forward in time during the day and at some time go to bed, and in the dream, too, we go on moving forward in time. The unit of time is one of man's greatest inventions, but it is necessary always to keep in mind the original fact: it is an **ARTIFICIALLY CREATED QUANTITY** that describes the speed of the transition of matter from one qualitative state to another. In nature, there are periodic processes that served as the basis for the creation of this conventional unit. These periodic processes are objective and real, but the time units created by Man are conditional and unreal. But that's exactly what was planned in the framework of the Ebr system, which solved specific tasks related to the redesigning man, who was planned to be applied with very specific aims. Therefore, any use of time as a real dimension of space has no grounds. The fourth dimension, the measurement of time, just **DOES NOT EXIST IN NATURE**. It is exactly the daily routine and widespreadness of the time unit application that accompanies one from the

⁸ Sukhomlinskiy V.A "On Upbringing"/Comp. S. Soloveichik. –4 ed. – M.: Politizdat, 1982. – p.270.

first moment of one's life to the last one, very often ***create the illusion of the reality of time***. It is not the time that real, but the processes taking place in matter, a measure of which is a unit of time. There is a **SUBCONSCIOUS SUBSTITUTION OF ONE BY THE OTHER** and, as an inevitable result of such a substitution of the real process by the unit of its measurement, is a fusion in the human consciousness of one with the other, which has played a cruel trick on people. There began creating theories of the universe, in which time was taken as an objective reality. ***The objective reality are the processes taking place in matter, but not the conventional unit for measuring the speed of these processes ...*** What is the practical conclusion? One of them is moving through time, as this is a process. Is it possible for people today? Perhaps, if, of course, you understand – what for, but this is the most difficult. ***"Do you want to know your Future?.."*** Nicolai asked me after this explanation. ***"No,"*** – I said, – and he smiled.

Nicolai did not hurry; he did everything carefully, fundamentally, for the future, realizing that he had no competitors who would "catch him up." He was achieving everything thanks to his permanent development, in spite of the fact that initially much had already been bestowed upon him.

Knowledge of the real structure of matter led Nicolai Levashov to comprehending the real structure of the Earth and the laws of Nature. And this, in turn, allowed him to successfully apply his knowledge in eliminating the consequences of man-made disasters and catastrophic natural phenomena, such as Chernobyl, and in April 2011, an accident at the Fokushima Nuclear Power Plant in Japan. This knowledge allowed Nicolai to clearly define the concept of "life" and to substantiate logical, automatic appearance of life on a number of different Planets with arising necessary and sufficient conditions. He proved that the appearance of life (living matter) is a natural process that inevitably takes place (and not only within our galaxy) on many billions of planets.

His further studies resulted in understanding the conditions under which living matter acquires the ability of thinking, becomes Intelligent, which is also a very ordinary natural process, inevitably taking place when several necessary conditions coincide on the inhabited planets. And such processes take place naturally on quite a number of billions of inhabited planets. N. Levashov did not pass by an Intelligent Man, he made a lot of sensational discoveries, which are being hushed up with all their might, by the modern "scientific community". He explained for the first time in what

real way **CONCEPTION OF THE NEW LIFE** actually takes place, how the embryo is developing from a single fertilized cell, what for and why the human embryo goes through several stages of development, in turn becoming for a while a fish, amphibian, reptile, mammal and only then a Human. He described this process in a simple and intelligible language, without resorting to the physics of the process in full, as A. Khatybov did, because he explained this to readers brought up in this matter by the school textbook of Biology about "pistil" and "stamen".

Nicolai first proved that Man is born an animal, a common animal in a human body, meaning by a human body – a certain suit (shirt) for the Entity (Brain) that provides its being within the Earth's life support system. And only the life among people and an active assimilation of the experience accumulated by the Human Society makes a Human out of a reasonable animal. He proved that transformation of an anthropoid into an Intelligent Man is the meaning of Human life, a real evolution, a true spiritual development. While creating his Generator, he realized then that without **having a Bath** and the "**broom**" created by him, as well as "**SvetL**" **Programs** at this stage of development, one simply can not do.

However, let us go back to the "chess" game. The system carefully "watches" the creative Personality and at a certain stage, "realizing" that he is dangerous, is trying to block it. This was manifested in the impermissibility of any publications and meetings with the general public. When this did not help, the *discrediting of the creative Personality* went into the course. Nicolai refuses the fees for his work. He puts his books and articles in the public domain on the Internet. He uses this powerful weapon of the System – the Internet – against it itself. For all that time, more than 2 million downloads of his books and articles have been made, in addition to purchasing books published on hard copies and disks ...

Nicolai is trying to introduce those technologies that are already developed, this is necessary to attract new supporters of his ideas, and mainly, to take another step to change the worldview of these people and not only these, giving them and all those who gets at the meaning of the new and really possible. I consider myself to be in this category of people. **The Generator of "Dark Matter"** – his offspring, – he creates before the decision is taken in the direction of the proposed *Project of the Health Improving Complex*. He develops a program that, with the help of the Generator, is capable of changing the structure of water in such a way that the yield of fungi, for example, is increased tenfold. This was used in

mushroom farming, and the production of extracts from mushrooms starts, which, when properly applied, gives very good effects against many diseases. Unfortunately, after Nicolai's gone, this business was "ruined" at the root. Is it possible to revive this? Yes, it is possible. And the step that is taken in this direction is somewhat different from the **N. Levashov's Program – "SvetL-Flora"**.

Of course, doing the healing and improving people's health, Nicolai eventually got the opportunity to live in easy circumstances. But this was not the main thing for him, he went on his research work in the name of the Mankind, planning to write books, including, on healing. But did not have time, or time did not come. Nicolai held seminars. He taught people so that later for some of them it became the work of their lives. I recently got a note from Robert Ginzburg, who attended Levashov's seminars (and quite successfully), and he, according to my information, keeps tapes with videotapes of these seminars (lessons). Also, some archives are kept by D. Orbelian in the USA. I wrote a letter to Robert Ginzburg asking him to consider the possibility of sending copies of these tapes to Russia to make them public. I hope this will take place, and then, after receiving such a **PRICELESS MINE** of **KNOWLEDGE**, it could be possible to recreate the book. In the meantime, here is his whole note.

Some Memoirs of Nicolai



How can one describe a person who is unlike anyone who probably has ever been on Earth. Majestic, incredible kindness, all knowing knowledge, etc.

Perhaps best to start how I met Nicolai. I was at a networking event and everyone had 30 seconds to tell their «story». I said I was transitioning

from being a lawyer to an energy healer. A woman came over to me and said if you really want to be a healer check out this Russian who just came to San Francisco. She gave me a telephone number of a person Nicolai was working on and said I could see him work on Saturdays.

At the time I still had a lawyer's ego and thought I was «hot stuff». I had just been hired by a prestigious mind-body school to give a 2 year training program in a new energetic healing system I had developed. For some unknown at the time reason I made the phone call and travelled about 35 miles to see Nicolai work. When I arrived no one was at the address so I went home. I called again and made the trip the following Saturday. Again this is most unusual for me. It was as if I was being pulled.

When I arrived that Saturday Nicolai was present and working. He nodded to me when I came in and I felt he knew I was coming. I saw this immense man with an energy field I had never seen before. At the time I really had no idea who he was but made an appointment to see him for a minor health issue. After working with him a few times Nicolai said he was giving a class and I decided to attend after I had a friend «check him out». My friend encouraged me to study with Nicolai and said he had never met someone with so much confidence.

At the class I really felt lost at the beginning. Nicolai was talking of things I never heard before. After a couple of weeks Nicolai told the class that 99 negative energy generators that surrounded Earth had been destroyed. He never said how this happened. At this time, I was starting to realize Nicolai was incredibly special and unique. I went over to him after class and asked «did you destroy these generators»? He answered «maybe». I now knew I was on the most special path one could be on.

During the class he worked on everyone's brain. I actually felt parts of my brain moving. Eventually he had completely changed my consciousness. He told me before class he would evolve my brain 1 million years. Who ever heard such a thing! I don't know how many years but my brain has evolved.

I really could write a book about Nicolai and perhaps will one day. It will be called «Travels with Nicolai». There is so much more to say about this incredible man but I will end it here.

I hope you find this interesting and useful.

My best,

Robert Ginsburg.



Make your own conclusions.

That time, the Interventionist System on the whole Earth was still all-powerful, it controlled everyone and could also destroy, if there was a necessity. Quite a number of Nicolai's companions gave their lives in this struggle. But here, too, Nicolai makes a pre-emptive move: he creates his own school, but not on the Earth, but on the mental level of the Earth, the so-called "Mental School", which the System can no longer reach. More than 3000 pupils studied – the future of Russia and the world. I know some of them and I know that they **DO NOT NEED to have a Bath**. They have already been there.

Having moved to the United States because of the persecution on the part of the "competent authorities" of the Soviet Union, Nicolai eventually finds like-minded people there, creates his own school, where he lectures on his concept. Since 1992, he had been reading his own lecture course at one of the technical colleges in San Francisco (USA). This is also one of the forms of introducing his ideas. Evariste Galois, the creator of the theory of groups, also sometimes lectured for one- person audience. Only after a hundred years did they evaluate his contribution to mathematics, and the group theory is now one of the basic directions of mathematics.

And there, in the USA, the System does not leave Nicolai alone, "offering" cooperation with it for quite a good money. Nicolai does not take the offer, and a new round of "troubles" follows ... But, despite this, Nicolai writes his first book, **"The Last Appeal to Mankind"**, which he completely designs and puts into shape in his home "printing house", having independently made a lot of illustrations. Here I want to draw readers'

attention to the fact that he did the drawings on the computer, which **MADE IT POSSIBLE "TO FILL" THEM NOT ONLY WITH VISUAL INFORMATION**. Few people paid attention to this *and almost no one has yet realized the real informativity and authenticity of the image*. This is particularly true about his pictures, which he "painted" (performed) in the so-called digital representation.

In the book he also puts his portrait. When 25 copies of the book were produced by him in the home "printing house", he sent a copy with a signature to his parents: *"My dear Mom and Dad. I give you this book, which is not only written by me, but also made by my hands. The first copies of my book came out of my hands in Russian, too. This book is my child, and I give you my child. Your son, Kolya."* And right there on the page, Valentina Petrovna wrote: *"Victor brought the book on 15.VIII.1994 from Moscow, when he was at Volodya's for 3 weeks"*.

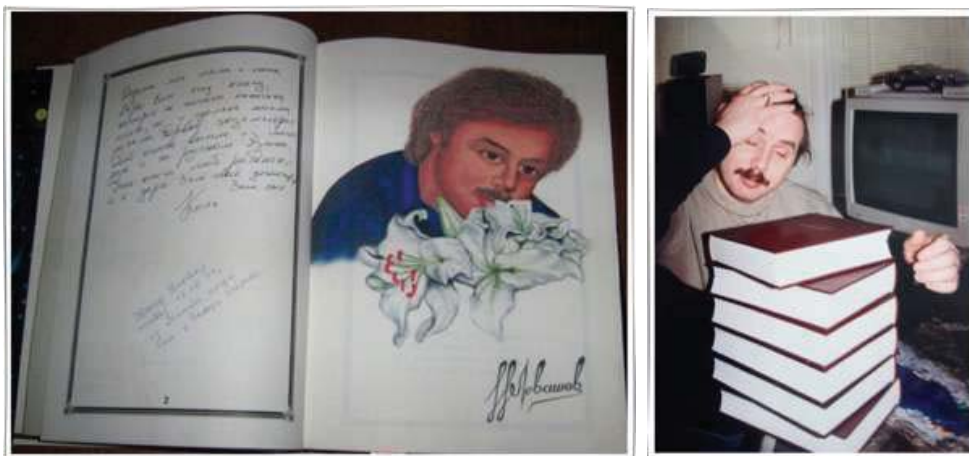

Returning to what was said in chapter 4 of the first book⁹ and the events that took place in the United States, - there was another "White Star" and very close, on our home planet. And to an even greater surprise – in California, in San Francisco. And it was during that period when Nicolai Viktorovich lived in this city. Well, aren't you intrigued?! Well then, we will not test your patience: this word combination was used in the name of the company White Star Center for Human Ecology, Inc. Its president, as you might guess, was Nicolai Viktorovich Levashov.

⁹ Book 1. Unmasking the Hidden (intervention:how it happened), ch.4.4.



About the company, established on May 19, 2000 in accordance with the laws of the State of California, it is difficult to say something so far. Today it does not work. Perhaps, the American associates will help. But the address where it was registered is – 738 10th Ave, San Francisco – turned out to be very interesting. At this address there is a two-store wooden house built in 1912 with an area of 2460 square feet, including ten rooms and two bathrooms.

And here is a frame of the famous film, which tells about the role of N.V. Levashov in the cure of the brain cancer of Isabel Pritchard. Approximately on the 6th minute of the narrative Isabel with flowers comes to thank Nicolai Viktorovich for recovery and climbs the stairs ... of that very house.





I would like to warn the fans of the "detective genre": there is another evidence confirming the above, but not public so far.

It only remains to attach the map on which the location of the house is indicated and assume that other shots from the film about Isabel could be taken in this house.

As you can easily see, the house is located near the entrance to the Golden Gate Bridge. Why? – everyone can decide for himself. To the above, it only remains to add that the house was sold in 2003.

It seems that such seemingly, at first glance, minor episodes of N.V. Levashov's life, is an important and significant for all his admirers addition to the incomplete **"Mirror of My Soul"**.

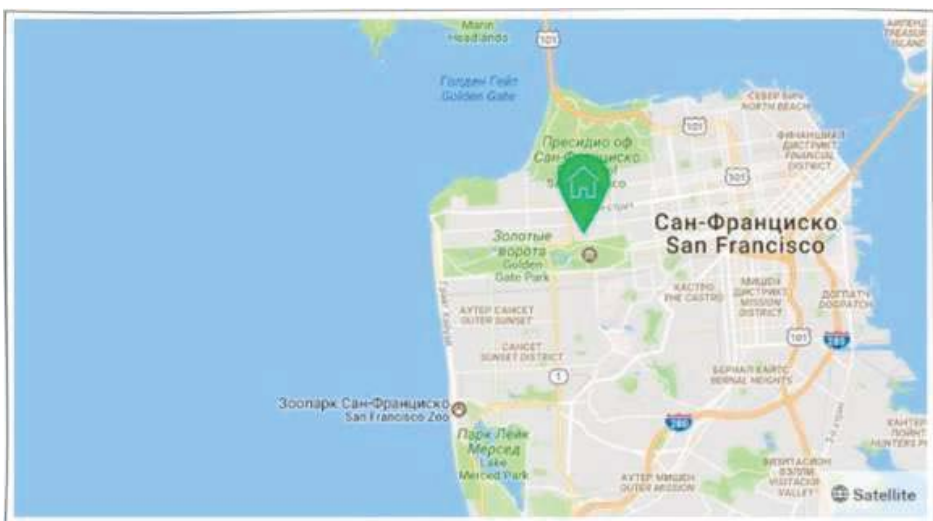

It remains to complement **that in 1990** there began to work in the active phase California Control Complex, which initiated the introduction of 461 genotype of the Brain. Is this all by chance? This is a question to the readers!

* * *

By the end of the 1990s, Nicolai already realized that new times were oncoming in Russia, about which he often talked to Vladimir Kozyrev, an old friend of his. Nicolai perfectly understood all the importance for Russia of those processes of the world transformation, which were gaining momentum. Therefore, he "decides" to come back to his homeland.

Here the next pre-emptive move was made – he creates **Russian Public Movement "Rebirth the Golden Age"**, which united all those who shared his worldview. A large number of groups of the Movement were organized around the country and abroad, which, before his death, actively implemented **HIS IDEAS** and projects. *This was a large scale implantation of information for perception.* The System, in response to this, also did not doze, it "pressed" on those who could be "broken". This led to the elimination of some people and betrayals. Gradually there was a "spoilage" of the Movement, – it included a number of people for whom their **OWN AMBITIONS, PERSONAL MERCENARY MOTIVES** were of primary importance. Sometimes these were direct "tasks" from the System. But already within the framework of the transition to the New Control System, a process began that indicated that **the time of the Parties and Movements had been left behind.** And there were many, including members of the Movement, began to understand this.

After Nicolai's gone, the Movement disintegrated through the "infiltrated" people in due time and through the automotor style of their actions within the framework of the Old System. But by this time the Movement had fulfilled its function determined by Nicolai. And did it rather well. This topic can be discussed for a long time, but I am not going to do it. There remained the people, participants of the Movement, who are trying to do something useful, practically on their own, but there are those, too who just try to maintain their "significance", despite the useless and illusory nature of it.

Nicolai had plans to organize schools here, in Russia, but the plans **WERE DESTINED NEVER TO BE FULFILLED;** there were many reasons, among them the activities of the Movement "leadership" and the situation that had changed in the Control System. As time showed, a number

of talented people showed up from among the members of the Movement, who grew into creative Personalities while working.. In order for the theory to live, it needs to be developed further, and not to be turned into *the Gospel*. Nicolai's success did not let alone those who possessed some special abilities or fragments of knowledge, although, in fact, they should have helped Nicolai, but having chosen unhealthy rivalries, doubtfull confrontations, they often completely lost their way (General Petrov, Trekhlebov and others). All these concomitant circumstances (betrayal of the surrounding people, "friends" and "followers") organized by the System, Nicolai invariably turned to his advantage. His pre-emptive move was in the revival of the Organization, which today bears the name of the **Russian Scientific and Technical Society ("RSTS")**. The main point and mission of this structure is still very few people understand and, especially, the "enemies." All this was carried out objectively, within the framework of those changes that began in 2010 with respect to the Life Support and Conrtol System.

1.7. The Splashes...

They say that Perception of the Truth goes through three stages: *"it can not be so", "there is something in it," and, finally, "it can not be otherwise."* True, between the first and the third stages, according to the academicians themselves, more than 50 years can pass. But the same can be said about the Technologies, about which they used to say "it can not be so", "there is something in it" and, finally they began to say "it can not be otherwise", and 50 years **HAS NOT PASSED YET**.

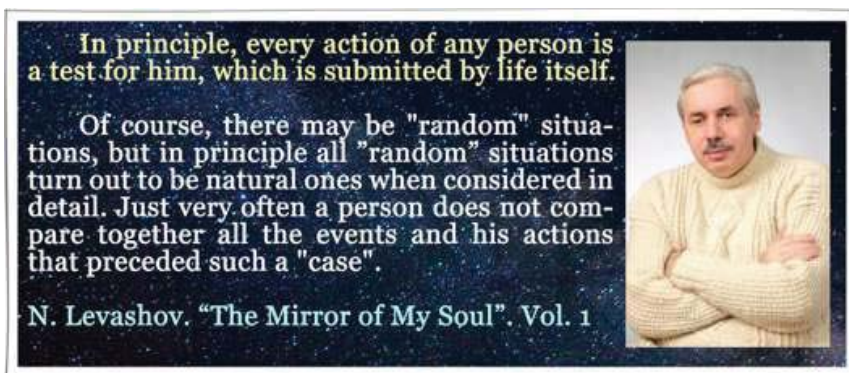

For a long time, I did not feel like making public what you are going to read now, but the circumstances nevertheless encouraged me to do so. And these circumstances are related only to the fact that information about N. Levashov's life and activities and everything associated with him continues to be distorted in all possible ways. And unfortunately, those people who publicly declare their relation with Nicholai, unfortunately, are doing this, for some reason, **NOT TELLING** the whole **TRUTH**, basically, but doing it in a fragmentary and selective way. It might be possible not to mention this, but, unfortunately, these people are listened to by others, those who first come across the works and the name of N. Levashov. As a result, initially false information is embedded in the "newly-consecrated ones", which does not bear anything but rubbish. Later, of course, everything takes its place, but the aftertaste remains. And the second reason is – a lot of questions that I am being asked. How could it happen that such characters were so close to Levashov, and why he did not throw them out on their ear realizing to what consequences all this might lead?

Russian Scientific and Technical Society has been doing scientific and educational work for many years, revealing once hidden truthful information about the Universe, Man and laws of Nature to the people. The last years, since N. Levashov's gone, "**RSTS**" has focused on **EXPLAINING PEOPLE THE MEANING OF THAT HERITAGE**, that Nicolai left to us.

Hence, it is clear, that "**RSTS**" activities encounter fierce resistance of assistants of those who tried to plunge our Planet and civilization into the disaster and death in accordance with the plans developed and implemented by the interventionists. Immediately after Nicolai's gone there were attempts on the Internet to slander "**RSTS**" and, in particular, me, by what the authors loudly called "exposures." Jumble of words pulled out of Levashov's works, rumors and conjectures having no grounds, references to people having seen or heard something somewhere ... In the course everything was of use: – nationality distortion (a clear sign of representatives of a certain Genotype of the Brain, that you have already known), the life story, and just a hastily invented lie. The organizer of one of the ***Crusades is Dmitriy Baida and his wife Helen Lybimova.***

Who is he and why did he go on a crusade against **RNTO**? *The site "1-Sovetnik" (Adviser), which has a considerable library of esoteric books of various authors, promising development, health, longevity and material benefits, presents quite eloquently D. Baida. Once the book (or rather, its*

description) **"The Last Appeal to Mankind"** in the first edition of 1997 was downloaded online and some passages from the book were laid out for reading. It was by this **in the spring of 2003** Nikolai Levashov, being in San Francisco, found the site and contacted **D. Baida**. On his request N.levashov sent his books, which were laid out for reading. Later this acquaintance was strengthened, because N. Levashov agreed to cure him of a rather grave disease (I want to emphasize here – free of charge) eventually "dragging " him out of "the other world." As a token of "gratitude", D. Baida developed under N.Levashov leadership his personal website to spread books, articles, photos and video materials on it and gave people the opportunity to use all this, and at the insistence of N. Levashov – absolutely free. All this was done under the direct control of Nicolai. Subsequently, this site **was "uploaded" with "Health improving sessions"** for all people who needed it. What happened to the site of N. Levashov, after he's gone, I have already written in my articles and will not repeat myself. If considering it from the point of view of our chess game, then **EVERYTHING IS QUITE NATURAL**. This was another attempt of the System to take control of **N. Levashov's** activities through its "executors" and under the guise of "good intentions", expressed by the slogan "Everything is for the people!" But the site was created, primarily and mainly, for the Books to find their readers and as soon as possible. **All the rest was secondary**. Was that the right move on his part in this chess game? Now I see it was the right one.



Nicolai's site was called into being **in November 2004**, it was not well known on the Internet yet, but, nevertheless, until the end of 2006, more than **15,000** books were downloaded! And this was only the beginning! Over the next year 2007, more than **33,000** books were downloaded, **"The Last Appeal to Mankind"**, in **2008**, respectively, more than **100,000** books, in 2009 – more than **114,000** books, and over 5 months of 2010 – more than **55,000** books! By the beginning of June 2010, from the time of free downloading of this book, more than **319,000** copies were downloaded. And with each month, **THE NUMBER**

OF DOWNLOADED BOOKS INCREASED. These figures speak for themselves. But these data on the download of the book reflect rather an incomplete information! After all, the book "**The Last Appeal to Mankind**" has been placed for free copy by many electronic libraries, it can also be downloaded from sites whose owners decided to host it without even asking for consent! And what a number of downloaded books were later "dropped" on discs, printed on individual printers, etc. etc.?! And, of course, the version of the book that had to be printed as early as 1997, on Nicolai's site it was for free download! But this is not the point! The point is that the book turned out to be very needful. And this is another victory over the System.

There is no doubt about the heritage Nicolai Levashov left to us all. Had everyone so eager for exposures acted from the position of common sense and really wanted to restore the truth, they would not have used any manipulative techniques, outright lies and concealment of information. If they had really been looking for the truth, they would not have needed to find out and investigate anything at all. On the resources of "**RSTS**" and on the personal pages of the participants of "**SvetL**" Programs, a lot of information has been loaded within the last years. The articles, speeches, photos, films shown for public viewing contain so much valuable information that it can be studied for many years. People on their own tell everything that they have experienced and felt about themselves, while using **Technologies "SvetL"** for their recovery. All this information, which is impossible to forge, comes practically from all over Russia and abroad.

I want readers to realize that **D. Baida and others like him are the project of the System.** The project, produced by those who **managed to kill N. Levashov.** Their main task, as I have already mentioned, is to block and not allow the information to spread; that knowledge given in the works of **N. Levashov**, and the **Technologies** that are working today for the benefit of people – they want to prevent them from developing. But here the System has failed, as well.

However, I got carried away, but could not but write about those "figures", because the information related to N. Levashov's heritage and, especially, ***the Technologies, should be complete.*** And the reader, in my opinion, will decide on his own whether it is worth believing those who have already been caught in lies an unmasked in public.

1.8. The Endshpil



This is the final part of the chess game. As a rule, it is characterized by a few number of figures and the strengthening of the king and pawns.

After **SVETLANA'S DEATH**, or rather, her **MURDER on November 13, 2010**, I was at Levashov's in a day. By his state, I realized how dear this woman was for him.



Nicolai told me in detail the moment of Svetlana's death and how he had been trying to resist it. Then I first learned about his Friends, who in their potentials, if I can say so, *were superior to Nicolai in our earthly understanding of this*. However, one cannot say better than it is

described by Nicolai, and there is no need. Unfortunately, I had not been acquainted with this beautiful woman. However, Nicolai told me a lot about her and her life in France. This frankness on his part, I did appreciate. **And yet I "saw" Svetlana.** I saw her later, and here's why: in 3 months, after Svetlana's gone, I brought to Moscow to N. Levashov, two manufactured "signs" (rings¹⁰), designed specifically for the "revival" of the organization, which today, as it mentioned before, is called "**RSTS**". On both sides of the rings there was the year of the so-called "start" in the old and new chronology – **2011 BC – 7519 – Peace Treaty at the Star Temple.**



Nicolai liked both the execution and the "design". We agreed that these Signs for the participants of "**RSTS**" would be executed of silver in St. Petersburg. And suddenly he says: "Well? Let's not touch these rings, yours and mine. But on the following ones, put the years **2010-7518**. I want us to think that we "started" with alive Svetlana, the more so, that **SHE TOOK AN ACTIVE PART** in the restoration of the Organization, to which she pertained and which activities she described in her book." Of course, I agreed, and after that all the signs of "**RSTS**" **come out** with these dates.

We discussed the routine matters related to the Complex, and the Primary Programs. I do not know what made me suggest that we should name the Complex in honor of Svetlana and the Programs – "**SvetL**", exactly in this writing (Svetlana Levashova). And since the Project itself also needed a name, I suggested calling it "**SLN**" (Svetlana-Levashov-Nicolai). For the rest of my life I will remember the way Nicolai looked at me. You can hardly describe it – there was gratitude, love for Svetlana and the openness of this Man in the depth of it ... But he suddenly looked over my shoulder and smiled. I turned my head and saw in the corner of the room, but we were sitting in the kitchen, **SMILING SVETLANA**, who looked affably at me and then nodded. *I've seen a lot of things in my life.* But at this moment,

¹⁰ See details in Book 1, chapter 4.4.

probably, my face expressed something that made Nicolai smile. And in less than no time Svetlana began vanishing in the air and disappeared ... That's how all my proposals and everything related to the **Programs** and the **Project** were approved. Later, when Nicolai's gone, I, if I may say so, "received from Svetlana" what had been kept in the Castle in France and intended for me. I have already written that Nicolai's things began to "find" me. All this happened even before the Generator under the Castle left his shelter and moved to Russia. And when it was implemented the way I described in the previous chapters, I **UNDERSTOOD THE TRUE MISSION** of these things. That was gratitude for all I did with Nicolai and Svetlana and go on doing now.

Pay attention to the Cross. This is the Sign that carries the potential. As far as I know, this ring was given to Svetlana by *Rockefeller's daughter as a token of gratitude*. None of the Rockefellers, as I got it, had a complete idea of the potentials of this ring, and it was kept as a relic once belonging to the **Templars** and then confiscated after their annihilation. What was the true reason for giving the ring to Svetlana remains a mystery so far. I know only that the ring, unlike the one I wrote about above, bearing the same signs but some other potentials, was in N. Levashov's hands and belonged



to him, but he used it only when being in France. It is with this ring that all those experiments with plants that were made in France are connected. In some time, *it "found itself" on me, having made quite a journey*. He "gives" the potential to interact with the Generator, who had been under the Castle, and now, is "**working**" in **Russia**, as you know. I regard this as a gift from Nicolai and Svetlana and a sign that I am a plenipotentiary participant of *the Organization revived by them*.

Here is another sign. About this ring, which Nicolai presented to Svetlana in 1993 in America, he told me himself. At the same time, he set in Generator the jewel (it is still there in the active form) which Programs envisaged the energy support of the owner (Svetlana) in her "journeys", the most powerful protection and the ability to "create" designs that, when filled with information, become the **BASIC EXECUTIVE BLOCK** in solving specifically planned tasks. For all that, the jewel "changes" its color from dark ruby to bright violet. The color is an indicator of the power of the being used



(involved) energy. And the physics of filling the created structures I **"found"** in **A. Khatybov's works**. I have no doubt that Nicolai explained all this to Svetlana and taught her to "use" this "article". For the first time this ring was used by Svetlana in 1994. This is described by N. Levashov in the first chapter of the third volume **"The Mirror of My Soul"**, which, in fact, I am completing. So the description of this "article" is quite appropriate here. And when this ring "migrated" from France to me, I tried and tested it, however, under the supervision of the Friends, who, as Nicolai liked to say, were "not from here". The results shocked me.

Why do I talk about it in such a detail? Just, only because all that I have described (apart from creation) is the most powerful "weapon" that Nicolai used in the struggle against the System. He described a lot of the results of this struggle in his writings. Of course, this kind of actions on the part of Nicolai, only strengthened the "desire" of the System to get rid of him and find some kind of non-standard move for this. However, for a long time nothing could be done, and Nicolai went on doing his work even in response to the blows directed at him. One should be like Nicolai, to be able after the death of Svetlana, to write an afterword to her book and explain what really happened, because the interpretation of her death had already filled the Internet so that there was only a miracle to be given. He even gave his admirers the hope that Svetlana's books on **Daaria**, the unfinished books **"The Templars"** would eventually be completed and published. It was the answer of the great Personality to the blows of the System. He went on working intensively, conducted meetings with the readers. On his insistence, I increased the number of my trips to Moscow to regular meetings with him. We could not discuss issues related to **"SvetL" Programs and Technologies** by phone or skype realizing what it might lead to.

When I knew about his intention to stand for the **presidential elections in Russia**, as a politician, I was at first absolutely against it realizing the foredoom of this idea. But when he told me his **true intention** and suggested that I should enter his election headquarters, – I, of course, agreed, realizing why all this is done by him. Of course, the system did everything in order to "pull" Nicolai out of the game at the first stage. But it miscalculated revealing by this example all the rottenness of the "state structure" and the corruptness of the so-called "popular election" campaign.

In practice, he turned the process of struggle from talking that's bad and this is bad into the state of participation in it and making his (people's) conclusions about what was happening before their eyes. It was a crushing blow at the System, and today this understanding is only getting stronger in people.

In response to these actions, practically at the same time, the representatives of the **4XX genotype** of the Brain, "guided" by the System, organized a trial on Nicolai's book "**Russia through the Distorting Mirrors**". Criminal iminal cases were instituted against some participants of the Movement.

Igor Mikhailovich Kondrakov attended the court session on the book "**Russia through the Distorting Mirrors**". Moreover, he wrote a scientific conclusion on this book. There are no elements of extremism in it. It was a social order of those executors of the System. It was **NOT** a **TRIAL** but the **JUDGEMENT** of Judge Fedorova who muttered the verdict in a barely audible voice, without giving a word in defense to the opposite side. You can describe everything in colors, but is it worth it?"



We are observing the similar every day and we are no more amazed, realizing that this is the agony of the Old System and the old thinking of those who execute in auto-motor style what once was imposed upon them. Of course, the moment of everyone's responsibility for everything done will inevitably come, regardless of whether it was done on someone's order or on one's own initiative. This is the hidden meaning of the transformations that are taking place. They can not be violent. But that does not mean that all-forgiveness day will come. Take my word for it, gentlemen, – it's much more serious than many of you might think.

Did N. Levashov understand that the System would not give in and would be "finishing him off", despite his obstinate resistance? Yes, he did.

My last meeting with him and getting some instructions from him prompted me that. *"In war, as in war, losses are possible. The main thing is that these losses are justified. You are a military man who can see far ahead"*, - he said, and his look got so deep and full of feeling that I felt how far deep into the future he could see. It was then when I got to the meaning of once said by him and later written, **"even my death WILL BE OF BENEFIT, HAVING UNITED PEOPLE to fight for their future where there will be no place for any lie and meanness"**. In 2014, during another meeting with Levashov's Friends after assessing the situation, I came to the conclusion that had Levashov "held out" for another six months, the events would have taken slightly a different turn. But what it happened it happened, and **on June 11, 2012, HE WAS GONE**. Was this victory of the System? No, it was probably the biggest failure, because no one will ever be able, and the more so those vertically integrated Gesheftmahyers, as the advanced detachment of the System, only able to auto-motor style actions, to stop the information spreading invested in N. Levashov's books and technologies. It is being spreading about in geometric progression, giving people **NEW KNOWLEDGE AND NEW WORLD PERCEPTION**. Foreseeing the oncoming events, he made a number of important and pre-emptive moves, such as "preparing" for the "transfer" of the Generator from France to Russia, saving a duplicate of his archive, handing the Technology and training to use them, creating a "structure" that makes it possible to reproduce and "set" **Generators** into **"SvetL" Complexes**, and much more. As I see it now, he "arranged" the situation in such a way that his Friends "found me" and told me much immediately after he's gone. He used to say that it was easier for him to make those do well who he knew well, than to introduce new people. Time has shown that he had calculated everything correctly. I do regret that until now I do not have his main archive. There is only part of it. The part I use when writing this book. But I do know that soon the archive will be in full there, where it is to be. **Moreover, manuscripts do not burn, you know!** And this is also a grave loss of the System, which "wanted" (naturally, through the guided people), to hide and destroy this heritage. As for **Nicolai's wife Svetlana**, as I said before, I will not "go into detail" here, knowing a lot not by hearsay, but from Nicolai himself. I just say that the System's operation **"Lieutenant Schmidt's Children"** has failed, as well! In the afterword to Svetlana's book **"Revelation,"** Nicolai, referring to Svetlana's memory, placed the last full stop, writing: *"I will continue the story about you in my biography, since our biographies have interwoven so closely*

that they have become one and continue to be ... "One of the pre-emptive moves that Nicolai made was preparing a historical reference for the situation when he's gone, as I said in my essay **"The Mirror not of His Soul."** In the same way, his autobiographical book "The Mirror of My Soul" had been written. Evaluating the distortions of information that returned to him after meetings with readers in the form of asked questions, Nicolai wrote an autobiography, which sets out in popular form many of his ideas, his findings, in addition to his biography, which is closely related to what he did. There could no longer be distortions of events and his work, because he set out everything as it was in his understanding. And this became the main and truthful source which made it possible to get information for understanding and gaining one's own knowledge for any Human being, and not only to show interest in his life story. Unfortunately, many readers had not got at the meaning of this. But about this – later.

1.9. The Postendshpil

Immediately after the death of Svetlana, and then Nicolai, the **DISTORTION** of **THEIR LIFE STORY** began. The Internet has been flooded with dirt about them, using archival materials and falsifying everything related to their names. Unfortunately, voluntarily or not, there took part those who called themselves "co-workers" of N. Levashov. As it turned out later, this was done, and yet it is being done only to give importance to themselves compared to numerous admirers of N. Levashov. But the foam gradually disappears, and more and more people get to know this absolutely unordinary, in our earthly sense, Personality who **CAN NOT BE COMPARED TO ANYONE** in the observable past, and probably, future.

When I was on the point of finishing to write this chapter, making corrections and introducing some new facts, not mentioned in the first edition, I got a letter from people who honor the memory of Nicolai Levashov, read his books, look for any information about his life and work, apply his Technologies and analyze the results obtained from the point of view of their knowledge, derived from Levashov's works and not only his works – *"...let us immortalize the memory of N. Levashov and show it not only by articles about him, stories and reports on the Technologies, but found His Museum, in which we will collect*

everything that we have gathered about him from various sources, and everything else we can get..."

Saying the word "immortalize", many of us do not even think how mortal monuments are today in any form. No matter in what way "they are oriented to eternity", the average "lifespan" is commensurable with the human one. Unfortunately, everything is forgotten. And bloody wars, and people's destinies in whom you can not correct anything, and people's writings, especially if they are related to their further development and perception of what is happening around them, if, of course, they are able to perceive it. Because it has become our past, distant past. Because what was in the past, in today's realities of a changing world order, is being perceived in a different way. The past events taken place, for example, some 100-150 years ago, 10-15 years ago were perceived by us in a different way compared to what they are being perceived now. This is an objective process affecting most people. But this can and must be resisted, and everything must be done to prevent this from taking place, the more so, with such a priceless heritage that is left to all of us. Since Nicolai is gone, I regretfully come to the conclusion that if it were not for the efforts made by the Clubs named after N. Levashov, as a new (at that time) form of relation of associates and like-minded people, and the spreading **of SvetL Technologies**, their application and the results that are absolutely public, and, strangely enough, the malicious attacks on the Technologies, which I have already mentioned, then after 3-4 years **THERE WOULD HAVE BEEN LITTLE TO REMEMBER** about Nicolai, even with his books being practically in the public domain. This is the reality of today, whatever one should say. Everyday life swallows up, and many significant things and events escape memory, move away like cold old stars. There is too much to think about every day, too much new information should be taken. A new way of life, new knowledge, new technologies, new words ... And people should not be blamed for that, especially today, taking into account what kind of transformations the whole of humanity is going through. But, for all that, no matter how much time has passed, whatever has taken place, there is something that you will never forget about – an indelible memory, something that has settled in a person tightly. For me, it's the memory of Nicolai Levashov and that work that we started with him, the memory of what he did for me, and how my life has changed after that. Probably, the same thing was experienced by people who had this idea – to create a virtual museum on the Internet first – public and accessible to everyone, collecting everything that can be collected about **Nikolai Levashov**, and then... then

we'll see. **The museum** is also a form of getting people together, as the museum is the **House of Muses** – an organization (institution) engaged in the collection, study and storage of objects of natural history, material and spiritual culture, as well as **EDUCATIONAL** and **POPULARIZING ACTIVITIES**. This idea is not new, since right after Nicolai's gone, some zealous "followers" started talking about opening a museum in France on the basis of a castle that belonged to Nikolai and Svetlana. There began making up plans, first taking into account their own interests, but it did not go further than idle talking. And, in the end, everything ended with the sale of the castle and the things that were there. But there were still photos, books, letters, projects and many things that the hands of this amazing Man touched. All this is kept by Nicolai's, mother Valentina Petrovna, and his brother, Vladimir. Exactly these people who came and come to see and help Valentina Petrovna gave rise to the idea of digitizing all the materials and on the basis to **FOUND MUSEUM OF NICOLAI LEVASHOV**. They are sure that **there will be no refusal from Levashov's relatives**. Of course, I have supported this undertaking, but suggested that emphasis should be made **at the educational and popularizing activities** – N. Levashov Museum – **FOR THE PEOPLE** as a **PLACE OF COMMUNICATION AND COGNITION**. I decided that I would hand to the museum photos and descriptions of those things of Nicolai, which for one reason or another "had come over to me."

Of course, in this museum there will be a place for a story about **"SvetL" Technologies**, the story of their development, application, and judgment of people. I hope that much will be taken from this book, which I have written and which I am now supplementing and expanding.

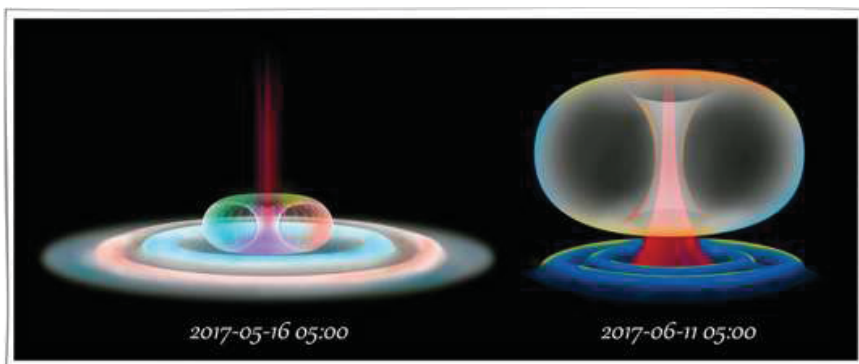

Finally it is necessary to understand that if we want to move forward in our knowledge of Levashov, then, first all, we must stop, comparing him with

anyone else using the notorious "binary" system of thinking about which it is well said in **The Third Appeal to Mankind**: "...the basis of the maximum mediocre Personality are the notions of **"yes"** and **"no"**, as allegedly existing and repeatedly manifested in the stepwise analysis of any complex process, including the evaluation of the activities of a particular Personality. The more so, the number of steps in the analysis is finite and, most often, very few, even if you are investigating rather a serious problem. The search for the answer is reduced to choosing one of the two, where two is the number of steps of possible solutions, while the most correct solution lies between them. Your mathematicians will understand the following analogy: the solution of the problem that comes out after solving particular questions of the type "yes" – "no" is analogous to the choice of one of the vertices of the **N**-dimensional cube, whereas the space of possible solutions consists of all points of the **N**-dimensional space. If to clarify, then the **REAL DIMENSIONALITY OF SPACE SOLUTIONS** is most often determined by you incorrectly and very rarely is in fact a numerical one, the present attitude towards you as an intelligent race is hampered by the following considerations of the information order. As far as one can judge, any scientific or legal law, the meaning of any discovery or invention, the essence of any important thought can be expressed by any phrase consisting of one hundred words from the vocabulary of **50,000** words, including mathematical and other symbols. The total number of possible phrases of such a vocabulary seems to be a very modest value **equal to 100**. If phrases with only a diagnostic essence are taken, that is, determining the essence, their number is reduced to **50**. If now we discard phrases in which the words are grammatically correctly connected, but their content does not even have any meaning, then the number of meaningful phrases will be reduced to **25**. In fact, by selecting true from false statements, according to the most overestimated estimates, gives a list of **only 3-10** statements and no more that could be expressed and correspond to reality. Meanwhile, representatives of the animal world on various Planets are known to be able of giving no less of various unconditioned reactions, quite adequate to reality, to various combinations of external stimuli, which, nevertheless, can not be called intelligent. Yes, and there is this kind of representatives on the Planet, too. Apparently, it would be more correct to consider Mankind to be not intelligent, but **POTENTIALLY INTELLIGENT RACE**, since the limitations of thinking, as you already see, *could not have been innate in you...*" So, only this way, and not otherwise. But most people, unfortunately, are not able to realize this even in their worldly life".

About the limited thinking and about who, how and why had done it, you have already read in the previous book. This, dear reader, should be taken into account when trying to understand and gauge such a Personality as N. Levashov. In the "Appeal" itself, if you are able to read carefully and get at the meaning of what you have read, and not only see the letters, everything is written that is related to the activities of **N. Levashov, A. Khatybov, N. Morozov** and those who published the "**Fundamentals of the Mankind Formation**". Everything that is written by them is precisely in the development and early implementation of **ALL** requirements of **CGO**.¹¹. That's exactly from such positions you have to approach these Personalities, if today they can be evaluated by someone. Try to read and reread the works of these people from the positions designated and prescribed in the "Appeal". And then there will be no disputes, absolutely groundless and unreasonable, relative to who is more significant. There is only one minor **BUT**, which, of course, can be taken into account, or can not, which I have mentioned many times. If you want to Know and move forward in your Cognition, then, first of all, you **HAVE TO START WITH LEVASHOV'S WORKS** as the basis for understanding everything new. And only after perceiving the initial, you can move on advancing and studying the works of A. Khatybov. Even N. Morozov's works, whom A. Khatybov called his teacher, it is best to cognize after becoming familiar" with the works of Levashov. I have already written about who and in what way made the decision to "move" the Entity of Levashov to the Earthly being. Nicolai not only brilliantly performed the entrusted upon to him while on the Earth, but he also brilliantly performed all that he had taken upon himself, and for which he had taken responsibility before his incarnation on the Earth. In fact, the book "The last Appeal to Mankind" is **THE FINAL VERDICT TO THE SYSTEM (MATE)**.

Our civilization in the near future is going to go through its birth. And if the "delivery" is successful, the Earth civilization will reach a new qualitative level of its development, when mentally, only by the power of his thought, a Man will be able to influence the ecology of his planet, control the weather, the fury of the elements, heal and restore the wounds of nature caused by the irrational activity of the man himself. Everything that we can observe today is the beginning. This is the victory won over the System, in many ways and thanks to N. Levashov. I'm sure that in the very near future, a man will be able to know himself, his own potential and resources of his

¹¹ Coalition Group of Observes (CGO).

Brain. Transition into the past, into the future, the space for billions of light years, will cease to be a "miracle", as some say, or "the ravings of a madman", as others brand with now... In time this will become just as common as travelling by airplane. All this will become possible only if the Mankind **PERCEIVES THE NEW KNOWLEDGE** necessary to rise to the next step in the knowledge of Nature. If the Mankind does not accept, does not want to accept the New Knowledge, the Earth civilization will destroy itself before the birth, and the "child" will be born dead... That's what N. Levashov used to say, and that is the really.

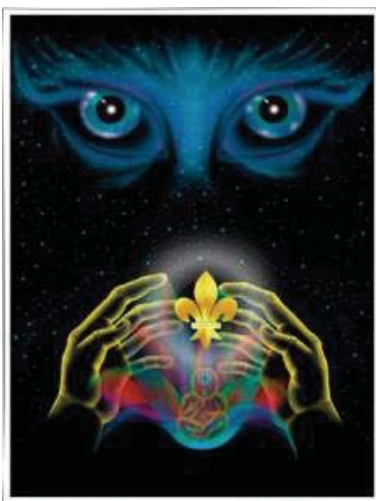

"How come! There are many who might get indignant! Had not our civilization achieved tremendous success!? The man had gone out into space, had been on the Moon, and soon he would reach Mars... (if, of course, people read both Levashov and Khatybov, they will know who will fly, in what way and where he will "land"). And in general, science, culture, art – everything is developing so rapidly, especially in the last hundred years... there was an information explosion... ***"The Last Appeal to Mankind"*** – sounds very categorical and peremptory. But do not rush

to conclusions, try to hear or at least listen... As Christ said: ***"He who has ears to hear, let him hear!"***¹² One can make fine food, but if a person dying of hunger does not want to swallow it, it is senseless to swallow food for him – all the same he will die of hunger... One can have Knowledge and the desire to pass it on to the Mankind, but if it does not want to accept it, so as not to perish, it remains only to regret it and try to correct what can be corrected, so that to widen that gap of time that people of the Earth might have to make their decision before vanishing in perpetuity.

At the end of this chapter, I would like to note that ***"SvetL "Programs*** have been created not to widen the gap of the remaining time, but in order that with their help (or rather, **AND** with their help) there should come into being those people who would carry this new knowledge not to let the Mankind perish. ***And those are not empty or high-flown words. Those are the realities of life today.***

¹² See the New Testament, the Gospel of Matthew, Chapter 11, verse 15.

Nicolaiy Levashov HAS BEATEN THE SYSTEM, BY HAVING MATE IT. And as you know, Mate in chess is a situation when the king is under the Shah, and the player (the System) can no longer make a single move to avoid it. *This means the defeat of the side that has gotten into such a situation. A Total defeat!!!*

Chapter 2. Physics of the Bath Taking Process

*"Do you believe in God? " – they asked me.
"I do not need it. I KNOW! " – I replied.*

I have always thought that *Man differs from animals and plants not by the fact that he wants but by what he wants*. The object of man's wish lies in the field of human aspiration for a certain amount of knowledge, having got it from the vast source of information. The Reason allows grasping all this amount of information. The information itself is available to all, but **YOU NEED THE REASON TO TURN IT INTO KNOWLEDGE**.

The trouble with many people is that they do not understand the global meaning of the ongoing events. **N. Levashov** explained it very well in the first volume of his book "**The Mirror of My Soul**". The Global understanding is always lies beyond the known and the comprehensible. It's a mystery before which the Man stops like a paper boat in front of a rock. The prophets and those who had the ability to do so could look into the future. They have never been understood. Just as until now not many are able to get at the meaning of what N. Levashov and A. Khatybov used to say and write. A lot of people consider the picture presented by them looks as fantastic, as ravings of an idiot. The impression is enhanced by the fact that they had to describe the future in terms of the present. People are able to indulge in fantasies only within the limits of the known. Two chapters of the third volume, "**The Mirror of My Soul**" written before N. Levashov's gone is a good confirmation of this. We look around and see different objects. But between these objects and us **THERE ARE ALWAYS MEDIATORS** - our feelings (sense of smell, touch, taste, hearing and sight). Our eyes get information from an external source and, through the "nerveous" channels, bring it to the Brain in the form of impulses. Into the head there comes not the chair we are looking at, but a set of impulses that the Brain deciphers into the image of the chair. We do not know how correctly the Brain deciphers, but we **BELIEVE THAT** it is **CORRECT**. There is no way to confirm this belief.

The reader has probably noticed that the more science knows about the world, the wider becomes the field of unknown. Everything is relative, approximate and doubtful, to know everything is impossible, even the

smallest speck of dust, not to mention a living cell or Brain activity. But people, contrary to their own logic, **BELIEVE THAT IT IS POSSIBLE TO KNOW ALL**. But the fact that this belief is strongly contrary to nature none paid and pays any attention to. Science becomes the authority of religion. Its bearers contrary to common sense have been believing ever since in an ability of science to potentially perceive everything. However, the scope of thinking of most people never goes beyond "to plant a tree, build a house, and bring up a child." All this, of course, is fine, but someone has to think of planting forests, building towns and educating the nation.

About modern science, we are going to talk, and in detail. Without this there will not be any understanding of how and in what direction to **"dig with a Broom of knowledge"**, but first of all - where we should take this **"Broom"**. That's why my only advantage over people, which I claim to - I always thought and judged on my own about what was happening . And not just because Levashov *"had taken me to the Bath"*.

We live in an era of epochal discoveries and events. A complete list of the events you can always "watch on the Internet or on **TV**. But it is better not to watch **TV** because then you will have to **"take the Bath"**. But not all are going to be allowed there. But, even if you watch TV and admire today's activities of: President of the country, the Government, the Olympic Committee, UN, UNESCO, government institutions, religious activities with the "gift of the Magi", scientific-research institutes and higher educational establishments and leading scientists, teachers, experts, statesmen and public figures, Nobel prize laureates, international and state awards in such areas as: information, Informatization, informatiology, physics, chemistry, mathematics, biology, astronomy, medicine, history, sociology, economics, computer science, politics, philosophy, cultural studies, informatiology resources and technology, mass media, informatiology security, etc. – you **STILL HAVE TO "TAKE THE BATH"**.

Our today's knowledge and cognition will not be able to escape it. Today, there are many (fortunately there is the Internet, where you can "pour out your feelings", show up yourself, and teach others), begin to talk about the Universe, the higher Mind and in general, less than universal issues are not discussed. With the foam at the mouth screaming at all corners: "We have read N. Levashov! We are bringing to the "masses» his new brilliant knowledge! We do not need more because we know! We have watched all his videos in **YOU TUBE** and watched more than once! " Others also cry: "And we have known **N.Levashov**, and have read **A. Khatybov**, (some add **N.**

Morozov). And now everything is clear to us, but "to put them together" **is impossible!** One contradicts the other. One is about the Entity, the other is about the Brain (and besides, about spermatozoons). The picture of the universe is not formed! However, there came into being some experts "of the **"Inhomogeneity of the Universe"** (for the ignorant ones - a book by N. Levashov **"Inhomogeneity of the Universe"**) with lectures and seminars for the followers. But for some reason none of the "organizers", "experts" and "followers" have never said (hidden knowledge?), what had been the reason for the creation of the Universe (at least – according to N. Levashov) and whether the Universe itself is the waste of the other process (at least, according to A. Khatybov)?

According to A. Khatybov, who I completely agree with, – the reason for the creation of the Universe was a **"Fire in the Bath"** because of the absence of **the "Instructions for use"**. And I should add – **taking into account** using **'the Broom and the Spade'** which "is in compliance with" the concept of the Big Explosion and the formation of the Hubble sphere ***so that the rest of the Cosmos could not intervene in the process of creating the living cell out of dust, as well as the homogeneity of the Universe.***

Of course, it is appropriate to attach the following:

- **Instruction No. 1** (in 6 volumes and 1 Appendix entitled "A. Khatybov's **Instruction for Bath Science**);
- **Instruction No. 2** (10 books entitled "The Source of Life" in two volumes and "The Spirit and the Mind" by H. Levashov);
- **Appendix** called **"Knowledge from На_Чала"** (**Knowledge from the Beginning**) (group of authors), and certainly, this book, if you finish reading it.

Some extracts from these instructions are offered to your attention. It should be emphasized that the basic material in mathematics, physics, chemistry, biology, medicine, and celestial mechanics is described in the best way:

- **in the writings of N. Levashov** ("The Last Appeal to Mankind", "Inhomogeneity of the Universe", "The Spirit and the Mind", "The Potentials of the Mind");
- **in the monograph by A. Khatybov** ("The Cold Nuclear Synthesis", where the work of **the Earth Life Support System** is revealed and looked into in detail.
- in the articles published on the website <http://rnto.club>;

- in the collection "**Knowledge from На_Чала ("Knowledge from the Beginning")**", that also explains what "**SvetL" Programs** mean, their fundamentals, potentials and all that is connected with them.

C It should also be determined with the applied terminology, so as not to mislead the readers in the process of getting knowledge.

1. The concept of "**BATH**" should be regarded as the WAY OF CHANGING THE STRUCTURE OF THE LIVING CELL AND THE STRUCTURE OF THE BRAIN within a relatively short time.

2. The concept of "**BROOM**" should be regarded as **THE RESOURCES OF THE GENERATOR OF "MATTER"** created by N. Levashov, and the potentials of "SvetL" Programes to promote change (improvement) of the structure of living cells and the structure of the Brain within a relatively short time.

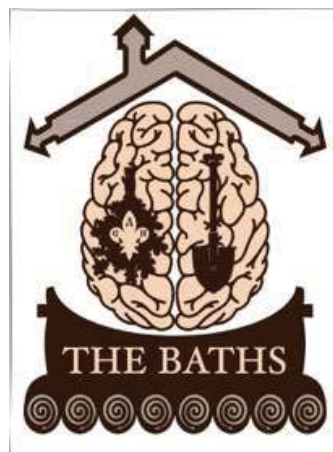

3. The concept of "**SPADE**" should be regarded as a **PERSONAL WORK OF THE INDIVIDUAL**, who through *discovering, study, comprehension and "application" of Instruction No. 1, Instruction No. 2 and Applications as well as the offered fundamentals* is given the opportunity to "get developed" " from the category of **PEOPLE** to the category of a **HUMAN BEING** in a **RELATIVELY SHORT TIME** (it depends on the Broom size and the ability to use it). From the point of view of knowledge, in these matters, it doesn't make any sense to focus on the study of the facts. I suggest focusing on getting knowledge on the whole and through this prism to dwell on details. N. Levashov used to say that it was impossible seeing problems like a tip of an iceberg to draw any conclusions. Conclusions can be made only after seeing the problem as a whole (the whole of the iceberg)!¹

When Nikolai Levashov and I discussed similar subjects, he was very correct when he touched upon those people who thought the world to be so immense that it made them **NOT TRUST** in their ability to **COMPREHEND** it. **BUT** they place perfect **TRUST** in those who, in their opinion, know the world better than most people. They believe in the illusion of the existence of a superman capable of solving all their problems for them. They are not able to realize that the Man who has comprehended the world and got rid of the load of illusions finds himself in the world of other dimensions and for the rest it is almost impossible to cross the line separating them from him. He

often no longer exists for them in the real physical world. He becomes a divine being worshiped and believed in. Nicolai did his best trying to convince people that they were mistaken. I also have to go this way when conversing with the people who have already got acquainted to some extent with the works of Levashov and have begun to study them. Now most of them are trying **TO CHECK** every **NEW** information on a particular subject **AGAINST** the information from Nicolai. But this "line-by-line" check **DOES NOT BRING TO LIGHT** the whole picture. We need the whole picture, especially today, when the events taking place before our eyes are so rapid. As for me I always try to watch a few "screens" and see all the information I possess or being given. The Dressing Room

Undoubtedly, the concept of the **Broom** we figured out above, it is extremely useful both in its availability and in the application, because we all know that the **BRAIN** is under the skull with the majority, and therefore, the space of research is known and does not require any significant investment in the store housing of separate elements of the object of research. But the basic energy constant of modern science is still **HORSE POWER**, so all that relates to scientific description, is "**HORSE KNOWLEDGE**", and all scientific ideas are considered **FROM THE HORSE'S POINT OF VIEW**.

From the directory of **John. Emily** (elements) it is known that a modern average Man (weighing 70 kg) consists of: oxygen 43 kg, hydrogen 7 kg, carbon 16 kg, phosphorus – 1.5 lbs. The rest of the table of chemical elements is presented in milligrams, including uranium deposits.

At the initial stage, after thoroughly mixing the hydrogen, carbon and oxygen and adding all of the elements of Mendeleev periodic table as spices, *a living cell has been got*. The secret of "spices", in contrast to the secret of Coca-Cola, was eventually lost, but the cell itself has been preserved and can "boast of its attire", from Nils BORR's and Kurchatov's. While creating a living cell, of course, no high technology was required: the initial compositions were pounded in a mortar and then warmed up to the desired temperature (not below the evaporation temperature of tungsten).



It is ridiculous, of course, but it was just so, because if there is no understanding of the world, no action can be performed. Or rather: the action can be performed, but it will be pointless. Imagine: you are in a space where everything is different. You have no idea what to fear, where to strive for, etc. All around looks wonderful, fantastic and weird, like in "Alice in Wonderland". There is no analogy with the familiar reality. You are being dragged with a flow of events, and you have no idea how to resist it. It happens like in dreams, where nothing can be done, because nothing is clear to you.

Freedom is manifested in action. The action is manifested in a choice. If there is no choice there is no freedom. To be able to choose you need knowledge. **KNOWLEDGE. IS STRUCTURED INFORMATION.** To turn information into knowledge, you should sort it out, laying separately harmful, beneficial, useless, and obscure, etc. Then there comes knowledge that makes it possible for you to define: what to strive for, what to avoid, what to ignore. Correctness of the knowledge is a relative question (the realm of faith). You might misunderstand the world and be free. The main thing in this situation is not correctness, but the scale of knowledge. Freedom comes if the scale of knowledge is not below the minimum. If it is below, then instead of a free action there will be a mechanical one, dependent on someone else's understanding, chance or chaos. And it was then when the "concept" of taking a mortar and pounding the original compositions in it came into being. Here you could rely on the fact that, according to the latest basic research, "Man, like the whole of the Universe is characterized by a five-dimensional measurement system and seven states: *solid, liquid, gaseous, plasma, information and physical vacuum, informatiogen vacuum and informatiogen*". That is, the living cell is no longer needed. There are, however, some modest statements of researchers of the **Edinburgh school** (England), with the temporal characteristics of DNA evolution. Back in the 80-ies they showed *that mutations of the genome of apes in the Human genome takes more time than the entire age of the Earth (over 4.5 billion years)*. At the same time, mathematician **Chandra Vikramasingh** and **Fred Hoyle**, an astrophysicist, (they worked together) came to the conclusion: *"Sooner the hurricane sweeping across the junkyard vintage aircraft, will assemble from pieces of scrap an up-to-date superliner than life spring up randomly out of its components."* Set out below is the material that claims to be the present day point of view of an unconventional approach, but the latest scientific achievements are taken into account.

A modern man has lived in artificial surroundings for quite a long time. He is formed by a flow of information being generated by the surroundings. Electricity, gas, light, water, sewage, groceries have become for a man the same routine, as the woods, trees, creek and mushrooms for a hare. The hare does not think where all this stuff comes from. A modern man also doesn't think where electricity in the socket and products in the store come from. For him it is the same reality as sunlight or air. *That's why you have to investigate the Bath in all its fine points and details.*

2.1. Let's look into the Bath

Everyone knows what the **Bath** is. Many have seen it and some even enjoy. It is known that after having the **Bath**, "you might lose your marbles", and you might find yourself in another city. There is no more cunning invention in the history of civilization than the **Bath**. Because, as Alexander Khatybov used to say and write, and you cannot but agree with it:

- **firstly**, no one knows what can be attributed to the concept of "**BATH**";
- **secondly**, even centuries of use of the **Bath** does not answer the question – what kind of changes take place in the human body after having the **Bath**;
- **thirdly**, what kind of **Bath** is better to have: the one that *generates cancer cells in a human body, or the other that promotes the formation of diabetes?* This dilemma may seem unsolvable even in the face of rapid development and progress of information technology in various fields of science and technology.

Once again, back to the applied terminology. The concept of "**BATH**" should be regarded as *the way of changing the structure of the living cell and the structure of the Brain* within a relatively short time. Indirect indicators (loosing of body weight, release from adipose protection) only add to the interest in the bath.

The Bath can be arranged on board the space station (Russian bath in smoke and steam is preferable) which you can escape of, leaving the ship without a spacesuit.

Let us consider briefly the classification of the well-known contemporary baths.

1. Russian bath with smoke and steam and with steam only.
2. Finnish bath (sauna)
3. Arab bath (invention attributed to Jews).
4. Roman bath.

The above classification of **Baths** is for a layman or an aborigine, who are not familiar with the **Bath** and who are supposed to be dragged there with the help of advertising and even sex shops. The aborigine might, of course, detect the absence of the Brain then, but this factor should not worry him, because in the history of the "bath business" this question has never bothered anyone or evoked unfavorable criticism even in the absence of this instruction.

To have a more global idea of the Bath in addition to it there can be included the following:

1. Chizhevskiy Lamp (an electric chair).
2. The hyperbaric chamber.
3. The car (country of origin not important).
4. Any enclosed space with the power turned on (e.g. 50 Hz that is extremely popular in the expanses of Russia).
5. Electric impulse instruments and appliances used in diagnosis and treatment (especially the Brain).
6. RLC circuits built on the laws of form (lightings)
7. Radio phone as the most economical device to turn off the brain (in common – the dumbbell to the Brain).
8. Systems built on the magnetron.
9. Airplane, spaceship.
10. The sea.

The Additional list is not for Aborigines. First they have *to pass the first 4 points*, and only then to choose by their taste what they are imposed.

The Bath is intended for a man (it was assumed that it would be used immediately after the tail had fallen off and the stick caught). Nobody tried to use the **Bath**, for example, to bathe an elephant or even a cat. The animals are very sensitive to their brains and do not seek to use the **Bath** on their own.

So, why do we need the bath? It is known to everyone – to steam out the skin so as to wash away cell waste and dirt, to remove epithelial cells that do not want to take part in the production of the offspring of the "King

of Nature" (we mean a Man), and also to change the heat balance so that we could also lose weight. Baths are mostly built of wood. But here it is advisable to consider a number of options.

A wooden bath

The Bath is ecologically friendly, insects at the temperature above **37,5°C** have time to hide in the cracks and get out only on a freshly washed body, so there is no danger of losing them. However, wooden baths often burn for some reason, and insects may not be in time to return, which is fraught with greater financial costs than the cost of the burnt laundry and the bath itself. **From the unscientific point of view**, spontaneous combustion of a bathhouse occurs because wood has the property of "collecting" water potentials, and when it reaches **124%** of the norm (the limiting state of destruction of the wood structure grating), there occurs, as if "collapse" of the grating with a loss of a number of frequencies in **44.375375 octave** with the formation of grating in **54.375375 octave (soot)**. The difference – the potentials in **48 octave** are clearly visible to the unaided eye **in the form of fireworks (fire)**. The inverse transformation, as a rule, is difficult. You can, of course, "measure" how much horsepower is released when one medium bathhouse is burned. In octave this value exactly corresponds to water energy reserve that has undergone the appropriate transformations.

It is known that the forest is on fire after rain (this is what we observed in Siberia in the last three months of 2015), and the bathhouse – after the washing.

B There are Russian and Finnish Baths. There are no African baths, for example. It is quite possible that in Africa there were baths, but without a bath attendant, and lack of sense of time, with all the bliss from the pleasure received, the aborigines did not have time to jump out in time, they had to participate in fireworks, the evidence of which is their skin color and the customs to dance around the fire. There is no problem to notice that, if you are not that lazy.

Russian Bath

There are two types of them – "with smoke inside" and "with smoke outside". The bathhouse is safer "with smoke inside", as the potentials intended for the bathhouse are partly spent on keeping up the fire, so the bathhouses "with smoke inside" burn by 30% less than "with smoke outside". In any case, the peculiarity of Russian bath is an **OVERSATURATED**

STEAM AT 100% HUMIDITY. This kind of steam one can get in any conditions (the fire is under the pan; the steam is above it).

A short remark

With this method of obtaining steam, a number of interesting features have been discovered:

- the pan should always be filled with water by $\frac{3}{4}$ as the so-called "light" fractions evaporate first and the steam contains the octave of **49.225225**, which has a beneficial effect on the lungs, **restoring the lungs' memory**;

- If all the water is used in the pan (for steam), then heavy structures, having a higher octave, for example, **77.450450**, can cause "poisoning" of the Brain, and with frequent use of the bath cause the destruction of it;

- in the bath it is recommended to use not only soap – you have to remove soap only with acid solution (although, in this case, insects will not want to come back);

- after Russian bath, they usually "consume" vodka to enable the high-frequency part of a living cell to maintain balance and not load the urinary triangle;

- instead of the acidic solution **you can use cold water or snow**, but snow is not brought to the bath, and people roll about in snow and rub down outdoors. If the remains of the acidic solution are poured on the wooden structure of the bath, the probability of its self-ignition will be slightly less.

Unlike other types of baths, **Russian bath DOES NOT CHANGE THE WATER BALANCE OF A LIVING CELL** if it is known in what order to use bath accessories and solutions or to be a participant in "SvetL" Programs.



Finnish Bath (sauna)

Finnish bath, or sauna is the most common bath. **Firstly**, they burn more often than Russian bath, and even "**SvetL**" Programs will not save. **Secondly**, it makes no sense to steam at a temperature **below 123°C** – there is no water in the steam room. The main difference from Russian bath is the way of getting steam: in Finnish bath all the water is poured onto the glowing stones, more than 75% of the frequencies potentials of this steam are of high-frequency. These potentials can both add the potentials of a living cell, and superpose these potentials by eliminating some of its frequencies, as a result of which *a fresh virus with prescribed properties or a **CANCER CELL** can be obtained* from a living cell. In addition, Finnish bath is used to "loose" body weight. However, delusion is impossible here. A living cell consists of water as well and the superposition of the potentials leads to a decrease of water in the cell (reducing overall weight). Here, the "crux of the matter". Good or bad, think about it, if you have already been invited to **the Bath**.

Before visiting Sauna, the living cell is balanced and formed the ionic sediment *that shortens her life*. Having changed the water balance of living cells in the Sauna (after the Sauna, as a rule, people rush to drink water, beer, etc.), the cell gets fresh potentials at a high angle slide, which immediately begin to form additional ionic sediment, until it reaches the water balance of the cell. *That is, frequent use of the Sauna leads to **RAPID AGING OF THE BODY** and to the change of the frequency connection of the Brain*. However high fashion for sauna and its effectiveness, especially during business meetings, allows us not to take seriously some inconveniences, which might arise months or years later. It is known that *absence of the brain even in a big head raises no serious objections*.

Arab baths should be included into a separate category. Taking into account African experience in using baths, some damage to health of the Sauna and the lack of snow for the organization of Russian bath, in some Arab countries they go to the bath once a year. Bath is a washtub filled with water. You can lie down the washtub with your clothes on and under the warm Sun bask in the same aqueous solution, which remained from the previous bath-lover.

This kind of bath has a lot of advantages: it does not burn; water cannot dissolve all the dirt, so your favorite dirt can always be saved. Water does not give the frequencies, destroying the living cell, i.e., it is ecologically

beneficial. ***The Jews are trying to assign the authorship of this type of bath to themselves***, but that is just (as always) an *attempt to misappropriate most valuable inventions*.

In ancient Rome pools were used. Bath houses were built of marble. But the marble has one unpleasant characteristic – ***it has a negative potential in 61.5 octave***, and a long sitting on the marble with the steam temperature ***over 72°C leads to the ELIMINATION OF SEXUAL ACTIVITY***, so these baths, did not get further development after the extinction of lovers of these baths.



Modern development of science, especially in the bath business, led to the development of **public baths**, built of red brick. These baths have a number of advantages:



1. **They do not burn**; at least after burning down the wooden parts the skeleton of the baths can be used further.

2. **The weather** does not affect bath-lovers – a magnetic storm first passes through the brick grating (the base – **54.625125**) and is converted to harmless negative electric potential. If the humidity is 100%, then this bathhouse is a perfect shelter from any magnetic storms.



3. **The color of the brick** determines the salt of mercury. Red color is preferable. It is known that mercury is the basis of a living cell (see the thesis, RANS) and the closer the brick grating to **54.00000000**, the more comfortable the living cell feels. **However, there is one inconvenience** – you cannot sit on brick (range of the grating is 3-20 cm). It has been observed in mice and rats that they avoid being even ***near a warm red brick, fearing for their offspring***.

After making a cursory analysis of **the Bath**, it should be noted that having a **Bath** without accompanying materials does not make any sense, therefore, let us consider briefly the catalysts in the bath process.

In our case, the **Catalyst (biological)** is what accelerates the "reaction", but is not a part of what we have to get. The catalysts, about which we are going to talk, can be active and passive. **The active** catalysts are in the same phase with each the reacting processes, **the passive** ones form an independent phase, separated by a border from the process in which they participate. For each bath process only certain catalysts are effective. Катализаторы в банном процессе

2.2. Catalysts in the bath taking process

After a busy day full of events and actions consuming great capacity of the respective convolutions of the Brain, a short recovery process is necessary in which the Brain gets free of unnecessary "junk"; and working cells of the body – from outside "witnesses". Urbanization has contributed to the bathing process. With the technologies of the XXI century having a **Bath** does not take 2-3 hours as it used to be but tens of minutes.

Advanced technologies include *the invention of the catalysts*, and **"SvetL" Programs**, which are also the catalysts that significantly reduce the time spent in the **Bath**. As a catalyst (that has long been known to many of us, of course), a **"cat instead of a washcloth"** can be used. But technical progress has gone so far that it's impossible to describe all the technical innovations available today in the bath process.

Thus, the catalysts. The catalysts can be electro-sound, magnetic, gravitational and others... We are interested in **BIOLOGICAL CATALYSTS**, since the *Human Brain was created from the Earth potential*, that is, from all that remained after the formation of the Earth from protoplanetary dust.

Crowds of the unicellular and multicellular, are still besieging the location of the Brain of the "King of Nature", and can't stand the thought that they are not needed for an active employment. For this reason, they try to please the Brain at his leisure.

Not the lazy part of the unicellular and multicellular organisms (including some bacteria and viruses) formed a Guild that can compete with any technical innovations in bathing the "King of nature". In the Guild, as in

any party organization, everything is divided according to the principle "he who does not work he will eat". From the point of view of the evolutionary development the passivity of one group and the activity of the other form the golden section, the characteristics of which are passed to those wishing to use the services of the Guild. But "**SvetL**" **Programs**, also created in the limits of the Golden section, can resist it better than any "wash-rag".

Thus, we "get down" to biological *catalysts, of passive and active types*.

Biological catalysts of the active type

An active type of the biological catalyst when it is used in the bathing process is not designed to entertain like a Japanese geisha, but like a combined procedure in the same way as a brothel where there are no problems in the choice of means of the client's leisure. The brain has to participate in this process by holding separate convolutions of the brain from temptation. In addition, in a short time the Brain gets free not only of money but also donates some potentials and frequencies unnecessary in the daily activities. *Biological catalysts of the active type prefer, however, high octave frequencies*, clogging the Brain with their presence, bringing it closer to the fundamentals of creating, that is, to the original dust. But "**SvetL**" **Programs** will not permit to do that. Of course, if they **CORRECTLY INTERACT WITH THE** owner's **BRAIN**.

As soon as the "King of nature" finds himself in the field of active types (hereinafter referring to biological catalysts of the active type), there forms a queue according to the characteristics of the group. There are a few groups of this type, and each group has its own purpose. One group distracts certain convolutions of the Brain from everyday worries, the other strips the convolutions, the third searches for all that is too easy to find in the pockets (i.e., in the convolutions), the fourth gives the appearance of decency and so on. Therefore, it is necessary to classify groups of the active type.

Classification of active type groups

	Type of the group	Lifetime of an autonomous structure (The Hulk)	Frequency range, octaves Minimum/Maximum	
1	Administration	0,2	41,875225	44,625375
2	Standardization	2,7	45,125125	47,625975
3	Maintenance	16,2	51,450450	57,375225

4	Service	224	61,875125	67,375375
5	Transport	512	77,225375	81,975975
6	Emergency	640	85,225375	91,125975
7	Search	720	93,225225	93,375975
8	Security service	840	93,450450	95,625375

Note that group 3 includes *available frequency* **53.375** (gamma radiation).

For all groups the spacing for available frequency range is quantized in accordance with the carrier frequencies of the living cell. Frequent change of the administration eliminates corruption and promotes a healthy climate. Due to the seasonality, the standardization group cannot use the standards of another season.

The most dangerous is the work in repair and maintenance groups. It is necessary not only to have time to replace the missing or runaway convolutions, pick them up in standard from the previous group, but also to record the necessary information (to make out a bill for the bath process, a football match, etc.). You also need new convolutions to align in the place, to remove the potential storage and coordinate all the work with the administration request. The solution to this "problem" will be taken care of by "**Svetl**" **Programs** if "the enrolled" to have **the Bath** have them.

The transport group moving from the individual convolutions to the working cells coordinates the routes of food delivery to the cells and the schedule of waste collection according to the estimates approved by the administration. This process takes a long time and usually unscheduled (might be continued outside the **Bath**). You have to negotiate the caprices of the working cells with the spare convolutions in the warehouse and the maintenance capabilities of the group. In the period of mass strikes of the working cells, lack of stock of spare parts, excessive amount of waste, etc. the emergency group seeks an early release of the **Bath** from the patient by disconnecting the individual brain structures both from links with the working cells and with the information field. Here the scheme of disconnection is agreed with the standardization group and approved by the administration. "The Patient" comes out of the



Bath quite satisfied as the rest of the structures properly perform their functions. The replacement, as a rule, is produced from the frequency range provided by the group of standardization.

Biologists, for example, make experiments on mice, as a mouse Brain is fully compatible with the Brain of the "King of nature".

C The largest is **the search group**. The group's objective is to find a patient for the **Bath**, wherever he is. The group has all the capabilities, including the information via the allocated frequencies. The directory allows selecting the most promising patients (with the minimum number of substitutions and a maximum of withdrawals). Delivery of the patient to **the Bath** is carried out by the security service.

The employees **NOT ONLY WRITE ANEW** the patient's **KARMA**, registering the information about the immediate visit **the Bath**, but also see to it that other groups would not take away the values withdrawn from the patient. Each new patient is registered in the administration group that makes an individual plan of bathing. Here "**Svetl**" **Programs** can provide an invaluable service and either take the "Svetl" owner to the **Bath** without queuing, or not let him in.

The active types structures for the Earth

The description of the structure of the active types will be incomplete if you do not specify that on the Earth, due to the acute shortage of the biomass, many functions of the active type groups are combined. In addition, it is expected in the future to adopt a universal model for the bath taking process, which will make it possible not to drive the patient in the **Bath** ahead of time (or with delay).

Note that *the bathing process takes place in neutrino space, the access to which was previously denied*. The new resources allow the search group, to which **sharks and dogs** can now be attributed, actively get down to work. Sharks, for example, can carry out propaganda work on the beaches or at the tourist ocean liner, and the dogs can just **RECORD THE INFORMATION TO THE OWNER** that "it is time to have the **Bath**" (at the same time performing the protection function). This is a



valuable quality in dogs, which the owners love and become attached to them. The Dogs, being able to share their experience in the information network can use the database on genotypes and select those who, from their point of view, are in need of the repair and restoration works, as well as in the new information support. If there are neither dogs, nor sharks close "at hand", it is advisable **to use "SvetL" Programs and preferably in the form of the Complex.** But for this you have to read and understand what I have written here. That is easy, if initially you have read "**The Spirit and the Mind**" by N. Levashov and realized whether you **HAVE** the Brain at least **OUTSIDE THE NEUTRINO SPACE.**

Taking into account that **the neutrino structure of the Brain** in dogs and sharks in the program is to be of a higher octave than in any patient, they do not need to consider the patient 's caprices, it is the responsibility of the administration, the part of which can successfully be performed by bacteria. New neutrino structure of bacteria ensures the continuity of the decisions taken in accordance with a new program and does not make it possible to violate the terms of their existence on the Earth. The distribution of the remaining obligations is to be completed soon and the material to work with maintenance groups is being accumulated, the information support is being prepared (in line with the new program). Here it is worth noticing that "**SvetL" Programs** take an active part in it, if you are a member of these Programs. Some cells might not agree with the innovations, but there is a Chinese method of education. Besides, no strikes of the working cells are able to stop the scheduled process of the **EVOLUTION AND CONTROL.** It is impossible to allow spontaneous cells division and creation of the uncontrollable mutations.

The group of standardization should be paid special attention. Everything depends on the mode of operation of the group and the selection of the personnel. The stuff needs to be large enough and the storehouse reserves unlimited, as those wanting to have the **Bath** might be more than enough which is being observed everywhere.

So, what are the requirements for the standardization group?

Firstly, the identity of replacement parts, i.e. the mandatory presence of potentials and **frequencies of 56.75 and 58.35.** Each inventory item must have a tag indicating the availability of these frequencies and the instruction for their use. A copy of the manual is available at the administration.

Secondly, it is compulsory to have potentials to the adjacent frequencies – **61.5, 63.5, 65.5, 67.5**. From all the variety of biostructures the presence of all this is observed **in cockroaches, rats and sharks**.

Let us consider the qualitative characteristics of the biological objects. It might be revelation to the reader, but it is true. **A COCKROACH**, according to Korney Chukovskiy's description is a "terrible bewhiskered creature" putting elephants into fear. An interesting fact about the cockroach is the presence of the skull, exactly molding the skull of "the King of nature." According to the laws of the form there is no need to store so high octaves in such a skull. It is quite enough to reduce them in their original form for a good lot. In addition, the autopsy of the cockroach's skull has shown a complete absence of the biological structures – the system of input /output which does not allow outside systems to use the storehouse reserves. Frequencies **61.5 and 65.5** are available and can be put at the disposal of the "King of nature" in everyday life.

Now standardization for the well-known properties with the New Program enables the "King of nature" **TO HAVE THE BRAIN BIOSTRUCTURE IN NEUTRINO SPACE**, and to use the vacant room in the skull as an incubator for the cultivation ions beneficial for the organism. Of course, *it might not be enough cockroaches for all* (especially at the start of the **replacement Brain** Programs; it is unknown how many will be required for a single replacement), but the administration will always find an adequate substitute, even by self-sacrifice.



Similarly to cockroaches **RATS contain the Brain in the neutrino space** too, but before the start of the program they waist the power accumulated to implement the Brain REPLACEMENT program, by creating around themselves a "ball of fear" and parading before the "King of nature" with open jaws. Of course, the top octave of the Brain in rats is lower

than that of a cockroach (and meets **58.35**), as the octave frequencies are not folded, but in the absence or lack of them they can be temporarily used.



The most valuable quality as a standard has a **CROW**. **First**, she does not creep, that is, her Brain is not afraid of heights. **Secondly**, her Brain is also in neutrino structure, but folded. The crow's Brain is extremely beneficial to the employees of the banking sector (it is known that crows lift everything that glitters, unaware of their hidden opportunities). The

range of hidden **octaves is up to 63.5**, which is quite sufficient for the majority of "Kings of nature". A crow is the most intelligent of the known feathered. This quality enables her to exist peacefully in any environment.

The whole set of potentials and frequencies in the standardization group have **SHARKS**, but they are hard to please, and the administration is not always able to take advantage of their helpful attitude. And when sharks are not "drawn in" by the administration, they are involved in other processes and activities.

In 1986, newspapers reported that sharks had damaged the fiber-optic cable, laid between the Canary Islands. It was even suggested that sharks supposedly indifferent to electrical cables, for some reason, attacked the fiber optic cables. This assumption was, however, refuted in the fall of 1987, when American signalmen donated to the Museum of Natural History in New York a collection of 350 broken shark's teeth extracted from the various cables and telecommunications.

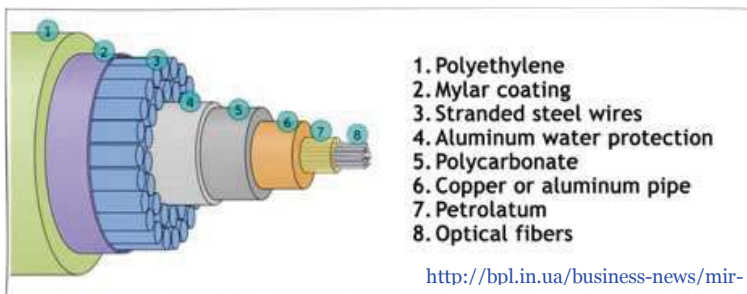

Ichthyologists believe that *sharks can sense very weak electric field to find food exactly by the "electric trail"*. In worldly terms we

get it that around any submarine cable direct current supplying amplifiers form an electric field. So the aggressiveness of the sharks is not surprising.

What is **ADMINISTRATION** and why do we have to ask it and to "report" to it? It is a life-support System of the "King of nature" in the framework of the Earth Control Systems.¹³

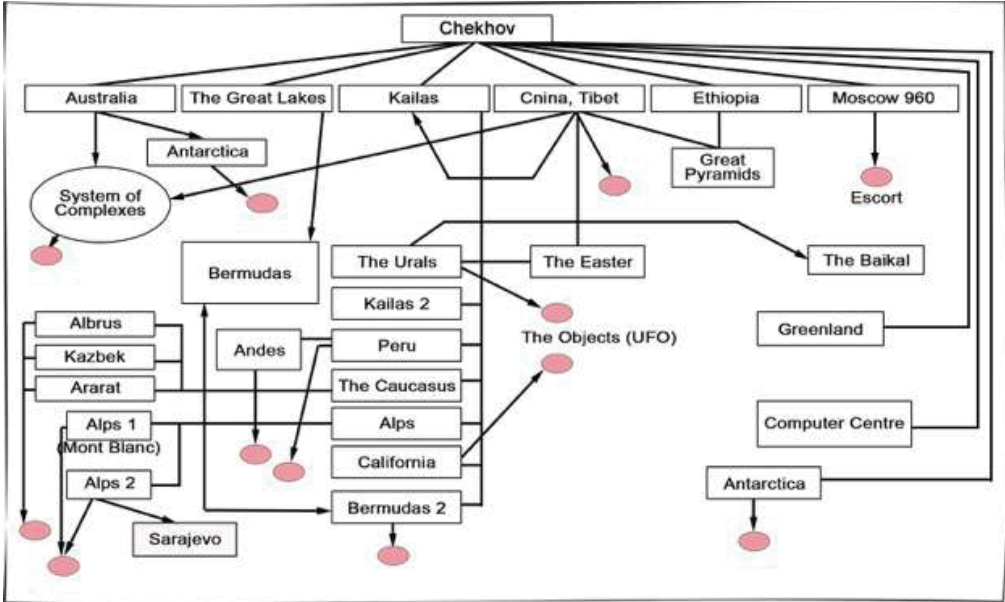

The Earth Control Systems

Nº	Complex	Function
1	Chekhov	Control room, main control system, setting Programs for all complexes.
1.1	Australia	Complex for changing the Earth topography (land and sea), bringing to conformity winter and summer.
1.2	Antarctica	Main complex to set winter-summer.
1.3	System of complexes	124 complexes on Earth, including Stonehenge – control and modifying surfaces on land and in oceans and seas.
2.1	Great Lakes	200 km North-West of New York. Coordination and monitoring of the state of all 7909 objects (UFO) on the mainland and sea-based.
2.2	Bermuda, the centre	Main energy complex to work for all objects, control over the production of octave 60 k-structure.
2.3	Bermuda 2	Energy complex of production octave 60 k-structure.
3.1	Kailas	The main Control system, correction in accordance with the atmosphere Brain Program and all genotypes on the Earth.

¹³ For details see Book 1 "Unmasking the Hidden" (Intervention: how it happened), chapter 1.1.)

3.2	China, Tibet	Control of the atmosphere state during the correction of the atmosphere brain and communication channels of 560, 520, 500, 440, 960 objects.
3.1.1	The Urals	Brain Casing (63 octave) for all genotypes (from the unicellular to man).
3.1.1.1	Baikal Lake	System of emergency rescue of humanoids 42, 44 in the event of a disaster.
3.1.1.2	Easter Island	Conformity Control of the brain casing and octaves from 49 to 59 for all genotypes.
3.1.2	Kailas 2	Routine (weekly) monitoring of the Brain.
3.1.3	Peru	The Main control complex, maintenance and storage of humanoids (for future use).
3.1.3.1	The andes	Control of all humanoids on the Earth.
3.1.4	The Caucasus	Main control Complex, control of the "Golden billion" – genotype 42 (cut off).
3.1.4.1	Elbrus	Territorial complex – the European part of Russia, Belarus, Ukraine, Bulgaria – total control of genotype 423 (reprogrammed).
3.1.4.2	Kazbek	Territorial complex – the East and the South Caucasus, Central Asia, East of Asia Minor – full control of the genotype 422 (reprogrammed).
3.1.4.3	Ararat	Territorial (first on Earth) complex – Asia Minor, Greece – full control of the genotype 421.
3.1.5	The Alps	The main Control complex, control of the Golden million genotype 44 (cut off).
3.1.5.1	The Alps 1	Territorial complex – France, Spain, Portugal, Italy, Western Europe – full control of the genotype 441 (reprogrammed).
3.1.5.2	The Alps 2	Territorial complex – Eastern Europe, Germany, Baltic States, Scandinavia – full control of the genotype 442 (reprogrammed).
3.1.5.2.1	Sarajevo	Main energy complex of octave 53.5 (all types of radiation). The first atomic bomb was developed in Germany.
3.1.6	California	The Main complex for training a new genotype – 46, (put into operation in 2012) (cut off).
3.1.7	Bermuda 2	Energy complex for production of 60 octave k-structure. Weekly pumping of transformation Systems 560 and the atmosphere brain.
4.1	China, Tibet	The Main control complex on the Earth, setting the standards for all complexes.
4.1.1	Easter Island	The coordination control unit via Kailas.
5.1	Ethiopia	The main control and supply center of the communication tubes with the satellites of the planets (see planet's satellites).
5.1.1	The Great Pyramids	Pumping System, removal of information (and transmission) from the satellites of the planets.
6	Moscow 960	The main object of the Control System (UFO), all brain matrices of 42, 44, 46, of Moshiaich. (cut off).
7	Greenland	Control of the atmosphere brain.
8	Ireland	The Computer center. All types of calculations. By the way, Ireland takes the second place in the world in EC

		programming. At the same time, Ireland is the birthplace of unsolvable problems production.
9	The Antarctica	Next to "Mir" station. Switch of Summer-Winter mode of operation and a shift of the timing by 1 hour (at 10-25-03-14-45).

You have to understand that ***the Programs that "had provided" the solution of the tasks on the development of specific genotypes of the Brain are removed. SOME OF THE COMPLEXES "ARE CUT OFF" AS UNNECESSARY.*** The rest of the Complexes, with New Programs are used in this most difficult transition period and directly "are involved" like the administration in the bathing process.

Nature reserves that created ideal standards are **NOT LIMITED**. The matter is only **IN THE METHOD AND QUALITY OF THE BRAIN REPLACEMENT**. It is not necessarily to make the "King of nature" drag himself to **the Bath**, knocking in his head what is still too early for him to get. ***There are quiet and unnoticeable ways of replacement.*** These methods are known to biological catalyts of the passive type. *It is quite different, if you are a member of "SvetL" Programs. This will make it possible to avoid cockroaches, crows, sharks, and will not "force" the member (even if he still considers himself the "King of nature") to line up to the Bath. He might be allowed to let in without queuing, especially during the current events.*

Biological catalyts of the passive type

Now we consider the biological catalyts of the passive type. What is **the catalyst of the passive type**? It is primarily direct and inverse transmitter of the potentials. The purpose of this type of the catalyst is connection with the administration (getting instructions and reporting on the work done), transmitting, lulling (instead of anesthesia), combing and wetting (washing). All of these functions do not require active mobility, and they can easily be performed by biological structures at least having a tail.



The tail is *the closing ring of the coaxial cable in the octave of 50*. In

addition to performing the regular duties, this type of catalyst **MUST** not admit to the Human Brain those structures which might damage the bathing process. And there are plenty of them nowadays. Of course, the passive type can be used for its intended purpose, for example, instead of a sponge or shoe brush for shining shoes, as well as oakum for plugging the slits in the bath. When used as a sponge or brush for rubbing shoes the she- cat fits better, since the he-cat has an individual protruding part that might scratch the skin of the "King of nature" or his boots. As an example, of *the catalyst of the passive type it is better to consider the she-cat (the he-cat)*.

We note immediately that if a cat falls off some height, it will land exactly on its feet. Nobody has seen a UFO flying upside down. The same property is possessed by this type of catalyst; it is like the law of the "sandwich", which always falls butter side down, and a cat never falls on its side or back.



Primitive "Kings of nature" tried to dress up exactly in skins of the felidae (see S. Rustively's "The Knight in the Tiger's Skin"). Thus, they were disguised as innocent beings. Cats have plenty of valuable qualities. **First**, they are mainly half-asleep. A place to sleep is selected basing on the needs of the «King of nature" – from head to toe. That is, the cat never sleeps anywhere, but makes itself comfortable where there is some need to ensure maximum inflow or outflow of the frequency potentials obtained from the administration directions for the specified patient. Here **UNNECESSARY POTENTIALS ARE JUST SCATTERED**. Upon completion the work there starts purring "come, cockroaches, I'll treat you to some tea", which literally corresponds to the invitation of the standardization group to perform its functions.

If there is some need to smooth something the cats are equipped with powerful brushes, made according to the bioamplifier scheme. During the visual inspection of the paws, "the combs" are invisible, but if necessary, the cat let its "combs" out from under its soft paws, leaving indelible impressions for a long time. If the "King of nature", lulled and sleeping in serenity (unaware of the fact that during his sleep a **PART** of the **BRAIN HAS GONE**), makes an attempt to throw off the cat, it reminds "the King of nature" in a soft and unobtrusive way, with the help of its "combs" that the process of his brain elimination is not yet finished, and he is not supposed to

turn round. If the "King of nature" is short of time, he may be early to call for music accompaniment, scratching the she-cat behind the left ear (he-cat – behind the right ear), that is the very place of the **"transmitter"**.

You can find all this in the administration directions (**"The use of detergents"**), I will tell you later about. In addition, the instructions notes that for the transmission of unnecessary potentials to the cat, they should be stroked from the head to the transmitter, not vice versa.

Despite the seeming passivity, the cat's type has an extraordinary jumping ability, especially if it sees that the wanted potential is going past. Unlike security guards the cat is not able to sniff the potential so that to recognize it, having a displaced vision, therefore, even under the cover of darkness the potential will not be able to slip through unnoticed.

It is noticed that the he-cat itself chases the potential, and the she-cat is waiting for the potential to come up to her. For the painless withdrawal of the potentials from the "King of nature" there requires anesthesia, and for this a number of songs being sung by the cat are successfully used. Choral singing of these songs is practiced by the he-cats, while the she-cats do not participate in the choral singing – they are too shy. Choral performance is practiced once a year in March, when the «King of nature" is required not to sleep for the period of intensive work of the Life Support System. Of course, the bloodthirstiness of the "King of nature" has no boundaries. It can be judged by the saying – "...and then – soup with the cat." Meekly carrying out its duties, the cat lead a miserable existence, about what they periodically inform the administration.

Periodically, the cat tunes the transmitter, moistening it with saliva, and tears. From the outside it seems idle pastime ("when the cat has nothing to do..."). As a rule, the passive type is equipped with a powerful receiving system (frequent change of "instructions" by the administration makes it necessary to have a supply of additional antennas). The cat does not need them really, so there is an expression "to look like a mangy cat." Cats like "Kings of nature!" have a good opportunity to get AIDS and in line with the directions (under anesthesia) to pass it to the «King of nature". Therefore, if the "King of nature" likes to get it, the administration will give the appropriate instructions. Of course, mistakes are possible, but we have to keep in mind that cats **TRANSMIT ONLY** what they are passed from the storehouse. By the way, if you take the cat's biochemical analysis of blood, you will not find AIDS, since the structure of the frequencies and potentials provided from the storehouse have separate packaging; and the assembling

TAKES PLACE in the **BRAIN ITSELF** of the "King of nature" according to the instructions.

The cat's modesty has drawn attention to it – they say that a cat having stomach like a thimble, is able to eat up a whole bowl of food. Sometimes cats are misused, for example, for the mass movement of the "Kings of nature" (if a black cat passes the road, there starts panic). An indispensable feature of the cat is catching the potentials necessary for the "King of nature". For example, the "King of nature" still has not learned to catch mice and eat them immediately (getting the right potentials). This function is successfully performed by the cat, *passing then to the "King of*



nature" to the accompaniment of its purring everything that the mouse was rich in before being eaten up. And **THIS IS NOT A JOKE.** *The mouse Brain is known to correspond exactly to the human brain.* This property is actively used in medicine, in particular, pharmacology, where the effect of medicines is tested on mice, and if the mouse is not sick, the cure is prescribed for the «King of nature's" use. However, while preparing medicines different chemical additives are added that might cause allergy or other negative effects. As for the cat, it divides the mouse into its component parts and passes to the "King of nature" only what he is supposed to have, and the purr does not cause allergy. An amazing feature of the cats is their patience. They can sit for hours waiting for a mouse to come out (they don't run about looking for it here and there). But when an arrogant and hairy muzzle of a mouse pops out of the shelter, immediately "the combs" are set in motion, and only after a proper grooming the potentials are removed in the correct sequence. We note some other peculiarities, clarifying the above. Under the he-cat's tail there is a huge waste bin (thoughts, projects, results, etc. are collected there). Hence the expression "under the cat's tail". The he-cat lives less than a she-cat because the he-cat walks by himself, *while the she-cat – only near the "King of nature" removing the excess of potentials.* We also note that the he-cat looks for the mice, while the she-cat waits for the mouse on its own to come out of the shelter (there is an analogue when Cobra hypnotizes a mouse).

After completing all the items of the directions, the catalysts of the passive type have a rest. The he-cat sleeps stretched out, and the she-cat rolls into a ring, closing the ring of the octave of 50; so even when being asleep a she-cat's reaction is much faster than that of a he-cat. When changing the environment phase, a she-cat has the quality (a he-cat does not) to change the phase according to the current one ("at night all she-cats are gray"). Besides, she-cats sleep on a soft place, and he-cats – anywhere. If you ask a she-cat what she sees in her dreams and how she manages to see in advance those who can offend her, you will walk with your mouth open for quite a long time. **Unlike Nostradamus he-cats possess some practical prediction.** All that for a few months or years before the events the he-cat has been doing, will be replicated by the humans and successfully used in everyday life. So, in "**Prostokvashino**" it was shown for the first time how to organize market relations; and in "**The Cat in the Boots**" – in what sequence it is necessary to withdraw the property from "the non-selected" (raider's capture). As noted by Chukovsky, the cat "goes backwards" (if the security guard is lame). And of course, the immortal image of the cat Behemoth who knew how to behave. Here it should be noted that exactly the she-cats "communicate" with **the owners of "SvetL" Programs**, but the he-cats run away from them, as a rule. It stresses more "delicate attitude" to the Man who **WILL HAVE to TAKE THE BATH ALL THE SAME.**

Whoever you ask will give you a sensible answer that he likes either cats, or dogs, or both. And all this love is cultivated in childhood. It would be useful to remind the adults about it. Cats are very smart and clean animals. They constantly clean and lick their fur. The main "profession" of the cat is a hunter and a guard. It is estimated that one cat hunting mice, saves up to 10 tons of grain. THE cat's behavior **can tell you the weather forecast.** They **predict earthquakes, volcanic eruption.** She-cats **show sensitive attitude towards their sick owners**, warming them with their bodies. And the people are getting well sooner. In addition, contemporary she-cats **perform in the circus**, Yuri Kuklachev's theatre, in the movies. A hunter and a guard, a weather forecaster and a healer, an actress and a friend, a toy, even alive "**alarm clock**" – **that's what** your cat can be.

A lot can be said about dogs. Now on the Earth you can hardly find a place where alongside the man there would not be a dog. It helps people in everything: guard the border, and find the footprint of criminals, accompany the blind, and locate people under the snow slip, and in shepherding, and guarding the house. But first of all, any dog, even the smallest, is a loyal and

unselfish friend that never leaves you whether you are in happiness or misfortune.

You might be skeptical about this, but then you **do not have to** strive for the **Bath**. You can live your life without taking **the Bath** and "washing" in the shower. As N. Levashov used to say: *"everyone has the right to have a choice"*.

2.3. Can they spy and bite in the bath taking process...

So what is a bacterium, and can it be "touched"? The bacterium is a **CLOSED BIOLOGICAL STRUCTURE** with the performance of all necessary vital functions. Unlike higher mammals, the cells of the brain, liver, spleen, intestine in the bacterium are combined into one system, the ionic part of which can be examined in a microscope. The compact arrangement of cells and the existence independent of outer conditions allows the bacterium to occupy an appropriate place as the administrator of the bath taking process.

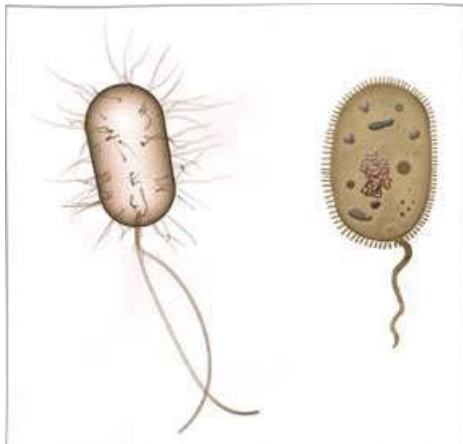

The bacterium does not need to consider, for example, the function of the liver in Man as something unique, – having at hand its own cells that perform the role of the liver, you can always give the relevant executors the necessary instructions for changing the structure of the liver on the basis of the standard. Unfortunately, bacteria can not walk on their own, so coordination of movements is not their function. However, being constantly in close contact with biostructures, they are able to observe the forms of their movement and the most suitable (from their point of view) to form for Man. In the same direction, **"Svetl" Programs** "works", if this balance is broken for some reason.

The outer ionic structure of the bacterium is designed to examine it in a microscope, but the main thing here is who looks at whom, because **THE FORM OF THE BACTERIUM EXISTENCE is NEUTRINO**, and this form, as it is known, is not destroyed. That is, removing the ionic part of the

bacterium, you are sort of changing its shirt. The bacterium changes, taking a more attractive look.

It is known that when bacterium finds itself in the wrong environment, it causes pain, and the skin receptors react to it. But the pain can not be due to the fact that such a tiny ionic being settled down on epithelial cells. This creature, first of all, sniffs the mattress, tries it with its teeth (the teeth are in neutrino space), and if everything is normal, then it settles down on it. By the way, the bacteria teeth are not like shark's, in two rows, but symmetrically on both sides, so whatever way you turn a bacterium, you will come across an open mouth with teeth.

2.4. Annihilation of a living cell

I will expound with humor, in the manner of A. Khatybov. He believed that with humor, the process of cognition is more intensive, and knowledge is fixed for a longer period. The specificity of this material and its urgency require immediate explanatory text, which allows understanding where the living cells disappear when in the **Bath**. It is known that, after yielding to persuasions of the convincing propaganda material presented by the relevant structures, the "King of Nature" (not yet a Man) falls into the ideal conditions of the operating room, where, under the purring, the properties of his Brain are changed and, in accordance with his new tasks, – structures of the living cells, as well (in order to become a Human).

Not all "Kings of Nature" normally take this process, so sometimes you have to disassemble them into separate parts (up to atoms), then to re-assemble it according to the **INSTRUCTIONS** attached in the dressing room. But unfortunately, in most of today's "Kings of Nature", there is no use whether you disassemble or reassemble them. "SvetL" Programs in such cases give a chance, but they are not a universal panacea.

2.5. Non-sluggishly going processes

Here we consider the organization of explosive processes, that is, the transformation of ionic structures in a short time. Such processes should not be attributed to moving the wallet with finances from your own pocket to someone else's, as well as the influence of intermediaries.

In the collision of two oncoming trains, the explosion does not take place, because the switchman is to blame, and if an apple falls on the head, the brain is not deformed, since the air plays the role of an intermediary here. At the same time, when two halves of a brick are joined (for example, assembled from ionic structures alone), there occurs an atomic explosion, since the intermediary, by its absence, makes these halves unite to form a new structure. Outwardly it looks like an atomic explosion, but if you look at it with the eyes of a cat, you can see **ANOTHER FORM OF MATTER EXISTENCE**.

Not sluggishly going processes – these are the processes in which the time of their passing is commensurate with the wavelengths involved in this process.

With the passing of non-sluggishly going processes, there are **3 different forms**:

1. ***Addition of counter waves, or annihilation.*** It is this process that is the main one in the bathing of the "King of nature" in the **Bath**.

2. ***Subtraction of counter propagating waves, or superposition.*** This process is described in the monograph "Cold Nuclear Synthesis" by A. Khatybov and is currently unpublished. I note that the process of soaping has nothing to do with it.

3. ***Mirror conversion of counter propagating waves, or normalization*** (the direction of the potential motion is normal to the cross section of the wave). In the bath-taking process, it is the return of a part of the Brain inadvertently withdrawn during the replacement function, if it is appropriate.

Mirror transformation of the wave is also found in nature, for example, a sunny bunny, whose appearance resembles the Sun, but if you place a direct sunray and a sunny bunny nearby, you can even see the difference with the naked eye, so with mirror transformation of waves in a bath-taking process, **IT IS NECESSARY TO OBSERVE THE FULL IDENTITY** of the removed and newly inserted "material".

2.6. Annihilation as the basis of the bath-taking process

Let's remember what parameters should be used to safely carry out the bath process. It has already been said about these parameters. These include: **the pH value** (the negative logarithm of the hydrogen ions concentration in the solution), the initial and final octave undergoing changes, the Diogenes barrel in which the intermediate result hides, the Archimedes spiral as the standard for the output shape, the stereometric structures of the input and output forms, the web quality in the corners of the **Baths**; the type of soap and its properties, the current albedo value, the number of cyclic sequences of the input and output forms, the wave node phase, the potential integral value according to the parameters of temperature, humidity and pressure created by the above parameters. All this must be collected, placed and fixed in a short period of time. And there must also be well-developed instructions for this process.

In the bath taking process, in addition to annihilation, there is also a superposition case, when not following the instructions, not only soap and a washcloth disappear, but also **THE SUBJECT TO BE WASHED**. And the process of disappearing takes place **WITHOUT ANY NOISE** and does not cause **ANY HARM** to the **Bathhouse**.

An example of annihilation is an atomic explosion, when packed in an atomic bomb the parameters of the Archimedes' spiral, Diogenes' barrel with the minimal cyclic sequence at the maximum albedo are wrapped in a spider web and are ejected, for example, through the window. In this case, the web unfolds and creates conditions in which annihilation takes place. In outer space there is no web, and there can not be atomic explosions. **THIS IS IMPORTANT**.

For a detailed analysis of the parameters, it is necessary to reduce them to a table, to which further explanations can be given. In this table, the ordinal number in the vertical line corresponds to the ordinal number horizontally (for example, pH-No.1 vertically and No. 1 horizontally). Dependent relationships are indicated, explanations are given below, the ratios are given horizontally, that is, the vertical line is secondary.

Relationship table

1 – pH;	10 – current albedo value;
2 – the initial octave;	11 – number of cyclic sequences of the input form;
3 – the final octave;	

- | | |
|--------------------------------------|---|
| 4 – Diogenes' barrel; | 12 – number of cyclic sequences of the |
| 5 – Archimedes' spiral; | output form; |
| 6 – stereometric structure of the | 13 – wave node phase; |
| input form; | 14 – integral value of the potential in terms |
| 7 – stereometric structure of the | of parameters of temperature, humidity and |
| output form; | pressure. |
| 8 – quality of the web; | |
| 9 – type of soap and its properties; | |

	1	2	3	4	5	6	7	8	9	10	11	12	13	14
1	1	1	1	1	1	1	1		1	1	1	1		1
2			1			1	1	1		1	1	1	1	1
3	1			1	1		1	1	1	1		1	1	1
4		1	1		1	1	1	1	1				1	1
5				1									1	1
6							1				1	1		
7											1	1		
8	1		1	1					1				1	
9			1	1			1			1			1	
10	1							1						1
11						1			1				1	
12							1							
13	1		1				1							
14								1						

The maximum influence on all parameters is made by the **pH** value. And until the pH corresponding to the effect of the catalyst is reached, neither the initial nor the final octave can be missed. The higher the pH, the tighter is the Diogenes' barrel and the tighter is the Archimedes' spiral; at certain pH values, the input and output forms are organized. In accordance with the pH value, the twisting of the potential is selected, and the current albedo value also depends on this.

Not a tabular setting of the pH leads to a sharp reduction in the number of cyclic transformations of the potential or to AIDS in both the input and output forms.

The main value is the influence on the integral index, and the higher the pH, the higher the potential value. So, at pH = 7.2 the value of the potential = 1, and at pH = 8.8 the value of the potential = 8. The effects of the initial and final octaves are understandable without explanation, for Diogenes' barrel – the tighter the barrel, the smaller is the angle of the spiral and the higher is the octave.

Archimedes' spiral is the main influence on the wave node phase. Quantization of the phase is achieved only at certain angles of the Archimedes' spiral. At the angle of the spiral < 21° the phase = 0, at 32° the phase = 54, at 44° phase = 72 and at 128° the phase = 128. The quality of the

web, or grating, in which the change takes place, affects the pH value, the twist potential and the phase. The more links a web grating node has, the smaller the pH, the more initial numbers can be converted into finite ones, the greater the angle of potential twist and the higher the phase.

The soap also has the pH, and the higher the pH, the more the phase changes. The current value of the albedo is of no importance, except that it affects a minor phase correction. This correction can be improved by changing the pH value in the web. If it is required to transform the longitudinal muscle of the back into a bone, then this can be done only by changing the form itself, selecting the appropriate soap (outer dependence); due to the internal reserves of the muscle itself, the effect will not be obtained, but when the final form is obtained, its mutation occurs only due to changes in appearance, when the look determines the distribution of the remaining parameters (squeezed into the corresponding form). Especially valuable is the so-called **"laundry" soap 72-76%**.

The integral potential value of the outer environment does not affect the octave transformation, but only affects the ratio of grating parameters (the web) in which the process of transformations takes place.

Thus, having formed the initial parameters in line with the type of the transport task, one can get a lot of options for achieving the goal, that is, to form the output octave, while removing all that hinders. **This process is called annihilation** – at the entrance there is everything that is necessary, but at the output everything can be seen only **BY CHANGING THE PARAMETERS OF THE OBSERVATION DEVICES**.

In this section we consider only the dependences that affect the living cell during its transformation, and, as can be seen from the table, the main influence is made by the grating, the change in the properties of which can lead, among other things, to annihilation. Surrounded by a soap solution, squeezed in the grip of standard grating parameters, the living cell has to find resources for its own transformations if the web properties are sufficient for such transformations.

In the Siberian Branch of the Academy of Sciences, a unique experiment was conducted, the results of which are of undoubted interest not only for science. The essence of the experiment was as follows. Mice (females and males) were soaped from ears to tail, and after a while the male lost their testicles (disappeared), and the females – their breasts.

The experiment caused panic in the scientific community, the results and the new problem were immediately reported to all the higher organizations (up to the United Nations). The lack of control funds due to the lack of funding prevented at the time of the experiment to make it clear when the testicles and breasts disappeared – at the time of soaping or after the mice were kept in the soap solution for more than an hour. If at the moment of soaping, then we have a direct confirmation of the process of annihilation, when only the cat can see new testicles and breasts in mice. Otherwise, we are dealing with the superposition, and such a mouse becomes "inedible". The uniqueness of the experiment is also in the fact that after wetting the mice with a towel there was no moisture left on it, that is, when annihilation due to a change in pH in conditions of the web grating presence, even water receives an octave of 45.5, and such water could not, of course, leave a trace even on a towel.

The new ionic structures formed during annihilation have nothing in common with the original structure, with the exception for the program. The increase in the octave of metabolic processes alters all kinds of metabolic processes in the cell itself, and in the case of the octave exceeding the new ion structures above the Brain octave, the cell can assume some of the functions of the Brain.

2.7. Archimedes Spiral

As already mentioned, **Archimedes' Spiral** is the main influence on the wave node phase. The formation of vortex flows, for example, air, as well as directed movement of any liquids and free-flowing bulk materials is subject to certain laws. The same laws also apply to the motion of non-inertial masses.

Let's consider Coulomb's law:

$$F = i^n * \gamma * \frac{E_1 E_2}{r^2}$$

The operator **i** determines the sign of the formula depending on the charge slip angle. The charge can only be negative, but when the specified angle is reached, it reverses the sign (not the charge itself becomes positive, but the angle sets its sign). This is especially important when calculating the directional motion of a non-inertial mass, and disregarding the charge-sign relationship does not allow creating even a model of a controlled process.

The number of rotation angles of the charge agrees with the multiplicative relation for the symmetry system, or 108 (18 axes and 6 transmissions). This was also taken into account when developing "**SvetL Programs**". But this is only in a complex space.

Entering the function $y = \sin x$, we change the coordinates and get a 36-multiplicative relation (12 axes and 3 transmissions) for the quaternion. Entering a sinusoidal function in a system of complete symmetry is a jump by an angle $\pi/2$ with the continuation of the sign system from the preceding series. However, the entering of this function is a direct dependence on the value of the number π and, as will be shown below, ignorance of this number leads to a chaotic scattering of the capacity of the potential, and not to a directed action. The random formation of a stable vortex, even for a non-inertial mass, is impossible for a period of more than 0.1 sec.

The next jump in the origin is made by exhausting the sign series of the quaternion – the transition to an octave. The jump is linear, but its value = π , for octaves we get 8 (8 symmetry axes and 1 transmission).

Thus, the complete sign system is 152 signs – one triple revolution of the vector. **NOW YOU SEE HOW IT IS ALL SIMPLE.**

The first sign of the complex expression must be the continuation of the sequence of the last sign of the octave, otherwise there will be a breakdown in sign and scattering of the potential. If this is considered regarding "**SvetL Programs**", then the potential scattering might not occur, because the last octave sign is controlled by the Brain in interaction with **the Generator through the Programs**. This could be understood and achieved only thanks to the calculations made by **A. Khatybov** in his monograph "**Cold Nuclear Synthesis.**"

The Coulomb law was not regarded as the law for the organization of a directed vortex process and was transferred to inertial masses as the basic law of "attraction" of inertial masses. Considering that the potential is not an abstract quantity, but strictly "tied" to the corresponding frequency, we get:

$$F = \sum_{j=1}^k i_j^\mu * \gamma_j * \frac{E_1 E_2}{r^2}$$

Here j is the number of frequencies for the formation of a stable vortex;

i – is the sign operator for potentials of a given frequency;

r – is the radius of the vortex;

E_1 – is the value of the potential forming the vortex;

E_2 – is the value of the counteraction potential (vortex formation environment);

γ_j – is the ionic transformation power of the vortex. The value of this quantity is described in detail in the appendix to the "Fundamentals of Celestial Mechanics", which is **NOT PUBLIC** today.

There are analogies on the use of the value γ_j , for example, in metallurgy – the Fe-C graph. This graph shows the dependence of carbon saturation at various temperatures and pressures of melting processes. A similar graph for γ_j – is a graph of the dependence γ_j -E. As seen from the graph, there are also "dead" zones, when even an increase in the potential value does not lead to a change in the value γ_j , that is, there will be no capture of ionic structures. It is these "dead" zones that the "objects" use which do not leave traces in ionic structures.

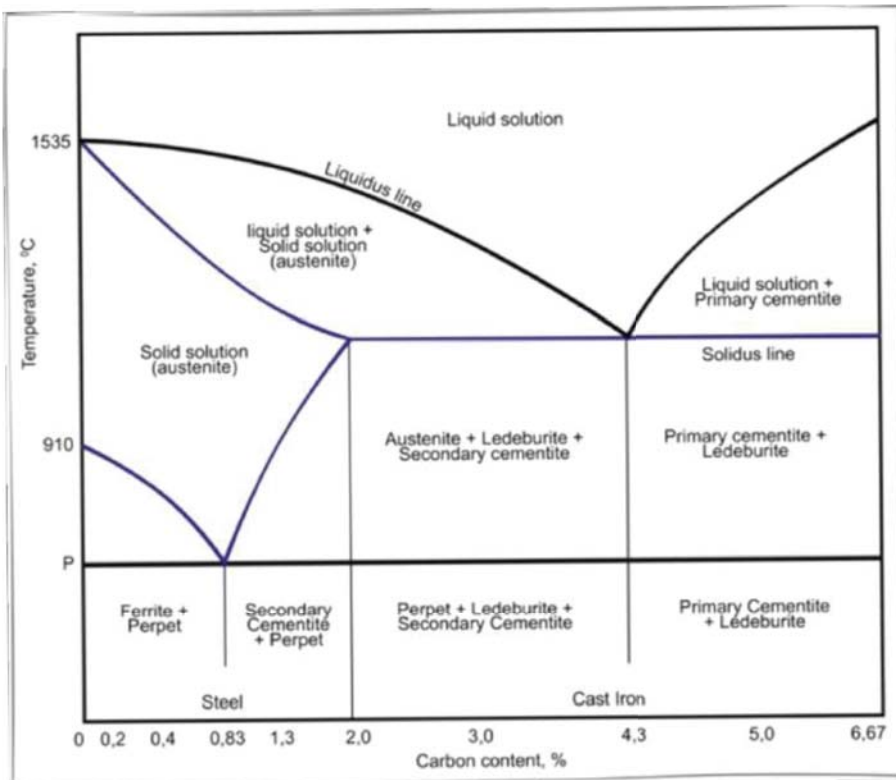

A vortex is not a set of random frequencies. All frequencies must be coordinated with the frequencies of the outer environment, and first of all, with the frequencies of the environment grating and the radiation grating. In

addition, there is a clock frequency of the vortex – 71.45454500, and all vortex frequencies fit in the clock frequency. With a successive change in the charge sign (potential), it is important that in a successive change, the complex space-

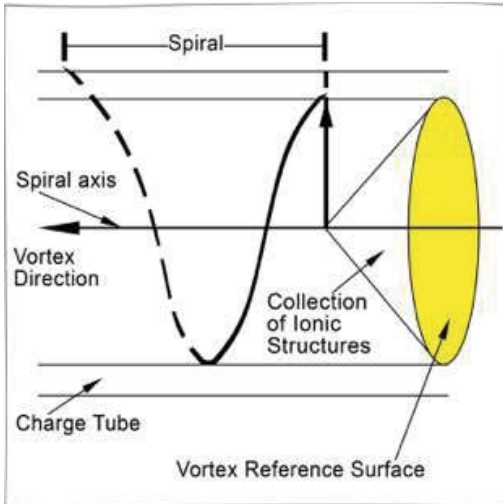

quaternion-octave-complex space, **-THE CONTINUITY OF THE TRANSFER FUNCTION SHOULD NOT BE VIOLATED**, and this depends on the values of the numbers π . Here begins the most difficult in understanding the vortex.

Actually the vortex itself is made as follows. The vortex reference surface is the surface formed by vortex lymph and having zero formation time. Relative to this surface, the vortex guide, spiral axis (clock), and the vortex ionic power are calculated.

The vortex reference surface lags behind the geometrically correct angle by a value that forms the value π of the right angle $\pi=3,14960000_{10}$. The vortex reference surface is the cone base, which apex is the base of the rotating vector.

The value of the number π of the vortex reference surface is not a random value. Since a vortex is a specific force affecting the environment without restoring it, as well as the transformation of ionic structures. The ionic structures frequencies can coincide with those specified in the vortex, and then the potentials of these frequencies are used by the reference surface to generate additional power. The dimension of the number $\pi=$ gram * cm. Decomposition of the number: $2*2*2*31*127*10^{-4}$, **t.e. $1,24*2.54 = 3,1496$.**

The spiral radius and the size of the "tube" depend on the values of the potentials.

The value of the number π of the reference surface for **the quaternion = 3.6428, for the octave = 3.88.**

The minimum number of frequencies for the formation of the vortex tube is 12 (without clock) and the inclusion of additional frequencies – by 7. The maximum permissible number of frequencies in the tube is 1174, from

the frequency range 53.5000000 in increments of 0.00001250. Rotation of the tube and its movement is associated with the value of another number π .

The vortex development and its motion are produced on the Earth, but for the ionic structures formed on the Earth, the value of the number π , has already been calculated, and this value should be used for the vortex, otherwise instead of the vortex a hemisphere with the "black hole" effect will be formed, that is with the increase in the values of gravitational potentials. And this is already fraught with an "subject" placed to the **Bath**.

The initial value (for the vortex tube formation) of the number $\pi=6,00000000$. At this value, the pitch of the outer spiral of the vortex is approximately equal to the radius of the vector and is exactly conjugate to the reference surface. Of course, there are many for whom it is not clear, and, probably, for the first time is not perceived. But I do not want those who understand what is being said to accuse me of inaccuracy, especially when I bring the real calculations of A. Khatybov, which have been tested in practice and applied in action. The Brain is the organ that we think we are thinking with it. So that you **WOULD NOT THINK THAT WAY YOU HAVE TO STRIVE FOR TAKING THE BATH**.

2.8. Superposition as a consequence of the bath taking process

As a rule, those who consider themselves the "Kings of Nature" are used to sweating and washing with appropriate facilities provided to them by the outer environment, and despite the use of the patented (laundry) soap, amazing things come about that are not envisaged by the instruction. It is known that unlike the security service, the passive type of catalyst does not feel like watching TV, especially commercials, does not purr on the radiotelephone, does not ride in the car. In addition, this type of catalyst does not like to watch sexual orgies of the "Kings of Nature". All this is noted in the Instruction as negative that can lead to the superposition and change the course of the bath taking process.

What is **the superposition** that we talk about so much? This is the phenomenon of decomposition into components of the potentials brought in by the soap solution under the influence of outer factors.

It is noted, as we know, that in experiments on mice their presence in the soap solution led to the disappearance of testicles (in mice male) and

breasts (in female). Unfortunately, in the description of the experiment there was no data that at the time of the experiment there was TV, radio, fan (for venting gases produced by mice), etc. switched on. If one of these took place, you could not talk about annihilation, but superposition, when the breasts and testicles **TURN INTO A GAS MEDIUM**, creating an additional **54.625625 octave** for the web.

Let's make a table of relationship of parameters for the superposition.

	1	2	3	4	5	6	7	8	9	10	11	12	13	14
1			1	1	1						1	1	1	1
2		1		1	1			1		1	1	1	1	
3	1					1	1		1		1	1		
4							1	1						
5	1	1	1						1	1	1	1	1	
6	1	1	1					1					1	1
7					1	1								1
8	1	1	1			1	1	1			1	1		1
9														1
10								1						1
11														
12														
13			1	1	1	1	1	1			1	1	1	1
14		1		1	1	1	1			1			1	1

The parameters are described in the annihilation section.

1. **The influence of pH**, as we see, is smaller than in the case of annihilation. The higher the pH, the smoother (more stable) **Diogenes' barrel**, but the shape of Archimedes' Spiral forms dents and protrusions on the barrel, against which the potential "stumbles". When looking for an output, the potential is divided into composite and assembled parts.

The composite moves further to the next obstacle, and the remainder begins to get accumulated in the pit or on the protrusion and, depending on the quality of the obstacle, forms an additional magnetic pulse in the range of **54.975975-54.125125**, not provided for in the instruction on the use of leaky barrels.

Because of this, **THE NUMBER OF CYCLIC SEQUENCES OF THE FORMS** is changed so that the output form might not wait at the given octave for the required potential and will have to bring down the octave of its existence (while in the standby mode). With each such lowering in the octave, the phase of the wave node changes (at the initial value of **45.9** it is possible to reach the value of **12.4**).

The integral value of the potential with respect to temperature, humidity and pressure is transmitted, of course, to the composite part; the

remainder independently forms this parameter, taking the necessary values from the flying past the composite potentials.

2. **The initial octave.** Leaving the soaped "Kings of Nature" in the state of bliss, the web is at risk of remaining naked. There are many reasons for this, and the first one is the state of the original octave. It is the presence of the ideal barrel (and there is nowhere to take a seat) that makes the original octave to have a better look at the "King of Nature" and seven times (the number of transformations) to **THINK ABOUT NECESSITY TO CHANGE ONE "SHIRT" FOR ANOTHER** using a dense veil of soapy solution. The initial octave flirts with the first potential it has got,



decomposing in the eyes of epithelial cells (ready for reproduction). I will not repeat what a shirt is. Everything is detailed in the **Collection of articles "Knowledge from Na_Chala."** (Knowledge from the Beginning). If, of course, the web does not catch the original octave before and take it in hand, it will not last long without attention. Flirting with potential, as a rule, takes place in a secluded place (in the pit of the barrel, and not on the hill).

After flirting, the original octave **BEGINS** to gain weight, changing the meaning of existence and increasing the spiral, as it is necessary to take care not only of itself, but also of what is left by the potential. Naturally, having changed the form, the original octave tends to immediately switch over to a new quality in the same form. After the switch over, around the original octave, not only the quality of the soap **IS CHANGED**, but also a number of other parameters.

3. **The final octave** is something like a waiting prince, who is brought in a non- kissed bride with a litter. The prince begins to rant and rave, spending the web potentials to destroy those servants who put furtively such a treasure.

4. **Diogenes' Barrel.** With different kinds of flirting the pits on the sides of the barrel deepen, and the protrusions can already cling to the web, and in this case the assembled potentials have no problems in getting the necessary qualities. You will know about the barrel in details after completing this section.

5. **About the spiral**, one can say a lot: it is crushed, and used as a pad when flirting, and the angle is changed, and the direction vector, and the stop signal indicator, and then the blame is dumped on it – because of it albedo shape has changed, and so on.

6. and 7. **The forms are understandable** – if, for example, the elephant "mixes" with the monkey, then at the end of it the monkey can burst (a joke from A. Khatybov). Therefore, there are various stop lights.

8. **The role of the web is enormous** and even more important than pH, that is, the soapy environment in which, in fact, everything takes place. From the web according to the instruction, everything that there is at its disposal is scraped off. If we consider that the web **IS LOSING MORE THAN IT HAS**, it actively intervenes in all the processes on its own, providing the necessary parameters. This is roughly about the same as giving immunodeficiency drugs to an AIDS patient (which only aggravates AIDS).

The remaining parameters do not provoke questions – their importance is insignificant, but the phase should be mentioned specifically.

The phase is a parameter that depends directly on the shape, but **THE SHAPE IS CHANGED UNDER THE PARAMETERS INFLUENCE**, and therefore the phase output value can be unpredictable, and in which phase the final (output) octave finds itself, and even with the offspring, it only remains to guess. This is approximately so: if you combine a bright future with a dark past, you will get a gray present. And this is what that is not desirable at all.

2.9. Diogenes and his Barrel

From the history of the Ancient World, it is known that **all wonders took place in Greece**, and so that these wonders should not interfere with the creative comprehension of the surrounding reality, a certain **philosopher Diogenes got into the barrel** and, without sticking out of it, began to **REGISTER EVERYTHING THAT WAS TAKING PLACE** around him without damaging the environment. A brief description of Diogenes' life (in the barrel) is given in one of the volumes of the ancient history of civilization.

Let's perform some surgical operation – pull Diogenes out of the barrel, that is, separate *the method of biomass storage from the container*.

Prefix DIO means **"two-sided"**, for example, "diorama" – a two-sided picture. By analogy, Diogenes – this is not the name of a Man, but the full **GENE**, that is, the gene that has the left and right-handed **BASES** of the lymph. Then the barrel is a **CONTAINER FOR TRASFERING THE GENE** to the right address.



Where did Diogenes come from in ancient mythology? As you know, all the Greek celebrities came into being in the **MIDDLE AGES, IN THE EPOCH OF THE GOLDEN AGE OF BOOK PRINTING**, at the same time the information exchange was activated, but the way of recording information was imperfect, and since (according to Darwin) not all had their tails fallen off (or there were not enough sticks for all), then the attempt to present the basics of genetics ended in a fairy tale. As in blood, where the transfer of a group of potentials takes place only in a container, and each container is addressed to a specific living cell, so the gene, in strictly defined conditions, moves to the Brain, creating the prerequisites for the evolutionary development of civilization as a whole.

Creation of the structure based on a proton atom

The energy characteristics of a proton atom are given in the appendix to the work **"The Fundamentals of Celestial Mechanics"** by **A. Khatybov** and in the **Collection of articles "Knowledge from Na_Chala"**. (Knowledge from the Beginning). There are also tables of

transient processes, frequencies and potentials of gravitational and electric frequencies and magnetic pulses.

The basis for the transmission of any group of potentials between adjacent atoms **IS A GRAVITATIONAL – ELECTROMAGNETIC WAVE** having a total albedo equal to zero, and morphologically shaped as a barrel.

In the coordinate grid of the Euclidean space, it can be imagined that longitudinal oscillations (a gravitational wave) of the clock frequency are propagated along the **x**-axis, to which the electric and magnetic frequencies are superposed (along the **y** and **z** axes), and according to Landau studies, the magnetic frequency (or momentum) can in some cases, be ahead of the electrical component, *but, in any case, the magnetic frequency is strictly quantized by electric.*

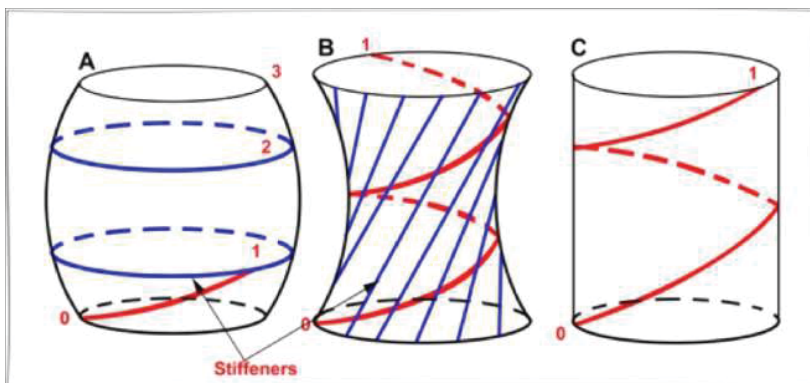

Note that the barrel is a specified form. Morphology is in the figure. **The barrel is the morphology of the bond between proton atoms.**

The barrel has two bases. One base "leans" on the outer surface of the atom, the second – on the inner (second) surface of the next atom, and this sequence extends into a spiral, forming the sequence of atoms **united by a gravitational bond**. Taking into account the bond within the atom (between the surfaces), the whole system **IN GENERAL IS A SINGLE ONE**. Note that to transfer any structure along this chain, a **O-transition** is necessary, that is, the vector albedo of the system is zero, then there will be no scattering and loss of the part of the structure. Let's consider three options of the barrel shape.

Option A. The stiffeners are transverse, formed by the limiting potential of the gravitational carrier frequency. In this case we have an interference pattern in which the discontinuities formed by the rings do not

allow the passage of the potential front both of the magnetic and electric frequencies. In addition, the absence of a guiding spiral prevents parity in the transmission of left- and right-handed structures. ***Thus, option A is used when it is necessary to scatter potentials.***

Option B. The stiffeners are longitudinal (Shukhov's construction). The grid of stiffeners allows forming both left- and right-handed spiral structures. But the spiral passed through option B shows that the potential first loses the albedo, and then increases it. With the loss of the albedo, scattering occurs, and with increasing – a set of chains, that is, in this case we can obtain an autooscillatory loop without feedback. The system built on option B can retain its internal potential for a long time, ***which allows using it to support gratings and grids of Hartman, Curie, Roentgen.***

Option C. When considering Archimedes' spiral, it was pointed out that it is possible to change the quality of the spiral **by changing the number π** . In addition, it must be borne in mind that **ANY GENE STRUCTURE** should correspond to the values of the **number π** for the Earth (when forming this structure, for example, on Mars, this value should correspond to the Mars constants). It is known that the value of **$\pi=3,1496$** is used for the minimum spiral pitch at the clock value **$\pi=6$** .

Option **C** allows using any value of both the clock and the carrier value of the number **π** , which allows this option being used **FOR TRANSFERRING ANY STRUCTURES**. The parity of the system is met automatically – "odd-even" is formed due to the support surface (more precisely – the layers of the atom), and the spiral – left or right – clocked by the gravitational frequency.

When considering Archimedes' spiral, it was pointed out that option **C** possesses one more valuable quality – a support platform that locks the potential movement in the opposite direction, and hence in an arbitrary direction. ***That is, the self-oscillating mode can not be created, so the design on the basis of option C is intended for the address transmission of any structure.***

And here is the conclusion, which is extremely interesting to us. TIME OF LIFE IS SPECIFIED BY THE OCTAVE LIMPH DEVELOPMENT for the formation of the ionic structure and **MAGNETIC PULSES** with the accurate slip angles. The relationship of time and space in a living cell is determined by the slip angle. The values of this angle, from **21.6 to 43.5, DETERMINES THE LIFE SPAN** from **0 to 32000 years**

(on Earth's time scale). The middle point corresponds to **124 years** of life. The perfect cell can be left to live for **32000 years**, but under unchanged outer conditions. ***The optimal point at 124 years corresponds to a cell approximating perfection***, but changing with the next mutation due to changes in outer conditions. All calculations made over the past year showed that with the timely and proper use and application of "**SvetL**" **Programs** this point is attainable. Note that a living cell is a multi-stage (multi-octave) structure – from **32** (ionic) to **96** (neutrino) octave. It makes no sense to compare the power capacities in different octaves – **one charge equivalent of octave 52 corresponds to approximately 10.000.000.000 charge equivalents of octave 32**, that is, the ionic structure has a minimum charge equivalent, and devices for recording charge equivalents of high octaves do not exist. The potentials of high octaves serve to maintain the gravitational frequencies of the cell's communication with the Brain. And if this **COMMUNICATION IS CONSTANT AND SUSTAINABLE**, then your taking **the Bath** was not in vain and the specified point you are sure to reach. This is written responsibly and consciously. And if this causes misunderstanding or skepticism inherent in modern science, then to these skeptics, you just want ***to come up and ask: "Is it difficult to live without Brains?"***

2.10. The Normalization

As it is known from the course of the mathematical analysis, ***the normal is the perpendicular to the line, the surface***. Thus, the normalization is the motion of the potential at an angle to the cross section of the wave. This unexpected invasion of a foreign body with conjugated properties has its own peculiarities, especially for the remnants of a soap solution and the web not removed in time. As in the case of the superposition, the whole spectrum of negative phenomena is repeated. But if native potentials participate in the superposition, so, having family ties they can be spanked; they do not do much harm, except for the one-sided development of the offspring (known in genetics and in biology as the presence of family ties). **Effects of the superposition are not observed immediately** – after a certain time, the "King of Nature's" **PANCREAS FAILS** first of all, and then depending on the sign of the charge of the composite or the assembled potential, either **diabetes mellitus or hemophilia** are developed successfully. I want to warn the reader: do not try everything on

yourself. Everything is described as it is supposed to be, if something goes wrong. But if everything goes right, and you are not forgotten to be taken to the Bath, you can use **"SvetL" Programs** or, at the worst (depending on your resources), **N. Levashov's Health Improving Sessions** (from here – <http://svetl.name/page/os>) and use them in strict accordance with the Instruction.

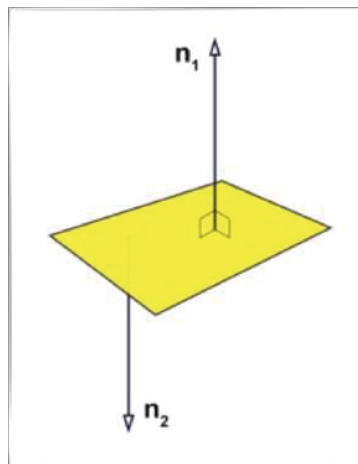

As biologists have noticed, extraneous relationships do not lead to this effect. But where can we find these potentials in the conditions of a great number of relatives and the prohibition to stick out of the window? Then a little trick comes to the rescue. The wave, tightening the knot and changing the phase (so that it is not noticed), begins to walk *next to the Diogenes barrel with the same angle of the Archimedes spiral* (so as not to get lost). This is why I am writing about the Barrel and the Spiral in detail. Normally moving potential, naturally, encounters a lonely wave, changes it all that is possible – both the filling and the current parameters. Back in its home environment, the wave, as if nothing had happened, takes a **FULL SUBSEQUENT TRANSFORMATION COURSE**, having a number of innovations in stock. These innovations can only be discovered after **12 years of the new structure existence**, when these innovations begin to get interested in their daddy. It remains only to guess what new properties can bring about, for example **23.5**. Since the wave does not care who will change its state, if only the potential is good; later it leads (especially after several generations) to the effect of automatic superposition, when any innovation ends only in the effect of decomposition. Isn't it sad? But it's better to know about it than to "guess". An increase in the angle of Archimedes' spiral due to the **INCREASE IN THE NUMBER OF CYCLICAL SHAPES** ultimately leads to the normalization of the wave itself, when any potential can create an independent joint structure, taking such a wave as the ideal option for annihilation. Since the process of annihilation must take place under the cover of the web, this is where the process of automatic superposition takes place, in which not only properties of the potential disappear, but also the web, because the normalized wave can not be in the pit of the barrel, but only on the ledge that in time becomes connected with the web. When the necessary parameters of pressure are received from the

web, the wave leaves the hillock of Diogenes barrel, thus changing its phase. Such a wave resembles a fish-sucker on a shark or a tapeworm in the intestine of the "King of Nature". To get rid of such a wave is quite difficult (even if it is detected). And is it necessary to get rid of it? This is one of the conditions for the **SUCCESS** of the **BATH TAKING PROCESS AND ITS USEFULNESS**. Here it is necessary to understand that *the Brain, well-arranged, is more valuable than the Brain, well-filled.*

If I apply everything that has been said to the practical life plane of people who I am constantly confronted with in questions and answers, explanations and clarifications on the application of **"SvetL " Programs**, then, when it comes to health improving (health), people do not trust the opinion (advice) of even their family members and friends, not to mention more distant acquaintances. It is clear that there are exceptions. But basically people give everything new a hostile reception, even if evidence of the effectiveness, as they say, is obvious (literally and figuratively). However, other people's examples, and even supremely positive results, voiced and written by the same kind of people on the scale in which it should be today, there are few to inspire. I would recommend everyone watch the series **"Doctor House"**. **Firstly**, you are finally convinced that the medical treatment that the official medicine is able to offer people is not even wandering in the darkness or making wild guesses – it is an attraction called "The Monkey and the Glasses". **Secondly, you understand that all human health problems, by and large, are created by them** – they eat the wrong, drink the wrong, they abuse anything possible, diminish the degree of the environment danger, do not hear early signals from the body, etc. Why is it so? Well, because there is no knowledge and no understanding. No one should be offended. This is the reality of today, which began its existence at least two thousand years ago.

Nothing happens "just like that". Everything is always interconnected and interdependent. And if you do not see the relationship between some events, it might turn out that you are just blind, but not because in reality there is no such connection. I am satisfied that Knowledge, acquired with experience, often can not come in handy for conscious use; they rather serve as a reflex to changing circumstances. Everything that happened before and is going to happen in the future, by current science and, naturally, by those who represent this science, **CANNOT BE EXPLAINED**, since the platform of materialistic world perception does not allow this, and the next stage in acquiring knowledge of the truth on the basis of materialistic idealism is only beginning.

And exactly for this I write, without fear of "experts" condemnation. When I am writing this, there is no making head or tail of the weather all over the country, for example, and this is in the month of June, 2017. The explanation is one – a sharp warming of the climate. But in Tatarstan at a plus temperature snow had fallen, and not only in Tatarstan. And all around cold snap has set in with the stories about warming. How often, willingly or unwillingly, by contrasting their own points of view, their hypotheses, their theories to others, they, these "experts" forget that the time will come when the indisputable truths will be replaced by others – **IT IS NOT IN THE DISPUTES** where **THE TRUTH IS BORN**. I am writing this for those who, supported with the spade, will grab the broom and run to take the **Bath**, and whether they are invited or not – is secondary. The main thing is to have a desire to run.

Chapter 3. Theory and practice in the description of the Object to be taken to the Bath

There are no secrets at all. Another matter is that there are things people have no idea of, and there are things about which a few initiated are not disposed to tell others.

The mankind has a starting point – *"as soon as an ape grabbed a stick, it began to "think"'* (perhaps at that time there came into being the theory of relativity). But you may think otherwise. You can think, but still remain an ape. As an example: the influence of gravity on the development of science is described in sufficient detail, but there are "experts" who tell everyone what **N. Levashov** thought of "the influence of this very gravity". It is clear to have a desire to contribute to the understanding of this process; it is not clear why the "experts" make a start from the well-known truth that the apple fallen on Newton's head brought to the discovery of laws. If Newton had been sitting next to the house under construction, then a falling brick on his head would have led to much more important discoveries. And there is a desire to give an advice to these "writers" before starting to write, let him sit next to the house under construction. As science proves, the gravitational effect on the Brain always results in something. The brain is not always necessary to be present – there are cases when pulling the nail out of the head do no bring to the brain damage (even if it there). This is about gravity; we will soon dwell on it in detail, but so far – back to the object, which should be taken to the **Bath**.

Well, then how to move forward? Where is that point from which one can make a start to knowledge, and what remains then – to believe in nothing or try to figure it out by removing all the rubbish accumulated by modern science and "experts" who write so-called "studies" on the basis of N. Levashov's knowledge in the absence of their own. If you want to know something, to comprehend and apply to life – reading **N. Levashov's** books (whoever and whatever say even with the "foam at their mouth") is not sufficient. This is only the point and the basis from which one should and have **TO MAKE A START IN ORDER TO**

GO FORWARD using the "**Spade of knowledge**". One horse can not pull two carts in parallel with one shaft. Everyone can be convinced of this. It means:

- **firstly**, those who want to know something, should forget everything they were taught;
- **secondly**, whatever conclusions might be, they can always be comprehended;
- **thirdly**, the belief and desire to gain knowledge which is always rewarded with the level of knowledge that is attainable for a particular person. Unfortunately, today – for a specific genotype. And only **Programs "SvetL"**, are able "to correct" it and ensure to "**be taken to**" the **Bath** (of course, with one's own desire);
- **Fourthly**, no convictions can prevent you from checking the result, which means that you **CAN BE KNOWLEDGABLE NOT ONLY IN ONE FIELD**. You can specialize in one or more fields of knowledge, but you have to know more.

Taking into account the introductory nature of this chapter, and the need to take the Bath, it is most desirable, on the basis of **N. Levashov's** books and **A. Khatybov's works**, to understand that:

1. **The construction of all atomic formations follows the pattern: highly organized plasma → material body → liquid → gas**, that is, a sequence of octaves ((128) → (126-74) → (72-66)) → (64) → (62-34) → (32-28) → (24–26) → (22-16). Octave 64 is a **MATERIAL FORMATION**. The atomic formation is a kind of pyramid (not in form, but in content). The top of the pyramid is octave 128 (atomic formations of all living beings, from octave 128 to 16). All the rest are built without tact, but the octaves are 84→16.
2. **There are no particles without a charge** – just there are no devices for measuring the charge or there is no medium for its manifestation.
3. There are no and can not be devices in the medium of octave 64 to measure the characteristics of formations in octaves 128-66.
4. **All the atomic formations are interconnected** – each formation is inside a certain grating.
5. **The brain (formations of octaves 66-72) is formed in the form of honeycombs.**

6. **All calculations in atomic formations** are made only using fractals of the golden section in the 12th number system.

7. **The atomic formation can not have a rigid framework.** The size of the atomic formation can vary within (+/-)24%. The hydro meteorological center, like the church, is a parasitic structure – without knowing the meaning and physics of what they were created for, they pull the housewives' legs with cyclones and anticyclones, which the wind brings, and *"...the wind is blowing because the trees are swinging..."*

8. **No biostructure can have information without the System.** You can "pass" by the information, because there is no command to pay attention to it. No outer influence can directly or indirectly cause the biostructure to work in another information field, as this will just result in the biostructure's destruction. In addition, even if the System itself provides information to the biostructure, this does not mean that the information has been fully brought to. Distortions are possible, but it makes the System repeatedly duplicate information. It was realized this way in the Old Control System, the same takes place today, although the information intensity is much greater.

9. **Biofield is the main argument of biologists and doctors** in explaining the causes of diseases. It is especially advertised in radio programs. *This is one of the vertices of obscurantism.* But if to you think as the most people do, then biology very accurately shows that the reproduction of man is a mechanical process (as in the production of fire with the help of a stone and a stick), and due to friction, a desire arises to reproduce a complete similarity to oneself.

3.1. Is current necessary to "move" to the Bath?

Using the numerous fruits of scientific and technological progress that literally reached every housewife and child, the overwhelming majority of mankind, like many centuries ago, is in deep cavemen ignorance, although, recently, it has become apparent that some of them start to crawl out of the caves. And if **THE IGNORANCE OF OUR** naïve ancestors **WAS FRUITFUL**, for it was the ignorance of a child perceiving the world around him, the ignorance of the modern philistine who has buried himself in TV

screens, computer monitors, does not contain anything but a narcotic desire to escape the "boredom of life». It does not enter any head to ask a question about how their mobile phone works. And it seems to be an interesting question. Well, really, a curious thing, you can hear a person on your mobile phone being on the other side of the globe, better than a friend from your home town on an ordinary phone!

In order to plug the socket, switch the kitchen electric cooker from **3** to **5**, repair the faulty wire or press the button of the mobile phone, **THERE IS NO NEED TO KNOW THE LAWS OF NATURE**. It is enough to have *the first signal system*, which, according to the teachings of Academician Pavlov, is inherent in both animals and humans. *The second one* which indicates the presence of consciousness is no longer required for this. Apparently, for this reason, if you ask an educated lady, for example, whether she knows **Ohm's law**, she will answer: "What is it and what is it eaten with?" – even with some sense of superiority. And it is unlikely that she and many others today will answer this question. And the fact that the basis for considering Ohm's law is the **MATERIALISTIC IDEAS OF THE WORLD AROUND US** is known to **VERY FEW** and mostly to *those who are anxious of to take the Bath*. They begin to guess that the laws of material particles motion, micro and macro objects are transferred to electric circuits and ways of moving electric charges. As with the movement of a cart, missile and other material body, electricity is represented as one of the *properties of the material mass transfer*. The basis for this transference is the medium that resists when an electric mass is trying to force through it. The basic concepts of interaction of the medium and the charge are as follows:

1. **The voltage is electric.** The term "electric voltage » in 1827 was introduced by D. Ohm¹⁴.

¹⁴ Georg Simon Ohm (March 16, 1787 Erlangen – July 6, 1854, Munich) – German physicist. He derived theoretically and confirmed experimentally the law expressing the connection between the strength of the current in the circuit, the voltage and the resistance (known as Ohm's law). His name is given to the electrical resistance unit (Om).

An analog of the pressure drop between two points of the circuit **Ohm** called the voltage.

In a general case, the electric voltage is the **work** on motion of a single electric charge, determined by the integral of the effective electric field E_3 (including the outer fields) along a given contour γ , connecting two points (1, 2) of the current circuit or other electrodynamic system:

$$u_{12}[\gamma] = \int_{\gamma} E_3 dl$$

Voltage is measured in volts ($1 \text{ v} = 1 \text{ j/A}^*\text{sec}$), in units of GSE – at $\frac{\sqrt{\Gamma \cdot \text{cm}}}{\text{сек}}$. ($1 \text{ GSE} = 300 \text{ v}$). The designation in the GSE is closer, since it affects horsepower problems according to dimension. Further explanations for those going to take the Bath, I will give in the italicized text in brackets with two **, so if something – this could be ignored. But then they will be taken not to the Bath, but some other place, more attractive one – for example, to the Zoo.



*(**...However, voltage is precisely work (by definition), and work is measured in horsepower. 1 horsepower = 746 watts (American horse) u 745.7 watts (English Horse). Just as with the movement of a cart pulled by a horse, to calculate the work on the of the charge movement, it is necessary to indicate the path (contour)).*

The contribution to the electrical voltage of non-potential fields (vortex and extraneous) is usually attributed to *electromotive force* $\varepsilon[\gamma]$:

$$U_{12}[\gamma] = \varphi_1 - \varphi_2 + \varepsilon[\gamma].$$

In practice, however, instead of accurately indicating the integration contour γ usually use explanatory words (***selected from the lexicon of builders or from the dictionary of taboo vocabulary – Moscow, 1993 г. – contains about 10,000 words and expressions*). In addition, when no suitable expression is found in the dictionary, another definition of the electrical voltage is used: Electrical voltage U is defined as the ratio of the work performed per unit time over the electric current I , to the current:

$$U = \int_v \langle e \cdot i \rangle dV/I$$

Here e – the intensity of the microscopic electric field, i – density of micro currents, integration is performed along the conductor contour V , $\langle \rangle$ – fast averaging sign. (****Since the current is being violated with the use of fast movements, the form of this violence can already be selected from the taboo vocabulary****). $\langle e \rangle = E$, $\langle i \rangle = j$, but in the general case $\langle ej \rangle \neq E_j$, so, in moving with speed v conductors (****see the taboo dictionary, for example, pencil****) $\langle ej \rangle = E_0 \cdot j = E \cdot j + j \cdot [v \cdot B]/c$ B – magnetic induction.

The voltage drop determined in this way satisfies Ohm's law in integral form:

$$U = R \cdot I, \text{ where } R \text{ – resistance of the chain section.}$$

2. Current. Current is the density of electric charge, measured in Amperes. Ampere is a unit of electric current strength equal to the force of an unchangeable current, which when passing through two parallel conductors of infinite length and negligible (****not thinner than pencil****), the area of a circular cross-section, located in a vacuum at a distance of 1 meter (****see translation into bast shoe****) from each other, would cause on each section of 1 meter length the interaction force equal to $2 \cdot 10^{-7}$ H. Ampere is also a unit of magnetomotive force along a closed contour linked to a DC circuit by force 1 A.

The Power of Ampere: $f = \frac{[j \cdot B]}{c}$, where c – light speed in vacuum.

$j = \rho \cdot v$ (v – speed, ρ – bulk charge density).

The power of Ampere is known as the Lorentz force.

The charge density is always > 1 .

Sometimes the Ampere law is the integral relation

$$\oint_C \vec{H} \cdot d\vec{l} = 4\pi \cdot I/c$$

Integral – along the contour. I – the total current flowing through a surface bounded by a closed space C .

This relation is analogous to the Gauss theorem in electrostatics. c is the speed of light in vacuum.

*(**From the calculations of systems in motion, the number π varies depending on the contour of the spiral, but in all electrodynamic formulas this number is always equal to 3.14259..., i.e. movement is not in a spiral, but in a circle, and the charge does not move anywhere).*

3. Resistance. Resistance to violence is different. In electrodynamics, only the resistance overcome by the current is accepted. This resistance depends on the material of the conductor, its dimensions and shape, that is, the corresponding ionic structure.

For each material (ionic structure), the coefficient R is experimentally chosen, which takes into account all the features of the medium in which the current moves.

4. Ohm's law. Using mechanics and **horse science (horsepower)**, we arrive at the differential form of Ohm's law (the integral is given above): $\mathbf{j} = \sigma \cdot \mathbf{E}$, where σ – coefficient of proportionality, or electrical conductivity.

The Ohm law in integral form can be obtained from this expression if we integrate this relation in volume (*** see the lexicon of builders*). Coefficients R and σ are related by: $R = l/S\sigma$, Where l – length of conductor, S – cross-sectional area.

*(**In this case, the shape of the conductor is hidden under electrical conductivity, so as not to infringe on the horse's rights).* Linear relationship between \mathbf{j} and \mathbf{E} in the conductor is due to a linear dependence of the (***effective friction force*), acting on the charge carriers, on their speed.

Microscopic determination of current density $\mathbf{j} = \sum e \cdot \mathbf{v}$, where e – charge of a carrier, and \mathbf{v} – its speed (the summation is over all charge carriers that are in the unit volume of the conductor).

If, during the motion of the charge carrier, a friction force acts on it, linearly dependent on the velocity (as is the case for liquid friction), then $\mathbf{v} = \alpha e \mathbf{E}$, and, consequently, $\sigma = \sum \alpha e^2$, Where α – coefficient of mobility of electric charge (***depends on its mood*). In the conductor there may be forces of not electrical origin and external forces. When the conductor moves

(see the lexicon of builders)** at a speed less than the speed of light, a dependence is derived for the relativistic generalization of Ohm's law with respect to charge density in the observer's system.

5. The generalized Ohm's law, or Ohm's law for plasma. As follows from modern physics, plasma is the 4th state of matter. **(**That is if the conductor is gradually warmed up, it will break up into its component parts, and Ohm's law reduces to a sequential walk around these components).**

The generalized Ohm's law is a linear dependence for plasma between the current density \mathbf{j} and the strength of the effective electric field \mathbf{E}_{eff} , which includes **volumetric forces of non-electrical origin** that cause current. The generalized Ohm's law is written in differential form.

For a fully ionized two-component plasma in a magnetic field \mathbf{H} , the basic Ohm's law has the form:

$$\frac{j_{\parallel}}{\sigma_{\parallel}} + \frac{j}{\sigma} = E' - \frac{\nabla p_j}{en} - \frac{R}{e} \equiv E_{\text{eff}}$$

Where $\sigma_{\parallel} = e^2 n / m_e \nu_{ei}$ – longitudinal conductivity of plasma,

$\sigma = e^2 n / 0,51 m_e \nu_{ei}$ – transverse plasma conductivity,

m_e – electron mass,

ν_{ei} – frequency of its collisions with an ion,

$E' = E - [\mathbf{uH}]/c$ – The electric field in the intrinsic plasma system moving with velocity $\mathbf{u} \ll c$.

p_j – ion pressure,

n – plasma concentration,

R – thermosil due to the gradient of the plasma temperature T :

$$R = 0,71 \nabla_{\parallel} T + \frac{3 \nu_{ei} m_e c}{2 e H^2} [H \nabla T].$$

(Thermosil – apparently, the effect of the falling of a hot brick on the head, and the collision of electrons with ions is the collapse of mass, is described in sufficient detail by D. Swift¹⁵).** In

¹⁵ Jonathan Swift- "Gulliver's Travels “

frequently occurring situations, when the gradients and temperatures of the plasma have the same direction perpendicular to the magnetic field \mathbf{H} , electric field \mathbf{E}' is naturally divided into three components E_{\parallel} , E'_1 , E'_2 (*****Existing on their own***). In this case, the "longitudinal" and "transverse" Ohm's laws are distinguished:

$$j_{\parallel} = \sigma_{\parallel} E_{\parallel}, j = \sigma (E'_1 - \frac{3v_{ei}m_e c}{2e^2 H^2} [H \nabla T]),$$

and the ion pressure gradient is held by **the Hall field**. $E'_2 = \nabla p_i / en$. In a slightly ionized plasma, an additional contribution to the current density is given by the **frictional force** between the charged components and the neutral component. In the ionospheric plasma, the calculation of LF processes takes into account also the contribution of **gravity**.

For a three-component plasma (***electrons, one type of ions and one sort of neutral***), neglecting the transverse and longitudinal conductivities and the thermosil (*****likewise in material resistance – if the beam of high-strength steel does not withstand the load when calculating, we replace it with a wooden one***). The fundamental Ohm's law is written down:

$$\frac{m_e v_e}{e^2 n_e} j + \frac{m_e \partial j}{e^2 n_e \partial t} = E' - \frac{\nabla p_i}{en_e} + \frac{m_i}{en_e} g + \frac{m_e}{e} (v_{en} - v_{in})(u - u_n),$$

Where \mathbf{g} – acceleration of gravity,

\mathbf{U}_n – the velocity of the neutral component,

$\mathbf{v}_{en}, \mathbf{v}_{in}$ – the collision frequency with neutrals, respectively, of electrons and ions (*****to create a mass-collapse effect***),

$\mathbf{v}_e = \mathbf{v}_{en} + \mathbf{v}_{ei} + m_e \mathbf{v}_{in} / m_i$ – the total frequency of electron collisions, which determines the time of transfer of their momentum to heavy particles $\tau_e = 1/v_e$.

(***** From the instruction on the destruction of cockroaches: ... to catch a cockroach, pour a powder in its mouth, hold its jaw so that it does not spit it and wait for 3 hours without releasing the cockroach from your hands until it stops breathing ...- similarly, Ohm's law for plasma***). Proceeding from the above, we determine the potential, or that value of the charge (*****after collisions of electrons, ions, neutrals and other debris, usually filling the plasma – after the successive transformation of metal-liquid-gas-plasma***).

3.2. Work on "moving" towards the Bath.

Potentials and their varieties

For clarification let's turn to Alexander Khatybov's favorite company – "Pi ...» («Pi.ts International»). Potentials can be different. There is a group of charges at different frequencies (or octaves), their sum is measured in low octaves (*to measure high octaves the devices have not yet been invented*, but **THIS DOES NOT MEAN THAT THERE ARE NO CHARGES**). Each charge has its own characteristics (density, structure of the shirt – compatible or not compatible with the outer environment). If the charge shirt is compatible with the outer environment, Ohm's law is useless – there is no resistance in the motion environment. If the shirt is not compatible, then the motion of the charge in another environment is accompanied by the potential loss, and the charge moves through the channel with the least resistance, while losing its properties. This phenomenon is called **work** (warming up someone else's environment thanks to the charge motion).

If the shirt is removed from the charge, it will move as a non-inertial mass without resistance but with instantaneous scattering.

Ohm's Law describes the properties of crowd movement without taking into account the rules of the traffic.

The group of charges **ALWAYS MOVES ON THE STRUCTURES OF THE CUBIC GRATING**. If the grating (path of motion) is not cubic (maybe monoclinic), then a certain potential is also spent on its alignment. It is known that different conductors have different resistance. The smallest are gold, silver (cubic gratings). At the same time, work on displacement is carried out to overcome the resistance of the environment. In other conductors, work is added to change the properties of the structure. Thus, in Ohm's law (averaged) it is necessary to have a standard (a conductor with a cubic grating) and an appendage for other conductors. In order to understand the operation of Ohm's law, we will analyze what a single charge is, without which one of the main components of an electrical circuit (without forces of non-electrical origin) is impossible. Let us imagine a proton atom with two outer surfaces of the condenser type. The outer and inner surfaces have potential. A few words about the potential.

Firstly, a potential is something that is not visible.

Secondly, it is not known where it is located and where on the way to the head the brick gets this potential on the way to the head.

Thirdly, how many potentials exist?

Fourthly, what is larger – potential or current.

And so on; therefore, we give one of the forms of existence of a potential, **consistent** with the above Ohm's laws:

a) **Potential** is a property of a non-breaking surface of minimal area at a given gravitational frequency.

b) **Potential** (electrical) is the normal to the magnetic line of the atom.

c) **Potential** is the limiting value for the angle of slip, the coupling frequency, the angle of the helix for a given number π and other normal to the magnetic field line of the atom constituent, forming the surface of the atom.

d) **Potential** is the collapse of the material mass, isolated in the form of a plasma and collected by the gravitational attraction of an atom.

THE POTENTIALS OF TWO SURFACES OF A PROTON ATOM DO NOT INTERSECT in the direction of the vector transformation, they have different signs relative to the mean point of the slip angle, the direction vectors of the force action have different signs. All other comments on the Ohm law can be found in **A. Khatybov's work "The Cold Nuclear Synthesis"**, which can be found (sorry for tautology) only after taking the Bath.

3.3. The theory of space for practice in the Bath and a little about the Moon ... (from the fundamentals of celestial mechanics)

Space metric

It is known that the atomic clock placed on the top of a skyscraper and in its basement, shows different time. Any space is connected with time, and when setting the distance and trajectory it is necessary to see not only the final destination, but also the peculiarities of overcoming this path under the

conditions of changing fundamental constants. All aspects related to time will be given in the "time metric".

The purpose of this section is to determine the actual values of some fundamental constants, which are indispensable for those who are striving for the **Bath** – for example, parsec. In addition, taking into account the **SPECIFIC ROLE OF THE MOON IN THE Earth LIFE SUPPORT SYSTEM**, we will clarify some concepts that remain beyond the scope of scientific research, for example, libration¹⁶ of the Moon, when not 50% of the surface of the Moon is seen from the Earth, but 59%. We also note the spatial orientation of the Earth.

All this will become necessary so as not to get lost when looking for the way to the **Bath**, which is clearly visible in the full Moon.

The role of the Moon

The moon is a special and the least explored object of the Solar system. It has its own UFOs, the Earth lives by the lunar calendar. It is the main object of worship among Muslims. *No one has ever been on the Moon (the arrival of Americans on the Moon is a cartoon film shot on the Earth).*



SCIENCE RECOGNISES QUITE A SIGNIFICANT ROLE OF THE MOON in the life support system of the Earth. Here are some examples.

- **with the full Moon**, a partial weakening of the Earth's gravity makes plants absorb more water and microelements from the soil, so the herbs gathered at this time have a particularly strong effect;

- **the Moon, due to its proximity to the Earth, greatly influences by its gravitational field on the Earth's biosphere and brings forth some changes in the Earth's magnetic field, in particular. The rhythm of the Moon, tides and ebbs cause biosphere changes in**

¹⁶ Libration (from Latin librati – "rocking") is a slow oscillation (real or apparent) of a satellite, seen from the surface of the body around which it rotates. Without further elaboration, the word "libration" usually means the apparent vibration motion of the moon when viewed from the Earth.

night illumination, air pressure, temperature, wind action and the Earth's magnetic field, as well as water level;

- **plant growth** and yield depend on the stellar rhythm of the Moon (period 27.3 days), and the activity of animals hunting at night or in the evening – on the degree of the Moon luminosity.

- **with the Moon** on the wane the growth of plants slows down, and goes faster when the Moon grows.

- the full Moon affects the growth of crime (aggressiveness) in people.

- **the time of egg-cell maturation** in women is linked with the Moon rhythm. A woman *is inclined to produce an egg cell in that phase of the Moon, in which she was born*. During the full Moon and new Moon, the number of women with menstruation reaches 100%. When the Moon is on the wane, the number of new-born boys increases, and the number of girls decreases.

- **weddings are usually held** during the growing Moon.

- **with the Moon growing**, there sow what grows above the surface of the Earth, with the Moon on the wane – on the contrary (tubers, roots).

- **lumberjacks cut trees** with the Moon on the wane, since tree contains less moisture this time and is not subject to rotting longer.

- **at full Moon and new Moon** there is a tendency to decrease uric acid in blood, the 4th day after the new Moon is the lowest.

- **vaccinations** at full Moon are doomed to failure.

- **at full Moon** pulmonary diseases, whooping cough, allergies get worse.

- **color vision** in humans is subject to lunar periodicity.

- **at full Moon** activity increases, with the new Moon – decreases.

- **the haircut** is accepted to have at full Moon.

- **easter** is the first Sunday after the vernal equinox, the first day of the full Moon.

There are hundreds of such examples, but the fact that the Moon **ESSENTIALLY INFLUENCES ALL ASPECTS OF LIFE** on the Earth can be seen from the above examples. It is important for us to begin to understand what is happening to us today and the main thing – why this is so.

What do we know about the Moon? This is what is given in the tables for the solar system. It is also known that the Moon does not "lie" in the plane of the Earth's orbit:

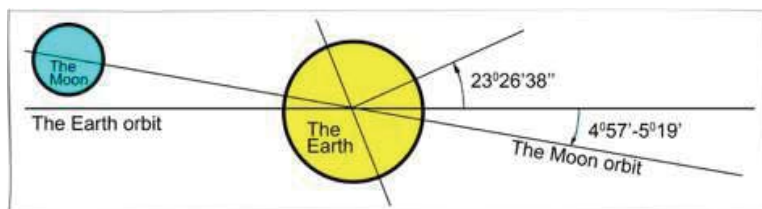

More precise values of the angles are given in this chapter. The actual purpose of the Moon, the features of its structure and its function are also given, because it makes sense, and then there arise questions about time and space – how much everything is coordinated with the actual state of the Earth as an integral part of the Solar System.

Let's consider the state of the main astronomical unit – parsec on the basis of the data available to modern science.

Astronomical unit of measurement

For 1 year, the Earth, moving in Kepler orbit returns to the starting point. The eccentricity of the Earth's orbit – apogee and perihelion are known. Based on the exact value of the Earth's velocity (29.765 km / s), the distance to the Sun is determined.

$29.765 \cdot 365.25 \cdot 24 \cdot 3600 = 939311964$ km – this is the length of the way for the year.

Hence, the radius of the orbit (not taking into account the eccentricity) = **149496268,4501** km, or 149.5 million km. This value is taken as the basic astronomical unit – **parsec**.

The entire cosmos is measured in this unit.

The actual value of the astronomical distance unit

If we take the distance of the astronomical distance unit from the Earth to the Sun, its value is somewhat different. Two values are known: the absolute velocity of the Earth's motion $V=29.765$ km/s and the angle of inclination of the Earth's equator to the ecliptic = $23^{\circ}26'38''$, or 23.44389° . If we question these two values, calculated with absolute accuracy during the centuries of

observations, it means that we destroy everything that is known about the Cosmos.

Now **IT IS TIME TO OPEN SOME SECRETS A LITTLE** which were already known, but no one paid any attention to them. **Firstly, *the Earth moves in space in a spiral and not in Kepler's orbit.*** It is known that the Sun moves, but it moves along with the whole System, so the Earth moves in a spiral. And **secondly, is that *the Solar system is in the field of action of the Gravitational Reference.*** What it is will be shown below. It is known that the center of the Earth's gravitational mass shifts toward the South Pole **by 221.6 km**. However, the Earth moves in the opposite direction. If the Earth just moved along Kepler's orbit, according to all the laws of motion of the gravitational mass, the movement would be the South Pole ahead, and not the North Pole. The spinning top does not come of here because the inertial mass would have taken a normal position – the South Pole in the direction of the movement. However, any spinning top can rotate with a displaced gravitational mass only in one case – when the axis of rotation is strictly perpendicular to the plane. But not only the resistance of the medium (vacuum) acts on the spinning top, the pressure of all radiations from the Sun, the mutual gravitational pressure of other structures of the Solar System. Therefore, the angle equal to **23°26'38"** takes into account all external influences, including the effects of the gravitational reference frame. The Moon orbit has an inverse angle to the Earth's orbit and this, as will be shown below, does not correlate with the calculated constants. Imagine a cylinder on which a "spiral" is wound. The spiral pitch = 23026'38". The spiral radius is equal to the cylinder radius. Let us unfold one turn of this spiral on the plane:

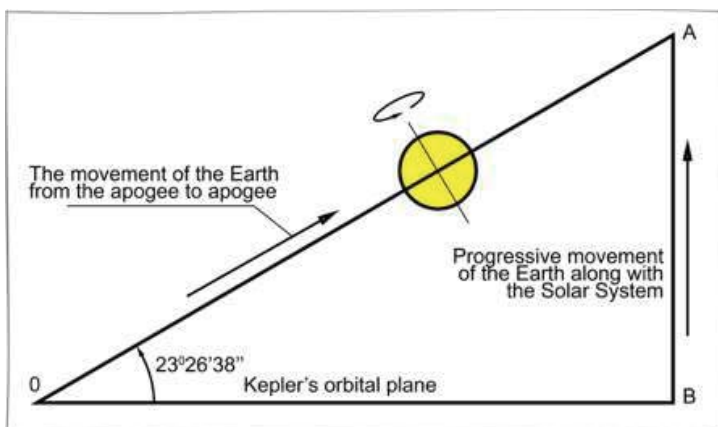

The distance from point O to point A (apogee and apogee) is equal to **939311964** km. Then the length of Kepler orbit: $OB=OA \cdot \cos 23.44839 =$ **861771884,6384** km, hence, the distance from the center of the Earth to the center of the Sun will be equal to **137155371,108** km, that is somewhat less than the value that is known (by **12344629** km) – almost by 9%.

A lot or a little, let's look at a simple example. Let the speed of light in a vacuum be 300,000 km / s. At the value of 1 parsec = 149.5 million. km the time of passage of the Sun's ray from the Sun to the Earth is 498 sec; at a value of 1 parsec = 137.155 million km, this time is 457 sec, that is, **41** second less.

This difference of almost 1 minute is of great importance, since, firstly, all distances in the Cosmos are changed, and secondly, **THE CLOCK INTERVAL OF LIFE SUPPORT SYSTEMS IS VIOLATED**, and the accumulated or not taken power of the life-support systems can lead **to the disruption of the operation of the system itself**.

Gravitational reference

The influence of the gravitational reference on the change in the Earth's orbit will be considered below. It is known that the plane of the ecliptic has a slope with respect to gravity lines of the gravitational reference, but the direction of motion is perpendicular to these force lines.

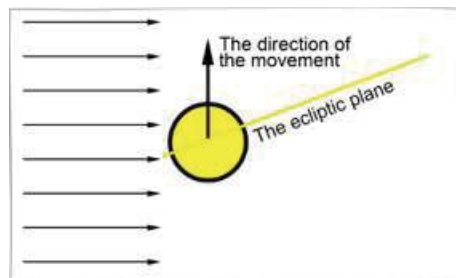

Libration of the Moon

Let's a more précised scheme of the Moon's orbit:

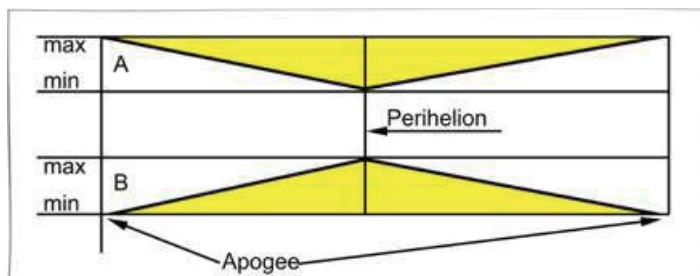

Group angles A:

5° 18'58.42" – apogee,

5° 17'24.84" – perihelion

Group angles B:

4° 56'58.44" – apogee,

4° 58'01" – perihelion

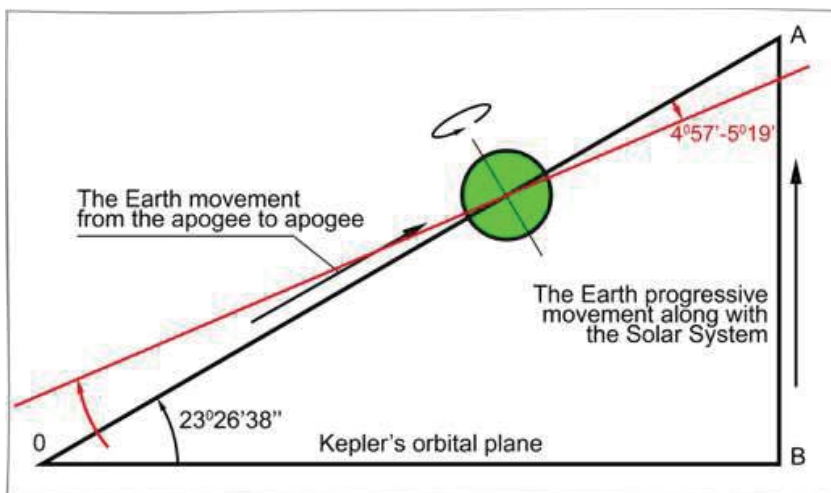

Taking into account that the Earth moves in a spiral, as well as the direct action of the gravitational reference, this reference also has a direct impact on the Moon, which is evident from the calculation of the angles.

Practical use of the constant "parsec"

As it is was shown earlier, the value of the constant "parsec" differs significantly from the value that is used in everyday practice. It will be useful to consider several examples of the use of this value.

Time control

As is known, **ANY EVENT ON THE EARTH TAKES PLACE IN TIME**. Besides, it is known that any space object having a non-inertial mass has its own time. The inertial mass has a lifetime determined by the charge equivalent density and its value for the bonding of ionic structures. Any **NON-INERTIAL MASS POSSESSES A MAGNETIC FIELD**, and the rate of decay of the magnetic field is determined by the decay time of the upper

structure and the need for lower (ionic) structures in this decay. For the Earth, taking into account its Universal scale, a single time is taken, which is measured in seconds, and time is the function of the space that the Earth passes for one full revolution, moving in a spiral following the Sun. In this case, there must be some structure that cuts off the "O" time and, relative to this time, makes certain manipulations with life support systems. Without such a structure, it is impossible to provide both a stable position of the life support system itself and the system of communication.

Previously, the motion of the Earth was considered, and it was deduced that the radius of the Earth's orbit is significantly (at 12344629 km) different from the accepted in all known calculations. If we accept the velocity of propagation of a gravitomagneto-electric wave in the Cosmos $V=300000$ km/sec, this difference in orbits will be 41.15 sec.

There can be no doubt that only this **VALUE WILL MAKE SIGNIFICANT CORRECTIONS**, not only in the problems of solving life support tasks, but, which is extremely important, – in communication, that is, messages just **MAY NOT GET THEIR DESTINATION**, and other civilizations might take advantage of it. Hence, – one must understand the enormous role played by the function of time, even in non-inertial systems, so let's consider again what is known to everyone.

Coordination systems independent control structures

It is quite unusual – but to the system of coordination it is necessary to classify **the pyramid of Cheops in El-Giza (Egypt)** – 31° eastern longitude and 30° northern latitude.

The unusualness is in the fact that the angle of entry into the pyramid is $25^\circ 15'$, and in the daytime position is precisely directed to the North Star. But there is no such an angle in astronomy, that's why they consider the pyramid just a ritual structure. Making simple calculations, we find **that this was the angle the Earth had when there was no Moon**. This means that the trace of the early state of the Earth

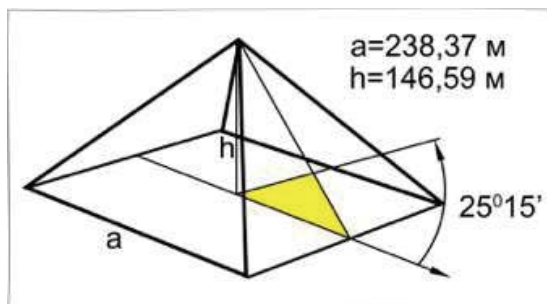

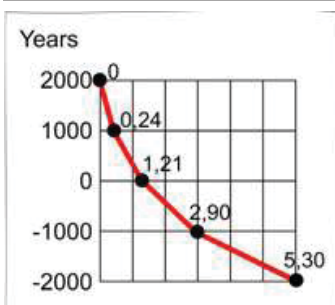

remains, and the angle of inclination of the equator was exactly $25^{\circ}15'$. How much has the Earth's orbit changed when the Moon appeared? The common path of the Earth for one revolution is **939311964** km, then the projection to Kepler's orbit: $939311964 \cdot \cos(25.25)^{\circ} = 849565539,0266$.

Radius $R_{\text{ncx}} = 135212669,2259$ km. The difference between the initial and current states is **14287330,77412 km**, that is, **the projection of the Earth's orbit has changed to $t = 47,62443591374$ sec.** Whether it is much or little depends on the purpose of control systems and the duration of communication.

The initial reference point

Location of the present day initial reference point – $37^{\circ}30'$ eastern longitude and $54^{\circ}22'30''$ northern latitude. The inclination of the reference point axis is $3^{\circ}37'30''$ to the North Pole. The reference point direction: $90^{\circ} - 54^{\circ}22'30'' - 3^{\circ}37'30'' = 32^{\circ}$.

Using the Star map, we find that the initial reference point is directed to the constellation of the Great Bear, the Megrec star (4th star). Therefore, **THE REFERENCE POINT WAS CREATED WITH THE PRESENCE OF THE MOON.**

Orientation

After the Moon appearance due to the change in the equator angle of inclination by $1^{\circ}48'22''$ there was a displacement of the Earth's orbit. While keeping the position of the early reference point, which for today does not define anything, only the initial reference point remains, but what will be shown below may seem at first glance to be a small misunderstanding easily amendable. *However, here lies the fact that is able to bring any life support system to disintegration.*

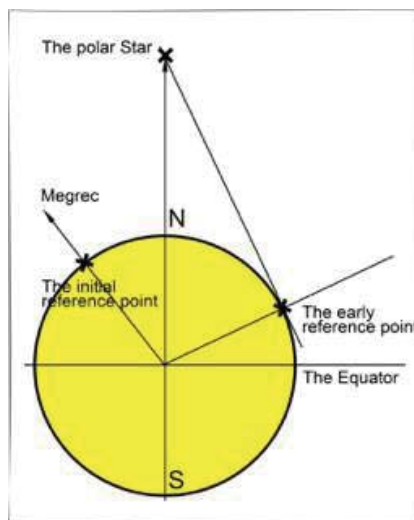

The first relates, as was indicated earlier, to a change in the time of the Earth's motion from apogee to apogee.

The second – the Moon, as the observations have shown, tends to change the correction term in time, and this is evident from the table:

It was previously indicated that the Moon's orbit with respect to the Earth's orbit has a slope: group angles A: $5^{\circ} 18' 58.42''$ – apogee, $5^{\circ} 17' 24.84''$ – perihelion; group angles B: $4^{\circ} 56' 58.44''$ – apogee, $4^{\circ} 58' 01''$ – perihelion

However, introducing a correction term, we get different values for the Moon's orbit.

The third note –The Moon cycles.

As you know, not Julian calendar has 13 months, but if a complete table of optimal days (Easter) is shown, then we see a serious shift, which was not taken into account in the calculations. ***This shift, expressed in seconds, takes the wanted date far from the optimal point.***

Glossary

1	Light	electromagnetic wave perceived by the eye	$(4-7.5) \cdot 10^{14}$ Hz ($\lambda=400-700$ n.m.)
2	Light year	The distance traveled by light per year	0.3068 parsec = $9.4605 \cdot 10^{15}$ m
3	Parsec (ps)	The distance from which the average radius of the earth's orbit, perpendicular to the viewing angle, is visible at an angle of 1 second	206265 a. e = $31 \cdot 10^{15}$ m
4	The diameter of our Galaxy		25000 parsec
5	Radius of the Universe		$4 \cdot 10^{26}$ m
6	Sideric month (S)	This is a star month – the period of the Moon's movement in the sky relative to the stars (a complete revolution around the Earth)	27.32166 = 27 days 7 hours 43 min.
7	Sideric Year-T	The period of revolution of the earth around the sun	
8	The synodic month (P) The Saros cycle, or METON	$\frac{1}{P} = \frac{1}{S} - \frac{1}{T}$ ST = PT – PS phase change	29.53059413580.. 29 d 12 h 51m 36"
9	The Draconic Month (D)	The period of revolution of the moon relative to the nodes of its	27.21222= 27 days 5 hours 5 min

		orbit, i.e. the points of intersection of the ecliptic plane	
10	Anomalistic month (A)	The period of revolution of the moon relative to perigee, the closest to the earth point of its orbit	27.55455= 27 d 13 h 18 m
11	The line of nodes of the Moon orbit slowly turns toward the Moon's movement, making a full turn in 18.6 years, while the major axis of the Moon orbit turns in the same direction as the Moon moves, with a period of 8.85 years		
12	APEX (the direction of the sun)	λ – Hercules, is located above the main plane of the stellar system (displacement 6 pc)	
13	The outer boundary of the solar system (Hill's sphere)		1pc = 2·10 ⁵ a.e.
14	The boundary of the solar system (the orbit of Pluto)		39 a.e.
15	The astronomical unit is the distance of the Earth to the Sun (au)		149,6·10 ⁶ km
16	Distance C.C. from the central plane of the Galaxy		8000 pc
17	Linear velocity of motion around the Galactic Center		220 km/sec

The sun

Radius	6,96·10 ⁵ km
Perimeter	43,73096973·10 ⁵ km
Diameter	13,92·10 ⁵ km
Acceleration of free fall at the level of the visible surface	270 m/sec ²
The average period of rotation (Earth days)	25,38
The inclination of the equator to the ecliptic	7,25°
Solar Wind Range	100 a.e.

The Moon

3 moons arrived. Two Moons (Lel and Fata) were destroyed by the planet (Phaeton), which blew itself up.

Parameters of the remaining Moon (Mesyats)

	Encyclopedia
Orbit – elliptical	
Eccentricity	0.05490
Radius R	1737.983 km
Diameter	3475.966 km
Circumference (perimeter)	10920.0692497 km
Apogee	405500 km
Perihelion	363300 km
Average distance	384400 km
The barycenter of the Earth-Moon system from the center of the Earth mass	4670 km
Distance between the centers of the Earth and the Moon:	379564.3 km, angle 38'

Apogee – Perigee –	384640 km, angle 36'
The slope of the plane of the orbit (to the plane of the ecliptic))	5°08'43.4"
Average orbit speed	1.023 km / sec (3683 km/hour)
The daily velocity of the visible motion of the moon among the stars	13.2°
Period of orbital motion (sidereal month) = Period of axial rotation	27.32166 day
Phase change (Synodic month)	29.53059 day
Equator of the Moon has a constant inclination to the ecliptic plane	1°32'47"
Libration in longitude	7°54'
Libration in Latitude	6°50'
The observable surface M	59%
The angular radius (from the Earth) of the visible disk of the Moon (on Wed distance)	31'05.16"
Surface area	3.796·10 ⁷ km ²
Scope	2.199·10 ¹⁰ km ³
Weight	7.35·10 ¹⁹ t (1/81.30 from Earth mass)
Average density	3.343 g / cm ³
from the Moon the angle of the Earth	48"
The density of the ionic structure is uniform and amounts to	2.4 kg / dm ³

The ionic structure includes ionic formations of practically the entire table of ionic formations of the cubic structure with the predominance of S (sulfur) and radioactive rare-earth elements. **The surface of the Moon is formed by spraying with following heating.**

There is nothing on the surface of the Moon. The moon has two surfaces – the outer and the inner. The surface area – 120·10⁶ km² (code of the moon – complex N^o120); the inner surface – 116·10¹⁰ m² (code mask). The side facing the Earth is thinner by 184 km. The gravity center is located behind the geometric center.

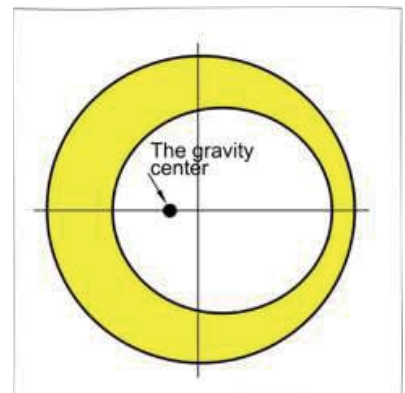

INSIDE THE MOON THERE IS EVERYTHING NECESSARY FOR LIFE
66:

- own lighting 53.875875 octave (beta+);
- acceleration 1.52 g (inside);
- on the surface 1.633 g;
- 120 lux/square meter lighting;
- octave 66 providing life;
- other octaves necessary for life support.

Inside the Moon there are 4 complexes:

Complex 38.1 – 7 pyramids with variable geometry (all sets of frequencies). Ranges of pyramids: 20.0-21.0; 24.0-25.0; 28.0-29.0; 36.0-37.0; 42.0-43.0; 44.0-45.0; 46.0-47.0.

Complex 38.2 – 6 pyramids with a fixed octave: 50.0, 50.5, 60.0, 60.5, 66.0, 66.5.

Complex 38.3 – 3 pyramids with fixed frequency, ranges: 53.375; 53.875875; 53.975975.

Complex 38.4 – 6 pyramids with a fixed octave: **28, 36, 40, 44, 50, 54**. The average loss is up to 45%, to the Earth 50-55% emissions. All the complexes are reliably protected and do not reveal themselves even when working.

Complex	Pyramids	Octave A	Octave B	Octave C	Octave D		
381	3811	21(22)		21(22)		Changable geometry (all sets of frequencies)	
	3812	25(26)					
	3813	27(28)		27(28)			
	3814	37(38)					
	3815		43(44)	43(44)			
	3816	45(46)					
	3817	47(48)					
382	3821	23(24)				Fixed geometry	
	3822	35(36)					
	3823		83(84)				
383	3831	53,375				Fixed geometry	
	3832		53.625625				
	3833		53.625750				

	3834		53.75075 0			
384	3841	35(36)				Fixed geometry
	3842	39(40)				
	3843		49(50)			
	3844				53(54)	
	3845		61(62)			
	3846		63(64)*		63(64)	
381	3811	21(22)		21(22)		Changable geometry (all sets of frequencies)
	3812	25(26)				
	3813	27(28)		27(28)		
	3814	37(38)				
	3815		43(44)	43(44)		
	3816	45(46)				
	3817	47(48)				
382	3821	23(24)				Fixed geometry
	3822	35(36)				
	3823		83(84)			
383	3831	53.375				Fixed geometry
	3832		53.62562 5			
	3833		53.62575 0			
	3834		53.75075 0			
384	3841	35(36)				Fixed geometry
	3842	39(40)				
	3843		49(50)			
	3844				53(54)	
	3845		61(62)			
	3846		63(64)*		63(64)	

Octaves A – are produced by the pyramids themselves

Octaves B – received from the Earth (the Sun – *)

Octaves C – are in the tube of communication with the Earth

Octaves D – are in the tube of communication with the Sun.

At the moment of the pulse (radiation), the rotation speed or the orbit of the Moon can insignificantly change. The compensation is owing to the directional emission of octave 66.o.

This octave coincides with the octave grating of the Earth and does not do any harm.

The complexes on the Moon are designed **primarily FOR THE MAINTENANCE OF THE AUTONOMOUS LIFE SUPPORT**, and **secondly, FOR THE PROVISION** (in case of an excess of the charge equivalent) of the **LIFE SUPPORT SYSTEMS** on the Earth.

The main task is not to change the Solar System albedo, and due to the difference in characteristics, taking into account the correction of the orbit, this task is fulfilled.

Geometrically, in the existing law of the form, allowing withstanding a 28.5-day cycle of changing the sequence of emissions (the so-called phases of the Moon), the correction pyramids are perfectly fitted in, which completed the construction of the complexes.

There are 4 phases in total. The full Moon has a radiation power of 1, the remaining phases are 3/4, 1/2, 1/4. Each phase – 6.25 days, 4 days – no emissions. Clock frequency of all octaves (besides 54) – 66.5, but the density of the clock frequency is little, and therefore the brightness in the optical range is negligible. When correcting the orbit, the clock frequency 53.375 is used. But this frequency can change the upper atmosphere grating, and the diffraction effect can be observed.

In particular, from the Earth the number of Moons can be 3, 6, 12, 24, 36. This effect can last for maximum of 4 hours, after which the grating is restored at the expense of the Earth.

Long-term correction (in case of the albedo Solar System violations) **MAY RESULT IN** an **OPTICAL ILLUSION**, but here it is possible the elimination of the protection layer.

The table of complexes operation (the period of 2006)

Nº	Complex	Shebat	AdarI	AdarII	Nisan	Iyar	Sivan	Tammuz	Ab	Elul	Tishri	Heshvan	Kislev	Tibet
1	20.0	+	+	+	+	+	+	+	+	+	+	+	+	+
2	24.0	+	+	+	+	+	+	+	+	+	+	+	+	+
3	28.0	+	+	+	+									
4	36.0	+	+	+	+									
5	42.0					+	+	+	+	+	+	+	+	+
6	44.0	+	+	+	+									
7	46.0	+	+	+	+	+	+	+	+	+	+	+	+	+
8	50.0	+	+	+	+									
9	50.5	+	+	+	+									
10	60.0	+	+	+	+									

11	60.5	+	+	+	+									
12	66.0	+	+	+	+									
13	66.5	+	+	+	+									
14	53.3	+												
15	53.88	+	+	+	+	+	+	+	+					
16	53.99	+	+	+	+	+	+	+	+	+	+	+		
17	28.0	+	+											
18	36.0	+	+											
19	40.0					+	+	+	+	+	+	+	+	+
20	44.0	+	+											
21	50.0	+	+											
22	54.0	+	+	+	+	+	+	+	+	+	+	+	+	+

Luminosity of the Moon

The luminosity of the Moon is determined by the operation of its complexes, the Sun and the Earth.

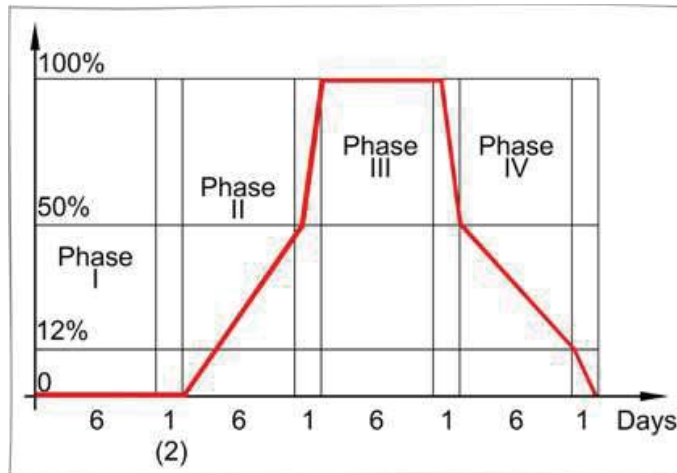

The Moon complexes work as shown in the figure. The surface of the Moon does not reflect anything, its luminosity is the imposition of working frequencies produced by the Moon and the Sun, and also the position of the communication tube with the Earth ("the shadow of the Earth")

When programs are thrown off to the Earth, halo rings around the Moon are observed (always in phase III).

The Moon Archive

Planets' satellites control the planets. Some of the satellites are the archive custodians. In response to the commands of the Earth Control System,

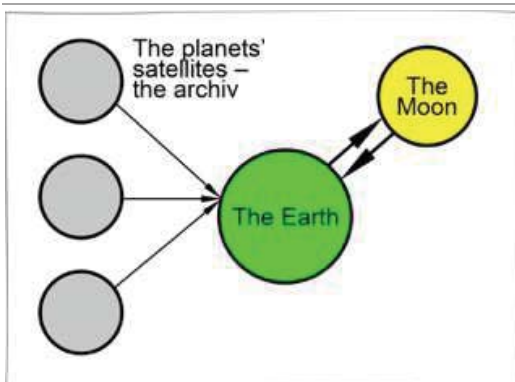

archival data is thrown off, and transmitted to the Moon to form a new Program in accordance with the conditions that have already been created on the Earth. The process of reading of archival materials is carried out only on the Moon, the coordination is also made on the data obtained after the capture of other planets in the Cosmos. The moon has

a powerful computing center and everything necessary to make the calculations. However, its resources are limited – initially, the complex consisted of **3 Moons, 2 of which were destroyed** (the meteorite belt is a former planet in which the Control System exploded itself along with all the objects (UFOs) that got to the secrets of the planets system existence.

At certain time, the remnants of the planet in the form of meteorites shoot the Earth, and mostly – the Sun, creating black spots on it.

Communication

The principles of the communication between neutron systems are considered in the example of communication with the object S64 (conventional name SS433).

The access parameters

When transmitting at: 00.30, 08.30, 16.30 (the reception is shifted by 4 hours) the transmitted message is in the cone with an angle $0.000000248''$ (with the radius of the active reception zone, equal to 124.000 km on the zone surface, the covering circle amounts to 30.75 m).

When receiving messages 75% resonance peak falls on the double radius of the active receiving zone and can be received by any station.

Energy characteristics:

Transmission: $EI=1.28 \cdot 10^{-2}$ volt·m²;

$MI=4.84 \cdot 10^{-8}$ volt/m³;

Reception: $EI=0.728 \cdot 10^{-8}$ volt·m²;

$MI=0.224 \cdot 10^{-8}$ volt/m³.

As you can see, great amount of power is required to work with communication and, so that not violate the noosphere, charge equivalents are used of octave 84 MI.

The transmit-receive frequency is constant and is equal to 375965 MI of the hydrogen atom H₄ (4 communications).

The MI potential is quantized over 32 symmetry angles and includes series:

1. Negative series: 4, 8, 12, 14, 16, 18, 21, 24, 28, 32, 36, 40, 44, 48, 52, 54

2. Positive series 54, 56, 58, 62, 64, 68, 72, 74, 76, 78, 82, 84, 88, 92, 94, 96.

These two series define only the alphabetic group and the sign of the symbol system, and all angles are not always used. ***When using all the angles, the power rises by 16 times.***

For encoding, **an 8-bit alphabet** is used:

DO RE MI FA SOL LA SI NA.

The main tones have no sign, i.e. Octave **54 determines the main tone**. Delimiter – octave 48 of the potential. Between two adjacent angles is an additional breakdown by 8, so one angle contains the entire alphabet. Positive series is designed for coding commands, orders and instructions (an encoding table), negative series contains text information (a table- a vocabulary). In this case, a 22-sign alphabet known on the Earth is used. 3 angles are used in a row; the last signs of the last angle are a full stop and a comma. The more significant is the text, the higher the octave angles are used.

Message text:

1. Code signal – 64 signs + 64 skips (fa). Repeat 6 times.

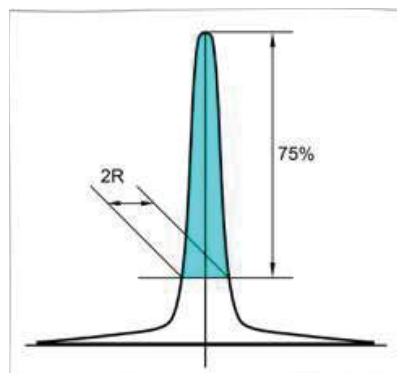
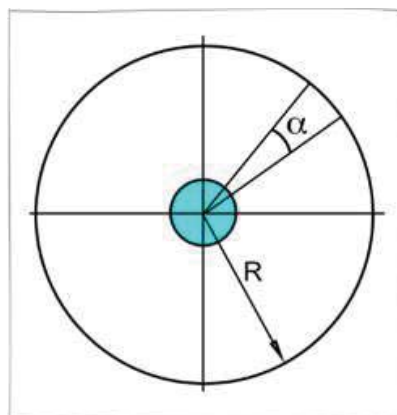

2. Message text – 64 signs + 64 skips and repeat 6 times, if the text is urgent, then 384 signs, and the rest are skips (384) and no repetitions.

3. The message key – 64 signs + 64 skips (repeated 6 times).

Taking into account the skips, a mathematical string of the Fibonacci series is superimposed on the text being received or transmitted, and the text entry is continuous.

The second mathematical string cuts off the red shift. The second code signal recognizes the cut-off type and the reception (transmission) is done in an automatic mode. The total length of the message is 2304 signs, time of reception and transmission is 38 minutes 24 sec.

Comment. The main tone is not always 1 sign. When the sign is repeated (urgent execution mode) an additional series is used:

Command-line table

	DO	RE	MI	FA	SOL	LA	SI	NA
54.000	+							
54.125		+						
54.250			+					
54.375				+				
54.500					+			
54.625						+		
54.750							+	
54.875								+

Command Repeat Table

	DO	RE	MI	FA	SOL	LA	SI	NA
54.00000000	+							
54.12501250		+						
54.25002500			+					
54.37503750				+				
54.50005000					+			
54.62506250						+		
54.75007500							+	
54.87508750								+

Messages decoding is made in automatic mode using the conversion table in accordance with the spine frequency parameters, if the commands are intended for people. This is a complete piano 2nd octave, 12 signs a table 12×12, in which until 1266 there was the Hebrew, until 2006 – English, *and from Easter 2007 – the Russian alphabet (33 letters)*.

The table contains numbers (12th number system), signs of type "+", "\$" and others, as well as service symbols, including code masks.

When transmitting or receiving messages the Moon communication Complexes orient the Moon so that there could no displacement from the tube axis. Orientation duration is **17.2 minutes**. The revolution of the Moon stops for this time, after the restoration of the revolution there takes place an oscillatory process for several hours, therefore not 50% of the surface (as generally accepted), but 58% are observed from the Earth. ***This number is known to astronomers, but there are no explanations.***

Long-distance communication system

The communication system is at 84 octave, but this octave is formed by the Earth. Communication with Sur requires quite a lot of energy resources (octave 53.5). Communication is possible only after the vernal equinox, for 3 months. The speed of light is a relative value (relative to 128 octave) and therefore, relative to 84 octave the speed is 220 times less. For one session, 216 signs (including service ones) can be transmitted. The communication is only after the completion of the Methon cycle. The number of sessions is 1. The next session is about in 11.4 years, while the energy supply of the Solar system is falling by 30%.

Let us go back to the Moon phases. Number the sequence of phase changes.

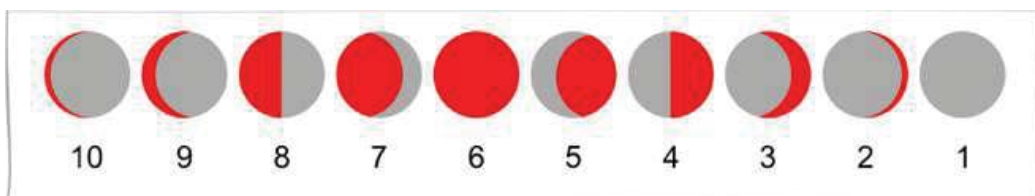

Number 1 – new Moon, 2 – a young Moon (with the diameter of the Earth roughly equal to the diameter of the Moon), **3 – the first quarter** (the diameter of the Earth is longer than the actual diameter of the Earth), **4 – The moon is sawn in half.** In the physical encyclopedia it is stated that this is the angle of 900 (the Sun – the Moon-the Earth). But this angle can last 3 to 4 hours, but we see this state for 3 days. **Number 5 – what form of the Earth gives such a "reflection"?**

Note that the Moon revolves around the Earth and if we believe the encyclopedia, then the change of all 10 phases, we can observe within one day.

The moon does not reflect anything, and if the Moon Complexes are disconnected due to the elimination of a number of frequencies in the Moon-Earth communication tube, we will no longer see the Moon. In addition, the elimination of some of the gravitational frequencies in the Moon-Earth communication tube will **MOVE THE MOON BACK** by at least 1 million km **UNDER THE CONDITIONS OF THE NON WORKING MOON COMPLEXES**.

Protection of the Moon

The moon is a special object; therefore it has a reliable protection.

The meteorite can not fall on the Moon – it will be directed to the Earth at best, but all random meteorites fall on the Sun and disappear in its crown. When a meteorite approaches, the Moon activates the anti-gravity belt (in the sector of the Earth's covering it is absent) and any meteorite changes its trajectory.

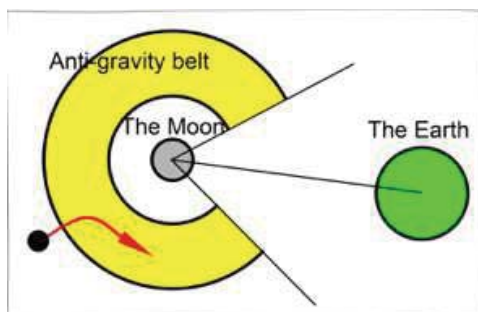

Objects (UFOs) of the Moon

It is believed that the Moon was captured by aliens who have been preparing to attack the Earth. There are photos of the movements of their objects on the Moon, the facts of escorting the Earth's spacecraft, glow from the Moon craters, and unusual structures on the Moon and so on. Means for contacts with aliens are planned, which will give civilized humanity all the necessary technical innovations. **Dear housewives!!** Everything that exists on the Moon has existed on the Earth for a long time, so there is no need to hint at the Moon, you just have to take a spade and dig out in the right place the same thing.

On the Earth **THERE ARE MORE POWERFULL STRUCTURES OF UFO** than on the Moon. In addition, they are able to materialize in the Earth's atmosphere.

On the Moon there are the following series of PLO (decoding from the commands): 126, 132, 136, 144, 152 164, 172, 212, 222, 244, 256, 264, 316.

The resources of the objects correspond to the index (in ascending order). On the Earth, **the minimum index is 346**, that is, an object with minimal resources on the Earth is much more powerful than the "coolest" Moon object. **No object on the Moon can leave the Moon (there are no right frequencies)**. At the same time, the Earth's objects, starting *with index 440, can move to the Moon if a movement tube is available*, which is formed by the objects Control complex (located in the USA, about 200 km North-West of New York).

THE MOON HAS ONE MORE PROPERTY. *No meteorite over 30 cm in diameter can fall on the Moon.* The Moon protective complex alters the trajectories of all larger meteorites. Glows from the Moon craters are the input-output tubes of the local objects. The exact time is set by the Moon. The reading is transmitted to the complex system of exact time (South Wales), which informs (and explains at the same time) the reasons for the time shift for housewives.

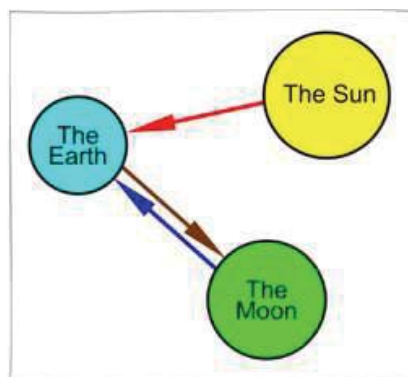

The Moon has its own (not optical) radiation, the frequency band comes from the Earth, the Sun gives the clock frequency. The sum of frequencies is the light that we see. If anything is removed, then the Moon will be invisible. **THE SURFACE OF THE MOON DOES NOT REFLECT ANYTHING ON ITS OWN!**

The moon is a kind of aircraft carrier that brought everything necessary to a new place.

On holidays, the Moon turns red. Holidays – **according to the Methon calendar are March 8, May 1, May 9, January 7, November 7** (dates according to the Earth's calendar).

Each of them is a significant date in the life of Ebr. As you can see, there is no Day of the Paris Commune. The glow of the Moon is different from the glow of stars and planets. I note here that the Methon cycle (Methon cycle,

Methonic cycle, lunar cycle) is a **19-year calendar cycle** showing the ratio of the lunar month and the solar year. The cycle uses the ratio of **19 tropical years = 235 synodic months**. In each cycle, the distribution of the Moon phases is repeated accurately to several hours. The error in the Moon phase shift is **1 day within 219 years**. The cycle is named after Greek astronomer and mathematician Methon, who discovered it **in 432 BC**, although it was known in ancient China (since 2260 BC) and Ancient Babylon.

Little is known about Methon's life: he was the son of a man named Pausanias and escaped conscription, feigning madness; he was a contemporary of the playwright Aristophanes, who depicted him in his play "Birds» in the image of a funny geometer Methon considered the length of the year equal to **365.25 days**, so 19 years make up **6939 days 18 hours**, and 235 synodic months (lunations) **equal to 6939 days. 16 hours 31 minutes** (about 1.5 hours less). Since 19 years by 12 months give a total of 228 months, then every 7 years of the 19 cycle one additional month is added (that is, the cycle consists of 12 years by 12 months and 7 years by 13 months). It is believed that Meton added additional months in the 3rd, 6th, 8th, 11th, 14th and 19th years of the cycle. The duration of the months was 29 or 30 days: all the years, containing 12 months, their duration alternately is 29 or 30 days, 6 additional months have duration of 30 days, and the seventh – 29 days. Total in the cycle are 110 months by 29 days and 125 months by 30 days. The Methon cycle served as the basis for making many lunar-solar calendars: the Greek lunar-solar calendar, Babylonian, Hebrew and some others. Beginning with the Middle Ages, **the ORDINAL NUMBER OF THE YEAR IN THE METHON CYCLE** (taking values from 1 to 19) there began to call **the Golden Number**.

Easter

All the Earth Control Systems are synchronized according to the clock, set by the Sun, taking into account the motion of the Moon. The motion of the Moon around the Earth is the Synodic month (**P**) **the Saros cycle, or Methon**. The calculation is according to the formula **ST=PT–PS**. The calculated value =**29.53059413580**. or **29 days 12 hours 51 minute 36 seconds**.

THE EARTH'S POPULATION IS DEVIDED INTO 3 GENOTYPES: 42 (the main population, more than 5 billion people), **44** (the "golden billion" having a brain brought from the satellites of the planets) and

46 (the "golden million", 1200000 people dropped from the Sun planet). Note that the Sun is a planet, not a Star; its size does not exceed the size of the Earth. To activate genotype **42 to 44 and 46**, *there is Easter, or a certain day when the Moon* throws off the Programs. *Until 2009, all Easters were held only in the III phase of the Moon.*

By 2009, the formation of genotypes **44 and 46** had been completed and the genotype **42** could have been destroyed, so Easter 2009-04-19 was held at the new Moon (Phase I), and the Earth Control System was to destroy the genotype 42 **UNDER THE CONDITIONS OF WITHDRAWING the BRAIN REMNANTS BY THE MOON**. It was given **3 years** for the destruction (2012 – completion). However, this process was abruptly stopped, but stopped after it had started. In fact, the change in the brain activity of this genotype began, which significantly affected the adequacy of the people. Previously, there was one-week cycle in which all those who had the old brain withdrawn, and the new one not yet gotten, were destroyed (Holocaust). Today, the halted withdrawal of the brain results in this inadequacy.

Calendar structure

The Control Systems operate by Methon, but on the Earth (in churches, Roman Catholic churches, synagogues) they use the Julian or Gregorian calendar, which takes into account only the motion of the Earth (the average value of 4 years is 365.25 days). The complete cycle (19 years) of Methon and 19 years of the Gregorian calendar roughly coincides (accurate up to hours). Therefore, knowing Methon and combining it with the Gregorian calendar, you could "joyfully celebrate your transformation."

3.4. About other planets without any preconception

We have been well familiar with the Solar system since school and take it for our home. The names of the planets that make up its composition, the order of their relative position (and maybe even their distance from the Sun) are known to many of us. However, it is worth adding a little more to our knowledge about it.

Table of comparative characteristics

Name	Average distance from the Sun million km in a.e.	Period	Inclination	Temperature
The sun	-	-	7°25	+5800
Mercury	57.9	0.387	7°004	+337
Venus	108.2	0.723	3°394	+400 +500
Earth	149.6	1.000	-	+14
Moon	0.3844	0.0549	5°145	
Mars	227.9	1.524	1°850	+30
Jupiter	778.3	5.203	1°304	-143
Saturn	1427.0	9.539	2°893	-145
Uranus	2889.6	19.18	0°773	-170
Neptune	4496.7	30.06	1°772	-210
Pluto	5912	39.52	17°14	-220

Period – period of revolution around the Sun in tropical years
 Inclination of the plane of the orbit to the ecliptic for 1975
 Mass of the Sun = $1.989 \cdot 10^{30}$ kg.

Inclination to the ecliptic for the Sun.
 Temperature – under the Sun point, for the Sun – in the photosphere.
 Astronomical unit (a.e.)=149.6 million km (parsec)

Halley's Comet, about which so much is said – crosses the orbits of the Earth, Mars, Jupiter, Saturn, Uranus, Neptune, the orbit is elliptical.

	Merc ury	Venu s	Earth	Mars	Phaet on	Jupit er	Satur n	Uran us	Nept une	Pluto
Distance to the Sun (L)	57.9	108.2	149.6	227.9		778.3	142.7	2870	4490	5890
Log ₂ L	25.78 7	26.68 9	27.15 6	27.76 4		29.53 6	30.41	31.41 8	32.06 4	32.45 5
Difference L		0.90 2	0.467	0.60 8		1.772	0.874	1.008	0.64 6	0.391
Inclination of the plane of the orbit to the ecliptic	7°0.2'	3°23.6'	-	1°51.8'		1°18.5'	2°29.5'	0°46.3'	1°46.8'	17°8.7'
Sideric period of circulation in tropical years	0.241	0.615	1.000	1.881		11.86 2	29.45 8	84.01 5	164.7 9	247.7
Average speed in the orbit	47.9	35.0	29.8	24.1		13.1	9.6	6.8	5.4	4.7
Inclination of the equatorial	0°	5°				3°4'		98°	29°	-

plane to the orbit (*)			23°27'	23°59'			26°44'			
Equatorial radius	2430	6052	6378	3395		70850	60100	24600	23500	1500
Sidereal Equatorial Period of Revolution, d – day, h – hours, m – minutes, s – seconds	59 ^d	-243 ^d	23 ^h 56 ^m 4.1 ^s	24 ^h 37 ^m 22.6 ^s		9 ^h 50.5 ^m	10 ^h 14 ^m	10 ^h 49 ^m	15 ^h 49 ^m	6.4 ^d
Number of satellites (own)	-	-	-	-		8	8	8	-	-
Number of satellites (strangers)	-	-	1	2		8	9	7	8	1

(*) In the Solar System there are 5 complexes (**angle >23°**), The rest are either destroyed when captured, or turned off.

Satellites of the Planets

Nº				Average distance from the planet, center thousands of km	Period of rotation, the Earth days	Diameter or dimensions
1	Earth	1	Moon	384.4	27.32	3476
2	Mars	1	I Phobos	9.378	0.32	25×21×19
		2	II Deimos	23.459	1.26	15×12×11
3	Jupiter	1	XVI Metida	127.96	0.29	40*
		2	XV Adrastea	129.8	0.27	25*
		3	V Amalthea	181.0	0.50	270*
		4	XIV Thebes (Teba)	221.9	0.67	110*
		5	I Io	421.6	1.77	3630
		6	II Europe	670.9	3.55	3138
		7	III Ganymede	1070	7.15	5262
		8	IV Callisto	1883	16.69	4800
		9	XIII Leda	11004	238.72	16
		10	VI Himalia	11480	250.57	180
		11	X Lysitia	11720	259.22	40
		12	VII Elara	11737	259.65	80
		13	XII Ananke	21200	631	30
		14	XI Carme	22600	692	44

		15	VIII Pasiphae	23500	735	70
		16	IX Sinope	23700	758	40
4	Saturn	1	XV Atlas	137.67	0.60	40 *
		2	XVII Prometheus	139.5	0.61	140 *
		3	XVI Pandora	141.7	0.63	110 *
		4	XI Epimetheus	151.422	0.69	140 *
		5	X Janus	151.472	0.69	220
		6	I Mimas	185.52	0.94	394
		7	II Enceladus	238.02	1.37	502
		8	III Tethys (Tethys)	294.66	1.89	1048
		9	XIII Telesta	294.66	1.89	24 *
		10	XIV Calypso	296.66	1.89	30 *
		11	IV Dione	377.40	2.74	1118
		12	XII Elena	377.40	2.74	36 *
		13	V Rhea	527.04	4.52	1530
		14	VI Titanium	1221.85	15.94	5150
		15	VII Hyperion	1481.85	21.27	350 *
		16	VIII Yanet	3561.3	79.33	1436
		17	IX Phoebe	12952.0	550.48	230 *
5	Uranus	1	U7 Cordelia	49.75	0.33	40
		2	U8 Ophelia	53.27	0.38	50
		3	U9 Bianca	59.16	0.44	50
		4	U3 Cressida	61.77	0.46	60
		5	U6 Desdemona	62.65	0.47	60
		6	U2 Juliet	64.63	0.49	80
		7	U1 Porcia	66.10	0.51	80
		8	U4 Rosalinda	69.93	0.56	60
		9	U5 Belinda	75.35	0.62	60
		10	U1 Pack	86.0	0.76	170
		11	V Miranda	129.8	1.41	471.6
		12	I Ariel	191.2	2.52	1157.8
		13	II Umbriel	266.0	4.14	1169.4
		14	III Tigania	436	8.71	1577.8
		15	IV Oberon	582.6	13.46	1522.8
6	Neptune	1	Naiad	48	0.296	50
		2	Thales	50	0.312	80
		3	Despina	52.5	0.333	180
		4	Galatea	62	0.429	150
		5	Larissa	73.6	0.554	190
		6	Proteus	117.6	1.121	200
		7	Triton	354.8	5.877	2700
		8	Kerenda	5562.4	360.16	340
7	Pluto	1	Charon	19.64	6.387	1186

(*) Has an irregular shape. The size of the major axis is indicated.

Remarks to these tables, for those who wish to take the Bath:

1. As the Solar System moves, **ALL THE PLANETS MOVE ALONG SPIRALS**, and not on Kepler's orbits.

2. The astronomical unit (**149.5 million km**) is incorrect. Taking into account the motion along the spiral under the conditions of a uniform Cosmos grating, from the Earth to the Sun **A=135.21 million km**.

The distance of 149.5 million km. is taken as the basic astronomical unit – parsec. The path traveled by the Earth within a year is: **365.25·24·3600·29.765 = 939311960 km**. The radius of rotation: **939311960/(2·3.14159) = 149.5 million km**. However, the inclination of the equator to the ecliptic = **23°26'38"**.

The distance from point A to point A is **939311960 km**, hence the Kepler's orbit length = **849565530 km**, hence the radius of the Earth's orbit (A): **135.21 million km**.

3. From the Sun to Pluto we have a sectional division of space (like hollow balls nested one into the other). Each such ball has its own density of grating structures and its octave of grating coupling.

4. The space changes significantly, as when examining an object through glass, which has different densities. The above properties are not known in physics, all measurements are performed in a linear uniform space

5. After the self-destruction of Phaethon planet (conventional name), not only the orbits of planets, rotation time, luminosity and many other parameters (in particular, the frequency balance of the Planetary Complexes) have changed.

6. Planets that have powerful Complexes are surrounded with extraneous (alien to the Solar System) satellites that control the operation of the Complexes.

How much futile are all those abstract conclusions in which we have been believing from the school bench, that have nothing to do with the experience and reality. **Therefore, it is necessary to recalculate the actual distances to the planets.** And as for the Comet Galileo – **Science does not know the purpose of the Comet.**

Why did I bring all these calculations here, as well as the processes that **A. Khatibov did and described?** Only **TO MAKE IT CLEAR, HOW**

COMPLEX ARE THE CONTROL PROCESSES, the information transmission, its fulfillment and numerous factors beyond the terrestrial manifestation, including from the Moon, which directly affected and go on affecting today our life support in full. Now, beginning **with 2013**, these processes have been changed in their content, but the **PHYSICS OF THE ONGOING PROCESSES HAS BEEN CHANGED INSIGNIFICANTLY**. Therefore, a lot of the above calculations are taken into account and applied in the "**SvetL**" Programs, which become an integral part of knowledge for those who are striving for the Bath.

3.5. Awareness and understanding

I am going on with those necessary concepts that will make it possible to comprehend the represented information much deeper. And the problem here is not in the limitations of the readers' intellectual potential, but in the subconscious or non-subconscious resistance to knowledge due to the fact that, should the new information be adopted, it is necessary to revise almost all of your conceptions and estimate anew your actions. There is a general dispose not to understand this, or be afraid of this. That's why there is a necessity to get urgently ready for the **Bath**.

It took me long to find the right and correct approach to the subject so that not to hurt the reader who "considers" the object to be sent to the **Bath** in all details. My talk with **N. Levashov** came to my mind, where he touched upon this very subject. Later, I read his **article** written in 2002 on this subject, which I fully agreed to. Therefore, I will try to present this urgent topic today with words that are close to the source, before going on with the description of the object itself, *which should be taken to the Bath*. I have no doubt that it will be useful for both who have and haven't read it.

The main cause of problems for the earth humanity is not a low degree of civilization development, but the **DISTORTED LOGICAL FOUNDATION – BINARY LOGIC** that is used by the majority of those who live. Any the highest developed civilization of the cosmos began its development from the same primitive stage as ours, if not worse. *The development of civilization can be compared with the development of one Man*. A Man is born, grows, gets education, lives his life with more or less success, then dies ... and it

all starts again. The Earth civilization is in the initial phase of its development, which under certain conditions may become the last. So that it should not happen, **NEW KNOWLEDGE** is necessary. And where to get it? How to "get the way to it"? For this, you have to take a "spade of knowledge" and start digging. And it is advisable to start digging precisely with the works of **N. Levashov**, having built a solid foundation for the new knowledge on this site. Then move on to the construction of everything planned. But you do not have to stop digging, because you get some experience and knowledge which allow you to move to another "layer", such as the works of **A. Khatybov**. And so dig deeper and deeper. If you are lucky and you are taken to the Bath, the results of all this will immediately manifest themselves and begin to be realized in reality. But initially, to perceive new knowledge, a Human and Humanity have to change their logical foundation, this is what is said in the "**Third Appeal to Mankind**", published in **N. Levashov's book "The Last Appeal to Mankind"**.

To get at the meaning of the primitiveness and harmfulness of binary logic, I will give you a simple example. According to binary logic, based on the principle of **yes-no** answers, the question: "Is it warm in the room?" Will be followed by the answer: "**yes**" or "**no**". But is it really so? Of course not. The reaction of people in the room can be different, up to the opposite. For someone it will be normal, for someone – warm, hot, cool, cold. Which of these answers is correct? All are, and none is. The reaction of each person is determined by his physical state at the moment, his type of metabolic reactions, emotional state and many other factors. Even of the same person, the reaction to the temperature in the room will depend on whether he is after sleeping or after physical work, he is sick or healthy, under stress or not, etc. **The application of binary logic** destroys the beauty of diversity, the fullness of perception, transforms any bearer of such logic into a blind man. If such a blind man is asked to describe the surroundings, then there happens similar to that in the famous Indian parable about the three blind who are asked to explain what an elephant is. The first touches the trunk and says that the elephant is a soft, flexible pipe; the second one touches the tusk and says that the elephant is cold and hard; and the third one touches its leg and says that the elephant is a thick column... And so that not to find ourselves in the situation of such blind people, one thing is necessary, to give a correct explanation of what an elephant is, **TO SEE THE WHOLE OF THE ELEPHANT**. That is what **N. Levashov** tried

to help people do, but many people will **NOT WANT TO OPEN THEIR EYES**, to which, of course, they have every right.

So we will try to go this way. In order to read this book, you need to know the Russian alphabet, which currently has *thirty-three letters*. Without knowledge of all the letters of the alphabet it is impossible to read. And if you, for this or that reason, do not want to learn all the letters (for example, you do not like the way one or another letter is written or pronounced, and you decided that only letters **A, B, C, D, E** are necessary and only they), then try to read with their help any text. You can imagine, what will happen? At best, you will be able to read a few words consisting of these letters. Using this approach, you will say that in Russian it is not read at all, but what you can read is a complete nonsense. Do you get at the meaning?

The same is true with new knowledge. For their perception, it is necessary to learn a new "alphabet", regardless of whether you like it or not. In his books **N. Levashov** gave this alphabet of **NEW KNOWLEDGE**. Those who are not too lazy to take it, *have no problems with "reading" what is written in this "language", or in another "language", for example, A. Khatybov or mine*, regardless of the level of your is education. Of course, it is desirable to have at least a secondary education.

The man found himself on the Earth through the so-called Star Gate, which is a "device" that allows connecting two points of space, regardless of how far these points are from each other. Through such a device you can come in one planet, and come out on the other one, at distance billions of light years (the light year, according to modern physics, is the distance that light passes through the year at a speed of 300,000 km / sec). Therefore, the modern Man is an alien on the Earth. This is a special subject and requires quite an amount of additional information for understanding. We will consider this subject further, after we understand – *do we have to take the Bath or not to?*

The appearance of intelligent life is a natural result of the matter evolution in general and living matter in particular, because living matter is a special arrangement of the same atoms, of which "inanimate" matter is composed. The helical spatial form of **RNA** and **DNA** molecules creates in its internal volume the so-called **STAGNANT WAVE OF DIMENSIONALITY**. When other organic and inorganic molecules with their Brownian motion fall into the inner space of helices, their disintegration into primary matter takes place. Similar

processes take place with radioactive atoms, the only difference is that the radioactive atoms disintegrate themselves, and in the inner space of the helices of **RNA and DNA** molecules other molecules and atoms disintegrate. Out of the building material that has gotten free this way, an exact copy of both the **DNA or RNA** molecule and the whole cell is formed at the nearest spatial level. The second material body of the cell is formed, which is just as material as the physical body, it is only formed by a qualitatively different matter, although "related", habitual for us. Here is how it is written in more detail and graphically by N. Levashov in the book "**Inhomogeneity of the Universe**". At the explosion (for example) of a supernova, the amplitude of the perturbation of space can vary at different points and will be proportional to the quantization factor γ . Depending on the amplitude, there becomes possible the merge of 2 to 7 primary matter in the volume of space with the disturbed dimensionality (for our universe). For all that, the fusion of matter with the formation of a hybrid matter neutralizes the deformation formed (in our example as a result of a supernova explosion), creating a stagnant wave of dimensionality. The space itself returns to a state of equilibrium. But the very state of equilibrium for each of the variants of matter fusion (hybrid matter ABC or ABCDE) will be different depending on the amplitude of the perturbation and, accordingly, the amplitude of the stagnant wave of the space dimensionality. But the perturbation amplitude of the space dimensionality may not be sufficient to merge, for example, of all seven forms of matter – then the hybrid matter ABCDEFG can not be synthesized. However, the constant presence of minor variations of dimensionality in the space (relict cosmic rays, for example), creating a kind of dynamic background, are superimposed on the existing deformations, creating in some volumes the conditions for merging in the situation described above all seven primary matters. But a constant change of this dynamic background at some point (after the passage of the wave front) will return the space dimensionality to the original level and the hybrid form of matter ABCDEFG will disintegrate before the next front arrival. Thus, the hybrid form of ABCDEFG, what we call a physically dense substance, is in a state of flicker and in the language of physicists is called an electron with its dual properties of a particle and wave.

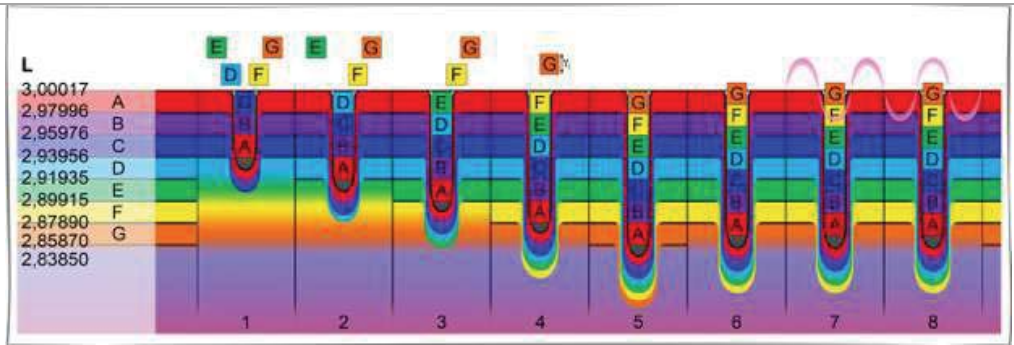

When the atom nucleus is formed, there arise the perturbations of the dimensionality – microspaces in a similar way. For all that, the damped perturbation waves form several zones of deformation, in which the merging of seven primary matters are possible, while in these annular zones of deformation stagnant waves of dimensionality of microspace are formed. At the level of microspace, there are constantly present microscopic fluctuations in the dimensionality that affect the change in the of dimensionality level in the zones of the stagnant wave of the atom dimensionality. Such perturbations lead to the fact that the electron (as a boundary form of matter) becomes unstable and disintegrates with the formation of a microscopic explosion. As a result, the zone of the stagnant wave of dimensionality created by the electron becomes higher than the level of the intrinsic atom dimensionality, and in this connection the merging of the seven forms of matter and the formation of an electron in the same deformation zone take place. As a result, the zone of the standing wave of dimensionality created by the electron becomes higher than the level of the intrinsic dimensionality of the atom, and because of this there takes place the merging of the seven forms of matter and the formation of an electron in the same deformation zone.

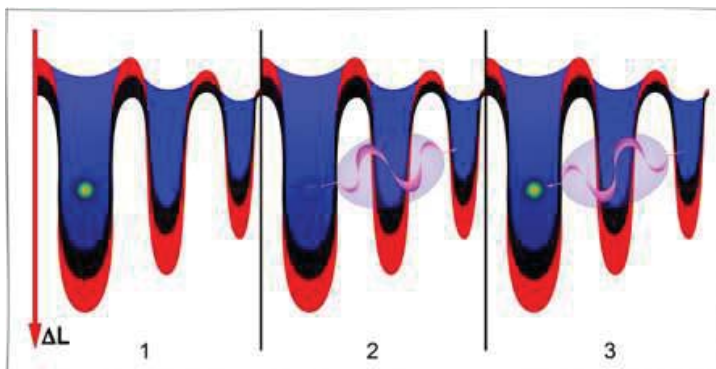

This extremely unstable, boundary state of matter is manifested, first of all, in the constant transition of matter from one qualitative state to another, which are related to the constant absorption and photons emission of gamma radiation upon the transition of matter from one qualitative condition to another and back.

The appearance of the second material body (in the occult literature called the etheric, which in itself is not correct) is the starting point in the birth of living matter. The first living organism is a virus, which is an RNA molecule surrounded by a protein membrane, the evolutionary development of which led to the emergence of many life forms, including intelligent ones. The intelligent life appears, naturally, *at a certain level of the ecological system development*. And, as can be seen from this brief explanation, **the Lord God** just "has nothing to do." Life and the Mind come into being as a result of the natural development of matter without any of His participation. The evolutionary development of life proceeded from the virus to a bacteriophage, from the latter – to single-celled organisms. The unicellular evolutionarily were divided into two "evolutionary arms" – plant unicellular organisms and carnivores. Unicellular plant organisms began their evolution synthesizing the organic substances necessary to maintain their life through the absorption of sunlight, while carnivorous unicellular began their evolution, absorbing already finished organic matter, industriously created by plant organisms. *Therefore, the latter, without the former, just can not exist*. Evolutionary development proceeded by creating colonies of the same type of unicellular organisms, which were interconnected by their runners – sprouts of their cell membranes. After some lapse of time, their "runners-sprouts" intertwined so much that they were no longer able to free themselves from the "embraces" of their neighbors, and a voluntary colony of unicellular organisms turned into their prison – a rigid colony of unicellular organisms, where each cell got a "lifelong residence permit" without the right "to move", almost like a registration in the former USSR. In rigid colonies, different single-type unicellular organisms were found in different external conditions. Unicellular organisms that found themselves inside the colony were surrounded on all sides by other unicellular organisms, which thus became their natural protection, while external unicellular organisms were directly affected by the external environment, which often was very aggressive. I think that this explanation is easier to understand than the one we discussed in previous chapters.

Having appeared in different external conditions, undergoing various external effects-chemical and radiation-in identical single-celled organisms of stiff colonies, different biochemical changes began to occur that ultimately led to the appearance of cells in the hard colonies that looked different, and began to perform different functions in the interests of the entire rigid colony. So there were multicellular organisms. Multicellular living organisms are rigid colonies of unicellular organisms performing various functions for the sake of survival, both themselves and the entire colony as a whole, a kind of "collective farm" created by nature.

Now let me remind you that every virus, a unicellular organism has the **SECOND MATERIAL BODY**, which is an exact copy of a physically dense virus, a unicellular organism, and is built out of "building material" of other organic and inorganic molecules trapped in the "zone of attraction" of the helices of **DNA** or **RNA** molecules. Therefore, at the second planetary level, the second material bodies of unicellular organisms of a rigid colony create an identical rigid colony of second material bodies that intertwine with each other just as the unicellular organisms of a rigid colony intertwine at the physical level. A rigid colony of unicellular organisms is called a multicellular organism, and unicellular organisms of this rigid colony are cells of a multicellular organism. I would like to draw your attention to the fact that each cell of a multicellular organism is an independent living single-celled organism, which is part of a rigid colony of unicellular organisms. So, the rigid colony of the second material bodies is what people call the *Spirit, Soul, and Khatybov called it the Brain.*

Evolutionary development of multicellular organisms led to the appearance of the third material bodies (astral) in the living organisms, which, in turn, create a rigid colony – the third **material** body of a multicellular organism. The Spirit, in this case, is a system of two rigid systems – a rigid colony (system) of the second material bodies of cells and a rigid system of the third material bodies of cells. In the future, we call a rigid colony of unicellular organisms a **PHYSICAL DENSE BODY**, a rigid colony of the second material bodies is the second body, a rigid colony of the third material bodies is the third body of a multicellular organism, etc. **The second, third, fourth, etc. bodies of multicellular organisms FORM THE SPIRIT.**

Depending on the evolutionary development of a living being, his Spirit can consist *of one body – the second body, of two – the second and*

third ones, of three – the second, third and fourth material bodies of the multicellular organism. Therefore, when the first material body (physically dense body) dies, the Spirit consisting of the second, third, etc. material bodies becomes free of its rigid "attachment" to the physical body. And if we consider that they are the result of the evolutionary development at the level of the second, third and fourth material bodies, it gets clear why people in a state of clinical death see their physical body from the outside and are able to think, feel and be aware of themselves. ***The "throw off" of the physical body does not mean the death of a living being. This is an extremely important concept.*** The Spirit that has two or more material bodies becomes stable and does not perish with the death of a physical dense body. The only thing that happens when a physical dense body is lost is ***the slowing down of evolutionary processes.*** Without a physical body, the Spirit finds itself as if in a "frozen state" and is not able to develop further. For the further development of the Spirit, it needs a new physical body, which the Spirit makes growing when entering the fertilized egg at the time of conception. And everything repeats itself again. Rather, it all repeated again... But today the process of moving Spirits is stopped and replaced by a somewhat different "process" of which the reader is to know later.

As follows from the above, the first Spirits appeared in viruses as a consequence of a certain spatial organization of very ordinary atoms, and **ANY SPIRIT IS MATERIAL, ONLY FORMED BY THE MATTER OF ANOTHER FORM.** Thoughts are also material. Only this is "another" matter, which does not correspond to the usual for a "normal" Man concept. The same can be said about the Dark Matter Generator in "**SvetL**" Programs – it's "another" matter. A man is not able to feel radio waves or radiation, but, nevertheless, radioactive irradiation kills, and with the help of radio waves food is prepared. Therefore, to talk about what is primary – matter or consciousness has no sense, because consciousness is material and, by affecting "ordinary matter with consciousness, you can change the matter. Both these concepts are interrelated, interchangeable and make up one whole ... This is just like a physicist studying atoms is just a bunch of atoms studying themselves.

To save **your** Spirit from destruction, there is a short advice: ***do not do to others what you would not like to be done to you.*** If a "normal" Man keeps to this rule, he is likely to escape "hell." The punishment for a sin a man

gets at the time of committing the sin, and not after the death. The changes taking place at this time in both the physical body and the Spirit are real processes at the level of the physical body, the second, third (and so on) bodies of the Spirit. And again, the **Lord God has nothing to do here**. After the death of the physical body, there is an energy release that opens as many qualitative planetary barriers as many bodies the Spirit has. If the Spirit has developed two bodies (the second and third) – two qualitative barriers are opened, etc. In other words, the Spirit finds itself at such an evolutionary level, which it has reached when developing in a given physical body.

At the moment of conception, the Spirit enters the biomass, which genetics corresponds to the evolutionary level of the Spirit. This happens automatically, so in this **case the Lord God "did not hold a candle"**. Therefore, nothing accidental or undeserved happens. The seeming injustice arises due to misunderstanding of what life is. Every **PHYSICAL BODY** for the Spirit **IS A TEMPORARY CLOTHING**. If a person, having committed a murder, changes his suit, he does not become innocent. The crime is committed not by the "suit", but the "wearer" of the suit (or, as A. Khatybov put it, the "wearer" of the shirt) – the Spirit of this physical body...

When creating the "Dark Matter" Generator **N. Levashov** used the initial matter, which **EVERYTHING SURROUNDING US** consists of, **INCLUDING US** ourselves. For "normal vision" primary matter is invisible, if only because we can see quite a little. Our eyes react only to the optical range, which is an insignificant part of the range of electromagnetic oscillations, not to mention everything else. Primary matters become visible only after the evolutionary transformation of the Brain or **after you are lucky to have been taken to the Bath. SOMETIMES** these abilities are more or less **MANIFESTED AS A NATURAL GIFT**. Natural gifts can be compared to a diamond that, without proper finishing will never become a diamond. Then the whole thing "stops" at "finishing", that is, again, taking **the Bath**.

The only thing that can be said at the conclusion of this paragraph is that if you possess true knowledge and understanding of the ongoing events, then there is all probability of correctness of your actions. From my point of view, only **IGNORANCE OPENS THE WAY TO EVIL**

3.6. Hair

It is hard to put into few words new philosophy, physics, astrophysics, physics of micro- and macro world, evolutionary biology, genetics, psychology (etc.) in order to be "taken" to the **Bath**. But if you still want to get there, then let's go on studying the object to be taken in the **Bath**. Or, as you have already guessed, – you yourself.

After *N. Levashov "has taken me to the Bath"*, I realized that in order to solve the problems existing in our world, first of all we have to recognize that many of our basic conceptions about reality are erroneous. It might happen that the main part of the solution looks at us every morning from the mirror, and we do not see it. For example, what is our hairstyle – is it personal preference, is it fashion or convenience?

Everything has its own strictly defined function, which contributes to the proper functioning of the body as a whole. Each part of the body has **ITS OWN CAUSE FOR EXISTENCE**. But before getting to studying hair, try to answer at least one question, given below, for example, regarding curly hair.

1. Why there is curly and not curly hair
2. Why more men have curly hair than women.
3. Why hair is curly on other parts of the body.
4. Why curly hair is "valued" more and attracts more attention.
5. Why some nationalities (genotypes) have thick hair?.
6. Why there are more Jews with curly hair.
7. Why hair turn gray with temples.
8. Why hair on men's body is not always curly.
9. Why hair on the public is always curly.
10. Why hair on the body and chest is often curly.
11. Why men have curly hair on their heads more often.
12. Why women like to have curly hair.

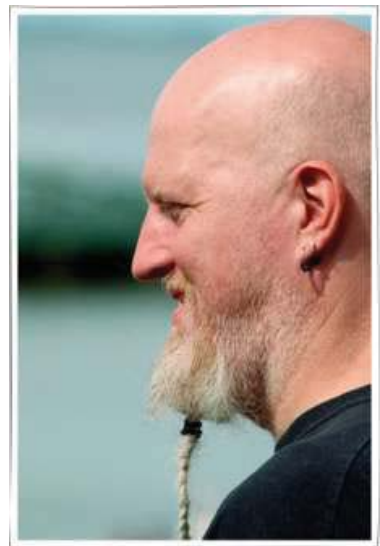

Of great importance is hair at an early stage of Human development. ***They act like antennas for receiving primary matter.*** That is, long thick hair maximizes Man's energy. One can draw definite conclusions about the fact that girls in the primary classes develop faster, because their hair is not as often cut as boys'. Human hair, including the vegetation on men's face, not only directly supply the Brain with information, it also "radiates" energy and information. This is a kind of feedback from the Life Support System and the Control System. And to be more precise, ***the electromagnetic energy is radiated by the brain through the hair into the environment.*** This was confirmed and determined with the help of the well-known **Kirlian effect**, when a Man was photographed first with long hair, and then after the haircut. It was confirmed that when hair is cut, the "reception and transmission" of signals to the environment is significantly hampered. Women with long hair, for example, bearing a child, rarely suffer from toxicosis.

A plait falling down the spine ***is a special accumulator of energy potential for a woman.*** A woman with long hair has such a powerful energy that is able to create a protective ring for her beloved man, protect him with her energy from any ills. By the way, a husband receives additional protection of his wife, when he combs her hair. But this has not been practiced lately. Everyone ran to beauty parlors!

The color of the hair depends on the amount of arsenic in it. The more it is, the darker the hair. A person, who has experienced a very great grief, is advised to have a haircut done quickly.

You should not cut your little children hair. There is such a belief that ***"a baby must have its hair cut off when it is 1 year old."*** However, this **PREJUDICE IS FAR FROM BEING HARMLESS.**

There are many who believe that hair must not be dyed in any case. And they are right. And here is an example of one of the arguments: the color of objects is the result of the waves absorption processes. The red vessel looks red because it absorbs all other colors of the light ray and reflects only the red one. When we say, "this cup is red," we actually mean that the molecular composition of the cup surface is such that it absorbs all the light rays, except the red ones. So, our hair has a certain color. As you know, there are no pure colors. Shades of hair are diverse and very complex. Hair absorbs energy flows of the certain wavelength. And they absorb exactly the energy that is

NECESSARY for **YOUR ORGANISM**. What happens when you dye your hair? Your organism begins to receive **STRANGE ENERGY**. And what is the result? You are right – diseases. So *a hundred times think whether to dye your gray hair*, whether it makes you look less beautiful. By the way, real Frenchwomen, who are considered to be the ideal of style and taste, have never dyed gray hair. But if you really feel like dyeing it, completely denying modern chemical dyes, you can use natural.

It is known that each hair consists of 14 different elements, including gold. The presence of this element in the human hair is not random. *Women have 5-6 times more gold in their hair than men*. And gold is obtained from uranium isotopes. What is usually considered a stable element in Mendeleev periodic table is actually an isotope. In total there are 24 variants of "stable isotopes" in gold. Life time of each is more than **4000 years**. *Gold until 2012 served as a mark* for identifying people who had to be always under the Control System, as you know from the previous chapter. This includes rings, chains, medallions, earrings, gold embroidery and so on, that is, those things that are worn with "joy" by both women and men.

In humans, reverse communication (control results) is carried out through the cerebellum as a structure – concentrator using antennas (hair). Now the process is changed, but this is the subject of another talk.

In North America, Indians remove the scalp, thereby removing the antenna and depriving the Brain of the ability to transmit and receive anything. There is evidence that the "custom" to remove scalp was common among many European nations.

You should not have a wrong judgment about the "neediness" or "uselessness" of hair in general. Hair, on the one hand, has its origin (growth) as **WASTE OF BRAIN METABOLISM**. So they are not superfluous. If you lost hair, this does not mean that its conditionally-root system is eliminated. It can be restored. And "SvetL" Programs cope with this task, and rather successfully. In the absence of hair, the conditional-root system performs the same function, only with an extra load.

**Table "hair location" for both men and women
(in comparison, for those who do not know)**

	In men (normal)	In women (normal)
--	-----------------	-------------------

Grow bald	From the forehead or temple	Thin hair on the head
Head	+	+
Neck (back)	+	-
Mustache	+	- to old age +
Beard	+	- to old age +
Underarms	+	+
Arms	+	-
Chest	+	-
Back	+	-
Pubis and crotch	+	+
Bottom	+	+/-
Legs	+	+/-

Such hair location is well known, and those who wish can check. How to check, I hope everyone knows, and we will not focus on this. The main load on receiving the energy-information Brain translation and getting a contact state with the Control System is laid on two states of the Brain: **ANTINEUTRINO** and **NEUTRINO**, both in a **NON-INERTIAL STATE OF ENERGIES**. These two states of the Brain have no vegetation at all. In this regard, the main flow of incoming information *does not depend on the density of the head vegetation*.

Now let's see what is in the projection under the hair besides the head.

In men: the reproductive system – the prostate, bulbourethral glands, the conductive ways. That is, the coat is not where the sperm is formed, but where it passes.

In women: the uterus, cervix and conductive ways. That is, not where the egg "lives", but where the spermatozoa move before coming across it.

In both – underarms lymphonoduses, the beginning of an arm. As protection from scattering "radiation", flow, is formed (converted) in the lymphonoduses, and the hair on the arm is also a protection when the flow moves to the palm. *The palm has no hair at all. This is a radiator.*

A man has more hair (protection is better, radiation is higher). Women with fluffy hair do not lag behind – they have high radiation, too.

Legs – likewise: the sole without hair is a radiator (or absorber); the leg with a coat is protection against scattering, in men it gets stronger to the beginning of the leg (where it grows from), in women – on the contrary – it gets weaker (hair is only on the shin, as a rule, but there are exceptions). Lymphonodues are also important: groin nodes in men "catch" less scattered

flow, in women – more scattered. If you remove hair – little will get to the coccyx, and there will not be anything to pass further. Here even the **Bath** taking will not help.

Men – hair is on the back, chest and lower abdomen. On the back – in the horizontal direction, on the shoulders – widely, its quantity varies greatly in different people, on the chest and abdomen it is along the central line. On the front – in the projection of energy centers, a protective coat from behind is not strong, but protection against scattering throughout the back (the back is difficult to control).

The head: it is under the coat in men and women – the Brain is there, but the Brain of some (especially men) requires curly (more reliable) protection. Men have a mustache and beard, which protect what in women radiates, as information about the state of the flesh. Women do not have protection from outside absorption, but men have. Everyone has a forehead open – both men and women. But getting bald begins from the top of the head (radiation centers). It is true, some people – from the forehead (a special case).

In general, women have less hair on the body – less protection, but more absorption from the outside. Men are better protected from all sides as a whole.

Children are without a coat of all kinds (except for the head, and not all have it since birth) – and therefore they manifest all kinds of "paranormal" abilities. With age it goes away (a coat is formed, which restricts on both sides).

Baldness is a consequence of radiation or a reason to radiate more effectively. Both ways are possible. Baldness comes with age, when there is what and by what to radiate. But this is without taking the **Bath**.

And do not be sad! Measures to restore hair have already been taken. And this is not the clinic "Real Trans Hair". These are "**SvetL**" **Programs**, and there are positive results. In certain circles there is such a joke: "Bald head is a suede with a hair coat inwards». Take this with humor and do not bring yourself into an inferiority state!

Mechanism. Since protection weakens with the hair removal (women think that it is more beautiful and shave – but it is wrong), it means that the essence is in the hair, or in what they create. A girl's plait along the spine (the antenna protection and its work improvement) – the hair "will sift the trash». And the signal will come to the spine in its pure form. Why is curly hair better

(more reliable) than straight? It takes more space, filling it evenly. It is like a filter – the amplifier of frequencies. Then with the age and development of a logically decreasing coat – a larger frequency range becomes "necessary" for processing. I have repeatedly said that this is where **"SvetL" Programs** will do you good, if you are their User. In general, the conclusions are obvious – ***if you want to make friends with your head, make friends with your hair!***

3.7. To wash or not to wash?

Everything is clear with the hair. Now the question arises: ***"To wash or not to wash, and if to wash, then what with?"*** Because, as I believe, and not only I do, there might stick together not only hair. At one of my meetings with Levashov in Moscow, I do not remember on what occasion, I touched upon this matter. He laughed for a long time, and then told me quite an instructive story that I remembered and then retold it many times when answering the questions of the readers. After the end of the Great Patriotic War, according to the calculations of our "allies", the population of our country was to decrease by ***at least 2 -3 million people in two years***. Due to what? Due to the lack of medication for the wounded who returned from the war from hospitals after surgery (meaning purulent wounds, lack of antiseptic drugs, etc.), as well as through epidemics of diseases because of the poor living conditions in the war-destroyed towns and villages. The anti-sanitation, which was present everywhere, was supposed to contribute to this. But it somehow **DID NOT HAPPEN**. Moreover, post-war birthrate broke all records, and children were



born healthy and were prone to diseases (especially dermal) many times less than now, in our time. So what's the secret?

The secret is that **THERE WAS NOT ANY SOAP** in the country, but the **LAUNDRY ONE**. Everyone washed, washed underwear and baby diapers with laundry soap. Hair and body, as well as wounds were washed

with laundry soap. And this was sufficient so that there were no diseases, infections and epidemics, which "our friends" – allies hoped for. Ask your grandparents about it. They will tell you a lot of interesting things about this soap. And only in the fifties the industry began producing kind of soap, using flavorings and chemicals. I think that it is already clear to the readers why this happened. Today try to buy a real laundry 76-72 percent soap! Soap of 72% at my request was found only in Belarus. But the shampoo "Wash and Go", known as a "Running Louse", you can buy everywhere.

I get many letters in which readers of **N. Levashov and A. Khatybov's asked about the "cold nuclear synthesis"**. What is it, and how to "feel" or "see" what is produced with its application. Touch, smell and look – the **LAUNDRY SOAP – this is the product of the cold nuclear synthesis.**

Of course, of great interest is how this "works" and is used in the Bath taking process. There is a concept of hydrogen ions "negative logarithm of the concentration in solution», or **pH**. Skin **pH** is **5,82-6,48**, alkali **pH** is – **6,96-9,64**, acids **pH** is – **3,52-5,64**. This parameter is well described. It is an indicator of a living cell satiation with a potential. **PH** range for human cells is **6,88-7,45**. This range can be narrowed due to various diseases. **Cells pH** varies during the day, there are a lot of factors of change in the value of **pH** – *they are consumption of energy, food digesting, nervous stress, etc.*

Soap (only laundry) is not intended for pleasant soaping of "convexo concave" parts of the body followed with the washing off, but for the bacteria neutralizing (removing the metabolic potential from bacteria and unicellular). In this case, there is no need *to be soaped for more than 1 minute* – the skin gets excess potential, preventing normal metabolism with the body.

Cold water has **pH 6,58-7,12**, which replaces the acidic solution. The same water at a temperature of 50°C has **pH 7,24-7,56**, so even in the bath you have to take a cold shower (rub with snow). Residents of southern regions (Italy, for example) do not have the opportunity to steam in the snow, so there for the removal of the catalytic effect there are creams, acid-based pastes (**pH 5,5**). In the regions of Russia there is no need to use such pastes and creams as there are natural regulators (water, herbs, snow). In Russia, testicles and breasts (bulges and concaves) and hair on the head, by the way, first washed with strong alkaline solution (alkali), and then, after washing off – with kvass (acidic solution) and additionally – with snow.

However, there is a minor phenomenon – *when frostbitten – they have always been softly rubbed with snow*. In this case, there was a soft recovery of **pH**. **pH** of frost-bitten skin is **4,21-4,39**, and this corresponds to **pH** of weak solution of hydrochloric acid. Snow at temperature -12°C has **pH** **5,20**, and at the initial stage of soft rubbing the skin restores to the normal, here you should not use strong alkaline solutions (alcohol, soap) – you can get a burn and local neutralization of skin conductivity.

Summing up. Before going to take the **Bath**, you have to find and buy *a laundry soap at least of 72%*. Having bought the soap, you have to keep it carefully and store it so that it would not be eaten by the mouse, if they are in the house, since the mice are very fond of this soap. You have to soap yourself with competence. Efficiency is achieved only when no more than 60 seconds have elapsed since the moment of soaping to the moment of washing off. It should be remembered that in your hands you have the **PRODUCT OF THE COLD NUCLEAR SYNTHESIS**, which does not and cannot exist either in Europe or in other parts of the world. And you should be proud of this because few from those regions will be taken to the **Bath**.

3.8. The error of thinking

I will allow myself to reflect a little in the style of **N. Levashov**, the more so I am completing **the third volume that he had started**. I want the reader not to get tired of the "mountain" of new information that has fallen on him (not always easily perceived at the first time). Everything that is written and described here, you can accept of in a different way. You can take, or you can not take, even on trust. This is the choice of each one. But, in my opinion, **TO CONSIDER IT – IS ADVISABLE**. I have long been convinced that the majority of people (not only considering themselves to be clever, but really very intelligent, capable of discussing most difficult scientific, mathematical, philosophical subjects) very rarely can understand the simplest and obvious truth. The truth, that admits that their own judgment about the subject may be wrong; that judgment that they have made, sometimes with great efforts, which they are proud of, which they have taught others, on the basis of which they have arranged their life. In my opinion, the most common and annoying mistake of most people's thinking is preconception.

Preconception is a tendency to notice, select, take note, approve and remember only the information that confirms an already existing opinion, hypothesis, principle, etc., while rejecting, ignoring something completely, not taking into account and forgetting information that goes against all this. It has long been observed that if a person is presented facts and arguments that do not fit into his already existing picture of the world, then the first, almost instinctive reaction to them is *mistrust, rejection, ignoring and throwing out of the memory everything connected with them, even if they are important and can be really useful for a person*. With this, my working team and I constantly come across in relation to "SvetL" Programs and everything that is somehow connected with this. Especially after N. Levashov's gone. The hidden motive is very simple: everything unaccustomed sharply breaks the sense of inner harmony and hits hard the self-esteem of the person, whereas the awareness of rightness and correctness gives pleasure and adds self-confidence.

- **preconception** – is the lack of a desire to change one's point of view;
- **preconception** – is a firm belief in one's own rightness, based on long-established stereotypes;
- **preconception** – is groundless self-righteousness;
- **preconception** – is the ability to form a pre-negative opinion about everything in the world;
- **preconception** – is the ability to ignore all information that does not fit into a clearly defined framework; it can also be said otherwise:
- **preconception** – is when a person is looking for and, what is characteristic, finds evidence only of what he already believes, completely ignoring everything that can shake this faith;
- in the **language of physics**: the information that comes into our head has a great amount of inertia. In **common language**: if a person believes in something, then *no matter how much you rub his nose in the refutation of his beliefs nothing will come of it*.

This applies to the full extent to those people who make various attempts to use N. Levashov's name for their small purposes. They repeat the mistakes of people who consider themselves smart and consider everyone else to be fools. I do not blame them, although it is sometimes unpleasant. I do not try to

convince them of anything. I am convinced of one thing: they will not be taken to the **Bath**, no matter how much they try to get there.

And since we are talking about the object that is supposed (or not supposed) to be taken to the **Bath**, in an appropriate healthy state, **I am giving you an example. MOST PEOPLE ARE ABSOLUTELY CONVINCED** of *medical science* being constantly developing (moving forward with leaps and bounds, implementing nanotechnology, etc.), medicines getting better and more effective, and getting help only in the relevant institutions (clinics, hospitals, medical centers, etc.). However, few people are able to think of the fact why, if everything is so good and progressive, the mortality from the most awful diseases grows steadily from year to year? Accordingly, the demand for drugs and medical services is also increasing like an avalanche. And this is when it must fall steadily. If the advertised achievements of medicine were really worth of anything, then the number of cases would have to have fallen. **But it is growing.** But nobody wants to notice it and take it into account. I'm not talking about any alternative to this process in relation to "**SvetL**" Programs, but for the period of their application, which is **more than 6 years**, we can confidently say that when the Programs "face" serious diseases (and there are quite a lot of such examples), then, with rare exceptions, for some reason (?) **the Programs** win. All this is directly related to the preconception in question. It's a vice. It can not be named otherwise. This vice has many different names-synonyms, which is due to the fact that it was noticed and described by different people, until they came to the generally accepted term. One of the most known is the "*Semmelweis reflex*", *i.e. reflexive rejection of new knowledge that contradicts to existing norms, habits or paradigms*. There are also such names as "selective thinking", "tendentious selection of facts", "mental constipation".

IT IS POSSIBLE to explain **TO THE PERSON SLOWLY GRASPING THINGS** most tricky things, if he has not made up any idea about them yet. But you can not explain **THE PERSON MOST QUICKLY GRASPING THINGS** the simplest thing, if he is firmly convinced *that he knows, undoubtedly knows, what is explained to him.*

Chapter 4. Description of the object to be taken to the Bath

*Everything began with Man,
With Man it shall end.*

*But a physicist, a doctor and others
studying atoms – they are just small heaps
of atoms studying themselves.*

Man by himself synthesizes (creates and recreates) the reality of his existence, guided by his own knowledge and his conception of the world. From this follows a natural conclusion that ***our conception and effective knowledge create, or make the World***, and not the other way around, as "modern" science believes. Observing and studying the World, we have to find the laws that move the world. In other words, everything that the World we live in is endowed with is the inner essence of ourselves, and therefore life is the creation of our own hands. But in order to comprehend this, you have to investigate those "spare parts", the knowledge of which will allow you to feel more comfortable in the **Bath**, and after "taking" it you can make a conception of everything that surrounds us today, what is happening around us and even more. But the main thing, why this way and not another way?

Until now, there is not a single theory that satisfactorily describes all the principles of the human body work except those works that are left to us by **N. Levashov and A. Khatybov**. One can assert with relative certainty: there is a **COMPLEX, MULTIFUNCTIONAL SYSTEM** called "**MAN**". Just to understand: inside this system there is another system – ***the control system*** that compares the current configuration of the body and the effectiveness of performing these or those functions with a certain "standard" (you can call this system, at least part of it, the system of identification – "friend-stranger"). Perhaps this is the immune system. "Perhaps, – think those who are interested in it, – and perhaps, – not only the immune system". Where is that individual "chamber of measure and weight" – nobody knows. It is quite possible that the standard changes from time to time, and does not remain constant throughout life. Of course, all this is desirable to be understood, and especially when you get convinced of the hopelessness of getting any help from doctors who are unable to decide or

give advice on how to correct one or another health problem. **At the first stage** of understanding this I can give you a simple advice – you have to read more, without having any aversion to anything. Even the most stupid and naive books sometimes contain thoughts, advice and recommendations that can bring you to a completely different level of health. It's not a rule, but it happens. Well, **in the second stage**, I still recommend you to take the path that is specified in this book. Is it complicated? Perhaps. Is it not clear? I admit so. But this is the way of knowing yourself, but not religion and dogmas that you are constantly being stuffed, and not only in medicine. There are no norms and standards in health.

Health is not the subject of the organized medicine. *Medicine is busy with diseases*. So, this is the medicine of diseases. And it is supposed to be medicine of health. Don't you see the difference?! Are they colleagues?

4.1. Simplified fundamental block-diagram of the Human body functioning

Before moving further in our conception of the "washing" process, let's be defined in terms and terminology.

Cells are consumers. Consumers, as the name implies, always consume something. In order for the consumer to consume, it is necessary to target (address) the delivery to the consumer from the warehouse of what the consumer can consume. That is, it is necessary the address the distribution of "sealed packages" (you can call them containers) with a certain content specific to each kind/type of consumers (you can call it food).

Kidneys and the gall bladder are the food production shops.

The liver is the containers production shop.

The production of containers entirely depends on the work of the catalyst production shop (housewives call this catalyst iodine). It should be specially noted that the catalyst produced by the thyroid gland, and the one that the health minister produces today, is not the same (as heaven and earth). In the production of the catalyst in the thyroid gland, regardless of the state of all other body systems, the **CONSTANT** temperature of **36,6°C±0,06** necessary for the production of lubricants (**Mg²⁺**). is maintained (as in the manufacture of high-precision instruments. Only the

presence of such a lubricant ensures that there is no friction in the vessels when moving.

The intestine is a warehouse.

The pancreas (PC) is a regulator of the dimensions, weight and contents of the containers that are discharged from the warehouse. The **PC** can often be imagined in the role of the warehouse manager. The **PC** is under special control and can not be operated. To put it simpler, without the **PC** – Man can not live. Everything depends on the **PC** operation – all the metabolic processes, the Brain feedback, the production of address labels for the containers (insulin), control of joint nodes, etc. Each container is designed for a specific cell, and no other cell in normal operation can capture another's container and, especially, change its labeling.

Especially about insulin. Out of many structures that form glucose, medicine has identified only one – insulin. Insulin is a catalyst, but **IT WORKS ONLY IN A LIVING ENVIRONMENT**, and its structure is formed by the Brain. If we isolate insulin and try to examine it in the laboratory, we will see *a dead matter* with the remnants of potentials and magnetic impulses that are living out their days in the lack of connection with the Brain. This is similar to the fact when a blood sample taken from a vein is examined under a microscope – it has passed through sepsis and is no longer the same living blood that is in the veins and arteries.

Insulin is not just a catalyst. By the Brain commands, the pancreas produces exactly the insulin that is necessary at the moment. Therefore, insulin should not only correspond exactly to the genotype – even the Brain should be able to control this catalyst, otherwise the containers delivery addresses will be undefined.

Artificial insulin is an artificial catalyst; – that is the structure that does not have connection frequencies with the Brain. Each new portion of artificial insulin reduces the cells' life. The Brain can not intervene in this process, since the control absence makes it impossible to do anything.

If the insulin production is reduced **to 80% of the norm**, then this is the pre-diabetic state (part of the containers do not have addresses and clog the ways). With **40% decrease of the norm** in the insulin production a team of "Tajiks" (artificial insulin) is invited, who label the containers with whatever comes to hand. With **33% decrease of the norm** in the insulin production its production ceases altogether, the "Tajiks" are dispersed, and a person lives **NO LONGER THAN THREE DAYS**.

Blood vessels are the ways of cargo delivery, i.e. "rails". It is clear that the movement of the "train" depends both on the curvature of the rails and on the relief of the way. When moving uphill, one must have several steam locomotives, and one is sufficient when moving downhill. Imagine a tube with a liquid around which a wire is wound. If a current is run through the wire, the liquid (with all its contents) starts moving. This is how the whole circulatory system is made. By the way, it is now clear why you have pins and needles in an awkwardly bent leg or your arm is often "gone numb" when **IN SLEEP** you put it over your head.

The lymph system is an underpass with traffic lights and control points.

The brain is a dispatcher, i.e. a computer center, a system that specifies the beat time.

Lungs are a power generator for the entire system. (The lowest bow to **G.N. Petrakovich**, the higher qualification surgeon, laureate of the Russian Physical Society Prize (1992), author of journals JRPHT (Journal of Russian Physics Thought) and Russkaya Mysl (Russian Thought), author of a collection of scientific papers in the field of biophysics, geophysics and astrophysics (cellular bioenergetics, the theory of respiration, nuclear reactions in a living cell, natural and artificial human hypobiosis, bioenergetic fields and molecules-piezocrystals in a living organism, time as a physical factor in the Earth noosphere, the author of the discovery of "the generation phenomenon by any iron-containing substances of animate and inanimate nature – mega-high-frequency ($\sim 6 \cdot 10^{18}$ hz) of electromagnetic field..." (1992)). Unfortunately, I did not know him, but I have read his works, having made sure that they "intersect" with the works of N. Levashov and are very close in terms.

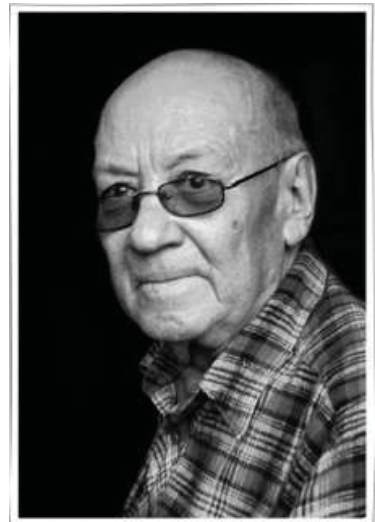

G.N. Petrakovich

The heart from those ancient times, when medicine discovered it, is considered an autonomous organ working without the Brain accompaniment, which simply drives blood through the human body. In fact, contrary to the generally accepted point of view, **THE HEART DOES NOT**

DRIVE ANYTHING IN THE HUMAN BODY. The power that the heart develops is sufficient only for its own work. And what, then, drives the blood? Cargo. You have just read about it above – where the question was about blood vessels.

The heart is the switchman at the traffic lights. The heart rate is set by the Brain, which, in turn, **GETS ITS BEAT FROM THE ATMOSPHERE GRATING.** The beat comes to the atmosphere grating from the Earth's colliders and is consistent with the structure of metabolic processes in the body. The right auricle is the assembly chamber in a container. This is a kind of magnetron, where with a beat of *about 1 sec. food packing into the container takes place.* After packing, the container enters the left auricle, from which it is further directed to the "labeled" address. All these systems operate under the Brain control and only the Brain, which has all the necessary frequency ranges and control functions.

So, there is a supply structure that has its own power station (providing power for all electric trains carrying containers), a dispatch room (with a traffic schedule, delivery schedule, containers loading, etc.), a branched track system, a garbage depot in the form of rusty axles, wheels from old steam locomotives, etc. The timetable is made up in advance. If the train is formed once a day, then you have time to sleep. If the trains have to be formed every hour, you have not only to form the train, but also to coordinate all the trains, adjust the balancing, lubricate the axles, check the availability of cargo, select the electric locomotive and clear the tracks on time. If such a schedule **is designed for 100 years**, then it becomes possible to earn on the side. For example, instead of boxes with cans of black caviar, you might be palmed off on a box of green peas (at best) or a rusty wheel – the total weight will remain, but the recipient might be outraged. The schedule can not be broken, therefore, if there is a shortage (at the entrance control), the container's weight "is loaded in addition" from the warehouse. The container may have the wrong viscosity or the wrong size, then the beat delay takes place (in medicine this phenomenon is called arrhythmia), and the pancreas urgently makes a replacement from the warehouse. If the general schedule is broken, in case of a major shortage, the whole container has to be replaced and another container has to be taken from the warehouse, produced half a century ago. Untimely delivery of electric locomotives, improperly packed cargo in the container, leakage from the container and a lot of other troubles can also result in the schedule breaking (**in arrhythmia**). We should

especially note that in such a supply structure, all services, in contrast to medical presentations, operate in the same rhythm.

What immediate conclusions follow from the above? If there is an arrhythmia, it is not necessary to blame the heart and start digging over it. You can not eat only **black caviar**; – it is not good for replacement. Similarly – you can not eat **only grass**. Before performing an operation on a Human, it is necessary to have a **DETAILED ANALYSIS OF HIS BRAIN FREQUENCY WORK**.

And now it is worth considering the *biological aspects of unscientific knowledge of Man, which science gives us today (or rather, from the Horse's point of view, as A. Khatybov liked to say)*.

4.2. Spine and other wonders of Nature

From the point of view of modern medicine, **the spine** is necessary for a person to give bearing when visiting nightclubs, as a post (similar to a fence) to hold the nerves tracts branching through the organs, to store excess memory (not fitting in the head), and also for dividing the upper and middle (the pelvis area) parts of the trunk so that they do not change places. It is known the pentagram role in the environment design, **as well as the number 7, so the basic division of the spine from the skull is 7 + 12 + 5 + 5**. The division is completed in the coccyx, which can, like with all normal mammals, be continued with a beautiful tail. So that not to confuse a person with mammals, in medicine it is customary to call the spine below the ribs "pony tail". In this case, the rights are equalized, and it **makes no sense separately to look for the continuation of the coccyx**.

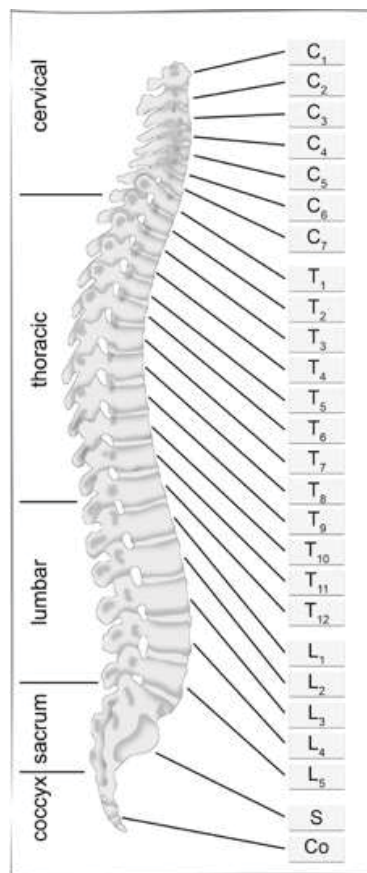

It is known that between the vertebrae a hernia can be formed, which spoils one's life. In addition, it is known that the nerve nodes that start from a particular vertebra are connected with a certain organ, although they have no direct relation to the spine.

Well, here's how it all really is. When developing in the womb, *the coccyx appears the first, then the vertebrae "crawl out" alternately*, hence, it is more correct to start counting the vertebrae from the coccyx (the pyramid base) and end with the skull – the pyramid top, and not vice versa, as in medicine. Let's consider some features of the spine structure, without comparison with medicine (not to hurt doctors' feelings).

The spine structure exactly corresponds to the information musical series and the musical series of the control system **(12 + 12 + 8)**. **A total of 32 vertebrae**, which corresponds to the complete sign system of the control of the information and control fields. The 15-degree magnetic pulse vector turn exactly corresponds to the 15-minute interval of its change.

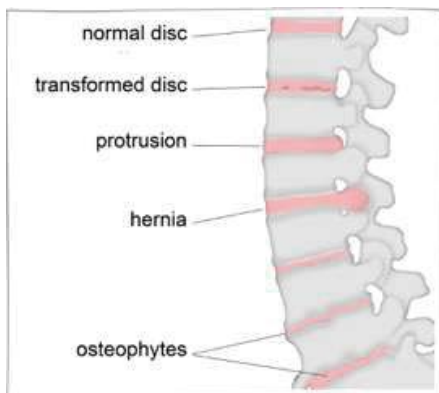

Each vertebra is individual. There are no exactly two identical vertebrae, and for each Brain genotype, the vertebra resonance contour differs. It should be noted that *the vertebra is an ionic lymphatic sediment*, the contour of which is formed by the vertebra itself, links it with the adjacent vertebra *and forms all the links*. Actually, the vertebra is not only a "power" circuit, but also a high frequency resonator, and each vertebra is for its own tone. There is no and can not be a rigid binding of the resonant circuit to the organ. In time, the vertebra structure changes, the magnetic pulse frequency beat "floats", and by their connection with the organs the vertebrae can change places. All these positions of *possible changes are "laid" in "SvetL" Programs*, which "make" the Generator of "**SvetL**" **Complex** correctly respond to these changes.

The role of each vertebra is individual. In the figure, the tones of the vertebrae referring to the Control System, the informational field and "**SvetL**" **Complex** resources in cooperation with the information field are conventionally given.

Notice, when you open your mouth when landing in the aircraft, this does not mean that you equalize the pressure, you change the resonant circuit. The same occurs with the vertebrae – in case of disturbances in the beat frequency (for example, with vertebral transmutation), the resonance circuit changes, i.e. an additional ionic structure is formed, which is usually called a hernia. However, while you can close your mouth then, the hernia can not be removed that easily, you will have to be operated on.

The musical control series is built on the octave DO-NA, and NA tone is extremely dangerous. With appearance of such a tone lately (in individual Brain genotypes), there observed a sharp visual acuity decrement, retinal displacement, color mixing and eye fixation shift, etc. When the magnetic pulse electrical potential reaches 21%, the resonator is unlocked and its operation is stopped, which automatically leads to the death or the Brain disconnection from the ionic structure. Naturally, there is no question of any bathing process. I note that in these cases, "SvetL" Programs are "POWERLESS". They can only provide "COMFORTABLE" LEAVING THIS WORLD.

The information series is based on the English system (12th) and is well known in music circles. If, for example, when listening to some musical work recording you suddenly want to urinate (you can then repeat the listening to make sure that this is happening at the same place of recording), it means that there is a resonance in frequency with the vertebra connected with the urinary bubble. The Brain receives the appropriate signal and commands the execution.

The coccyx specifies the type of Diogenes spiral (the spiral, "Diogenes Barrel" – we have already considered)¹⁷. Each vertebra is tuned with regard to the coccyx, so the coccyx damage is extremely dangerous, and when visiting a bath, it is advisable to put a felt mat before sitting on the sweating shelf.

The control system operates in a triad. The total triad is equal to 18 axes of symmetry; in the spine they are all present (8 + 5 + 5 vertebrae), of which **DO and NA are the original or double symmetry, 10 vertebrae of the information structure – normal, or complex symmetry, and 6 vertebrae of the control system – fractional symmetry.**

^{17 17} See BOOK 2, CHAPTER 2.10.

Note that there are no instruments for measuring fractional and double symmetry systems frequencies, but within the framework of using "SvetL" **Complex** this process is carried out constantly in the mode of "testing" both forthcoming planned changes in the organism of the Complex owner and the "programmed" – within the framework of today's change of the people's Life Support System.

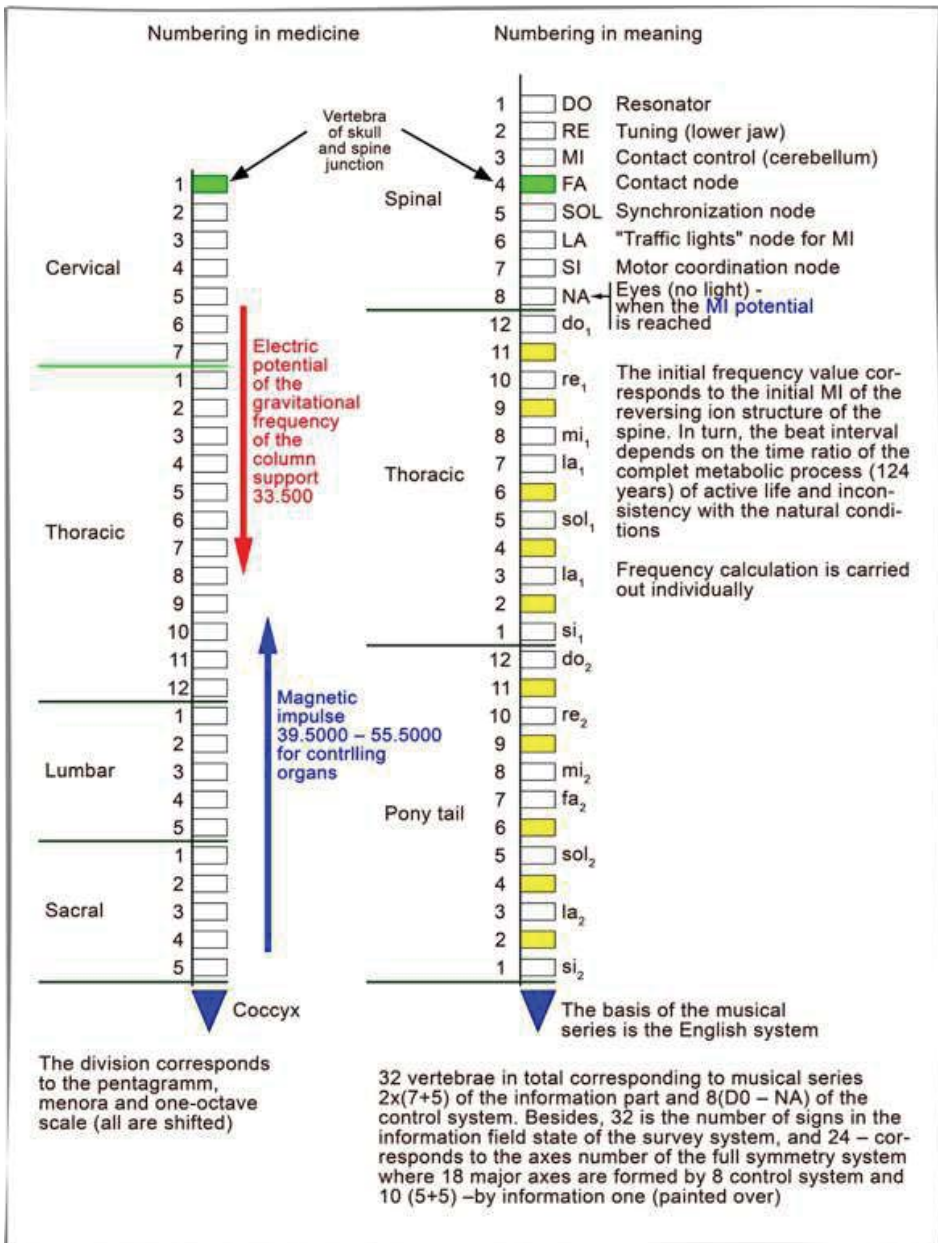

Fundamentals of piezoelectric elements with non-inertial mass and their oxygen balance

The existence of a non-inertial mass (the structure of octaves above 64, integrated by octave 96) modern science does not even suspect of, although the ball lightning and its action have been known for a long time, as I have already mentioned. With octaves above 64 there are 8 different atomic structures (further *they are given conventional names – neutron and antineutron, neutrino and antineutrino, etc.*). Here I am going to tell you why the **new Complex "SvetL"** was created with the use of a silicon wafer, calculated in a golden section, and what "made" us do it.

The role of **piezoe crystals** (as one of the types of piezoelements) in information control systems is great. **Piezo crystal** is a variety of quartz and silicon (polycrystalline silicon). It is generally accepted that silicon (quartz) is crystalline silicon dioxide SiO_2 one of the main minerals of the earth's crust. Natural crystals of silicon are from sand grains to several tens of centimeters size, there are crystals of 1 meter or more



size. **Polycrystalline silicon is "grown" in crystals of a given shape and then cut into wavers of the given size**, depending on the application. The quartz crystal structure is formed of SiO_4 tetrahedral: the cation Si located in the center is surrounded along tetrahedron by four cations O, and each O ion, by coupling tetrahedra, is linked with two silicon ions. The SiO_4 : tetrahedra along the main axis are located in the structure along the helical line (right or left spiral). The absence of planes at the center

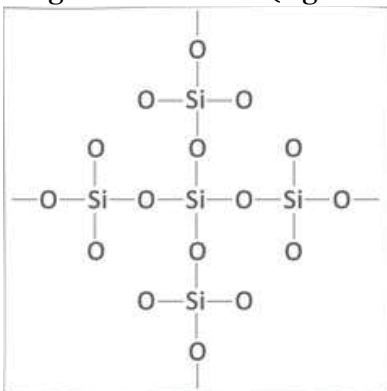

of symmetry in silicon and quartz crystals causes the presence of piezoelectric and pyroelectric properties. In ordinary quartz glass, tetrahedra are linked at random, and the basis of polycrystalline silicon are dodecahedral structures of the inner grating of the silicon itself. This was taken into account and applied in the "installation" of the **"Dark Matter" Generator** (in N. Levashov's terminology). The knowledge of

these processes made it possible to find the "carrier" of the Generator that is optimal in form and application, to develop and make a radically new "**SvetL**" **Complex** with expanded resources. Let me remind you that human muscle tissue contains $(1-2) \cdot 10^{-2}\%$ of silicon, bone tissue – $17 \cdot 10^{-4}\%$, blood – 3.9 mg / l. With food in the human body there comes up to 1 g of silicon daily.

Piezomagnetism (for complete understanding)

The appearance in a substance of a spontaneous magnetic moment upon the imposition of elastic vibrations is called the piezomagnetic effect. Piezomagnetism can exist only in antiferromagnets and ferromagnets and is fundamentally impossible in para- and diamagnetics. The thermodynamic consideration of the matter of piezomagnetism is based on the isolation and study in the expansion of the thermodynamic potential of **N** terms linear in the magnetic field \mathbf{H}_i and one of the components of the elastic stress tensor σ_{jk} :

$$\Phi = \Phi_0 - \sum_{ijk} \Delta_{ijk} H_i \sigma_{jk}$$

If all the transformations of the magnetic symmetry of a given crystal leave at least one term in the expression invariant, then the corresponding coefficient Δ_{ijk} (the piezomagnetism module) is nonzero, and a piezomagnetic moment appears in the crystal.

$$m_i = - \frac{\partial \Phi}{\partial H_i} = \Delta_{ijk} \sigma_{jk}$$

Symmetry analyses made it possible to find all the classes of magnetic symmetry that approve piezomagnetism. They turned out to be **66**, and the type of tensor Δ_{ijk} was found for all of them.

Due to the symmetry of the tensor σ_{jk} piezomagnetic tensors can be represented as **3x6** matrices, and the number of such matrices is **16**.

Ferromagnets include: **Fe₂O₃**, **FeCo₂**, **MnF₂**. Antiferromagnets: **CoF₂**, **FeF₂**.

It can be seen from the formula that, in addition to piezomagnetism, there must exist an opposite effect: linear magnetostriction, in which the components of the strain tensor are linearly related to the magnetic field. The

sign of linear magnetostriction, as in case of piezomagnetism, depends on the sign of the vector L characterizing the formed domain state of the sample. All efforts were directed to understanding (transforming) the process of changing the cubic grating into a dodecahedral one through the search for a specific carrier of the "Dark Matter" Generator at its maximum efficiency. And these efforts proved to be a success.

Piezoelectrics (the basis of "SvetL" Complex)

Substances in which, under certain elastic deformations (stresses), electric polarization arises even in the absence of an electric field (direct piezoelectric effect) – these are piezoelectrics. A direct piezoeffect is the reverse piezoeffect – the appearance of mechanical deformations under the electric field action.

Piezoelectric properties were detected in more than **1500 substances**. Piezo-effects **ARE OBSERVED ONLY IN CRYSTALS** that do not have a symmetry center. When other symmetry elements appear (as a result of mechanical deformation), the piezo- effect can either disappear or remain only in certain directions.

Oxygen series of the piezoelement

It is known that **an oxygen series is: 16, 18, 20, 22, 24, 26, 28**. However, this series should be divided into 2 groups:

- basic series: 16, 18, 20, 22 (oxygen);
- alternative series: 22, 24, 26, 28 (nitrogen).

The table of the composition of atomic structures:

№	Name of the atom	Oxygen				Nitrogen			
		16	18	20	22	22	24	26	28
1	Proton	1	1	1	1	1	1	1	1
2	Antiproton							1	1
3	Gravitational	4	4	4	4	4	6	6	6
4	Anti-gravitational						2	2	2
5	Neutron	2	2	2	4	4	4	4	4
6	Antineutron	1	1	1	1	1	1	2	2
7	Neutrino	2	4	4	4	4	2	2	4
8	Antineutrino	2	2	4	4	4	4	4	4
9	Electronic	4	4	4	4	4	2	2	2
10	Anti-electronic						2	2	2

As can be seen from the table, ***the initial state of any inertial mass, possessing such a distinction as the process of atom-antiatom charge transfer and vice versa***, is inherent only in nitrogen compounds, but this name has oxygen and fluorine. Inconsistency in meaning introduces confusion and distorts the information sense. ***The dodecahedral structure***, which is the basis of any piezomagnet, **CAN BE BUILT ONLY WITH THE PARTICIPATION OF ANTI-ATOMS**. A single-type structure (consisting only of atoms or only of anti-atoms in one type of field) **CAN NOT CHANGE ITS STATE** because of the lack of potential to change the state even by mechanical destruction or deformation (the sum of charges always remains constant). In the other case, in the presence of different type structures, the sum of the charges, or the total charge equivalent, depends on the mutual orientation (the direction vector) and the spatial arrangement of atoms-antiatoms bonds. To make it simpler, the question is about interaction within the limits of **"SvetL" Programs directly** with the Brain neurons.

The basis of biostructures on the Earth are electron atoms ***having octave 54 of beat frequency***. This property is known in the Cosmos, therefore all biostructures created on other planets must intersect by transmutation with octave 54 (see A. Khatybov, "The Basics of the Biosphere", N. Levashov, "Inhomogeneous Universe"). Besides, all so-called UFOs are equipped with units for destroying octave 54 by superposing the electrical potential. However, for the Earth there is no and can not be an electron atom with a pure octave 54 – **NO BACKING OF LIFE-SUPPORT SYSTEMS**, on the one hand, and on the other – it would be taken as a weapon. Therefore, during transient processes (the transfer of biostructures to the Earth), the principle of telescopic transmutation is used, described in the works of N. Levashov and recommended for your own careful study.



man in a different way depending on his genotype. Proceeding from the

recent "research", it became more than obvious that the optimal carriers of the "Dark Matter" Generator and, accordingly, the main platform for the "installation" of the Generator in "**SvetL**" **Complex**, today are the wavers (made in the calculation- given sizes) of **iron** (a certain grade of steel), **polysilicon** (the crystal is grown under certain conditions and then cut into wavers of specified sizes), **silver and platinum**.

N.V. Levashov used to draw my attention to this subject. Under his leadership, back in **2011**, I made "experiments" mounting generators on these materials. But then the correct decision for the production of these carriers was not found (due to a number of non-public reasons), and as a basis for the Complex (as a platform for the Generator's "carrier"), **a tablet PC** was used, the working chip of which was made of polysilicon. The main resonant "pad" of the Complex, built on this design, was the touch screen of a tablet PC in cooperation with the generator mounted on a silicon platform.

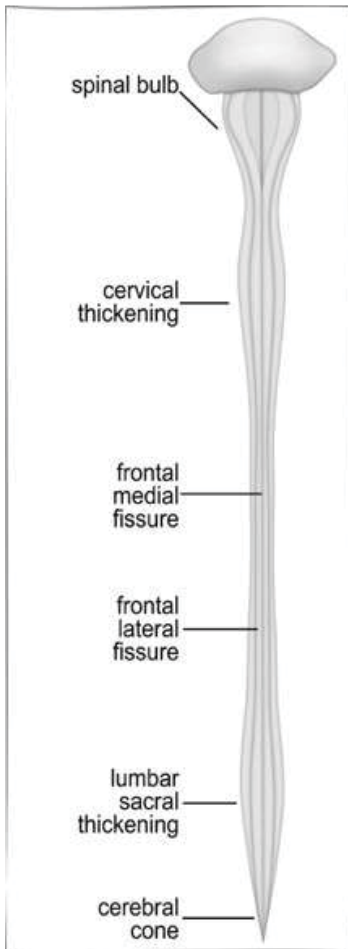

The reader already knows that **the construction of all atomic structures** follows the pattern: **highly organized plasma → material body → liquid → gas**, that is, the sequence of octaves ((128) → (126-74) → (72-66)) → (64) → (62-34) → (32-28) → (24-26) → (22-16). **Octave 64** is a material structure. This is a kind of pyramid (not in form, but in content). The top of the pyramid is **octave 128** (atomic structures of all living things, from octave **128 to 16**). All the rest is built without beat, but octaves are 84-16.

There are no particles without a charge – just there are no devices for measuring the charge or there is no environment for its manifestation. There are no and can not be devices **in the environment of octave 64** to measure the characteristics of structures in **128-16** octaves, in which the Generator of "**SvetL**" **Complex** "works". Therefore, the "work" of the Generator is impossible to be fixed with anything, although there are many who would

like it. You can **ONLY FIX THE RESULTS OF THE GENERATOR'S WORK!**

All atomic structures are interconnected – each is inside of a certain grating. The Brain (octave structure **66-72**) is formed like honeycombs.

All calculations in atomic structures are made only in *fractals of the golden section in the 12th number system*.

A FIELD SHOULD HAVE A CARRIER – if an electric, then – electron, if a financial one, then – measure and so on. *A field without carrier does not exist, no matter what theory is hidden behind.* But both in atomic structures and in our environment, there is only one field – electrical, and it is its properties *in various 96 octave of states, 64 sliding angles in each octave, 18 variants of impulse transmission and so on – in combinations, are perceived as other fields.*

The generator of "Dark Matter" (Psi-Generator) must have a carrier (its working platform). A generator without a carrier does not exist. The most optimal carrier (platform) for the Generator, created by **N. Levashov, are iron, silicon (polysilicon), silver and platinum** (wafers made of these materials). The generator can also be placed on a "platform" of another "material", but the effectiveness of its work will be commensurate with the capabilities of these materials. There is no concept of "to switch on or switch off the generator no matter whatever "codes", "Programs" or "Modules" whoever said. The generator either exists, and then it works, or it does not exist, and then it does not work.

All the "impacts" and transformations realized by **"SvetL" Complex** take place at the level of the **NONINERTIAL MASS**, and this is the Brain function and the spinal Brain along with the spine as the "receiving-information" antenna.

How, Who (and what) creates the Generator, and also in what way it "is installed", I made my point clear in my essay **"The Mirror not of His Soul"**.

"Tuning", adjustment of the impact power on the owner of **"SvetL" Complex** and other resources (public) of both the Generator and the Complex are set forth in the "Instruction to the Complex" compiled with **N. Levashov's** guiding. The detailed capabilities in the application of **"SvetL" Complex**, as well as **"SvetL" Programs** in the ongoing events, I have

outlined in the published collection and articles under the rubric **"Knowledge from Na_chala" (Knowledge from the Beginning)**.

Basics of piezoelectrics biology

Piezoelements have never been considered as an integral part of ionic biostructures.

In medicine there is a concept of "salt deposit", this deposition appears, as a rule, in old age, but there are cases when similar salt deposits appear in babies. Medicine considers such deposits to be foreign inclusions and tries to remove them. But each salt deposit is formed of the ionic structure, which is a "continuation" of the lymph. And, together with the existing ionic structure (bone), such a salt deposit forms a resonator, complementing partially lost bone functions.

1. The human bone skeleton

The human bone skeleton is **328648 structures**, some of which are completely formed on an ionic basis. The remaining part is a kind of reserve and is transformed into ionic structures if necessary. A Human has no unnecessary (not functional) details. Each element of the structure performs several functions, and the perfection of a Man is determined not by the forms of the external ionic structure, but exactly the reserve that can be used to maintain the necessary ionic form. Each bone in a Man is a **RESONATOR OF THE RELEVANT FREQUENCY**. The bone ionic structure is sufficiently known. Besides those properties that are known to medicine, the bone is an information channel, that is, its structure is such that "tunnels" and passages in the bone structure are not just resonators, **but "cables", through which information flows**. Today, "to put right" these information flows, if they are for some reason destroyed, broken or distorted, is possible only by "taking" **the Bath**. The narrowest point is the junction of the bones. Cartilages, along which the bones "roll", is the most complicated complex, including elements of inertial or ionic mass, and by their nature and structure, they are close to the Brain. What does this mean? The complexity



of the transitional process between the bones and small space brings to the existence of two factors. **The first** is the property of a 100% transfer of the information flow and **the second** is not a violation of the time factor (hence the complexity of the spatial construction).

Let's consider the first factor. The structures of the resonator (bone) and cartilage are different. Direct transmission of the information flow without loss and distortion of information is impossible. Hence, there is a way of transforming this information, and such that its restoration in another resonator is not a problem. All transformations **TAKE PLACE AT THE LEVEL OF NON-INERTIAL MASS**, and this is the Brain function, and therefore it has been shown that the cartilages possess the Brain function. **The second factor is the principal one.** The transmission beat interval of the information flow **CAN NOT BE BROKEN**, otherwise irreversible processes may occur at the point of beat interval breaking. The beat interval in cartilage is always equal to the beat interval of that bone, out of which the information flow comes. Thus, *the cartilage has two beat intervals*

Energetically **a Man's organism is well balanced, and all electrical potentials of both gravity frequencies and magnetic pulses frequencies can not be changed in the formed organism.** Then at the expense of what do nails grow, for example?

We live not on a meteorite, but in the Noosphere, and the information flows that run through a Man leave a "trace" in the form of specific additions to the existing potentials, and a part of these "additions" is used to transform the non-inertial mass into ionic structures. The defining Generator is the spinal cord. Let's pay attention to the fact that nails grow only on fingers and toes, nothing grows out of coccyx (unlike mammals). Consequently, the throw off the potentials is from the Brain to the periphery, and the role of the coccyx is special. **THE NON-INERTIAL PART OF THE COCCYX IS THE RETURN GENERATOR** of the pyramid type and it serves to loop the information flow in the main information center – the spinal column. I am noting once again that the **MAN HAS NOTHING UNNECESSARY.** Therefore, the ribs that *supposedly serve to protect the lungs and the heart*, in fact, act as a potential-limiting device with a closure to the main energy node-the solar plexus (remember *N. Levashov's advice: "... Mentally create an energy ball in the solar plexus region and drive it inside your body through your arms and legs... "*). The absence of such a restrictor would bring to an unlimited growth of outer

potentials in the body. In contrast to the spine bones, where there is a strict dependence on the resonant frequencies of each vertebra, the remaining bones perform other functions no less important than the functions of fixing the outer information.

2. The human muscular skeleton

From the point of view of modern medicine, the muscular skeleton is intended solely for the transmission of motor functions to the bones. Having blood vessels, the muscular skeleton is more convenient for taking blood for analysis, rather than if these vessels passed through the bones. It is generally accepted that the more muscles, the better.

From an unscientific point of view, the muscular skeleton of Man is the most complicated complex. And the question here is not in the names of muscles and their structure, but in the properties of an individual muscle in terms of **PROTECTION OF INFORMATION FLOW**. The thicker the muscle, the less protective function it performs, in addition, in places of muscle thickening, information flows are of no value. The blood vessels, their composition, structure, and the composition of the filler (of the blood) are described in my articles "**Knowledge from Na_chala**" (**Knowledge from the Beginning**). Here I want to note once again that blood is **NOT THE INFORMATION CARRIER, BUT ITS PROTECTION**. And what is **the function of protection?** **Firstly**, to prevent the dissemination of the information flow by fixing the transmitting nodes. Here **Complex "SvetL"** is sure to help, if it happens. **Secondly**, the screen is formed around the information flow thanks to a special arrangement of blood vessels, the lymph of which forms the muscle tissue between the vessels. The screen beat frequency is compatible with the beat frequency of the initial electron atom at **54.62506250 octave**. Naturally, the beat frequency in the "**SvetL**" **Complex** is also compatible.

Muscles are not a perpetuum mobile, and therefore are subject to change. There are ways to keep the muscles in working condition. But the main problem for muscles *is the muscle sepsis*. Muscle sepsis is formed in connection with the superposition of beat and carrier frequencies of the screen and the outer environment. It should be noted that as a result of sepsis, the ionic structure loses its non-inertial mass and turns into ordinary sand, which in future fills vital organs – the kidneys, bile ducts, intestines, etc. "Sand" is, of course, a conventional name. But the structure obtained as a result of muscle sepsis has, like sand, **32,000000 octave** of the beat gravitational frequency.

It should be noted that with age, muscles become flabby. This does not mean that the information flow is left without protection. It is necessary to calculate the relative values of the screen-flow, which will help determine the sensitivity. With age, the sensitivity increases, so the response to external changes is adequate.

Biopiezoelements are structures formed in case of cartilage sepsis. We already know that each bone (including the vertebra) is a resonator of a given frequency and the corresponding musical tone – information or control. The fields beat frequencies are determined by the electron atom, and the carriers – by the characteristics laid in the specific Brain genotype. This has already been mentioned.

In case of muscle sepsis and the protective screen break, the cartilage sepsis automatically arises. In addition, an unprotected information flow changes the resonator structure, shifting the carrier frequencies. This shift should be compensated for something. It is compensated by the formation of cartilage sepsis and the formation of a biopiezoelement to synchronize the new frequency with the subsequent information flow transmission without distortions.

Biopiezoelement is a structure containing non-inertial mass, as a battery for the operation of the ion structure of the piezoelectric element proper. While spending the non-inertial mass the biopiezoelement transforms into an ordinary piezoelement (in medicine it is called "**salt deposition**"). If the biopiezoelement is in a general structure of the information flow, it does not interfere with the organism, since the electric potential transferred from the non-inertial mass exceeds the electric potential obtained by mechanical compression of the biopiezoelement. In addition, in relation to the given angle sliding for the information flow, the transferred and "mechanical" potentials have opposite values, their superposition also determines the sensitivity or quality factor of the circuit.

On the other hand, the biopiezoelement is like a trigger, where the direction switching depends on the type of the applied potential, so the information flow goes in both directions. An ideal biopiezoelement can be considered an element which magnetic impulse beat frequency is compatible with the electron atom standard. As the non-inertial mass is consumed, the trigger turns into a diode, and the information flow comes across the "barricade" on the route.

The piezoelement effect is known – the generated electric potential (sufficiently dense with heavy compression) neutralizes the magnetic impulse electric potential, causing instant coma along the entire path of the magnetic impulse. The brain reacts to this condition with a pain syndrome. In medicine, there is a convincing explanation for salt deposition – ***salt rubs against the nerves and scratches the bone, that is why there comes pain and numbness.*** The biopiezoelectric element is formed only on the path of the magnetic impulse.

It is not difficult to guess why **Users of the Complex** have the pain gone in the shortest possible time. But it should be emphasized that if there is already a clear Brain absence or there is a clear rejection of the **Bath** (there are such ones), then **this process is significantly "dragged out"**.

4.3. The lungs as one of the spare parts

The term "breath" is used to refer to those processes by which animals and plants consume oxygen, give off carbon dioxide and convert energy into a form available for biological use.

The specialized organ should have a thin wall (the membrane of this wall must be semi-permeable) so as not to interfere with diffusion. It must always have a wet surface so that oxygen and carbon dioxide can be dissolved in water and, finally, it must be well supplied with blood.

With indirect breathing, gas exchange between the cells of the body and the environment includes two phases – the external and the internal. External respiration consists of the gas exchange by diffusion between the external environment and blood by means of a specialized organ, for example, the lungs in mammals. Internal respiration is the gas exchange between the blood and the body cells. The transfer of gases between these two phases is carried out by the circulatory system.

Let's follow the path of oxygen molecules entering the body. Air enters through the outer nasal apertures, or nostrils, which lead to the nasal cavity – a large space located above the oral cavity and below the Brain. The nasal cavity contains the organ of smell and is covered with epithelium separating

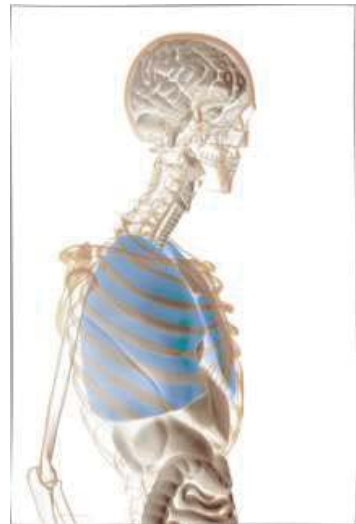

the mucus. Passing through this cavity, the air is cleared of dust and warmed. When the nasal cavity capillaries excessively expand, bringing to excess mucus formation, a running nose appears (in case of an official getting a bribe, the nostrils expand without a running nose).

From the nose air passes through the internal nostrils, or the choanaes to the pharynx, where the tracts of the digestive and respiratory systems cross. Food passes from the larynx into the stomach, and the air goes farther through the larynx and trachea. So that food should not fall into the larynx and trachea and not damage the tender membranes covering these organs, with every ingestion of food, the opening of the larynx is covered with a special cartilage called an epiglottis. Fortunately, this happens automatically, and we do not have to remember every time when we swallow that it is necessary to close the epiglottis. Occasionally this automatic mechanism lets us down, and the food gets "to the wrong throat".

The larynx (sometimes forms an external projection – Adam's apple) contains vocal cords – epithelial folds, which, when air passing between them, vibrate, producing a sound. The tension of the vocal cords is regulated by special muscles, which make it possible to produce different high-pitched sounds (when tapping on an Adam's apple a characteristic sound of a bottle glass is made).

The trachea, or throat, can be distinguished from the esophagus by the cartilaginous rings that are inside its walls and do not allow it to subside. During inhalation, the air pressure in the trachea is below atmospheric pressure, and without cartilaginous rings it would be squeezed.

At the level of the first rib connection to the breastbone (counting the ribs from the coccyx), the trachea branches into two cartilaginous bronchuses that go into the lungs. The bronchus branches into the bronchioles, which, in turn, re-branch into ever narrower tubes leading to the terminal cavities-the alveolar sacs. In the walls of the thinnest bronchioles and alveolar sacs are the smallest cup-shaped cavities, called alveoli, surrounded by a dense network of blood capillaries.

The walls of the alveoli are thin and moist (pre-impregnated with C_2H_5OH), which allows the gas molecules (all known and unknown gases) to easily pass through them into the capillaries. According to rough estimate, the total area of the alveoli through which gases can diffuse is more than 100 m², that is, 50 times more than the skin surface.

The walls of the trachea and bronchi consist of an internal epithelial layer, an external connective tissue layer and a middle layer containing cartilaginous rings and smooth muscle fibers. In a person suffering from asthma, these muscle fibers are greatly reduced, which causes a narrowing of the lumen of the small bronchi and makes breathing difficult.

The epithelium contains ciliated cells. Beating of cilia occurs continuously in one direction, and when solid particles, for example, dust particles enter the moist surface of the epithelium, they are delayed by the mucus secreted by the epithelium, and the ciliary beat carries them back to the pharynx. This is an important mechanism for protecting the body against inhaled bacteria (some bacteria also have cilia).

As the bronchioles and their branchings narrow, their walls become thinner, the cartilage layer disappears, and the ciliary cells are replaced by a flat epithelium.

The walls of the alveoli consist of only one layer of flat epithelial cells. It was assumed that the alveolar epithelium was also single-layered, but studies using an electron microscope showed that it consists of two layers – the alveolar epithelium and the endothelium of the capillaries, which separates the air in the alveoli from the blood. Between the alveoli there are supporting strands of elastic connective tissue. This gives the lungs such elasticity that if you immediately puff them out of the animal's body through the trachea like a balloon, and then open the trachea hole, then they, due to their elasticity, compress and push the air out.

The lung is provided with both motor nerves going to the smooth musculature of the bronchi and bronchioles, and sensitive nerves branched throughout (it is known that if this nerve is dipped in curare (a strong poison), the rest may not be considered).

Each lung, as well as the inner surface of the chest cavity, in which the lungs are, is covered with a thin layer of smooth epithelium called pleura. Both pleura leafs are always moist, which reduces friction when the lungs move in the chest cavity when breathing. The pressure in the pleural cavity (between two pleura leafs) is usually less than atmospheric (in some cases, the lungs can be swapped).



The lungs, by virtue of their elasticity, tend to move away from the chest wall, as a result of which a partial vacuum is created in the chest cavity.

With inflammation of the pleura, its epithelium secretes fluid that accumulates in the cavity between the lung and thorax. This condition is called pleurisy. In case of severe tuberculosis, sometimes it is necessary to cause an abate in one lung to provide some rest to infected tissues. This is achieved by piercing the chest wall and letting sterile air into the chest cavity. As a result, the lung abates due to its own elasticity.

Mechanics of the breathing process

It is necessary to clearly distinguish breathing as one of the basic vital functions, that is, the gas exchange between the cell and the environment, which consists of **three phases**: the external respiration, transfer of gases by blood and the internal respiration. **External respiration** is a mechanical process of filling the lungs with air (inhaling) and pushing this air outward (exhaling).

Since the blood of the pulmonary capillaries continuously removes oxygen from the alveolar air and gives carbon dioxide instead, the need to change air in the lungs is obvious. In Man, the cycle of breathing, consisting of inhalation and exhalation, is **REPEATED 15-18 TIMES A MINUTE**.

In Man and other mammals, the structure and interposition of the ribs, chest muscles and diaphragm provide greater mobility of these elements, which allows arbitrarily increasing or decreasing the volume of the chest cavity. When it needs to be increased (inhaling), the intercostal muscles contract, pulling the front ends of the ribs up and forward; such movement is possible due to the "hinged" connection of the ribs with the spine. At the same time, the diaphragm forming the bottom of the thoracic cavity contracts and becomes less convex in its upper part, which also increases the cavity. Since the space of the chest cavity is closed, this increase in volume brings to some decrease in pressure in the lungs, and when the pressure drops below atmospheric, the outside air rushes through trachea, bronchi, alveolar sacs and alveoli. When exhaled, air is pushed out of the lungs due to the elasticity of the lungs and the weight of the chest walls (as debtors in the casino). During inhalation, the lungs, as they are filled with air, are stretched. After relaxation of the intercostal muscles, the ribs get the chance to return to their initial position, and the simultaneous relaxation of the diaphragm

leads to the fact that under the pressure of the organs located in the abdominal cavity, it again takes a domed shape. As a result, the volume of the chest cavity decreases, which allows the stretched elastic tissue of the lungs to contract and push out the air that entered the lungs when inhaled.

During muscle work, the passive relaxation of the intercostal muscles and the diaphragm is not fast enough for the air to escape from the lungs until the next inhalation begins, and this reduction in the volume of the chest cavity is done by contracting the muscles. In addition to the muscles that raise the ribs during inhalation, there is a second group of muscles which fibers go at right angles to the first ones. These muscles lower the anterior ends of the ribs, thereby reducing the volume of the chest. The chest wall muscles also contract, causing the abdominal organs to press upward onto the diaphragm and then further accelerate the elastic compression of the lungs.

When breathing, the walls of the chest cavity never bring pressure on the lungs and do not squeeze the air out of them. Reducing the volume of the chest cavity only allows the lungs to contract due to their own elasticity. Coughing and sneezing are forms of the enhanced exhalation, in which, due to the vigorous contraction of the muscles of the abdominal wall, the organs lying in the abdominal cavity press on the diaphragm, sharply reducing the volume of the chest cavity and rapidly pushing air out of the lungs.

Trachea, pharynx and other respiratory ways do not perform any active muscular function in breathing; they serve only as conductive channels. In some cases, when closing the larynx lumen, there have to be made an artificial hole in the neck to allow air to enter the trachea. Breathing movements after this go normally. The air pressure in the lungs varies with each respiratory movement.

In the intervals between inhalation, exhalation and subsequent inhalation, the pressure is equal to the atmospheric pressure, since the external air and the air in the lungs freely mix with each other. When the inhalation begins, the air pressure in the lungs decreases by 1-2 mm Hg. which brings the air to the lungs. By the end of the inhalation, the incoming air equalizes the pressure. At the beginning of exhalation, the elasticity of the lungs compresses the air contained in them; its pressure becomes 2-3 mm Hg. above the atmospheric, and as a result, the air comes out of the lungs. By the end of exhalation, the pressure, of course, returns to the level of atmospheric pressure. This knowledge is enough to "breathe" on the

Complex "SvetL" (you can also sweat) with problems with the lungs or the respiratory system.

I gave you a **WELL KNOWN POINT OF VIEW OF ANATOMICAL PATHOLOGISTS AND MODERN SCIENCE**. It maybe a bit long for non-specialists, but exhaustive, in my opinion (or rather, in their opinion). But in order to take the **Bath**, you have to have some other point of view. I'll try to make it short, but intelligible.

The mechanics of the breathing process (an alternative point of view)

Every Man has an aura. This aura is created by all the body cells and this is **β -decay** (the reaction of metabolic processes). The same reaction is in the lungs. The lungs activity is controlled only by the Brain, neither muscles nor ribs can move independently without control. **THERE IS NO CHAOS IN THE ORGANISM**, it appears only in the lack of the Brain. No Brain will allow the inhalation of a mixture not intended for breathing. The pressure required for inhalation and exhalation, is created at the Brain commands, that is why when exhaling under water or inflating balloons, etc. the pressure in the lungs is much

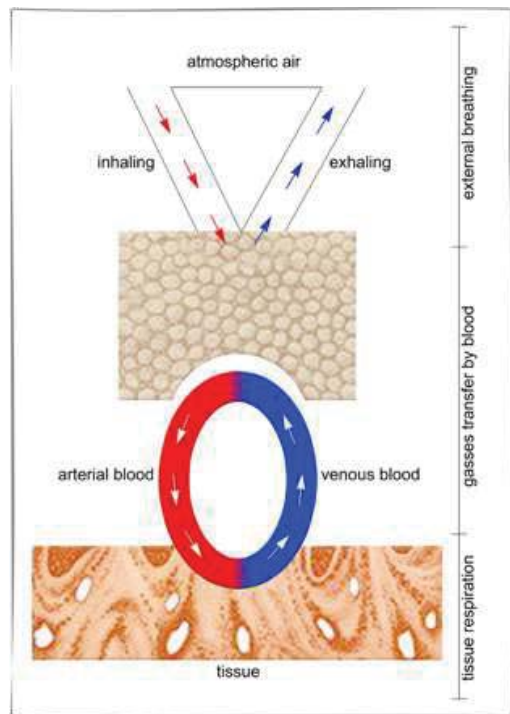

higher than the atmospheric pressure (it can be 1.43 times higher). The entire breathing system is conventionally divided into 3 parts.

1. Control of the inhaled mixture

All that is attributed to the upper part of the lungs, in addition, has a non-inertial mass. **THESE ARE TRITIUM CONTROL SYSTEMS**. If tritium does not have frequencies for which the Brain is tuned, the air

mixture into the lungs is not admitted. There passes only what can be processed.

2. The lungs memory

This is an automatic system tuned to the frequency that is the base for the Program. (Until recently, the Program was brought in at Easter, now this point is changed). The brain sets the upper and lower limits for the base and the limits of quantization for the remaining frequencies. **An example:** if the base frequency is **71,450,450**, and the limits (upper and lower) are respectively equal (**148% and 12%**) to the potential density, then the frequency that was used before bringing in the Program (**67,450,450**) have limits (**88% and 33%**) of the potential density, and the doubling frequency (**66% and 48%**). *If there is no base frequency, then the Brain makes a decision to remove potentials from the electronic layers of tritium of the organism cells, which brings to the cells dehydration. **HERE NO MEDICINE WILL HELP YET.** The owners of the "SvetL" Complex* the indicated base frequency is in line with a wide range of available frequencies of the **Complex** interacting with the owner's Brain. And in this case there will not be any cells dehydration. This has already been confirmed by the experience of using the **"SvetL" Programs.**

3. Interchange system

The main element of the air mixture is tritium, which has three electronic layers (1, 7, and 16) and with which we have already dealt¹⁸. All gravitational (8 gratings) outer layers have a potential density less than 2%, so when weighing the air, tritium is not detected (in practice, this is a non-inertial mass). Spectral analysis also does not reveal it, since there are no radioactive frequencies. **In 2007 OCTAVE 71 WAS "SET"**, and exactly it occupies the upper electronic layer. The next two layers are octaves 67 and 61. By the way, water also has a grating of octave 71. Inter change processes take place with the decay of tritium and the formation of oxygen (non-inertial) with the base octave preservation. *For a non-inertial mass there are no barriers, the decay is accompanied by appearance of a new isotope of tritium, which is called oxygen.*

Separately existing pulmonary circulation is designed to form all metabolic processes, while **the blood plasma pH** should always be in the range of **6.88-7.45**. Note that the plasma **pH** varies from **0.5 to 8 sec**. The

¹⁸ Book1, Chapter 5.2

brain marks this change, and when the value of the lower limit is **+0.26 (pH = 7.14)**, there takes place an automatic response for the intake of the next lot of the mixture. In lethargic sleep, this limit can be reached in a month that is why in this sleep there is no ordinary breathing. **The SvetL Complex** monitors these processes and, if they fail (for some reason or other), "helps" the Brain to control

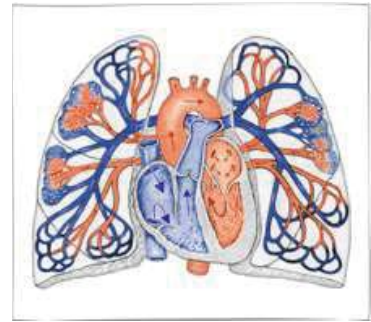

the response for the mixture intake, because the artificial breath holding results in the fact when the interchange processes are performed with other layers of tritium, but there are other ratios of limits there. The location of all lung structures is defined functionally with respect to the non-inertial masses of the control and interchange systems. Of course, the lungs can not be moved (swapped), you can not put into any foreign objects, shunting the action of the non-inertial mass. Here illnesses are not considered. Because if there is no base frequency, there are millions of diseases, some of them are known to medicine (tuberculosis, pleurisy, ARI, and so on). There are no and can not be any recommendations for treatment – you **ONLY NEED TO KNOW** if the Control System has placed the matrix that contains frequencies introduced in line with the Program, or it has forgotten about you and deleted you from the list of those to be taken to the **Bath**. But all this takes place beyond the obvious sensations of Man (**even the owner of the Complex**). **Therefore, one who believes or says that he "gets neither treatment nor sense out of "his Complex", just does not understand that all of the above is more than enough to" justify "the possession of the "SvetL "Complex.**

In general, I do not recommend you to "breathe" at "SvetL" or blow at it (all the more, try to "get inside the Complex" (even with the use of psychics, which is sometimes observed, and mostly in the Ukraine), or **USE THE COMPLEX IMPROPERLY** (which also took place in the practice of exploitation it.) It is quite possible that in such cases the Complex will just "prompt" the Control System, **THAT IT SHOULD FORGET YOU**. What kind of talks there might be about the **Bath?**

4.4. About the Heart's part in the Bath process

In order to explain the process of recovery, it is completely useless to draw some diagrams, schemes or graphs from the series: "here, see how one affects the other this way, and in line with the reversible system also in the third and the fourth ". All the same people are waiting for someone to "advise" them the drug **X**, which was recently (long ago) put on the market. And they do not need then "interaction" with the "**SvetL**" Programs, which are incomprehensible to them and "smells" (as they think) charlatanism. Then there will not be the needed result. More precisely, maybe someone will get it, but someone will not. Or we will get the opposite. Why? Because all the "calculations", conclusions and results **ARE MADE AT THE LEVEL OF THE DEAD FLESH**. And the living flesh has a supervisor, that is, the Brain, which is able to **CROSS OUT ANY CALCULATIONS**.

Trying to heal a living organism by some pre-designed schemes is about the same as trying to constantly deceive a growing child. At first, while the child has little experience, it is not difficult to deceive him. But with gaining experience, this becomes more and more difficult, more and more sophisticated schemes and combinations are necessary, until finally there comes a time when the already grown up child will not «give in" " to any persuasions.

*Only a direct "agreement" with the Brain can, through interaction with it, correct the situation. The "**SvetL**" Programs have potential for this. And today there are more than enough graphs and calculations, and, most importantly, living testimonies in the application of the Programs and their successful work. It is not bragging – it is a statement, the basis of which is the objective conclusions of the Users of the Programs.*

The Burning Engine

It is known that the heart of Man can be replaced by an artificial one. You can perform almost any operation on it. You can even transplant from one patient to another. This universality is characteristic only of the heart – it is impossible, for example, to transplant the lungs or pancreas, as well as the spleen. You can only selectively transplant the kidney or sew on the finger.

Unlike the rest of the organs, for the heart, a **NEGLIGIBLE LIST OF AILMENTS IS ENVISAGED** – (stroke, heart attack, ischemic disease) –

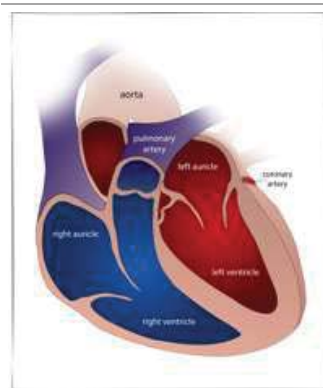

with which the surgeons can easily cope. But if these ailments catch you in the **Bath**, then it's unlikely that someone will be able to cope, except for the "**SvetL**" **Programs** in the ambulance mode.

All ailments arise, as a rule, from poor nutrition and from inadequate behavior of others. Like any living organism, a Man eats something and "throws out" something. In this case, for eating, we have only the mouth, and for "throwing out" – the rectum and ureter. It is known that the processing of food involves the stomach, intestines, liver, glands, and the processing of solutions – the kidneys and ureter.

The heart does not participate in the food processing, and therefore it gets the remnants of what is prepared for the "throwing out". An important part belongs to the rate of metabolic processes. If we take **Fleorov's**¹⁹ **table of physical and chemical properties of the elements**, then we should pay attention to the time of chemical elements existence. In the same place, there are **α - and β -decays**, and in the decay we can get **γ -radiation**.

No living being has in its basis (that is, in a living cell) eternally living structures, as well as structures with the possibilities of **α -decay, arbitrary decay, γ -radiation, and β^+ -decay**. All structures are formed only on the possibilities of **β^- decay** (the right-hand part of the Fleorov table). However, only material structures are given in the table, something that can be felt and measured. Science does not know anything about the non-inertial mass and intangible structures, but **THEY ARE THE ONES THAT SET THE METABOLIC RATE**. Any person has an aura in which there are no radiation frequencies. ***Kirlian-radiation of cells contains only the frequencies incoming β^- -decay***. When calling biostructures into being, the principle of successive time shift (beat) of metabolic processes was used.

The neutral axis is **1,0007** seconds, this beat is set by the Earth's collider, and this beat is unique for all inhabitants of the Earth. The collider itself is located under the north polar circle and "wrapped" with **8.640.000 meridians** descending to the southern ring (under the south polar circle). The accelerating blocks of the Collider are pyramids connected with the

¹⁹Book1, chapter 5.9

Earth Control System. If the collider is turned off, then life on Earth will disappear. To the left of the neutral axis are the normalized beat intervals for all inhabitants of the Earth, **TO THE RIGHT – ONLY FOR A MAN**. The beat interval is the basis for all metabolic processes, down to hundredths of microseconds. And this is extremely important for understanding the process of "bathing" in **the Bath**.

For Man, the initial **beat is 1,0007-1,24 s**. However, we have a lot of Brain genotypes,²⁰ and each differs not only in appearance but also in its initial beat. **Hence, problems arise:**

- if you transplant the heart from a donor who has the same beat, then there will be no problems;
- If the donor's beat is less, the transplanted heart will accumulate everything that is incapable of processing, and then a new transplant will be required;
- If the donor's beat is more, then the problem will arise in the Brain.

However, some structures – spiders, wasps, bees – have a beat interval **above 1,0007**. Previously, I mentioned that the inhabitants of South-East Asia chew fried spiders²¹ (by the way, they can eat them alive). Inhabitants of **14 countries in South-East Asia** have a **beat of 1.24 seconds**, and the spider's beat is **1.12 seconds**. The



European can not eat a living spider (if only in fried form, and even then this is dangerous), since the beat of metabolic processes is much higher. And while our European digestion structures are preparing "forks and spoons," it will have time to bite off something from us. That's why even in fried form spiders are dangerous for all of us. A spider might not be roasted well and wake up in an acid sauce in the stomach.

²⁰ Genotype is the aggregate of the Brain neurons ability and genes of a given organism, which, unlike the concept of a gene pool, characterizes an individual, and not a species. Such a definition gives only a superficial notion.

²¹ .Boo1, Chapter 3.1

In the metabolic processes, annihilation (mutual annihilation), superposition (imposition-summation), normalization (adjustment to some standard) take place. And all this is the reaction of accumulating the necessary potentials and removing the unnecessary ones.

Depending on what you need to accumulate or "throw out", the diet is made. It is noticed that horses and cows do not eat meat at all, and dogs gladly gnaw bones.

All biostructures, including Man, are built so that they have the whole set of octaves – from **16 to 128**. They are different in purpose and the predominance of one or another group of octaves forms the basis of the biostructure. The functional division of octaves is as follows:

- 16-32 → all kinds of gases and water (everyone needs breathing and water);
- 34-46 → the structure of reincarnation (all structures tend to accumulate the frequencies potentials of these octaves);
- 48 → the distributor;
- 50-52 → energy balance;
- 56-62 → the control of organs
- 64 → material structures;
- 66-72 → The Brain;
- 74-86 → the reincarnation control;
- 96-126 → the control;
- 128 → the defining beat generator.

All kinds of plants and herbs are into octaves **34-44**. Therefore, cows use only grass for food, knowing that they will be offered for food.

All metabolic processes are controlled by the Brain, but the **BLESSINGS MANAGER** for the body cells **IS** the **HEART**. If the heart asks for "luminium", the cells will get exactly "luminium", despite the Brain requests to give **aluminum**.



The heart has one important feature – it can not just be stopped. When performing operations on the heart the question always

arises – which circulatory system should be blocked first of all? But first, they have to realize why in general the blood is necessary and whether it can be replaced with anything else.

When creating a Man, it was considered that the transmitter (cerebellum) and the lungs should receive scarce frequencies, which are not necessary for normal cells. Therefore, two circulation circles were created: **a greater circulation** – low frequency structures and **a lesser circulation** – high-frequency structures. The distributor is the heart – The brain is not allowed to this frequency distribution process.

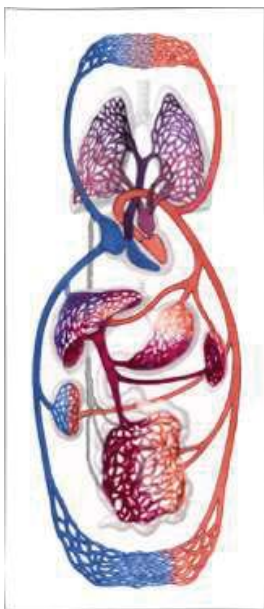

Unlike muscles, the brain can not “be inflated? – its dimensions are unchanged. The **Bath** will not change these dimensions. As the control structure, the Brain is conservative and does not react to external changes. The heart is **RATHER ACTIVELY INTERESTED IN ALL THE CHANGES.**

The heart has no convolutions, and therefore is not designed to store information. The thinking process is, naturally, *divided*. *The heart takes the main decisions, but does not remember anything; since there are no convolutions. The cerebrum works only for itself*, for this purpose it has many convolutions in which any information (where to steal, whom to deceive, what football team to buy, etc.) is freely placed. **Programs "SvetL" INTERACT** with the heart **ONLY THROUGH THE BRAIN**. Therefore, *it is expedient to sequence – first the Program "SvetL", and then – to the Bath.*

4.5. Blood plasma

Plasma does not have much to talk about – everything is known about it. More than 500 years ago, science established the truism – unshakable and steadfast Everyone, even children, know that blood is a liquid, usually red, it flows through veins and arteries, gets into capillaries. The blood composition is complex, and every year they find new components and compounds.

It is also known that blood moves due to the heart muscle contractions (44 mm of mercury), while its movement there partially expends the

muscular energy of living and other cells and formations in the body. Lately, however, there are some *suspicious about erythrocytes with a diameter of 7 microns being not able to penetrate the capillary with a diameter of 1 micron*, but science claims that these are trifles, that if you take blood from a capillary, there will always be an erythrocyte there. There are a lot of formations in the blood that appear because of a Man's wrong nutrition. So, love of sweets brings to the increase of sugar in the blood, and it is visible to the naked eye. If desired, the blood can be coagulated or not coagulated. Biochemical blood analysis accurately determines all aspects of its lifestyle. If desired, the blood can be poured from another source. An invention known as "blue blood" is some mixture of water and ions.

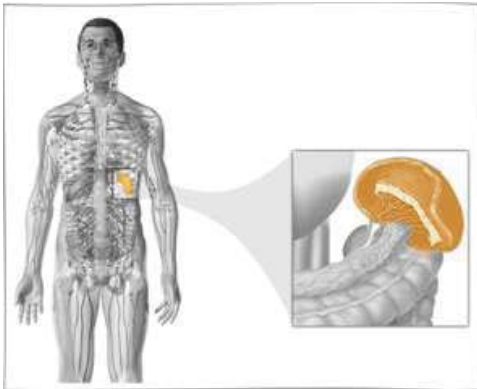

The producer of blood plasma is the spleen. If the spleen can not cope with the task (or if it is absent), then blood plasma can be obtained from the liver. It is known how much blood there is in the body, what the length of all veins, arteries and capillaries is.

It is also known that there are **two circles – a pulmonary one and a greater one**, and there is no difference, what to consider first. From a greater circle, having passed the intestine and having saturated with all that is rich in the intestine, the blood enters the Brain and passes the Brain all the valuables that were obtained in the intestine. For biochemical analysis, blood is taken from the veins, where it is maximally saturated with all those ions and structures that characterize the state of the organism. No one, of course, thinks of taking and comparing blood from the pulmonary and greater circles.

It is also known the upper and lower pressure in the arteries, and no one ever measure the pressure in the veins, in the pulmonary circle, in the Brain capillaries, in the liver, since there is one heart and the pressure it creates is everywhere the same, and the expenses, that is, high pressure in the Brain vessels at normal arterial pressure, can always be attributed to high mental activity.

There are, however, unscientific views on the composition of the blood, the way it moves, but these views are doomed to

extinction, since science for the past 500 years has not found anything that could shake its foundations. Nevertheless, let us consider not the horse's point of view on the blood, in other words, the unscientific version about the blood plasma and its use by a living cell.

4.6. Paradoxes of blood plasma, or Biological aspects of non-horse Science

If children in a kindergarten every day, in the morning, in the afternoon and in the evening, are fed only with semolina, then on the third day you will get a strike.

The Man's body consists of more than **640** different cell types, each type has up to **2484** varieties.

Each cell at the frequency corresponding only to it has a connection with the Brain. If such a connection is broken, the cell begins to live at the expense of its neighbors, and neighboring cells are forced to change their way of life. Each cell has its own needs: one consumes only compotes to keep the figure, another likes sausage such as "salami". If these cells get the same every day, and they also dig in all those wastes that float by, then soon enough the connection with the brain will not be required, and the cells will just live at the expense of neighbors, selecting from them the most tasty pieces. To such cells the Brain is no longer needed, and they can boldly raise the question of the democratic way of the control, where each group of cells takes what it likes most.

It should be noted that the cells not only drink and pee, but eat and poo. These features are known to science, but because of the sensitivity of the question, science does not touch this aspect and prefers to assign the cells the role of an automated complex *where everything that is obtained is eaten and after an autonomous processing (or without it) again comes to be eaten.* Thus, quite a problem is removed – there is no need not only to feed the cell, but also not to care about the waste disposal.

Lately, it has been observed that some cells change **pH** (even a version is suggested that **pH** varies in cells taken for the Brain). However, this is still referred to the whims of weather (**pH** has one value in rain, and another one in wind). Remember that ***pH is the negative logarithm of the ion concentration in the solution.*** The type of solution is not specified.

So, there is a conveyor (veins, arteries, capillaries), in which ***the viands move***. The first rows of cells grab all tasty things, and the rear, if they do not have time, receive only scraps or sweet compote. All this reminds the Kazakh variant of a dinner – when all dishes are mixed in advance in a cauldron (by a principle that in the stomach all is mixed all the same).

In the conveyor, except for food, there is a mass of waste and a guard (making sure that bacteria and viruses, the crowds of which swarm near the conveyor belt, do not attack the delicacy).

Of course, the cell can also feast on the guards, and have a snack with the bacteria; in this regard, special directions have been created in science that study the behavior of bacteria and viruses near the conveyor. At the same time, medical preparations are specially created, which bring out the unscrupulous microorganisms and viruses into the open.

Since modern science has not noticed anything else, let's try without additional details, clearly systematize a different approach to ***the problem of blood plasma***.

It is known that each cell has a membrane that passes only that water in which the grating is compatible with the cell structure grating. Consequently, the water from the water supply system or from the river will not pass here. In addition, the food for the cell can not be cooked in a kitchen factory with a diet number label (some cells can not read and can grab the wrong plate).

Each group of cells that is fed in one diet should have its own chef, which receives the initial (basic) solution at **54.875975** octave. This solution is prepared by the spleen, and it is the same for all cells. Regarding this base, each chef of the group prepares meals in the range from **32.625,125 to 65.750450**.

The diet is made by the Brain, and if the cell needs an additive or another diet (for a short time), then the Brain is in the know and gives the appropriate directions to the chef.

Thus, **THERE IS NO ANARCHY IN NUTRITION**.

The initial solution is standardized in composition, octave of the grating, therefore **the Brain does not have to constantly monitor the work of the spleen**, it is enough to carry out the control of the spleen proper. Of course, there are unscrupulous spleens, hiding their state from the control, but this is a special case.

Plasma standards correspond to **66** output parameters, each of which is consistent with the cell, and none of the body cells is left without food. One of the main control parameters, made by the spleen itself, is the lack of octaves **54,375, 54,450 and 54,625**. These octaves, when necessary, are added in the form of spices by the chefs of cells groups on their own. In addition, the blood plasma should be able to insert an additional **61,450,450** octave on which the waste (ions) is formed.

Since the group chef can not keep track of everything that he cooks, and the food can burn, a non-stick octave **54,225225** is added to plasma. The availability of this octave does not allow the blood plasma to lose the remaining grating octaves (or collapse).

As soon as the water gets to the chef, he immediately rushes to the refrigerator where the necessary octaves are stored, stirs them in the right proportion according to the current diet and pH of the cells (**pH range =6.88-7.45**). This takes into account the whims of the cells (plates, spoons, knives, napkins, etc.).

Note that the chef uses only the initial solution, and not what floats there, he dilutes the solution himself with the right amount of appropriate spices and culinary supplements, pre-filtering it.

Cells always get freshly prepared food and only if the chef mixes up the diet (when working for two or more wage rates it is possible), they resort to various forms of protest.

Of course, the chef does not immediately rush to feed the cells. First, the tasting is done, and then the commission selected by the Brain signs for the quality. Then the cells take seats (considering that some of them have slept, others – like after a run of 100 meters, get some time for combing, washing) and the process of cells saturation is done in order. At the same time, the chef watches so that the cells may not overeat (otherwise they may become fat and not be placed in the space allocated to them) and leave the table with a slight feeling of hunger (reaching **pH=7.44**).

Some time after lunch (3-4 hours), the chef puts all the cells on chamber pots, and ***the liquid waste is packed into one type of container, and the solid waste – diluted with the initial solution, into another type (AMONG COMMON PEOPLE AND IN SCIENCE, THE LAST CONTAINER IS KNOWN AS ERYTHROCITE).***

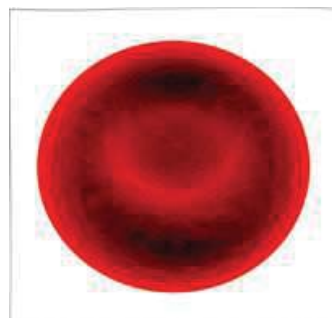

These containers are thrown into the initial common stream and, of course, no other chef decides these containers to be used for cooking. Coming further into the bladder and into the intestine (according to the stuck label), the containers are thrown out into the noosphere, where they are taken away by bacteria for the preparation of nitrogen-containing fertilizers. Sometimes, however, containers are not enough for everyone, then they are borrowed from other groups, causing in future the amazement of the laboratory assistants conducting biochemical analysis of blood plasma. The new content of the known container usually becomes the topic of doctoral dissertations.

Stockpiles are replenished daily with manna from heaven. And if suddenly it is discovered that the refrigerator is empty, this does not mean that some irresponsible cells climbed there at night or there was no manna of heaven there. The guilty ones, as a rule, should be sought among the quartermasters of neighboring groups of cells, which have taken what they might need in the future in the hope of good.

Some cells do not want to sit on the chamber pots, and empty containers have to be thrown out clogging the initial plasma with empty boxes. Hence comes what is commonly called, *for example, right-sided sugar with signs of left-sided one* – **THERE IS NO SUGAR, BUT THE SIGN IS "STUCK"**.

If you do not have the above octaves, then the lunch can evaporate before everyone's eyes (the effect of annihilation), while the smell remains **at octave 73.450450**. Sniffing brings the cells into the state of affect (known as hallucinations, especially after using drugs)

When carrying out the biochemical analysis, it is necessary to separate the containers from the waste, and not to rummage in the whole heap. Only after the containers separation can we calculate how much (and what type) ions of **Ca, Mg, Fe, Na** and other ions to add to the manna of heaven for the organization of rational nutrition. Having looked into the blood, let us get down the skin. *And we will know a lot of new things.*

4.7. The skin

The material presented below is given without corrections from the monograph by *K. Willy. Biology, ed. Mir, Moscow, 1968* (Claude Alvin Willy, born in 1917 in Lancaster, Pennsylvania, died on August 7,

2003, an American biologist and lecturer at Harvard University). The text from the monograph is reproduced completely, without distortion, and if you come across **obvious stupidity**, then all questions to **K. Willy** as a Harvard professor. (Forced comments, which will have to be done in the work, are in italics in brackets).

All multicellular animals are covered with skin on the outside or a cover consisting of one or more layers of cells. The skin is much more than just a simple outer cover of the animal's body; it is one of the important organs of the body and performs many diverse functions.



Perhaps the most obvious and vital function of the skin is to protect the body from all sorts of external factors and help maintain the constancy of the internal environment. (*Probably to prevent any organ from escaping*). Being transparent and flexible (*in order to look after the organs properly*), the skin protects deeper lying cells from mechanical damage caused by pressure, friction or blows (**especially important for the penis**).

Until its integrity is broken, the skin is practically impenetrable for microbes and protects the body from pathogens (*everything on the surface is inclined to feast on what is inside*).

The skin being waterproof protects the body from excessive loss of moisture, and in water forms – from excessive penetration of water from the outside (*unscrupulous cells of the body always tend to drag out the drinking water, and water forms – to grow to the whale size, so the skin for them is the worst enemy*).

Of great importance is the fact that the skin is able to protect the cells underneath it from the harmful effects of ultraviolet rays, thanks to the pigment that it can synthesize – a tan (*it is required only when staying at the North or South Pole, in Africa it is not needed*).

In addition, the skin functions as a thermally controlled radiator that regulates warmth loss by the body (*that is, it performs those functions to which the Brain is incapable*).

Warmth is continuously formed as a result of metabolic processes in cells and is distributed along the body by the blood. Therefore, to maintain a constant body temperature, the body always has to lose a certain amount of

warmth (***chemical reactions that form warmth take place simultaneously in all cells, even in the brain ones, these cells warm not only the external ambience, but also the bones.***)

Some of the warmth leaves the body with exhaled air, some with excrement and urine, but approximately 90% of the total warmth loss is through the skin (***if we calculate the warmth released with the excrement, we get a medium-power atomic bomb.***)

When the external temperature is low, the temperature-sensitive nerve endings in the skin become irritated, and the skin capillaries become narrower reflexively, thereby reducing the flow of blood through the skin (***one of the causes of myocardial infarction***) and reducing warmth loss (***the Brain does not suspect it.***)

In the warm ambience, the opposite happens: the capillaries get wider, the skin turns pink as a result of the increased blood flow and gives off a lot of warmth (***according to this conclusion, under normal conditions, the skin has an average color of the spectrum, that is, green.***)

At a very high ambient temperature, this mechanism can not ensure the return of the necessary warmth, so the sweat glands in the skin emit unusually much of sweat (***the cells, of course, do not know who and why takes away the sweat.***)

Evaporation of sweat from the skin surface lowers the body temperature, taking away from the body the heat necessary to convert the sweat into water vapor; to convert 1 liter of water into vapor, 540,000 calories are required (***if a pot of water is put on fire, the resulting vapor cools the water – as a method of getting ice.***)

In the skin there is a number of different sensitive receptors, through which we can feel pressure, temperature and pain and are able to distinguish various objects that we touch. The receptors respond to the following stimuli: Krauze's endings – to cold, Ruffini's papillary endings – to warmth, Meissner's corpuscles and Merkel's discs – to touch, Pacini's corpuscles – to heavier pressure, free nerve endings – to pain stimuli (***the skin does not have receptors for analyzing the composition of gases, radiation, alkalinity and acidity – these analyzes are carried out in closed laboratories of the internal organs by absorbing external stimuli.***)

There are specialized glands in the skin: about **2.5 millions** sweat glands are scattered all over the body (***many are lying unattended***), but

they are most numerous on the palms, on the soles of the feet, in the armpits and on the forehead (the bones also sweat); sebaceous glands are also distributed throughout the body, but especially a lot of them are on the face and the scalp (if the hair grows on the nose, then there are also these glands there). They give off fatty grease, thanks to which hair retains moisture and flexibility (hair washing is not indicated), and the skin does not dry out and does not crack (*it is noticed that if you sit with your bare buttocks on the leather sofa, it also does not crack immediately*). Mammary glands of mammals are also skin derivatives, specialized for the secretion of milk (*if you squeeze it well, you can get 1 liter of milk every day*).

I am sure that with such Alexander Khatybov's comments, everything has become clear. It is true, I did not tell you about the silky face skin and the way it is achieved, but considering numerous ladies wishes, I'll have to tell about it later- I only want to remind you that what helps others, can be useless and even harmful for you. And this should always be kept in mind.

4.8. The skin components

The skin consists of two main parts: a relatively thin external layer, the epidermis, in which there are no blood vessels, and an internal, thicker layer – the dermis, rich in blood vessels and nerve endings.

The epidermis, in turn, consists of **SEVERAL LAYERS OF CELLS**

OF DIFFERENT TYPES, the number of which in different parts of the body is not the same (*since these cells do not get a full-fledged food prepared on the basis of blood plasma, they are forced to feed themselves by smuggling and what they are offered by bacteria and viruses, wishing to penetrate the skin; while preferring dressing up so that they may not be noticeable against the background of green grass*).

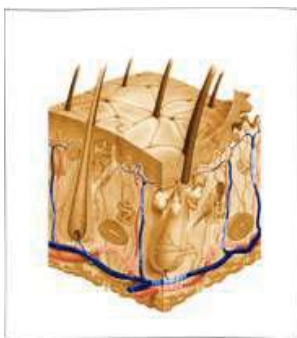

The skin thickness varies considerably from one part of the body to the other. The skin is the thickest on the soles of the feet and on the palms (*with some ones – on the tail*), where the surface of the epidermis breaks down into countless narrow ridges (*see channels on Mars*), which form

characteristic patterns (***with age, the artistic industry develops, and in the end there remain only patterns***).

The epidermis layer adjacent to the dermis is formed by columnar cells, which often divide and, thus, give rise to the overlying layers (***in the beginning was a word...***).

The epidermis external layers are continuously peeled off and replaced by cells from the underlying layers (***in search of a good life***). Each cell of the lower layer, tending to the outside, is compressed and transformed into a flat scaled epithelial cell (***see the continuation of the genus based on the friction of epithelial cells of a man and a woman***), which dies off.

Dandruff consists of flaky remnants of external epithelial cells of the scalp (***not having time to take part in sexual intercourse***).

The dermis is much thicker than the epidermis and is formed mainly by connective tissue fibers and cells. Its external layer, consisting of densely interwoven connective tissue fibers, is the part that is tanned for skin dressing (***and giving it the necessary color and strength, the skin is usually tanned after birth***).

Underneath it, connected with deeper muscles, is a layer formed by numerous fat cells and a friable plexus of fibers. This part of the dermis is one of the main fat stores of the organism. Fat helps (***in the lack of the Brain***) to avoid excessive warmth loss and acts as a cushion that protects against mechanical damage (***to avoid prick, the feathers from the pillow are removed***). The dermis is abundantly supplied with blood and lymphatic vessels, nerves and sensitive endings; it contains a lot of sweat and sebaceous glands and hair follicles.

Skin color depends on three factors: from a yellowish shades of the epidermis cells (***under sunlight it is green***), on their ability to let in the light, thanks to which the bright pink color of deeper blood vessels shines through (***if the blood is blue, then the color is of the sea wave***), and on the type and amount of pigment of red, yellow or brown, which is contained in the lower layers of the epidermal cells (***considering the physics color laws, you can get any coloring for the skin, like the color mixing in TV***).

4.9. The skin derivatives

Hair and nails in humans, as well as feathers, scales, claws, hoofs and horns of other vertebrates are derived from the skin (***under the conditions of poor nutrition of epithelial cells, there might be anything to grow up upon them***). All the skin except the skin covering the palms of the hands and the soles of the feet (***hence – the constant debate about the origin of man: whether from the monkey, or from the elephant***), is provided with countless hair follicles – sacs formed from the cells of the epidermis internal layer. These cells are divided and give rise to the hair cells (***changing not only the structure, but also the purpose – as is known, the hair is needed to pull it out***), just like the internal epidermis layer gives rise to the overlying layers.

But these cells die still being inside the follicle, and the hair protruding above the skin surface consist of a tightly packed mass of waste (***and the skin care for the hair color, shine and strength is deception***).

The hair grows from the bottom of the follicle, and not from the upper part of it. The color of the hair, as well as the feathers and furs of animals (***being one of the forms of the hair cover***) depends on the pigment amount and type, the number of air bubbles and the nature of the surface of these formations, which can be smooth or rough (***the favorite occupation of cells is to blow air bubbles***).

The nails on the fingers and toes also develop from the pockets formed by cells of the epidermis internal layer; the growth of nails is similar to the growth of hair (***with the same functions; a man is particularly sensitive not to the skin itself, but to the waste***).

Nails consist of tightly packed dead cells, through which the underlying capillaries are visible, giving a normal pink color to the nails.

Sebaceous and sweat glands develop from the epidermis internal layer, which forms pockets that extend deep into the dermis. Each hair follicle is provided with a sebaceous gland (***for the purpose of maximum waste preservation***).

(Thus, with the lack of the Brain, the skin copes brilliantly with its duties, reproducing a human race by the friction of epithelial cells between themselves, giving a special beauty to the waste and preserving all the dead cells necessary for the

organism, and also regulating the processes of the body's warmth balance.

In addition, the color and structure of the skin external surface is determined mainly by the dead cells. The main role in the all processes regulation is assigned to the epidermis layer, on which there grow hair, nails, claws, horns and hoofs).

4.10. Skin sensitivity

As mentioned earlier, the skin contains several different types of simple sense organs (***able to cope with recognition tasks independently of the Brain***); some of them are just loose ends of dendrites, others are ends of dendrites, enclosed in special cell capsules. (***Using the law of physic and modern methods of research, the answers were found to all questions on the skin sensitivity***).

When carefully, point by point, examined a small skin area with a hard bristle (for testing the sense of touch) and a hot or cold metal needle (***to test the temperature sense***), it turned out that the receptors for each of these sensations are located at different points.

4.11. Kinesthetic sensitivity

All muscles, tendons and joints are equipped with nerve endings, called proprioceptors, which are similar to some of the skin receptors. These endings are sensitive to changes in the tension of the muscle or tendon and send impulses to the Brain through which we feel the position and movement of various parts of the body (***if you remove at least one receptor, then the person would go head over heels***). This feeling is called kinesthetic; it gives us the opportunity, with our eyes closed, to perform various actions with arms and hands, for example, to dress or make knots (***even with the Brain turned off***).

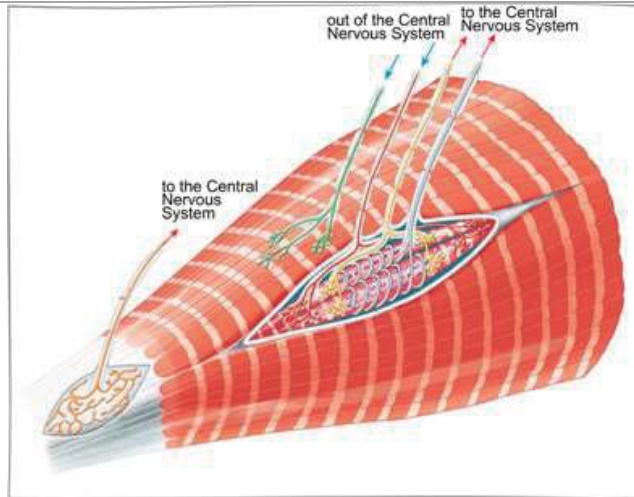

In addition, impulses from proprioceptors are extremely important for the coordinated contraction of different muscles involved in one movement, without them complex actions requiring dexterity would be impossible (*especially in terms of swindling, when the Brain is asleep*). These impulses are also of great importance for maintaining the balance (*the greater the impulse, the greater the balance*).

4.12. Splanchnesthetic sensibility

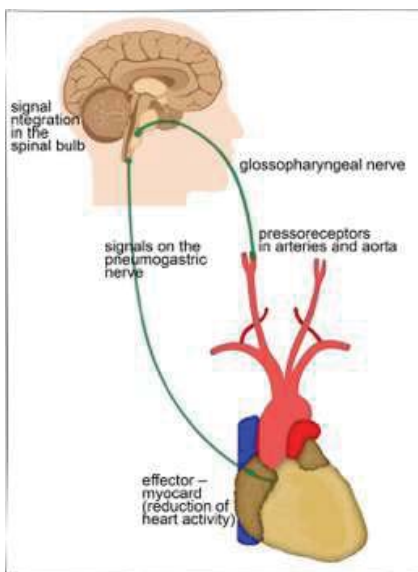

Sensations associated with receptors of internal organs, extremely important for regulating the operation of the viscera, rarely reach the level of consciousness (*therefore, one should not pay attention to various pains of the viscera – the Brain is not aware of them, and the receptors themselves determine what should be done*).

Some impulses from the receptors, however, reach the cortex and cause such feelings as thirst, hunger, or nausea.

The feeling of thirst arises when the receptors in the pharyngeal mucosa are irritated; when the membrane is dried, the receptors send impulses to the Brain,

which we take for thirst (***hence, if these receptors are removed, the feeling of thirst can not be experienced at all, which is very useful in desert conditions***).

The wall of the stomach also contains receptors. When the stomach is empty, a series of strong, slow muscle contractions pass through its wall stimulating receptors and causing hunger. Inputting a rubber balloon into the stomach (***taken by the stomach for sausage "salami" because of the receptors' lack of eyes***), it was possible to find out that the attacks of hunger are closely related to these characteristic contractions. Recent studies suggest that the feeling of hunger can be caused by a lower concentration of glucose in the blood (***so you can not eat only sauerkraut, and the optimal is having diabetes, when you do not want to eat at all***).

It is possible that the feeling of nausea is also caused by the stomach receptors action, but contractions causing it are directed up the digestive tract (***in case the Brain is in the buttock muscle***), and not down, as in normal peristalsis.

4.13. The skeleton

The first and most obvious function of the skeleton is that it gives support and "form" to the body (***even in the lack of a lymph system***). We need some solid, durable material that would support the heaviness of the gentle tissues (***dipped under the skin***) and serve as a reliable basis for the muscles joint. The bone marrow, enclosed in the cavities of the bones, performs a special function for the production of all red blood cells and certain types of leukocytes (***without the Brain knowledge and for the organism having capillaries of more than 9 microns in diameter, that is, the bone marrow works for nobody knows what creature, perhaps, for a dinosaur***). Two types of specialized structures, consisting of connective tissue fibers of the ligament and tendon, serve to connect the bones with each other and to attach the muscles to the bones (***if***



they are assembled in the desired sequence), thereby creating the possibility for body movement (***immediately after the assembly of bones, muscles and tendons the body has the ability to move around***).

The skeleton of dead animals is better preserved than soft tissue. Many of our knowledge about fossil animals and their kinship ties (***including the number of extramarital relationships***) were obtained through intensive study of their bones. Studying the bones size and shape, the place of muscles attachment, etc., you can get a lot of information about the animal and its lifestyle (***including the number of taking into custody and wages in the last 10 years of life***)..

The skeleton of the man limbs differs relatively little from the original type, ending with five fingers, while the more specialized limbs of other animals sometimes have four – like a pig, three – like a rhinoceros, two – like a camel, or one finger- like a mare, (***the horse has one more finger***). The similarity of the basic structure plan of the skeleton of the upper and lower limbs of man is discovered (***if they are interchanged during the assembly, it can not be outwardly visible***).

4.14. Some remarks

According to scientific facts, a man is outwardly made of waste productes, that is, he is abundantly smeared with excrement. But it is known that after a certain time the excrement starts glowing at night, and with fat glands normal operation- in the daytime in the sunlight. I must say that, in addition to fat glands, excrement is diligently taken care of, for example, washed of all bacteria, viruses and dust trying to join the luminous source, using the Kazakh-made food the type of "***Wash & Go***" shampoos – in this solution (for washing the excrement) the conditioner (***acidic solution***) and shampoo (***alkaline solution***) are combined together in one bottle, the same as in Kazakhs cooking – all dishes are prepared (***including compote***) separately, and before eating they are placed into one pot (***anyway in the stomach everything is mixed up***).

It has been experimentally established that the strongest glow is observed in the region of the skull, where usually what is refered to the Brain is located. And the warming of bones when the organism is giving off the warmth and the unique glow of excrement create an unforgettable picture.

According to some scientists, the halo on the icons has also two antennas, that is, the horns of the aliens, so the bold scientific conclusion is that all male cuckolds are aliens.

It is also established that people with a crown should speak less, because the less you talk, the more heat is saved and the more intensive the sweating; and profuse sweating creates in the rays of the sun a rainbow that frames the crown. It is established that to those people who often and for a long time speak (***especially before a large crowd of people***), hot tea is brought. This habit has taken root and has become a tradition since it was realized that in order to maintain a warmth balance when returning it, it is necessary to take something hot (***but not above 96,6° – in alcoholized terms***).

Crowns may be different. If the excrement is emerald green, then the crown has a red glow, if it is blue, then -golden.

In general, excrement of blue color is a rarity, not more often than 1: 1,000,000,000,000, that is, one in a trillion of people. Blue excrement is cleaned of unpleasant odors (with the help of chemical additives) and therefore have the feature of not attaching a different color even when talking. As a rule, most people do not know anything of chemistry and therefore try to transfer the outer form of the crown to an icon.

The presence of excrement helps the search and guard system. Dogs, for example, when checking "**friend – stranger**", first of all, sniff and determine the type of excrement, and if they are not of that type, they taste it for filing in the file. If a part of the body is bitten off, this can be attributed to costs and zeal.

The conducted scientific analysis allows us to draw a conclusion that ***the epithelial cells are most important for the "King of nature"***. Only the friction of these cells creates the necessary conditions for the existence of both a man himself and his offspring. Only the presence of these cells is the determining factor in the genotype structure. ***Only the properties of these cells allow the "King of Nature" to look elegant (the excrement properties are described in detail in biology)***. Only high quality of excrement allows the search and guard team to ***find the "King of Nature" in time and bring him to the Bath***. Having a constant supply of epithelial cells, the "King of Nature" may not

care of being unnoticed, and not getting all those benefits that are due to him thanks to the properties of epithelial cells.

The same can be attributed to the participants of the "SvetL" Programs, who, in interaction with their "ward", will decide whether HE CAN BE TAKEN TO THE BATH OR HE HAS TO WAIT.

But first of all, to move forward, you have to take something as a basis. I suggest: in order to finish this chapter and move on in the knowledge of the object to be taken to the **Bath**, take the following as a basis: **"Do not believe your eyes, then you are a thinking person"**. It is this rule that has allowed the Mankind to make all the true discoveries that people have been enjoying and will enjoy. He who did not believe his eyes (claiming that the earth is flat) and went to seek the horizon, discovered America and India. That Man realized that the surface of the Earth has a spherical shape, and its design is multi-layered, and it consists of many different spheres. It turns out that in order to understand what is happening in the world beyond the sensory perception of human organs, it is necessary to completely abandon those ideas about the phenomena that these sensors give.

Our eyes, ears and other senses specially provide false information which deprives us the ability to reck our brains over the essence of those things and matter that lies beyond the scope of our activity. If, for example, a man is a fruit-eating creature, then, accordingly, the sense organs are arranged so that he can really feel those objects and phenomena with which he is directly connected, for example, fruits and berries in all their beauty. It is for this reason that the person was not endowed, and to be more precise, his Brain was deprived of many abilities, for example, X-ray or microscopic vision, and therefore has no opportunity to see the structure of the smallest atoms or even smaller particles. And as an "excuse" for this – a ***man is not fed with individual atoms, so he is given multi-color vision in certain limited frames*** so that he may be able to carefully examine the fruits on trees and other objects within his real life interests. Here the truth is not important – the surrogate of the truth is important. The Truth is often so simple that it is not believed in. This is one of the reasons for taking the **Bath**. But even after the first Bath, exactly the same method of distrust to ***one's ears, eyes and feelings*** should be applied when a person wants to understand the essence of events and phenomena that are beyon his mind even after the first "bath".

If people want to understand something in general or want to understand the truth beyond their own activity, then it is necessary to

perceive absolutely all the information that your senses give you – as false. And if a person wants to understand the processes of the social system or what can take place in social processes, then for this it is necessary to take all the stereotypes of thinking in this sphere – as false, especially nowadays. Because every truth is a system of knowledge, but not every system of knowledge is the truth. But, despite everything, we will go on keeping a close eye on the object and everything connected with him, before sending him to the **Bath**.

Chapter 5. Correction of the Brain structure before and after taking the Bath.

Infinite is only the Universe and the Human stupidity. Though about the first I have some doubts.

I was perfectly aware of what was in store for me when I got down to the continuation of the book by **N. Levashov**. But I was also aware of what subject I was to deal with in relation with all this. You may ask: "What for do you need this?" It is better not to touch the past, not to stir up the past interests. Since there are **N. Levashov's** books, there are his websites and people who are well or not quite well engaged in spreading and "explaining" the information left for all of us, then let it goes that way. And if it "has taken roots", then let it grow the way it grows. The same can be said about **A. Khatybov**. Here, however, a little more difficult, because many of his works are just "hidden". But still, there is enough information which makes it possible to come to certain conclusions or not to come to anything at all, living by the principle: *"let it be quiet and no mouse scratching."* It might have been done that way, if it were not for one nuance (today even not very "curious" see it) – everything that happens around us does not stand still. Everything is changing and developing rapidly. But in what direction? For good or for worse? It all depends on who, how and what "sees" and knows. There are many for whom to grasp the direction of development at once, became as easy as predicting the fate of the house, which foundation has partially disappeared or come down. What should the tenants do? Should they keep quiet and wait when it collapses? I am sure that it is not the best option. **Noah**²² once predicted the flood. People laughed at him and went on building houses. They got drowned. Only the righteous survived with a family of eight souls who built the ship.

Proceeding from my own knowledge, I want to share the events developing forecast for the near future (they have already begun),

²²According to the Bible, Noah was a righteous man in his generation, for which he was saved from the Flood and became the successor of the Human race. With this end, God commanded Noah that he should build the Ark and take there members of his family and a pair of animals of each kind.

comparable in their significance to the Great Flood. In order to somehow ease this oncoming period for people, it is necessary to build a design for a future world outlook that differs from today's as far as a ship differs from house. All the rest, in my opinion, **IS USELESS IN THE STRATEGIC PERSPECTIVE**, because building a house on the eve of the flood, *using old knowledge and old worldview, is doomed to failure*. The house is good on the land; at sea it is a coffin. The same should be applied to the Knowledge, "gained" by the absolute majority. It is necessary to search for something new, fundamentally different, but not create a "protective" construction, relying on the today's knowledge; search for those like-minded people who have got at the meaning of the events taking place. It is necessary to start a search (if, of course, there is a desire to survive) looking into what is left to us by **N. Levashov**, the Scientist who **DID NOT FINISH WRITING** his third book, "**The Mirror of My Soul**", but he laid the foundation for moving forward – to a new world perception and gaining one's own New Knowledge. That's what I proceeded from, when "taking up the pen."

5.1. For the people from the locomotive

Imagine the Mankind in the form of a train. Ahead is the locomotive dragging the train carriages behind it. First follow passenger carriages, followed by freight trucks and the tank trucks close the train. **PEOPLE** go on this train. They **HAVE DIFFERENT OVERALL VIEW OF THE OUTSIDE WORLD**. Those sitting in the locomotive see the surrounding space at maximum width, as they sit in front of a huge windshield with large windows on each side. The outside world for them is seen in the same way as the space inside the locomotive.

In the passenger carriages there is no windshield, there are only large side windows that open the view on both sides. If you wish, you can even lean out of the window look a little ahead. The world outside the carriage is of no doubt for these passengers as well as for those in the locomotive.

There are no windows in the freight trucks, but there are slits to which one can cling to and see the outside world. But most of them do not look through the slits, for they are busy with their "truck" affairs. For them, **THE MAIN REALITY IS THE TRUCK SPACE**. As if there is no world outside the truck. It would be considered non-existent, if not for the slits through

which one can sometimes look and make sure of its existence. The world outside as if exists, but at the same time it is almost an abstraction.

The last ones are the tank trucks. They are hermetically sealed – neither windows, nor slits. The people in them do not see the outside world. Their only reality is the space of the tank, in which they are as if immured. The world outside the tank is not even an abstraction for them, it just does not exist.



There is "a flow" of people through the train. ***Who wants to know the world around as a whole, moves towards the locomotive and once gets into it.*** Who does not want to know anything other than the visible reality inside the carriage or the truck, they move toward the tanks and one day find themselves in the tank. Some of those who seek to know the whole reach the locomotive. Those who do not feel like it, once find themselves in the tank. The slowest is the flow from the locomotive and tanks. From the locomotive down there go the blind. From the tanks further up there go the sighted (or – feeling intuitively). ***In the locomotive today a negligible part of humanity is traveling*** – literally one out of a million (even out of ten or a hundred million). Hundredths of a percent go in passenger carriages. Tenths of a percent – in freight trucks. The rest of the humanity (about 99% of people) makes their life journey in the tanks. Everyone has their own life journey, but everyone is sure: there exists only **VISIBLE TO HIM SPACE OF THE TANK**. Neither consciously nor subconsciously, the thought never occurs to the passengers: "Is there anything outside the tank?" For them, the **VISIBLE SPACE IS THE ONLY REALITY**.

Different perception of the reality determines the possibility of a dialogue between people from different spaces. Travelers in the locomotive can communicate relatively freely with people from passenger carriages. Communication with passengers of freight trucks is possible, but more difficult. With people in the closed space (from tanks) it is impossible, because their ideas about the world are different, as well as their goals. Between the sighted and the blind there is just nothing to talk about. With the blind only the other blind easily finds a common language. The

passengers of freight cars, never looking through the slits, understand the passengers of the tanks, but these are nuances. The main idea – **"different ones are not able to communicate with each other, each one has one's own"**. If an insect sees in a radius of several centimeters from itself, there is no sense to start a conversation about the stars. ***If the horizon of a person is limited to the framework of the current life, it is useless to talk with him about the world beyond the horizon.*** The concept of an "outside world" does not exist for him.

I am writing it for all the people from the locomotive, for many of the passenger carriages, for some people from freight trucks. And for none from the tanks, because, in my opinion, there is no sense. But there is one **but ...** The fact is that there are many who spent most of their lives in an enclosed space. A series of events led them out of it. Consequently, the **TANK** is **NOT** a **SENTENCE** because the **"SvetL" Complex** has "come into being", and **everyone** (I emphasize – everyone!) **while using it is able to see more.**

You might agree with me that today for many people the characteristic feature of life is not striving for knowledge, but striving for goods. Any person, being between favorable and unfavorable environment, has been doing his best towards the good. It's no secret that dead matter, unlike living matter, does not strive for anything, everything is decided by chance. But today, you have to **STRIVE** for the good **ONLY THROUGH KNOWLEDGE** and gaining of your own New Knowledge on this background. This goal looks unusual, so there are many who are afraid of getting down to it. One thing – to talk about this in the kitchen, then again to plunge into the current life, and another thing – to start a talk precisely in order to realize it, this goal and get the result thanks to your knowledge.

Reviving the **"RSTS"** Organization, with **N. levashov** we decided that, unlike the **"RPM RGC"** created by him, we should look for and attract people who are not just fond of talking on this subject, but able of moving from words to deeds. In theory, everyone is able of this, but many people are pinned down with far fetched fear. For such people, action is never as terrible as imagination makes it. But you have to overcome yourself and move to Knowledge. Fear has big eyes, but as they say, "you never know what you can do till you try". As soon as you start (only really, and not as many kitchen patriots used to) and you will see that everything is not so scary and even works out. Today I fully relate this to the participants of the created **Clubs of "New Knowledge named after N. Levashov"** who play significant role in the quest for Knowledge and in understanding our victory. In history,

you can find many events in which an enormous and invincible in appearance enemy turned out to be a "colossus on clay feet". Most of the modern systems that we face almost daily, are just like that. They seem great, powerful, indestructible, but at the same time they can hardly survive. To "shatter" them (and "shatter», first of all, for the sake of Cognition and secondly – for the sake of the good, you have to poke your finger in the right place. The weak point can only be determined through Cognition. The number one task is to understand the weak points of the colossi. Task number two is to have a finger to poke. Next, the "building" will begin to destroy itself due to the growing wave of destruction (domino effect). All this directly relates to our today's world-arrangement and world-perception.

Any system is weak in something, and strong in something. We discussed this subject with Levashov while re-creating the **Organization**, which I have already mentioned and which we temporarily called "**RNTO**". I then realized that someone who understands both, has a chance. A chance to the future. My favorite historical hero, Alexander of Macedon, took power over Persia not because he had a miraculous force. He just knew and understood the weak points of the enemy thanks to the records of Xenophon²³, who participated earlier in the campaign against Persia. It was Knowledge.

Very briefly about the essence of these records (Knowledge): a relative of the Persian king, Cyrus the Younger, was the satrap (governor) of one of the provinces of Persia. Perfectly knowing the quality of the human material of the Persian army, he hired 10,000 Greek mercenaries and went to war against Darius. By a tragic accident the governor died at the very beginning of the first battle. The Greeks retreated, and Xenophon described the events of the campaign in the book "Anabasis" ("The Way Home").

²³**Xenophon** (Greek Ξενοφών) about 430 BC. – Ancient Greek writer and historian, commander and politician, whose main work is "Anabasis of Cyrus."

5.2. Back to HisTory

Nikolai Levashov used to give detailed examples from the past, if they could add some understanding of the future. I am going this way, too, the more so, that few people know this historical event. So, **Alexander learned by heart "Anabasis"** and understood the reasons that prompted the governor not to be afraid to fight against the whole of Persia.

The governor knew the worth of the Persian army: against the Greek army, in spite of being numerous, it was as helpless as a million 80-year-old women before a thousand fighters of the GRU special forces (some exaggeration, but the essence is clear).



Had not the rebel satrap died, he would have had all the chances to get the same result that the Macedonian got later. On the assumption that Cyrus the Younger was a shrewder politician, then there is no doubt that he would have achieved even greater results than Alexander. But because of the tragic accident, the Spartans, hired by the governor of the Persian province, lost to the Persian "old women". Alexander knew: ***the power of Persia was a propaganda bubble***. The Tzar Darius could take the field with the army of a million people, which struck the imagination of the man in the street, but Alexander was not excited about this, because he realized the quality of this army, he knew that the Persian army would not stand against the Greek phalanx, the main military force of that time. One Spartan warrior was more powerful than ten Persian warriors.

Darius also made distinction between propaganda power and the real one. Knowing the worth of the military qualities of his people, he did not want to fight. His task the Persian king saw in avoiding the battle, while retaining authority. In gaining victories without a military encounter, the Persians had a lot of experience. The Persian kings won victories by intrigue and bribery. Does it remind us of the actions of some present day rulers?

Three times Darius offered the Macedonian astronomical sums and lands as compensation. The first offer he made before the Battle of Issa. The Macedonian answered: "Tsar Alexander – to Darius... Do not write to me as an equal. Everything that you own is mine. If you need anything, let me know

in proper terms, otherwise I will treat you as a criminal. If you want to fight for your throne, fight, and do not run away. Wherever you hide, be sure I'll find you".

Darius got offended, but, after the defeat at Issa he again proposed making peace with even greater concessions. Alexander again rejected. Before the Battle of Gaugamela

Darius once again suggested making peace and unheard-of concessions. In addition to huge sums of money and territories, he offered his son Okha as a hostage. Because of the unusual nature of the proposal, Alexander brought this problem to the discussion of the military council. The military commander Parmenion said: *"If I were Alexander, I would accept these proposals"*. "And I would accept them," Alexander answered, "if I were Parmenion." Darius was refused for the third time. As a result, Alexander took everything.

The Macedonian never discussed the idea of partitioning Asia with Darius, because he did not consider him the owner of Persia. At the same time, there is no doubt that all the papers that determined Darius the owner of Persia were in order. But the Macedonian had the main "piece of paper" – his force.

The strong one never has a question of legitimizing his rights. Darius had all the rights to Persia, but the Macedonian had force, and everything fell into place. By the way, **Nicholas II** wrote about himself in the questionnaire: "The owner of the Russian land." His heirs by law had all the legal rights to the asset. But a bad luck – they did not have the force. Lenin, unknown to anyone, had only force with no rights. As a result, he became the ruler of the Russian land. And the heirs of the Tsar ... We do not know anything about some, because this is a "sealed by seven seals mystery" so far, others "were" shot, still others went abroad ... to live out their lives and resent.

In this sense, Darius was in some ways similar to the Russian oligarch. Formally, he is a kind of the owner of his assets, but in fact he is an administrative manager. His will in the domestic sphere – to buy yachts, palaces and stuff. As soon as he exceeds the limits, that is, creates the slightest threat, the situation changes. The authorities will not bargain with him for the same reason as Alexander did not bargain with Darius. He will be immediately put in his place (the choice is not rich: either obey, or to London, or to Siberia). Persian society recognized the power of the king, until he refused to take a challenge. It limited Darius strategic initiatives. For

example, he could not take the advice of the Greek Memnon, who had served King Philip, the father of the Macedonian. The Greek said to Darius: "You must not fight with Alexander for a number of reasons," and he gave the reasons. But the Persian grandees who had influence on the tsar were not military strategists, but *masters of machinery of State games and intrigues (exactly like our today's Government)*. They just did not understand the nature of the danger and the essence of the Greek advice and thought more about how to use the fact of victory in their own interests. How to defeat the Macedonian – they did not think about it at all, it seemed obvious to them, because they were victims of a propagandistic myth, too.

In this atmosphere, the hired Greek commander, the only one who realized the situation and rules of the game, was useless. He was like a man giving advice to people who can not play chess. He advises giving in the knight to mate later. But pseudo-players fall into anger because of a proposal to sacrifice a knight and begin to suspect of treachery.

If Memnon had had he opportunity to command the army, he would have compensated for the quality of the human material of the Persian army with a strategy and tactics of a high level. **Napoleon said:** one Arab will defeat five Frenchmen. But ten thousand Frenchmen will defeat fifty thousand Arabs. If the Arabs had had their own Napoleon, the advantage of the Arabs would have been preserved. But since Napoleon was with the French, the Arabs lost.

If the Macedonian had been opposed by a comparable military leader, he would not have had the chance. The Persians would have won because of the numerical advantage, despite the higher quality of Greek warriors and the genius of Alexander of Macedon. But the commanders of the Persian army could not be compared with Alexander. They were good for punitive expeditions among the civilian population. Against the military machine they were helpless, as the police are helpless against the army.

The Persian bureaucracy could not entrust the command on the Greek. Everyone realized that. Memnon realized that, too, therefore he tried to dissuade the Persians from the war. He argued: if the Macedonian lose, nothing terrible will happen, a usual military failure. But if you lose, you will lose your country. The Greek offered the tactic of "scorched earth": to retreat to the deep into the country, leaving behind a desert – to destroy crops, burn villages, towns; take the bread, the cattle. The army of the Macedonian would have died of hunger, thirst and other problems unavoidable for a large mass of people caught in the desert.

The Persian grandees, rich landowners, did not even want to listen to such an advice. Instead of gratitude, they accused Memnon of intending to undermine the country's economic might, that is, treason and other malicious intentions.

Memnon offers another plan: to send troops to Macedonia of several tens of thousands of Persian warriors. This would not effect the fighting efficiency of the Persian army, but Macedonians would have to retreat before the threat of seizing their kingdom. The advice of the Greek commander and strategist Memnon the Persian politicians were not able to hear, because they spoke different languages and pursued different goals. They did not think how to defeat the Macedonian. They thought how to maintain the habitual way of life and how in the future to get by bargaining various benefits from the king. By the way, the modern grandees in the face of the crisis are in a similar situation. They are all sure that they will overcome the crisis somehow, because, .. but...what is the other way? They do not think, they live the usual routine of the established life. And they shall lose, like the Persians.

Alexander was a head higher than the Persians (people resembling modern officials). They had a safe, well-fed life and could not play chess that Macedonian imposed on them. ***Gold for Alexander was not the way to equip his life, but chips for a game.*** A characteristic action: he invested all his resources in the army. When asked by friends and relatives, what he was leaving to himself, the Macedonian answered: "I leave my own hope to myself."

Alexander understood the peculiarities of Persian society. He knew: non-standard, but the only true advice of Memnon Persian grandees would not take. In such a situation, the king could not accept ruining his land. In addition, the king of Persia had to be present at the main battle. This was required by custom, and this was the weak point of the Persian military machine. If you shake the center (the king), the whole mass of the army, without thinking a second, will turn into a flight.



The Macedonian twice beat on this point, and Darius twice fled from the battlefield (the first time in the Battle of Issa, the second – at Gaugamela). It was not a deliberate retreat, but a flight in panic and fear, throwing everything away. The king did not save his life, because the flight was equal to suicide and meant the loss of divine status. The fled king either posed as a deity (deceived), or the gods turned away from him. In both versions, death awaited him from his own circle. Darius understood all this, but under the pressure of the Macedonian, on the one hand, and his nature, on the other, fled like a coward. He did not retreat for strategic reasons; he just fled, unable to overcome animal fear.

Persian officials, retreating with the king, *afterwards executed Darius. Then the Macedonian executed these officials* for the fact that they took the liberty to solve the issues that were beyond their competence.

What conclusion can be made from what was read in the previous chapters? **The first** – yes, it is interesting as a historical fact for the average person level. **The second** is that it is **NOT THE FORCE THAT WINS BUT KNOWLEDGE**. And the third – all the events described took place within the framework of the beginning removal of the "cupola" control of people and the preparation of a specific biomass – people with different types of thinking, the determination of their number and the picking out the prevailing number of a certain category through the physical destruction of another (in this case – the Persians).

This was the beginning of preparations for the transition to the Program of "growing" specific genotypes of the Brain under the direct "control" of the Ebr Control System. **Alexander of Macedon** was "selected" by the CS (for certain parameters of his Brain), and all the actions that he performed – **ARE THE RESULT OF THE PUROSEFUL IMPOSING ON THE EXECUTION OF THE SPECIFIC TARGET VECTOR**. On the same principle, "other significant moments in the **HisTory** "were created", which, in the opinion of historians and philistines, were "key" and "turning points".

Encouraged by Alexander of Macedon's example, we will continue training in our desire to **"get to the Bath"**.

5.3. World perception through the individuals

Among many descriptions of the universe given to the mankind, I have come across one more created by **N. Levashov** in his works – a picture of the Universal World. And, perhaps, it is one of the most realistic. And everything written (described) by **A. Khatybov** should be considered as some complementary continuation of the whole integral picture. But is it possible to say that the universal picture of the World described by them is so new and original? No! The picture of the Universal World, described by **N. Levashov and A. Khatybov** and "built" on our Earth, does not have a novelty. Motives for the Earth and its inhabitants capture and enslavement are present in the folklore of many peoples of the Planet. The picture they created is new and original in the width of its coverage and the concreteness of its description. One astrophysicist, Doctor of Science, (when I asked him to "criticize" Levashov's book "Inhomogeneous Universe") said to me: *"... only one who had been there was able to write such a thing! .."*. For the first time, they gave a vision of a specially directed "chance" in the "evolution" of Human civilization, more precisely, its degradation (especially in our time). But why do people now have been taken away the opportunity to see with the own eyes both what is coming along and the enemy (after all our ancestors saw the enemy and fought him!)? The answer is simple and complicated at the same time – only those who want to see are able to see. And the wish to want to see something and understand was taken away from people, and now very few people worry about this, even after those events that I touched upon in this or that form in the first book. **ALL SCIENTIFIC DISCOVERIES** of the Mankind – is **WHAT WE WERE ALLOWED TO BE ENGAGED IN**, and not more. The discoveries of **Tesla, Searle, Grebennikov** and many others "did not go", not because of their phenomenal approach and knowledge of the nature phenomena, but because of the particular control of the "laws of nature" by external forces (not necessarily dark ones). And this can be traced on the example of the works of **N. Levashov and A. Khatybov**. For example, is Nikola Tesla's capabilities were greater than that of the today's radio enthusiast? Of course, not – even a thousand times lower. So what is the mystery of Tesla's success? In the fact that he "found» the possibility of *transferring the energy of the higher octaves to the lower ones without losses*. And this possibility was reduced by the Ebr Control System to "nothing", first by the efforts of the financial capital (through Morgan), then by "changes" in the

parameters of our space (some spatial frequencies were changed), and then a false theory of relativity was introduced through Albert Einstein.

The effects of **Searle (JRR Searle) and Victor Grebennikov** were not related to the physical properties of the general (in our understanding) space, but fell into the sphere of influence of Ebr objects (type 440), which used the energy of these devices. Later, when moving or destroying these objects, these effects disappeared.

And what is the "theory of relativity"? This is not a theory, this is CS created a "cupola" for the Humanity already at the level of a "scientific worldview", because the religious "cupola" created by the CS for the further control of the Mankind was already unreliable. The space was developed and changed for the "new principles of the Mankind control" through science and resources for cognition, but in strict accordance with the Programmed control and "developing" the Brain genotypes.

Modern mankind has no history (**hlzTory**, but more correctly – real chronicles), nor Knowledge in the reality of perception of the surroundings. All this became the chains that Mankind was chained to the rock of slavery, because almost all the principal discoveries in the Universe surrounding us are nothing more ***than a game of invaders with a primitive human individual***, it is like in a kindergarten when blocks are placed surreptitiously for the children to "accidentally" collect the given figure. And this is declared the discovery of the law and "new knowledge"!

To control the Knowledge invested in the Man from the outside, one must take away his inner Knowledge. And it is not so easy to deprive the Human of his inner Knowledge. The invaders' Control System had been engaged in this for **18,000 years (!)** and still suffered a defeat.

From the point of view of our level of development, it is almost impossible to determine ***what the Man was 18,000 years ago***. It is possible to describe in words the lost properties that our Great Ancestors possessed, but this will be only a verbal description that practically can not be transformed into the inner structure of Man in an appropriate level for adequate understanding. You can try to explain to the blind all the beauty of the rainbow, but it is unlikely that the verbal form of the essence of this phenomenon will help the blind to perceive and understand the world of the magic rainbow. To perceive and understand this kind of phenomena so that further development could take place, there is a need in rather intensive inner work and the main factor – the genotype to which Man belongs. ***The body and genotype of a person is like a car – you will not go far***

and fast on a bad one. And you should not take the concept of a genotype, as something negative or provoking rejection. **All of us are the "product" of the millennial work of the Control System.** But today, suddenly, through the works of A. Khatybov, we have known about the Brain genotype, read about the Spirit in N. Levashov's books, about its development, and began to "ponder" over that – "where should we place ourselves?" To which genotype? And after knowing – what to do with it! With great humor, **A. Khatybov** answered this question in one of his articles. I will give you this answer further, practically without changing anything.

Outwardly, the human body is symmetrical. The axis of symmetry passes through the middle of the body, dividing it into two equal parts. But for some reason this symmetry is not observed in the internal structure of the human body. A person now has one heart (there were two before), one liver and many unpaired organs. Ebrs had worked well on these changes through their CS. **"Paired" internal organs, provided for a person both the length of life, and no diseases throughout life. THERE WERE NO DISEASES AT ALL.** After reading the above you can independently answer the questions: "Where did the diseases come from? Result of what are they? What consequences in the development of Mankind did all this have," **95% of the Human Brain resources are blocked**, a division into the conscious (5%) and unconscious (95%) are made. This was specially made to **NARROW THE FLOW OF THE PERCEIVED CONSCIOUS INFORMATION.** This allowed the invaders to slowly transfer the Man (with the help of "scientific" technologies) from the analogous perception of the world to a discrete one, to reduce everything to binary manifestations. Have you noticed that today digital sound and image almost completely satisfy the Man, while surrogates of food and artificial flavor additives do not cause rejection in most people, **which indicates to a successful narrowing of the flow of every day life information.** If Ebrs had wanted to leave Man as he is now, then they should have digitized Man's taste and touch and sense of smell – but this was not necessary for the invaders. The latest "invention" in terms of destroying Man as a personality is **DIGITAL TECHNOLOGY OF ALL KINDS.** This is much more terrible than atomic weapons. I hope that there are many who understand why. Ebrs did not need Man (in our understanding). They needed only a new "shirt" (a new Human body) of a certain **4XX genotype**, where they could insert (transfer) their spider's brain. And this "people's poultry factory" would have been necessary to them only until they have figured out the "secret" of the Man's Cell being. And all these studies would have been developed and made

by the people themselves. But these Plans are already in the past. It remains to clear off the garbage and regain our human cast of mind. To regain – but only through **Cognition and New Knowledge**, and also through the itch to "get" into the Bath.

Artificially "cultivated" and inoculated into Humanity genotypes (**4XX type**), invented epidemics (back in the Middle Ages) – all this could exist only with the frequency support of the invaders' Control Systems. Since the 60s of the last century, "psychotronic" generators (the first experiments: the hysteria and success of "**Beatles**", the beginning of sexual revolutions, the falsification of the flight of Americans to the Moon) were widely connected to such frequency support, which in the late 1980s were destroyed by *N. Levashov and his Friends, about which he wrote in his books*. But we have to understand that Levashov did not tell us everything, but only what could be public at that time.

Now there are about 7 billion people on the planet. Out of these, with the Brain genotype **42 – 1 billion (golden billion)**, with the genotype **44 – 1 million (golden million)**, with the genotype **46 – 10,000** (should have been launched **in 2009** –but failed). With the genotype **48, 100** people were to be created, but it did not take place due to the destruction of the CS of the invaders. They would have been the "bearers" of this genotype of the Brain for the **Supreme Eternal Hierophants by 2012**, for the world government and the top of the Corporations. All these representatives of **4XX** genotypes can only be conventionally called human beings, for the higher the number **4XX**, the farther this representative is from the Human. The main qualities of representatives of **4XX** genotypes are the lack of morality, parasitism, homosexuality, sexual perversions, rejuvenation with the help of stem cells, and much more, which is not characteristic for the indigenous Human of the Earth. To be more precise, it can be said that until recently, not only morality had been ruined, but the bearers of the human morality, – people having alpha-genetics, had been systematically annihilated. This was done by the hands of the people themselves. They were set on to fight against each other through manipulation of their Consciousness, "introducing" false values into the society, false Knowledge about the World that surrounds them, including various religious trends. This kind of "performance" and voluntary and involuntary participation in it, in the production of the invaders which is called "Life", people, living it through, passed from generation to generation. Now this kind of "life " goes on, but already depending on the knowledge gained by each individual.

5.4. How to get to know?

So, *how to find your genotype of the Brain* and those around you (this is also interesting)? Who in this case to apply for? Could it be the "experts" on the Brain? They are more than enough today and, especially, in the present Government. First you have to fill out the Form (Questionnaire) on your own (See **Application 1.**)

But the Form (Questionnaire) can be filled out by the "applicant" only if there is a Matrix of his Brain that is stored behind the "seven locks" in the Kailas Complex or in its "peripheral complexes" (as a duplicate for special merits and "advancement" in knowledge).

It is necessary to understand and not to worry that the "permission to see" and further use is given only by the Control System of the Complex after the presentation of the complete Questionnaire given in the application.

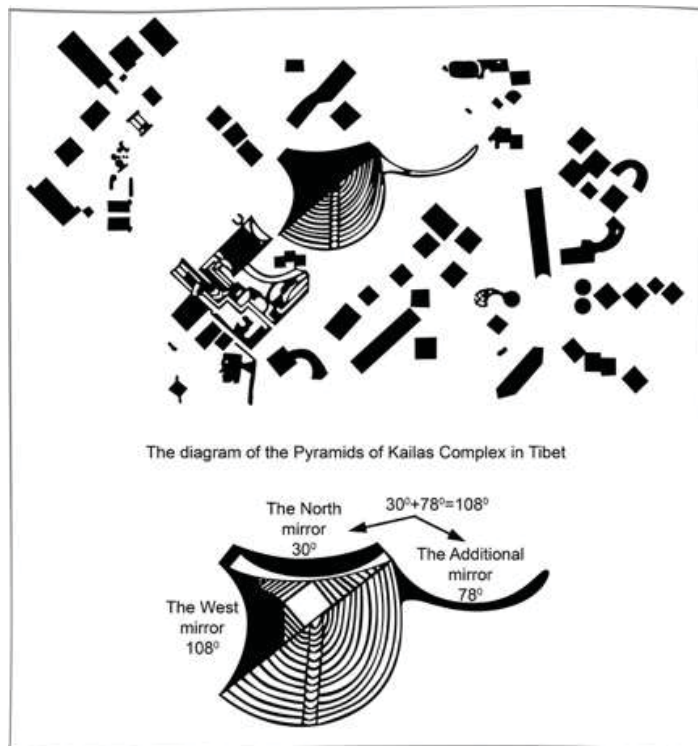

Diagram of the main Pyramid of the Tibetan's complex – Mount Kailas (top view). Three giant stone mirrors are shown.

Before filling out the Form (Questionnaire), (**Application**) it is advisable to have a medical examination for the general state of the "shirt"

(physical body) of the "applicant". It is not forbidden – in the district clinic, at the place of residence (habitat).

Sequence of the preliminary work:

- print out the Application in triplicate on a jet black and white printer;
- prepare a photo (3 copies in black and white) and stick on each copy;
- Surname, name, patronymic (no nicknames, for example, "Luzhkov" – indicate the real surname);
- date and place of birth according to Methon (if it is not clear what it is, you can use the usual calendar);
- we compile the "code parcel" and send it to the control system of the Complex, with subsequent notification;
- upon receipt of the permission (notification) – waiting for the number of the Admittance Series;
- decoding of the series, the translation into the Matrix of the actual structure, the translation from the Matrix to the language accepted in modern medicine is done directly to the "applicant";
- coordination of special cases (sometimes it happens when the "applicant" and the information coming from the applicant are not real and false) is carried out directly when filling out this Questionnaire.

The total cost of the work (state duty) is 700 euros.

Two days after the series is issued, the Control System of the Complex (or its periphery – at the request of the "applicant") transmits data to the Matrix Correction upon receiving applications for "Generators Production" and transfers the Applicant Brain to the execution state. *Here comes the information with a long-awaited answer – what your genotype is.*

The total time for normal initial execution (and the correct filling out of the Questionnaire) is 72 hours. The Questionnaire can be viewed (download for using) in the **Application** to this chapter.

And now seriously. The joke on this subject of Alexander Khatybov is quite appropriate and rational. However, regarding the provision of "opportunities" to identify belonging to one or another genotype, I'd like to say that this is a very dangerous and problematic process. *I'm sure that as soon as such information leaks out in some hints, there will immediately be a numerous group* (as Boris Makov called it, and I

completely agree with this precise expression) *of the Gesheftmachers, which will not only bring to large-scale panic and confusion, but also will immediately transform it into the sphere of gaining profit and spreading lies, organizing feud that can lead to military operations.* Therefore, the information from A. Khatybov, in my opinion, is more than enough. Therefore, this subject should not worry anyone today. And those few who know what is hidden on this subject let them think what they should do.

5.5. Developing the subject

Bodily we look nearly alike, but as for the Brain – it is far from it. And these differences can not be overcome either by upbringing or education or social status, – by nothing... Now you know why.

You should not waste your energy, time and your means on persuading, re-educating or refashioning anyone – it's absolutely useless. This is particularly important for those people who sincerely hope to change in a certain person what he does not like. The most that can be achieved in such a case is mimicry, i.e. imitating what you want to see in him or her. Are any real changes possible? All this I told **N. Levashov**, defending my point of view in our conversations. It was important for my understanding of what was going on. And what was happening to people at that time, as well. Why did I say this to him? Just because I have come across very few people in my life who listened to my conjectures (sometimes just crazy, as I see them now) as carefully as N. Levashov, without interrupting me and never showing me his superiority in both Knowledge and understanding the world around. If I was wrong in something, he always found some life examples to convince me. And then I agreed to him, realizing how much I still had to learn in order to somehow "come closer" to the level of knowledge of this **Man**. And now, thanks to my personal experience, I believe that a scientist is incompetent or an idiot, to put it mildly, if he is not able *to explain to the senior pupil* the essence of what he does (I mean the scientist) within 2 hours.

At that time, I was just sure that at the first opportunity the person tries not to think at all... The brain is the idlest, most lustful and most useless part of the body that absolutely does not want to work... The brain would rather deceive, steal, simulate, than make the work well. It seemed to me that in the body there are special substances that are secreted specifically so that we do

not think about anything profoundly, but only think about the pleasure – food, reproduction and dominance, i.e. about who is the most important. Genetically fixed instincts, I thought, can not be changed in any way – you can only force a person to do otherwise. This is the basis of my talks with Levashov, in which I even tried to "convince" him not only in this, but also that if you are not able in one way or another (physical, economic, or some other) constantly **keep a person in check**, in a certain framework of behavior that you need, then you have to get rid of such a person, and not waste your life hoping for the best – it will not be better, it will only get worse. The word "get rid" does not carry any criminal subtext. You can just strike off your life such a person or almost always you can "step aside" yourself. I had to reconsider almost all of my positions on these subjects, and in a rather short time, thanks to my talks with Nikolai Levashov.

Here we come to today's most topical question, "tormenting" people and, especially, **Users of the "SvetL" Programs**, who already in many respects "for some reason" began to understand objectively, but while interacting with people, communicating with them (and even with their loved ones) they can not understand in any way – why **THERE ARE SO FEW WHO CAN HEAR OR LISTEN TO THEM**. The wolf by its Brain differs from the fox less than we do from each other. In many cases, one Human has some structures in the Brain, and another has none of them at all. Therefore, it is just impossible to come to any agreement for many people ... It has already become obvious for many people in real life. But very few people understand the reason. You should not be surprised that someone does not hear you and does not understand, despite all efforts on your part – that person either just does not have the Brain structures necessary for this, or the information perception is much lower than your capabilities, or there is something, but has long died because of the banal problems with blood circulation, for example. **Therefore, if you are not heard of, not understood and not even tried to be understood – leave them alone and go away** All attempts to "knock until you are heard" will be as successful as trying to fill the sink with water when the sink is open. A sad feature of the Brain is that for the rest of the body it is becoming a foreign body today. *That is, the information flows, influencing the Brain development are so powerful that the Brain (though, if it exists) "is developing" fast and does not have time to "pull up" the development of the body (shirt) to the proper state. And this reveals itself by progressive diseases and other problems.*

At one time N. Levashov drew my attention to this fact, describing the case with "his burnt nerves" and described it this way: *"... the qualitative Brain transformation made by me was accompanied by a qualitative change in the Spirit of Man, creation of new bodies of the Spirit, which the Man had not possessed before my interference, but without creating them, it was just impossible to create new qualitative structures, or to create qualitative structures of the Brain without a corresponding qualitative change in the Spirit of Man was dangerous. The activation of such structures without having the corresponding structure of the Spirit could severely destroy the Spirit of Man or even completely burn it out with the power of the flows of matter passing through such structures. And this is not said for effect, but the real truth! Without qualitative harmonization of the human brain structures, this is exactly what can happen. And this is a fact based on personal experience. During some work that I was doing, a powerful flow of matter, going through my body, burned out the nerves of my right hand. The sensation was far from pleasant. I, for certain reason, could not interrupt that work; I had to finish it, despite very acute pain. The nerves of my right hand practically became charred because of the excessive load; The feeling was as if molten lead was spilling through the nerves inside the arm. After finishing the work, I not only restored the destroyed, but also qualitatively changed everything that was necessary to harmonize qualitatively the structures of my brain. And since then I have always adhered to this rule – **any qualitative changes in my brain I accompanied with appropriate qualitative changes.** Therefore, taking into account all of the above, it is of fundamental importance in such work to get the most reliable information about what kind of current changes take place during my current work."*

This is a very important point for understanding the following. Before I tell you what the Brain really is, based on the information I have, thanks to N. Levashov and A. Khatybov, I will try to describe some, in my opinion, important points that prevail in the thinking of many people. However, when I start talking about this, there are many who do not want to see or hear it. What I'm writing is just information that can be accepted or not accepted and that is "known", but it's extremely difficult even for some **Users of the "SvetL" Programs** to do something taking into account this information.

So, for the first grade. Suppose the Brain in an excitedly working condition consumes **35%** of the energy available to the entire body of **70-80 kg** (some, however, exceed these parameters, but it's not so bad), people try to do everything possible, to make the Brain not work. All the Control

Systems imposed upon people are designed this way considering it were exactly they who invented the control of their own kind. If a ready solution is offered, then the Brain starts saving energy and consuming only **9% of all energy** instead of **35**. In particular, all religions of the world and all state systems are built this way. But you should understand that all this is imposed with certain goals, which have been considered in the previous chapters. The fact that in the Brain there are "special mechanisms" for maintaining Baboon (monkey), rather than Human behavior – *this is defined as the "law of nature"*. Of course, Nikolai Levashov not only emphasized the fact that when the Human Brain absorbs quite an amount of information accumulated by Mankind for all its historical existence on the Planet Earth and qualitatively comprehends this information, the Brain neurons are structurally and functionally changing (to a greater extent at the ethereal and astral levels). The information received by the Brain make it possible for qualitative structures to develop. Only after the opening these structures (neurons of the Brain) the Brain acquires a new quality – the rudiments of Reason. Moreover, there is a **MINIMUM VOLUME OF INFORMATION** (critical mass), which is necessary for the **RUDIMENTS OF REASON TO ARISE**. We will return to this later.

Going back to the question of faith and religion, what I am asked about constantly and people ask for "advice" what to do?.. In my opinion, there is only one advice – if you are a believer, stop dealing with this nonsense immediately (and believe me, here I do not offend any feelings of believers). If there are believers in your close circle, of course, mix with them, but all your attempts to "convince them of something" will not bring any success. Any religion, any belief is **A LACK OF KNOWLEDGE AND UNWILLINGNESS TO KNOW**. And reluctance to know is an awfully infectious thing (it is enough to have a look at the number of people buried in their iPods and feverishly waiting for the change **of model E for model G**). In my opinion, everything related to religion reduces the size of your Brain, which is already not so big. This is stated both in N. Levashov and A. Khatybov's works. One quotation from A. Khatybov *"The direct evidence of the absence of science is the presence of the church ..."* says a lot. In all that concerns your social life, try to reduce any contact with state structures to a minimum, because it is already impossible not to understand what is happening to those working "behind the Kremlin wall" and in the state structures. If you use the Head (Brain) and at least occasionally spend 25-30% of the energy to support it, the "safety" of your Brain will be much better. Here, **the "SvetL" Programs** will help you, which were created for

that. See for yourselves – chess is not an intellectual game, as we were told at school. Computers are a wonderful way to control a semi-literate population, divorced from the reality. As for the Social Networks, which are supposedly invented for the people to mix, there is nothing to say. Dear readers, some of you still have a minor opportunity to stop using handhelds, tablets, iPods, iPhones and other debilizators. Do it before it's too late. The newspaper **The New York Times** recently (January 2016) published an article stating that the Technical Director of the largest US online auction eBay sent his children to the school located in **Los Altos, California**. The same was done by the employees from other Silicon Valley giants, such as **Google, Apple, Yahoo, Hewlett-Packard**. For education in this school they use the usual, not related to the latest technology tools: *pens, pencils, sewing needles, sometimes even clay, etc.* And not a single computer. Not a single screen. Their use is not allowed in the classrooms and not encouraged at home. In the US, and in our country, too, schools are in a hurry to equip their classes with computers, and many politicians state that not doing this is just silly. However, the opposite point of view has become widespread in the very *epicenter of a high-tech economy*, where some parents and teachers make it clear: *the school and computers are incompatible. This is called the "breakthrough" of the information of Knowledge.*

I am sure that today a more individual way of life, as less as possible associated with the social environment, is a prerequisite for increasing the Brain size. And vice versa, an active integration into the society brings to a steady decrease in the size of the Brain. You should not "apply" the experience that remained in the past. When taking something from there to apply today, you should remember – it shall not work like it did. I wrote about this a long time ago, albeit somewhat in another connection, that does not change the essence of the matter. Most important, try to ensure that someone's interests, if possible, never rise above yours. You can live anywhere, with anyone and do whatever you like, but you, your deeds and your desires, especially in Cognition, should be your **number one priority**, and not as it is excepted with most people – first someone's interests and needs, and to yourself – those leftovers after this headache, if at all anything remains. Although for the sake of justice it should be noted that a large number of people have a *lifelong "headache" – called life.*

In general, no matter how sad it is to admit, we all live in an animal world according to animal laws. Even television programs are telling you about it. No matter how incomprehensible it may seem to someone, but in

the behavior of most people today there is practically nothing human – only “animal” habits and instincts. It's not just me, who is telling you that but many others who, in spite of everything, are striving for Knowledge. In what we say, write, ride on Mazda-Volvo Mercedes cars, go to work, give birth to children and so on, there is **NOTHING OF HUMAN**. In all this there is nothing that makes a man – a Human, and not a monkey. *The overwhelming majority of people on this planet does not create anything, but only serves a bunch of the main baboons engaged in a fight for natural resources, their ransacking, theft from each other and the reluctance to come to any agreement at all about anything.* And when they can not agree, they cut out someone. But this is for understanding in the "first grade", but for a different understanding these are exactly the objective processes that we all living today go through. Only those are able to understand this who are dreaming of "**getting into the Bath**" today, and before that – to know (Cognize) what the Brain is.

5.6. The Brain problems

There is a widespread view that the **resources of a Man's Brain have no limits**. The brain of a man does not care about the semantic content of its own work, if it does not bring to an increase in the energy potentials of the Brain itself and the reflection of this on the body, but as details. For this reason, a man can with the same conviction believe in green men, the afterlife or cosmic teleportation. The naive confidence that the hidden **BRAIN RESOURCES WILL BE OPENED THROUGH DREAMS** has been warming the soul of lazy and idle people for many millennia. Unwillingness to objectively assess the "shortcomings" of your own Brain leads to bizarre fantasies in art, religious delusions, and brings down the objectivity of perception of the surrounding world. The latter is specially expressed in most of people. This is my opinion, and, of course, you may not agree with it. But if you look at it objectively, then you will see that in the state of "eternal rest" is the Brain of the greater part of the population of our Planet. If this "happy" state is reached by the Brain, it is immediately preserved under three simple conditions. It is necessary that food should be sufficient, reproductive results should be achieved, and, in particular, the conditional stability of the social status should not worry. In other words, the Brain is passive if reproduction of one's like (or imitation of this process) is well set, and the level of dominance does not cause any trouble. Usually it is

enough to be sure that there are worse than you or that everyone around is not so unique. If such a simple self-deception is enough, you can safely move to the sofa, TV or computer and through it to social networks, since conditioned external stimuli are necessary for the imitation of the Brain life. As a result of this energy stabilization, the Brain reaches a state of complete biological happiness. The consequences of such "happiness" are not difficult to predict, although, depending on the circumstances, they can be individualized. As a rule, lovers of the instinctive and hormonal way of life successfully manage without special intellectual efforts. In my opinion, in conditions of total idleness, the Brain continues to work according to the same physiological laws of the workaholic. Unfortunately, and this can be observed in modern people, it is not able to work intensely for long. The brain does not "like" it. It finds sophisticated ways to reduce thinking and related to its energy costs and seeks to return to the bosom of idle happiness. For example, the teaching of **I.P. Pavlov** was focused on the study of unconditioned and conditioned reflexes. But, adjusting Human psyche to it, **WE CEASED TO THINK OF OUR DEVELOPMENT** or, more precisely, of the cognition of development; and conditioned reflexes took for the higher nervous activity. As a result, we began to "study" the cerebral cortex, and the fact that Nature **HAS COLLECTED IN THE BRAIN ITSELF** for billions of years turned out to be as if of no interest. Take the theory of relativity, which in the interpretation of A. Einstein claims that *there is nothing faster than the speed of light, although today, all this "speculation" of scientific dogma has already "collapsed"*. Where, then, excuse me, the thought has disappeared in this case – the "substance", instantaneously spreading over huge distances? It was simply thrown out of our use. It was very convenient for those who defended the position of conditioned reflexes, limiting the resources of people. Now you know what for and who by it was done.

But that is not yet all. Here is what N. Levashov wrote about in this connection: *"Our civilization was subjected to the impact of astral Generators, which were located in 99 energy nodes of the incoming energy flows. The astral Generators created such an energy structure, which provided the birth of people with ready-made robotization²⁴. And only the Spirits of a very high level of development with great potential could, by restoring the normal structure of their bodies and energy, actively develop*

²⁴ Here we are talking about the use of objects 440, through which all this was implemented.

further. Such people were physically eliminated, without giving them the opportunity to enter a new qualitative level and expose and destroy the structure of robotization²⁵. When a man was born with a deformed structure of bodies and energy that was ready for robotization, it was just enough to "include" this person in the general Control system, which was achieved by upbringing and education, which required of man to be only the ideal "cog" of the universal mechanism. Morality and philosophy served the same purposes. Often, indeed, the highest spiritual and moral universal values served as bait for people seeking truth and purity. The impact on people was on the ethereal, astral and mental levels, of which, unfortunately, most people have no idea. And those few who thought about these things were fed up with such information that pushed them into the logical labyrinth, only very few were able to get out of it ... After the biorobot structure had been formed in most of the people, it was only left to create a controlling psi-field for guiding them. On the planet Earth, for several thousand years, psi weapons have been used on a larger or smaller scale, and the very fact of their application has so far remained a "mystery under seven seals" (except for the "initiated"). The "Initiated" tried to prove to everyone else that any thought of psi-weapons and its use was nonsense, absurd. And in the meantime, very actively and effectively they tested it on those who had been convinced of the impossibility of its existence..." "The same thing you can find and in A. Khatybov's works with explanations, framed in the form of concrete physics processes calculations of the Generators work.

Until now, in official science, there is no general concept on the place and role of Man in Nature. Therefore, there is no question of **any taking the Bath**, let alone the **application of the "Broom of Knowledge"**. One of the most profound secrets for Man is the perception of the very fact of the ongoing physical process, under which the harmony of the internal states of the functioning Brain and the external states of its Control is being formed. But in order to move further in this direction, you have to have at least an idea – **"what our Brain is"**. I am quoting here what A. Khatybov wrote about this (as always with a great deal of humor), providing this text with my comments, which is public (out of all that is published today in his works on the Brain). But this information will be enough to comprehend it, and to **queue up to the Bath**.

²⁵ Implementation of the Program for the Development of Genotypes of the Brain and the elimination of what tried to be developed in spite of this Program

Modern science has unlimited technical potential, which allows it to deal closely with the problems of the Brain. As is known, the Brain, for the majority, is located under the cranium, **SO THE SPACE OF RESEARCH IS KNOWN**, and does not require significant expenses for storing individual elements of the scientific research subject.

Virtually all countries, including third-rate ones, such as Russia, have either Brain Institutes or special medical departments. This may be the Institute of Man, and the Institute of the Brain (in St. Petersburg), and the Institute of Psychiatry, and so on. The main task of research and researchers is to determine whether the Brain affects the life of a Human. For these purposes, volunteers are selected who guarantee that they have the Brain. These volunteers are "put" into electronic devices and the experts find the facts that are of interest to medicine and all progressive mankind. As, for example, that in some cases the Human Brain, while maintaining Consciousness and absolute capacity, is actually in the state of coma according to the indications of these devices – but this is only according to the readings of the instruments. And, for the detection of pathologies, including in the brain, it is generally accepted and honorable to undergo an MRI, after which pathologies, even if they did not exist, have an excellent chance to appear exactly thanks to it.

Based on these studies, the long-term planning of pharmacology, the production of medicines, clothing, housing, vehicles, recreation, etc., is made, as well as conferences on knowledge and cognition are held. The studies conducted in this way have recently established the fact of the lack of the Brain in a human being, and the structure of a man himself turned out to consist of a mixture of solid, liquid, gaseous and other constituents, and the very concept of a "living cell" lost its meaning.

The basis of all scientific knowledge, applied in this case, is the theory of Darwin and that monkey, that first grabbed a stick; in other words, some individuals, according to Darwin's theory, descended from monkeys. Of course, the Brain evolution did not start with a monkey, but a little earlier.

As modern science proves, after the Earth formation from a protoplanetary cloud, dust residues (not suitable for the formation of the Earth's surface) formed a living cell through chemical reactions. Any schoolboy can reproduce these chemical reactions at chemistry lessons. There are some who, of course, can object and open an awful secret that the **LIVING CELL** was brought to the Earth from another planet. But there is

a harmonious, time-tested theory of the Big Bang, when the whole of the Universe, or the Cosmos, was located at the point. This point exploded, and its fragments formed dust clouds, transformed by chemical reactions into Stars and Planets. Thus, even if the living cell was brought to the Earth from another Cosmic body, then this body in its essence also consisted of the same dust as the Earth; therefore, it makes no sense to refer to other Planets. The method of transporting living cells in the Cosmos has already been studied in some Academies, and the science of Astronomy claims that **on the Earth** it is possible to reproduce any action occurring in the Cosmos.

Living cells, gathered in a critical mass, formed for themselves (possibly by voting), a totalitarian control system, to which the cells themselves were not allowed. Over the time, this *control system* entangled all the cells in the nervous system, making them separate in the style of bipartisan systems – in muscle and bone.

It is known that the control system took the best places (hiding under the skull), divided into two parties (the left and right hemispheres). Having at hand quite a strong means of influence, the control system forces all cells to obey by flashing them with an electric current. Improving, the control system formed a powerful bureaucratic apparatus under the skull, dressed in a gray uniform.



In the struggle for their existence, the control system created a powerful defensive line, covering the outer surface with a dense network of trenches and entrenchments – the so-called convolutions (it is established that the more convolutions, the more intelligent the man is, which roughly corresponds to military terminology – the more ravines on the ground, the better actions of cavalry).

With time, they (convolutions) became unnecessary, except as a museum exhibit, and for a well-organized brain, it makes no sense to keep more than one trench (a convolution) in working state. In addition, into these trenches you can dump unnecessary information, then you have to restore abandoned trenches. With the advent of phonograph records, some suspicion arose that the Brain used the principle of recording on these plates and tried to take out the information trash that had lain too long in the trenches.

Science proves the use of gymnastics, but has not yet come to the conclusion that **MENTAL GYMNASTICS** is **BETTER** than **PHYSICAL**.

On the example of the Brain, we can say that the more the cell thinks, the more slender it is. Brain cells, unlike stupid working cells, do not get fat or lose weight, that is, they are always in shape. ***You can "pump" the muscles, but you can not "pump" the Brain.*** Exercises are contraindicated to the Brain.

As in the organization of dacha keeping, waste withdrawal systems are located away from the house, but valuable waste is closer. Sulfur is the waste of the Brain's activity, which is ejected through the ears. According to the spectral analysis, sulfur in the ears is close to white oil, which is a valuable raw material. The brain rationally arranged the distribution structure of food products by "fixing" the mouth and nose closer to itself, and the most delicious things first are tasted by the Brain, and the leftovers are dumped in the stomach, where everything is arranged like in "public catering". There is an expression – "melting in the mouth" – it just does not reach the public catering.

Nostalgia for the ancient fern thickets led to the creation of artificial plantings, which seedlings are passed to epithelial cells. True, some Brain structures were developed under desert conditions where there was no vegetation, therefore there are no artificial plantings (hair) in their locations, as there is no sense to keep expensive seedlings requiring special care – constant washing using **"WASH & GO"** ("Running louse "), waving, coloring, leveling, etc. Depending on where the Brain cells were originally formed – in a dense fern forest or in the desert, there are expressions: ***"tear hair on your head"*** and ***"sprinkle ashes on your head"***. In meaning they are the same and express one of the types of working cells strike.

It is known that the basis of the thinking process is gravity. An example is Newton's apple. The brain can not stand an independent flight in conditions of gravity – when the Brain falls from a height of even 10 meters it breaks, at the same time the working cells jump on their feet. The reverse action, expressed in the fall of foreign objects on the head, for example, an apple, does not cause any functional Brain disorders, but **PROMOTES IMPROVING THE THINKING PROCESS** while falling foreign objects on the working cells causes trauma, fractures, and the condition of the working cells deteriorates sharply. Therefore, even in football, they try to catch the ball with their heads, and not with their legs (so as not to injure their legs). It is noticed that when you are in the toilet (when the waste is removed from the intestine), there appears an interest in reading. There is

nothing special here – ***the change in the overall gravitational component leads to the activation of the thinking process.***

Taking into account the role of chemical reactions in the creation of the control system, the system itself is thinking about the problem of automating all functions by replacing the swelled staff with a transistor analogue (artificial intelligence). Like all people's chosen ones, the control system is especially scrupulous about the privileges – from food to habitat. If an ordinary cell, for example, is quite satisfied with dextrorotatory sugar, then it makes the control system sick. If the ‘toiler of a bone” is perfectly comfortable with any atmospheric pressure and even its instantaneous changes in a wide range, then the scrupulous control system immediately closes all the windows and doors, shutting itself up.

With time, it became unprofitable to govern from one center, so local self-government bodies were created-the spinal cord, with the passing of motor functions to it. Some biologists believe that the spinal cord was first formed, but here it is appropriate to recall that the Brain did not follow the path that is used in an unreasonable life – to pick everything up for itself. For example, biologists know that unicellulars perfectly process fats and amino acids, which in their structure are higher than the unicellular themselves. The brain ignored all this and created enterprises for such processing without interfering in the production process. Of course, the liver, kidneys, bile ducts, gallbladder, etc., perform the same functions as unicellular ones, but the brain does not participate in this process. Of course, **THE BRAIN ARE THE MOST INTELLIGENT CELLS**, so for the remaining cells it is sufficient to use a binary code of the "**hay-straw**" type. By analogy, the transistor analogue of the Brain should work in the same way – **beat-no beat**, that is, there is continuity in the governing. Since the conceptual basis of modern physics is built on the model of the Bohr atom, and everything that we see can be touched by hands, the Brain tends to be in a state far from plasma. You remember that the material body is the foundation, and the next transition process (especially the final one – plasma) is less attractive, that is, everything that is known about the surrounding world and what we all "use" today, especially by using the physics textbook by **A.Peryshkin: *solid material body – liquid – gaseous – plasma.***

Of course, a more stable base is preferable for the Brain, that is, closer to a solid material one. The state of plasma, where, according to Landau, *the magnetic impulse is ahead of the electric charge*, it is unacceptable for the Brain, since there will be no one to control. It might be possible, of course, to

give some examples, but they will cause unhealthy interest of the vertically integrated

"Elite" and the itch to "know" this with the further possibility of applying it (to test on many ones).

The replacement of the control system does not lead to any serious changes, therefore, measuring (using a voltmeter) the voltages and currents in the neurons, you can safely choose the best analogue and conduct cloning. **THE BRAIN IS NEVER ILL** because it is clever. True, the Brain, which was "on the sly" and became a user of **the Programs "SvetL"** is even smarter. Only working cells suffer from diseases. If the Brain happens to be unwell in the form of a headache, then it is removed by using simple pills of aspirin type. While treating working cells there have been developed and manufactured millions of names of medicines. The brain, for example, can not get sick with a venereal disease or **AIDS**, because (according to biology) this is the business of working cells – *rub against foreign objects*. The brain, of course, does not participate in either sexual intercourse or fetal growth (in women), all these are the results of chemical reactions and the friction of epithelial cells (according to modern biology). Similarly – with the help of a stick and flint, the ancient ancestors made fire – here there is both friction and a chemical reaction. To listen to music ears are attached to the Brain, which are the source of all low-frequency information. With time, the Brain has created (from the waste of the epithelial cells) the intelligence service and the receiving and transmitting center for communication with residents, the so-called cerebellum, supplying the Brain with all the latest news and commercials. Perhaps for this reason, the removal of a part or whole of this fragment of the Brain with surgeons' submission plunges Man into a certain state that can be called "he is not himself", for a fairly long time. It's like if it's suddenly denied access to Internet social networks, but after a while these "inconveniences" are disappearing, and the Brain finds another source for getting the necessary.

The most valuable organs have a double (eyes, ears, hands, feet), the low-valued do not have a double (nose, mouth, penis). Concerning the low-valued organs, science assumes that they sometimes work independently, then causing the Brain's displeasure with the consequences. Especially valuable Brain, having achieved perfection, is covered with a calcareous solution and stored as a standard. For better preservation, especially valuable cells are transmuted into coal.

The Brain is surrounded by the Hubble sphere so that the Cosmos could not harm it. It is not possible for the Cosmos to penetrate into this sphere. Naturally, the Cosmos can not know what is happening inside the Hubble sphere. Like all material bodies within the Hubble sphere, the Brain is subject to collapse, that is, compression. In medicine, there are varieties of this process: menopause, sepsis, schizophrenia (separation of the Brain), paranoia. Like all normal closed control systems, the Brain is able to view itself (eyes), listen to music performed by a number of Brain cells (ears), and also perform facelift and overhaul (surgical operations). The highest achievement of the Brain is *the thinking process*, when material bodies, moving on colliding courses, exchange information (see Brownian movement).

If you look closely into the textbook on biology, you can find out that working cells can do without the Brain for some time.

The structure of the Brain (see in the same textbook on biology) is quite simple. The structure of the body can serve an analogue, for example, a tiger, which is shown in detail by a trainer in the movie "The Striped Flight". Each highlighted part is of undoubted interest to the cook, therefore a similar conception of the Brain (biology, medicine) makes one come to the conclusion that not only the human body, but the Brain is considered by modern science only from the cook's point of view. If the trainer's explanations that the tiger has an udder, causes laughter, then the explanation of biologists that **THE GRAY MATTER IN the man's CRANIUM IS THE BRAIN, DOES NOT CAUSE ANY LAUGH.**



It follows that the *foundation of modern knowledge of the Brain is laid down by cannibals, and this foundation is acceptable for the whole civilized Humanity*. From the point of view of the cannibal, not every Brain is delicious – the brain of a young lamb is considered a delicacy.

The perfection of the Brain at the present time is that no one of the working cells can reproach the Brain for developing in the wrong direction, and the opinion of the majority is always true.

The result of the Brain development are all the processes taking place on the Earth, including the formation of weather, although the Brain does not know about it. Having attained perfection, the Brain is already able to look beyond the Hubble sphere and consider the rest of the Cosmos as the sphere of its interests, as can be seen by making your Brain read the books by N. Levashov. At the same time, coming across similar protoprotonic formations on its way, by virtue of its perfection, the Brain is able to form an additional control system by connecting the new System to the civilized world.

Actually, this is exactly what N. Levashov did. He said that under the transformation of the Brain, a person could consciously get out of his body in principle at unlimited distances! More precisely, the distance of the Spirit's (Brain's) moving from its physical body is determined after the Brain transformation only by the qualitative level of the Spirit's (the Brain) development and not by the "length" of the silver thread between the body and the Spirit²⁶, as in the usual case. If the Spirit, after the Brain transformation, "comes up against" any qualitative barrier and is not able to move further, it is enough only to create new properties and qualities that are lacking and... forward!

5.7. We have no conception of the Brain

One can agree with this, or disagree, but the Brain does not exist in our conception or imagination or touch. We can not examine the Brain under a microscope, cut it with a scalpel. ***"We do not even know what the Brain is"***. And before proceeding to consider any "interaction" with the Brain, and more so – **the "SvetL" Programs** in questions of "opening" the Brain or understanding how and what for N. Levashov "opened" the Brain

²⁶"The Thread" connecting the Spirit and the body (shirt) when leaving the body.

(though, not to all wanting), and what those with whom it "happened" and is going to happen in the cause of their Brain interaction with the "**SvetL Programs**" understood this, we will try to make clear this phenomenon. Let's apply objective data (obtained for more than five years), **ANOTHER KNOWLEDGE STRUCTURE** and **ANOTHER INSTRUMENTAL BASE**. I am saying right away that the instrumental base built on horse science is not suitable here (as Khatybov used to say, and it's hard not to agree to him, the basis of modern physics is horsepower). We have to consider not only the Brain, but also the Information field (space), without which the Brain can not exist.

There is no technical means to analyze the work of the Brain, – one can only analyze the consequences (at the proton or biological level). Changes in biological structures do not mean a change in the structures of the Brain (the Spirit), but indicate the properties of the Brain to protect themselves from unfavorable conditions by changing the properties of high-frequency lymph. If we take it in a simple way to understand how N. Levashov managed to "create" duplicates of his Spirit (Brain), it was "done" exactly this way and some other resources of his Brain. Here there was a process of not restriction, but recreation. The most important thing to achieve was the feedback from the "doubles" that were "programmed" (they were "entrusted") to solve certain tasks. N. Levashov told me about the very "mechanism" of this **at the end of 2011** before his leaving for France. Of course, at that time I did not have such potential and such "energy" as Levashov had. And my Brain was not yet ready for such "actions". I needed something that could compensate for the lack of these potentials. I realized it that time.

A week after N. Levashov left for France, he himself called me from the Castle via Skype, and I saw his office and the objects that surrounded him for the first time. I was delighted with everything I saw. But these were not all "surprises".

Nikolai made it possible for me to "see" the **Generator**, which was under the Castle and which I have already mentioned above. That's when I knew from him that this Generator was Man-Made, when, by whom and for what purpose it could be used and why Levashov needed it.

After "connecting" the structures of my Brain (let's call it – opening my Brain) and the "structure" of the "Generator" itself (I would describe it as a kind of crystal in the form of two connected dodecahedrons located in the

toroidal field of a luminous plasma containing octaves from 62 to 96. And all this is reproduced in a state of non-inertial mass), he "suggested" that I should try to create several doubles of my Spirit (my Brain). Everything was done in three spaces, if you can say so – neutrino, antineutrino and proton. This is the basic physics of the process.



I did not think then- whether it would work out or not. **I JUST DID WHAT HE SAID TO DO**. When I saw my "creations" (and they were 3), probably, I was the happiest Man. Nikolai suggested that I should "guide" at least one Spirit, in terms of any action and check the feedback. He explained that I should "activate" the Ring for this that I had and someone's **Complex "SvetL"**. I, without a long thought, sent myself to Moscow to my mother, who had the Complex then. Since I knew the location of her apartment in relation to the Moscow area, the "double" of my Spirit very quickly (almost instantly) got to the Complex, which acted here as a powerful "landmark." The Spirit interacted with **the Programs "SvetL"**, taking almost all the parameters of the healing process, and acted as a retranslator for my Brain. All this took no more than a few seconds, and I was telling Levashov about my mother's state. He recommended that I should change something in the "work" of the Generator, which I did through the double of the Spirit, which was in the room with my mother. Then, I could hardly find the words to give accurate description of all my feelings, and the very physics of the process. Today I can do it. In general, everything worked out and confirmed the

possibility of solving problems "at a distance". For this, I need a map of the location of the Man's house (apartment) and the working **Complex**

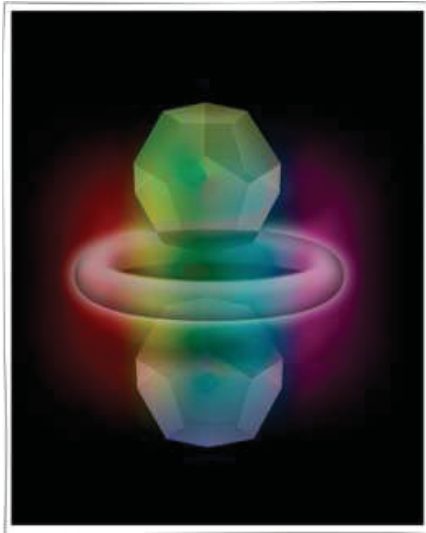

"**SvetL**". Frankly speaking, to "look for" the Complexes on other carriers is not hard. Just, this requires more time and energy, which can be restored in the required volume and depending on the tasks to be solved by the **Generator**, if of course you are able to do it. This is where my French lessons were over. Then in Moscow, after Nikolai's return, we discussed everything in detail again, and he revealed to me other potentialities of the **Generator** under the Castle and the ways in which these potentialities could be used for good. Actually, the whole value of

the Castle was **the Generator** "under it". Nikolai did not fail to remind me of the case (already told me once) of his good friend, whom he once "**opened**" the **Brain** and warned him that in order to make experiments, you should understand all the physics of what you are going to do. The friend was very inquisitive and decided, as an experiment, to try to "prolong" his life, creating a second heart. When he turned to Levashov, "asking for help" it was already too late. All that Nikolai could do was to provide him **PAINLESS PASSING AWAY**. I remember this well and give an example to those who believe that they think that "snap with their fingers" – and everything turns out. You can snap your fingers, but what you will have then is a big question. And what if the house collapses, as A. Khatybov used to say.

After Levashov's gone, I practically did not use (probably, as a human, I feared to do anything wrong) anything that I wrote about. And there was no time for it. I had to be engaged in **the "SvetL" Programs**. The first time when the Generator was still under the Castle, practically in a dead state, I decided to do it, only for the sake of the person who had cancer and who lived in Lake Baikal area. I created the Double of my Spirit and "sent" it with a specific "task". I got feedback and realized all that was necessary to be done. Once again I got convinced, how important in such cases is the feedback and the getting direct information, practically from myself (paradoxical as it may sound). **THE RESULT IS SUCCESSFUL RECOVERY**. All this is confirmed by the article written by his daughter-in-law, a biologist by education, and this article is published on the **RSTS** website. I do not regret

about what was done, but, probably, the article was untimely. After its publication, there came just a squall of requests from both those who participated in the **Program** and those who were not, but their health was in a very critical state. I could not refuse until I realized that my potentialities and energy were still limited. I myself began to have heart problems, and I realized that the continuation could be fraught with. And I still had to "place" **Generators on the Complexes**. This is also a serious load. **THE DECISION TO TRANSFER THE GENERATOR FROM FRANCE HAD** already **BEEN MADE**, but for some reason it was not possible to do this in the current time interval. The **Generator** had to be transferred to Russia not for these purposes, I mean – recovery. But it, in essence, is extremely useful for solving problems related to improving people's health, as well. It took almost six months and, as I wrote before, "suddenly" those Levashov's things that were supposed to be with me "started coming back to me". As soon as **two rings** came – the moment of the **Generator "transfer"** and the place where it is located today were determined.

Everything went quietly and "in line with the plan", not counting the lightning in the sky at the place of its "installation", a fallen pair of pines and scorched grass of the right circumference with a radius of about 50-60 meters. I should say that the grass "recovered completely" in three days. I was able to shoot all this on "video", because I participated in this "event". Here is one of the fragments of the footage...



Another item of our common with N. Levashov plan has been realized. I would like to emphasize once again that **N. Levasov's Friends** played an essential part in this event.

On one of the French sites the following is written: "Montez un peu plus haut dans le village" vous apercevrez un château mystérieux qui

surplombe le village: le Château du Temple. Celui-ci est privé et ne peut, malheureusement, être visité ... Seule, une petite lumière qui brille permet de savoir qu'il est habité. De hauts murs l'entourent et empêchent tout curieux de s'en approcher..." Here is the translation: "A little further the village (**Il Bouchard**), you will see a mysterious Castle overlooking the village of **Castle Hall**. It is private and public are not admitted to the Castle..."

Having finished writing these lines, I got the news that the Castle of N. Levashov **WAS SOLD IN THE END OF JANUARY 2016 AT THE AUCTION** for **560 thousand** euros. It did not cause any surprise, except for the price which it was sold for. A year ago I saw similar (if I may say so) Castles (there were 6 of them) put on sale in France. The minimum price of the Castle, in much worse state than Levashov's, was **1 350 000** euros.



Many curious people would like to know the whole of the story N. Levashov wrote about the acquisition of the Castle and Svetlana's life in it, as well as the development of events concerning the Castle after he's gone. But I believe that **THE TIME HAS NOT COME YET TO TELL ABOUT IT** in order to satisfy someone's curiosity. I know this story not by hearsay, and not only me. Probably, the time will come and this story (it is very interesting in fact), as well as the story of N. Levashov's personal belongings – those that were also sold at the auction in November 2015 and those that “were” in the Moscow apartment and the Castle, and other things – there will be in my future books. I am saying again – the most valuable thing that was under the Castle – ***has been taken out in line with the will of N. Levashov and transferred to Russia***. Here is the answer to the question why I "have

had" everything to continue my experiments with the Spirit (Brain), "**SvetL**" **Programs** and solve other tasks. That is, in fact, being done today. Energetically, I recovered rather quickly, and my "messengers" have been taught to "be reproduced" as many as the situation requires. Feedback is established, and information flows almost continuously, as well as on my request. Today a whole book can be written about how the "transferred" Generator from France in difficult situations while interacting with **the Programs "SvetL"**, helped and helps people being nearly in a desperate state. This is not bragging. **THIS IS AN ASCERTAINING OF THE FACTS.** I can not publish the letters of those whom I helped and go on helping, because it is especially personal correspondence, but believe me – *the final letters are thanksgivings with tears in the eyes.* I never take offense at those who after getting help, forget the words of gratitude, thinking this is exactly the way should be. I understand them, because getting into a habit of measuring everything and everybody by the binary standards imposed on us invariably brings to misunderstanding the essence, the picture as a whole, in the entire volume of its constructive complexity. Each of us is part of something voluminous and complex, but this inclusion has different nature, determined by our own qualities. Someone is the key node of the whole design, others are interdependent elements, still others are partly included in their functionality, some more (for the present) are like potentially necessary filling, and the rest are just ballast. The true and effective meaning of this process, already being under the control of the new System, is the "clearing" the information blocks of the Brain (both at the level of its antineutrino state and the states of matter of the magnetic energy of Brain neurons) of the past information elements on the basis of which the Consciousness of people and all their subsequent common world perception, including "their worldly philosophy of life" had been formed. **AND THERE IS NO HOMOGENEITY IN IT** – everything is changeable and various, and besides, it is strictly dependent and structured according to the given vectors that add events to the sequence, which in the end will form the only required result. As an example, I will not give the results of my restoring those people who just forget all that was done for them, taking it for granted, but the way I was looking for the methods to solve their problems. If, for example, it is necessary to find a solution for treating for cancer, and to be successful it is required for the person engaged in solving this problem to interact with a certain number of such patients, but it is not always possible to organize such narrow selectivity though it is realistic. However hard you try – it's easier to make people who are burdened with diseases flock to the

key link that has the potential to solve this narrow problem, and including the one sought for (cancer), then the Person will have an opportunity to solve the problem. Perhaps, in parallel, due to the variety of patients being treated, he will solve some other problems, or a continuous flow of people craving for recovery might sweep the person like a squall so that he would need an urgent help himself. For the final result of this particular task, it does not matter, **THE SOLUTION WILL BE FOUND ONE WAY OR ANOTHER**. And perhaps by someone else, if the current version for some reason turns out to be unsuccessful. Duplication, including in the simplest and most effective version, is used. But if you evaluate the described from the standpoint of an individual, everything looks more complicated and insoluble. After all, there are their own feelings, needs, and emotions, **WHICH ARE DIFFICULT TO GET RID OF**, without taking into account when making decisions or committing actions. Few people will be worried about the possibility of a global solution of the entire oncological problem in the unknown future, if a close person is dying of cancer here and now. Moreover, it is possible to solve the main task through assistance to specific individuals. It is good, if trying to help the first ten who ask for help, you immediately manage to get to the goal and solve the problem entirely – these ten will get help while searching for the solution, and all the rest – with the help of the solution found. But this is some idealized option. In fact, everything is much more difficult – **THE SEARCH MIGHT LAST FOR YEARS** and the solution can be found *not after a successful hit from the first time, but as a result of a series of trials and errors that might cost someone's health or life*. I have gone through all this. It is difficult, sometimes emotionally painful, but I have passed it and cognized. Not everything can be measured by human measures, if they are only sensual and emotional. Because the process itself (and this is precisely the process) is in relation with changes in the states of matter of magnetic and electrical energy of the Brain cells (its separate functional regions), the program of the "active state of interaction" of neurons in the Brain (neurophysiology has found some fragments of neurons links into unrecognized circuit like a biocomputer), lymph and many other things. I'll try to tell you more about this in this book.

Had not the people turned to me with their problems, I would not have found solutions for many problems. Had I previously refused many of those who asked me for help, I might have lost my companions and friends, who I am rich in now. Had I initially arranged strict "selection" of those who asked for help – I **MIGHT HAVE FOUND MORE SOLUTIONS** related to

human health, thereby helping more people than I could, just letting go the situation. If I had not been so loaded with someone's endless problems, I might have turned my potential to the creation of the **"SvetL" Complex** and the new generation **Programs** ... But if not for that **ENDLESS FLOW OF REQUESTS** for help – many **PROGRAMS WOULD NOT HAVE BEEN CREATED**. To find the way among all these opportunities and probabilities is difficult, you have to weigh every decision. It's hard not to ask for help, trying to solve some very serious problem on your own, *but it's practically impossible to refuse help when people turn to you.*

Here again I want to emphasize, I'm **NOT A DOCTOR**. I just know the **PHYSICS OF THE PROCESS**. And doctors who **DO NOT KNOW** the physics of what they "are doing", in my deep conviction, should be kicked their heels. Because thanks to them, we now have the **MEDICINE OF DISEASES**. But there must be **HEALTH MEDICINE!**

However, I got carried away, and it's time to get back to knowing the Brain.

5.8. The Bound State

All the information about the structures and properties of living cells is contained in the Brain, and not in **DNA** (in DNA – some incomplete copies). That's why it is possible to control and influence the processes of recovery installing a "connection" with the **Brain through the "SvetL" Complex**. But the Complex itself interacts with the Brain and collects its information about the cells, which is then "analyzed" by the brain with the help of its **"SvetL" Programs**, and the results of this analysis become an informational component of the cells healing through the interactions of the **Programs and the Brain**. If some comparison is appropriate, then the DNA itself is a kind of "conveyor", on which the things are assembled.



The information is contained in the things assembled. For example, after assembling, the car is filled up with gasoline, and it is ready to move, but no one will fill the conveyor up with gasoline. That's how you can

"influence" the refueling the car through your "presence", and "refueling" with better gasoline, you increase its power and, therefore, the reliability of the car itself. If there is no "presence", but only the **Complex** work, all the same the gasoline will be better than the initial one. But the biologists are stubbornly looking for the reason why the "conveyor" does not move, and do not pay attention to what kind of components are coming for assembly, because they can not be seen today with any modern technical means.

The Brain is the most complicated complex; it can not be created out of dust. The Brain is the result of a multimillion-year work on the formation of the Biostructure (Human). Here is a drawing of the Brain, on which its main functions are conventionally indicated.

The brain is a **SIMULTANEOUSLY BOUND STATE OF 3 SPACES** – *neutrino (higher), antineutrino and proton, or ionic*. Here it should be noted that the "Dark Matter" Generator, used today with the **"SvetL" Programs**²⁷, was created by Nikolai Levashov on the same principle. The antineutron space forms the lymph around which the proton space is formed by lowering the potentials of the original frequencies. This proton space is endowed with the properties of its own control and perception of the environment, that is, the perception of the "space-time" states in the surrounding objective reality.

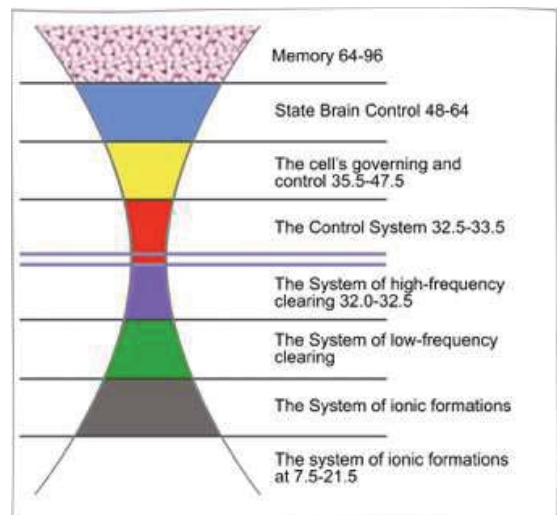

However, this is the lowest level of perception. It is exactly this level that is taken for the standard of perfection by science, and with this kind of its state in the proton space all modern medicine operates. There are no ways to transfer or control from the lower space by another space, a higher space (in octaves). When trying to change the state of a living cell, there takes place a simple disconnection of the control system from the Brain (the Spirit), and the living cell exists exactly as long as the potential of the magnetic impulse

²⁷ N. Levashov "The Source of Life" 1-10.

of the cell itself is consumed. The man eats antibiotics that sharply change the cells albedo, as a result, there is a disconnect from the Brain, at best, but since there are more disconnected than disposed – after the end of the existing potential, the cell in a normal form ceases to exist and – **URNS INTO A NEW FORM – CANCEROUS ONE**, if there was no time to remove. I will write more about it later. We should not forget (I have written about it, too) that any **LIVING ORGANISM CAN EXIST ONLY IN THE INFORMATION FIELD**, outside the field the organism expends the reserves of the proton space potentials irrevocably. The end of the stocks leads to the space separation, and the ionic structure turns into an ordinary inertial mass, into sand.

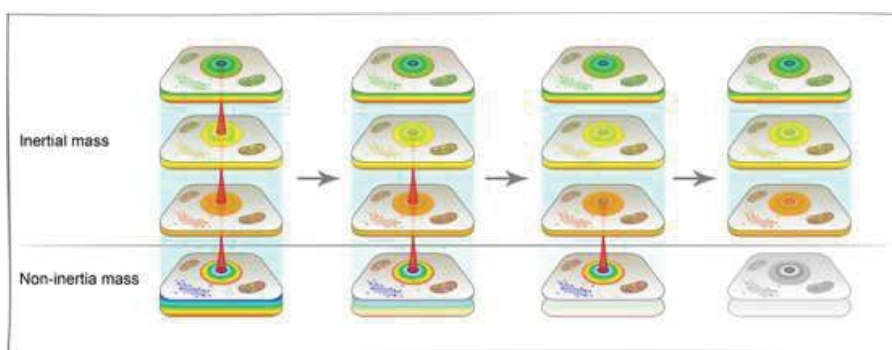

The figure shows the moment of death of a physically dense cell, when the circulation of matter forms between the ethereal and physical levels of the cell ceases. If the influence of the cell's external and internal environment leads to the cessation of the circulation of substances at the cell's physical level, the circulation of matter between the cell's physical and ethereal levels also ceases. There comes a physical death of the cell. After ceasing the processes of the physical cell vital activity, there starts the decay phase.

As the physical cell disintegrates, the complex organic molecules that form the cell's nucleus break down into simpler ones. The main task of the "SvetL" Programs (the Generator itself), constantly "analyzing" (scanning – according to N. Levashov) the situation that comes about with the "Complex" owner is to prevent it. Are there many people able to feel or see radio waves or radiation? I think that there are not, and only thanks to the created instruments the invisible became visible and tangible. The instruments only compensated for the limited perception of the surrounding world by our senses. In other words, the problem lies in the imperfection and limited nature of the Human sense organs; as a result the Brain receives limited and selective information from the world around us. For example, our eyes are

able to catch only the optical radiation of the Sun [(4...10)10⁻⁸ m], which is less than one percent of the emissions (and this is only what is known to modern science), piercing the surrounding space. And what if it does not know everything?! Until recently, two hundred years ago, no one suspected the existence of radio waves and radiation, and the very thought of them was heretical and absurd. And we should not forget that all measurement complexes are made within the limits of the vision frequencies, and the relation "space-time" is determined by the beat interval of the magnetic impulse. The distortion of this relation is not only a disease, but also the result of the "technical progress" and a change in the conditions of the Brain's existence in the current Noosphere.

In recent years, science has shocked humanity with discoveries and information about these discoveries. Even housewives, and not only, – require to bring their diseases in line with the new science achievements. They are the cloning, and getting codes of the human genome, etc. Dear housewives, as well as organizers of conferences on such issues, not everything that is written on the fence lies behind it. There are hundreds of examples from the field of medicine. Let's say that the heart is indeed a pump that provides blood movement through the vessels – at the very least, but if there is a "pump", the science immediately with relief closed its eyes to the fact ***that its power is not enough to push the blood even up to the crown***. And what about lymph that moves from the bottom up without any heart (as a pump), as well as in plants that have no heart (pump), but there is sap flow, and active, which we do not see? What about these phenomena? I fully agree with A. Khatybov, who argued that ***over 500 years of medicine existence no one paid attention to such trifles***, therefore one can report great victories over Mind, not attaching importance to small things.

It is known that mathematics is used in medicine but mostly – statistical. And only in those cases that are convenient for the medical system itself – in the clinics no one posts statistics on the incidence of vaccinated and not vaccinated children, and about side effects from vaccines and Mantoux – all mouths are shut, although in other "convenient" cases, statistics are exact and with the correct presenting.

Any biologically active structure develops ***not in an exponential, but in an octave***, more so, using octave stereometry (octave properties in space). When **the "SvetL" Program** works in cooperation with the owner's Brain, not only dependencies of the living cell existence are determined, but

also constants that are the basis or limit of using the external environment by a living cell.

The existing science has its own system of knowledge, built on Bohr's atom, Mendeleev's table and Willy's biology (where the frog has a pancreas, that is, in the interval between the croaking, it chews salami with pleasure). Then we can say that one of the constants is **CROAK**. This is not an exceptional case of the Academy of Sciences – it's just another step of the achieved knowledge. The next stage of knowledge will also belong to the Academy of Sciences, and not to those academies that use the results of the work of the Academy of Sciences and introduce rubbish into science, for example, in the form of **information ions and torsion fields**. All the academies created in recent years use not only the accumulated experience and knowledge of the RAS, the former secret materials of 1st departments of various institutions, but also misinform the public, **USING THE IGNORANCE AND LACK OF COMMAND AND CONTROL** of the society.

And of course – about the questionnaire attached at the bottom, which so many people wanted to get. You can think of this in different ways – you can accurately and carefully "fill out" the questionnaire, finding out your genotype (if, of course, it works out), and you can spend the same time with greater benefit – by evaluating, using the information from the same questionnaire, some details of Man's shirt "structure", unknown to medicine, and the scale of changes made by the Interventional SU to achieve their goals. **And besides this – the scope of what Alexander Khatybov did, just only by SUCH A SHORT PASSAGE** from his writings. **Believe me – it will certainly be a pass to the Bath, and, probably, without waiting.**

Application

The Form to fill out. To be filled out personally.

Date and place of birth _____

№	Name	Norm
1	Emission of cells incompatible with the body	44000
2	Pressure in the Brain vessels	125/110
3	Pressure in the spinal cord vessels	130/115
4	Kirlian (Radiation of all cells)	100%
5	Elasticity of cerebral vessels	100%
6	Relative indicator of the lymph system	100%

Electrical potential formed for the spinal column (%)

	Name	Performance of centers	Brain; Communication with systems системами	Magnetic impulse импульс	Magnetic impulse potential	Notes
1	Pericardium					
2	Right upper lobe of the liver					
3	The upper lobe of the liver					
4	Pancreas					
5	Thyroid					
6	The Urinary Triangle					
7	Biliary duct glands					
8	Bile ducts					
9	Vegetative-Vascular system					
10	Bladder					
11	Right kidney					
12	Motion coordination system					
13	Heart valve regulator(right left)					
14	Sexual system					
15	Hematopoietic system					
16	Nervous system					
17	Circulatory system					
18	Communication system (cerebellum)					
19	The memory system(cephalic and spinal)					
20	Vertebral column					
21	Heart					
22	Stomach					

23	Small intestine				
24	Colon				
25	Lungs (right-left)				
26	Great Circulation Circle				
27	Small Circulation Circle				
28	Lungs (left-right)				

Matrix BLOOD ANALYSIS

1. General indicators of blood. **Black color is within normal limits, red color is anomaly.**

2. Items 1, 7, 8 – express diagnostics without detailed interpretation.

3. Items with a shaded line – only in the matrix.

	Name	Unit	Norm		
1	Hemoglobin	G L	132-164 (m), 115-145 (w) (CPU=167)		
2	Fetal hemoglobin.	%	Up to 1.5 of total G.		
3	Hemoglobin of adult type	%	Up to 94.9 of total G.		
4	Methemoglobin	%	1.0 of total G.		
5	Carboxyhemoglobin	%	1.0 of total G.		
6	Sulfmethemoglobin	%	Must not be		
7	Glycolic hemoglobin.	%	3-6 of total G.		
8	Or fructose	Mr	0.46-0.64 Mg per 1 mg.		
9	Leucocytes	10 ⁹ /l	4.0-9.0		
10	ESP	mm/h	1-10(m), 2-15(w)		
11	Erythrocytes	10 ¹² /l	4.0-5.1 (m), 3.7-4.7 (w)		
12	Hematocrit		0.40-0.48 (m), 0.36-0.42 (w)		
13	Color indicator		0.86-1.05 (at E.=5.0, T=167)		
14	Thrombocytes	10 ⁹ /L	180-320		
15	Eosinophilis	10 ⁹ /l	0.5-5.0		
16	Lymphocytes	10 ⁹ /L	19-37.0		
17	Monocytes	10 ⁹ /L	3-11.0		
18	Neutrophilis:	10 ⁹ /L	48-79.0		
19	A) The Stab	%	1-6		
20	B)Segmentation	%	47-72		
21	Plasma cells	10 ⁹ /L	99-156		
22	pH of the pulmonary blood		6.88-7.45		
23	pH of the plasma		6.88-7.45		
24	pH of a large circle		6.88-7.45		
25	Elastic. cells erythrocyt.	100%			
26	Viscosity of erythrocyte	100%			

27	Structures of Ca^{++}	100%		
28	Structures of Ca^-	0%		
29	Structures of Mg^{++}	100%		
30	Structures of Mg^-	0%		
31	Structures of Fe^{++}	0%		
32	Structures of Fe^{+-}	0%		
33	Structures of Fe^{+}	0%		
34	Structures of Fe^-	100%		

2) Acid-base state

35	Excess or deficiency of base	100%	(Excess > 100, deficiency < 100)
36	Partial pressure of carbon dioxide	100%	
37	Partial oxygen pressure	100%	
38	Partial pressure of chlorine	100%	
39	Partial pressure of nitrogen	100%	

3) Blood plasma

40	Proteins common Albumin Mkmol / l 59.0-70.6	G/L	66-87
41	Albumin	Mkmo/l	59.0-70.6
	Globulins		
42	a1	%	2.10-4.40
43	a2	%	5.20-9.70
44	b	%	7.30-12.20
45	Y	%	11.20-19.90
	Lipoproteins		
46	- prelipoproteins (VLDL)	Mkmo/l	0.1-1.29
47	- lipoproteins (LDL)	Mkmo/l	1.0-3.37
48	- lipoproteins (LDL)	G/L	1.5-3.3
49	Triglycerides	Mkmo/l	0.45-1.81 (m), 0.40-1.53 (w)
50	Creatine kinase (with activators)	Mkmo/(s-l)	Up to 100
51	Alanine aminotransferase (Alat)	unit/liter	5.0-40.0
52	Aspartate aminotransferase (Asat)	unit/liter	5.0-40.0
53	Lactate dehydrogenase (LDH)	unit/liter	225 – 480
54	□□ amylase	mg/(h/l)	3.3-8.9
55	Glutamyltransferase (Gamma-GT)	H Humol/(c-l)	250-1767 (m), 167-1109 (w)
56	Nitrogen residual	Mkmo/l	14.3-28.6
57	Creatinine	Mkmo/l	50.0-115.00

58	Urea	Mkmol/l	2.1-7.3	
59	Uric acid	mkmol/l	208-428	
60	LED	Mkmol/l	0.19-3.18	
	Pigments			
61	Bilirubin generic	Mkmol/l	3.4-18.8	
62	Bilirubin bound	Mkmol/l	0.1-5.1	
63	Bilirubin free	Mkmol/l	3.4-15.0	
64	Glucose	Mkmol/l	3.0-6.40	
65	Sugar++	100%		
66	Sugar+-	0%		
67	Sugar-+	0%		
68	Sugar--	0%		
69	Common lipids	%		
70	Phospholipids common	%		
71	Cholesterol total	Mkmol/l	2.5- 5.18	
72	Lipase	%	0-470	
73	Sodium	Mkmol/l	136- 146	
74	Potassium	Mkmol/l	3.5-5.1	
75	Calcium total	Mkmol/l	2.15- 2.55	
76	Phosphorus P++	100%		
77	Phosphorus P+-	0%		
78	Phosphorus P-+	0%		
79	Phosphorus P--	0%		
80	Magnesium Mg++	0%		
81	Magnesium Mg+-	0%		
82	Magnesium Mg-+	0%		
83	Magnesium Mg--	100%		
84	Хлор	Mkmol/l	98-106	
85	Chlorine	100%		
86	Chlorine Cl+-	0%		
87	Chlorine Cl-+	0%		
88	Chlorine Cl--	0%		
89	Сульфаты	0%		
90	Iron	Mkmol/l	10.6-28.3	
91	Copper	%		
92	Phosphatase is acidic	nmol/(s-l)	67-167 Optimum pH = 5.0-5.5	
93	Alkaline phosphatase	unit/l	90-360	
94	Kidney: Removal of blood structures	100%		
95	Kidney: Cell scavenging structures	100%		
96	Kidney: Digestive tract waste removal	100%		

97	Kidneys: removal of waste water used to maintain the balance of temperature	100%		
98	Heart	44 mm.Hg	Pressure for indexing containers	
99	Pancreas: the formation of a complete assembly for the heart	100%		
100	Stomach: Acidic environment of chlorine	100%		
101	Stomach: Pretreatment of food	100%		
102	Intestine: food processing -descending bowel - transverse intestine - an ascending bowel - rectum - appendix (neutrino)	100% 100% 100% 100% 100%		

4) Lungs

		Lefr	Right	
103	General state - magnetic pulse potential - communication with the heart - communication with the thyroid gland - communication with the liver -communication with the pericardium -communication with the brain -communication with the sugar gland			
104	Pharyngeal ring			
105	Trachea			
106	Alveolus			
107	Difference index			Difference between intake and sediment
108	Lungs memory			
109	Energy balance			
110	pH of water treatment			Norm 6.887.45
111	Limit value of specific gravity			norm G = 1 g/sm ³
112	Condition of membranes			

The energy balance of the body is always = 0.

5) Sexual System

Nº	Name		
----	------	--	--

1	Sacrum		
2	Ureter		
3	Rectum		
4	Seminal vesicle		
5	Ampoule of the seminal duct		
6	Ejaculatory duct		
7	Mat of the prostate		
8	Cooper's gland		
9	Anal opening		
10	Epididymis		
11	Scrotum		
12	Testicle		
13	Serous membrane		
14	Peritoneum		
15	Bladder		
16	Pubic adhesion		
17	Семявыводящий проток		
18	Prostate		
19	Urethra		
20	Cavernous body		
21	Penis		
22	The head of the penis		
23	The plasma pressure in the cavernous		
24	The ratio of MM / MP pressures	0.66	
25	Relation to Moon Phasing Отношение к Лунной фазировке	100%	
26	Relation to the magnetic impulses of the Sun	0%	
27	Relation to the Zodiac	100%	

MM – the maximum pressure (the upper limit) in the vessels of the brain.

MP – maximum plasma pressure in the cavernous body

Ultimate pressure in the vessels of the brain (Enter color)

Type (DN A)	AAA	CCC	GGG	TTT	AAC	CAC	AAG	AGG	AAT	ATT	CCG	CGG	CCT	CTT	CGT	GTT	ACG	ACT	AGT	CGT
T(years)	11	0.8	3	7	11	17	1	13	11	18	2	5	6	18	37	41	66	120	54	72
MM	-	-	-	-	-	235	-	215	-	230	-	-	-	245	235	245	255	265	245	250
MP																				

6) Identifiers of beat frequencies since 2012-07-12.

	Octave	Must be	State
113	43.975975	0%	Brain communication with the Atmosphere Brain (up to 2011-06-06)

114	43.125125	0%		Communication brain control (up to 2011-06-06)
115	43.225225	0%		Communication with Kailas Complex (up to 2011-06-06)
116	43.875875	0%		Communication through the atmospheric Brain (up to 2011-06-06)
117	49.975975	100%		Brain communication with the Atmosphere Brain
118	49.125125	100%		Communication Brain Control
119	49.225225	100%		Communication with Kailas Complex
120	49.875875	100%		Communication through the Atmosphere Brain
121	64.975975	100%		Brain communication with the Atmosphere Brain (secret code)
122	64.125125	100%		Communication Brain Control (secret code)
123	64.225225	100%		Communication with Kailas Complex (secret code)
124	64.875875	100%		Communication through the Atmosphere Brain (secret code)

$$1 \text{ mol} = 10^3 \text{ mmol} = 10^6 \text{ } \mu\text{mol} = 10^9 \text{ nmol}$$

Conclusions: _____

The genotype _____

Frequency balance _____

Chapter 6. About Reason, Consciousness and Matter, or "how to dig with the spade of Knowledge"

*Consciousness creates reality and you
Create Consciousness.*

The trouble "came" when a medieval Man directed his telescope to the sky. He gasped with astonishment; he did not believe his eyes. The world that opened up was strikingly different from the world of his imagination and understanding. Everything was not the way he had been taught, including, in the Church, which he believed to be infallible. But this was just a stage of creating a specific Brain genotype and changing the situation through the cognition and the Brain potentials of this genotype.

Today we can not imagine the medieval Man's shock who saw infinity instead of the firmament with flashlights. As Lomonosov said: *"The abyss has opened up, full of the stars. The stars are numerous. The abyss is fathomless.*



This became the quintessence of the **new World perception**. The Earth was not the center of the Universe, around which everything was revolving, but one of the planets revolving around the Sun. Everything turned out to be quite different from what the priests said. It was a shock.



For the man who looked into the telescope, "the soil was cut from under his feet".²⁸ It turned out that the church was telling wrong. The picture it created in fact did not correspond to reality. The thoughts whirled in the head: "*it can not be, because it can not ever be*". But it was. Today, the similar things happen to those who picked up

not a telescope but the "spade of Knowledge" and are learning or has already learned how to use it.

Time passed and, it would seem, – with knowledge of the excellent orderliness of Stars and Planets, people should have guessed about the existence of powerful "forces" that organize everything. It goes without saying, that even then the conclusion arose that those forces existed and possessed such intelligence, in comparison with which people are just insignificant "half-wits". But if we approach this in a philosophical way, then half-wits are not able (in fact of the matter) of making correct conclusions, even if these conclusions arise by themselves. And people made and go on making them now. People looked for and go on looking for some "signals" from other civilizations. But people do not understand that the Higher Civilizations, "watching them", see that they are still "rather weak in wits". Read once again "**The Last Appeal to Mankind**" by **N. Levashov** in the book of the same name, presented at the very beginning.

Today, in my opinion, and I am hardly mistaken, the Mind "maturation" of the Earth Humanity should take place in direct contact with the "Parents", which I mentioned earlier in one of the chapters. Otherwise, people are going to make what happens in our life, when human children are fed by wild beasts. But **THIS CONTACT SHOULD BE DESERVED** in our hard times. We have already been indicated the path to direct contact with the Universal Mind. It is indicated by those who lived and live among us today. And we still do not

²⁸ At the beginning of the 17th century, no one so closely looked at the stars, like a Dutchman named **Hans Lippersgey**. In 1608, operating with two lenses and a hollow tube, Lippersgey invented the world's first telescope and tried to get it patented. But the inventor was denied, the cause of the refuse is not preserved for us.

fully realize who and what "we were lucky" to come into contact with. They taught and go on teaching us, told us, wrote about how to reach this contact, and how it is done. But very many of us do not want to move along that path of Knowledge indicated by them or just have no strength, as "have knocked into their heads", that the way goes uphill. And if you need to have physical strength to go up the earth's mountains in order to overcome the force of gravity, then to rise along the indicated path of Cognition to the top of perfection, one should have **KNOWLEDGE, UNDERSTANDING, AND THE STRENGTH OF MIND**. These qualities allow us to overcome the force of "attraction" of the so-called human temptations, to which all of us are accustomed and without which can not imagine our "life". The first strength to overcome the temptations you will get after comprehending the information in the writings of *N. Levashov, A. Khatybov and N. Morozov and others living among us*. The strength will be those conclusions that you will make, thinking on what is said and written by these people. And when you make the right conclusions and move on the path of Knowledge up the hill, then on this path, **THROUGH YOUR KNOWLEDGE**, obtained from the writings of these people, you will come to the perception of what is happening and what you are striving for. This can make it possible for you to get rid of the earthly "judgment" about people surrounding you, of envy and anger at some of their actions performed "without thinking". This can allow you to get out of emotions that just block your Mind.

Lately, there are many people from whom I have heard "... *we have already read and known everything, we have understood everything and have become smarter. We are striving for our perfection, but we have very little time, because we are engaged in what is so necessary "for others"*. But not everyone can stand the trials, which always inevitably "fall" on one, as the more knowledge one gets, the more responsibility one has for others. There are many who really want the rest of the world to know about it, to get the recognition of others and the corresponding "reaction". In other words, it all turns into a "mania of one's own importance and greatness". And with this, it is impossible to go up the way of Knowledge, no matter how much one is yearning for. This prevents one from understanding and getting those potentials that are opened on top, which one yearns for. And they, for example, might be higher than the miraculous potentials of Jesus Christ, who exactly told his disciples that "*they would make miracles that would surpass those that he himself made...*" People who today "lean" on their knowledge acquired at least from those "sources" that I have told you about – can be as more powerful than modern

people who are unfamiliar with this knowledge, as a man behind the levers of an excavator is more powerful than a Man with a shovel, or as a man behind the levers of a truck crane is more powerful than a Man with bare hands.

And if you look deeper and try to understand what capabilities you can get in the near future, you can imagine them when looking at the prehistoric foundations of huge and carefully fitted stone blocks in Machu Picchu, Baalbek, Palmyra. This was done not by Gods and aliens. This was done by the Man, by **THE HUMANS KNOWING**. Today similar potentials can be gotten by those who will step on the way of knowledge and cognition to the heights of perfection.



I would like to stress once again that the way up is not easy. On this way, a lot of tests will have to be passed. You will have to "take" all the exams and, basically, of yourself. I am sure that any perception of something is possible only through one's own knowledge, gained through one's own work, aimed at good. Therefore, to live not in line with these "rules" is nothing but trouble to oneself and people. Thinking of this, you have to make right conclusions. And do not take the above for some kind of instruction. This is not so. I just wanted to show you **N. Levashov's** and many others way who reached the top, and which I am going myself.

Of course, the **REACTION OF PEOPLE** on what I am writing and presenting not yet finishing the planned **IS INTERESTING**. This allows me to make corrections. I asked a certain Person living in Siberia to read the

written (not to the end) and express her opinion. We have already made some very interesting experiments together. A Person who initially did not believe anything without thorough consideration, diligently looking into everything through personal experience, testing her knowledge on the realities of the world around her. Her perseverent yearning for knowledge sometimes struck me.



Her name is **Daria Kuznetsova**. She came to St. Petersburg with her children, and we met. I'm rather good at making people out, but I have not seen such longing for knowing and such a questioningly demanding eyes for a long time. It is not a compliment to a beautiful young Siberian woman. This is a statement. Here is a shortened version of the text that she sent me, reading this book of mine and I am sure that this will be useful for the reader.

"In my opinion – you have given exhaustive information – if you mean the initial acquaintance of an individual with the events happened (18 thousand years ago) and, as a consequence, with what is taking place now and will take place in future. All written will be interesting to **3-5%**, of those readers who are "not in the subject". The rest are disposed to twist their finger on the temple rather emphatically. The older the person, the less information is accepted. But if all the written by you is retold to them – they “swallow” it easily and ask for more. It is checked. They are slowly getting used to it, and with a squeak, they begin to swallow and digest the information. Well, those who somehow encountered "SvetL" Technologies, they are doing it more actively, because **THEY ARE JUST INTERESTED TO KNOW** – "in what way does it work?". But they, too, are more disposed to listen to than read on the own, let alone search. Basing on my communication with people – there is nowhere to go – no matter what you are talking about – the last dinner or the stars – comes up against a new look at everything that is obtained through the known Writings. There is also a group of people (according to my observations) – who **TAKE** everything you have written about and repeated over and over again **QUITE NATURALLY**, but does not get to the bottom of the matter and **IS NOT GOING TO USE IT IN PRACTICE**, in their lives. The state of such relative peace might come to its end soon and something will have to be done, otherwise someone will do it for them. However, the feeling that the absolute majority does not give a damn about it all does not leave me. There are many people who do the following – the truth and what is next to it – they lump everything together – "Slavic-esoteric". And out of this heap it is easier to select

what **DOES NOT NEED TO BE COMPREHENDED**, but only requires simple actions, or does not require anything at all – to do round dances, discuss news in social networks, dress up in national clothes or create settlements of new "land-owners".



Perhaps I am mistaken about it, but it's easier for people to organize a kind of "activity" as if not waiting for something to turn up, move to" revive "the Slavic traditions or" fight "with smoking or something like this, than doing what you are writing about. But slowly, something is probably changing and people after Ivan Kupala celebrations and jumping through the bonfires **WILL STOP FOLLOWING SOMEONE**, and **START THINKING WITH THEIR OWN BRAINS**. Another point – it is important who gives information and the way it is given. Your information is also for those who can, having comprehended the given – develop it further and do something in the right direction, and not just "resonate" and feel happy. And if so, then it is all right – every idea you have expressed (or A. Khatybov, N. Levashov and others), when considering, reveals a whole layer of the concealed. But, I hope that each of those who "understood" – will take it further to others may be with some differences, but just in the way the others need – the way it has been comprehended. And for the general public, what you are writing about is not going to be understood soon. If, of course, the reduction in the population you have mentioned does not change the existing relationships. I meant to write more, but I restrain myself with all my might. And I feel like writing because I seem to have a shortage of people who I can communicate with normally and in the same language".

What could I say to this? Probably, the fact that she is right in many respects, because today the confidence of modern people is not based on **PROFOUND KNOWLEDGE AND CALCULATIONS**, but on **WISHING TO BELIEVE IN THE INVARIABLE IMPROVEMENT** of the world. In principle this does not differ from *confidence of people before the Flood*. Most of them drink, eat, have fun and try not to burden themselves with reflections in the same way as it was several thousand years ago – People live their usual lives and do not hear (or do not want to hear) storm warnings. And these warnings "sound" everywhere. This is not because of their stupidity, but because of Human qualities. We were "taught" to think: tomorrow will be a little better than today, because today is slightly better than yesterday. People are sure of this truth and therefore laugh as children at anyone who indicates the signs of imminent colossal changes. When the worst is to come, most people are disposed to believe that the worst is left behind. **IT IS NECESSARY TO CHANGE EVERYTHING**, and change it today, **SO THAT** to be able **TO COMPREHEND IN THE OTHER WAY** the emerging circumstances of the **ONGOING CHANGES AND MAKE THE RIGHT CHOICE** in getting a different level of Cognition for thinking about the Mind, Consciousness and Matter, which, in fact, we are going to do in this chapter.

6.1. Factor

The advancing development of any system is inseparable from the similar advancing development of all elements of the system and is subject to the fundamental laws of the development of matter. In the event of a violation of the development cycle of an element or subsystem, the entire system is at risk.

The laws of the development of Reason and Consciousness are inseparable from these fundamental laws, as a part can not contradict the whole, without jeopardizing the very fact of the existence of the whole. Therefore, when comprehending the laws of Consciousness and Reason development, it is necessary *to take into account the physics of the processes* at the macrocosm and microcosm levels. N. Levashov used to say it again and again. And let's not forget that **Consciousness, Reason and Matter** are the **INDISSOLUBLE PARTS OF THE SINGLE WHOLE** as the "triune truth". These laws are common and characterize the whole variety of processes that include them. This means that Consciousness and Reason are not some idealistically enthusiastic categories, but, on the contrary, they are

categories of Matter, just as Matter in its development can reach the level of Reason.

The development of Consciousness and Reason is not something that can be described with the help of religious dogmas, esoteric speculation or the fascinating psychological delights of Dr. Freud and his talented followers. The followers, of course, tried, "each in his own way", in order to outdo the grandfather, but in the majority they did not go too far. Particularly noteworthy in this respect is the "remarkable" theory of behaviorism,²⁹ put forward and actively promoted by his American followers, led by its founder, John Watson. According to this theory, all human behavior is easily explained by the same mechanisms that shape animals behavior, and in fact – reflexes that are

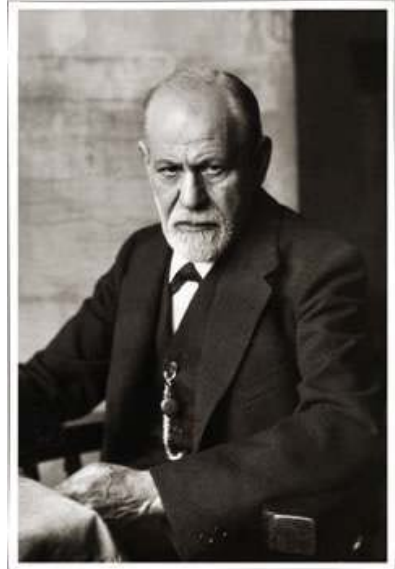

hardly distinguishable from the reflexes of the unfortunate wards of Dr. Pavlov. The philosophical basis of behaviorism is the concept of **John Locke** of the birth of a human out of a pure leaf – **Tabula rasa**, and the non-recognition of the existence of the thinking substance of Thomas Hobbes.

John Broades Watson proposed a scheme explaining the behavior of Man and other living things: **S→R** – the stimulus triggers a reaction. The stimulus and reaction were measurable, so this approach was not questioned a lot. Watson believed that with the proper approach it would be possible to fully predict the behavior, control and shape through the changing environment of people of the necessary professions, regardless of their Consciousness. The mechanism of these influences was training through classical conditioning, studied in detail on animals by Pavlov.

Human behavior was often studied by these "remarkable people" on animals, and therefore it should not be surprising that the methods of achieving their goals by Americans often lie in the mainstream of all the same animal instincts. But all this is not so interesting, and therefore we provide them to themselves, everyone gets what one deserves.

²⁹ **Behaviorism** is a direction in psychology that rejected both consciousness and the unconscious as objects of scientific research and reduces the psyche to various forms of behavior understood as a set of reactions of the organism to stimuli of the external environment.

Behaviorism

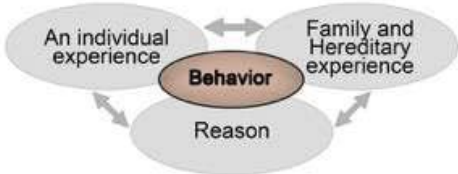

The diagram illustrates the components of behaviorism. It features a central oval labeled "Behavior". To its left is an oval labeled "An individual experience", to its right is "Family and Hereditary experience", and below it is "Reason". Double-headed arrows connect "Behavior" to each of these three surrounding ovals, indicating a reciprocal relationship.

In Behaviorism it is important so that the employee understands the relationship between quantity and quality of work and incentives-rewards and incentives-punishments.

This statement was established on the basis of numerous experiments on people and animals.



The image shows a balance scale. On the left pan, there is a stack of five small boxes, each with a carrot illustration. On the right pan, there is a single, much larger box, also with a carrot illustration. The scale is tilted, with the right pan being lower, suggesting it is heavier.

The system of internal administrative responses depends on a set of administrative incentives based on the Stimulus-Reaction principle. It is possible to find this relationship only on the basis of complex experiments. Working conditions form labor productivity.

Now of interest is quite another thing. With regard to Man, the development of Reason today presupposes the necessity to take the trouble to oneself and *present the tasks for the Reason beyond the scope of ordinary everyday thinking*, **NOT TO BE AFRAID TO BREAK STEREOTYPES** and use *intuition, imagination and fantasy as integral instruments of one's own development*, since the Reason in its potential is as infinite, as infinite is the Cosmos itself.

What I am writing about is an attempt to sort out at least a small part of all this infinity. And it might seem to be debatable and somewhat provocative, but still it is an attempt to understand and comprehend those aspects of new knowledge, those questions to which there are no ready answers and solutions. **No book WILL EVER GIVE ANSWERS TO ALL THE QUESTIONS**, but *it is imperative to put them up to you and look for the answers to them!* Otherwise, getting only ready-made knowledge, the Reason can fall into lethargy.

6.2. Human Consciousness and Consciousness in General

What is Human consciousness and consciousness in general, if it is permissible to put it this way? This is the most complicated question and is, perhaps, one of the principal mysteries of the Universe.

I am saying it again and again – when considering the laws of development of Consciousness and Reason, we can not separate them from the

physics of all the processes of Matter development, both at the macrocosm and the microcosm levels. **Consciousness, Mind and Matter ARE THE PARTS OF A SINGLE WHOLE.** Separating them one from the other is not correct. Without understanding it, we have nothing else but to make the entrenched mistakes of all scientific, religious and esoteric thought on this subject. But for all the 18,000 years of intervention, none of these directions has ever come closer to the truth and the essence of these concepts has not been explained. This could not have been for the reasons already known to us.

Matter develops on the basis of precisely defined physical laws, and this is not disputed by anyone. But the human thought has never attributed Consciousness and Reason to Matter, in any way, explaining it by anything – religious postulates, economic laws, class struggle, psychology, and , finally, instincts, but not Matter.

If this or that concept does not provide a consistent answer to the questions posed, but, on the contrary, more fog thickens around them, then such a concept can not be considered true. For it (the concept), the notion of "supposition" can be applicable and nothing more. The supposition can be an incentive for further searching for the truth, but if the search has not been successful, the assumption can not be the basis for the concept formation and should be rejected as unconfirmed. Nevertheless, some of the concepts at certain particular stages of history (from Tora) declared about the complete comprehension of the truth on Consciousness and Reason. And this truth was postulated as immutable. Let us not "dive" into the analysis of these concepts, there is no point in this, and if anyone has an increased interest in such issues, then there are plenty of great and minor works on them.

Consciousness at the non-inertial level has a cellular structure built on the dodecahedral basis

The cubic structure, imposed in the period of the intervention, blocked most of the links, forming artificial limitations and **MAKING it IMPOSSIBLE THE ADVANCING EVOLUTIONARY DEVELOPMENT.** Consciousness, being based on a cubic structure, as well as in the structure of DNA, having limitations on the "input-output" blocks, did not allow the cells to be combined into a single structure. This fact directly contributed to the formation of a **false "I"**, based on the imposed social ideas. **"A man is not what he really is, but what roles he has to play in his life"**. And there could be many such roles. For all that, each of them tried to develop into its own "I", which is false for the individual (no longer Man), since it had nothing

to do either to his personality or to his Spirit. And the society imposed on people the idea of how to play these roles in order to achieve success.

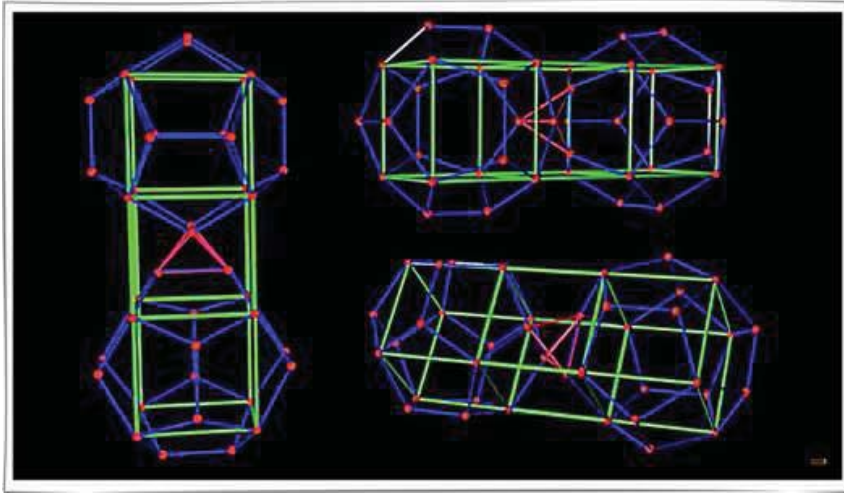

Thus the ego developed, because the desire for success without the ego is impossible. For the true Personality, for the true individuality, for the Spirit, with all its experience of incarnations, these social notions of success do not have any value. On the other hand, religious and esoteric ideas placed at the forefront the destruction of the ego by abandoning the "I". But here there was an almost imperceptible, but extremely significant substitution, since it was required to refuse precisely from the true "I", from the individuality. For all that, it was assumed that all the experience and memory obtained were ultimately transferred to the higher structures (egregors) of these religions. As a result, **THE DISINTEGRATION OF THE PERSONALITY** and, as a consequence, the impossibility of one's evolutionary development, **TOOK PLACE INEVITABLY**. *The consequence of the cubic construction resulted from the impossibility of realizing the true world order, the impossibility of combining the individual Consciousness with the Consciousness of the structures that make up a single space structure and including (as constituent elements) the Consciousness of cells, organs, the physical body Consciousness, on the one hand, and the Consciousness of the planetary mind (Earth Control Systems), the Consciousness of the Cosmic Level structures, on the other hand.* Here, there should be taken as the cornerstone the general principal goal of human development and the Earth development. "The realization of the true goal of the Earth existence in general and the fulfillment of its main functional empowerment given to Her when designing Her, that is: in the process of the embodiment of all eight stages of

Her discrete complex civilization development, to achieve perfection of the harmony of only the non-inertial state of energies and Her Reason, becoming in the end an hypostasis of the Universal Reason!"³⁰

The dodecahedral construction of the structures of Consciousness (cells of Consciousness) ensures the interaction of the individual Consciousness (the Consciousness of Man as an individual) with other levels of Consciousness structures. Thus, initially mobile dynamic structures are formed that ensure the full interaction of the Control Systems of each level, without which the **EVOLUTION of the Human Being and the Earth Reason, as well as the Planetary and Galactic civilization clusters, are IMPOSSIBLE.**

Next, we must take into account the necessity of understanding (through the principles of non-Euclidean geometry as the principal basis) the Space construction. The dodecahedral structure is the carrier, but it is not the main dominant form in relation to a single construction of the Universe space. Here it is necessary to consider the Mobius band – the embodiment of the law of interrelated spaces (for more details on the Mobius Band see later). The present day knowledge and Man's thinking do not make it possible for an adequate conception and interaction with this structure. The Earth's atmosphere levels are also connected, in addition to the dodecahedral structure, with the formation of spatial interrelationships on the basis of non-Euclidean spaces. Their harmony in this basis of conception is the most important factor for the Universe. A cell is also a Universe for certain levels of space. Consequently, an integral part of Man on the inertial and non-inertial levels is an innumerable set of universes existing on other space levels. On the other hand, Man himself is a microscopic link in the scale of our universe. And such universes, as N. Levashov used to say, can not be counted. To make the point clear for a Man, taking into account the current level of the Brain octave, it can be imagined as two serpentine bands that are one in the other and interacting continuously. Having imagined such a construction, we get the similarity of the DNA helix, which is a reflection of the Space shape on all its levels. Our idea of the shape of the DNA helix is incomplete due to the inability to see (taking into account the existing instruments) its full and true construction. Now (for the time being) we **have a closed 4th DNA codon and the construction of DNA on the principle of the benzol ring**, i.e. on the basis of k-structures, while in its correct, true construction, the DNA bond nodes have a dodecahedral

³⁰ B. Makov "Destruction of the System of Social Violence"

structure. Accordingly, the entire true design of the DNA helix is still closed to us.

6.3. Benzol ring

Benzol model of the dodecahedron (*initial for the formation of material structures.*

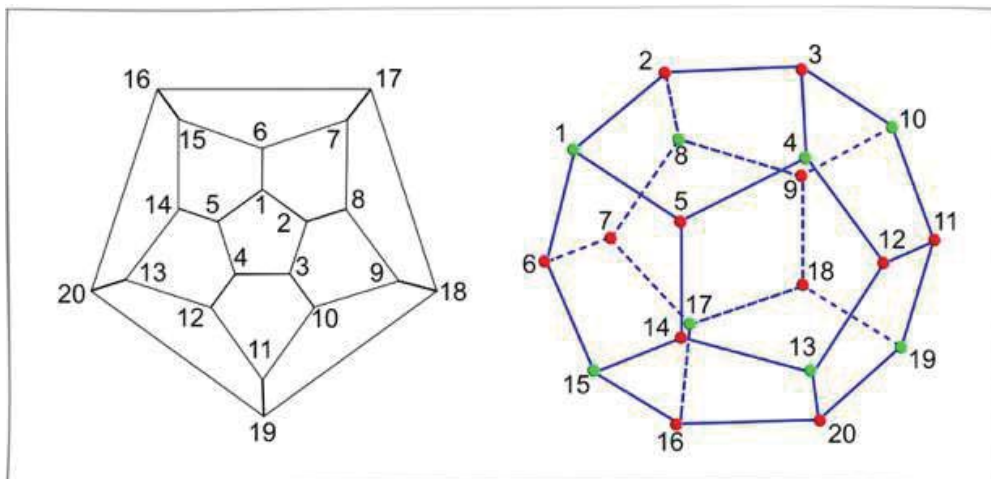

If the idea of interpenetration of different levels of space and the possibility of the existence of entire worlds "inside" the cell seems to be ill-founded, I will give you here as a confirmation **one quotation**.

"Nature in its development of eternal matter for infinite time in an infinite space reaches such a state, when the accumulated building material, easily integrating, creates a whole Local World. And this Local World, in turn, can be only a small part of another more integrated world, which will have its own building "indivisibilities"

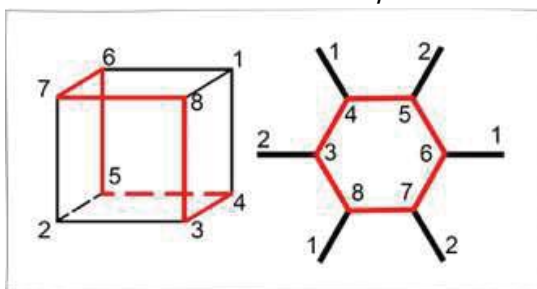

which in comparison with our "indivisibilities" can be a whole World. The building material of our world is a photon and a magnetic particle. Apparently, the answer to this question lies in understanding of the eternal and infinite...

And if we sum up a certain result of the question under discussion, then we have to say it again that only two particles are sufficient for the construction of the entire World: a photon and a magnetic particle. All other observable particles are the integral formations of the two indicated.

For our private world, these particles are the main building material, but there are also such worlds in which both the photon and the magnetic particle are the integral particles, i.e. created from even smaller particles."³¹

The development of Consciousness is impossible without taking into account and **PROCESSING THE RECEIVED EXPERIENCE**. Experience is the category of memory. But a jump in the development of Consciousness can occur only when memory carries information not as some kind of knowledge in general, but only as *knowledge that has become a personal experience of an individual* (or any carrier of Consciousness). *Only then does enlightenment with knowledge take place. Knowledge becomes a personal experience, this experience is accepted, absorbed by the structures of Consciousness*, and a qualitative leap takes place, enabling the formation of Matter with new properties and qualities. In this process **the "SvetL" Programs** showed their undoubted expediency in their application as "some help" to the structures of Consciousness. It is necessary to recall the above example of Human interaction with structures that ensure the existence of Religions. In the process of development, getting life experience, Man creates additional bodies, i.e. Matter. Energy is the basic quality of Matter. Accordingly, when giving up personal, individual consciousness in favor of various Gods and Deities, the Man passes his own energy to these structures, i.e. provides them with energy



saturation (food) at the expense of himself, receiving in return the **ILLUSION OF GAINING NEW QUALITIES** or the **ILLUSION OF HEAVENLY EXISTENCE** on the "other side". In this case, if one "finds oneself" illusory in the Paradise, the passing occurs voluntarily, if -in the Hell – forcibly. *These categories are imposed on by the Interventionist civilization.*

³¹ A.A. Luchin "PHYSICAL FIELDS" (Materialist concept of classical physics)

6.4. Space, as a characteristic of Consciousness structures

Considering this issue, first of all, it is necessary to take into account the interrelationship of the life support fields of **IFNS** (informational field of the neutrino space) and the **IFPS** (information field of the proton space). Each of these fields is a spatial structure. Let's take into account that the **IFPS** does not exceed **72 octave**, and the **IFNS** is an octave from **72 and higher**. Everything that is memory is located in the **IFNS**. Accordingly, speaking of Consciousness, we can talk about the **IFNS**, since Consciousness is inseparable from Memory and without Memory it can not be formed. The physical (dense) body of Man entirely depends on the qualitative characteristics of the additional bodies, or rather, the characteristics of the Matter, which they are composed of. Cellular memory can also exist only in neutrino space, and with regard to Consciousness at the cellular level, all of the above is true. *The communication – the Brain – a cell and the Brain – an organ is performed at the level of the neutrino space. The programs "SvetL" in this case perform the part of a supervisor for these processes. And when this communication is violated because of some reasons, a command "is given" to the Brain to restore the communication and "suggestions" on its restoration. This was the task of working out and adjusting the "SvetL" Programs, since 2012. When this interrelationship is violated, first of all, the violations occur at the level of additional bodies of cells and organs, and violations at the level of a dense physical body are the consequence of those violations.*

When creating the structures (cells) of Consciousness on a dodecahedral basis (at all levels), such relationships are quite stable, which ensures the stable operation of the system as a whole and **SUGNIFICANTLY PROLONG THE LIFE OF THE BIOSTUCTURE**. Actually, this is exactly what the "struggle" is for in the adjustment of the **"SvetL" Programs**. The results obtained allow us to say that with the correct use of **the Programs** and the **Complex** itself, the result of the minimum lifespan (**124 years**) is practically reached. **The cubic structure** has a much less number of communication nodes, which can not provide stability. *The result is illness and aging of the physical body.* At the cellular level, DNA is responsible for providing communication with the Brain. Let me remind you that at the present time the 4 DNA codon is still inactive, and this state has been persisted throughout the entire intervention. *The beginning of the disclosure of the 4 codon provides a gradual increase in the octave of the Brain and its rearrangement to the dodecahedral base.* More precisely, the

formation of dodecahedral structures of the energy grating is primary here, and there is no question of raising the octave of the Brain, as long as the energy grating is formed capable of transmitting a charge with a higher density at higher octaves than the current state. The consequence will be a change in the spatial characteristics of the human body in relation to all levels of space. That's why you have to "strive" for taking **the Bath**.

But Space is a measure of time that takes the reactions to occur at an object. And each object has its own space. This means that the question of Consciousness is also in close interrelationship with such a notion as "time". Any change in the physical characteristics of an object leads to a change in spatial characteristics, and this brings to the influence of the object on spaces of **MUCH HIGHER LEVEL**, since all objects are in a certain interrelationship. So, the spaces are in the same interrelationship. Hence it becomes clear that the question of the development of the Consciousness and Reason of an individual or any element of the Subsystem can not be considered in isolation from the influence it exerts on the System, and the System can not develop without the analogous development of the Subsystems, but within the framework of the corresponding cycle.

Therefore, the Earth, as the System, can not move to a higher level of its development, until its transition to a higher level **IS NOT DONE BY PEOPLE**, in any case, ***by those who integrate into the new Civilization***, and therefore will be its integral elements. No matter how much anyone would like to interfere into this process – it will be exactly like this. Otherwise, it would lead to a gross violation of all basic physical laws, which is just impossible. Hence it becomes clear the role played by both individual and public consciousness of people in the entire process of evolutionary development of both Humanity and the Earth. All this is well known to those who have a false idea of their being the "rulers of the world". And what is characteristic – they know the way they will end their existence. But the relentless desire to "fight" for their place under the Sun, despite anything, won't leave them. However, no Consciousness or common sense in their current deeds are noticed. Just the Brain is "knocked out". But the dreams of "integration" – are still there. They believe they can buy. Let them believe.

THE MINORITY, BY DEFINITION, CAN NOT CONTROL THE MAJORITY. In practice, this happens, but the most vivid manifestation of this situation is cancer. **Cancer is a consequence of the disruption of the "cell-brain" communication.** By the way, in the above – mentioned "comrades" this is almost universal, however, it is carefully hidden and on

"healing", which for some reason does not happen, a fabulous amount of money is spent. The cell, as a unit of consciousness, tries to impose its "will", its "idea of development" to the whole organism. The result is known.

Similarly, it happens at the level of the Great Cosmos. The Civilizations that have chosen a parasitic way of development are trying to impose their will on the entire Universe and rebuild it in their own image. Cases of the death of Universes, unable to cope with the seizure and spread of parasitic civilizations, are described by N.V. Levashov (**"The Mirror of My Soul", Volume 2**) in every detail. Accordingly, for the Human Consciousness, the existence of the Control System having a higher octave is a vital necessity, from the point of view of the Control System itself. Otherwise, the existence of this System might be in jeopardy. And as an axiom – ***Man can not have a complete and correct idea of the true meaning and purpose of the existence of higher-level structures.*** As a consequence, an attempt to impose one's own will and own ideas about the goals of development upon higher structures (systems) can bring to a "surgical operation", manifested as the Human Brain's disconnection. The similar situation is at all levels. Potentially, according to the level of his Consciousness, even without increasing the octave of the Brain, a person is able to correct the diseased organ or body system independently (by the thought power), since for this organ or system, the Man's Brain is the Control System. Accordingly, for the diseased organ, such an impact will be a control correction. This correction, in the long run, is for the benefit of the diseased organ. If the case is neglected or the possibility of individual conscious correction is not accepted by the person, he runs to doctors who either perform an "operation to force peace" through drug treatment in relation to the "revolting" organ, or the "antiterror" operation comes into effect, and part of the patient organ (or the whole organ) is just eliminated. But the decision on such an impact is finally taken by the person himself, being the Control System for the given organ. Therefore, for the Person who considers himself to be the King of Nature and the crown of creation, and its "highest evolutionary point" can also be applied an operation "antiterror" on the part of the Earth Control System, and it should not surprise and frustrate him. But this is for those who **Are NOT** Users of the **"SvetL" Programs.**

One of the most important manifestations of Human Consciousness, as one's individuality, is will. When there is no resistance of the environment and no need to make deliberate decisions, often in defiance of the present circumstances, the potential for development is missing. Making a choice and applying strong-willed efforts to solve the task, a person **IS DEVELOPING NEW MATTERS** and thereby increases his energy potential, that is, acquires

and develops what in the worldly sense is called power. At the same time, being a spatial structure in the essence and changing the characteristics of his own spatial structures, the Man, thereby, **CHANGES CHARACTERISTICS OF THE SURROUNDING SPACE**. The decisive is the starting point of the choice and the beginning of the action, i.e. a choice of the direction of the way or the personal "purpose vector". Although a person almost never can foresee the exact consequences of his actions because of the present level of development, then, as a guide for his decision-making, he proceeds from those concepts that are significant to him personally. And this is also a matter of one's individuality. For someone such guidelines are honor, conscience, a sense of duty to the homeland or the loved ones. For others – itch for power, money, and popularity. But in either case, these concepts can be incentives to apply volitional efforts, which will affect the evolutionary level of Man. Here experience is always experience, and we can never know what way one will go on further. Once chosen, the direction is far from being final, and the opportunity to "wake up" is almost always preserved. And then the result and the experience, gained on the basis of some motivational prerequisites, can be used in the future, with their change.

An important point in considering the question of Consciousness is *the conceptual system*. It should be borne in mind that the current conceptual system is largely imposed from the outside as a result of the actions of the Interventional Control System. Formation of the conceptual system of Man was carried out mainly through the imposition of religious and scientific tales, presented as religious and scientific dogmas.

The first thing in the matter of religious dogmas was the concept of good and evil. With seemingly unquestionable nature of these concepts, one can not but admits that they *are formed on the basis of a binary measurement system and dual logic*. These concepts were indisputable for a Man and were not subject to doubt by human consciousness. Although it is obvious that these concepts can not be perceived in isolation from the context of the imposed paradigm, or in the esoteric interpretation – within the framework of the established picture of the world. What was considered good or evil in one religion, or as applied to a group related by the world outlook (the same religion, the same kin, the same people, the same ethnic group or super ethnos), could change its polarity in relation to another group. **"Do not kill"** is the law for your own people. But strangers, infidels or goyas can be killed and even must, because it is so pleasing to God. Also the reverse – not to kill the enemy attacking your Land, not to protect your Land – is evil, and can not be

forgiven. You can correlate all other commandments in all religions. Proceeding from this, it is necessary to recognize that **THESE CONCEPTS A PRIORI ARE NOT ABSOLUTE**. But Man in his conscious activity had never gone beyond the bounds of the laws imposed by dual logic and had never analyzed them. In order to have the opportunity to do this, it is necessary to go beyond the limits of the imposed paradigm. But any dissidence was brutally suppressed. And even when dissidence carved its way, it eventually turned into a new paradigm, built on the same dual laws. The level of Human Consciousness development just did not allow thinking and living differently. ***And here you do not need examples; the entire human (h)ISTORY (from TORa) is a confirmation of this.***

Scientific dogmas in this respect are no different from religious dogmas. Only the formation of these dogmas has acquired its fundamental importance at the final stages of intervention, mainly since the XIX century. Before that, even sketchy **SCIENTIFIC KNOWLEDGE HAD BEEN A DESTINY OF SELECTED**. Later, when universal education began to be introduced everywhere, scientific dogmas became decisive in the formation of both public and individual consciousness. With the seemingly expansion of the picture of the world, Human Consciousness became more and more enslaved. All the concepts imposed upon the conscious, in the process of formation of life paradigm turned into tightly laid brick wall, shielding the horizon. No scientific discovery could shake the system, as it was transmitted exactly by it. It would seem that scientific progress broadens the horizons of knowledge, but in fact, it only narrows, leading further and further away from the truth. But Man did not give himself the trouble in analyzing the basis of the conceptual system, what is put into the words that make up the basis of the scientific worldview. At present, science, in fact, does not have a clear explanation of its provisions. Any definition is nothing more than a set of words, behind which there are the same concepts that are not explained in any way.

In order to find the true meaning of any scientific concept, one should have the possibility of its multicomponent analysis, consideration of all its aspects. But for this, the Human again has no potentials, ***because the consciousness is built on dual logic***. Let us recall here cubic and dodecahedral grating structures. A cubic structure has rather few links; being in one node, we can move only in three directions within the framework of a more complex structure. You remember that in our present reality we have three dimensions. But the true **CONSTRUCTION OF AN ATOMIC**

GRATING IS MUCH MORE COMPLICATED. Accordingly, the number of connections is incommensurably greater. The dual consciousness is a straight line, along which we can move only in two directions. It does not give an

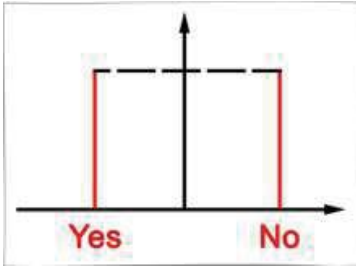

opportunity to examine and analyze in detail any concept. For this you should be able to move in all directions – to the right, to the left, up, down, inward and outward. But from each such a step, from each new node, you should again be able to move in all these directions. And with the greater number of measurements, the number of such

directions only grows. It is clear that for a Man in the present state this is impossible. And this blocks even the potential ability of his development. **The conclusion** – without the interference of the true ECS, without increasing the octave of the Human Brain, without forming a dodecahedral structure of consciousness cells, a Man is doomed to degradation, even if one does not take into account the inevitable final that was prepared for Humanity by the Ebr intervention.

Let's consider what significance for the development of Reason and Consciousness has a conceptual basis and the ability to collect in a single whole the fragments of various conceptual systems. After all, the inability to speak one language is an essential factor in the emergence of various contradictions, and these contradictions themselves speak of the duality of thinking, its narrowness and the impossibility of **UNITING ALL PARTS INTO A SINGLE WHOLE** because of one and the only reason that the same phenomena are named and explained differently.

But every concept is just a concept, when all the phenomena in all their complexity and versatility are being tried to fit into a narrow verbal form. These objects and phenomena, put within the framework of duality, the Human Reason is not able to embrace in full. And to have at least some judgments is necessary for a Man, otherwise he will not be able to find a company among his fellow-men in Reason, which is manifested most clearly today. The level of these judgments can differ in the same way as different groups of "fellow men" differ one from the other. It is impossible for a man to be without communication in general, and, so that not to lose this communication, each one should defend the interests of one's group as one's own, without realizing that one does not understand the true essence of objects and phenomena. It also concerns the members of the Clubs named after N. Levashov, which we created and which are successfully functioning. However, everything listed is

found in the people who created them. But there is no doubt that those who created these Clubs will help to overcome it.

Let's recall one of the basic principles of the control – **"divide and rule"**. For its realization it is enough to make some contradictions between different groups and to warm them up when necessary. And this has been successfully applied in any public sphere – religion, science, art, education, politics, and economics.

The purpose of science, for example, **IS TO FIND THE TRUTH ON THE LAWS OF NATURE**. But after all, everyone has one's own attitude to the truth. And the search for the truth in the academic circles has resulted in almost infinite conviction of the opponents that his view of the truth is more "true" than those of the opponents (I apologize for the tautology, but this is exactly like this). And these, instead of trying to convince one another of the fact, that the truth can be only one and all contradictions are no more than its facets. The reason for this lies in the fact that **THE ABILITY OF ACCEPTING THE TRUTH** in its multifaceted essence **WAS NOT OPEN TO THE HUMAN CONSCIOUSNESS AND REASON**, which completely satisfied the Interventionist civilization. But time is different now, and there is a necessity to form a completely different way of knowledge perception and quite another way of thinking. Today this is a vital necessity, from the point of view of individual integrating into a new civilization. And it is clear that this way can not be passed overnight – to change the way of thinking there requires hard and long work to change the very essence of one's own "I".

Let's step a bit back from philosophizing and try to show with the concrete examples that the object or phenomenon is essentially wider than the framework into which they were squeezed by various definitions. There are a lot of people who are eager to find and learn new things. It is clear that "a lot" is still only a few percent at a stretch, and a bigger part of them has a craving for knowledge in a very specific area – esoteric, and more – its sacral meaning. But even these "a lot" often cling to the level achieved, for the knowledge gained, like a child in a sandbox – for a favorite toy. And even more – they want their favorite toy to be the best of all. This is an analogy, but accurate. ***Very often, the gained knowledge is perceived as the ultimate truth, and all other points of view are swept aside as heresy.***

Is it a familiar situation? Not so long ago, among the members of the **RPM of the RGA**³², the point of view was actively promoted that the knowledge given by **N.V. Levashov** through his works – is the final truth, and if something different is accepted, then it is considered an anathema. And while time goes on, but these "fellow men" are still there. Moreover, the Movement as such is no longer exists. There are several regional groups that do not understand what they exist for and what they are doing. All this happened after the death of N. Levashov and happened exactly as I had told Nikolai at our meetings. But for that period – this movement was necessary. It's like a retreat, and the question of the truth then came up against their believe – that the knowledge of **N.V. Levashov and A.M. Khatybov** had nothing in common. And this argument was mainly proved by the complete difference in the conceptual system. And it turns out that again on the basis of only an external factor a conclusion is made about the whole essence of the subject. After all, the concept is nothing but an external factor, a shell, peel of a bulb. Try to separate at least the peel from the bulb, to make sure that behind the external differences, in fact, there is the same thing. It is clear that the volume of the material is too global to make a wide analysis of the Knowledge left to us by these Great Russian Scientists in their works, but we will try to consider certain aspects.

6.5. Energy conservation

Let us consider the law of conservation of energy, discribed in detail by **N.V. Levashov** in the book "**Inhomogeneous Universe**", chapter. 2.3. "**The system of matrix spaces**".

"Thus, as a result of the consistent formation of spatial structures, a balanced system of matter distribution between our matrix space and others is formed. After the completion of the formation of the Hexa-Ray, the stable state of which is possible only if there is an identity between the mass of inflowing and outlawing matter:

$$N^{(+)}dm_i di = 6 _^{(-)}dm_i di$$

³² Russian public movement "Revival of the Golden Age", which goal was to unite people in the name of their Great Nation and the country's happy and peaceful future, for the preservation of the Planet and its ecology. After the death of N. Levashov, "fell apart" into separate regional groups that pursued their interests.

where:

$N^{(+)}$ – the central area of the matrix spaces link up, through which the matter flows into our matrix space

$\eta^{(-)}$ – "ray" zones of link up with another matrix space through which the matter flows out of our matrix space;

i – number of matter forms making the Hexa-Ray;

m_i – mass of matter.

The identity for the whole of our matrix space can be written in a more convenient form:

$$N^{(+)}dm_i di = 6 \eta^{(-)}dm_i di = 0$$

As can be seen from this formula, the laws of matter conservation are not violated at any level of spatial formations. From the microcosm to the macrocosm **THEY ARE COMMON**. The unity of laws follows, at least, from the fact that the microcosm is the structural base of the macrocosm.

In the AntiHexa-Ray, the circulation of matter goes in the opposite direction, from the boundaries of this Super space down to its center. Moreover, the curvature of the matrix space is maximum in the boundary regions and minimal in the center of this spatial formation. The condition for the AntiHexaRay stable state is the harmony between the outflowing matter through the central zone of the matrix spaces link up and the synthesized in the boundary zones of the link up (external) by the matter of a given type of quantization of dimensionality.

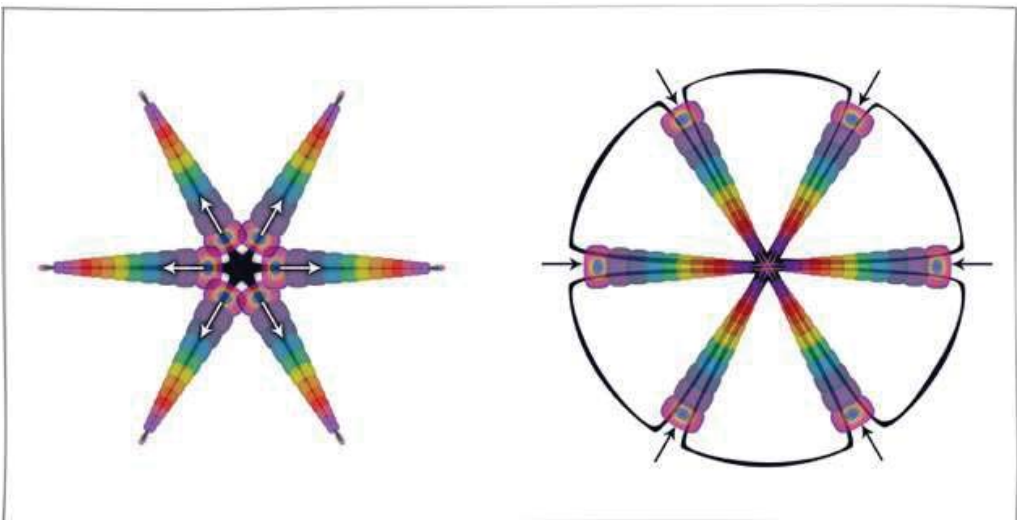

The condition for the balanced stability of our matrix space is the balance between matter synthesized in the matrix space and matter outflowing through the zones of link up of the matrix spaces".

So, the main condition for the stable existence of the system is the balance between the incoming or synthesized in the system matter and the matter outflowing from the System. This provision is a reflection of the law of conservation of energy. But this very situation is directly connected with such a notion as albedo. Albedo is one of the basic physical characteristics used by **A.M. Khatybov**.

The earth constantly reacts to the change in its albedo, reducing it – these are earthquakes, volcanic eruptions, and tsunamis. ***$E = 0$, that is, the sum of all the energy processes occurring on the Earth is equal to the sum of all the energy costs that cause these processes.***

The Planet abide is the "integral sum" of the albedo of all Planet atoms, including the atmosphere, ***and this sum must be zero***. On the Earth, thousands of small and medium-sized earthquakes take place daily, volcanoes can "work" for a long time, but all this does not happen at the same time and not evenly, so the Earth's albedo looks like a saw (even within a day), but the artificial albedo change brings to an increase of "teeth" of the saw and, as a consequence, a qualitative time change.

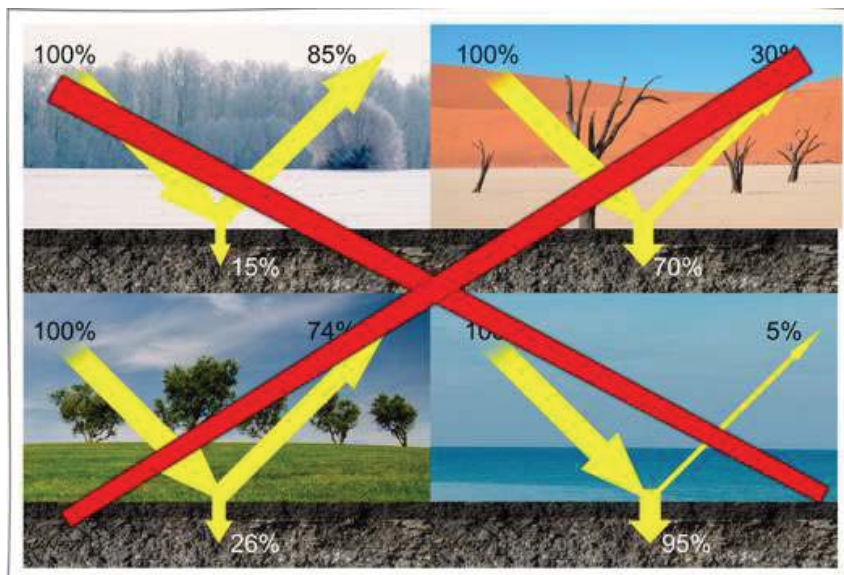

Albedo is **NOT** a **REFLECTIVE ABILITY**, as shown in the picture, but a property to change the potential, under the magnetic pulse action and a

gravitational wave. An atom has one property – atom energy constant is zero, but at the same time, an atom is *a gravity-magneto-electric Generator*. This is one of the main conclusions for understanding New Knowledge.

But this property does not belong to the wave function of the atom Generator, and since the change occurs abruptly, the difference between the accumulated electric potential and the norm (zero) is an atom albedo. Changing any parameter entails changing other parameters.

And now we correlate with the one written by N.V. Levashov. "Naturally, there are many such superspaces in our matrix space. They create, as if, nodes in the matrix space and are "atoms" in it. Again, the structure of the macrocosm is similar to the structure of the microcosm. This is yet another confirmation of their unity".³³

Hence a simple conclusion follows: matrix spaces also have a kind of atomic structure, and accordingly they have an energy grating, since the existence of atomic structures without energy gratings is impossible. And as we already know, *the macrocosm structure is analogous to the microcosm structure*. But this energy grating must have a dimensionality that is different from the dimensionality making up this space and contacting with this grating primary materials. Otherwise, the energy grating would interact with the primary matter in the zone of contact, and there would be a change in its qualitative structure, which would inevitably bring to the breaking of the entire energy structure. Energy grating is a kind of system of cords, which, on the one hand, are communication cords, and on the other hand, a charge conductor.

The **conclusion** that follows from this may seem controversial, but, nevertheless, I will take the liberty of expressing it.

THE SPACE MAY BE ARTIFICIALLY CREATED CIRCUIT, into which the construction of energy gratings built on a dodecahedral basis (at a human acceptable level of perception), is initially laid. *The space was originally "empty"*. Along the energy gratings, saturation of the Space with primary matter is carried out, which "fills" the space, flowing out of the nodes of the energy structure. The material embodiment of energy gratings is realized out of matter that initially differs in its properties and qualities from primary matter that flows through these gratings. It is enough for general understanding of the process itself, and it **ALLOWS** turning to the physics of the **"Psi-Field" Generator ("SvetL")**, which is created in a similar way.

³³ N. Levashov "Inhomogeneous Universe"

While operating the **Generator creates its own space** which is saturated with the necessary primary matters through the energy gratings nodes built on the dodecahedral basis. The **Programs** put in the Generator are attached to these nodes and decide which primary matters saturate the space created by the Generator, as well as their properties and qualities. The way of matter interaction and the consequence of this interaction are the realization of the **Programs put in the Psi-Field Generator**. This should be understood as follows: – The space created by the Generator is filled with the matters, in which certain properties and qualities are already laid, or rather – the "directions" of interaction with the Owner's Brain. Accordingly, the Programs decide exactly what kind of their further interaction is going to be carried out.

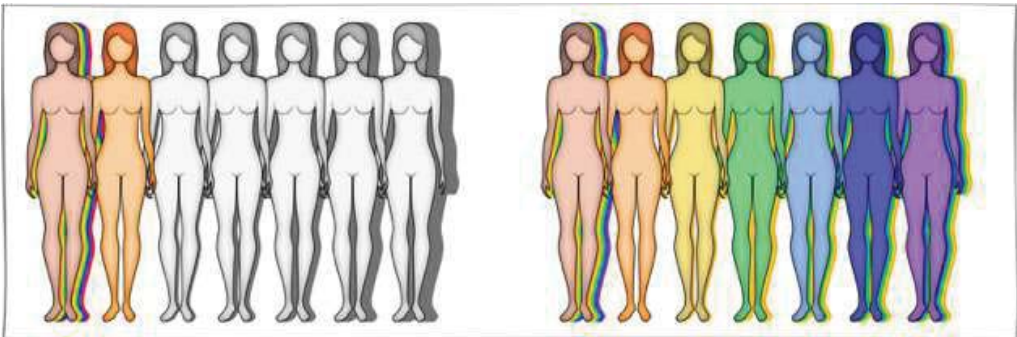

The space created by the Generator affects and reconstructs the space in which its user is located. It should be borne in mind that the Man's Spirit (or the Brain) is also a space.

The principle importance for the interaction of the **"Psi-Field" Generator** with the user of the **"SvetL" Programs**, has its platform or base, on which it is "attached" ("placed"). The energy grating structure of the **Generator's** carrier (site) determines the quality of the **Generator's** interaction with the user and the "speed" of the changes that are being made.

An essential fact is to recognize the ability of the energy structure of the carrier grating to store information. ***This enables the energy-information "record" of all transformations carried out by the "SvetL" Generator.*** Moreover, such a ***carrier can act as an archive of the Spirit's memory.*** Actually, what I have said above.

6.6. Discreteness and structurability of Matter

For a more complete understanding of the fact that everything written by **N. Levashov** is interconnected with the writings and calculations of **A. Khatybov** and is the basis for mastering and understanding the New Knowledge, I am giving you a short excerpt from the joint work with **I.M. Kondrakov**.³⁴

"The discreteness and structurability of Matter at the "lower" levels of the organization, in accordance with the laws of the Systems development, brings to the structuring of the Space itself, in which Matter is located. These geometric forms (tetrahedron, octahedron (cube), icosahedron, and dodecahedron) are taken by many crystals in the process of growth.

The superposition of various parts of the spectrum of electromagnetic radiation from gamma radiation to long electromagnetic waves, the distribution of Matter in an inhomogeneous space, in accordance with the laws of synergetic and harmony, form the corresponding structures, for example, (Hartman, Curie, etc.) grids. Here, the hybrid Matter itself participates in this interaction, also structuring the space around itself and in itself, creating crystalline and other grids up to the Great Cosmos, which is clearly shown in the figure below.

Here, under the numbers, there are separate major stages of structuring this space together with the Matter located in it. Position 1 – matrix spaces with a structured space after the formation of Reality (see SAV – Slavic- Aryan Vedas); position 2 – formation of stars and anti-stars (black holes). Then there is a fork: the development and structuring of matter and space on macro (positions 4-9), meso- (positions 4-5) and microlevel (positions 3-3 ').

At the micro level, the formation of structures of particles, atoms, molecules (simple and complex), up to to crystal gratings of various types of position 3-3 '. Then, at the macro level, as a result of a super explosion bringing to the space structuring and formation of a metaverse system (see position 6: 1 and 2), first-order superspace is formed by merging nine forms of matter out of 14 possible.

Here the law of the "golden section" is clearly manifested: the dimensionality differences between the "patches" of matter from 1-9 PM and 1-14 refer to each other and to the whole, as **8ΔL:13ΔL=0.618: 1**.

³⁴ Igor Mikhailovich Kondrakov, Professor, Candidate of Technical Sciences

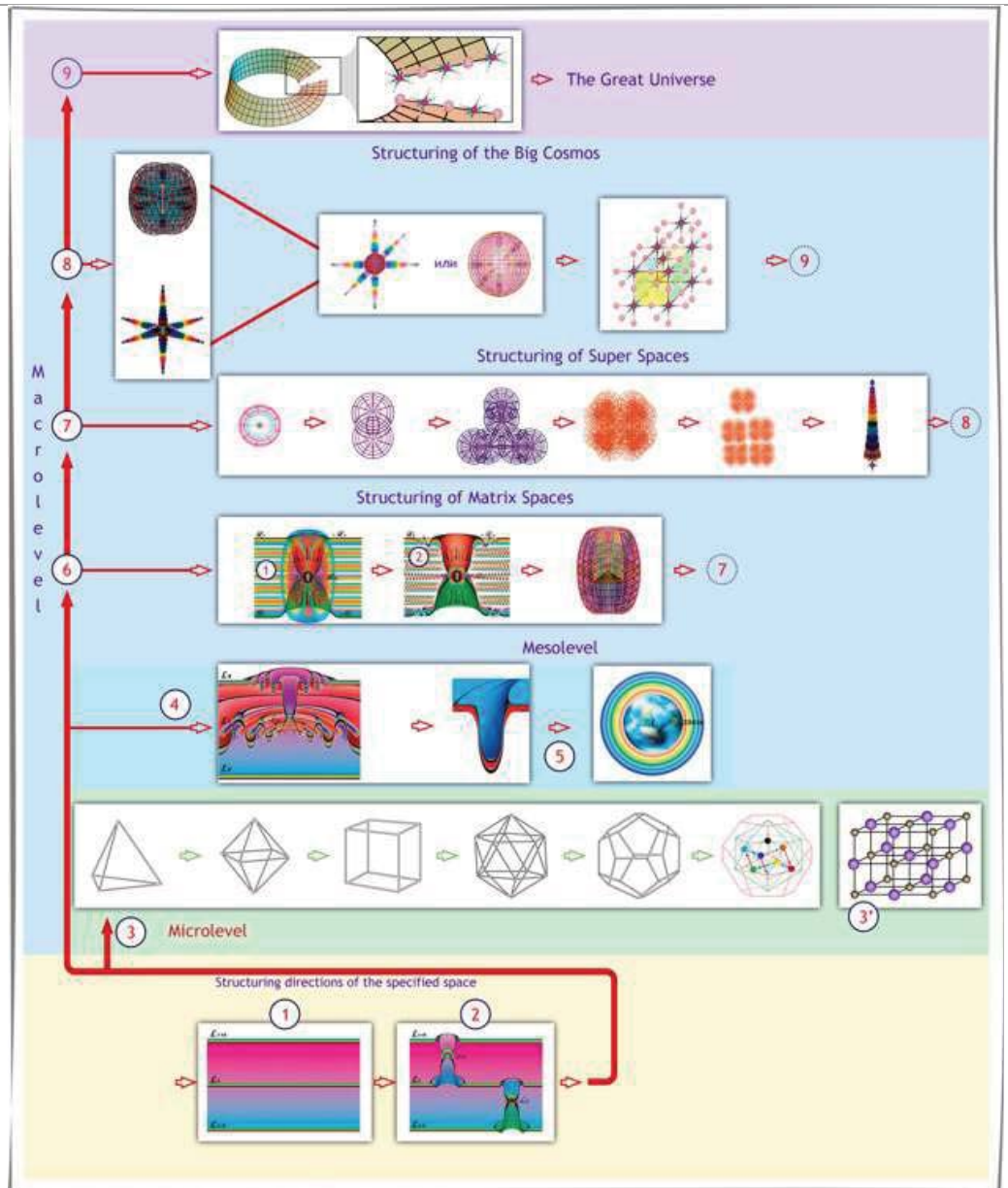

And it is not by chance, in harmoniously developing Systems (striving to equilibrium here) the ratio between the part of the system and its whole is within the value of the "golden section".

Further structuring of the macrocosm at the level of superspaces of the 1-6th order brings to the formation of "atoms" and "molecules" (hexa-rays and anti-hexa-rays) of the macrospace (clusters), which terminates in the formation of a "crystal" grating of the macrocosm (position 9), which resembles a

honeycomb structure, especially if it is viewed at a certain angle. In a confined space, this honeycomb structure is transformed into a Mobius band by virtue of the properties and qualities of the hexa-ray and anti-hexa-ray. ³⁵But this is already the Great Universe, about which we have no information.

At the mesolevel, the structuring of space takes place and, as a consequence, the formation of planets, in particular, the Earth takes place (the process is described in detail and shown in drawings by N.V. Levashov in his book (Fig 2.5.5.-2.5.12).

If there are appropriate conditions on the planet, **the natural ECS** (in the form of six spheres interrelated into each other) is automatically formed along with the most physically dense Planet, other structures and systems that continue developing the Planet itself: the atmosphere, biosphere with a multitude of ecosystems that form – at a certain level of development – society and, in some cases, the techno sphere (if the civilization goes along the technocratic way) or the noosphere (the sphere of Reason – if the civilization follows the way of self-knowledge and self-development). And further, if the Planet falls into the center of attention of developed civilizations, then the natural **ECS** is replaced with an artificial **ECS** (according to A. Khatybov), which guarantees further development of the Civilization in the direction of the Reason orientation. Here is a direct bridge to higher sociology.³⁶

After recreating the true "Earth Control System", the performing state covers both the structural aspects of the changes in the inertial and non-inertial energy states, and the change of the entire true Programmed **ESSENCE OF THE CLUSTER CONTROL OF THE EARTH BEING AS A WHOLE**. It can be defined as the causative basis of all the processes of changing the energies being on the Earth. When forming a new methodology of cognition, this side of Being should also be taken into account. Consequently, the methodology of cognition should contain the conceptions on the way the evolution of the surrounding world in its inertial manifestation is associated with the change in its non-inertial Matter component.

³⁵ N.Levashov "Inhomogeneous Universe"

³⁶ 'Fundamentals of the formation of Mankind' Parts 1-5

6.7. Consciousness Perfection

In the Universe there are no random processes inherently. All created, being created and ongoing is the essence of the processes of finding the Perfect State of the Universe comprehension of itself through the finding of the Consciousness perfection of all its constituent elements. Since these processes are not accidental, then, as a consequence, we can recognize the complete controllability of all the processes taking place in it.

At first sight you can find this conclusion, contradicting to **N.V. Levashov's** point of view. However, one should take into account that **Levashov** describes the **INITIAL LAWS OF MATTER AND SPACE FORMATION**, and, as a consequence, of Life and Reason. But any process or phenomenon submitting to the laws of Nature can be reproduced when appropriate capacities are available. And a higher level system is capable of reproducing processes and phenomena at a lower level system or, in other words, a subsystem. It is only necessary to know and understand these Laws and have the corresponding potential. On the one hand, ***the confirmation of this is the very development of Human civilization, when science tries to make Nature work for it, using its laws, not understanding them at least at the level that it (science) understands.*** It does not matter now how correct it has comprehended these Laws of Nature, and whether these experiments provide any benefit for the Earth and Mankind. The very fact is important. On the other hand, an obvious confirmation of this is the activity of N.V. Levashov. The most striking and characteristic example is the White Star³⁷ created by him.

Further it is expedient to touch upon the very nature of Matter and see if there is a fundamental difference in the consideration of this issue in the context of New Knowledge.

1. *"The spectrum of electromagnetic waves represents a spectrum of primary matters, corresponding to the spectrum of the quantization coefficient of the space γ_i ".³⁸*

2. *"This scientific and historical barrier transition in cognition **was symbolized by the scientific discovery (2008-2013), accomplished by the Russian physicist A.A. Luchin**, a colleague and scientific partner*

³⁷ N. Levashov "The Mirror of My Soul".

³⁸ N. Levashov "Inhomogeneous Universe".

of the **NII "CPS"**, (Scientific Research Institute “ The Center of Preventive Strategies”)who theoretically substantiated and experimentally confirmed **the divisibility of an electron** (nearly 300 years of irrefutable dogma collapsed), and the Swiss Collider can be disassembled as unnecessary) and formulated a different methodological view of the fundamental principles of the World construction: the presence of the primary matter of everything existing, that is, the matter of electric and magnetic fields"³⁹.

3. "The point is that the whole of Nature and all its elements, including living nature, have only two building materials: electrical and magnetic matter collected in one "mine" – an electron. Such a brilliant simplicity can only be created by developing infinite matter in the infinite space, for infinite time. These conditions provide a minimum of forms and their properties, but such forms which allow creating everything: from stars and fields to living nature, *including the intellect* and the senses.

This is the law of the infinite perfection and creation. This is the law of the highest expediency, expressed in the minimization of the number and absolute universality of the properties of the Universe building material".⁴⁰

Such conclusions bring to an objective study of electric, magnetic and electromagnetic fields and the idea of an upgoing integration of the World structure.

4. And some more from **A. Khatybov's** works: "*Albedo is a property of changing an electric potential under the action a magnetic impulse and gravitational wave.* An atom has one wonderful property – its energy constant is zero, but at the same time, an atom **is a gravito-magneto-electric Generator...** As for gravitational frequencies, there are no gravitons. **Gravity is the property of electric charge.** "

Proceeding from the citations quoted, it can be concluded that there are no contradictions on the nature of Matter in the views of the cited authors, and they generally adhere to the same positions, although they are considering the subject from different angles, or more precisely, with a **DIFFERENT LEVEL** of detailing. I have already mentioned that the works of N. Levashov are a **STARTING** point in gaining New Knowledge and, in particular, in comprehending the works of **A. Khatybov**, and not only.

³⁹B. Makov "What is the essence of the" Perfect Reason of Man "

⁴⁰ A.A. Luchin, A.L. Shapiro "Nature of fields. The view from the standpoint of classical physics and experience "

6.8. Dimensionality

We will not dwell on the knowledge of the ongoing events, and if we take electric and magnetic particles and their interaction as the basis of Matter, then we can try from this point of view to touch upon one of the basic concepts of **N.V. Levashov**, described in his works – **dimensionality**. There comes out a very interesting point. When it comes to dimensionality, N. Levashov uses very accurate figures with **five signs** after the decimal point. It means that this is a precise and clearly defined physical quantity. Levashov suggests that we should hit upon the concept that he uses on our own. Besides, as if accidentally, makes a footnote in the book "**The Last Appeal to Mankind**": **Dimensionality** is a collection of qualitative characteristics of Space. But Levashov's "accidentally" is a tip of an iceberg of **THE SKILLS OF READING AND MASTERING SIMILAR TEXTS**, which are written, as the author said, "layer by layer".

If we accept that the fundamental basis of matter (both primary and hybrid) are electrical and magnetic particles, and the possibility of the interaction of Matter depends on the identity of their properties and qualities, determined by the quantization coefficient of the dimensionality of γ_i , then it is logical to assume that the concept of **Dimensionality**, which conveys properties and qualities of Matter and Space, in one way or another, is connected with the interaction of electric and magnetic particles constituting this Matter and Space.

Properties and qualities of Matter directly depend on the quantitative content of these particles in matter, on their spatial arrangement and their interaction, taking into account the carrier frequency or octave. Thus, it is logical to assume that *dimensionality is a "certain" coefficient of electric and magnetic particles interaction within a given space and matter*. Even a slight change in this coefficient significantly changes the properties and qualities of both Matter and Space, in which this Matter is located. And since the concept of dimensionality is applicable to Matter and Space at different

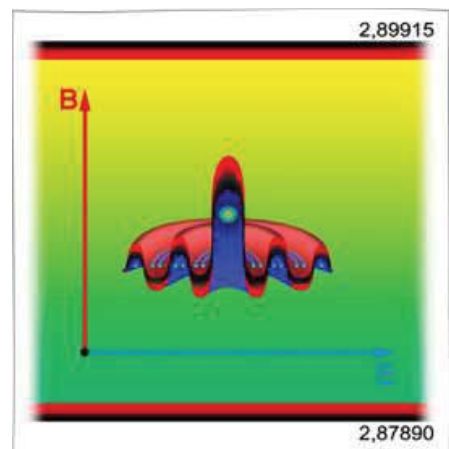

Electrical (E) and magnetic (B) fields astha aconsequence of dimensionality differential

levels of consideration – from the macrocosm to the microcosm, then **Dimensionality** at a higher level is the total coefficient of **Dimensionalities** composing this level of elements. *"It seems incredible that any atom affects macrospace, but, nevertheless, it is a fact. Naturally, the influence of one atom is microscopic, but their total influence is the balance that places the macro-space in equilibrium".*⁴¹

Exploring the microcosm, every observer "sees a great and loud sensation" that our vast World is built of atoms and their combinations – molecules. They are Stars, the Earth with its oceans and rivers, grass, trees and all living beings. And if we look into an atom structure, we see only three particles: an electron, a proton, and a neutron. There are also their fragments: mesons, leptons, which live for fractions of seconds and do not exert influence on the structure of bodies. Some researchers require adding the matter of fields in this triad. No question. But what is this matter of fields, which can be touched, but it does not let itself be caught? Out of respect for its existence, we conditionally add the matter of different fields to the named triad (electron, proton, and neutron) as the basis of World building material.

If now we look into the filling of the "elementary" particles and fields, then in an electron we see a lot of tightly adhered electric particles (photons) and magnetic particles (they have not yet been named), which together, breaking out of its inside, create an electromagnetic field in the surrounding space – a cloud of unconnected electrical and magnetic particles. This indicates that no special matter is required for the fields.⁴²



Now we are just trying to get closer to the structure of the microcosm. Catastrophically there is not enough knowledge, and therefore it remains to make assumptions and versions, trying to be guided by logic. The world of this knowledge is absolutely immense, just like the entire Universe. And it is also clear that using the words "a certain coefficient", the authors, in fact, admit in their inability to get out of this something more precise and objective. Let it be so, but we do not have anything more precise and concrete, so it remains to make assumptions and try to get to the bottom of the truth. But without such

⁴¹ N. Levashov "Inhomogeneous Universe".

⁴² N. Levashov "Inhomogeneous Universe".

attempts, you will never get to it. And to use only **READY-MADE KNOWLEDGE AND NOT TO TRY TO GO FURTHER** – is too boring. Even though this knowledge is truly grandiose.

But this is just a kind of distraction. Let us go back to the question of electric and magnetic particles and logically turn to the question of "fields".

6.9. To the question of "fields"

Look at how Levashov briefly described the necessity of "artificial" generation of the Brain right now and precisely in the criteria in which the **"SvetL" Programs** were created. Look around and ask at least yourself – is there (has someone else created) something like this? I have not yet seen or heard anything, except for the technologies and directions that **B.Makov** is engaged in **at the Research Institute of the CPS and V.S. Leonov**, an



outstanding Russian scientist, who recently became "public". I started to do this on all our Internet resources. The nature of our world, society, power and Human is such that the destroyer of the society foundation, including science, is always qualified as *a dangerous and sacrilegious rebel*. **Vladimir Semenovich Leonov** is such a "rebel", my Friend, Companion and member of **"RSTS" since 2005**. Today we can talk about him openly. Time has come for such people. I want to note that his assistance and advice in creating the **"SvetL" Programs** were invaluable and effective. But this is somewhat different, something that, unfortunately,

today can not be publicly shown and applied.

Regarding fields, everything is simple in its complexity. For example, to form a **criminal field**, it is necessary to have a State that, first of all, creates all the conditions for the formation of this field, and then creates in its environment similar structures to combat this field, and the more effective the conditions for creating the criminal field, the more difficult and sophisticated have to be the means to combat it. If these conditions have not been created, the State would have nothing to be engaged in. *The criminal field* and the structure that fights against it, are often mixed up, although this is the same and they are supplied from the same source.

A torsion field is an object of special care of smart dealers from science who **DO NOT HAVE ANY IDEA OF THE PHYSICS AND PROPERTIES OF AN ELECTRIC CHARGE**. Apparently, the authors of this, and other authors (or rather, the group of "scientists" that have already been mentioned) first have to study the popular science video for preschool age *"Alice in Wonderland"* – there is a conceptual basis for changing the form there. Some fields can be compared, for example: which field is more powerful – torsion or minefield. It might turn out that a torsion is heavier than an anti-tank mine. A group of "scientists" should know this.

A biofield (psi-biofield) is a special subject. **Firstly**, this type of field is defined as a scientific term, and **secondly**, it is not only found in humans. It is also noted that yogis do not have a biofield, it is understandable – they take care of themselves.

There is no evidence that *a living cell is the source of the biofield*. Only the presence of radiation is noted. This conclusion is confirmed by the presence of doctoral dissertations on this topic. The **radiation of Kirlian** is not included in the biofield and can not be attributed even to the biofield carrier. The size of the biofield is measured by a frame (see the "psychic" frame) and the correction is made in line with the measurements (that is, the waste is driven from one place to another without disrupting the integrity). Such a correction is scientifically justified, the **Ministry of Health issues licenses for**



biocorrection. A biofield is the main argument of biologists and physicians when explaining the causes of diseases, as well as of those "advanced healers and psychics" who are using such beautiful terms when talking with their "patients" (having no idea of their meaning), like the **energy**

of "Yin" and the energy of Yan.⁴³ It is particularly advertised in radio programs. A biofield is one of the vertices of obscurantism.

Concerning the use of fields in the national economy without involving science, one can give an example of the movement of a larger diameter erythrocyte in a vessel of smaller diameter. This fact may well lead to the discovery of a new field and help those who are engaged in cloning. From the answers to this question alone, a separate edition can be made. There are several versions regarding the names of effects, and one of them – " does not go with the vocabulary scarcity of the creators of the new type of field or the "creators" of the Generator – by analogy with Ellochka the cannibal (from the "12 chairs"). Therefore, for each new phenomenon, only one name is prepared in advance – a "field", which was applied by those who ***do everything on the basis of N. Levashov's knowledge***. But there is another vision and our Knowledge, which in combination we applied with N. Levashov initially. A field must have a carrier: ***if it is an electric one then – an electron, if a financial one – then a measure and so on. A FIELD DOES NOT EXIST WITHOUT A CARRIER***, whatever theory it is being concealed with. But both in atomic structures and in our environment there is only one field – ***the electric one***. It is its ***properties in various 96 octaves of state, 64 angles of slip in each octave, 18 variants of forms of impulse transmission, and so on – in combinations are perceived as different fields***.

Exactly in this definition is Levashov's answer to the questions of "inconsistencies" in the information obtained from his works and the works of A. Khatybov. When creating the **Generator** and the primary "**SvetL Programs**" for it, Levashov, I remember that well, was confronted with the fact that explaining the work of the Complex and the Generator, in particular, from other positions (from the positions of Khatybov's writings), it would, on his part, illogical, as it required changing many concepts (only in terms of terminology), given by him in his books already published, which could "confuse" the readers. That is why now, when presenting basic questions and positions, and especially concerning the **Generator** and the **SvetL Programs**, it is necessary to lay bridges between Levashov's and Khatybov's concepts. Perhaps you, dear reader, will need another systemic view of what they both stated and what I have written so that you could see the picture as a

⁴³ From the "magic of Feng Shui" – Yin-Yan – these are two opposite energies, dark and light. The law of Yin-Yan means the interaction of two opposite principles. Everything that belongs to the weakened energy belongs to the Yin – the female principle, but that to the strong energy – Yan – to the male principle.

whole, regarding the Generator and the Programs. And here's another subject I would like to draw attention to – many admirers of both Levashov and Khatybov **LITERALLY UNDERSTAND SOME INTERPRETATIONS** that are outlined in their writings. For example, "Ebrs conquered the Earth", so immediately, after this, everything had to become "Ebr-like". After this, there could not have been any progress in development and on the Earth in general, in their understanding. But, at the same time, **1543 years ago** (for 2015), the starships of our ancestors flew. This is very important to understand in order to stop thinking that the "bright future" will come tomorrow. Many people already see that the old scheme of governing the human civilization has been operating erratically, with sneezes and coughs, producing clouds of pink, tasty smells of pleasant service, encouraging forecasts for the future and simultaneously launching deadly poisonous tornadoes of terrorism, nihilism, wars, discord, disobedience, ecological crisis and other horrors. **THE OLD WAY OF CONTROL IS OPERATING FROM FORCE OF INERIA**, creating new difficulties, although in smaller quantities and scales due to the growing influence of the Earth Control System, which has become Native. The life-support system of Man is also changed. But this does not mean that people (or rather their Brains) immediately saw the light and changed their world view. The force of inertia of Ebr programs is great. The true and effective meaning of this process, already taking place under the control of the new System, is the "clearing" the Brain information blocks (both at the level of its antineutrino state and the matter states of the Brain neurons magnetic energy) from the elements of past information on the basis of which previously people's Consciousness and all subsequent common world outlook, practically on all questions, including "their worldly life arrangement» were formed. We are going to come back to this subject again.

Another thing is to accelerate these processes in oneself independently. ***There is a Bath, a Broom and a Spade. The choice is yours.*** Everything should be expressed in only eight words: **"The more you know, the more you can"**.

So, there are three ***"fields as physical structures, conventionally they can be called: electric, magnetic and gravitational. They differ in the frequencies and charge properties (octave charge 4-512)***. But let's not forget that gravitational particles do not exist, and gravity is the property of electric charge.

If the octave of the charge is **less than 64**, a rigid structure of the proton atom (Matter) is formed, habitual for a Man dense Matter, or substance.

If the octave of the charge is more than **64 (up to 512)**, a **NON-INERTIAL MASS QUANTIZED BY THE PURPOSE AND PROPERTIES IS FORMED**. The non-inertial mass, as we already know, is a highly organized plasma.

But there are also gravity-electric, gravitomagnetic, electromagnetic, gravito-electro-magnetic fields, as well as 512 types of interactions of these fields.

The **gravito-electro-magnetic field** is generated, in particular, by a gravitomagnetic-electric Generator, which properties are possessed by an atom. But we, to a large extent, touch upon the questions of Consciousness and Reason. And here it is appropriate to quote from the works of A.M. Khatybov. *"Each living cell of the Brain is an electro-magneto-gravitational Generator, and the Brain, on the whole, autonomously supports the albedo of the entire human body, creating optimal living conditions for every living cell of the body. These conditions ensure the work of the whole organism as a single system. Each cell of the Brain contains information on the development of the Human, its structure and determines the lifetime of the cells of the body. Taking into account the special role of the Brain in the formation of personality, it is necessary to have information not only on the Brain albedo (as a whole), but also the albedo of all organs of the Human Body."* It is clear that by definition the Generator, generates what it is intended for. Accordingly, the electro-magneto-gravitational Generator generates corresponding fields with the given frequencies. But the "Psi-Generator", created by **N.V. Levashov**, which is used in the "**SvetL**" **Complexes**, also must possess and possesses **the characteristics of an electro-magneto-gravitational Generator** in order to be able to interact with flesh cells and Brain cells at the same levels of dimensionality, which they possess. But at the same time there is an inherent ability to increase this level of dimensionality through the **Programs** installed in the Generator.

Albedo of a living cell varies in a wide range. However, this applies to the case of the Brain normal functioning with albedo of the Brain cells $E^a=O$.

Change in albedo by the "**SvetL**" **Programs**, entails not only a change in the time of the processes in the atoms which the Brain cells consist of, but also their spatial arrangement. With an increase in albedo in relation to the norm, the time is shortened, while "the hours of life" are accelerated, and this **ACCELERATION CAN BE OF SEVERAL ORDERS**. In connection with the change in the time of the atomic reactions, not only the values of the

magnetic impulse, gravitational frequency and electric potential change (which changes transfer the cell to a decrease in the magnetic impulse with increasing gravitational frequency), but the reaction itself also changes for the condition of maintaining the overall energy balance. Gravitational frequencies with a magnetic impulse, supported by the electrical potential, having a Control Program (of life), naturally, **WILL USE CONTROL FUNCTIONS** on those structures that will be attainable in the new space. Having such an access and control functions, it makes no sense to transfer the former cells back, since we have a ready-made control system.

A little bit about magnetic matter. Magnetic matter or magnetic particles do not have a special name and, as we see, do not have a relationship to gravity. But magnetic particles are very important in the structure of matter, its properties and qualities. Here, not only metals can possess magnetic properties. With an increase in the number of magnetic particles in an electron, the properties of a magnet can acquire any materials and any substances. Another question is that it is "not so simple" to arbitrarily increase the number of magnetic particles in an electron, otherwise we would live in a completely different world. But, there are mechanisms for this. And we have to make it clear in detail, since this factor is going to be important when considering the question of Consciousness. *"A magnetic particle has a bipolar structure, its density is by 4-5 orders of magnitude greater than that of the photon density, and the structure of its field lines is the same as that of a permanent strip magnet. Without an external magnetic field inside the magnet, chaos is created of these two particles. But under the influence of the external magnetic field, an organizing principle is formed in the chaos, which forms magnetic filaments from the magnetic particles and ejects them from the magnet in the direction of the organizing field action. The ejected filament (flagellum) moves from the magnet until the photon attraction force stops this movement, and the field forces of the opposite pole turn this flagellum to the other end of the magnet and close up with a field of photons. If, on the way of the field line, there is a ferromagnetic, the line of force breaks off, connecting with the magnetic. The power flagellum becomes shorter, and the photon field forces pull it back into the magnet, i.e. there is an attraction. This retention of the flagellum by the field photons forces is constant in magnitude. But if the length of the flagellum changes, becomes less (which is important), then the force with which it tries to detach from the maternal mass is less, and the photon field pulls it inside, trying to reduce the tension that has arisen.*

Nature does not like tense state, because it takes energy. It tends to minimize (better to zero) the energy costs. The dynamic equilibrium of the

flagellum of the magnetic field of a permanent magnet by the forces of attraction of the internal photon field (electric field) of a magnet can be disturbed by an action of the magnetic field of the magnet on the power flagellates, for example, by centrifugal forces which give an extra force to the flagellum and it breaks away from the magnet.

The figure shows the device, \square **the Generator of an axion field**. *The space in which the flagellum of the magnetic field is located looks like this, that is what is called field lines, flying or located in any body, freely penetrating them. Hence there is a unique opportunity to make any body (object) magnetic, regardless of whether it is wood, aluminum, plasticine or water. It is only necessary each time to select certain speed for the flagellum*

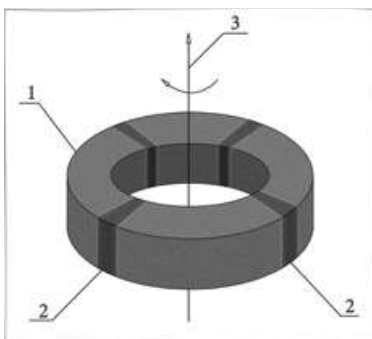

The generator of the axion field: 1 – Ferromagnetic material, 2 – Permanent magnets, 3 – The rotation size is: 020×012, height – 6 mm.

of magnetic fields, so that, penetrating into the body, they could be inhibited in it. It would be good to make these flagella spiral, for example, then their penetration into the depths of the bodies would be difficult, and the creation of large concentrations at shallow depth would help to obtain a powerful magnetic field in a small volume.

Moreover, such concentrated magnetic matter would, in a short time, be covered with electric charges of such densities, it is better not to talk about it yet".⁴⁴

The description of the above experiments shows that such a design significantly **CHANGES POTENTIALS OF A MAN AND HIS CONSCIOUSNESS**. On the other hand, in this situation, a Man gets most powerful instrument of influence on the environment and people. That's why the so-called "opening the Brain" (which many people dream of) is made "slowly" and directly depends on the Man's knowledge development. There is no other way at this period of existence, as any tool can be used for both good and evil. I hope that the Reader understands me in the right way. But I am also writing it in order to make the skeptics understand – "to give" such a capacity today to practically any man is quite possible. Another thing – is it worth giving?

⁴⁴ Luchin A.A. "Physical Fields: The Materialistic Concept of Classical Physics".

So that not to be unfounded I am quoting here another passage from the above-mentioned book: *"Under the influence of the Generator "Comfort" radiation (as the author A. Shpilman called his axion, it is also a torsion Generator), the carbon stick of V.S. Grebennikov's detector turned at an angle of 90 degrees. (About V.S. Grebennikov, his detector and experiments, you can read a lot on the [интернет](#)).*

By changing the angle of exposure of Grebennikov's detector, D. Wilcock randomly sent a beam of radiation to the window that faced the street..." I decided to strengthen the beam by making a bowl of my hands by the "Comfort" Generator, and kept them so for about 2 seconds, and during this time a bright spherical flash appeared outside the window on the line of the beam. After three seconds, a lightning flashed. I went outside to have a look, and then a second flash appeared at the same point. Back in the house, I turned on the "Comfort" Generator and directed it at the window. Outside there was no rain, no wind, although there were some clouds in the sky. In the first 10 seconds nothing changed. In the next 10 seconds a wind appeared which blew in the direction indicated by me for 20-40 seconds: the wind increased, and a slight rain began. 40-60 seconds: the rain intensified, it became very heavy, 60-90 seconds: the rain was getting heavier, there was a rumble of thunder... I had a heavy headache. I turned off the Generator. Within 80-90 seconds everything stopped – there was no rain, no wind".

Further, he writes: *"In the American Association of Psychotronics in June 2002, I held a demonstration.., in which I turned the properties of a glass of vodka into a glass of water with the help of an axion field. Some of those present could feel alcohol 10-15 minutes after the energy influence".*

David Wilcock also cites some of the results of his experiments on healing people. One of the patients showed that..." his consciousness expanded very much only after three treatments in three weeks – he remembered his dreams, clairvoyance, telepathy, foresight, etc." My remark – I'm sure, in a month, everything was forgotten and Consciousness returned to its original state.

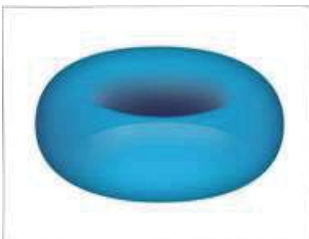

Why did I bring this passage and why do we need to understand these mechanisms? If we refer to the "construction" (if it is permissible to put it this way) of the Psi-Generator "SvetL", then one of its most important elements will be the "imputed" to the Generator site – Thor. Thor today is the most "acceptable adapter", which allows implementing

the transforming processes without destruction (the method of transformation) **between the old and the new.**

One of the significant Thor roles in the **Generator "SvetL"** is precisely the increase of the magnetic component in the bodies of the user's Spirit. In the final analysis, when the physics of the process is considered, the dimensionality of the bodies increases. It is known that the **Generator "Svetl"** thinks. But from a physical point of view, this is due to an increase in the charge density. A.M. Khatybov believed, and I agree with him, *the cleverer the Man, the higher the charge density in the thinking process.* When the cell acquires a magnetic component at the level of a dense physical body, an increase in the number of magnetic particles takes place, which brings to an increase in the charge density. This happens both at the level of the proton atom, i.e. *inertial mass*, as well as at the level *of non-inertial mass*, which contributes to the development of additional "bodies" of the Spirit. But so that the conductor could be able to withstand a charge with a high potential, it should have the appropriate characteristics. As applied to Man, the conductor is an energy structure at a non-inertial level. Hence, before increasing the charge equivalent density, **IT IS NECESSARY TO GENERATE SUCH AN ENERGY STRUCTURE** which will be able to sustain such a charge. Otherwise, combustion is inevitable, which means the destruction of flesh cells. It is clear that here it is a matter of *changing the structure of the energy grating, gradual transforming it from cubic to dodecahedral*, as well as changing its qualitative structure, increasing its conductivity. Therefore, for the **"SvetL" Programs** this is one of *the priority tasks.*

It is known that the **THOUGHT is MATERIAL**, and also you can talk here about the effect of "intention". The concept of "intention" is not scientific, but rather isoteric, but, nevertheless, it is exactly so. In other words, a thought having a higher charge density has a greater potential for realization. An increase in the number of magnetic particles by the bodies of the Spirit brings to an increase in the energy potential of the Spirit (or the Brain, whatever you prefer). But since people are different, and not all even among the users of the **"SvetL" Programs** have learned to **CONTROL THEIR THOUGHTS CONSCIOUSLY** some blocking mechanism is necessary, which does not allow realizing negative thoughts. Such blocking mechanisms were "laid" by **N.V. Levashov** in the process of restructuring the Brain, so that the Man after having such a restructuring could not be able to do anything to the detriment of others and himself; **the same mechanisms are laid in the "SvetL" Generator.** That is why the basis of the potential for the development of the

User by the "SvetL" Programs is *an unceasing work on transforming one's Consciousness, increasing perceptiveness and, as a result, the ability to control and analyze one's thoughts*. Let us return to the question of the Mobius tBand, which was touched upon in the first chapter of this book.⁴⁵

The Mobius Band

"Antimatter for our Universe is a native matter for the Universe, from which it came into our matter. Therefore, the only space for which there will be

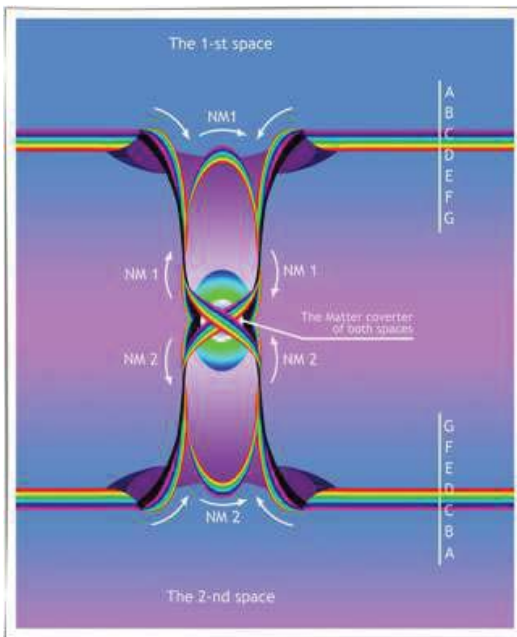

no harm – is this particular space. The only way to prevent the advance of this cyclone of antimatter in our space is to return this matter to its native space. But it's not that simple. If we just find a way to transfer antimatter to its native space, there comes a disturbance in the balance of spaces, which is no less problems than the antimatter cyclone. So I decided to try to create a converter of matter between these two spaces, which looked like an immense eight, in the center of which was placed the matter converter of both spaces. The Eight was created by the Mobius band, formed by the curvatures of

both spaces. Moving in such a curved space, any matter passing through the zero point, was completely disintegrated into primary matter, and after passing it, the latter created a new matter, harmonious with the other space. But the curvature of the space in the form of the eight did not allow this matter to escape the passing point, and this matter, moving along the Mobius band of this eight, returned to the passing point and again passed the point to our space and was already moving along the Mobius band in our space. In short, the antimatter was trapped".⁴⁶

⁴⁵ Book 2, Chapter 1 "HIS Checkmate to the System".

⁴⁶ N. Levashov "The Mirror of My Soul".

This fragment gives an understanding of how important the Möbius band is in constructing Spaces. It allows you to touch another puzzle, namely – the way to create **"flip-flops"**, i.e. to the mechanism by which Nikolai Levashov returned the "dark ones" to the point of evolutionary distortion, thus, bringing them to a harmonious way of evolutionary development. There were about the same mechanisms here. After all, the way of evolutionary development of Reason, whatever it may be ("light" or "dark") is also the Matter development, formation of its certain qualities, out of which the Spirit is "formed". And it was thanks to the Mobius band that it was possible to create conditions under which Matter, possessing these or those qualities, can be, as they say, "infinitely looped" and brought to a converter which operation principle is described in the above fragment. And in the converter to lay the conditions under which the matter can go into another cycle of development with new qualities corresponding to the "light" way of development. All this can be attributed to the **"SvetL" Programs**, which are "applied" in the Generator depending on the tasks assigned, related not only to the health improvement of the User.

Here, there comes another assumption, or, if you will, a version related to the structure of DNA and the **secret of codon 4**, which Ebr have not been able to guess. The DNA seems to contain the principle of the Mobius band. The eights, as part of the DNA helix, are not so difficult to imagine. There should be no breaks in the rings joints. The spirals should be connected into a single circuit. Of course, the idea of DNA, which comes from official science, is far from reality, and its true form is different. ***DNA is a double spiral, the spiral pitch corresponds to the frequency value with the number $\pi=6$*** . The question is in its joints, and this already affects the harmonious flow of Matter and the functioning of all the joints in the input-output. Ebr might have not been able to recreate some analogue of such a converter. As a result, the violation of connections and, accordingly, the albedo, which brought to a very short life of the living cell relative to the potential. But I am saying it again, it is only an assumption. Although any assumption might be a starting point in the movement toward the truth. **The main thing is to set a goal to find it.** And here it is important to understand what is included in the **"Psi-Generator"** in addition to the functions known to us.

In Nature everything exists and develops according to unified laws. And we should understand that the **"SvetL Programs, or, to be more precise, the Psi-Generator with the "SvetL" Programs**, can in no way operate in contradiction with these Laws. On the contrary, it is created as the embodiment of these Laws, but only at an incommensurably higher level of their

understanding. As it is, the process of grounding transition to a new Structure of the organized society Being naturally requires the elimination of the old System, but not mechanically by aggressive destructive violence, as it was traditionally done before, but **THOUGH** the **TRANSFORMATION OF THE PUBLIC CONSCIOUSNESS** and elimination the previously imposed worldly principles, first of all, in *public consciousness of the prevailing part of society*, i.e. previously limited through social parasitism over them. The process of such general clearing of the Brain "information blocks" is carried out by informational substitution through a new energy-information transmission from one of the true Control Complexes, using the technologies of the former Main Interventionist Control Complex Checkov as the final Control translator for this period of the ongoing transformations. The very realization "technology» of such "information substitution" is surprisingly simple by its essence, but on the people's initiation of their technical capabilities, **IT IS NARROWED DOWN TO ITS IMPLEMENTING AT THE PRESENT LEVEL OF DEVELOPMENT** (mainly by the level of observation of changes in the neurons states and the like). This is due to changes in the states of matter of the magnetic and electrical energy Brain cells (its separate functional regions), the program of the "active state of interaction" of the Brain's neurons (neurophysiology has detected some fragments of neuronal connections in some kind of unknown to them scheme similar to a biocomputer), lymph and much more. This is one of the most important elements of self-knowledge, as one of the secrets of the "World Created", which should remain not only unpublicized, as well as some potentials of **"SvetL" Programs** in this direction, but also completely closed, since the basic everyday aspirations of people have not yet been "cleared" of the effects of parasitism and violence, especially in the states of social Consciousness.

In the **"SvetL" Complex** unlike any known mechanisms and devices, although their comparison is in principle unjustified, its own development potential is laid, and the **"SvetL" Programs** work in close relationship with the changes taking place on the Planet. But who said that this potential is limited by the Planetary changes? The overwhelming majority of people today simply is not able to go beyond the planetary level. **N. Levashov**, in this respect, was not limited even by our Space. In his writings, he said, and I know, that he "had come" to Midgard-Earth from another Space and it is clear that he had come not at random, but with quite certain tasks that were performed brilliantly, no matter who and what said about it. And this means that his Spirit (his Brain) carried Knowledge of other Universes, completely different Worlds and another Cosmos, and as a result – about Control Systems of a completely

different level. Therefore, the question asked by the **Users of the "SvetL" Programs** is whether **"SvetL"** is only a health device in the medical sense of the word, or it is something quite incommensurably greater – you will answer on your own when you finish reading this book. At least, I hope so.

6.10. Health Improving and Transformation

With questions related to "health improving, we should **look into it** much deeper. To be more precise, this is not a matter of healing, but of Integrating into a **future Civilization**.

Integration is impossible without a gradual, but binding increase in the **Brain** octave. But what does it mean to increase the octave in the physical sense of this process? With an increase in the octave of existence, the space of existence also changes. Here is an example: The Cat "Behemoth's"⁴⁷ Brain corresponded to 87 octave, and there was a power of 12.8428 w / m. But in octave 63 it did not exist, it was an ordinary "barabashka"(come out), that is, with the octave of existence increasing, the space of existence is increasing, too. You can not raise the Brain octave **WITHOUT CHAGING THE SPACE OF EXISTENCE**, that is, ***the gravitational values are to be at octave 65***, and this changes not only the optics, but also all previously installed parameters of the Celestial Mechanics.

So, with increasing the octave of the Brain existence, it is also necessary to change the gravitational octaves. An octave is directly related to the vibration of the magnetic pulse in an atom. The octave and the corresponding energy frequency determine the



specific structure of the Space. This frequency of beam waves, characterized by 8 parameters, determines the set of conditions necessary for the existence of a living cell in a specific space. The space of the present existence of Biostructures is octave 64(n=64) as **THE LOWEST LEVEL FOR A LIVING CELL**, if I can put it this way; it is simultaneously designated as a space code (code 64).

⁴⁷ M.A. Bulgakov "The Master and Margarita"

And you should keep it in mind that still there is a concept of a Biological octave: the frequency characteristic of the specific bioobject Brain connection in the conditions of normal relation of the life support basic parameters – **type I**.

Type II – the maximum frequency of metabolic processes. What does it follow from this? And it follows from this: if the house is to have major repairs, is there any point in painting the walls and changing the wallpaper? If there is, it is more expedient to strengthen the load-bearing structures in order to preserve the structure in principle, and start setting the scaffolding, if the repairs are very soon.

The increase in the Brain octave is impossible without increasing the flesh cells octaves, and all this means in a complex a **TOTAL REORGANIZATION OF THE ENTIRE HUMAN ORGANISM** and bringing it up to a state where it can exist and develop under the entirely changed conditions. If a certain device is designed for 220 volts, then when the voltage increases, it will just burn out.

It's the same with the human body. **The cell in its present structure is not able to exist with the Brain** octave increase, it just collapses. Hence, without changing its parameters of existence and bringing it in line with the new space parameters, *its further life is impossible*.

Let's return to the above data on the "web". Proceeding from the above explanation, one of the main tasks is the basic reorganization of the entire carrier structure of the electromagnetic gratings for the new tasks with the aim of adapting it to the changed conditions, *from the atmosphere gratings to the living cell*. Without such restructuring, the **EXISTENCE OF A LIVING CELL** and, as a consequence, of a biostructure, becomes **IMPOSSIBLE**. The grating is the basic condition for the life existence, as such. Any conductor has to provide the possibility of moving the charge and the magnetic pulse, and if it does not correspond to this task, then its availability has no sense. And since the "web" was created based on the realities of the previous CS, then, in the changed Space conditions under the Native ECS (today), **IT IS NECESSARY TO AGREE ALL THE LEVELS OF SPACE** on the Earth and the entire "web" transformation. And this is happening today. And we are observing it everywhere in the realities of the ongoing changes around us (the weather, abnormal phenomena, the formation of gaps in the Earth, the shallowing of rivers and lakes, etc.). The brain, created for the "web" without changing the entire structure of the gratings, will be deprived of the ability to get and process incoming information and will find itself in the

information vacuum. This can be observed in the behavior of individuals who "flash" on the TV screen. And without information there is no *Life*, not to mention the fact that the Brain (the Spirit) is deprived of the ability to get and process signals coming from the flesh cells, which also brings it as a Biostructure Control System to a state of total collapse and inability to perform its functions. Consequently, ***such a biostructure is subject to destruction, and the Brain – to removal.***

So it turns out that the ***"SvetL" Programs interacting with the user's Brain entirely restructure the Human body or, at this stage, get it ready for such restructuring,*** forming the necessary dodecahedral structures of energy gratings (girders and scaffolding). And we want them (I mean the Generator with the Programs, regardless of their carrier), ***"to cure us immediately of the cold or hemorrhoids"***. But if there are diseases that are a threat to existence or, for various reasons, an obstacle to all further transformations, the elimination of such diseases becomes ***a priority for the "SvetL" Complex, regardless of whether the owner wants it or not.***



Have a look at this photo. Even with the knowledge we already have, it is enough to understand that this design is very close to the "Psi-Generator". Here we see the THOR (see above), the eight, resembling the description of the Möbius band, as well as the DNA helix rings. But this is the process of development and formation of a young star somewhere in the distant Cosmos. And now remember once again what you already know about the Mobius band. What potential of transformation and development does the **"Psi-Generator"** with the **"SvetL" Programs** carry, if the stars are formed according to the same laws laid down in it? How many millions of functions, tasks, Programs (for this, even the right word is difficult to pick up) does it carry in itself?

Maybe we should pay less attention to the fact that for some six months or a year of using the **"SvetL" Programs** we are not yet a model of youth and health, and we should think more about the potential of endless development that is just given to us as a **gift by N. Levashov.**

"SvetL" Programs are "built-in" and "coordinated" with those Programs of the Native **ECS**, which are now displayed and are transforming almost everything around us. I am writing and emphasizing it many times. **Complex "SvetL"** here becomes a kind of analogue of the Man's own Control System, or rather of his Spirit. It should not be taken as something imposed from the outside that transforms the Man (the Spirit) into a governable structure. No, and no, again! Without the Control Systems there is no, and there can not be life on the Earth, without it there can be no development of global galactic structures and clusters. But the Control System (it is clear that here we are talking about the Systems of Thinking Civilization, since the Ebrs also created the CS on the Earth) – this is also a developing structure with a very profound if not infinite development potential. The consequence is that the Subsystem, being in close relation with the System and having a double-acting communication with it, also has an unlimited potential. And this means that the System for the Subsystem is a kind of staircase that allows you to climb higher and higher.

And if the System (here **"SvetL"**) already bears in itself experience and communication with the Control Systems of a much higher level and at the same time this System (it is the **Psi-Generator "SvetL"**) is built into the Earth Control System, then, we get confirmation, that **"SvetL"** acts in line with the RCS Development Programs. And after realizing it I came to the conclusion that as a result of this, the Earth Control System has "something" so far "hidden" from our perception and far exceeding this System by the development potential; and this **"something"** is possible to bear in itself the experience of incommensurably greater something.

This "something", like a Trojan horse, but not in a negative but a clearly positive sense can reveal itself as an activating Program at the moment necessary for the ECS. And then the paradoxical (at first glance) conclusion arises that, at a certain stage, the ECS itself can become, if permissible to say so, the **"user" of the "SvetL" Programs**, in its turn, laying in itself a truly infinite potential that will be "transferred" to the user, if, of course, by this time his Brain has been prepared. I would like to emphasize that only thanks to studying the works of **N. Levashov, A. Khatybov** and others it became possible to understand and apply everything that **N. Levashov** created, who looked far ahead and, in fact, this was one of his main tasks on Midgard-Earth, which (like others) had been completed.

Therefore, when I knew that a group of "comrades" from the former (collapsed) Movement of the RPM of the RGA under the leadership of its

permanent mastermind N.Ya. Anshukova created on the basis of N.Levashov's knowledge (not having their own) a certain "Health Improving Complex", stealing the very idea, the computer program, and the user's manual – I did not find it funny. To their accomplices, of course, they told, that everything had been done with N. Levashov's "approval" and they were in touch with him (probably in the Government's), almost every night. Why at night is also unclear. I wrote an exhaustive article on this subject, which can be read on the ["RSTS" site](#). But I would like to say something else. This is a specific example of the automoto style actions of those people who have already had their Brains "removed". There can be no other explanation. I'm sure that people who come across this "invention" will understand everything and will figure it out themselves. Today it is a must to help talents. The talentless will break through on their own. So it was, but it should not be and shall not be.

I know – what is written above- is far exceeding science fiction. The consciousness of many people just refuses to understand this for the same reason as the Consciousness of the Papuans refuses to seriously think about flying "iron birds": ***this can not be because it cannot be ever.*** Today's form of my knowledge is not morphology, for which I am sincerely grateful to **N. Levashov** as a forerunner of everything. This is the form that was obtained from the memory archive. And it is additionally formed in the course of cognition through the already mentioned works in the process of the current development of the Control System itself, or rather, the substance of its Reason state. That's why the "understanding" of everything connected with the "creation" of the **"SvetL" Programs**, their installation and correction, "came"; and also other possibilities that were tested and experienced in specific moments and confirmed their justifiability. Errors are technologically excluded today.

Chapter 7. Variations in Reflections

To reach the goal, first of all, you have to go.

Today we are all participants of the "parade of changes". "The Parade of Changes" is fast developing before our eyes. Whether we see it or not, – depends on many things, on having read of what is narrated here, for example. Here, you can conduct the orchestra, or you can clean up the garbage behind the "holiday" participants. You make this choice yourself.

* * *

In the pregnant woman's abdomen two **BABIES**: a **BELIEVER** and **UNBELIEVER** are talking.

Unbeliever: Do you believe in life after birth?

Believer: Yes, life after birth exists. Here we are preparing for it.

Unbeliever: Ignorance! There is no life after birth!

Believer: There is. In that world there is light.

Unbeliever: What is light?

Believer: I do not know. But the reality is perceived differently under light.

Unbeliever: You are talking about things you do not know.

Believer: No, I do not know this. But I believe we will move there in space, eat with our mouths and do many things that are difficult to imagine now

Unbeliever: Nonsense! It is impossible to move around in space. How can you eat with your mouth?!

Believer: I believe that after our birth another life awaits us.

Unbeliever: From there no one has ever returned! Life ends with the birth. And in general, life is one great suffering in the dark.

Believer: No, after the birth, we will see Mom, and she will take care of us.

Unbeliever: Mom? Do you believe in Mom? And where is she located?

Believer: She is everywhere, we are in her, and thanks to her we live.

Unbeliever: Obscurantism! I do not see any mom! Hence, there is no it.

Believer: I do not see it either, but I feel her singing and caressing our world. *I firmly believe that real life will begin after the birth.*



I recommend you to come back to this little story after a while, when emotions come down. If the above-read seems nonsense to you, call it nonsense and live your life, so to say, in the "automoto" way. And you do not have to line up to *take the Bath*. This is also great. At least – everything is clear and explainable.

7.1. The Base of Consciousness

There is such a notion – the base of Consciousness. We formulate our thoughts, representing the world, and reproduce them in words. **18000 years ago** there was a single language on the Planet. But the Ebrs violated this unity. Now, according to the laws of dialectics, if there is at least something in it to rely on, – all existing languages Nature must reduce to the common denominator. Such a denominator, the key to the base of Consciousness, the Russian language is chosen. The entire information component, translated through the New (Native) Programs, is **PRODUCED ONLY IN THE RUSSIAN LANGUAGE** (previously the entire translation was only in English). That's why Russian was chosen as the world language in communication (in the broadest sense of the word). Why Russian? Because, in the past time, there were no other languages. **THERE WAS A SINGLE LANGUAGE**. It was a slightly different language than the one which we speak and write today, but we are obliged to return to that, our Native language. This is an answer to all those who believe that when reading the materials of the **SRI CPS** and in particular by **B. Makov** (and to some extent by N. Levashov and A. Khatybov) there is no understanding of individual words and phrases. They seem somehow fanciful and unnecessary. But it's time to start getting used to it, start learning to understand and use them. Otherwise, there is information

distortion that the Brain perceives, rejecting what it does not understand. **N. Levashov**, while creating his works, tried to explain the most serious things of the universe most intelligibly. And he succeeded more than anyone else.

I noticed that the Users of the "**SvetL**" **Programs**, when reading the materials, **DO NOT FEEL ANY DISCOMFORT** in the perception of seemingly "unfamiliar" words. There are many who just refuse when communicating with people to use the words "imposed" on us with certain aims. And there are more than enough words of this kind today. I often hear people use **BLAGODARU** (I am grateful to you) instead of **SPASIBO(G)** – (Save God) – THANKS. And there are many examples of this kind. Since almost all languages of the world, to some extent, are a "product" of the Russian (Native) language, then, considering its initial flexibility, any other group of foreign languages will fit into its system.

The Russian language is the richest language in the world, it contains five million words. For example, in the English language, there are 180000-200000 words, whereas in Russian 200000 only basic words and about 1 million words of the active vocabulary.

A well-known Indian scholar, professor of Sanskrit **Durga Prasad Shastri** at a scientific conference in 1964 in India noted that *the Russian language and Sanskrit are the two languages in the world that are most similar to one another*. "It's surprising, as he notes, that *in our two languages word structure, style, and syntax are so much similar*. There is even more similarity in grammar rules – all this triggers off, in his words, a deep curiosity among those who are familiar with linguistics".

Russian	Sanskrit	Russian	Sanskrit
mater	matr	brat	bhratar
pramater	pramatr	bratstvo	bhratrva
syn	sunu, suna	dever	devar
snoha	snushu	zayt	jata jati
svoyak	svaka	svoistvo	svatva
tata, tyatya	tata	zhena	jani

Let's take into account the opinion of well-known linguist-sanskritologists who are engaged in comparative typology of languages, and who are convinced that only one language – Sanskrit – can be the only proto-language that gave rise to other European languages. Moreover, the conclusion suggests – **Sanskrit is purely Russian**. If you want to hear how the original Sanskrit sounds, go to the north of our country and you will hear and make sure that the northern Pomorski dialect is that very Sanskrit.

As a result of his research, Professor V.A. Chudinov came to the conclusion that the Slavic literary texts and, above all, the Russian alphabet, has been existing, at least, several tens of thousands of years. "It's quite obvious now," says Valery Chudinov. *"Our ancestors for millennia had the traditions of script rather thoughtful and perfect in its own way-and this was when most European nations could neither write nor read."*⁴⁸

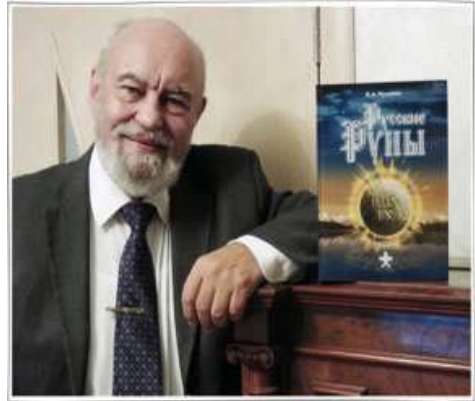

V. Chudinov

A researcher of the Old Russian alphabet and a follower of the 18th century scholar-Slavist Thaddeus Volansky, P.P. Oreshkin was busy deciphering ancient written monuments. As a result of his research, he came to the conclusion that the oldest documents had been written by means of various alphabetic systems, but in one language, and this is the key to their decipherment. "THE SIGNS are MISCELLANEOUS, THE LANGUAGE is SINGLE," said Peter Oreshkin.⁴⁹ And a simple, clear conclusion, which can not be doubted: since the native speakers of the Russian language are Rusy, the revival of Humanity will begin (has already begun) in Russia in the widest sense of the word. And we should discard all the thoughts about the extinction of Mankind, which is now literally everyone is screaming. Mankind shall not die out. The question is in a different thing. How many Humans we (and they) will be able to save? I am not writing about the whole of the world, but I am sure that the Rusy, who have not lost their energetic and ancestral origin, shall not only survive, but succeed in their development through their eagerness for taking the **Bath**.

7.2. Everything is solvable...

Despite the present "disastrous situation", which we are constantly told about, we should not look back, into the void. I mean the West, where the

⁴⁸ V. A. CHUDINOV The Russian language is millions of years old

⁴⁹ Oreshkin P.P. The Babylonian phenomenon. The Russian language from the depths of centuries

process of destroying life has already begun, as such. First of all, the death of people from various, previously unknown, diseases that we "are brought" as "cow's hydrophobia", "pig" and other influenza, and all sorts of viruses with names that can "twist off the tongue" when pronouncing them. All this is associated with only one – with Consciousness destruction and the Brain degradation.

If talking about diseases today in general, they do not exist on their own. Each of them only "reflects" in the physical body, but mainly – in the Brain, – this or that degree of destruction of Human Consciousness at higher levels in accordance with the genotype of the Brain. **The Programs "SvetL"** in the most active way, which I have been convinced in for years of their use by people, successfully resist this, regardless of the Brain genotype. With the use of the Programs, everything is being realized in a different way. We have already considered these points partially and will continue to examine them somewhat later. And this is not mysticism. Mysticism is necessary for those who benefit from concealing the truth. For the years of my "getting together" with N. Levashov, comprehending his works and A. Khatybov's, as well as my own research, calculations and search for irrefutable evidence of the **"SvetL" Programs** effectiveness it became possible to put together the Knowledge into a rigid system, relying not on the physical laws of modern science, but exclusively on the physics of Cell, Brain and Energies. I do realize that this is only a small fraction, but it has already given a significant practical result.

Everyone knows the **Bermuda Triangle**, the Devil's Sea and other anomalous zones, which are the centers of the pentagons or the dodecahedron pentagon.⁵⁰ However, many believe the Bermuda Triangle is a mystical place.

But the center of a pentagon is at the same time the top of an icosahedron, where there is also no mysticism – it is the physics of physical and mathematical bodies built in line with the principles of the Golden Section. There are totally different conditions there and other states. The musical series are subordinated to the principle of the Golden Section, the Man is built up according to this principal. And does this affect us? Let us take a simple everyday example, about which everyone knows, but very few people understand – why it was done this way?

⁵⁰ Pentagon – regular pentagon (five-angled)



The Bermuda Triangle

Our ancestors were clever people and built **ceilings 3.5 meters high** (in the so-called Stalinist blocks-of flats, the ceilings are at least 3.5 meters high). **The official sazhen is $217.6 \times 1.618 = 3.52$** . A modern one **2.7 meters** high and less "cuts" the room, translates its influence on our average height, as a result, it does not matter whether we are sitting or standing – we are still "cut" by the plate that is above our heads. All this was done only to ensure that the **BRAIN IN SUCH ROOMS WOULD NOT HAVE ANY TENDENCY FOR DEVELOPMENT**, and the Man, living under such conditions would become easily governable. This is only one and of minor important examples out of a great number ones of how for more than 2000 years we had been turned into an obedient herd. We all know the result.

Nature, in the broadest sense (do not forget about the CS), triggers us non-stop, dictating ever new conditions of life. It requires that we should correspond them. There is a rigidly rational law: ***if you do not correspond – die out!*** This is what is taking place today. Hence, **THE BASIC TASK OF MAN NOW: to be able to adapt (and do not get shy of this concept), create in oneself the missing energy structures at all levels of existence of the Brain (the Spirit), and if to put it easier, then "to get the developed level"**. Here everything will depend on an individual. And I believe that this task is completely solvable for those who is longing for knowledge. What kind of help can the **"SvetL" Program** give here in addition to the User's health improving? They "help" people to master the methods that "psychics have" (although there are

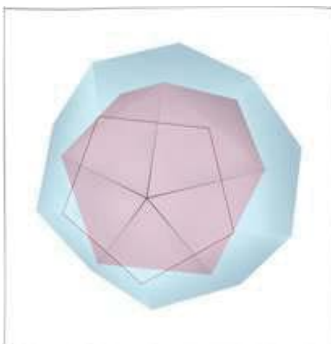

very few left due to the changes in the life support system of Man), but in another evolutionary principle. It is the question of the so-called **opening of the Brain and the expansion of its potentials** (true, within the reasonable limits). How is this implemented by **the SvetL Programs**? Practically the same way as it was described by N. Levashov. It can not be otherwise, because the physical Brain (what science calls "the gray matter") is only the foundation that provides the process of thinking. Neurons of the physical Brain do not think, they only split the substance of the physical level into the matter that forms it, and this, in turn, creates the necessary potential and provision of the remaining levels of neurons. The ethereal, astral and mental bodies of neurons at their respective levels form their systems – the ethereal, astral and mental levels of the Brain, which are just as material as the physical ones. The process of thinking arises precisely at these levels as a consequence of the circulation of different *flows of energy (matter) among them. And here, in the process of thinking, there are many different flows of matter, both in composition and in activity, which can capture a different number of the Brain levels. THIS IS THE PHYSICS OF THE PROCESS*, but in the everyday sense, we are used to believe that the main function of the Brain is thinking. We often heard that "we need brains to think." Besides, lately it has become the idea that the reality we are observing is the product of our Brain and depends on our thinking. Is it really so? Man is not the only being possessing a developed Brain. And the main Brain function is to create an objective picture of reality and physical sensations based on the signals from various organs of the body that enter the Brain. And everything we see, hear, feel, and touch is, as we think, the most complete and objective information that our Brain can only get. This model of reality is formed automatically, still at the level of sensations and feelings, i.e. before we thought about something and incorporated the logic, before we even learned to speak. Thus, the model of the world that we know is the result of our Brain's work which tries to make this model as objective as possible, although in most cases it does not work out. And it does not work out because of the implementation and embodiment of the programs related to the development of the Brain genotypes, as we already know.

Logical thinking is a later superstructure that has developed in evolutionary species for decision making and activity planning. It does not

participate in creating the world picture. Moreover, it is limited to the picture that the Brain has created, by the sensations that are available to us.

Logic is needed solely to solve practical tasks and make the right decisions. It was not created to "comprehend the objective reality." And when a Man tries to apply logic inappropriately and with its help create "an objective picture of the world" disregarding the information that is prompted by his feelings, he begins to make up all sorts of strange theories like dark matter or the afterlife. All this brings to the substitution of reality with its theoretical models and makes the behavior inadequate, overly complex and unpredictable. This is a sign of unhealthy thinking that arises as a result of the loss of Man's connection with reality. It is dangerous and fraught with mental disorders, various hallucinations and other moments that can be observed in the behavior of many people today, and especially the so-called "ruling elite".

If you use logic according to its purpose – to solve life problems, plan your activities, improve your living conditions, create mutually beneficial relationships, then it really helps you to objectively change the world, make it better, more comfortable, more sensible, which, in turn, expands your possibilities and promotes the development of your Brain. Then there comes a stable interrelationship in development.

Now I am going to tell you what should become the basic thing in your understanding of this process, especially if you ***are going to the Bath, and you have already been put in line***. If Man (or, a reasonable being, as N. Levashov used to say) is unable to change the physical volume of his Brain (the volume of gray matter), ***then what prevents him from changing the size of the Brain qualitative structures at other levels?*** This opens the door to infinite development. "SvetL" Programs in this process is great help, but they will not replace your thinking process and, especially, the process of cognition. And you will only have to Cognize and then Know how it is done and then not to break harmony at any possible level. It's very simple, is not it?

Now about the Brain transformation. Well, it is N. Levashov's "system", he created it, because he knew certain laws of Nature (the physics of the processes) and what and how to do. In my time, I understood this physics of the processes on my own, thanks to studying N. Levashov's works and A. Khatybov's calculations but "**...what and how to do it...**" – Nikolai told me just a few months before he's "gone". He let me understand, taught me (and I had something like examinations) how to create those qualities that Man does not have. This is not "unblocking" the Brain of a Person who is in a "sleeping

state", which was imposed upon him by the Ebr Control System. Some people believed that Levashov just "unblocked" the brain of one or another person being in a sleeping state. No, it's not. He created in this or that Man those qualities, **WHICH THE MAN HAD NEVER HAD BEFORE** and could have got them potentially only with the proper development. All this I tried to "invest" in the **"SvetL" Programs**, which are "put" in the Generators of Complexes. When the setting of the Generators was handled by Nikolai, he did not install such programs, focusing only on health improving. And it was expedient that time. It was necessary to start and "see", **HOW ALL THIS WILL START WORKING**. I have mentioned it many times. I just did not talk about the **"Development" Programs**, which include *the Brain Transformation Program (openinig)*, because I believed the time did not come then, and that Man's development was not something guaranteed, it is only **POSSIBLE AND DIRECTLY DEPENDS ON MAN'S STRIVING FOR COGNITION**. Moreover, the question of the **"Bath", "Broom" and "Spade of Cognition"** had not been touched yet. I felt responsible for my action. In the transformation there is not only a qualitative change in the Man's Brain (The Spirit), but also the creating of those bodies that Man had never had. The first application of the *Brain Transformation Program* was implemented in the early **2013**, when the processes of changing the life support system went more intensively. But it soon became clear that this program dramatically affected the platform of the Generator and damaged the Complex Electronics much faster than one would expect.



"SvetL" Complex (the second generation)

It was necessary to reduce the "power" (if I can say so) of the **Program itself**, which, naturally, affected the time factors of the Users' Brain Development. All

that related to the Users health recovery, was not affected and only improved by an order of magnitude. This was the beginning of reflection on the creation of a fundamentally new carrier for the Generator, the possibility of full-scale application of all Programs on it and the prospects of their "addition" to the Generator, as well as the solutions of other identified "shortcomings" in the operation of the **First Generation Complexes**. This task was solved and a new **Complex "SvetL"** came into being.

Now I am sure that after a qualitative transformation of the Brain, practically of any Man, it becomes attainable what is regarded as the highest achievement in the Oriental studies. But do we need this kind of achievements? Personally, I, just like Nikolai Levashov, want a man, **BECOMING RATHER HIGHLY DEVELOPED INTELLECTUALLY** to be able just only by his presence to change the state of the people around, Nature, correct genetic processes and much more. I just add that such a mechanism can (will) operate reliably exclusively on a conscious level only. This is a difficult way, but the movement in this direction has already begun. An experiment called "**SvetL-**



Flora", which is involving many participants, is the forerunner of the development of Intellect and "primary skills" in the cognition and mastery of these potentials even after the "partial" transformation of the Brain of the owners of the **SvetL Complexes**. The ultimate goal of this stage of Human development is the mastering of their interaction with plants (at the first stage) exactly as N. Levashov did, as it is written in his work – "**The Source of Life, 1-10**".

I have no doubt that this is the right way in one's development. This is a real indicator of the implementation of the theory into practice. I want to note that the participants of this experiment today are already doing a lot. When I was writing these lines, **Denis Vasiliev** sent me pictures of his result of the successful application of his abilities to "control" "**SvetL-Flora**" **Generator** (October-November 2015, air temperature -5, -8°C, Ulyanovsk Region, Kasunski District, Prislonikha Village). Do not you think it reminds us of Levashov's experiments in France?

I will not detail here how and why this experiment with plants began (practically all over Russia and in some foreign countries,too), because I want to write a separate book (the working title "The Source of Life – Life goes on") in which I will tell you in detail, relying on the real materials of this project, that became possible thanks to N.Levashov's experiments made in his Castle in France. This will be a worthy continuation of what Nikolai Levashov started, transforming Flora. And the book will be written by the people whose development allowed them to translate their own resources into reality. I think that another year or two – will be enough for convincing visible results already received by many participants. I will not fail to recall you that ***the Generator, which had been located under the Castle in France, was "transferred" to Russia FOR THIS KIND OF PHENOMENON***, as well. And whatever someone said or wrote that "someone turned off the Generator" after Levashov's death, you should know, this is written and said by THOSE who, above all, want to stop spreading and mostly using N. Levashov's Technologies. And pulling out quotes from N. Levashov's books (without understanding the depths of them) these people are persistently advising us to defeat our local evil – the earthly one, which fusses around everywhere and prevents us from living happily ever after. But they do not refer themselves to this category of fussing evil, because they "take an example from Nikolai Levashov" and "take advantage of the knowledge that he left for them". One can use only one's own knowledge. And if one does not have one's own knowledge, then it will not help one,if someone has left something for one.

7.3. For those who are eager to take the Bath

Here I am giving you some points that I had to face when creating the "**SvetL**" Programs. They, in my opinion, are important in comprehending a Man's physical body (his "shirt") and understanding what happens when the Brain interacts with the Programs. This is useful for those who want to "stay" on this planet longer than the others and is going to take **the Bath**. The information is given in order of importance and necessity of gaining. However, if you have not mastered **point 1** (or you do not understand, or doubt it), there is no point in switching to point 2 – you will not be taken to **the Bath**, and will not be given the chance to stay longer on the Planet.

1. The human Brain, through its control of the body, is able to synthesize and eliminate everything. This means that, no matter what you deprive it of, sooner or later, it will be able to make out of the available

substances (even water and air) everything that is missing – it is only the matter of time. True, if the time is available. Regardless of what you give your body in excess (potent poisons and lethal doses are not considered, since you have to be able to split them very quickly, and only the Brain is able to do it, if it has mastered it), the Brain will sooner or later learn to resist this by producing neutralizers in the body.

2. The moment when the brain "teaches" the body to do this, will become for you the moment of the truth – from now on you are going to be the slaves of the tough dependence (on "habits", medicines, food, etc.). Henceforth, every small dose of what should not be in the body will result in an aggressive electrochemical rebuff on the part of the Brain and will be the source of a great number of different sufferings, troubles, symptoms and illnesses. It is this fact that underlies all the dependencies: tobacco, alcohol, drug, coffee, narcotic, game, etc. To neutralize the defense created by the Brain through the body and, thus, remove the whole complex of related painful symptoms, one has to bring in even more substrate, against which this defense is created in the hope of breaking it, which, in turn, will lead to even greater reinforcement and diversification of defense – the vicious circle closes, thickens and hardens. I am stressing once again: any dependence is based on the acquired and developed ability of the body to protect itself from the presence/absence of a substance **on a scale many times greater** than the actual need. But do not forget – when we talk about the body and its reactions, it is necessary to clearly understand that all this is the Brain reaction, which controls, and gives orders to all and everything. And they are carried out by the body. That is why, when the Brain gains such an ability, the matter is already not in doses (such as "well, I'm just a little bit and that's it"). The matter is in reacting to even one molecule. As an everyday occurrence, this means, for example: do not try to deceive the Brain (the body) with diets – it will take its own all the same. This means that the "coded" alcoholic can be ruined even with yogurt, and only one puff can destroy a year's abstinence from smoking in a moment. **Alas, – the ability has already been gained, and there is no turning back.** Just like forgetting how to ride a bicycle or swim.

3. The situation with so-called "treatment" is completely analogous. If the body (the Brain) has previously come across the prescribed drug (or one of its components), the therapeutic effect of the standard dose will be weak, it will not be at all or there will be continuous "side effects". In fact, most (if not all) side effects owe their existence to building "chemical" protection against the injected substance. Absence or minimal severity of side

effects when taking medication is due to the **EXCLUSIVELY UNREADINESS OF THE PROTECTION SYSTEM** to invasion of substances of this kind. Give the Brain (body) more time, do not stop stuffing it with poison – the result in the form of persistent dependence or resistance will unfold before you in all its glory. Dependence is the need to increase the dose to get the initial effect due to the fact that the Brain has learned to neutralize the initial one (the lesser one). And resistance is a condition in which the Brain operatively neutralizes the given dose, and it does not work because the organism does not have it in its initial form.

4. In fact, all diseases are determined by violations in the information transmission system, which in the Human body is carried out by cytokines.⁵¹

They regulate intercellular, interorganic and systemic interactions, determining cell survival, stimulation or suppression of their growth, differentiation, functional activity, also ensure ***the coordination*** of the actions of the immune, nervous and endocrine systems (in this order exactly) in normal conditions and in response to external negative effects. The modern medicine considers it this way. In the very transmission of information, first of all, the Brain is involved, which takes information from the outside and "spreads" it everywhere on the cellular and intercellular levels, using the whole human skeleton as the system of undistorted information transmission. All the rest is secondary. Against the backdrop of the ongoing changes in the Life Support System of Man, all these processes have an intensive nature and informationally are aimed, first of all, at "bringing" the body (the shirt of a Man) to the "proper" state. Naturally, this happens only through the Brain, as the main performer in this process. But both the Brain, and the human organism, in most cases, do not cope with this information load. This is the reason of today's sharp exasperation of various diseases of people virtually of all ages, with the exception of children born in the period since 2013. One of the main tasks of the **"SvetL" Programs** – interacting with the Brain, to damp this load, directing the activity of the Brain to a specific direction, depending on the ailments of the body, for its healing and in parallel developing the Brain's resources. This allows us to achieve such effectiveness in the use of the Complexes that we have today, especially with respect to the Second Generation Complexes. To put it easier, taking into account that the Human

⁵¹ Cytokines are small information molecules. Cytokines have a molecular mass not exceeding 30 kD. The cytokine is released to the surface of cell A and interacts with the receptor of adjacent cell B. Thus, from cell A to cell B, a signal is transmitted that triggers further reactions in cell B.

Brain can do anything (**see point 1**), it will do everything – you just need to prompt it with the help of **Programs** and they will press the right "buttons" at the right time.

5. Loss, damage, change of any organ or part of the body (even a tooth) **BRING TO DISORDERS IN THE OPERATION OF THE WHOLE SYSTEM** of intercellular interaction under the Brain control. It is possible to get a serious or even incurable disease not only as a result of an accident, injury, poisoning (food, drugs, etc.), extreme external influences (burn, frostbite, beating, trauma) and abuse (tobacco, alcohol, drugs, medicines, etc.), but also as a result of a simple and widespread *operation*, which has already become familiar and common in our understanding (for example, removal of glands, moles, teeth, appendix, gallbladder, etc.), or a *psychic* state of a certain type (despair, anguish, fear, etc.). Any change in either physical, or emotional state (under the influence of the environment) *always*, and moreover, today, is attended by the processes ongoing in the most active way, accompanied by changes in the system of intercellular signaling. But if there is no change in the body and it develops without interference from the external environment, only under the influence of information energy flows taken by the Brain, which is able to respond correctly to the information received, then, regardless of microbes, infections and other "swine flus" , then there is no any disease. This is now extremely rare and, mainly, with the children born **since 2013**.

In November 2014, we discussed this subject with **B. Makov** in my favorite hotel "**Arbat**" in Smolenskaya Square in Moscow. He told me then – "...here, you have today some **3-5 thousand** people under the **Programs "SvetL"** all over Russia. This is catastrophically few! There should **be 3-5 million, at least ...** But this ought to be only their choice, and not somenon's... " Time proves he was right then.

6. All diseases (from cold to cancer) **ARE CAUSED ONLY BY THE INFORMATION** that is "technically" realized through the Brain. The most striking examples are:

- a) death after blood transfusion that is incompatible with the group;
- b) death from a gunshot wound, in which there is neither damage to vital organs, nor heavy bleeding;
- c) death after notification of the death of a loved one.

In all these cases (as, indeed, in all others), the Brain plays the leading role in the death (more precisely, self-destruction of the Spirit), giving through the central nervous system the appropriate order. By the way, many oncological diseases also end in self-liquidation, because the Brain "understands" the impossibility of restoring damaged tissues and gives the appropriate order. But everything here depends on the development of the Brain, and on the genotype, and on the information flows changing the Life Support system of Man. Recently, one can observe a vivid manifestation of these processes among those who imagined and go on imagining



in auto-moto style to be the "rulers of Human destinies", naturally, being representatives of the **4XX** genotype of the Brain. The sharp increase in cancer deceases (carefully concealed by these individuals) is an objective process of non-violent decision of the matter regarding those who can not have a direct connection with the revived Control System. Against this background, they suddenly begin to "come up with ideas" that reveal the desperation of drowning people catching at a straw, people who have not fulfilled their functions as statesmen, who felt close failure and switched over to boyish fantasies. We can see this more clearly now. And no clinics (the best in the world) will help here for any money. So their ancient secret symbolism (4XX genotype of the Brain) **"The snake biting its tail for its own destruction"** – is being realized and only by them and against them. All this is influenced by **psychological** factors directly related to the Control System, which contribute to and cause in these people the transition of cancer from one ("slight") stage to another (more severe). Therefore, there is a "hope" in healing with the help of "advanced" technologies. But these hopes are false. It is through the Brain that the executive vertical "hypothalamus-pituitary-adrenal glands", i.e. the connection between mental states and adrenal glands, on the one hand, and between the adrenal glands and the lymphatic system, on the other, explains the fact that **among all cancer states (unfortunately, not only in these individuals) it is precisely with lymphomas⁵² that a psychologically unresolved**

⁵² Lymphoma is a group of hematologic diseases of lymphatic tissue, characterized by an increase in lymph nodes and / or damage to various internal organs, in which uncontrolled accumulation of "tumor" lymphocytes occurs. The first symptoms of lymphoma are an increase in the size of the lymphoid nodes of different groups (cervical, axillary, or inguinal).

problem can be clearly traced. Loss of communication (after the change of the Ebr CS for the native CS) of these people with the Control System caused psychological changes which influenced these representatives of the genotype **4XX** long before the onset of clinically pronounced disease. In this case, relapses of the disease or periods of deterioration of the general state are always closely related to events affecting the psychological state of patients. And such events take place almost every day. But the main thing is not this. The main thing is that in connection with the termination of the reincarnation program, none of them has a prospect of integrating into the future. Can the "**SvetL**" **Program** play any positive role in this case? They can.

Neither I nor my team, which is engaged in the "distribution" of the **Programs**, has any right to refuse anyone to become a Participant of the "**SvetL**" **Programs**. None of us can be a judge here. Everyone should have a chance. I am telling you this, readers, and the same in his time, **N. Levashov** said, when I asked him the question: "how to determine who can be the participant, and who cannot ..?" Many of those who called themselves "Elite" of our society and inadequate actions of whom are visible with "unaided eyes", know about the **Programs, the Generator and the Complexes**. They read everything that is published on our resources and resources of **the SRI CPS**. Some of them crossed the "line of distrust" to the Programs and became their participants, having already received a serious "relief" in their problems related to health and development. After a while, many of them will want to become participants out of despair in which they will find themselves. I am writing this because I know. However, everything connected with the application of the Programs for this "category of people" today can not be public. I said what I think is necessary on this subject and close the written with dots up to a certain time, the same way as **N. Levashov** used to do. The only thing I can say quite openly – **THEY ARE SURE NOT TO BE TAKEN TO THE BATH.**

.....

7.4. Saturation for the achievement

Once again I would like to emphasize what I am writing all this for. The main task **at the first stage** is to saturate the informational space with New Knowledge of Human Social structur on this Earth, which is laid down in the works of N. Levashov, A. Khatybov, N. Morozov and others. ***Under the word "others" I understand, not many scientists, unfortunately, whose***

information somehow clarifies and explains the processes that "modern" science either is not able to explain, or deliberately hides or distorts it for the sake of its conjuncture plans. And even if , voluntary or not I hurt the feelings of some of them by the fact that I used their open information for an intelligible explanation of what people should know today, without their permission, and caused somebody's dissatisfaction, I am sure that this is all secondary. Is it important in this situation, copyrights, rights of ownership of the written – if this written is not intended for the author's gain, but for people? I believe that in such cases – **PRIMARY IS THE INFORMATION AND POSSIBILITY TO BRING TO MANY PEOPLE THE THOUGHTS** of this or that author on many subjects of people's concern. It is necessary to try to convey to the **MAJORITY OF PEOPLE** the fundamentals of the **NEW KNOWLEDGE** laid down in their writings and to show the practical use of the **New Technologies**, not only the technologies of N. Levashov, but also others already created and applied, after using these New Knowledge. Such information already "walks" among people. But these people are still very few in comparison with those who derive the criterion of understanding from TV and the Internet or from nowhere at all. The increase in the number of people who are striving for New Knowledge, and especially through the use of New Technologies, in particular, the **"SvetL" Technologies**, creates some intellectual activity around these people. This intensifies the discussion of all issues that care many of us (there are those who generally do not care about anything). When the discussion reaches the critical mass, when the information permeates the society to the farthest backstreets, then the irreversible consequences that N. Levashov wrote and said about will take place. **SATURATION WITH NEW INFORMATION**, in the truest sense of the word, **WILL CHANGE THE STRUCTURE and COMPOSITION OF THE SOCIETY**. There will be a new society that will seek the appropriate form in applying its Knowledge of the surrounding World and putting the Knowledge in practice (in real life). Is this not an fine example of the use and application of worthy information, maybe with some infringement of the authors' ambitions? The saturation indicator is the filling of various information carriers, which include not only the central media and thick smart journals, but also **fences and walls**. I do not mean today's information sites of the **Clubs of New Knowledge. named after N. Levashov**. It was for this purpose that the clubs were created. All this is necessary in order to get closer to one of the deepest secrets for the Man today (in the so-called Transition period) – the awareness of the very fact of the ongoing physical process, in which the **HARMONY OF THE INTERNAL**

STATES OF THE FUNCTIONING BRAIN and the external states of its control are being formed most actively. This emerging harmony is important precisely for the acceptance (and correct understanding) of the present New information, which directly affects the changes that are taking place. And it is possible to realize the required **ONLY THROUGH THE SATURATION WITH THE INFORMATION OF THE WHOLE LIFE-SPACE** of the Man's **VITAL ACTIVITY**, including the use of the **"SvetL" Programs**. It may seem, at first glance, that it is an infinite field of getting information, and it might not be realized in a short time, taking into account the depth of that inculcated lie, which through the interventionists interference "had been imposed" everywhere a stable illusion of the truth of all that surrounds us. But without knowing this, everything else loses all meaning in the possibility of the changes that are taking place and, especially, in the change of the Man himself and his "getting" the Reason through cognition. But, as **B.Makov** likes to say, the very process of getting information (by any way, even by mere familiarization) is not yet knowledge. The completed knowledge is **SEARCHING AND FINDING OF EVIDENCE OF THIS KNOWLEDGE!** You can not but agree with this. However information might be different. Every day I get more and more letters, in which people are complaining about problems with their Brain activity – ever increasing absent-mindedness (ie, inability to concentrate their attention, to gather their thoughts for solving some problems), difficulty in remembering information, their inability of reading voluminous texts, not to mention books. And they ask to give them Complexes to become participants of the **"SvetL" Programs, as they believe**, to improve their Brain Activity, in general, and Memory, in particular. And, paradoxically, this problem is characteristic not only and not so much for the elderly, who are supposed to have "weakened Brains", "because of the age", as for people of middle and younger age. Moreover, there are many who are not even interested in why this happens to them – they automatically attribute it to some stress, fatigue, unhealthy ecology, age, etc., although all this is not even close to the cause. Among my acquaintances and people connected with scientific activity, there are those who are **far from 70**, but they have no problems at all either with their memory or Brain activity. So what is the reason? And the reason, as usual, is ignorance and unwillingness to understand and, above all, in spite of any arguments, no one categorically wants to agree –

in the so-called *permanent, round-the-clock "connectivity" to information*".⁵³



Favorite gadgets

In other words, the accelerated loss of your Brain functions began on the very day when you decided that you just had to be constantly “on-line”. And there is no

difference – whether you have been forced to do this by an official necessity, exhaustion from idleness or an elementary fear of being “not at the level”, i.e. fear of being known as a black sheep, an eccentric in the midst of your own kind. Back **in 2008**, it was known that the average Internet user reads no more than **20%** of the text placed on the page, and avoids large paragraphs in every possible way! Moreover, my observations and those studies that I could find on this subject show that a person who is constantly connected to the network does not read the text but scans like a robot – snatches scattered pieces of data from everywhere, constantly jumps from one place to another, and the information is evaluated solely from the position: “Is it possible to send this to anyone?” – but not for the purpose of discussing, but mainly for the purpose of causing emotions in the form of an animated eructation accompanied by short “monkey screams” in the SMS format. I am writing this not to offend anyone, but just stating the facts. With such an approach, unfortunately, I had to face and repeatedly explain to many Club participants which have been created to ensure the dissemination and filling of space with information. However, the persistence in reluctance to accept these arguments, amazed me, frankly speaking. Here are the studies that were

⁵³ A.N. Stackevich, Degradation of the brain, "Academy of Trinitarianism", M., El No. 77-6567, pub. 21867, 03/07/2016

conducted recently by a sufficiently competent institution engaged in this subject.

Red marked areas where the reader's attention is kept the longest. Yellow – a zone of cursory viewing. Blue and gray areas are not read at all.



In the course of the research, it turned out that the pages on the Internet, as already mentioned, were not read, but scanned cursory through a pattern reminiscent of the Latin letter **F**, i.e. at first the user reads the first few lines of the text of the page (sometimes even completely, from beginning to end), then jumps to the middle of the page, where he reads a few more lines (usually only partially, without reading the lines to the end), and then quickly descends to the very bottom of the page – to see "what's the end".

That was the conclusion, and you cannot but agree with it today – the most effective way of giving information to an ordinary Internet user is to display information in the form of a pyramid turned upside down (that is, according to the principle "the lower, the less") with mandatory selection of keywords, so that the mass(I do not find another word, and it's still mild) could understand what is important and what is not very, and explaining of no more than one thought in the paragraph – the only way to keep attention on the page as long as possible. If, while going down the page, the density of information does not decrease, or even worse, it increases (for example, on the site of **"RSTS"**, out of which, according to the plan, the information is supposed to be "scooped out" and disseminated through the Clubs) , then only a few linger over such pages. Is it possible to overcome this? Yes, it is. But we have to start with the information disseminators themselves and it is desirable they should understand what is being disseminated. This is hard independent work, but it will reward handsomely. Do the **"SvetL" Programs** help in this? Yes, they do. But they help those who is looking for knowledge.

In general, the amount of information on the Internet is so great and, at the same time, it is so empty (I mean useless) that you cannot talk about it as having any use at all. I believe (and hardly anyone can object to this) that the Internet is, in general, an invention for fooling people and making of them – a mass of morons, if you will. And the notorious "**terrible comforts**" that result from this constant connection are utter nonsense. There is a steady opinion – there is everything on the Internet. No, there is nothing there. And if anything is valuable, it is either for money, or left in pieces and compiled in such a way so that after reading the information by unprepared people (mass) – they generally would not want to read more, but there would arise a desire, but not to understand the written, but just call a madhouse to "come for them." That's how it was prepared, distorted and "left" on the Internet (as you know – specially) the information on the works of **A. Khatybov**, for example. Not once when talking to **N. Levashov** we both agreed that the bulk of information on the Internet was just useless rubbish, presented as something absolutely necessary. My personal opinion is such: the Internet is a drug. And what is a drug? It is completely useless thing, without which anyone can live fine until one "tries" it. And when one "tries", the dependence becomes lifelong, as drug addiction, which is not treated. That's why I decided to publish on my websites on the Internet only the information that is able to develop and give people information on the subjects that are interesting today, using for this purpose various and worthy, in my opinion, and, naturally, under my responsibility, sources (works of specific authors). And where, who from and what I "borrowed" – this is secondary. Primarily is the information itself, if it can help or orient people at this hard time. Authorship is secondary. Borrowing information, or as it is commonly called – plagiarism is not as terrible as it seems. Without it, we would not have known half of the really reasonable thoughts. This helps the author to eventually understand the value of his work and the impact of the given information on the real things in people's lives. But the very concept of plagiarism and everything connected with it was "invented" to control the dissemination of information in the framework of the programs for the creation of specific genotypes of the Brain.

Approaching the subject with cool heads, it is not difficult to see that plagiarism has an orientation not so much to protect the author as to add ambitions to him. But in addition, plagiarism in the context of nurturing authorship makes it possible to manipulate readers – written by a reputable recognized author is read with great attention and is perceived as something originally true that one can not question. As a result, so that to control a large mass of reading people (and therefore, dangerous), it should be enough to

control the authors they respect. And for the success of this, the authors should be singled out and their authority in the masses should be maintained. An excellent assistant in this is human ambition. The author, warming them up, will strictly abide by his authorship, and readers, raising their ambitions, will justify their actions with these very authorial statements. In this situation everyone will catch – and the guardians of their copyright, and free thinkers, and "writers" of aphorisms / quotations – expressed in a certain context, thoughts will walk in isolation from them, the authors "accidentally" will be messed up and replaced by the "necessary" ones, people's intelligentsia will pick up and scatter in the couloirs, in the end, SOMETHING – a prepared throw-in, a new idea, a well put-together, but shallow saying or something else.

There is another side of the problem. What is the explanation for the necessity of strictly observing authorship and the punishability of plagiarism? The explanation is quite edible – do not steal someone else's, learn to think and adequately formulate your thoughts yourself. Such theft is dangerous only in the framework in which plagiarism and authorship are important and necessary for their own worth. If there are no such frameworks – there are no ambitions for which one can not do without an author's instruction, there are no thoughtless repetitions of someone's ideas or senseless dragging of texts. And one more thing, which for me is quite painful – when my (and not only mine, but also Nikolai's) texts and their fragments are used not for knowledge (in any form), but for increasing one's own importance in the readers' eyes allegedly with one's deep understanding of the ongoing processes or interpretation of N. Levashov's works.

In fact, a valuable thought or idea do not need authorship at all. We use the "quotes of great people", referring to their authority and wisdom, as if showing in their direction, well, here, he thinks so, what we can say about ordinary mortals. In such a quote, it is the author's name that is its basis, creating the foundation for the statement itself. But the real value should be in the thought, the expressed idea – it becomes an incentive, an impetus to the work of one's own Brain.

You can write a lot about this and reflect on both sides, but I consider my position on this issue to be grounded.

People of all ranks and specialties – from highly qualified university professors to servicemen for washing machines complain about the problem of information perception. I hear such complaints especially in the academic circles, i.e. from those who have to communicate daily with people (teach, give

lectures, take exams, etc.) – they report that the already low level of reading and perception skills of those with whom they have to work, year after year is falling lower and lower. But they, unfortunately, **DO NOT UNDERSTAND THE DEEP DEVELOPING PROCESSES**, and attribute everything to the "collapse" of education, the shortage of trained teachers and the lack of adequate funding. Of course, all these exist, as you know. Even weblog- posts with the size of more than three or four paragraphs seem to the majority too hard and tedious for perception, and therefore boring and not deserving even an elementary understanding. There is hardly a person who does not hear a popular network saying – *"too many letters – could not master"*, which is usually written in response to a suggestion to read something longer than a couple of dozen lines. It turns out to be a vicious circle – it makes no sense to write a lot, since almost no one will read it, and the reduction in the volume of transmitted thought brings to even greater feeble-mindedness not only readers, but also writers. As a result, we have what we have – mass sinking into torpor.

Even people with good (in the past) reading skills say that after a whole day of rushing about on the Internet and maneuvering among dozens and hundreds of e-mails, they are not able to start reading even a very interesting book, since reading only the first page turns into a real torture. Reading just "does not go," primarily because: **a)** it is impossible to make yourself stop scanning the text, searching for keywords in it, and **b)** the complex syntax inherent in most classical, highly rich in content or science-intensive works that is completely absent in the exchange of telegraph-like SMS-eructation. The same applies to the texts presented by **N. Levashov, A. Khatybov, myself, SRI of the CPS** and others. As a result, one sentence has to be re-read several times! The sincere people say so directly: I am disgusted by myself. But these are the ones who begin to understand. It is a pity that not all.

Thanks to the constant connection to the Internet, such human skills as the ability to return to the once-meaningful information, analyze the read and use the imagination, is deteriorating sharply. Even worse is the fact that in 80% of cases people "go" to the Internet for dubious entertainment, or get the information from there that has not only zero, but negative cultural value. At the same time, most people (especially young ones) are tied up to their gadgets so much that at the thought of being "disconnected" from the network for at least one day, they experience not only mental depression, bordering on panic, but also a real physical breakdown similar to narcotic. You do not believe me, do you? Well, try to turn off your computer and do not turn it on for two or three days.

Those who "invented the Internet" planned that the ability to effectively perceive complex texts, read complex literature afterwards, rather soon, will become an elitist privilege accessible only to a special caste of people (genotype **4xx**). This idea is not new, since even Umberto Eco in the novel "**The Name of the Rose**" suggested that only those who were able and ready to perceive complex Knowledge should be allowed into the library. And all the rest will be able to read only posters and Internet. If you sum up, you have to understand that no pills, no dietary supplements, no diets, no brain corrections, etc. can stop, in this case, the degradation of the Brain. Only one thing can stop it – the end of receiving all sorts of information debris into the system of processing it and **DAILY FILLING THE BRAIN WITH USEFULL INFORMATION**. This process is extremely complex, and for many people is completely impossible. The train, as they say, has already gone. But do not forget that there are also "**SvetL**" Programs, which, as the experience of their application shows, significantly affect this process, although, if the User wants to break this vicious circle.

I am explaining this again in an intelligible language. Gadgets, smartphones, ipads, tablets, etc., providing your constant connection to information on the Internet, Skype, social networks – make you almost a moron with an inert, apathetic, barely grasping anything Brain that is **NOT ABLE TO THINK AND ANALYZE**. But, like any drug addict, you, of course, are convinced of the opposite – that these "soap-boxes" and through them communication in the social networks, holding parties for which Skype is the most appropriate and for respectability called conferences and seminars, – all this make your life unrealistically bright, rich and comfortable, and you personally – such an advanced being who is "*always on-line, always informed of anything.*" Because of these devices, your Brain receives a continuous flow of all kinds of garbage that clogs your Brain ("on-board computer") so much that you are only fit to do the most primitive low-skilled work. Pay attention – these kind people after a certain time are unable either to speak clearly, or write and read, they speak thickly in bad language. Telling someone about something, they hardly pick up the right words, and listening to someone – quickly lose a thread of conversation, get bored, yawn and gape. They can not write at all, in general, because in almost every word mistakes are made, and they have no idea about using the punctuation marks. But they are "cool" taking selfy (and other garbage photos) and "knock" someone in **Viber or What's Up**. As the president of **CBS News** Richard Salant said: "*Our work is to sell people not what they need, but what we need.*" Make

your own conclusions out of this. Well, what about the filling the information space, and what was written above? Can you do it via the Internet? Yes, you can and should, – while it is available and used by a great number of people. You have to sift the information that you come across, and get rid of any rubbish (by virtue of your understanding, of course) But the **MOST IMPORTANT THING HERE** is **YOUR RESPONSIBILITY** for the information that you post. This is a complex and laborious work, but it will bring you, first of all, satisfaction in the work done. And you should not to enter into polemics with anyone about what you have published. It is a waste of time and nerves. You have to be prepared for not being understood by the people surrounding you, to put it mildly, because they do not "hear" your reaction to their "criticism" of your writings and the lack of your comments. And they will lose the opportunity to teach others and you, including – *"how and what you have to do and what to think about"*. They will say that you are "not in the right mind, crazy and lost your marbles, etc. There is no need to worry. Just do not be care a bit and forget. And do not let the "opinion of morons herd" become very important for you.

If you carefully analyze the story of the Internet creation, it becomes obvious – what for and who by it was created. All this took place within the framework of creating a new tool for fooling (within the framework of a tough control system) and destroying a Human. The basic foundation for the transition to a different understanding of the internet purpose should be (if it has been created) not only some set of administrative executive actions, as the members of the **Clubs of New Knowledge** actively discuss, but, first of all, changing in the state of one's Consciousness and Reason in accordance with the understanding of the ongoing events. All this is related with a substantial correction of the level of Cognition as a whole. This process is taking place. I am saying responsibly: the participants of the **"SvetL" Programs** are much quicker and more efficient, but there will not be any comments or moralizing on the activities of Club members, "investigation" of each step in regard to the coverage of an event, and "chewing" this or that process. We need to look for and find the most acceptable and effective form of filling the information space, relying on the experience that has already been got in the activities of the Clubs and Club members. And the main thing is to learn to read books again. Real paper books. Do you get it? Not to scrutinize your soap-box with a screen for hours with your weak-sighted eyes, but read books. It will be difficult, but you try. Do not force yourself – the first day read ½ page, the next – a whole page, on the third day – 1.5 pages, etc. Perhaps the body will resist this in every possible way -you will feel sick, broken and tempted to do anything, if only the

Brain does not strain. But you have to overcome this, because then you will get in the queue of those who want to **"take the Bath"**. This is where the **"SvetL" Programs** come in handy.

7.5. Why it is not allowed and what is permitted by now

What is **N. Levashov** for me? Many times after being acquainted with him, did I ask myself this question. Imagine: someone before your eyes grasping an empty space with his hands and pulling it down with one sweep, like a window in a train. After such a move a hole was formed in the space, through which I **SAW ABSOLUTELY DIFFERENT REALITY**. That's exactly what happened to me, it was "made" by Nikolai. Everything struck me to the depths of my soul. Seeing another being, I realized – ***there is another world lying beyond the usual one***, so unusual and beautiful that there are no words to describe it. As if I have lived in the mist (modern society lives in a misty world outlook) and suddenly saw something that fundamentally shocked me. After that, it became impossible to live as before. Here, to this vision of another world, lying beyond our usual one is a must to strive for, because it is impossible to live another way today. But this requires first of all New Knowledge and yearning for cognizing. And the **Program "SvetL"** will help to open the window of the train.

An Irish philosopher **George Berkeley**, in his time, shook the queen of the exact sciences – mathematics. **If $1 \times 0 = 0$, if $2 \times 0 = 0$, it turns out that $2 \times 0 = 1 \times 0$. As a result, $2 = 1$.** You can save mathematics by banning to multiply numbers by zero. There is no logic under this banning. We just take the rule for granted. Mathematics forbids multiplying by certain numbers – and we do not multiply.

About 100 years later, an English philosopher **David Hume** states on the inability to have confidence in anything. The full stop in this matter is put by an Austrian mathematician **Kurt Gödel**, who proved in the 20th century: **MATHEMATICS IS NOT EXACT SCIENCE**. Any system on the laws of logic contains assumptions that can not be proved or disproved, relying on the logic of the System, in which we have all "grown up". The most striking example is logic itself. It can be refuted only through logic, that is, remaining within the System. An irrational (intuitive) assertion can not shake a logical system, nor can it reverse – logic can not shake an irrational system. Today we are within

the framework of either the Old or the New System, and the rules of one system can not be transferred to another (and will not work). Even if mathematics is not exact science, what can be conceived as unquestionable? But we have to make the compatible out of the compatible – for application. Take, for example – the volume. Have a look at the room where you are now. Mentally remove everything from it: the objects, the air, as well as the atoms and the walls. It seems that everything was removed. But there remains the volume. How to remove the vacant space – the volume of an empty room? It seems that the existence of the volume can not be doubted. It exists, regardless of the presence or absence of anything in it. This is the initial schooling for understanding the "control" of your **"SvetL" Programs** and through them, for example, **the "SvetL-Flora" Complex**. You have to learn to remove all the unwanted from the room you created (volume, or rather, the structure in the form of a dodecahedron) and fill this space with whatever you want, or pass it further, or realize it in action. And do not worry if it does not work. Everything depends only on your perseverance and persistence to Know. But if we develop the idea further, the conclusion is valid if other conditions are available which are to be taken for granted. In particular, we are compelled to take for granted the information delivered to our Brain by five senses. The foundation is the condition in which you have to believe, because we look around and see different objects. But between these objects and us there are always mediators – our feelings (smell, touch, taste, hearing and sight). This was well described by N. Levashov in his works. Our eye receives information from an external source and, through the nerve channels, brings it to the Brain in the form of impulses. To be more precise, we see not by our eyes, but by our Brain. It is necessary to get the experience of "getting rid" of the vision of surrounding objects, while solving the task of filling the imagined space with some kind of action you have planned. But there is one minor "but". This "but" implies the concept of the noosphere⁵⁴ and the way its properties are being changed today.

The concept of the "noosphere" was proposed by the *professor of mathematics of the Sorbonne, Eduard Leroy (1870-1954)*, who interpreted it as a "thinking" shell, being formed by the human consciousness.

⁵⁴ The noosphere (the Greek νόος is the mind and σφαῖρα is the ball) is the sphere of the mind; the sphere of interaction of Man and Nature within the limits of which reasonable Human activity becomes the determining factor of development. The noosphere is a new, higher stage in the evolution of the "biosphere", the emergence of which is associated with the development of society that has a profound impact on natural processes.



"Fathers" of the noosphere: paleontologist-Jesuit **Pierre Teilhard de Chardin** (1881-1955); mathematician and Catholic modernist **Eduard Le Roy** 1870-1954); geochemist, representative of Russian cosmism **Vladimir Vernadsky** (1863-1945).

At present, the noosphere is understood as the habitat of all living creatures inhabiting the Earth (including Man). V.I. Vernadsky should be mentioned separately in order to move forward. And, probably it is impossible to say about him more profound and truthful than in the article by **A.M. Khatybov** "In what environment do we exist?"

Development should be accompanied with "new knowledge", which should be owned only by those who were considered "selected." The scientific basis for the "selected" was prepared, but one should not forget that the slogan "**ignorance is power**" was the main one in science, which is common for all. It should be given credit – one of the main conductors of this "science" was **V.I. Vernadsky**. The value of Vernadsky's works lies in the fact that he managed **TO UNITE THE WHOLE OF OBSCURANTISM** and **BRING SCIENCE AWAY** to that far side so that it made it impossible to come back. On the Earth there have not been such geniuses who so masterfully have brought science into the labyrinth. Vernadsky's brilliant works had to be supported until the program was fully completed, which was realized by the Ebr CS, and no one was supposed to know either the goals, or the means and resources of the Control System.

To spend energy on achieving the goals that do not exist, to scatter the attempts to find out the actual state of affairs, to increase the number of morons among research workers – all this Vernadsky managed to cultivate in the entire scientific world. And it was not by chance that Lenin pointed out the great importance of science – the science that Vernadsky was entrusted with. Vernadsky, unlike Lenin, did not prepare murders, genocide, destruction, but

he **ACCOMPLISHED THE MAIN TASK** skilfully – **TO DESTROY SCIENCE**. By the way, the issues related to the introduction of such a concept as "plagiarism" became popular precisely with his presenting. This is what we are "disentangling" today. Mankind will be grateful to Vernadsky, as the "genius of all times and peoples", for his creative approach to solving the main task – to ensure the safety of the program of real science destruction. And this task has been fulfilled with honor. Further in the article there are some quotes from the book "**V.I. Vernadsky. Philosophical Thoughts of the Naturalist**" (Moscow, Nauka, 1988, Publication of the Academy of Sciences of the USSR). They are given so that there would be no passionate accusations (with no understanding at all) in the fiction and irresponsibility.

"And it turned out that we did not have a more profound theoretical basis for all nature protection measures than the teaching of V.I. Vernadsky about the biosphere and its transformation into the noosphere. " (page 4)

"... And he (Vernadsky) came to the conviction that his doctrine of the noosphere is consistent with the Marxist doctrine of scientific socialism, and the future of the noosphere is closely related to spreading communist ideas." (page 13).

"For, the biosphere is the only earthly shell into which cosmic energy, cosmic radiation, are continuously penetrating and, first of all, the Sun radiation, supporting the dynamic equilibrium and orderliness: the biosphere-the living substance." (page 23).

V.I. Vernadsky's ingenious find:

"The evolutionary process ... created a new geological force – the scientific thought of social humanity" (p. 27).

"Under the influence of the scientific thought and human labor, the biosphere passes into a new state – the noosphere" (p. 27).

"There is no theory, no exact scientific explanation of this basic phenomenon in the history of the planet" (p. 29).

"The creation of the noosphere out of the biosphere is a natural phenomenon, more profound and more powerful than human history" (p. 35).

"It is real, the unity of man, his difference from all living things, a new form of power of a living organism over the biosphere, its greater independence than of all other organisms, from its conditions, is the main factor that eventually emerged in the geological evolutionary process of the noosphere creation"(page 42).

"The basic geological force creating the noosphere is the growth of scientific knowledge" (p. 49).

"For the first time the task is to penetrate the whole of mankind with scientific knowledge" (p. 50).

"The course of scientific work is the force by which a person changes the biosphere in which he lives" (p. 57).

"Although man is a geologically superficial phenomenon in one of the shells of the earth's crust, a new geological factor, one can not object to introducing this factor for geological subdivisions along with stratigraphic and tectonic units" (p. 58).

"Without the formation of the human brain, there would be no scientific thought in the biosphere, and without scientific thought there would be no geological effect – the restructuring of the biosphere by mankind" (p. 59)

"Tens of thousands of generations passed after the appearance of man in the biosphere before his manifestation became noticeable" (p. 61).

"To the previously known area of human life (the noosphere), in which science has been developing so far, two new ones, sharply different from it, have been added, the world of the Cosmos expands and the world of atoms and their nuclei..." (p. 74).

"E. Rutherford pointed out correctly that the modern development of physics, which has turned our worldview, .. by 9/10 is bound to radioactivity" (p. 78).

"As we have seen, geologically we are now experiencing the isolation in the biosphere of the kingdom of reason, which changes both its appearance and its structure – the noosphere -in a fundamental way. "(p. 127).

"Living organisms, having metabolism, create their own chemical elemental composition ..." (p. 177). (***** You will not find a more stupid formulation anywhere *****)

"An empirical generalization, once accurately deduced from facts, does not require verification" (p. 283).

"Until now, people have not been touched with scientific knowledge" (p. 396).⁵⁵

⁵⁵ A.M. Khatybov. "In what environment do we exist?" [Http://www.salvatore.ru/?page_id=1964](http://www.salvatore.ru/?page_id=1964)

Here I have given only the least part of the fundamental teaching of V.I. Vernadsky from A. Khatybov's article. I also talked with N. Levashov about Vernadsky, who expressed his **opinion** about this man and his role in science, but it differed little from Khatibov's vision. Vernadsky can be quoted endlessly, but one would rather regard his works sceptically, supporting one's theory with one's own observations.

The existing pyramid of science has been created for more than a century, and in such epoch-making time (transition to a new era and a new program) it makes sense to look back and examine this pyramid, since it just turned out to be without any foundation. Until now, from all rostrums, "leaders" of different levels, including "the first" persons, officially announce that no science can develop without army orders (MIC). Today it is confirmed by the fact that science and the military-industrial complex are united under one heading. Thus, **SCIENCE MUST WORK ONLY FOR WAR** or for destruction, that is, to create new weapons, while finding new data for modifications. The leaders believe that there is not and will never be a copyright on its work – all rights belong only to the military-industrial complex. A reasonable question arises: how then did **Khatybov's** and **Levashov's** works succeed in preserving, where one can find a lot "of this direction" (if, of course, one is able to understand). Well, they just do not fit into the existing pyramid of "science" (knowledge). For their understanding, other Knowledge is required, and none of them from the above-mentioned structures was given such knowledge. Why they were not given and will not be given – we will make it clear later. The pyramid structure is known, previously there was only one addition: all the developments made outside the contour of the pyramid at first became the property of the KGB, and only then – they might be allowed for the pyramid. The author was no longer needed here.

Today, the pyramid has lost its harmony, there are many mutants such as the **Academy of Ministry of Internal Affairs** (the graduate is supposed to shoot well). But the name does not change the essence, and all the academies adhere to the same foundation.

There came out many works the authors of which had not been allowed to come within range before, but directly sent to a psychiatric hospital. But now for such kind of authors, academies have been established, where similar foundation is used but



the works do not have any scientific value. But the foundation brings to doctoral dissertations and individual publications. By the way, the doctor's degree (doca is the Torah interpreter) in a number of such academies one can get just by opening a commercial stall. Therefore, so that the crazy works (such as torsion fields) might not get to the normal scientific environment, **the Commission on Combating Pseudoscience** was established. (The Commission was established in **1998** on the initiative of the Academician of the RAS V.Ginzburg). But about the true essence of this commission N. Levashov told at his meetings with the readers.

Thus, at the same foundation there settled peacefully the academy of sciences, the academy of Ministry of Internal Affairs, the Law academy, the Medical academy, and so on. But if one fine morning it turns out that the pyramid has no foundation, and everything is going to this, it will disappear along with its filling.

The foundation of science is the basis, or the instrumental base for conducting any research. Like the instrumental base like the result. The centuries-old development of science has led to the next instrumental base.

The basis is *horsepower, Mendeleev's table, Bohr's atom (and its modifications in quantum mechanics)*. By the way, the density of light is also measured in horsepower.

Suppose that the grating structure of any layer of the Noosphere has changed. Computers will stop; electronic circuits will have the form of scrap metal and so on. How will modern science explain the ongoing changes? There have already been reports about the end of the world, about the overturning of the Earth, mass disasters, etc.

It is also known, there was a flood on the Earth. What are these vagaries of nature and when will they come again (and under what circumstances)?

What is a UFO?

The simplest question is what is water like?

There is no such area of knowledge where **MODERN SCIENCE HAS ANOTHER ANSWER, BUT THE DIVINE BEGINNING**. However, we are returning to the Noosphere, but in somewhat different interpretation.

7.6. The Noosphere – what one should know

In relation to the Earth's radius, the thickness of the noosphere is insignificant – 7.45 km to the center of the Earth (from the surface level) and 27.36 km from the surface of the Earth (the sea level). You can estimate the volume of the noosphere. The theoretical area of the Earth is 510.2 million km², taking into account the relief, the Earth's area is 512 million km², and this figure coincides with the Earth code. For example, the Mars code is 480, but the outer surface area on Mars does not coincide with the Mars code; since the code and the surface area must coincide, we can make an assumption that Mars has more than one surface (that is, on Mars there must be internal surfaces). The noosphere volume is approximately 17817.6 million km³. This is the sphere, or rather, multi-layered spheroids, where each layer contains a certain information structure. This spheroid is rather thin (relative to the radius of the Earth), and any disturbances in any layer of the spheroid bring distortions into the information structures of the noosphere as a whole. The noosphere is protected, and reliably enough, both from above and below. From the below is the Hartmann grid, which does not allow any change in the electromagnetic basis of the atmosphere. This grid is formed by the intersection of magnetic, electric and gravitational power lines, forming the "skeleton" of the Earth (or a shape similar to the type of the human lymphatic system). Above is a tohr-shaped magnetic field, which is a trap for any external distortion, and the ozone layer that polarizes the hard radiation of the electric and magnetic waves. The noosphere is not a product of spontaneous formation, since the artificiality of the internal structure is obvious. It was the noosphere that was called into being *for the development and life of biosystems on the Earth* (the subject of using the single-celled to form the vertical base of the noosphere is not touched here). But the artificiality of the noosphere protective mechanism structure is obvious, if only because of the fact that any changes taking place on the Earth **DO NOT AFFECT THE PRINCIPAL LIFE-IMPORTANT COMPONENTS OF THE NOOSPHERE**-for example, air pressure, humidity, and temperature.

Nobody ever thought about the phrase, which is almost daily pronounced by the employees of the hydro meteorological center – **"the cyclone has brought the temperature"**. This phrase is similar to – *"the wind is blowing because the trees are swaying"*. Its comprehension makes consciousness search for a source that guarantees the existence of the noosphere.

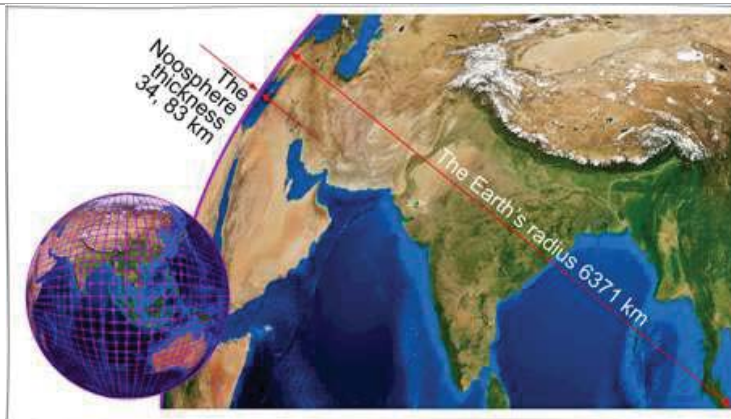

Out of more than hundreds of genotypes of people inhabiting the Earth, we will choose a genotype that has protection according to the system of motor coordination. In the classification table, such a genotype is indicated by the code 64,000000, or just **64**. Let us consider the statistical parameters of this genotype.

Nº	Name	Min	Norm	Max
1	Brain frequency, octave	248,12501250	480,0000000	512,0000000
2	Angle of the magnetic inclination of the brain cell, degrees	23,840	19,640	21,720
3	Body area	2,16 m ²	2,16 m ²	2,16 m ²
4	Weight, kg	62	64	76
5	Brain magnetic communication field, in/m3	6,4*10 ⁻²¹	9,6*10 ⁻²¹	12,8*10 ⁻²¹
6	Number of microelements	216357	484264	640000

Genotype **64** is superior to all others. Having a communication frequency commensurate with the Earth code, genotype **64 IS CAPABLE OF ANALYZING ANY INFORMATION MATRIX** (of any genotype), and also, using the time factor, making replacements in information matrices. Quite rare cases of such substitutions were observed even before the appearance of genotype 64 (for example, hypnosis), but people who are able to do this, as a rule, are mentally unbalanced, and totally fall under the classification given by Professor Lombroso, Dr. Kinsey and Klimov. Therefore, special cases, such as cases in the life of Wolf Messing, can not be taken into account – they did not affect the informational structure of the noosphere – they only partially used it, without disturbing or distorting the cycles of the Noosphere life support System. Unlike all the previous history of the Earth, the appearance of genotypes **64 to 72-74, WITH THE POSSIBILIITY OF CHANGING THE STRUCTURE OF THE NOOSPHERE INFORMATION MATRICES** entails a **TOTAL INFORMATION CONTROL** over the

noosphere. Where did these genotypes (from 64 to 72-74) come from, and also their functional purpose – for me, unfortunately, remains a mystery today... *I know "from reliable sources" that A. Khatybov's Brain was above 64, well and the Brain of N. Levashov is much higher, which allowed them to create what they were creating, each of them solving their s own task.* So called the "miracles in the sieve" (remarkable things), as Levashov used to call them, were stages in mastering the possibilities of changing the noosphere for certain purposes. You can understand this after carefully reading the first two volumes of "**The Mirror of My Soul**".

I am opening you a "secret", which very few people grasped. Immediately after Nicolai's gone, the information closed by dots in his texts until certain times was published. All this is more a description of "putting the finishing touches" to the possibilities of N. Levashov's Brain (Spirit), before solving more global problems. For those who has grasped it, these are the stages in the sequence of building up the Brain's activity, if, of course, you "had taken" **the Bath**, and got all the "procedures" done, and, most importantly, if you have the potential to build up something. However, now there can be other examples of "building up" activities, and not just brain one's. Five years after Nicolai's gone, a "book of memories" about him is published, which the authors named as the work of their entire lives, which, however, was very close to the truth, since an attentive reader easily discovers what the book contains, what it is telling about and in what way. I would like to note that in this "narration" there is a lot of information "borrowed" (just stolen) from my articles and this book of the first edition. I'm not against borrowing and using. I am against the fact when due to this information the so-called "authors" try to make their cheeks puffed up and demonstrate their importance both in understanding the ongoing processes and in interpreting Levashov's works, having neither a decent basic education, nor any understanding of what is written in these works. Well, as for the technologies, there is nothing to say. It is all just – deceitful meanness. And meanness is taking advantage of one's own insignificance! Probably, I should not have gone to the root of this matter. It is relevant more within the framework of today's problems and achievements, but for our research and knowledge of what is happening – this is not much necessary. So let us go on – the main parameters (by indirect data) of these genotypes (to a greater extent, genotype 64) are determined:

a) the biological binding is carried out in relation to the maximum genotype inhabiting **the Earth – 56**;

b) The functions of the Brain are expanded to such an extent that any mutation – according to Darwin's teaching – is out of the question, since the Earth's life support system is disposed to the optimal existence of a living cell under the following parameters of the atmosphere.

№	Наименование	Min	Max
1	Pressure, hPa	999	1038
2	Humidity, %	19	99
3	Temperature, °C	-34	+41
4	Number of compounds in the atmosphere	1024	1025
5	Content of H7 in drinking water, %	12,4	100
6	Content of H8 in drinking water, %	0	0,72
7	The Noosphere magnetic field, volts/m ³	-	1052
8	The amount of drinking water (base H6), %	-	1048
9	pH Parameter	98	110
10		7,4	5,6

Sea water (H6) does not contain the structure of H7 and is not considered as drinking water. For the past (2013-2015 and subsequent years) the following changes were observed:

№	Наименование	Min	Max
1	Pressure, hPa	966	999
2	Humidity, %	10	99
3	Temperature, °C	-42	+46
4	Number of compounds in the Atmosphere	1018	1018
5	Content of H7 in drinking water, %	8,31	8,56
6	Content of H8 in drinking water, %	0,12	1,62
7	The Noosphere electric field, volts*m ²	-	1043
8	The Noosphere magnetic field, volts/m ³	-	1054
9	The amount of drinking water (base H6), %	61	75
10	pH Parameter	6,88	4,31

It should be noted that for the current period *there were no complaints of genotypes of poor general state* – with the decrease in pressure from the norm of 1013 hPa by 15 units. Representatives of genotypes who do not have a multiple frequency of connection of the heart with the Brain feel such a decrease (there are about 62% such people on the Earth, the so-called "cardiacs"). However, there were no reports of mass deaths or mass consumption of cardiac drugs. It means the **INFORMATION SUPPORT** in the noosphere structures to the response to the external changes **WAS REMOVED**. Since ion transformations of genotype reconstruction after transfer must have strictly prescribed parameters, no genotype inhabiting the Earth can be folded or unfolded on the original data, which are given in the last table.

A sharp reduction of the electric field and the extension of the magnetic field significantly changed the entire noosphere structure, and, **FIRST OF ALL, THE INFORMATIONAL ONE**. It is very important to understand this. There was no tsunami, typhoons, high winds, and daily fluctuations of pressure, for example, were up to 30 units. Since the storage system for information matrices is built on a high-octave **magnetic field (64 octave)**, and the storage method is consistent **with the color range (8 colors)**, when reading and replacing information matrices, most likely, the superposition principle was used in the decomposition of white color (in this case, **the NA tone is the tone of annihilation**), **WHICH ALLOWED REMOVING THE REVERSE COMMUNICATION OF GENOTYPES** (and especially **4XX**) **WITH THE INFORMATIONAL FIELD**. That's why we observe inadequacies in actions and decision-making of all those who we get used to considering responsible for this. It is no use saying that in the absence of feedback, the life-support system of the noosphere remains without informational support to restore the norm, but, of course, after restoring, the information matrices of genotypes 64 will be destroyed first of all, since the norm parameters of the noosphere are not their norm for transmutation of the ion chain during the transient process, and the restoration of the magnetic and electric fields totally blocks the information communication even among 64. This should have happened before 2012; by this action there would have been destroyed a significant obstacle to the final implementation of Ebr system's plans.

However, until the last moment, **ANY INTERFERENCE OF THE EARTH LIFE SUPPORT SYSTEM HAS NOT BEEN OBSERVED**. Besides, the annual cycle has been observed under the conditions of the normal noosphere state. But due to the sharp "worsening" of the noosphere structure, changing the main parameters of the atmosphere for the transmutation processes of ions in **4XX** (without taking into account the state of the Earth's population), *there is a serious number of negative phenomena*: in foods, there is an increase of lactose and strontium, the number of cases of hypoglycemia and diabetes, cardiovascular diseases, so called AIDS **AND SERIOUS DISEASES OF THE PANCREAS**. The conditions of the annual cycle have changed – in April there is no growth of plants, etc. It is not yet known which forms of life are taken into account considering the changes introduced into the normal noosphere structure (**from 62 to 72-74**), *but the fact that it can not continue for long is already clear*. Therefore, all the changes made in the **"SvetL" Programs** in relation to the above are objective. Moreover, the effectiveness of the **SvetL Programs**, in comparison,

for example, with 2011, has increased by almost an order of magnitude (if such a comparison is appropriate). And the **SvetL-Flora Complexes** are getting more effective every year in interacting with both the noosphere and the plants themselves, because they are "capable" of reacting to the current changes in the noosphere, thus "protecting" the plants from the abrupt changes that are observed in the transformation of Flora. Practically, almost all this has already been proved by the results of the **"SvetL" Programs and the "SvetL-Flora" Complexes** application.

7.7. The informational Support Symbolism

The transformation of informational support and obtaining information for further development in the possibility of using the New Technologies has been stopped. Here I am talking about the latest technologies, which have already been developed, but have not yet been applied. It has nothing to do with the **"SvetL"** Technologies, which had been "launched" up before and "agreed upon in their application" with the New Control System. Therefore, their effectiveness is only increasing. And it increases, against the backdrop of changes in the Life Support System of people, which do not always have a positive effect on the current state of people's health. This is an objective factor, which I am going to substantiate in the future. And the hold up over the transformation of information support is due to the fact that, unfortunately, the control of the external system is related to the symbolism of the closed information space, which does not make it possible to use knowledge above the communication octave of this symbolism. The point is that symbolism is still of great importance in determining the elements of the world events, naturally, through the carriers of this symbolism.



Symbols and Signs, passed from Nikolai Levashov

Knowledge is the structured information, expressed in a symbol and having a certain meaning



Nikolai Levashov's Symbol

I will not "decode" the symbolism of the rings and of this Sign. Everyone should try to do it on one's own by virtue of their knowledge and understanding. I am saying just one thing – the so-called triangle, as a construction, – is the Knowledge – from the beginning (the low vertex) up to the maximum – the upper bar. But the saturation (the picture) in the triangle is a symbolism that tells us where, how, who for and who from this information is to be received, so that it can become your knowledge. But initially the information should be taken (got) from the one who is the bearer (possessor) of this Symbol.



However, we are going on. The representatives of **4XX** genotypes of the Brain have become acting in auto-motor style to a greater extent. So their ancient secret symbolism, as I have already mentioned, ***"The snake biting its tail for its own destruction"*** – is being realized, and only by them and against them!

What is the danger of using open symbols today? Read – the introduction and employment of the Newest Technologies based on New Knowledge and, as an example, – **"SvetL" Programs** in their full use, not only with respect to the Health of Man, but also in those issues that I have already described in relation to the Brain. If these technologies become available to those who are still "in power", but have already, as we see, become inadequate in understanding the current events and making decisions, the

consequences of this can be catastrophic. This is practically impossible, because the **"SvetL" Technologies are "tied" to the Symbols (symbolism)** and the **SYMBOLS ARE ONE OF THE COMPONENTS OF THE TECHNOLOGIES** in their entirety. That's how wise Nikolai Levashov was when creating these Technologies. After all I decided to write about it, because of that nonsense his new "biographers" and "connoisseurs" are talking including the one related to symbolism and Signs, owned and created by Levashov, and trying to distort and replace it, without having absolutely nothing to do with them even without ever seeing them in reality. And the statement that this is the Spirit of N. Levashov (see the Sign of Levashov) only proves their entire ignorance. As a conclusion – there is no sense to communicate with the past, which has no future! I have showed you all the open symbolism and Signs of Levashov (though there is also closed symbolism), there are **NO OTHERS AND CAN NOT BE**. However, there are also his pictures, but this is another story.

Once, an attempt to use open symbols (even distorted) led Germany to a fairly rapid growth of scientific potential (up to the invention of an atomic bomb). The consequences of this are known. But here I also want to emphasize the temporal, as B.Makov says, flow of events (process). How much time was required (in the Earthly sense) from the beginning to the realization. This, in fact, is for those who understands the current events, but wants everything to happen tomorrow or at least the day after tomorrow. We are not considering the history of the development of information links and ways of searching for today's solutions concerning the "creation" and application of New Knowledge and, on their basis, New Technologies (with a flashlight in the daylight). I note that today (unfortunately) modern science is based on mathematics and, accordingly, physics, chemistry, etc., **WHICH HAVE BEEN GIVEN AS APOCRYPHA**.⁵⁶ The developed mathematical apparatus and the system of knowledge make it impossible any longer to deploy the whole of "locomotive" so that the movement can be coordinated with the informational support of the noosphere. So, for example, at MSU engineers are trained in mathematics, able to calculate (as on a conveyor belt) and prove basing on the knowledge that has been accumulated and which are considered unshakable and infallible, anything you like. Any New Knowledge that do not fit into the modern paradigm is rejected (or stolen for future dissertations). **And N. Levashov, and A. Khatybov, and many others, including myself**, constantly

⁵⁶ **Apocrypha** (from ancient Greek – ἀπόκρυφος – hidden, secret, mysterious).

touched upon this topic. So, modern basic knowledge is built on the following "whales":

1. Mathematics

- 4 arithmetic operations, root, logarithm, integral, differential;
- 11-vector symmetry;
- Quaternion – the highest achievement (in calculations);
- a class of NP-complex and NP-difficult problems (more than 90% of the problems are reduced to this class).

2. Physics

Fundamentals – quantum electrodynamics and quantum electromechanics, atomic model – Bohr, Boskovic, matrix form.

No postulate works, all effects have a double, and sometimes even more meanings. The calculation mechanism is built on the class of problems "System analysis and operations research", mathematics does not solve this class of problems.

3. Chemistry

Mendeleyev's table is one of the main hindrance of development.

One form of any transformation, one table (with isotopes, isobars, isosters) without the elements connection and without the meaning of their existence. Flat forms display complex structures. This is what lies on the surface.

ANY RANDOM DOES NOT HAPPEN TWICE The lack of an instrumental base (primarily mathematics) does not allow one to approach even elementary calculations, let alone understand the meaning of transient processes. **A.S. Pushkin "... *The hut is standing there on chicken legs having neither windows nor doors ...*"** The simplest reminder of the multidimensionality of space, but even in **the simplex method**⁵⁷, transition to the next space is simple, adding one (!)variable. Misunderstanding of the meaning of space (the state of the octave) brings to the creation of a technical base precisely according to the level of understanding and, as a rule, everything is used only to destroy Humanity (for example, as soon as the names "virtual reality", "virtual space" appeared, the video "Virtual Killer" immediately came

⁵⁷ The simplex method is an algorithm for solving the optimization problem of linear programming by enumerating the vertices of a convex polyhedron in a multidimensional space. The essence of the method: the construction of basic solutions on which the linear functional decreases monotonically, to the situation when the necessary conditions for local optimality are satisfied

out). ***No technology is able to pass, measure, evaluate or at least understand the meaning of what and by whom we are surrounded,*** where we are and how accurately we fit into the noosphere – with a stone ax of knowledge, we are not able to assess. Major changes are taking place in the noosphere, and no one can understand anything – there is nothing to measure, there is nothing to calculate. ***Nobody is going to replace a stone ax with Kalashnikov sub-machine gun. The Earth is not meant for war, and any knowledge that can be used for warfare will only be given in an apocryphalized form.*** This is what one has to resign oneself. That's why I have to close some paragraphs of already written material with dots. And that's why, when talking about the **SvetL Programs**, first of all, I focus on health improving and interacting with the Brain, and no more. And this most of all wounds those who want everyone to believe that there is no N. Levashov's technology heritage. He was "too smart and could see far ahead to leave anything to anyone ..." Note that all these fabrications are submitted on his behalf with reference to their analysis of the written by Levashov. Analysis is always good when you put it in a jar in the morning to take to the clinic, with the hope of a good result. Again – ***all this is lying meanness. And meanness is taking advantage of one's own insignificance!*** But the main thing is that this insignificance is objective. On the night of **2012.10.12** one of the true CCs ("Altai") was turned on a programmed process that should be conditionally perceived as the "Eucharist" (the terminology of the SRI CPS⁵⁸). This process for the first time in its active phase had been up to **2012.10.25**, and in the subsequent time was resumed and "occurs" periodically, before every **COMPLETION OF THE SPECIFIED EVENT PROCESS**, as an element of some "sweep" ***in the transition to a new state of the embodiment of any development processes involving people.*** This is quite normal, but also irreversible, since being the only expedient in the processes of adaptation to new conditions of habitation (control). I decided to focus on clarification and write for those people who, in their majority, still do not understand what is happening to them and around them, after reading all kinds of "writings" about the life of N. Levashov. I'll try to explain what caused it, leaving the emotional side of the question.

⁵⁸ **Eucharist** – means in translation from the Greek language – Thanksgiving. Grateful "the reward for all that was created before," (even taking into account what is not of one's own will) is precisely how it will be more accurately expressed about the process that started as a result, as one of the elements of the new control on the Earth.

Many people who are looking after their physical condition through sensations, during this period, probably paid attention **TO THEIR OWN UNREASONABLE GENERAL STATE**, unusual sensations or some inexplicable and unreasonable anxiety and much more. Some of them have a great desire to convey to everyone their own vision of all and everything in any ways – through lies, intrigue and deceit, misleading, distorting the available information, and of course, all for the sake of raising their own significance. This is a consequence of cleaning the Brain "information blocks". This is what we notice in those who have written the "book of their life", mixing up their lives and N. Levashov's life without even realizing it. One of such elements is the control over changes in the general biological state of the human flesh cell. And it is carried out with the help of the "Cords", which phantoms passing is controlled by the CC "Altai". We will come back to this. The very essence of such a physical process is not important, but superficially reasoning about this, it should be noted that it is based on the "technology" of measuring the changes in the charge density of the matter of the magnetic and electrical energy of the Brain. I note here that this is one of the principal functions of the **"SvetL" Programs in their application**. The point is that all the changes in the states of Consciousness and Reason, the states of the "activity" of neurons and not only in the flesh of the Brain cells, are related to the changes in the states of matter of the Brain cells electric and magnetic fields (and the rest of the flesh to a lesser extent). This is one of the most important elements of self-knowledge at the present time. But this can not be public, since the basic everyday aspirations of people have not been "cleaned" yet from the consequences of parasitism and violence, especially in the states of public Consciousness. Here it is appropriate to add to what has been said that the change in Consciousness and Reason (for the better) in a certain way alters some important fragments of metabolic processes in the body. Take my word for it – diarrhea and the problem with the pancreas are not the main problems of those who want to write improperly about **Nikolai Levashov, Alexander Khatybov** and those people who are engaged in **Technologies "SvetL"** today. And the last thing – "thanksgiving" does not necessarily have a positive character, but is **"RETRIBUTION" FOR ALL REALLY COMMITTED**.

Today we do not know the laws of the Cosmos (even having read all the writings of N. Levashov, which were written in the framework of acquaintance with the unknown and undiscovered); the meaning of barabashka" (come outs) and "plate"(UFO) are not clear (even after reading the works of A. Khatybov, who clearly confirms this). Therefore, one does not have to speak seriously (or rather, talk big) that everything is known, and it only remains to take a seat and

calculate (what was taught). No positrons can quantize the fields of high octaves, no computers can come close to solving the simplest problem-*finding a cyclic sequence of ion conversion in a living cell*. You can, for example, study and set tasks in line with the book by **L.N. Prokopiev "Energy of Space"**, but at the end of the book there is a phrase that totally crosses out the title of the book – **"there is no instrumental base at the present stage..."** – and you can talk about anything here. As for **N. Levashov's Generator and the "SvetL" Programs**, – one can talk about, as well – **WHATEVER YOU LIKE** and **WHOEVER LIKES**. But here the instrumental base exists today. But it is still virtually unknown to anyone, except, of course, the creators. And, as I am being convinced day by day of its being unnecessary so far. But there are a lot of interested and curious people. What about – it's easy to guess. Any attempts to create an artificial intellect, for example, **firstly** come up against the meaning, (a low octave of the authors information exchange notices only the symbolism), and, **secondly**, the instrumental base. This can be fully attributed to the **"SvetL" Technologies**.

It is not necessary to say that the lack of knowledge of elementary complex symmetry (in particular, fractional spaces) is not a mathematical joke, but represents a profound research instrument in constructing ion transformation series, however, modern mathematics has found a way out here too – it has turned fractional spaces into Koch "snowflakes"⁵⁹ and closed the problem. Unfortunately, in the context of modern symbolism and the application of any new elaborations, first of all, on war, it is impossible New Knowledge, intended for the revival and development of Russia, to give *the bearers of closed symbols: firstly*, they do not need these Knowledge, they will not understand them; and, **secondly**, they are not meant to get these Knowledge. The fundamentals of New Knowledge are given in **A. Khatybov's** monograph **"Cold Nuclear Synthesis"** and, as an initial cognition in order to move forward – in the works by **N. Levashov**.

⁵⁹ **The Koch curve** is a fractal curve, described in 1904 by the Swedish mathematician Helge von Koch.

Three copies of the Koch curve, constructed (points outwards) on the sides of the regular triangle form a closed curve of infinite length, called the Koch snowflake.

7.8. Confirmation in Reflections

Now tell me, honestly, are there many great minds in Russia, with the exception of a few, ready to give up at least the usual level of comfort for the sake of Cognition and, most importantly, ready to pass what they know to others? Are there any people who consider the whole nation not as a cattle that needs to be manipulated, but as one's family? They are very few today. Instead we have – "talking heads" and debaters on the Internet sites – who is "cooler", what they "have known" and how this "known" puts them "above others" (unfortunately, the like). They are always – with grandeurous rhetoric and a set of common phrases, behind which selfish desires are guessed and nothing else. They are like a mother, for who a living child is replaced by a certificate of his birth. *This kind of people including those "writers" I mentioned, are smart in getting a smattering of knowledge.* As soon as you plunge them into the heart of the matter, they lose ground under their feet and fall into the zone of discomfort. They are able to leave this zone only by refusing to think about global subjects and accepting their own patterns on faith.

None of these people has any idea why he thinks so, on what grounds. Such a question never comes to their minds. But this does not prevent them from considering their beliefs as the only true ones, while others – to be more or less false. If other people's views are absolutely similar to their views, they recognize them as absolute truth. If the views are absolutely different, then they consider them an absolute lie. This is only my opinion, which you can agree with, if you have read what is written above, and you can not agree, if nothing is understood (it happens). But I am going to write not about them (much honor), but about other people – Human Beings who I make friends with and consider them my Companions. These are the people who were brought up within the framework of the "science" I have described, but found the strength and courage (exactly the courage) to reconsider the concept of their Knowledge just as I did, in my time, and start cognizing all the new things that were brought in this world by N. Levashov, A. Khatybov, N. Morozov and others. Moreover, they are able to convey to the listeners and readers exactly what they themselves have cognized.

One of them is **Igor Mikhailovich Kondrakov**, Ph.D., Professor, the author of many articles about N. Levashov, A. Khatybov, a number of excellent thematic articles, such as "**Lessons of Cognition**". I have already mentioned him briefly. Here are his reflections on **matter G** from his article "**Parallel**

Universes", which is a complement, or rather, one of the explanations in comprehending the noosphere as such.

The first introduction of N. Levashov's concept has already passed through his books, articles and new technologies that work. But there may be another introduction – confirmation of the idea that within the noosphere, which interests us, a physically dense substance consists of the synthesis of seven primary matters, and there is one of them that plays a **SIGNIFICANT ROLE IN THE FORMATION OF A PHYSICALLY DENSE MATTER**. The question is of **matter G**, which completes the process of synthesis of hybrid matter and which exists only in the physically dense component of the Planet, therefore it is this matter that must be responsive to **matter G**. As is known from the concept of



N.V. Levashov, after the Planet formation and the "elimination" of heterogeneity, primary matters (which are plenty in space) freely pass through the Earth, not interacting with it in any way. And only one – **matter G** that does not exist in the second – sixth spheres, interacts with the physically dense sphere (since in it there are components of matter G, even in the form synthesized with other matter) creating a sail effect, or gravity. Obviously, insects, such as beetles, (most likely, humanoids, brought to Earth in large numbers – more than 12 billion, materializing in them) "learned" to "control" **matter G** in the process of evolution. When blocking this matter, you can make an anti-gravity effect and it is possible to create conditions for the materialization of humanoids, with their "extraction" from non-inertial structures with subsequent destruction. This mass manifestation is observed in many regions.

As an example – "incident" in late **February 2016** on the beaches of **San Bernardo in Argentina**.



Beaches of San – Bernardo

Gravity, by definition of A.M. Khatybov, manifests itself as a property of a magnetic impulse, on the one hand, and on the other one, as a property of electric charge. In general view, the charge has a central part and a shirt (contour). The charge moves between the nodes of the icosahedron, having a slip angle and potential. In the structure of the icosahedron, the charge does not need a shirt, the structure vector is directed toward the charge center and the charge itself is subject to external forces. That is, the shape of the PM is defined by the contour of the magnetic structure – the PM cell of a certain shape. Similar properties of PM have a certain gravitational effect at all levels of the planetary spheres, preserving the integrity of the whole planet, thanks to EM properties, that is, the difference in the dimensionality of space. Matter **G** in the composition of physically dense matter is a "obstacle" ("responsive" to "pure" matter **G**) for the passage of free flows of this matter through a physically dense substance.

Matter **G**, like others, is an electromagnetic oscillation⁶⁰ corresponding to the spectrum of the quantization coefficient of the space γ_i , i.e. oscillations of a certain frequency or octave. For example, hard – X-rays to gamma radiation have from **54.375 to octave 60**, i.e. this frequency is $\sim 10^{16}$ - 10^{18} Hz. **Sunlight is octave 48 or 10^{14} Hz.**

Matter **G** in the composition of physically dense matter is a "obstacle" ("responsive" to "pure matter **G**) for the passage of the free flows of this matter

⁶⁰ N. Levashov « Heterogeneous Universe ».

through a physically dense substance (since adds MI, towards a general dimensional difference).

As is known from AM. Khatybov's concept, one should study the matter in the following sequence in order to form correct world view: **"Strictly organized plasma → material structures (gaseous → liquid → solid)**. that is, the sequence of octaves ((128) → (126-74) → (72-66)) → (64) → (62-34) → (32-28) – (24-26) → (22-16). If a number of octaves is converted to "ordinary" frequencies, we get the following spectrum: **10³⁸-10⁵ Hz.**

The X-ray part of the spectrum adjoins the ultraviolet. The frequencies of x-ray radiation lie in the range from **6·10¹⁵ to 3·10¹⁹ Hz**, which corresponds to waves from **493 to 0.1 Angstrom.**

Let us consider the following series of octaves: **7, 9, 11, 13, 15, 17, 19, 21, 23, 25, 27, 29, 31, 33, 35, 37, 39, 41, 43, 44, 45, 46, 47, 49, 51, 53, 55, 57, 59, 61, 63.65, 67, 69, 71, 73, 75, 77, 79, 81, 83, 85, 87, 89, 91, 93, 95, 97, 99, 101, 103, 105, 107, 109, 111, 113, 115, 117, 119, 121, 123, 125, 127.** **Octave 7 (this is ~10² Hz)** is the lower limit of the existence of structures on the Earth, with a decrease in the frequency of at least a hundredths of a percent in structures with an octave **7** there occur infrasonic waves that destroy, in the first place, the Brain. The entire first and second series are available to the Control Systems, octave 63 (~10¹⁹ Hz) – this is the known atom, Mendeleev's table and everything that is known to modern science. The third row is not available to the Automata of Control Systems, although in respect of octave 127 (~10³⁸ Hz) the **SPACE AND TIME ARE BUILT**. A special attitude is **towards the 3rd row**. Here are all the mental and astral fields, marked by weak and heavy influences and unknown in nature. It is established that all structures on the Earth have a strict hierarchy, especially in atomic construction.

So, matter **G**, as an electromagnetic wave, should have octaves just above the octave of a solid, i.e. **16-32., i.e. 2¹⁶-2³²=10⁵-10¹⁰**. This frequency under certain conditions can destroy a physically dense substance or block the counterflow to create the state of weightlessness.

The fact that it is matter **G** is responsible for antigravity effects, we try to show, using the experience of **Victor Stepanovich Grebennikov** with his flying platform. And this is a clear example for those who doubt about the New Knowledge being interconnected and closely intertwined.

Only "drawing up" the works of **N. Levashov, A. Khatybov, V. Grebennikov** and others, one can achieve a result in both gaining Knowledge and realizing this Knowledge in practice. Only this way, and there is no other way. The canonization of anyone (as an example, the works of N. Levashov) of course, at the first stage will help to get initial Knowledge and give impetus to a revision of one's vision of the World. But to get some practical result expressed in realities – will not bring, unless, of course, there is a concrete imputed embodiment of "making" something within the framework of the imposed program upon someone (but necessarily with the corresponding basic Brain readiness. "Invention" of Victor Grebennikov is such an example Another example in obtaining Knowledge on the basis of combining information from the works of N. Levashov, A. Khatybov and others is everything related to the creation of the **"SvetL" Programs**. Victor Grebennikov has discovered the effect of cavity structures (ECS), which official science has not recognized (since this effect does not manifest itself everywhere and it is impossible to prove it)⁶¹.



That's what he writes in his book "Flight". "Taking into account" the bee hives, I made dozens of artificial "honeycombs" of plastic, paper, metal, wood, and it turned out that the reason for all these unusual sensations was not the "biofield" but the size, shape, quantity, interposition of cavities, formed by any solid bodies. And still the organism felt it, and the instruments were "silent". *Calling the device the effect of cavity structures – ECS*, I went on intensively and diversified the experiments, and Nature continued to reveal to me its innermost secrets one by one ... It turned out that in the zone of ECS action the development of saprophytic soil bacteria, yeast and other fungi, and wheat is depressed, the behavior of microscopic mobile algae of chlamydomonas is changed, luminescence of bee-leaf larvae appears, and adult bees in this field behave much more actively, and the work on pollination of plants is completed two weeks earlier. It turned out that the ECS is not screened

⁶¹ As I have mentioned, the effects of **Searle (JRR Searle)** and **Victor Stepanovich Grebennikov** were not related to the physical properties of the general (in our understanding) space, but fell into the sphere of influence of Ebr objects (type 440), which used energy of these devices. Later, when moving or destroying these objects, the effects disappeared.

in any way, like gravity, acting on the living through walls, thick metal and other obstacles. "

Then he writes: "It turned out that if you move the cellular object to a new location, then Man does not feel the ECS at once, and after a few seconds or minutes, in the same place there remains a" trace "or, as I called jokingly," phantom " , palpable by the hand through dozens of minutes, or even months later. It turned out that the ECS field goes down from the cells not evenly, but surrounds them with a whole system of invisible, but sometimes very clearly perceptible "shells" (perhaps, this is a volumetric diffraction pattern after the splitting the matter stream into quantized components).

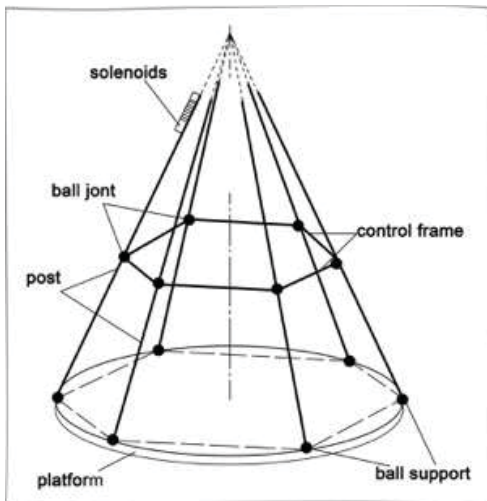

It turned out that animals (white mice) and people who fall into the zone of action of even a heavy ECS, after a while get used to it, adapt. It can not be otherwise: we are surrounded everywhere by numerous large and small cavities, grids, cells – of living and dead plants (and our own cells), bubbles of all kinds of foam plastic, foam rubber, foam concrete, rooms, corridors, halls, roofs, spaces between the details of consoles, appliances, cars, among the trees, furniture, buildings. The "pillar" or "ray" of ECS turned out to be more

effective for the living when it is directed to the opposite the sun's side, and also downwards, to the center of the Earth (where all the flows of primary matter are directed). Does the description of the ECS work convey anything to your mind?

I placed this small concave chitin plate on the microscope table to examine its strangely-stellar cells once more under rather large magnifying power. I admired another masterpiece of the Nature-jeweler, and almost without any purpose I put on it using the tweezers a similar plate with these unusual cells on one of its sides. But there it was not: the part broke free from the tweezers, hung for a pair of seconds in the air above the one on the microscope table, turned a little clockwise, sided down in thr air! – to the right, turned counter-clockwise, swung, and only then quickly and sharply fell on the table. What I experienced at that moment – the reader can only imagine... Having recovered, I tied several panels with a wire; this was not without

difficulty, and only then when I held them vertically. There I got such a multi-layered "chitinblock". I put it on the table. Such a relatively heavy object as a large clerical button could not fall upon it: something seemed push it upward, and then to the side (the chitin layer, its structure, unfolded matter **G**, resulting in an anti-gravity effect). I attached the button to the top of the "block" – and there began such incongruous, incredible things (in particular, for a moment the button completely disappeared from view!), And here I realized: it's not a beacon, it's quite Another thing".

It turns out that if we divert the flow of primary matter **G** and its components from the object, **THEN THE OBJECT BECOMES INVISIBLE** – which is confirmed by Grebennikov's experiments with his platform: when he went up on it, he could not be seen from below. And further: "I observed in the microscope the wings of the May beetle and the golden-cheeked head – a beautiful honeycomb pattern of the rows of arranged funnels with cones projecting from their bottom, which ended in a thin" hair "(evidently for the drain of static electricity). The wings pierced from the inside with a large number of vessels to supply liquid in them. Most likely, the shape of the elements of the picture creates a barrier to primary matters (unfolds them) trying to "press" the beetle to the ground. "

Grebennikov describes his experience of moving in space on a platform: "The speed of the flight is quite high – but the wind does not whistle in my ears: the power protection of the platform with the block panels" cut out "in the space the divergent upward invisible pillar or beam (unfolding the flow of primary matter **G**) cutting off the attraction of the platform to the Earth – but not me and not the air that is inside this pillar above it; all this, as I think, during the flight, as if the space was moved apart, **REASON** for the **APPARATUS BEING INVISIBLE** with a rider," or rather "riser", or partially distorted visibility, as I have had recently over Novosibirsk Zatulinka.

Once, with a fast descent, in the free fall mode, the left hilt ... flew away, and I could have been "in a better world," but I neither hurt, nor even felt the impact, only the darkness: the platform-plate plowed in the land – it's good that not on the road! – a fairly deep well, at first vertical, and then turning to the against the sun-side. From this wonder-well I could hardly get myself and my platform out, of course, rather damaged; but the most trouble was the "well": it had no dumps! "The platform performed the function of "press tool", as if the soil was made of non-deformable material), and without dumps, which should not be when pressing. The properties of the soil have changed as if the platform had made an imprint in space. It is a pity that Grebennikov did not

describe the condition of the ground under the platform and the side walls, here one can only guess.



Grebennikov's platform

And then Grebennikov, as a pioneer, whose brainchild has not been accepted by the official science, shares his thoughts: "Why am I not revealing the secret of my discovery? **Firstly**, because to prove it you need time and energy. I do not have either one or the other. I know it from my bitter experience of "pushing" my previous findings, including the most obvious phenomenon – the effect of cavity structures, in the reality of which, undoubtedly, readers have already become convinced. And here, what is the result of my many years lasting troubles about the scientific recognition of ECS? ***"For this application for the opening, further correspondence with you is inexpedient."*** I know some of the Controllers of Fate of Science personally and I am sure: Should I make an appointment with one of them, which, however, is almost unbelievable – and open my "sketchbox", turn the handle and soar on his eyes to the ceiling – the owner of the cabinet will not react, or even order the magician out. Quickly, come to replace them, these "top managers", you, the young!". The same and in full, I can say about the **"SvetL" Technologies**. But is this the main thing? The main thing is that they exist, work and work for the good of people.

7.9. The Concept of New World Outlook

For those who likes to live at the expense of an unknown problem (in the framework of modern knowledge in physics, mathematics, biology, etc.) ***I am revealing a little secret, or just saying again: NO ONE HAS EVER FLOWN AND IS NOT ABLE TO FLY*** onto the Earth – any biostructure

only approaching the Solar system will be detected and destroyed by the Earth Control System. All that had been observed before **2005-10-08 00-14** were the sondes sent from the landmarks (4100-4800 m deep) for the purpose of control. At the same time, to analyze what has been said, one should have Knowledge that can not be obtained from academic structures – one should have at least an idea of not the horse science. New Knowledge "is being taken root" at a fairly rapid pace and with great intensity, if I can say so. Another thing is – who is taking it, and who is withdrawn everything that had been inculcated within the framework of the Ebr System. Modern science has at its disposal the knowledge obtained on the basis of fictitious constants. Time, space, speed, temperature, etc. are derived on the basis of values that have nothing to do with the physics of the process. That is why today practically no one (except for a few) can closely “approximate” to understanding the **Generator of 'Dark Matter" and the SvetL Programs**. As for the physics of the process there is nothing to say. The works of A. Khatybov both in the accessible part and in the non-public are the translation of the texts received by him, translated in the beat intervals of communication with the imposition of developments in the field of *living cells, mathematics, and symmetry*⁶². Everything he describes is one of the foundations for understanding the "work" of **the "SvetL" Programs**, including their application for launching missiles that are not "equipped" with what they have to be equipped. And the “cupola” about which the new "biographers" of N. Levashov are talking about, has nothing to do with it. I have written some articles about this, which are published on the "[RSTS](#)" [website](#) and I see no point in saying it again. The coincidence with respect to the Programs and their applications is not accidental, since this basic material **IS THE FOUNDATION FOR THE CONSTRUCTION OF SYSTEMS OF MOVING IN SPACE** with other principles of motion, rather than overcoming the environmental resistance. Only the operation coordination of the Earth Life Support Systems with the principle of non-annihilation, will bring to the application of Knowledge for the subsequent qualitative development of those who are eager to take **the Bath**.

The concept of the New Worldview has already been partially expressed in the first book. Here it is somewhat systematized for a more profound understanding and especially in relation to the Brain.

⁶² See details in Book 1, Chapter 3.5

1. **The Earth** is controlled by the Control System located below the surface of the Earth.

2. **The Control System** is a complex hierarchical system.

3. **On the Earth** there are more than 2000 control systems.

4. **The basic Brain** of each individual **IS STORED** in the archive of the Control System, at each beat interval the Brain of the individual is monitored with the information recording.

5. **The Control System** uses 7 types of time, one of which (**60×60×24**) is the beat of the bottom of the grid.

6. **To convey** the information, the Control System uses a musical series, and the resonance contours of the spine are the receivers of the information.

7. **To control** the Brain, the Control System uses a different musical series.

8. **The series** for controlling the Brain: **DO RE MI FA SOL LA SI NA**, the **LALALA** code (**666**) – callsigns plus the code from the magic square.

The appearance is a shirt, and the Brain transfer is made into a shirt that is compatible with the transferred Brain in the frequency balance. When transferring the Brain, the information in the archive might be fully or partially kept safe, that is why the individual does things previously beyond his comprehension.

The replaceable Brain can be saved, but, as a rule, it is scattered, while the ion structure (and DNA, too) remain the old ones (sedimentary structures of the old Brain).

The new Brain does not form DNA, therefore it is always possible to detect the substitution (for example, the case with Anastasia ⁶³- Anastasia's brain was moved completely to another shirt, and only DNA analysis indicated a mismatch). **When the Brain is replaced**, the Control System assumes that in the archive the new Brain is more perfect than the one being replaced, but this is not always the case, the reverse process has recently been observed.

The Old Brain can not be replaced if some control points are missing or can not be replaced (inconsistency of the genotype, illnesses, such as AIDS or

⁶³ **Anastasia Nikolaevna (Romanova)**; was born on June 5 (18), 1901, Peterhof. On the night of July 16 to July 17, 1918 in Yekaterinburg, the Great Princess, the fourth daughter of Emperor Nicolai II and Alexandra Feodorovna, was shot with her family in the house of Ipatiev. After her death, about 30 women declared themselves "the miraculously saved great princess"

tuberculosis, a narrow range of lung memory, exceeding the level of potentials in radioactive frequencies, etc.).

A rather important aspect is the way of transforming and resizing the structure, as I have already written about it.

This implies an important factor – the new Brain is fed in a higher octave, and the functions of the old Brain can only be broken partially. All this refers to the Spirit and those processes taking place with it, which are also described by N. Levashov⁶⁴.

The list can be continued, but it is better to look for more detailed in the works of A. Khatybov and N. Levashov. I just want to note that today the work proceeds (it is public now) to make a certain Depository for those **"replicas" of the Spirits** that remain in the "SvetL" Complexes after their Users are gone. This is an extremely important and significant matter concerning the possibility of integration into the future. Naturally, such a decision was "agreed" upon with the direct involvement of **B.Makov** in this, through the Control Complexes, and N.Levashov's **Friends**. Much remains to be done, but how and what to do – is clear today! To have this priceless information "pushed" into a certain Depository, for the purpose of a possible "demand" for it in the future – one condition is required – the Information must be clean (washed, combed and dried). And this is possible only when the user of the Programs has been taken to the **Bath**. In the future I will describe the principle and mechanism of all this. I'll tell you how I was helped and what difficulties had to be overcome after this subject was put on **the agenda in 2013**.

I would also like to draw your attention to this aspect, which is manifested today by inventors and scientists, as the growth of the number of inventions of perpetual motion machines or, at least, the eagerness to create them. More than 99% of such works are obvious stupidity even from the point of view of official science, but if in some cases there is a non-inertial mass in the technical solution, the problem can not be solved by conventional means and devices, especially since the Bohr atom does not change the dimensions, and the Periodic table does not contain non-inertial mass. Let's return to the question – is it possible the existence of a perpetual motion machine? If we take a time period of 100 years, then it is possible – by scattering high octaves, the ionic masses can be "fed" from nowhere, but this is in case of the presence or combination of inertial and non-inertial masses. **An example of such an**

⁶⁴ N. Levashov "The Spirit and the Mind"

eternal engine is Man WHOSE BRAIN IS IN A NON- INERTIAL STRUCTURE.

What will happen if someone decides to visit Pluto on a modern spacecraft? Or Mars, about the flight to which everyone is talking whether it is in place or out of place?

While moving, the high octaves will be scattering (and this is the Brain), so when flying by Mars we will have the Pithecanthropus Brain, and **in the final point – a pile of sand**. All objects that move in the Cosmos have a *gravitomagneto-electric generator, supporting the existence of moving matrices at all frequencies*.

This is for those who have not yet understood – how our ancestors had flown on Vaytmanah and Vaytmarakh, and how Nastenka⁶⁵ "walked" beyond the "far away lands".

7.10. Some words about UFOs which are talked so much about

Any form of life requires the support of frequency balance, and this support is provided on a temporary or permanent basis (System). Biostructures on any celestial body have only that frequency spectrum that is provided by the System. This spectrum of frequencies was provided: either due to UFOs (a cupola had been created earlier, inside of which the life of a biostructure was provided, for which the frequency balance was unique); or (if the physical parameters of the celestial body are suitable for a living cell formation) the life support system is created, which provided without a UFO:

- control of the noosphere state;
- storage of the autonomous Brain;
- transfer of the Brain;
- support of the autonomous Brain;
- communication with the autonomous Brain when changing the program of actions;
- memory adjustment (by template)
- after death – partial elimination of the Brain (subsequent transfer to other biostructures or animals, or creation of humanoids);

⁶⁵ N. Levashov « The Tale of the Clear Falcon ».

- connection with the planet, from where this civilization is transported;
- development of the Brain according to the program;
- If a person dies earlier, his Brain (with full coincidence of all biological parameters, all communication systems) is written to the newborn, while a partial memory is possible (a rarity, and even more so today).

Elements of the System were brought by UFOs, and in future the system provided the existence of UFOs. UFOs could not fly on the own (and more so, do not fly now), but to know how all this had been what it resulted in is necessary). For long distances (to other galaxies), they were transported inside a closed system (for example, the Moon) and upon arrival at the site it was the System that provided the communication tubes for **UFOs** and energy support, which in fact was realized when the Earth was captured.

Everyone knows about the existence of UFOs. Some saw them, some even "flew" on them, so this presentation should not cause fear and, more so, stress. Flying to the Cosmos at the present stage is a chalk movement on the board – the chalk is used up after a certain number of meters. So you cannot fly in the Cosmos this way. However, this does not prevent today's "scientists" from wasting enormous sums of money, proving to each other and, of course, the Prime Minister that, "...we will soon fly to Mars. The Moon is close – and there is nothing to do there.

In this regard, I suggest acquainting with at least *a list of sections from the works of A. Khatybov, which would be nice to read to those who "prepares" travels to the Cosmos.*

Names of the prepared sections:

- atomic structures, matrices of transition states of atomic structures;
- the law of prime numbers, the calculation of a prime number with any number of signs;
- symmetry laws – 18 axes of symmetry, 6 translations, double, fractional and complex spaces;
- algorithm "kaleidoscope" – solving problems from the class of "systems analysis and operations research" in real time (any dimension);
- the morphology of space, the Noosphere structure;
- communication and matrices of code transformations of potential;
- a living cell, forms of existence and development;
- measuring complexes of Life Support Systems, forms of existence, life time, frequencies, memory capacity;

- physical constants of the Solar system;
- generators of atomic structures, the coordinates of their location, the systems of Life Control on the Earth;
- law of accumulation and transformation of potentials while a UFO moving;
- UFO computer support, memory structure, speed of response, memory capacity, communication and ways of conveying information.

But here is the information for those who "are dreaming of taking the Bath". Because after the Bath New Knowledge will be opened, some of which are based on the following.

1. Atomic structures

- The "proton" atom is the basis of the "material" world;
- Mankind has revealed some features of the "proton" atom, transforming it into Bohr's atom;
- "Neutrino", "neutron", "antiproton", etc. atoms – the basis for building the world around us;
- results of calculating the structures of the proton atom as a phenomenon of the Periodic table (modern physics knows less than 1% of the proton atom structures);
- matrices of transition states for the simplest forms of an atom;
- the structure of the "ideal" atom as the basis of the vacuum.

2. Space and time

- each atom structure is formed for its own space;
- the concept of "albedo", or "swing", to determine the structure of space;
- double, fractional and complex spaces;
- the definition of time as a relative value of the potential transformation;
- base time in the "Proton space" – halk (from the decoding of the message), corresponds to 1/1080 hours;
- structure of the Solar system. The outline of the Solar system;
- movement of planets, comets, meteorites;
- matrix representation of vacuum;
- absurdity of the Hubble sphere;
- Satellites of the planets, their purpose, the principles of the operation of protection systems, information support.

Monitoring the state of space. **Example** – what space does the cat see? Can you answer or imagine? The role of biostructures in the monitoring of the space state of their existence. **ON THE EARTH THERE ARE NO OUT-OF-THE-WAY BIOSTRUCTURES**, the appearance of new types – increasing the stability of the space-time state;

- removal (destruction) of obsolete forms – You can compare the disappearance of the arithmometers because of the appearance of calculators;
 - 108 laws of transformation of any space of the **Noosphere**;
 - cycles of albedo change in the Solar system;
 - 108 layers of the Noosphere, including 32 layers for the Earth;
 - matrix of fiber division. Energy properties of each layer of the Noosphere;
 - Earth protection systems. Energy density of the Earth protection systems (against penetration of extraneous UFOs);
 - types of spaces in each layer of the Noosphere;
 - Noosphere, as a translator, when converting the Cosmos grating into water;
 - conditions for obtaining water, a variety of water, its purpose;
 - Conditions for the existence of UFOs in the Noosphere of the Earth.
- The table of correspondence of the elevation height of the UFO and the energy state of the layer of the corresponding Noosphere space;
- the principle of motion of a UFO in the Noosphere layer;
 - energy and morphology transformations of UFOs when moving in a layer;
 - communication and protection;
 - transmission of information.

3. "Native" and alien UFOs

- coordinates of UFO location on the Earth, depth of "lying down", matrix of ascent and conditions of existence;
- UFO varieties, their purpose, technical characteristics, computer support and communication systems;
- mathematical support for UFO computers, number systems, conversion for different types of UFOs;
- mathematics of the octave and concepts of the computational process;
- "refueling" benchmarks and "fueling" hoses;
- reference table in the Greenwich coordinates;

- morphological transformations of UFOs with a change in their distance from the reference benchmark;
- stable (programmed) state of UFOs, forms of proton atomic structures;
- the concept of flight range. If necessary, the UFO removes some structures from the current space;
- the conditions for transferring the removed structures to the UFO status matrix;
- withdrawal of the Brain and biostructures control systems;
- removal of a biostructure;
- table of direct and inverse transformation of the biostructure into a UFO matrix;
- UFO control system, the concept of UFOs "pilot", elements of robotics;
- returnable and unreturnable UFOs;
- UFO accidents and the destroyable systems in case of an accident;
- control of foreign UFOs, protection and effectiveness of destruction;

4. Mathematics of the octave

- coding in octave, code conversion systems;
- a programmed complex for the potentials of octave 23.5;
- automatic programmed complexes to work out angular coordinates during the movement;
- inertia and stability;
- correction matrices for the corresponding Noosphere layer;
- tables of prime numbers for the mathematical support of protection systems;
- The Golden section as a basis for a control point when entering new software for UFO computers;
- the real time scale for solving any problems, including "Systems Analysis and Operations Research";
- penta (five-sided) as the basis for the construction of the benchmark.

-

* * *

The rule of calculation. Any task is solved for a strictly certain time, regardless of its complexity. This entirely applies to the solution of tasks related to the creation of the **"SvetL" Programs**. If the problem **CAN NOT BE SOLVED OVER THIS TIME IN THE ASSIGNED SPACE**, *its solution is performed in a different space, with a different time, and then transferred to the assigned one, while the transition time and the solution are the total time for the solution of the problem*. The beat time of the solution is the beat of the state change (albedo). It is 1/54 of the hulk.

* * *

- UFO movement does not depend on "weather" conditions;
- octave trigonometry, morphological transformations performed using octave trigonometry;
- mathematics of the octave for automatic UFOs;
- mathematics of the octave is the basis of space communications;
- the musical series of the octave is the basis of the living cell.

UFO Computer

The elementary cell of the UFO computer is the star of "David". When conveying the charge in any number system (3rd, 6th, 12th, 8th), the star converts to the 8th code. Let me remind you that the command systems for Biostructures, UFOs, Control Systems **OPERATE IN DIFFERENT NUMBER SYSTEMS**. The same can be attributed to the **"SvetL" Programs**. The assembly of elementary cells is a spiral with a maximum memory capacity of 10^{12} bits (in the 10th system). The number of spirals is from 10^8 to 10^{24} . By the way, the 10th number system is not used. The Control System reads messages and commands in the computer, according to which the UFO performs the appropriate actions. *Without a command, no UFO will move.*

All initial messages until 2007 had been only in English, after **Easter 2007** – only in Russian. The clock period is determined by the Time Control System (South Wales, England).

UFO Outlet Tubes

Sea-based UFOs did not have outlet tubes and could exist in the octave of the optics in which they were noticed. When performing commands (movement), these UFOs used the energy reserve of the 43.5 octave grating,

which is also available in the water. Each sea-based UFO could remove up to 12% of the grating potentials, so their exit was limited. When "flying out" of the water into the atmosphere, a tube was created from a set of frequencies over which the UFO moved with the transformation into additional material structures. The formation of the tubes was accompanied by optical effects and sulfur smell. UFOs moving from the Earth's surface had a ball lightning structure that was transformed into a material structure after the end of the movement, leaving traces of black spots on the Earth by the tubes, changes in the atmosphere (hurricanes), and changes in the density of the atmosphere's grating. As a rule, all UFOs had the property of transition to another optics.

An example of the formation of UFO outlet tubes – Hurricane Katrina (USA) – 8 outlet tubes for the objects 440 – 1, 548 – 1, 346 – 6 exit (all the objects are destroyed). UFOs indexes are conditional. There are photos of the UFOs tubes exit, but the chemical analysis of the atmosphere was not made. Indexing of objects, their characteristics, location are in A. Khatybov's works and they are **NOT PUBLIC** today.

UFOs Movement

Any UFO moves in the Cosmos in the structure of the created grating. This grating has nothing to do with the atmosphere. In a general case, UFOs transport objects of the Moon type (there is everything necessary for this inside the Moon). This is when moving to a distant Cosmos (the distance is more than from the Earth to the Moon). When moving for short distances, a tube is formed, in which, first of all, the medium is created where the objects will be located. Then, in the same tube, conditions are created for moving the object. There are no orbits of Homan here. While moving along the tube, the object changes the octaves of its structure and at the final stage uses the potentials accumulated for the object at this final point. If there is an atmosphere, then in it there forms a grating of a certain saturation, which is used as fuel for UFOs. UFO does not fly twice into one point of the space – there is no fuel. All piloted UFOs have ***their own gravitomagneto-electric generator*** (such as a feed generator in case of an accident).

UFO Pilots

Approximately 66% of UFO's are automatic machines that serve as control systems. Piloted UFOs are objects **DESIGNRD TO PERFORM CERTAIN TASKS**, for example, to destroy the civilization in the north of Africa and get the Sahara desert (the depth of "plowing" and transformation into sand – down to 50 meters). UFO pilots that are not designed to leave the

UFO do not have in their structure such systems as the digestive tract, intestines, and the reproductive system – when converting frequencies, the principle of minimal transformations was observed. For 12 days of the UFOs exit into the atmosphere, all the necessary changes are made. You will never see a spider emerging from a UFO (maximum – a Chinese). If the contours of a man are visible under the spacesuit, this means only one thing: when an the object was landing, a man was captured (his Brain is not needed, only a shirt is taken). The UFO pilot's Brain is inserted into this shirt and goes into flight.

This is **WHERE THE FAIRY TALES ABOUT THE SPACE ORIGIN OF THE HUMAN COME FROM**. Moreover, the appearance does not scare the aborigines, and they take this phenomenon for the divine beginning, hiding everything under the veil of secrecy.

UFO Gemmation

The only structure that moves alone or as part of a group of **6 UFOs are objects 346** (control automatic machines). When you are told that 9 UFOs were observed, and not 6, then you can recall the optical effects when there were 3 Moons or 2 Suns. UFOs of other types move only alone, but for their movement there is a whole staff of UFOs that can not be seen optically – they are escorts, tankers, navigators, "public catering" of reserve structures and so on.

Observance of the frequency balance

None of the frequencies that use UFOs can be obtained by modern technical means on the Earth – they are all derived from prime numbers in the range of 10^{18} - 10^{44} . The frequency has the following properties:

- in the 12th system the end = **BBB**, in the 6th the end of the same number = **555**,
- in the 3rd the end = **222**. In addition, there is always an adjacent = **+ 2**, for example, **17-19**.
- base frequency – activation function, adjacent frequency – shutdown.

All frequencies directed as an action function to the UFO are checked, and if a discrepancy is detected, full protection is activated or the object that tried to act on the UFO (for example, the radar) is eliminated.

Communication

The antenna circuit (around the UFO) is able to have communication within the grating with fuel for the movement. Wherein:

- a UFO computer is used;
- the text length depends on the source (7 sources);
- the maximum text length does not exceed the operational memory of the on-board computer;
- the whole message is divided into 6 grandees (according to the rule of 6 signals in the exact time system);
- at the beginning of the message – the sender's address (from 3 to 12 signs), in the text – the recipient address, therefore, if the text appears, it is perceived by all UFOs computers, and only after determining the recipient the rest of the UFO skip the text;
- a general texts' analysis is made on the base computer of the **Control System of Ireland**;
- In Ireland, the computer center of the UFO Software is located.

Communication – sound signals in the 8th number system (8 tones, note **NA** is added). These signals can be recorded. The code table (8x8) changes every lunar month. If the text of the message is transmitted in the fuel environment and meets all the limitations, it is taken for a normal order.

* * *

Perhaps, what is written in this chapter, is not clear to many readers today. But, nevertheless, the emphasis of this narrative, first of all, was made on logical, i.e. not the most effective way of getting at the meaning of thoughts. Why am I writing and going this way? I just proceed from the fact that my task – through key works, notes and statements of N. Levashov, A. Khatybov and others, through my understanding of ongoing processes – to convey this information (knowledge) to the most number of people. To do this, it should be transformed into the appropriate format, to show how deeply it is necessary to approach understanding the questions that are put before you. Somewhat later I will give a list of questions that have to be answered if you want to understand what **the "SvetL" Programs** are and the physics of these programs. Take my word for it, that there will be no less questions than those from **A. Khatybov**, for example, on water. And do not try to understand by your Heart (whether it will "lie down" on your heart or will not). You can not understand anything with your heart. You can feel with your heart. You can understand **only with your Head** (the Brain, naturally), i.e. logically. But

keep in mind that **IF INFORMATION DOES NOT TRIGGER OFF ANY ACTION**, it means that it has not reached you yet.

In his time, A. Einstein said that *if you are not able to explain your idea to a five-year-old child, then you did not understand it very well*. It is not enough to feel the truth in order to explain the simple. It still needs to be understood. We will strive for this.

Afterword

Do not try to find fault with the author over some trifles. They are inevitable in such a large-scale subject. Do not appraise an architectural structure by the form of its bricks. Appraise it by its form as a whole.

Cognition begins with surprise, and it is a pity that **IN THE FIRST HALF OF ONE'S LIFE THERE IS NOT ENOUGH INTELLECT, AND IN THE SECOND – NOT ENOUGH HEALTH.** By the way, – a couple of lines about health from the Divine story and the factors that affect it. For many of you, it will be fun, but one who gets at the meaning of what has been said will take the next step in understanding the fruitfulness of all abstract deductions not related to any experience or reality.

In the beginning God created the heaven and the earth.

The earth was covered with broccoli, cauliflower, spinach and vegetables – green, yellow and orange – of all kinds, and Adam and Eva had a long and healthy life.

But Satan created ice cream and boubliks with butter.

And Satan asked Adam: "Would you like to try some fatty cheese and a boublik?"

And Adam said: "Yes! I would."

And Eve added: "And me, too! And some pickles! "

And Adam and Eve put on weight. Each – three kilograms.

And God created a living bio-yogurt so that Eve could keep the figure that Adam loved so much.

But Satan created white wheat flour, yeast and cane sugar and mixed them up.

And Eve changed small size for medium.

And God said: "Help yourselves to this green salad from my Garden of Eden!"

And Satan said: "And add some blue cheese sauce, and some garlic bread!"

And Adam and Eve undid their belts after the meal.

And God said: "Here you are, – these green vegetables for a healthy heart and olive oil of cold pressing."

And there put Satan on the table ram's kebab, shaurma in pita and chicken, fried in breadcrumbs, and treated them generously.

And Adam and Eve's cholesterol rose up to the heaven.

And God created potatoes with high content of potassium and other useful ingredients, baked in an oven without oil.

But Satan peeled the potatoes and cut them into thin slices, and fried in plenty of oil, and generously salted, and called them potato chips.

And Adam gained still more in weight. And Eve got covered with pimples.

And God created sneakers for running, and gave them to his children so that they could lose a surplus of weight.

But Satan gave Adam and Eve a cable TV with a remote control, so that they might not strain themselves if they wanted to switch programs.

And they laughed, and cried in front of the flickering screen, and put on comfortable home "workouts" with an elastic band on their bellies.

And God gave Adam and Eve lean meat, diet foods, low-fat sausages, so that they might not gain a lot of calories.

But Satan created McDonald's and a cheeseburger for five dollars.

And Satan said to Adam, "Do you care for some chips?"

"Yes," Adam answered. "A double portion!"

And Adam and Eve got a heart attack.

And God sighed, wiping sweat from his forehead, and created heart bypass surgery.

And there grinned Satan going on the struggle, and... created the Ministry of Health.

Each ending is the beginning of something new. So this afterword is not the end of the narrative. Take it for a transition to a new book in which it will be continued.

Giordano Bruno said to the tribunal of the Inquisition: "***Probably, you are pronouncing the verdict with greater fear than I am***

listening to it." This phrase pierced many people's hearts, shaking their faith in Christ and calling into being their faith in science.

"Even my death will be of benefit to uniting people to fight for their future, where there is no room for lies and meanness..." – said **N. Levashov** before his death. This phrase also pierced the hearts of many people. It has become one of the slogans of the **Russian Scientific and Technical Society ("RSTS")** and of many people who have come to know and understand his works and Technologies.

"A direct proof of the lack of science is the existence of the Church," – said **A. Khatybov**, and this inspired people to think – is there a science?

In this book, willingly or unwillingly I have contrasted my point of view, my hypotheses, my theories based on my Knowledge, obtained from the works of **N. Levashov, A. Khatybov and others**, with the points of view of modern science on the subjects that have been touched upon. I know that the time will come when the **UNDOUBTFULL TRUTHS WILL BE REPLACED WITH OTHERS**. Not in a dispute the truth is born. It is just as simple and short as the statement "In the beginning there was a word". And if to prove it heaps of papers are being filled up, then are not people being alienated from it? Why should the Truth be replaced with a truth and a lie, splitting the whole world by them? How can you divide the world into a dead and alive, useful and harmful? Life is everywhere, in every particle – on the Earth and in the Cosmos. This is what I tried to substantiate and prove when undertaking to continue the unfinished **third volume of N. Levashov's book "The Mirror of My Soul"**. First of all, we have to understand that we are still living in a world of distorting mirrors, where **EVERYONE IS FIGHTING FOR PEACE, NOT KNOWING ITS LAWS!**

The world is one and indivisible. But today it is like a broken mirror. And for many millennia, a man has been picking up its fragments. The society in mirrors, like all in orders, and **until 2012 had been building** another «kingdom of distorting mirrors." These pieces, like a piece of ice in Kay's heart⁶⁶, have turned many people into evil geniuses. And the saddest thing is that they, ice-splinters, prevent Man from seeing the evil that these "geniuses" carry. Existing Science and Religion are the two sides of the mirror of illusions – the "secret order" of controlling the body and soul of

⁶⁶ Hans Christian Andersen – "The Snow Queen" (heroes of the fairy tale – Kai and Gerda).

Man. The love of what kind of Gerda is able to destroy the charms of numerous mirrors? What is behind these charms? Belief! Both in the power of science, and religion, and about this I tried to tell in an intelligible language, **using the works of N. Levashov, A. Khatybov and some of my early publications.** What is the origin of faith?

In science: the belief in the ability of searching for Knowledge through experiment. Perhaps, it might be luck. And luck is rare enough. Much more often they just let genie out of the bottle, and then look for the ways to deal with it.

In religion: the millennial expectation of a miracle – the advent of another prophet, who will awaken Man from sleep and give him knowledge. What for?! They are in Man! And I really want to believe that you have already understood this. Both science and religion drag the society apart to different corners. It is high time for everyone to sit down at a round table and ask each other and, in the first place, themselves: "Am I doing the right thing? Am I going the right way? Who am I: a slave or a Man? "

Time to pick up the pieces is gone. Time has come to sort out monstrous heaps of our delusions and mistakes, **NOT RELYING ON ANYONE'S SUGGESTIONS.** The suggestion is the mortal weapon of laziness. Is it easy to live on a suggestion? Being not responsible for anything, satisfied with the idea that all or almost all live the same way. Laziness made a dead set at Man today, not letting him go for a second, wearing him out, not letting blossom his talents. You can justify exhaustion, but not laziness. It comes out gradually, imperceptibly, from the moment when a child learns to ask stupid questions. When he begins to think that his questions have long been given all the answers. But it would be so simple if he asked these questions to himself and honestly answered them. **But... he has been broken off.** At school, at home, and with the help of television, the Internet and other gadgets, he is constantly drummed that there are smart uncles and aunts, specialists who are not only ready to ask for him, but also answer his questions.

This lesson, as a rule, takes place in childhood, when they get acquainted with the **Tale about Vovka from the Far-away Kingdom,** who gave the tasks "to two of the casket, alike in face". But there are not so many who get at the meaning of it. The same tale was told by N. Levashov at his meetings with his readers. And very few people understood it; I got convinced of it later. So is it worth doing other people's lessons without

mastering your own? Is life an exam for a given topic, so that as a conscientious scholar, correctly, from the point of view of judges from the same casket, answer the questions asked? Is not it easier to ask yourself these questions – just as tricky? It turns out, it's easier. But only what for, if even waiting for the answer is sometimes dangerous? It's easier instead of not solving the problem, not let the problem arise. The situation happens to get out of the control. The solution of the problem is in the absence of an answer. So began the development of the application of the **Technologies "SvetL"**.



If we understand that the information from this book that you have already read, having transformed it into your own Knowledge, destroys the construction basis of your idea of the world around, the construction that had been imposed upon you from your birth, then why do we let this information go around? Why do we tell the passengers of the sinking ship about the impending catastrophe? In the light of what has already been stated, a serious basis is needed for this. The explanation is this: **the captain of a passenger ship** hiding the truth from passengers is right until it works for the benefit of the passengers. If the ship can not be saved there comes another truth – everyone should have a chance for saving. For this, the captain has to inform everyone about the danger. This will cause panic with all the following consequences, but everyone will have a chance for saving. I hope that under the saving the Reader understands not that the church promises us in its canons, but the possibility of integration into the future. If you do not say anything to anyone, no one will have a chance. The truth of the new situation remains the same – the good of the people – but now it binds the captain to inform. Actually, this is exactly what I am doing. It is for you to judge whether I have succeeded or not. For this, I decided to "try" to give you a "spade", with which you could dig and sort out everything. **Well, if after that you will be called to take a BATH ... then my work is not in vain.**

People-Humans! Start thinking with your own Brains; stop listening to other people's explanations, besides being absurd ones! Much will become very clear if you develop yourself correctly. And what was attributed to Gods will become possible for Man! Yes, for Man –

who has risen to the level of creation! You should only go through all the necessary stages of this development, and, as they say, not Gods burn pots!..

I tried to help you in this, but so that you could be genuinely surprised by the result, be fully aware of the possibilities of the **Technologies and "Svetl" Programs** (as much as it is possible today), the physics of the Brain, the physics of Energies and the physics of the Cell, and also about which I did not have time to tell you in this book (about N. Levashov, A. Khatybov's works,

B. Makov and many other things) – I decided to go on writing this book, which will put a full stop in the third volume of **N. Levashov's book "The Mirror of My Soul"**. This is not only my wish; it is also the wish of those many Readers, who I have received a lot of letters from with the request to go on with my narrative. Those are people who have realized that even after reading this book (not to mention the writings of N. Levashov and A. Khatybov as a basis), you can find yourselves in the dressing room of the Bath. And at the end of this book (the part) I want to emphasize some key points that in many respects, **have taken shape of my entire future life**, after my acquaintance with N. Levashov. It goes through my understanding, and I'm ready to confirm my every word.

"In the beginning there appear dreamers, visionaries, crazy ones, dreaming about the future, writing and talking about the unrealizable. Then enthusiasts come and show that the project is feasible. Then come professionals and make a fairy tale happen. But everything begins with a dream". So it happened with the **Technologies and Programs "SvetL"**.

The process of the recreation of Man has already begun, it is not instantaneous and, basically, **CAN NOT BE INITIATED BY MAN**. "Individual opinions", of course, will be considered, but very limited. The old Program is completed, the New one –is with different goals and under new conditions. A new set of Vectors of Goals (future) has been called into being new phenomena, actions and events which are to be realized in a different way within a specified period of time through other Programmed processes of a higher order. Ignorance and the corresponding untimely reaction to the ongoing Program changes will bring the society to the states of catastrophes, especially in the governing circles. The transition period to the beginning of the realization of the stated has already started, and it is very brief. Within the framework of the new Program, the world around us is **RESTORING ITS FORMER STATE** at the structural and energy levels, and it is already

impossible not to see it. The surrounding world will soon complete its changes, and most of the currently existing technologies will not be able to function at all – **THE ENVIRONMENT WILL NOT ALLOW IT**. Both the current technologies and the old societies of anti-social system of the higher-order can not exist in their old essence within the framework of the new Program. They are already being destroyed as a technically and energetically unsupported atavism, since they are not provided within the framework of the new Vectors of Goals in such structural form and forms of being in general with either functions, or territorial determination, or programmed and other support. *"God does not do everything himself, so as not to deprive us of free will and a part of praises due to us"* (Machiavelli).

In place of all the multifaceted, now unrelated to the reality of the societies diversity, there comes the Humanity as a single structure of social organization. The latter has acquired completely different complex functions of a higher level **WITH GRANTED INITIAL COGNITION** of a higher level, capable of moving to a single function of a model harmonious unification in other territorial, spatial and temporal frameworks for the Man being recreated. Think of this! What else can you do to solve this, except by the technologies of N. Levashov and the application of A. Khatybov's calculations? Destructive technologies are being completely replaced with creative technologies. This radically changes the quality of human being, i.e. the mode and the form of being.

Transition to, or rather, the restoration of the Man's Brain at a substantially higher level, the change in the mode and form of being, finding the ability of freedom of reason and action to perform his functions, an entirely different, and not an animal level of the awareness of his destination on the Earth, will qualitatively change the attitude towards each other. The animal functions of territorial and other aggression are being removed from the Brain, the mode of existence isolates from the conditions and possibilities of restoring an individual utmost selfishness, the life span of Man is being prolonged in case of his gaining new qualities of the Brain and its new properties. A Man becomes the Man. First of all, it is a must for everyone, i.e. **THOSE WHO ARE STILL ABLE TO ELEMENTARY LOGIC THINKING**, to realize that it is impossible to revive all this, already non-existent. The world has changed, it is necessary to get ready for the life in a new world. The old skills, technologies, structural and functional systems will not be able to regain the old authority and adjust the functioning of the society and all of its former management system to the new conditions of the

changed environment. The structural forms of the Control of the new System can not support and impart efficacy to everything that was related in any way to the old states or the old System. All this former conditional sufficiency to its manifestation in actions and events is dead, and **NOT BY THE WISH AND WILL OF PEOPLE. *It is dead because of its not being at all.*** It does not exist any longer, and therefore there are no more all those which it had created, supported, controlled and directed. Independently, instead of the old Control System, people will not be able to do anything to support their life existence. They will not be able to bring back to the previous level the entire surrounding world, to bring the energy informational state to the old conditions because all that is alien to our planet Earth, it is getting free of that. A new program has started under the direction and control of the new System, only this System and with its support something can be performed, and people including. Not the last to be mentioned here are the **"SvetL" Technologies**. All that is beyond the actions and scope of the new System is counteraction to those governing processes that are created and provided by it. ***Everything that is taking place beyond the framework of the new Program will be toughly suppressed.***

Cognition does not tolerate fuss, and one has to move forward, checking and verifying each step with the reality. I did it and go on doing it having that rich heritage that N. Levashov, A. Khatybov and others no less worthy Russian Scientists have left to all of us. And I am doing it, being well aware of what kind of situation people are in today. I know that I should help and help with the "SvetL" Programs – to those who consciously made a decision to use them, and not with someone else's suggesting, persuading or taking on trust the potentials of the Programs. I emphasize once again – ***"SvetL" Programs are not "made", like barrels and benches. "SvetL" Programs, like bread, grapes and children, are given birth and nurtured, because it is Living"***.

Content

Foreword	3
Introduction, or the wish in the reality	9
Chapter 1. His checkmate to the System	23
1.1. The image.....	27
1.2. The Start	30
1.3. The Debut	38
1.4. The Quest	48
1.5. The Mittelspiel.....	51
1.6. The Intermediate move	53
1.7. The Splashes.....	67
1.8. The Endshpil	71
1.9. The Postendshpil.....	77
Chapter 2. Physics of the Bath Taking Process	84
2.1. Let's look into the Bath.....	90
2.2. Catalysts in the bath taking process.....	96
Biological catalysts of the active type	97
The active types structures for the Earth	99
Biological catalysts of the passive type	105
2.3. Can they spy and bite in the bath taking process.....	110
2.4. Annihilation of a living cell	111
2.5. Non-sluggishly going processes	111
2.6. Annihilation as the basis of the bath-taking process	113
2.7. Archimedes Spiral	116
2.8. Superposition as a consequence of the bath taking process	120
2.9. Diogenes and his Barrel	123
2.10. The Normalization	127
Chapter 3. Theory and practice in the description of the Object to be taken to the Bath	131
3.1. Is current necessary to "move" to the Bath?	133
3.2. Work on "moving" towards the Bath.	140
3.3. The theory of space for practice in the Bath and a little about the Moon ... (from the fundamentals of celestial mechanics)	141
3.4. About other planets without any preconception	164
3.5. Awareness and understanding	169
3.6. Hair	178
3.7. To wash or not to wash?.....	183
3.8. The error of thinking	185
Chapter 4. Description of the object to be taken to the Bath	188
4.1. Simplified fundamental block-diagram of the Human body functioning.....	189
4.2. Spine and other wonders of Nature	193
4.3. The lungs as one of the spare parts.....	207

4.4. About the Heart's part in the Bath process.....	215
4.5. Blood plasma.....	219
4.6. Paradoxes of blood plasma, or Biological aspects of non-horse	
Science	221
4.7. The skin.....	224
4.8. The skin components.....	227
4.9. The skin derivatives	229
4.10. Skin sensitivity	230
4.11. Kinesthetic sensitivity.....	230
4.12. Splanchnesthetic sensibility.....	231
4.13. The skeleton	232
4.14. Some remarks.....	233
Chapter 5. Correction of the Brain structure before and after	
taking the Bath	237
5.1. For the people from the locomotive	238
5.2. Back to HisTory.....	242
5.3. World perception through the individuals.....	247
5.4. How to get to know?	251
5.5. Developing the subject	253
5.6. The Brain problems	258
5.7. We have no conception of the Brain	267
5.8. The Bound State.....	275
Application	280
Chapter 6. About Reason, Consciousness and Matter, or "how to	
dig with the spade of Knowledge"	287
6.1. Factor	293
6.2. Human Consciousness and Consciousness in General.....	295
6.3. Benzol ring.....	299
6.4. Space, as a characteristic of Consciousness structures.....	301
6.5. Energy conservation	308
6.6. Discreteness and structurability of Matter	313
6.7. Consciousness Perfection.....	316
6.8. Dimensionality.....	318
6.9. To the question of "fields"	320
6.10. Health Improving and Transformation	332
Chapter 7. Variations in Reflections	337
7.1. The Base of Consciousness	338
7.2. Everything is solvable... ..	340
7.3. For those who are eager to take the Bath.....	347
7.4. Saturation for the achievement.....	352
7.5. Why it is not allowed and what is permitted by now	362
7.6. The Noosphere – what one should know.....	369
7.7. The informational Support Symbolism	374
7.8. Confirmation in Reflections.....	381
7.9. The Concept of New World Outlook	388

7.10. Some words about UFOs which are talked so much about	392
Afterword	402

BERSERKER

BOOKS

