

Ruckers. A Harpsichord and Virginal Building Tradition

Volume II



Chapter 7 - The Decoration of Ruckers Instruments

The decoration of a Ruckers instrument produces a visual effect that is as rich as the aural. The case exterior was painted, either with a rather simple imitation marble or with an imitation iron strap-work held in place with brass studs and containing large semi-precious stones against a marbled background. Many of the interior surfaces of the instruments such as the soundwell and keywell were decorated with block-printed papers, and the interior of the lid, if it was not also ornamented with paper patterns and Latin mottoes, was painted in oils, often by one of the great Flemish artists of the day. The soundboard and wrestplank were decorated with paintings of flowers, birds, insects, scampi and occasionally with a small scene depicting human or animal figures. The soundboard has as its focus the gilded rose surrounded by a floral wreath painted on the soundboard. This rose, along with the date painted on the soundboard or wrestplank, identified the maker and the time at which the instrument was built. The case sides, the tops of the keyblocks, the jackrail, and the keyboard and lid battens were decorated with varnished ogee, ovolo or composite mouldings which were sometimes partly painted over with red or black lines, and the keyfronts were decorated with Gothic arcades in paper and parchment.

Flemish printed papers

Only the first two Ruckers instruments, the double



Photo 7-1 A modern spinett virginal (copied from the (c1600) HR) made by the author showing the style of Ruckers decoration. The stand is copied from that of the 1650 IC muselar virginal.



Photo 7-2 A modern copy of a 'French' double-manual harpsichord made by the author showing the style of the Ruckers decoration. The stand is copied from that of the 1620c AR double-manual harpsichord.

virginal of 1581 and the 4-voet virginal of 1583 by Hans Ruckers have original painted decorations in the soundwell and keywell. All subsequent instruments are (or show signs of originally having been) decorated with block-printed paper patterns. The painted decorations are very similar in style to the more common paper patterns. In the soundwell the designs are in only two colours - the background colour plus the white painted design. In the keywell more colours are used and produce a striking effect. Also a feature of these first two virginals are the pairs of medallions on the nameboard with effigies of the Spanish royalty and aristocracy. The cost of these painted instruments must have been high, and clearly in an effort to reduce their cost the later instruments were decorated with the inexpensive paper patterns.

The decorative paper patterns used by the Ruckers family, and probably by most of the instrument makers in the Guild of St. Luke, are printed from wood-blocks and are usually in the shape of long strips. These strips were joined end to end to form a continuous pattern which covered most of the interior surfaces of the instrument except for the lid, if this was painted, and the soundboard.

The paper itself onto which the patterns were printed is made by hand one sheet at a time. The raw material consists of linen and cotton rags beaten and mixed with water. The pulp mixture is brought into a vat where it is kept in a state of agitation to ensure even mixing by a kind of paddle or hog. The paper-maker or vat man



Photo 7-3 The 1581 HR muselar and child double virginals. The decorations are all hand-painted on this instrument, and no use is made of the block-printed paper patterns.

picks up a layer of the pulp on a mould consisting of a mesh of fine parallel wires tightly stretched or 'laid' between the sides of a wooden frame. The wires of the mould are close enough together to retain the fibres on the upper surface, and far enough apart to allow the water to drain away. It is these wires with the occasional transverse chain wires, onto which the pulp collects more or less unevenly, that produces the characteristic ribbed texture of hand-made paper.

The layer of pulp is removed from the mould onto a felt cloth. The resulting sheet of paper is covered by another sheet of felt, until a pile consisting of alternate layers of paper and felt is formed. This is then pressed in a screw press in a series of operations, first of all with the felts and later with them removed, to squeeze out all excess water and to give the surface of the sheets the required finish. The paper was then sized with one of various sorts of fillers according to the purpose to which it was going to be put, and hung and allowed to dry.

The paper produced by this method and used by the Flemish builders is of an extremely fine quality without any coarse fibres and with little surface texture. It is quite strongly sized so that the ink does not bleed into the paper. The thickness of the paper which they used is about 0.085 mm to 0.12 mm thick with a weight of about 60 to 70 gm/m².

The exact type of ink used to print these papers is not known. However, the standard ink used during this

period consisted of lampblack or powdered charcoal ground in a linseed varnish. The fact that boiled linseed oil made a good varnish of good binding and drying properties was known to Flemish painters in the 15th century, and paints based on it were used during this period for inking wooden printing blocks. It seems almost certain that the papers were printed in a press, as press printing had superseded manual rubbing of the blocks or type as early as 1440, and since the linseed varnish inks were used for letter-press it is likely they were also used to print the blocks.

The patterns were cut into the surface of a plank sawn pieces of hard, even-textured wood. Blocks dating from the period in which the Ruckers were active in the Plantin-Moretus Museum Collection in Antwerp are made of pear, apple, cherry and box. The blocks are thus woodcuts where a piece of wood is cut plankwise, with the knife pulled toward the cutter. A wood engraving which was a later development is done on end-grain boxwood using a graver pushed away from the worker. During printing the part of the block cut away is not inked, and the pattern printed results from ink transferred from the uncut flat sections of the block onto the paper. Obviously the patterns consisting of a black background with the pattern in white were quicker to cut than the corresponding negative pattern since less wood had to be cut away, and this may explain the rather large numbers of this type of 'black' pattern.

The wood-block pattern books

Many of the patterns used by the Ruckers family were taken from Renaissance pattern books which were printed expressly for the use of decorators, gold-smiths and silver-smiths, embroiderers, lace-makers, etc. Two of the books used as a source of these patterns are by the Renaissance artists Francesco Pellegrino and Balthasar Sylvius. The patterns in these books are wonderfully inventive and exhibit a great beauty of form and design. They are based on Arabic and Moorish art and make use of stylised vines, leaves, ribbons and bands interlaced together sometimes in the form of knots or geometrical patterns and sometimes as exotic arabesques.

La Fleur de la Science de Pourtraicture is one of the sourcebooks of the Flemish paper patterns, and is signed Francisque Pellegrin (as Pellegrino would have been known in France) and was printed in Paris in 1530⁷⁻¹) I have discovered this to be the source of at least four of the Ruckers printed paper patterns. This book, along with two similar books by Peter Quentel and Giovanni Tagliente both printed in 1527, was among the first to be printed which introduced the elements of Moorish and Arabic design into Western art in a way that was grammatically correct and yet thoroughly confident and inventive. Pellegrine was a Florentine who, along with Benvenuto Cellini and Rosso Fiorentino, came to work on the Chateau de Fontainebleau from 1534 to 1536 for the enlightened King François 1^{er}. The great King's Gallery at Fontainebleau is one of their

finest achievements and a major contribution to the rapidly developing Renaissance style. Rosso Fiorentino originated the heavy strapwork borders surrounding the paintings in the King's Gallery, and these contrast markedly with the light airy arabesques of Pellegrino (see p. 411). Pellegrino died about 1552.

The second source book used for the paper patterns is by Balthasar Sylvius. Three Ruckers patterns were discovered in this book in 1939 by Scheuleer,⁷⁻²⁾ but in fact it is the source of at least 12 complete patterns, and the border patterns of 4 others. The book was published in Antwerp in 1554 under the title Variarum protractionum quas vulgo Maurusias vocant.... Sylvius was born in 1518 in s'Hertogenbosch in what is now Southern Holland. He was already living in Antwerp in 1543, and he is inscribed in the ledgers of the Guild of St. Luke under the name 'Balten Bos' as a journeyman copersnyder in 1551, the same year as Peeter Brueghel, the Peasant Brueghel, became a master. This was the time of the 'Golden Age' in Antwerp, when there was a flourishing trade in the new port in all sorts of articles, such as decorated cups, plates, vases, goblets, boxes, knife sheaths, as well as lace, embroidery, trimmings, braids, etc. Obviously a book such as this would find a ready market and its patterns put to a multitude of uses in such an artistic atmosphere.

One of the great beauties of the patterns in these books is their great freedom of rhythm. The major factor

contributing to this is that none of the designs is completely symmetrical. The basic outlines of most of the patterns give the appearance of being symmetrical, but slight unobtrusive asymmetries avoid the mechanical solidity and stiffness of a completely symmetrical pattern.

Because of the asymmetries in the patterns it is possible to tell that some of the patterns have suffered a mirror reversal in being copied from the pattern books, and some have not. The mirror reversal occurred by glueing the original pattern face uppermost onto the wood block and cutting the pattern through the paper into the wood. After cutting, the original paper is removed using warm water to dissolve the glue holding the paper to the wood. The prints produced from the resulting block are then all mirror images of the original. The prints without the mirror reversal are produced by glueing the original pattern with its printed face toward the surface of the block itself. If the paper on the block is then dampened slightly, the paper can be carefully rubbed off leaving only the inked pattern and the surface fibres of the paper glued to the block. In this way the pattern becomes clearly visible for cutting. The glue is again dissolved after the cutting is completed and the printed pattern produced from the resulting block is an almost exact duplicate of the original. Most of the patterns used by the Ruckers have been copied in this way, without the mirror reversal.

Catalogue of the Flemish paper patterns found on
Ruckers instruments

Most of the patterns used by the Ruckers family are to be found either in the Pelligrino or Sylvius pattern books. Although I have made an exhaustive search of the large European libraries no other pattern books have been found with any of the Ruckers patterns in them. The stylistic similarity of many of the Flemish patterns not found in the Pellegrino and Sylvius books, does seem to indicate that yet another pattern book was used to get many of the remaining Flemish designs, and that this book has now disappeared. A few of the designs are quite unlike any of the others and may have come from yet other pattern books, or may have been made up by the wood-block cutter without reference to already published patterns.

The origin of the dolphin pattern, Type 12 and 13 below, is particularly intriguing. Although I have found the dolphin motif as a constant feature of Renaissance ornament and of many of the pattern books that I examined, none was identical or even very similar to those found on Flemish instruments. With such a traditional design, it seems highly improbable that the exact origin of this version of it can be located. This dolphin pattern is painted in the keywell of the Ioannes Grauwels' virginal (c. 1570), No. 2929, in the Brussels Museum of Musical Instruments, and this along with the other painted decoration on the instrument seems to be original. A number of paintings and engravings⁷⁻³⁾ as early as 1548 shows this

traditional dolphin motif. And the Ioës Karest virginal of 1550 in Rome,⁷⁻⁴⁾ is painted with a mannerist grotesque design very similar to the dolphin pattern. The dolphin pattern was thus a traditional design used by the Flemish instrument makers, the paper pattern being a cheaper version of the painted one.

It seems that the pattern Type 14 below was also one of the traditional patterns of the St. Luke builders. A similar pattern is painted on the faceboard and keywell of the Lodewijck Grauwels virginal dated 1600 (and made in Middelburg shortly after Grauwels had emigrated there from Antwerp) in the Crosby Brown Collection of the Metropolitan Museum, New York, as well as appearing as a paper pattern on several Flemish instruments.

The Hans Bos virginal in the Monastery of Santa Clara in Tordesillas, Spain, in addition to having the two patterns mentioned above, Types 12 and 14, also has another pattern, Type 27, which provides an interesting clue to the origin of these papers. This pattern appears on only one Ruckers harpsichord (1640b IR) and that an instrument probably 60 years later than the Bos virginal. The fact that the patterns used by two quite independent builders at totally different times have a common pattern book as origin, suggests that probably all of the guild members bought their papers from a common source. Further, the fact that the paper Type 15/29 uses patterns taken from both the Pellegrino and the Sylvius books, points to there being but one person making the blocks and utiliz-

ing both sources. Doubtless also a member of the Guild of St. Luke, this person cut and printed a number of patterns, some traditional and some taken from pattern books, and supplied them to all the instrument builders working in Antwerp.

Another interesting pattern used by the Ruckers family is the imitation wood grain pattern Type 16, which is clearly not the type of pattern that would be found in a pattern book. I have discovered a version of this pattern in the so-called 'Winkelriedhaus' from Stans in Switzerland. The coffered ceiling of the banqueting hall from the second floor of this house is now in the Schweizerisches Landesmuseum, Zurich and it is dated about 1563. Similar, but not identical papers have been found by Dr. Horst Appuhn of Schloss Cappenberg, in the rooms in Kloster Isenhagen and Kloster Weinhausen, and in a number of 16th century German letter-safes.⁷⁻⁵⁾ In all of these the paper pattern is meant to imitate the wood grain of plank-sawn figured ash (usually call Hungarian ash). Panelling on walls and ceilings, cupboards and wardrobes was often of figured plank-sawn ash, often with the larger flat surfaces inlaid with intarsia arabesques, and was very common and fashionable during the high Renaissance. The surprising thing in the Winkelried ceiling is that the coffered areas with the imitation wood-grain papers are boldly set against genuine figured ash panels in the framing!

The Winkelried ceiling contains two very similar

wood-grain papers (see Photo 7-4). The first of these is very similar to the earliest example of the wood-grain paper to be found on a Ruckers instrument, the 1591a HR virginals (unfortunately the figured wood pattern is barely visible on this instrument, but the same pattern is also found on the 1598 HR virginal (see Photo 7-5)). The difference between the earlier Winkelried pattern and that on the 1598 HR, is that they are mirror images of one another, and the 1598 pattern contains much more detail than the earlier one. Both patterns have a cleverly designed edge symmetry with an axis along the centre of the long direction of the paper, so that if the papers are glued in place such that each successive paper is rotated 180° to the preceding one, the wood-graining matches at the join in the two papers. Also the upper and lower surfaces of the papers are also ingeniously designed so that, if the papers are placed directly one above the other, the wood-grain pattern of one paper matches the next, flowing without an apparent break from paper to paper. The repetition cycle of the papers is thus so large that one repetition cycle covers almost the whole of a harpsichord lid and the eye is easily deceived into believing that, as with natural wood, the wood-grain pattern does not repeat at all.

It seems fairly certain that the 1598 HR pattern was cut from the earlier Winkelried pattern simply by taking a sheet of the Winkelried paper and glueing it to a block, and enhancing the detail somewhat. A careful comparison reveals that the elements of the two patterns are ident-

ical in arrangement and form except for the mirror reversal difference that exists between the block itself and the print produced from it. Similarly, the 1598 wood-grain pattern and all of the subsequent wood-grain patterns (see Photo 7-6) differ by the same mirror reversal, produced by a second similar re-cutting of the pattern. These three wood-grain patterns thus represent three generations of woodcuts spanning the period from the Winklereid ceiling in 1563, to 1651 when the last Ruckers instrument which still has this pattern was built⁷⁻⁶).

The first two patterns (Photos 7-4 & 7-5) are used in a way which clearly imitates wood. The pigment used to print the pattern, although now greatly darkened, seems to have been natural Italian Sienna, and the original effect, against the background of the off-white paper, must have been very similar to the appearance of the grained figure in the natural ash wood. All blocks of this pattern printed after 1598, however, are a light olive green, probably using terre verte (green earth) as pigment. This green pattern clearly cannot any longer have been meant to imitate wood-grain. Either the Ruckers simply liked the effect produced by the shimmering green pattern, or more likely, it was meant to imitate watered silk or camlet which were popular as early as the beginning of the 16th century, and became very fashionable in the first half of the 17th century. However, despite the more common later use of this paper printed in green to imitate silk, I have chosen to call this the wood-grain paper be-

(Captions for the photographs on the following page.)

Photo 7-4 The wood-grain paper (c1560) from the Winkle-
reid house, Stans, Switzerland.

Photo 7-5 The wood-grain paper from the 1598 HR spinett
virginal.

Photo 7-6 The wood-grain paper from the 1627 AR harpsi-
chord. This pattern, unlike the two above
which are brown, was printed with green ink
and used after 1623.

Scale 1:4 in all photographs

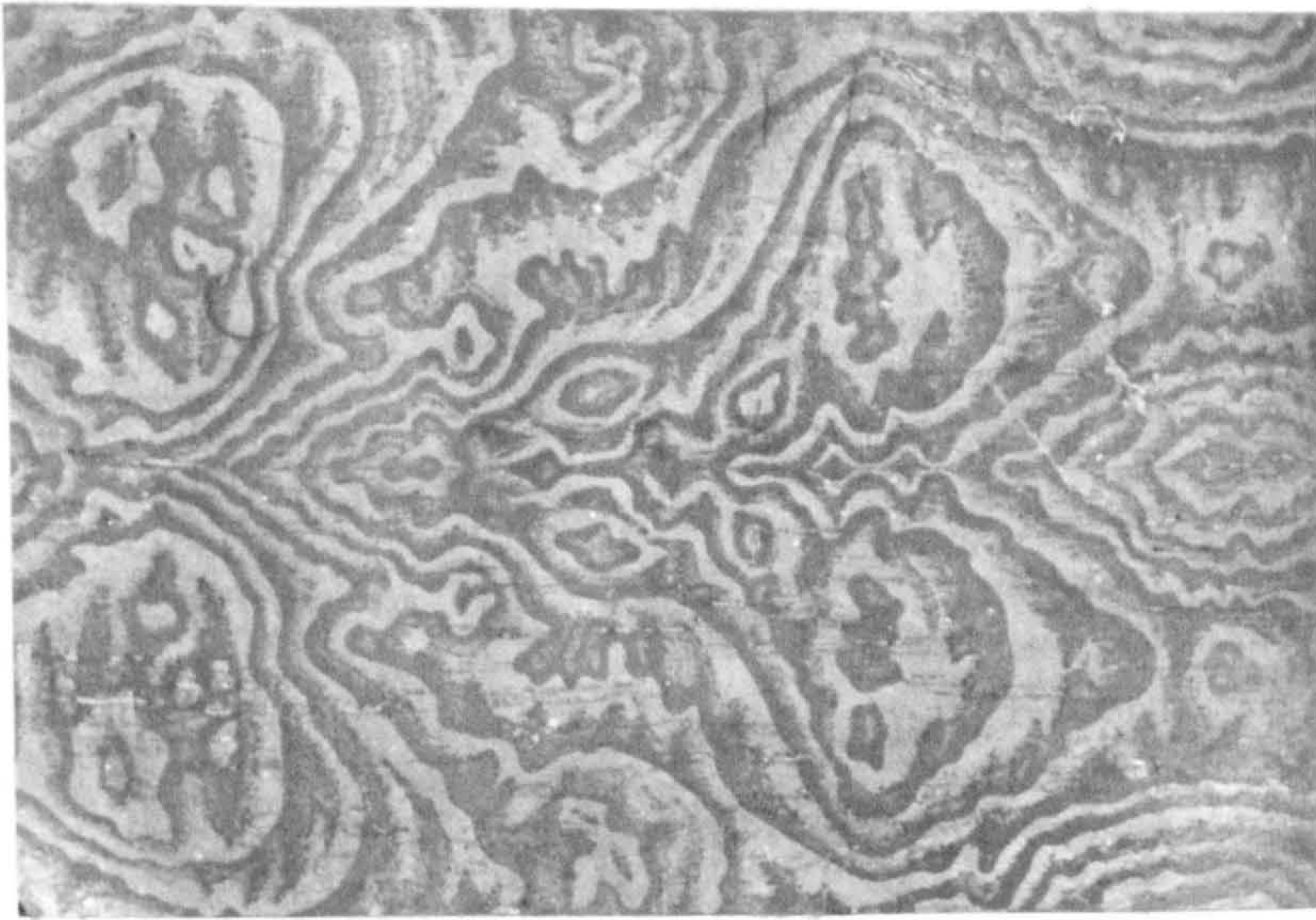

Photo 7-4



Photo 7-5

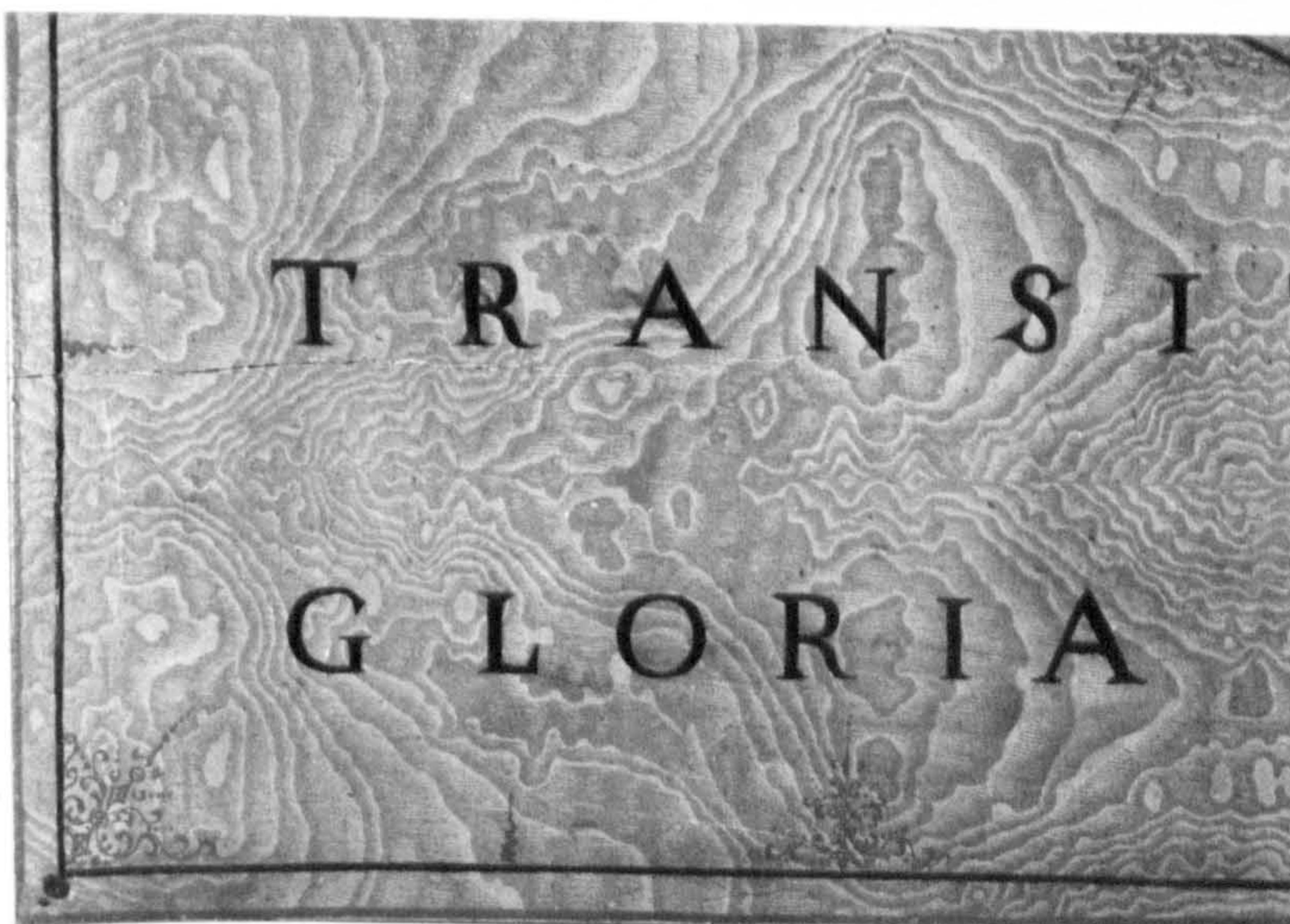

Photo 7-6

cause this expresses its original purpose.

The block-printed papers, in addition to being used inside the main lid, lid flap and keywell flap were put to a number of other uses. As has already been mentioned the keywell flap was decorated with one of the wide paper patterns. In the large virginals and single-manual harpsichords this is often one of the dolphin patterns. The dolphin pattern was however not used in the keywell on double-manual harpsichords or on the smaller virginals. The most common patterns found in double-manual harpsichord keywells are Type 12 in Andreas instruments, and 21 or 22 in the Ioannes doubles. These patterns fit quite well onto the narrow nameboard, and on the spine and cheek part of the keywell the papers are placed side by side with the rope or chain edging removed so that only the central portion of the paper is used. The smaller virginals which have narrower case sides use one of the narrower patterns such as Type 12 in the keywell and on the faceboard.

In the child virginals the whole of the outer case is covered in a paper pattern and Types 5 or 12 are often used. An interesting variant is the child part of the 1610 HR double virginal in Brussels which has two strip patterns still joined together. Paper Types 24 and 28 are both taken from Sylvius where they occur together on the same page one above the other. And this is the way they appear on the virginal (see Photo 7-7). Clearly when the pattern was taken from the Sylvius book, the page was

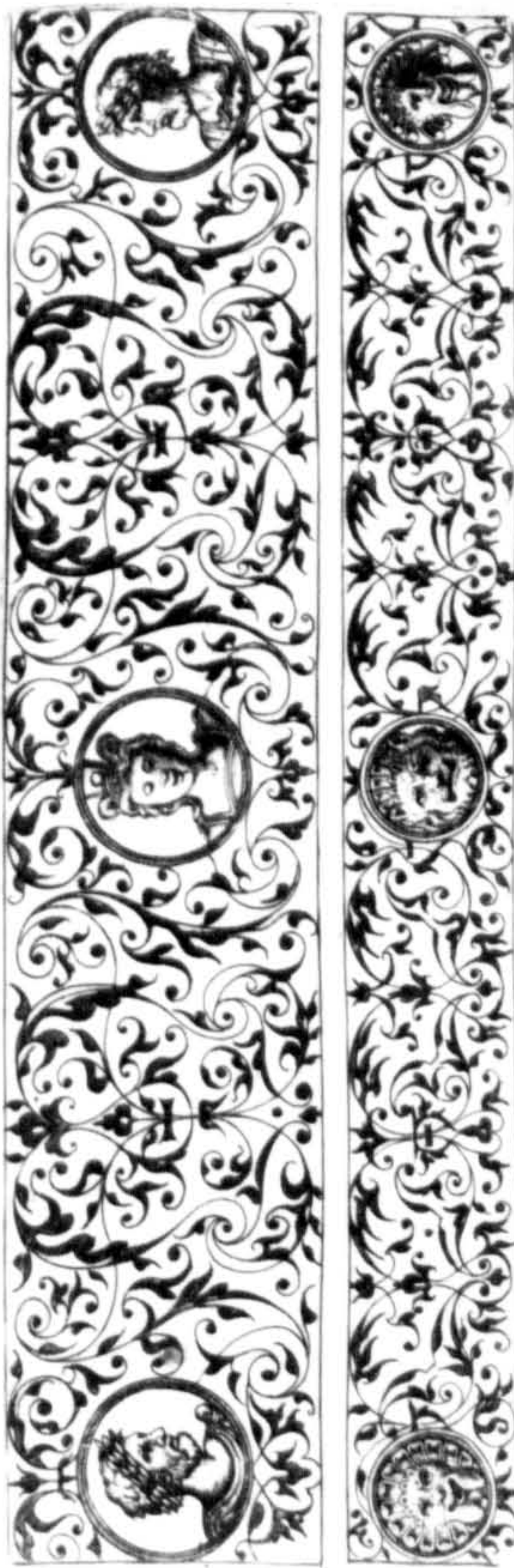

Photo 7-7 Original engraved pattern from the book by Balthasar Sylvius (1554) (above), and the block-printed pattern found on the 1610 HR child virginal (below).

Scale 1:2

left as it was and glued face down to the block. The extra leafy arabesque designs were added on either side, probably by cutting them from a second copy of the Sylvius pattern book, since the added arabesques are slightly different from one another although each is identical to one of the internal arabesques of the pattern.

The narrow strip patterns are used to decorate the soundwell on the interior case sides above the soundboard. One of the most commonly occurring soundwell patterns is the Pellegrino pattern Type 13. In the large 6- and 5-voet virginals the faceboard and keywell are lower than the case sides and a narrower strip pattern has to be used on this part of the soundwell than on the spine and sides of the instrument. Thus for these instruments two different papers are used in the soundwell.

The harpsichord jackrails are also decorated with paper patterns (the virginal jackrails bear the maker's signature and are therefore not papered). The double manual jackrails are wider than those on the single manual harpsichords and strip patterns of the appropriate width are chosen to suit. The lower manual batten on double manual harpsichords is papered, and often the top of the lid on the virginal toolbox and the top of the block at the bass end of the upper manual keyboard in double-manual harpsichords are covered with a section of one of the paper patterns. Although the keyblocks (only the lower manual keyblock in doubles) usually have a design painted on them in Ioannes Ruckers harpsichords, the keyblocks are often
 (the main text continues on p. 417)

Types of Flemish block-printed paper patterns

Each of the paper patterns and each of the original designs as printed in the books by Sylvius or Pellegrino are here reduced in size by a factor of 2:5. It will be noticed for those patterns which have been taken from one of these source books that the pattern found on the instrument is slightly larger than the original. The probable reason for this is that when the original pattern was cut it was first glued to the wood block with a water-soluble glue (such as hide glue). The water in the glue would expand the paper slightly as it was glued in place so that the wood-block design was slightly larger than the original. The same enlargement would again occur when the printed pattern was glued to the instrument. Thus the paper patterns as found on the instruments are larger than the originals as a result of two expansions caused by the use of water-soluble glue.

Type 1

Early type

Found on: 1591a HR, 1598 HR

(Illustration on next page)

Late type

Found on: 1623 IR, 1628a IR, 1629 IR
 1637b IR, 1638a IR, 1640a IR, 1642a IR,
 1615 AR, 1618 AR, 1620a AR 1624 AR,
 1627 AR, 1632 AR, 1633a AR, 1635 AR,
 1637 AR, 1640a AR, 1644a AR, 1648 AR,
 (1651)a AR, 1654 AR

(Illustration on next page)

Type 1 Early type



Type 1 Late type



Type 2

Found on: (c1600) HR, 1642a IR,
1620a AR, 1643a AR

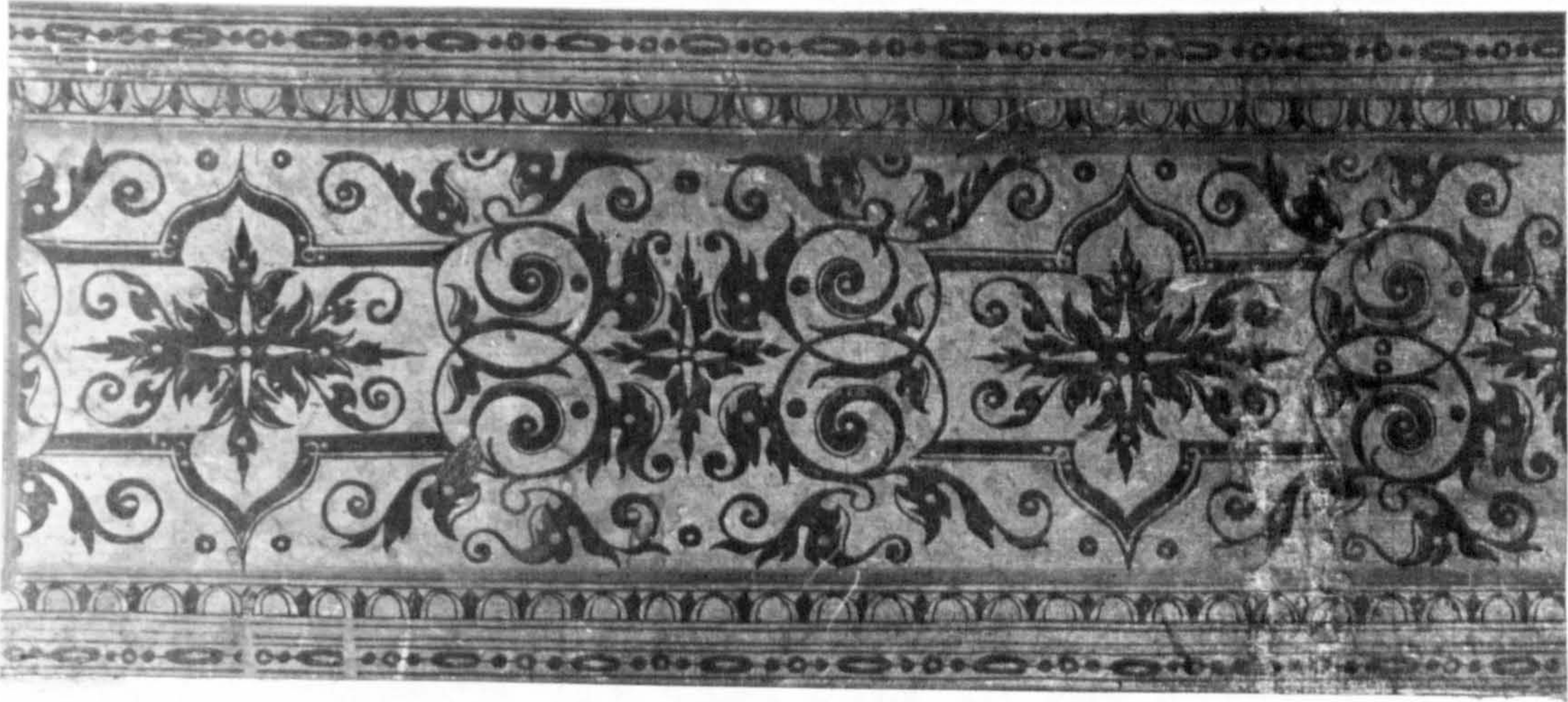

This pattern is usually used on the front flap or, using only a half of the pattern, it is sometimes used to decorate the lid of the virginal toolboxes. It is also used on the 'C. R.' virginal in Namur, and the Iohannes Bos virginal in Tordesillas, Spain.

Type 3

Early type

Found on: 1591a HR, 1594 HR, 1598 HR,
1611 IR, 1640a AR, 1640b AR



Type 3 Late type Found on: 1640a IR, 1637 AR, 1648 AR,
(1651)a AR



These two patterns are used only in the keywell and on the faceboard. The late type is a mirror reversal of the early type. The early type also occurs on the 'C.R.' virginal in Namur, and on the Iohannes Bos virginal in Tordesillas, Spain.

Type 4 Found on: (c1600) HR, 1623 IR,
1644a AR, 1645 IC



Like the later version of Type 3, this pattern is a mirror reversal of the early Type 3. It is also used only on the keywell and faceboard.

Type 5

Found on: (c1600) HR, 1639 IR

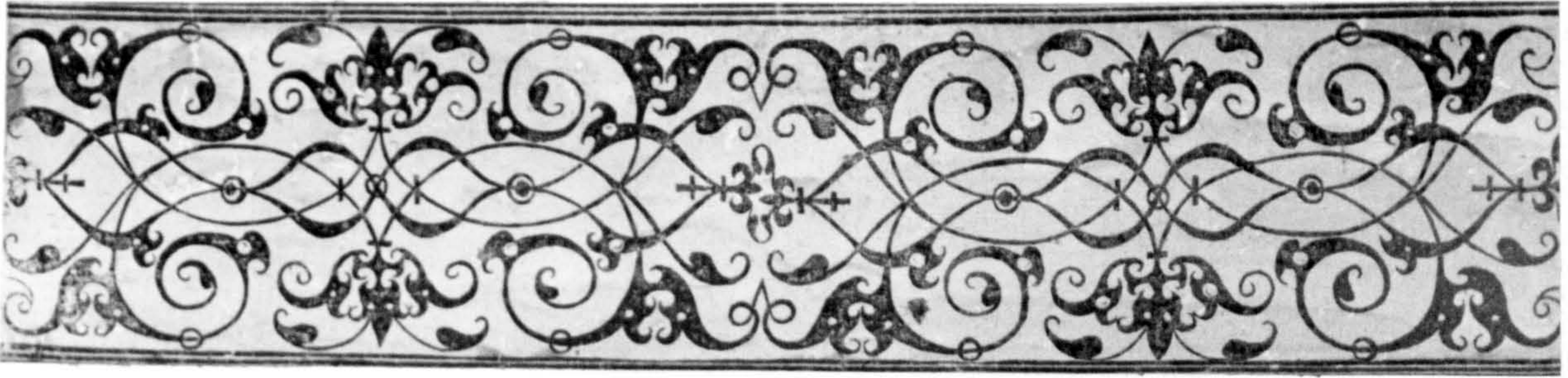

This pattern is painted on the keywell of the 1639 IR instrument, but it was almost certainly used originally as a paper, and then later painted in when the paper became damaged and was removed.

Type 6

Found on: 1642a IR, 1608 AR, 1643a AR, 1644a AR, 1648 AR, 1654 AR

Type 7

Found on: 1633a AR

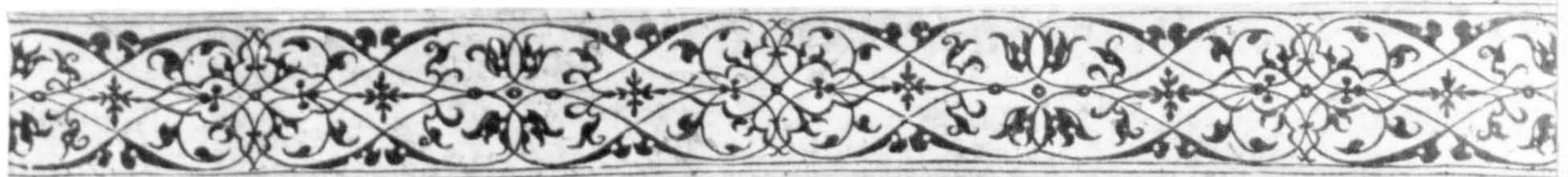
Type 8

Found on: 1591a HR, 1598 HR, 1629 IR, 1642a IR, 1618 AR, 1620a AR, 1637 AR, 1640a AR



There are practically no two versions of this pattern which are exactly the same. It seems to have been printed from a number of different blocks.

Type 9

Found on: 1618a IR, 1638a IR, 1613c AR,
1620d AR, (1626) AR, (1651)a AR



Without the two narrow border strips, this pattern is often used in the soundwell of the child virginals. As a border pattern to Type 1 it is used both with, and without its own narrow border strips.

Type 10

Found on: 1623 IR, 1640a IR, 1620d AR,
1624 AR, 1632 AR, 1635 AR, 1637 AR,
1654 AR

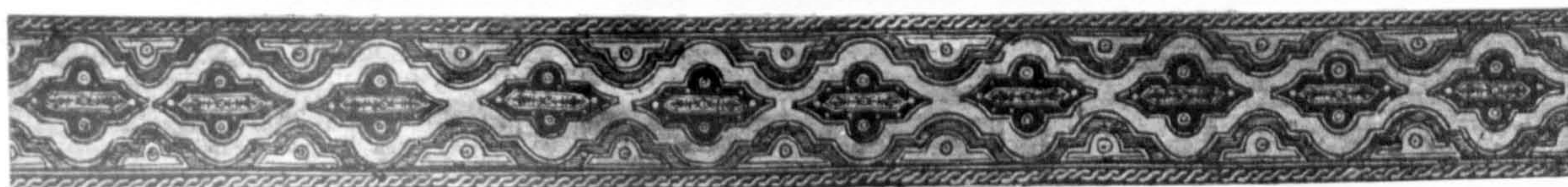

A similar pattern, cut from an entirely different block, is to be found on the 1605 Gheerdinck virginal, in the Germanisches Nationalmuseum, Nuremberg.

Type 11

Found on: 1598 HR

Type 12

Found on: 1599 HR, 1611 HR, 1618a IR,
1623 IR, 1640a IR, 1642a IR, 1610b AR,
1613b AR, 1613c AR, 1615 AR, 1620a AR,
(1626) AR, 1627 AR, 1643a AR, 1644b AR

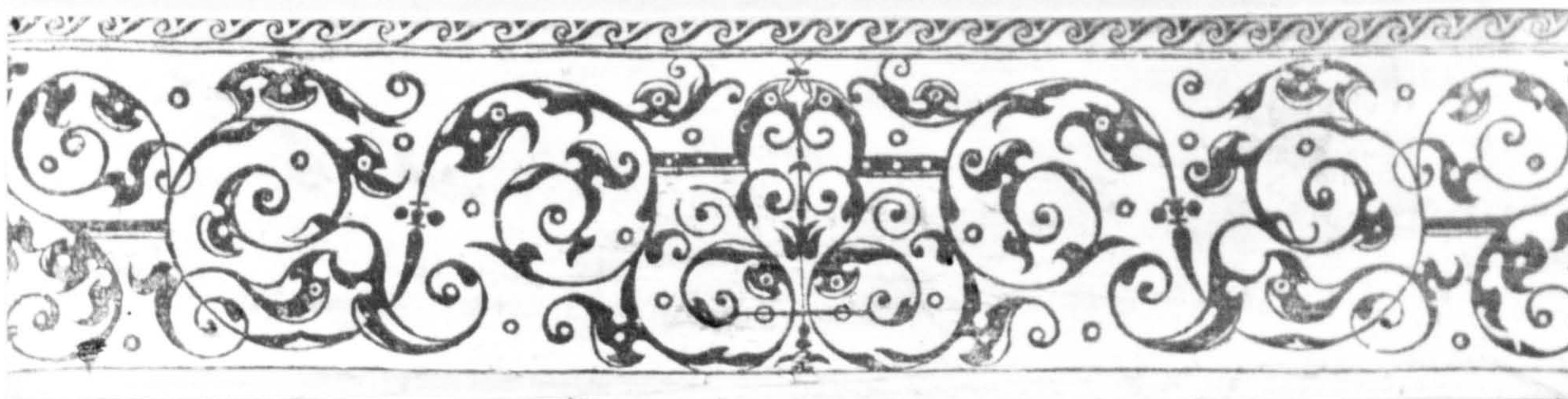

Type 13

Found on: (c1600) HR, 1599HR, 1609 AR,
1610b AR, 1615 AR, 1633b AR, 1635 AR,
1636 AR, 1637 AR, 1640b AR, 1644a AR,
(1651)a AR



Source: Francesco Pellegrino, 1530



This is by far the most commonly used soundwell paper.

Type 14

Found on: 1624 IR

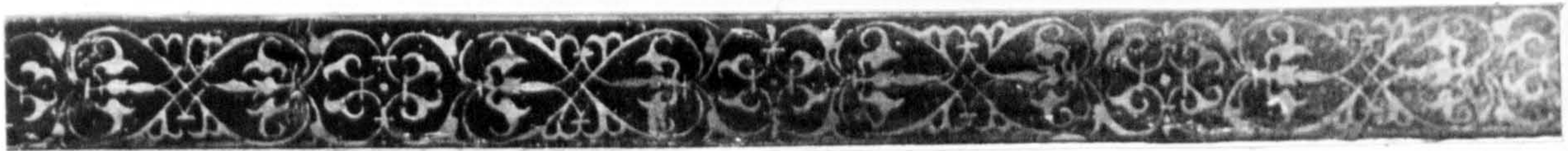

Source: Francesco Pellegrino, 1530. This is clearly the negative of the Type 13 paper above.

Type 15

Found on: 1598 HR

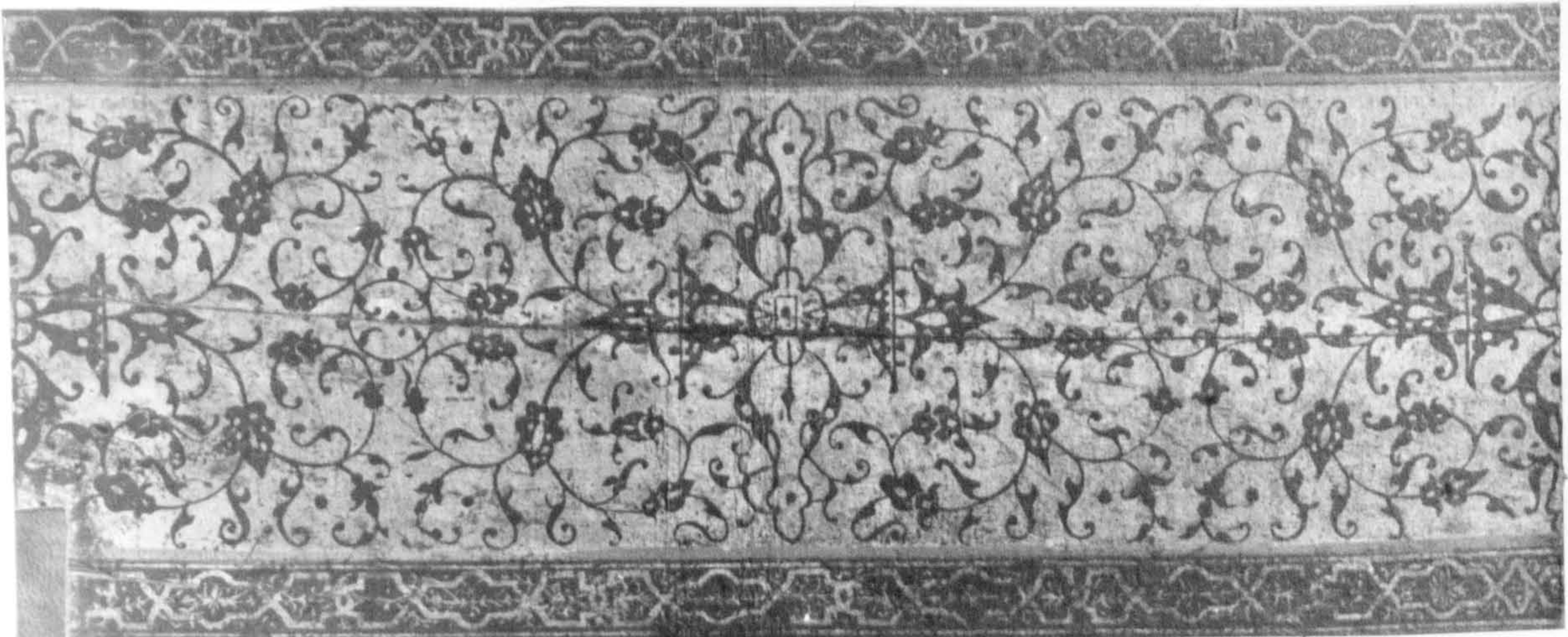

Source: Francesco Pellegrino, 1530, the central pattern only. The top and bottom border patterns are Type 30 (see below).

Type 15 (cont'd)

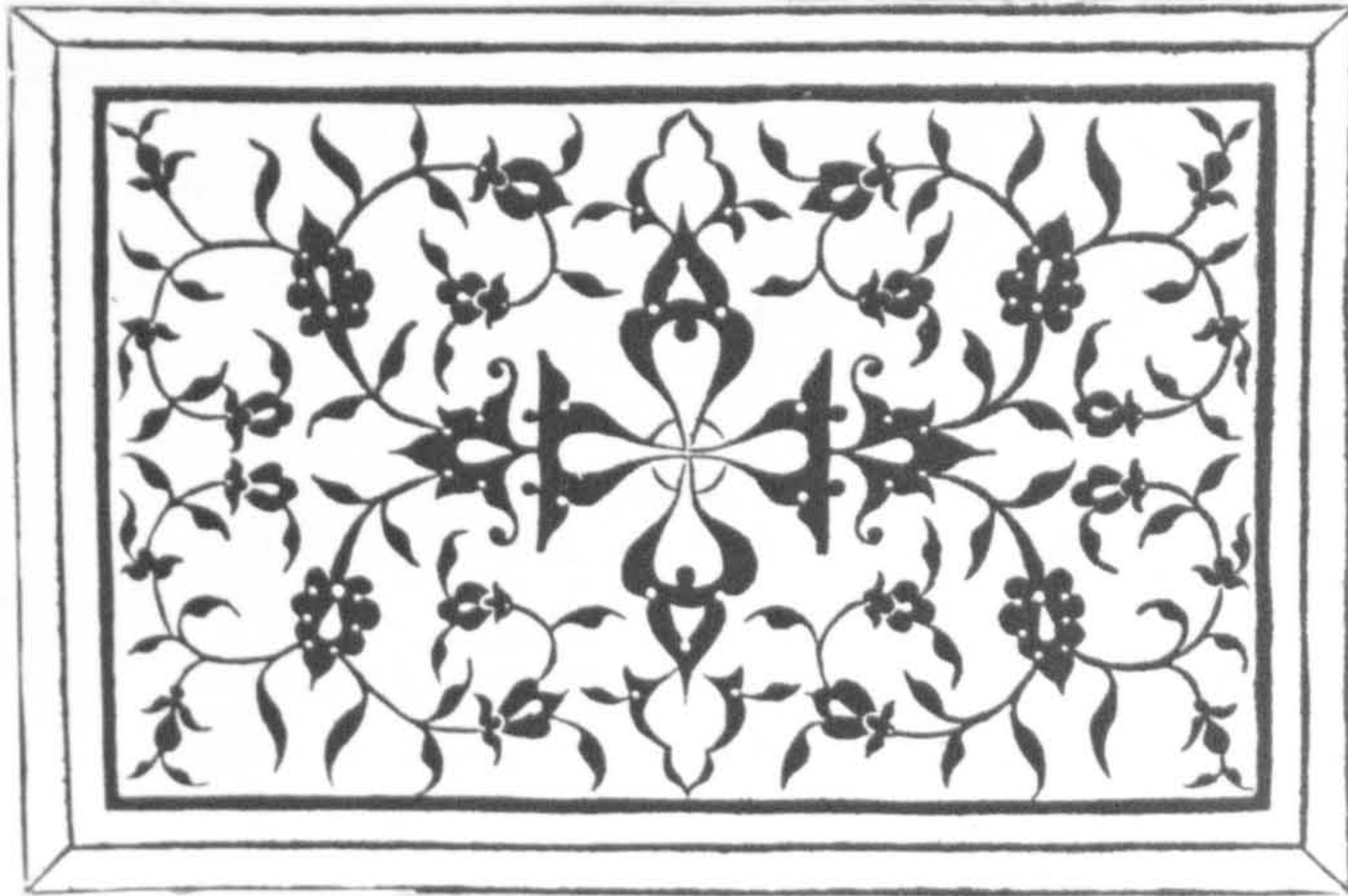

Type 16

Found on: 1640b IR



Source: Francesco Pellegrino, 1530



This paper is also found in the soundwell of the Iohannes Bos virginal in Tordesillas, Spain.

Type 17

Found on: 1598 HR, 1617 IR, 1640a IR,
1642a IR, 1620a AR, 1620d AR, 1624 AR,
1648 AR



Source: Balthasar Sylvius, 1554.



This pattern was obviously enlarged and re-drawn before being cut as a woodblock.

Type 18

Found on: (c1600) HR, 1618b IR, 1640a AR



Source: Balthasar Sylvius, 1554.

Type 19

Found on: 1611 HR, 1634 AR

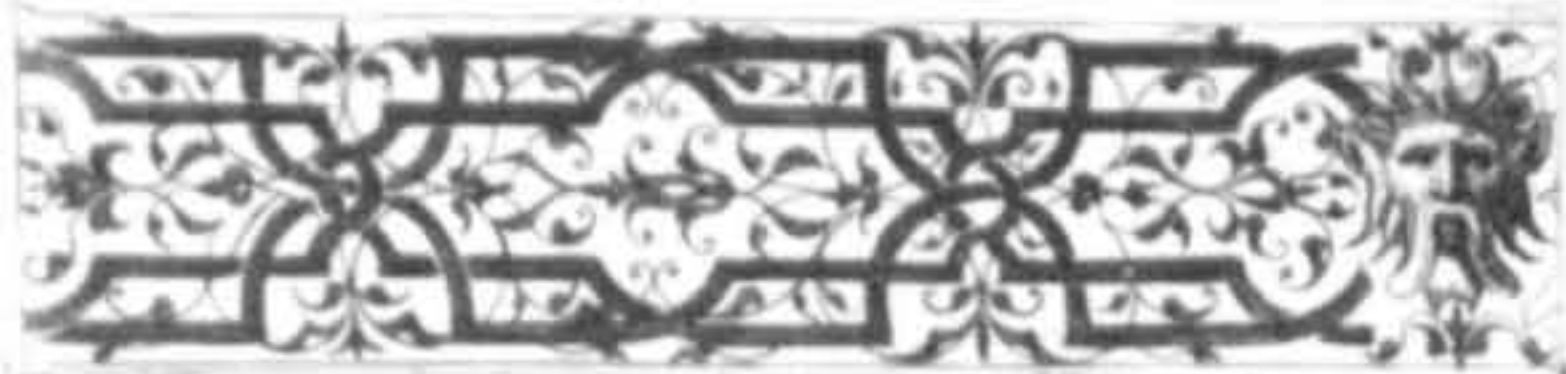

Source: Balthasar Sylvius, 1554.

Type 20

Found on: 1628b IR, 1637b IR



Source: Balthasar Sylvius, 1554.

Type 21Found on: 1618b IR, 1624 IR, 1627b IR,
1628b IR, 1637b IR, 1638b IR

Type 21. Source Balthasar Sylvius, 1554.



This pattern seems to have been used only by Ioannes Ruckers in the keywell of his double-manual harpsichords.

Type 22

Found on: 1640b IR, 1635 AR



Source: Balthasar Sylvius, 1554.

No complete version of this paper is known to exist, but it is clearly the negative of Type 21.

Type 23

Found on: (c1600) HR, 1611 HR, 1638b IR



Source: Balthasar Sylvius, 1554.



Type 24

Found on: 1610 HR, 1628b IR, 1637b IR
1638b IR



Source: Balthasar Sylvius, 1554. (See Type 28.)

Type 25

Found on: '1634 IR'

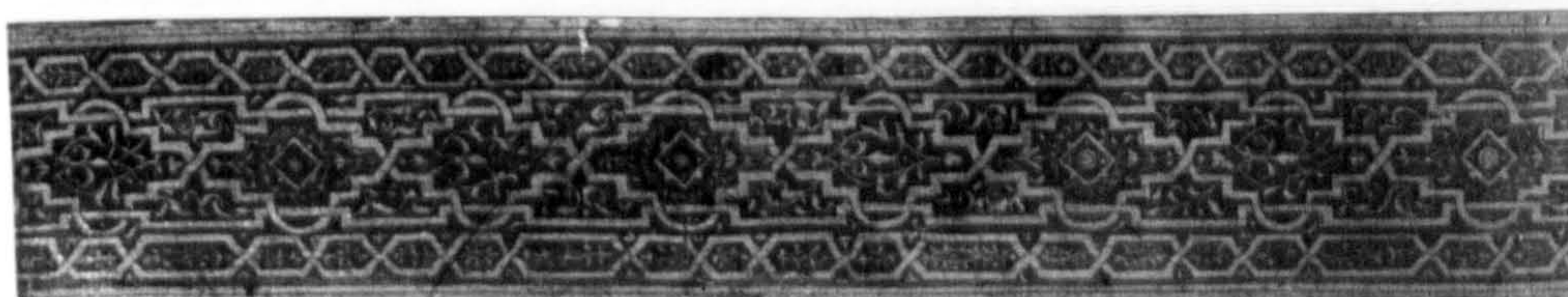

Source: Balthasar Sylvius, 1554.



Strangely, this pattern, although it exists on no genuine Ruckers instrument, is found on the '1634 Ioannes Ruckers' fake harpsichord, c. 1720 in Ham House, London. Since the pattern is one of those in the book by Sylvius, it seems likely that the person who made the fake harpsichord copied the pattern from a genuine Ruckers instrument in the 18th century.

Type 26

Found on: 1610 HR, 1623 IR



Source: Balthasar Sylvius, 1554.

Type 27

Found on: 1627 AR, 1645 IC



Source: Balthasar Sylvius, 1554.

Type 28

Found on: 1610 HR, 1623 IR, 1627 AR



Source: Balthasar Sylvius, 1554.



Type 24 and Type 28 appear engraved in the sylvius book one above the other, and appear together this way on the outside of the 1610 HR child virginal. (See Photo 7-7).

Type 29

Found on: 1612a HR, 1628 AR



Source: Balthasar Sylvius, 1554.



Type 30

Found on: 1598 HR

(for illustration see Type 15)

Source: Balthasar Sylvius, 1554.



This is the border of type 15.

decorated with one of the narrow strip patterns in harpsichords signed by Andreas Ruckers.

The woodblocks from which the Ruckers patterns were printed are competently cut, but without any particular skill or refinement. In comparison with the brilliant contemporary woodcuts used for botanical illustrations, book decorations, etc. which are preserved in the Plantin-Moretus Museum in Antwerp, the woodblocks used for the Flemish instruments are second rate. The exact source of these papers thus seems rather enigmatic - it was not a block cutter of the first order, and it does not seem to have been the instrument makers themselves, unless one of them made the papers as a sideline and sold them to his colleagues.

Whoever cut the blocks and distributed the papers, the prints which appear on the instruments show that the blocks gradually became chipped and damaged resulting in a number of defects in the finished products. The later prints generally show more of these defects, indicating that the blocks were re-used regularly to make fresh prints and that they were probably both very badly stored and that they were cut in a relatively fragile wood. This doubtless explains why a number of the patterns were re-cut giving new versions of the same pattern. This fact is very important as a useful tool in estimating the date of some undated instruments. Clearly if an instrument retains any of its papers which are also found on a number of other dated instruments it is possible to give an estimate of

its date by noting the defects in the prints on the instrument and comparing these with the prints on other instruments whose dates are known.

Rather surprisingly nothing seems to have been done to protect the papers from damage after they were applied. Many of the papers have since been covered with a protective coat of varnish, but the large number of instruments which survives untreated indicates that the papers were applied and then left in their natural state to fend off the ravages of time without any additional protection.

Ruckers painted soundboards

The origins of the painted soundboards on Flemish instruments is not at all clear. What does seem certain, though, is that the tradition of painting the soundboard certainly did not come from Italy. It may have come to Flanders from Germany along with the other traditions in keyboard instrument building. The earliest paintings depicting Flemish virginals and harpsichords show that the soundboards were often decorated only with a scalloped edging around the inside of the case and outlining the bridges, rose and jack mortices, with arabesques placed at the corners of these borders and joined to them, and protruding into the soundboard area at intervals.

Traces of pigments have been found on the soundboard of the Ioès Karest virginal of 1548 in Brussels, and the 1550 Karest virginal in Rome has a fully developed soundboard painting with blue scalloped borders, blue arabesques, and fruit and flower paintings. It is thus the earliest

extant instrument with a painted soundboard. This along with its beautiful grotesque outer decoration, its elegantly curved 'bentside' and the unusually large compass of C, D to f³ makes it one of the most interesting and precious of early Flemish instruments.

But although the origin of the practice of painting flowers, fruit, etc. on clavecimbel soundboards is not certain, the tradition of this type of decoration has considerable precedent. The stylised flower and figure painting found in illuminated books, peasant furniture, and on pottery, armour, and 'Dutch' tiles are very similar in concept and execution. Along with the passion for gardening, exotic plants and birds, and when at the height of the 'Tulpomania' aberration, a single exotic tulip plant could be sold for a fortune, it is not surprising to see this type of decoration on harpsichord and virginal soundboards.

Pattern books for Ruckers soundboard paintings

It is clear from an examination of Ruckers soundboard paintings that each builder had his own painter and that each painter worked in a consistent style over a period of several decades. In addition to using his own style of arabesque, each soundboard painter used the same motifs and groupings of flowers, fruits and animals again and again, and each had his own characteristic technique of applying the paint. The similarity in the individual decorative elements from soundboard to soundboard are so consistent for each painter over such a long period of

time that it seems almost certain that the decorators were each working from pattern books from which they copied their designs onto the soundboards, rather than painting each flower or bird entirely from memory. The position, orientation, spacing and size of individual elements varies on different soundboards by the same decorator, but details such as the proportions, outlines, colours and shading of the individual elements remain the same.

Just as there were traditional patterns used for the block-printed papers, there were also doubtless workshop patterns used by the Ruckers which were not taken from published pattern books. Clearly the garland or wreath around the rose was one such workshop design which one would not expect to find in a pattern book. But the popularity and large numbers of printed herbals and florilegia that existed at this time, suggest that the Ruckers soundboard designs, if not copied directly, were at least inspired by these pattern books.

It is very difficult to associate a particular pattern book with a Ruckers soundboard painter or design. Each soundboard painter would have to interpret the engraved designs in the manner of his usual painting style. The way he applied the paint, the brush strokes and the colours used would be an extrapolation of the lines of the engraved image and would be left to the individual artistic interpretation of the decorator. It is possible to imagine two different soundboard decorators using the same engraved pattern book to produce two painted patterns

which are so dissimilar as to disguise their common origin.

The other problem of associating one of the published florilegia with a given Ruckers soundboard painter is that, in the days before copyright control, the flower books were copied and re-published again and again by new 'authors'. This usually meant that a previous flower or animal design was copied onto the engraving plate and re-engraved. Each time this was done the image suffered a mirror reversal. Some of the designs copied onto Ruckers soundboards have this mirror reversal either because the decorator was working from a second-generation copy of the pattern book, or more likely because he reversed the image so that it would fit better into the space he needed to fill, or to synchronise it with the rhythm of the adjacent designs. I have been able to discover a definite association between only one set of printed pattern books and the Ruckers soundboard paintings, where some are with and some without a mirror reversal. The pattern books involved were used by the soundboard painter who painted the late instruments signed by Andreas Ruckers. They are by Adrian Collaert and are called Florilegium and Avium Vivae Icones (Living Images of Birds).

Adrian Collaert was born about 1550 to 1560, was a citizen of Antwerp, and died on July 29, 1618.⁷⁻⁷ He became a master in the Guild of St. Luke as a figuer-snyder or engraver, and his father was a master of the Guild and presumably also an engraver. His wife was Justa Galle, the daughter of Philip Galle who was a famous en-

graver as well. Collaert was co-dean of the Guild of St. Luke in 1596/97, and was elected corporate dean in 1597/98, and therefore would doubtless have been aware of Hans Ruckers' death in 1598. He is recorded regularly in the Registers of the Guild as having taken in apprentice engravers, and in his later years is recorded as a contributor to various benevolent funds of the Guild.

The date of publication of the Florilegium is unknown but is thought to be about 1590.⁷⁻⁸) Collaert published his Avium Vivae Icones in Antwerp in 1610, and later in Amsterdam in 1625. He also published two other pattern books of interest: Piscium Vivae Icones, Antwerp, 1611 and Amsterdam 1634, and Animalium Quadrupedium, Antwerp, (1612?). Unfortunately I have not found any specific examples of the use of these pattern books by any of the Ruckers soundboard painters.

Collaert's Avium Vivae Icones is a collection of engravings of domesticated and wild, European and exotic birds, and it is designs from this book which are most easily recognisable on the Andreas Ruckers soundboards. Most of the birds illustrated depict the common European species: the sparrow, the raven, eagle, partridge, starling, goldfinch, etc., and a few exotic birds like the turkey and parrot. These latter two are easy to identify on the soundboards although the European species are also found on Andreas Ruckers soundboards. Photo 7-8 shows the Collaert turkey engraving and the turkey depicted on the soundboard of the (1651)a AR single-manual

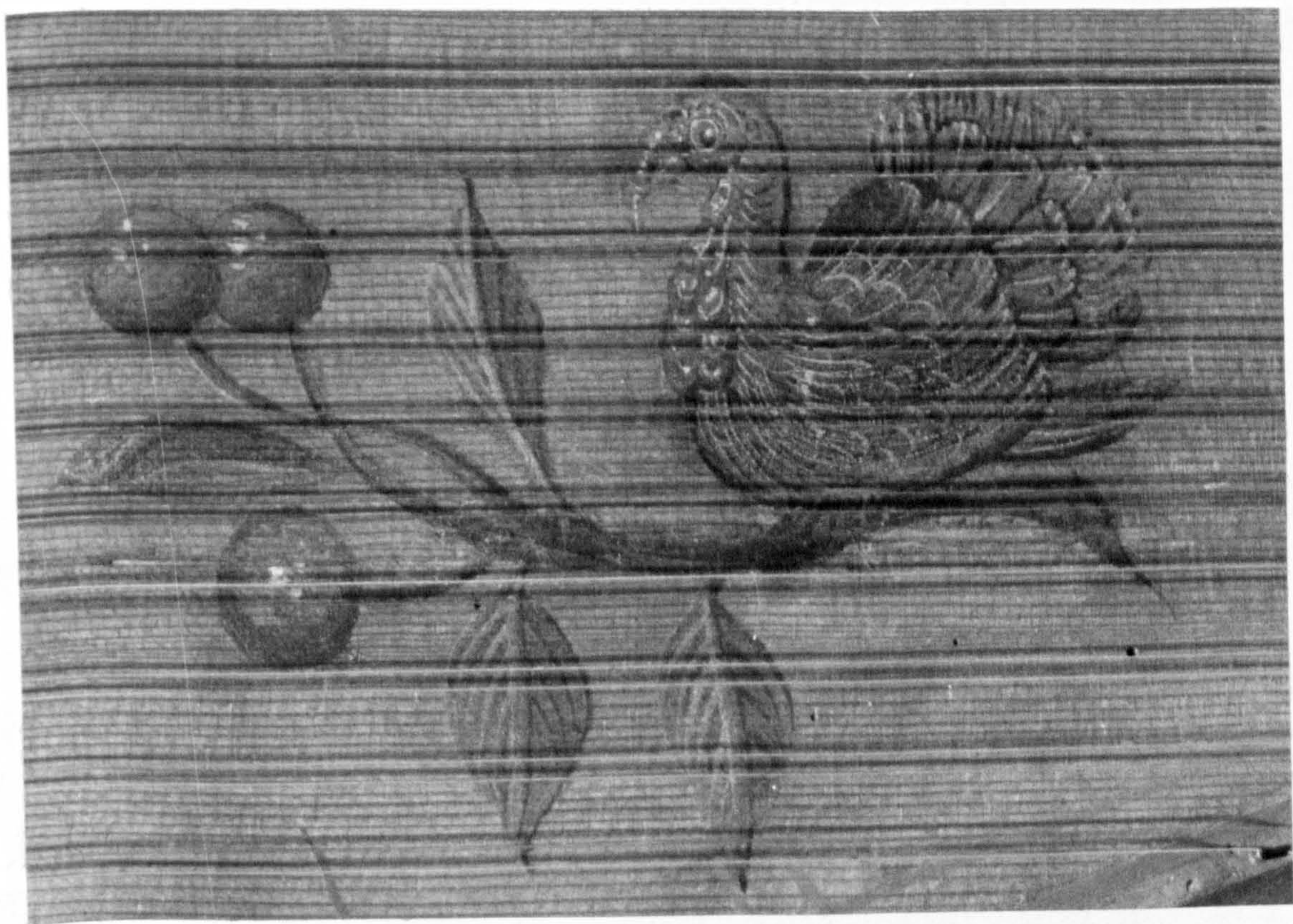
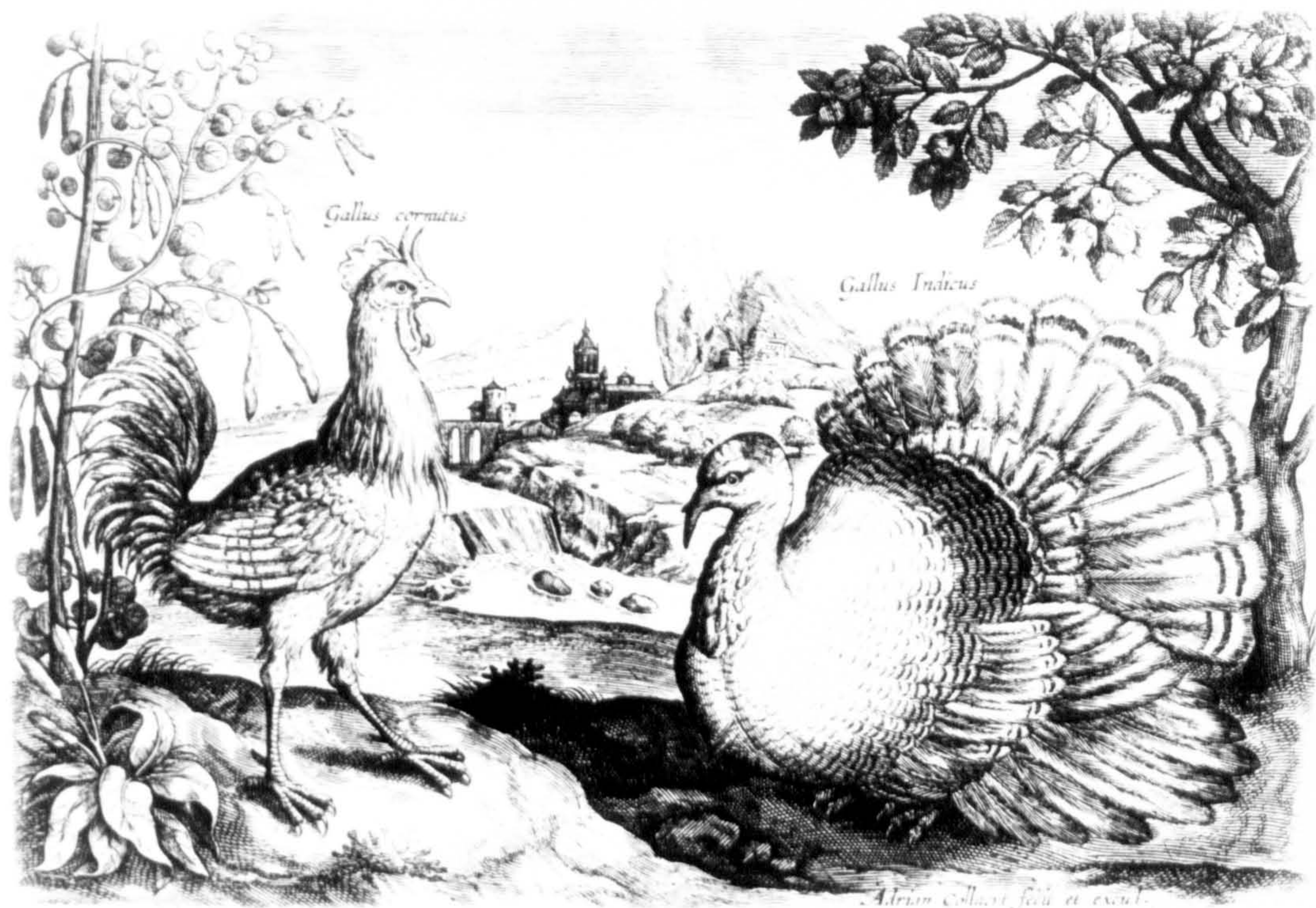

Photo 7-8 Comparison of the turkey in Collaert's *Avium Vivae Icones* (scale 3:5), and that on the soundboard of the (1651)a AR single-manual harpsichord.

harpsichord in Traquair House, Innerleithen. Here there is no mirror reversal. The same turkey is seen in a similar position, but sitting on the stem of a tulip on the 1640b AR in Namur, and with a mirror reversal sitting on a strawberry on the 1633b AR double in Leipzig. Photo 7-9 compares the parrot holding a cherry on the 1646b AR double soundboard with the Collaert engraving. Here there is clearly a mirror reversal. Photo 7-10 shows a comparison of a hoopoe in the Collaert pattern book and that found on the 1623 AR double harpsichord. Here the soundboard painter, who may be different from that of the previous two examples, is less confident and more naive, but the source of his design seems still to have been Collaert. Naturally there are numerous other examples of concurrences between the Collaert bird engravings in the Avium Vivae Icones and the late soundboard paintings of Andreas Ruckers which cannot all be itemised here.

Collaert's bird engravings exhibit a clear attempt at a naturalistic representation of the animals involved even if they are not completely anatomically correct. The illustrations above show that the painter of the late instruments of Andreas Ruckers treats these illustrations with considerable freedom, resulting in a highly stylised representation of the birds concerned. This is also true of the flower patterns which the late Andreas painter used from Collaert's Florilegium. Photo 7-11 to Photo 7-13 show comparisons of numerous flowers engraved by Collaert and as found on the later instruments of Andreas Ruckers. These illustrate beautifully the meaning of

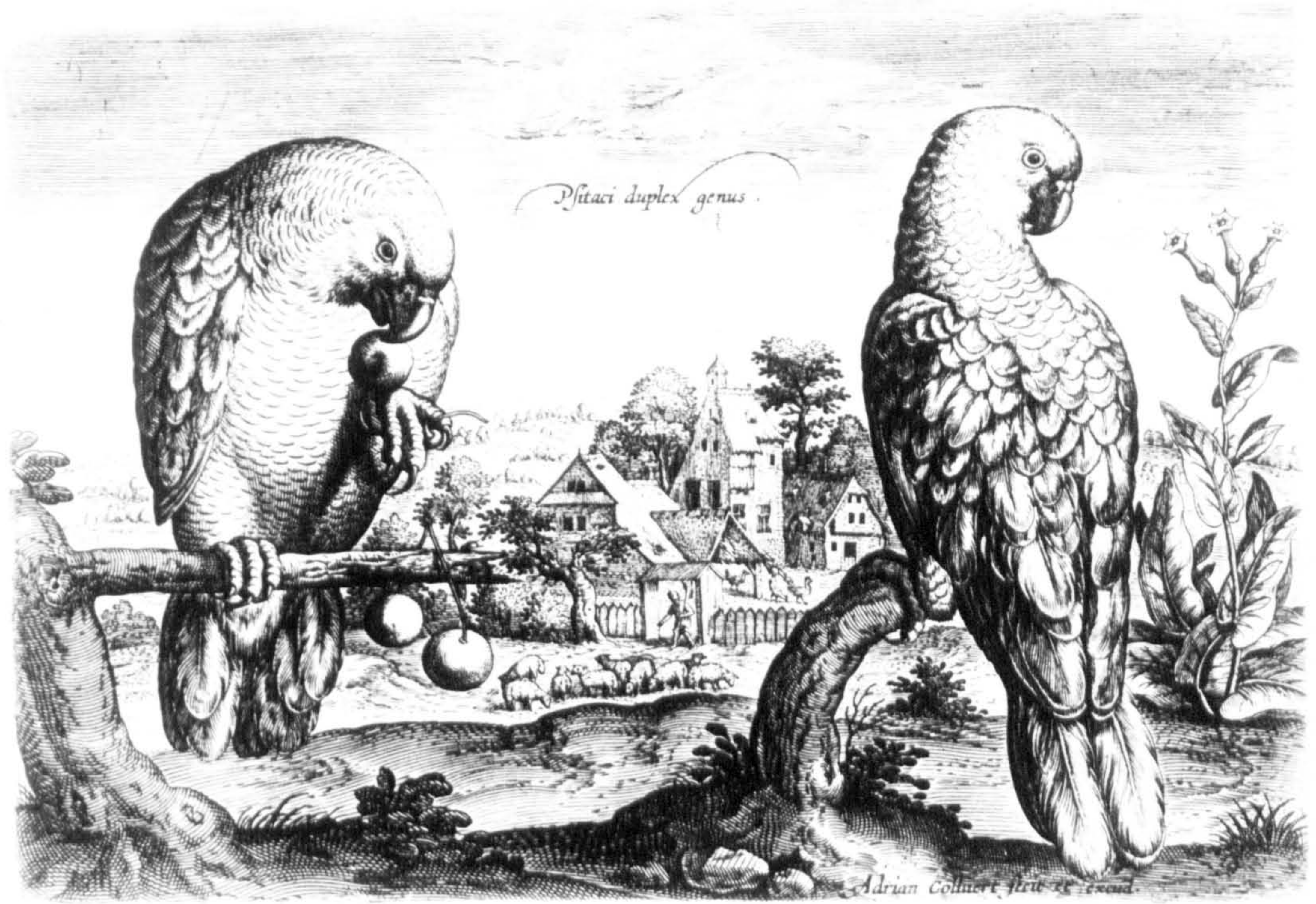

Photo 7-9 Comparison of the parrot in Collaert's Avium Vivae Icones (scale 3:5), and that on the soundboard of the 1646b AR double-manual harpsichord.

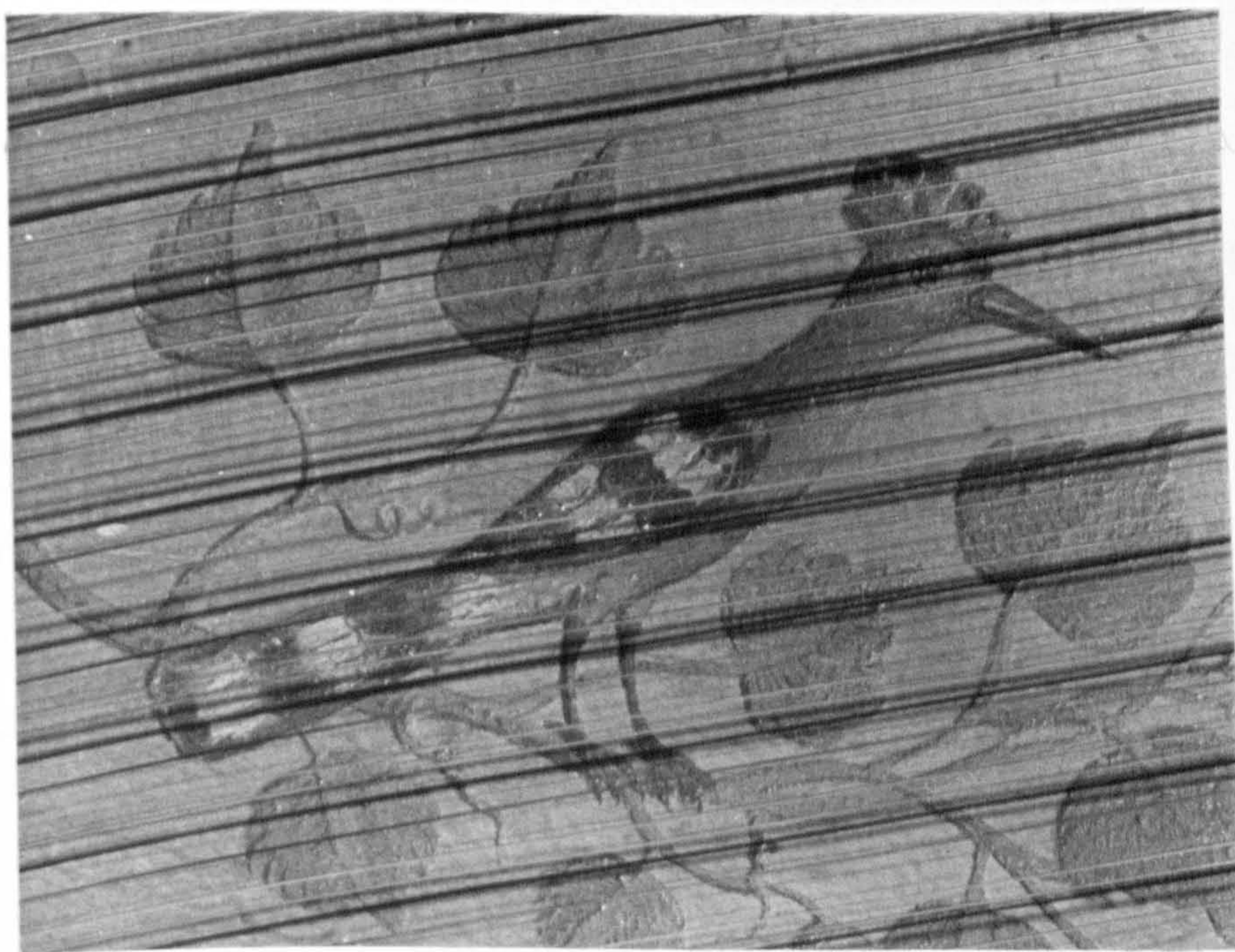
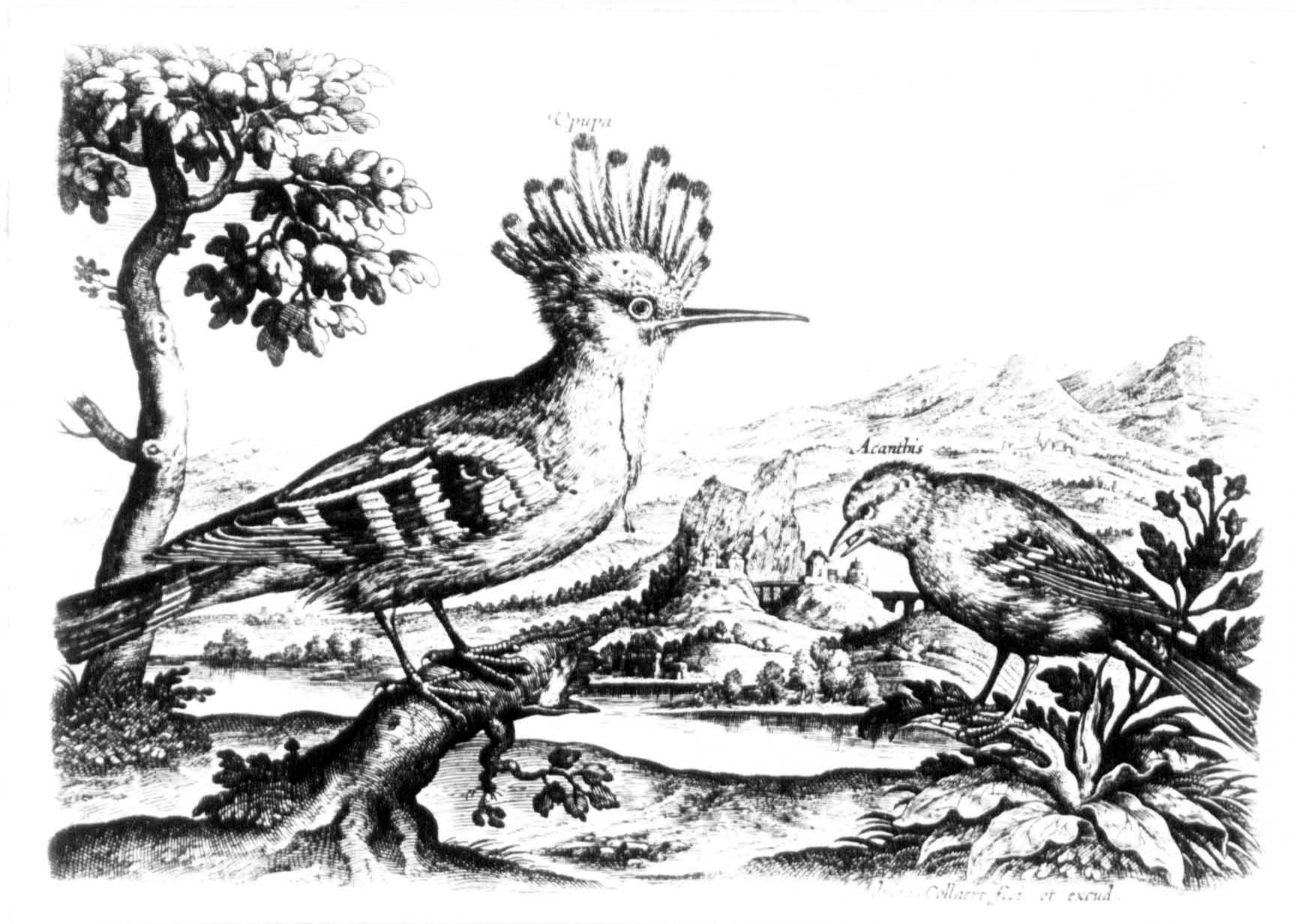

Photo 7-10 Comparison of the hoopoe in Collaert's Avium Vivae Icones (scale 3:5), and that on the soundboard of the 1623 AR double-manual harpsichord.

artistic license, but also show that the decorator of the late Andreas Ruckers instruments was definitely using Collaert's Florilegium as a source book for his soundboard paintings.

Among the other soundboard painters who decorated the Ruckers soundboards I have not been able to trace the use of any particular printed pattern book. Of the remaining Ruckers soundboard painters, the one who worked on the early Ioannes Ruckers instruments is notable in that the painted style is almost like that of a coloured engraving. The leaves are painted in flat green paint and then the outlines and veining are added with quill and ink, as though the painter were copying the black engraved lines onto his soundboard. Even the flower heads are sometimes outlined and shaded in quill and ink, and the birds and insects are also treated in this way. Clearly this soundboard decorator was looking at a coloured engraving when he copied his patterns onto the soundboard. The flower groups mostly resemble those engraved by Crispin van der Passe, but it is not possible to identify unequivocally any of these with the early Ioannes soundboard paintings.

The soundboard painting on the early Andreas instruments are like those on the early clavecimbels by Ioannes Ruckers in being outlined with quill and ink, and must also be derived from an engraved (or woodcut) pattern book. These are not so much paintings as drawings in paint; there is no use of the methodical building up of

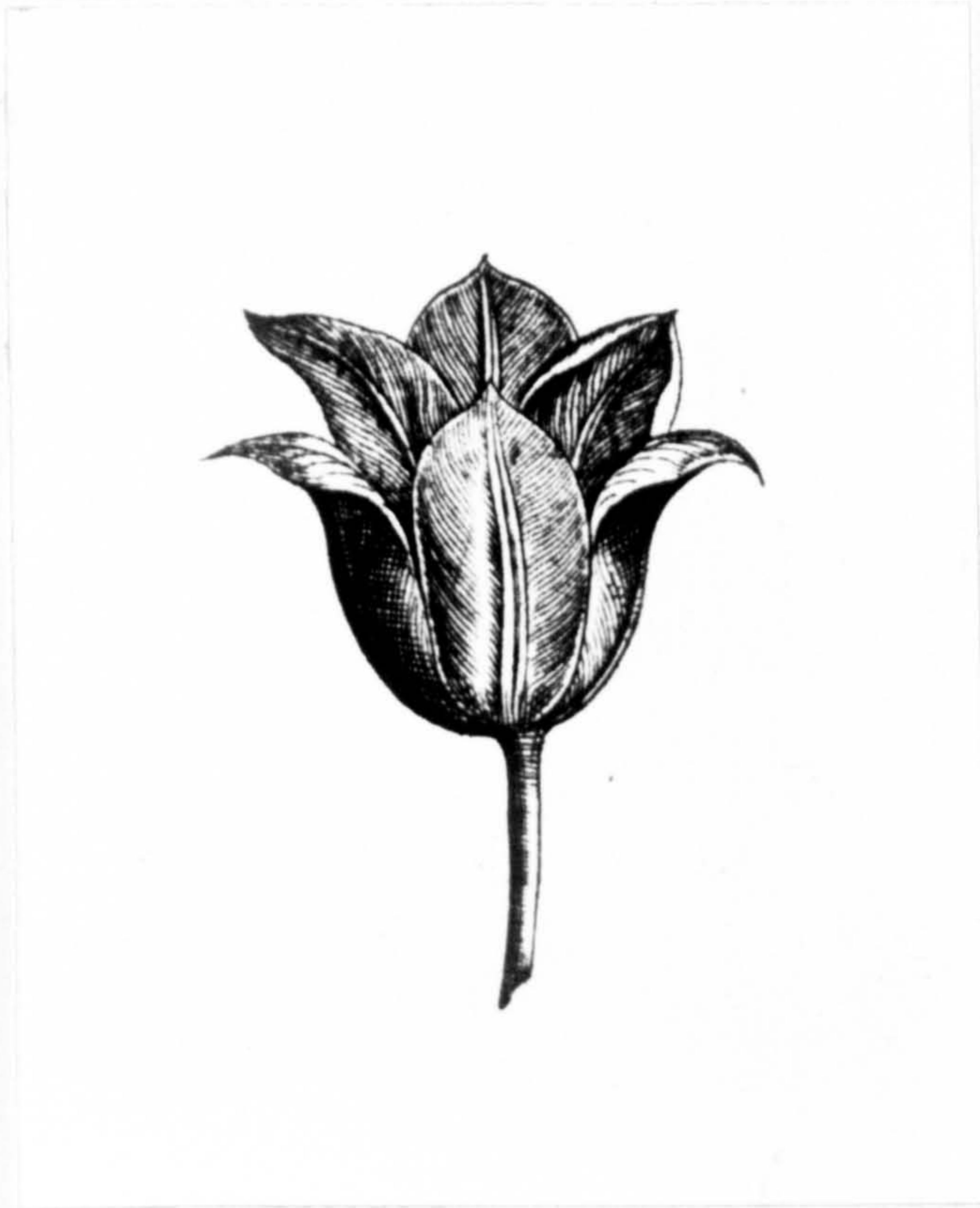

Photo 7-11 Comparison of a tulip from Collaert's Florilegium with that on the soundboard of the 1640a AR single-manual harpsichord.

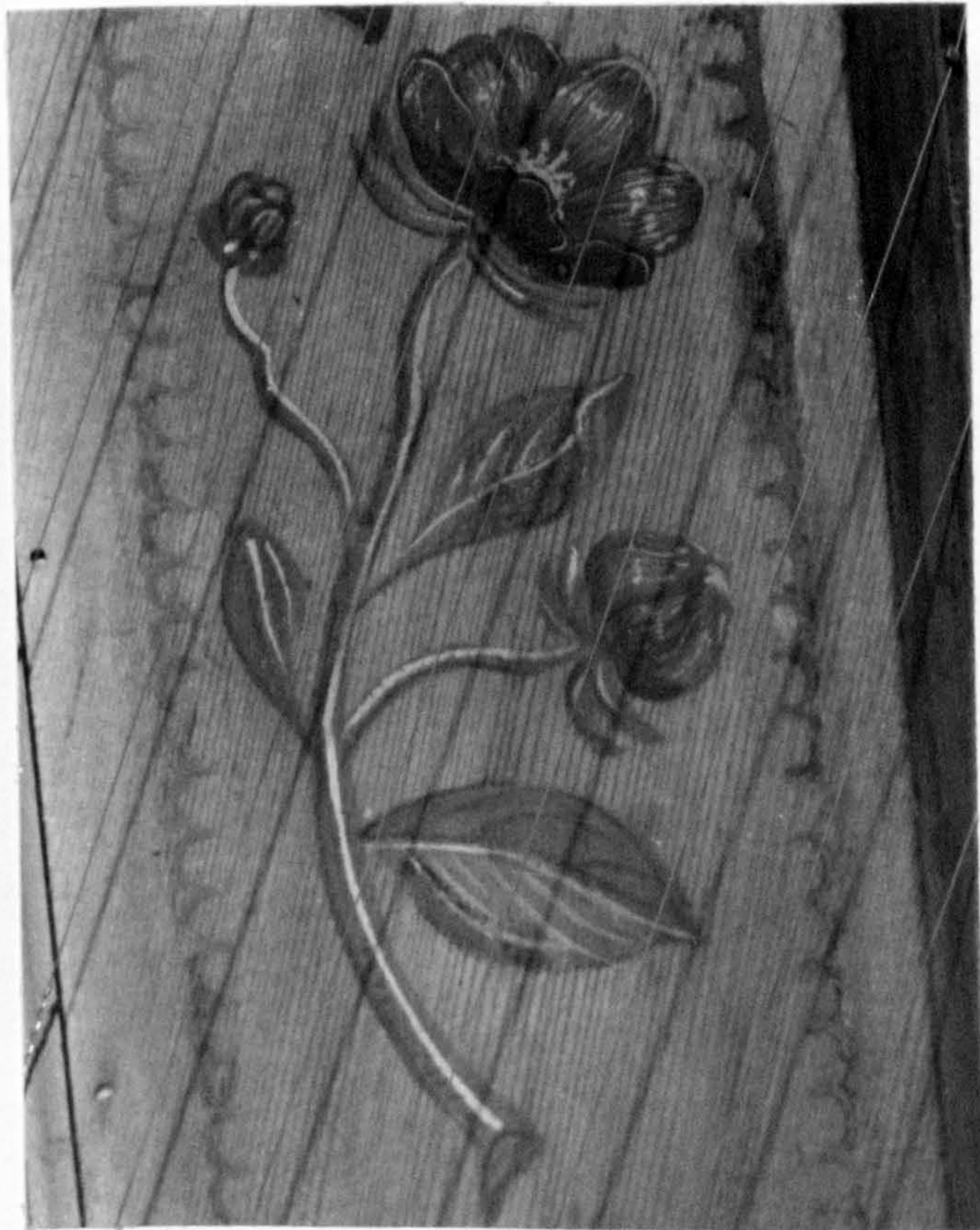

Photo 7-12 Comparison of a rose from Collaert's Florilegium with that on the soundboard of the 1640a AR single-manual harpsichord.

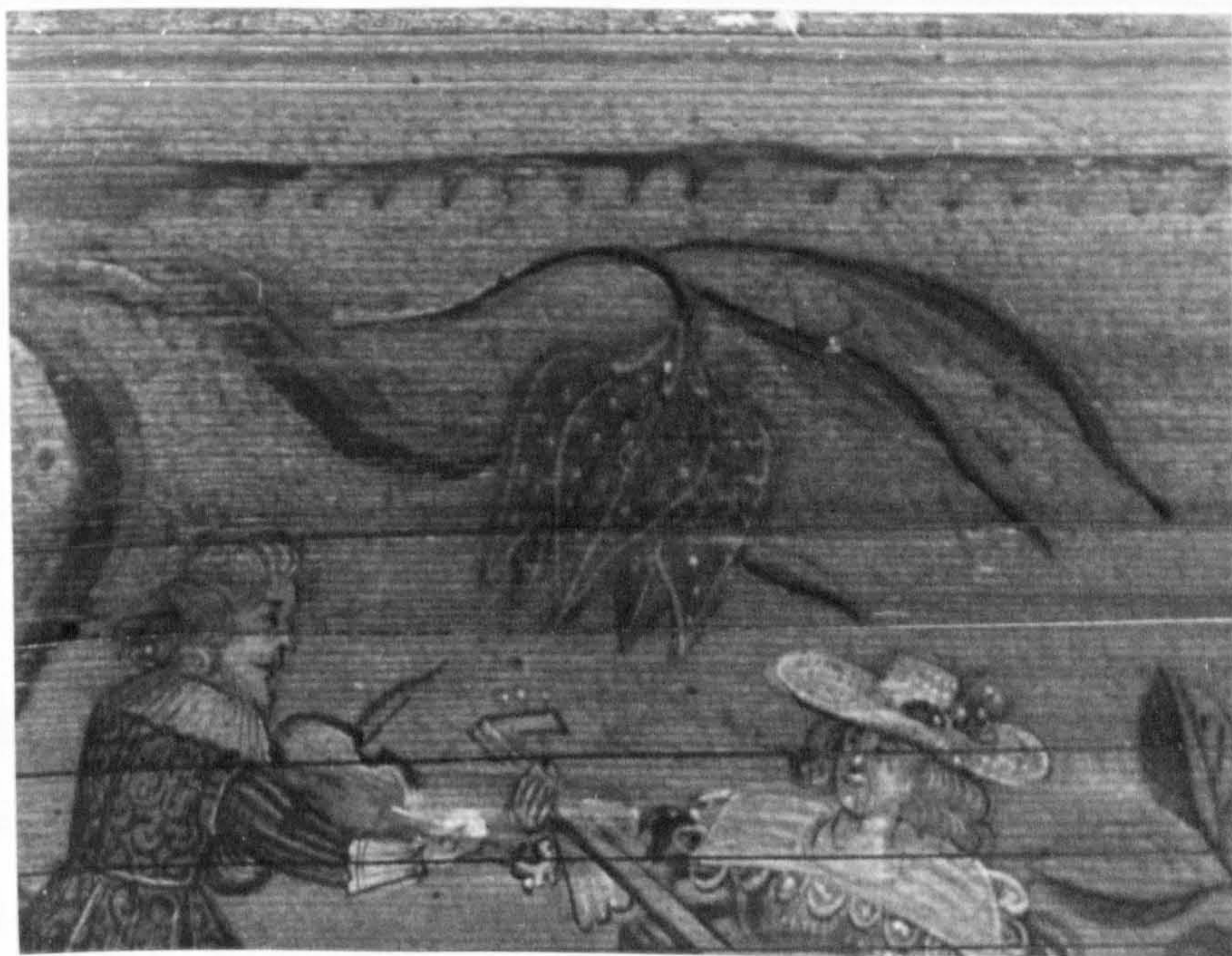

Photo 7-13 Comparison of a fritillary from Collaert's Florilegium with that on the soundboard of the 1633b AR double-manual harpsichord.

paint, or of the brush stroke. The effect is flat and linear, and results in a very stylised representation. But although the paintings of the late Andreas soundboards, on which we see the designs taken from the Collaert books, are also very stylised, they are painted and not drawn in paint. The painter who used the most sophisticated technique and who produced the most naturalistic paintings was the late Ioannes Ruckers/Ioannes Couchet soundboard decorator. Here the paint is applied methodically in layers, and glazes are used to create shadows and highlights. Use is made of the brush-stroke both to give colour and to create form. The effect gives shape and depth in a manner not achieved by the other decorators and in a style which begins to approach the art flower paintings of Bosschaert, van Kessel and de Heem.

However, none of the Ruckers painters is to be compared with the fine art painters. They were simply highly efficient decorative artists. The results they produced are stylised and naive, colourful, and thoroughly charming.

Styles and periods of Ruckers soundboard decoration

Because the soundboard painting style of each Ruckers decorator is relatively constant over a period of several decades, the soundboard painting can be a useful guide to the authentication of a Ruckers instrument, and to the dating and the identification of the particular member of the Ruckers family who built the instrument. It is therefore worthwhile to examine each soundboard paint-

ing style in detail in order to identify the salient characteristics of each decorator. There are five, or perhaps six, different soundboard painting styles, each with its own typical way of painting the blue borders and arabesques, and each with a different painting style and choice of designs and motifs.

Early Hans Ruckers style

It is very difficult to distinguish the later instruments of Hans Ruckers from the early ones of his eldest son Ioannes. Ioannes would have been 19 years old when Hans died in 1598, and was therefore old enough to have been making his own instruments even though he may not have been registered with the Guild of St. Luke as a master builder. The last instrument with an extant painting which is painted in the Hans Ruckers style is the 1591a HR polygonal virginal in Bruges. The 1594 HR harpsichord-virginal combination in East Berlin has lost virtually all traces of its soundboard painting. The next instrument is dated 1598, has an HR rose like that of the earlier Hans instruments, but is signed IOHANNES RVCKERS FECIT ANTVERPIAE and a soundboard painting in the style of the other early instruments by Ioannes Ruckers. It therefore seems likely that it is by Ioannes and not by Hans, although there is no reason why the same soundboard painter should not have worked for Hans and then later, after Hans Ruckers' death in 1598, for his son Ioannes. As we shall see below another soundboard painter worked for Ioannes Ruckers and then later for Ioannes Couchet

after Ruckers had died and the workshop was taken over by Couchet.

The same decorator worked for both Hans Ruckers and Marten van der Biest (and perhaps Ioannes Grauwels). The style of this decorator is particularly easy to identify from the lacy blue wreath surrounding the rose (he does not use a floral or leaf wreath). Also the soundwell and keywell painted decorations are in the same style and obviously done by the same decorator. Usually he also paints a red band inside the wreath and around the rose, with black and white 'pearls' spaced regularly along the band. The flowers on the soundboard are done in a somewhat more painterly style than the early Ioannes and Andreas instruments, but are very stiff and rigid. The flowers usually have either four or five petals and these are painted in a very characteristic way with a prominent green sepal between each petal regardless of the type of flower. The leaves of the flowers tend to be thin, straight and pointed. The effect is much like that of dried straw flowers scattered about the soundboard, and I usually call this the straw-flower style. Cherries and other small individual fruits, leaves and olives are scattered among the flowers and blue arabesques. This decorator does not seem to have painted birds, animals or human figures, or scampi.

The early Ioannes style

The same decorator worked in the Ioannes Ruckers workshop from at least 1598 until 1624, and his sound-



Photo 7-14 The soundboard of the 1581 HR child virginal showing the typical Hans Ruckers 'strawflower' soundboard painting style.

Scale 1:5

board painting style is remarkably consistent over this period. The early soundboard paintings are slightly stiff, and somewhat sparsely painted in comparison with the later ones, but the painting technique and the motifs chosen remain consistent over the entire period.

Again one of the most distinguishing features of this soundboard painter is the way the wreath is painted around the rose. Instead of the Hans Ruckers type of red ring immediately surrounding the rose bevel in the soundboard, the Ioannes decorator used two thin concentric rings with a wide white band between them. Onto the central white band is painted a red rope pattern. On some double manual harpsichord soundboards each loop in the rope has a grey dot at its centre. Surrounding the ring rope pattern is a wreath of intertwining myrtle leaves with the occasional small red, white and blue flowers dotted among the leaves. This wreath usually originates at the bottom of the wreath from two crossed stems which oscillate from one side of the wreath to the other, with leaves which curl out and intermingle on either side. As with the Hans and early Andreas wreath paintings, concentric circles are scribed in the soundboard to use as guidelines while painting the decorations around the rose.

Another particularly striking and characteristic feature of the early Ioannes painter is that the leaves and some of the flower heads are outlined in black ink. The leaves are painted without shadows or highlights in a solid flat green (or sometimes half of each leaf is painted



Photo 7-15 Wreath painting on the 1618b IR double-manual harpsichord.

in a single shade of green). This is outlined in black ink and the veining is also drawn over the paint in ink, normally on only half of each leaf. Some flower heads are also painted in solid flat colours which are outlined in ink and this almost certainly disclosed the fact that these designs were taken from an engraved pattern book. But the flower heads which are painted by mixing colours and by applying successive layers of paint to give highlight, shade and form are not also outlined and shaded in ink. The flower groups consist of a pleasant mixture of large flowers - tulips, iris, paeonies, roses and lilies, with smaller marigolds, cornflowers, lily-of-the-valley, fritillary, borage, columbines, heart's-ease, forget-me-nots, etc. filling up the space of the soundboard.

Sometimes a bird is perched on one of the flower stems. The black and white magpie, and the red-breasted, black-backed stone-chat are particularly common, but the goldfinch and parrot also occur. There are never any large fruit but small spaces are filled up with single leaves, small fruit, bees, butterflies and moths, or flower buds. And a spindly strawberry plant with long stems to its leaves, fruit and blossoms is also quite characteristic. Because of the general flatness of the paint, and the use of ink outlines and shading in most of the motifs, the result is very stylised. But despite this stylisation the effect is always naturalistic enough to make the decorator's intent clearly recognisable.

The blue arabesques are usually quite tall and

tapering with a pronounced central axis, like those of the early Andreas painter. But the Ioannes arabesques are lighter and more lacey than those of Andreas, which tend to be rather solid and heavy. A considerable part of the lightness of the arabesques is achieved by individual dots of paint placed near, but not touching, the arabesque. These early Ioannes arabesques are much more symmetrical than those of the Couchet or late Andreas painter, although mechanical symmetry is avoided by balancing the left and right half of the arabesque in such a way that the eye is deceived into thinking that both halves are identical even though small asymmetries exist. The variety and inventiveness displayed in the arabesques is extraordinary when one examines the small number of basic elements used in their construction. Although they are usually quite large, the arabesques may also be no more than a few curls and dots of paint added to the scalloped border, with all possible variations in between. Arabesques in the same style are painted in red on the wood-grain paper on those instruments with papered lids and flaps, but these are never as large and intricate as the blue arabesques found on the soundboard.

In addition to the blue arabesques and scalloped borders, the early Ioannes soundboards usually have a few 'bubbles' consisting of six or eight dots surrounding a larger central dot, and 'stars' which are just 'bubbles' with lines drawn out from the dots of the 'bubbles'. These 'stars' and 'bubbles' float freely among the arab-

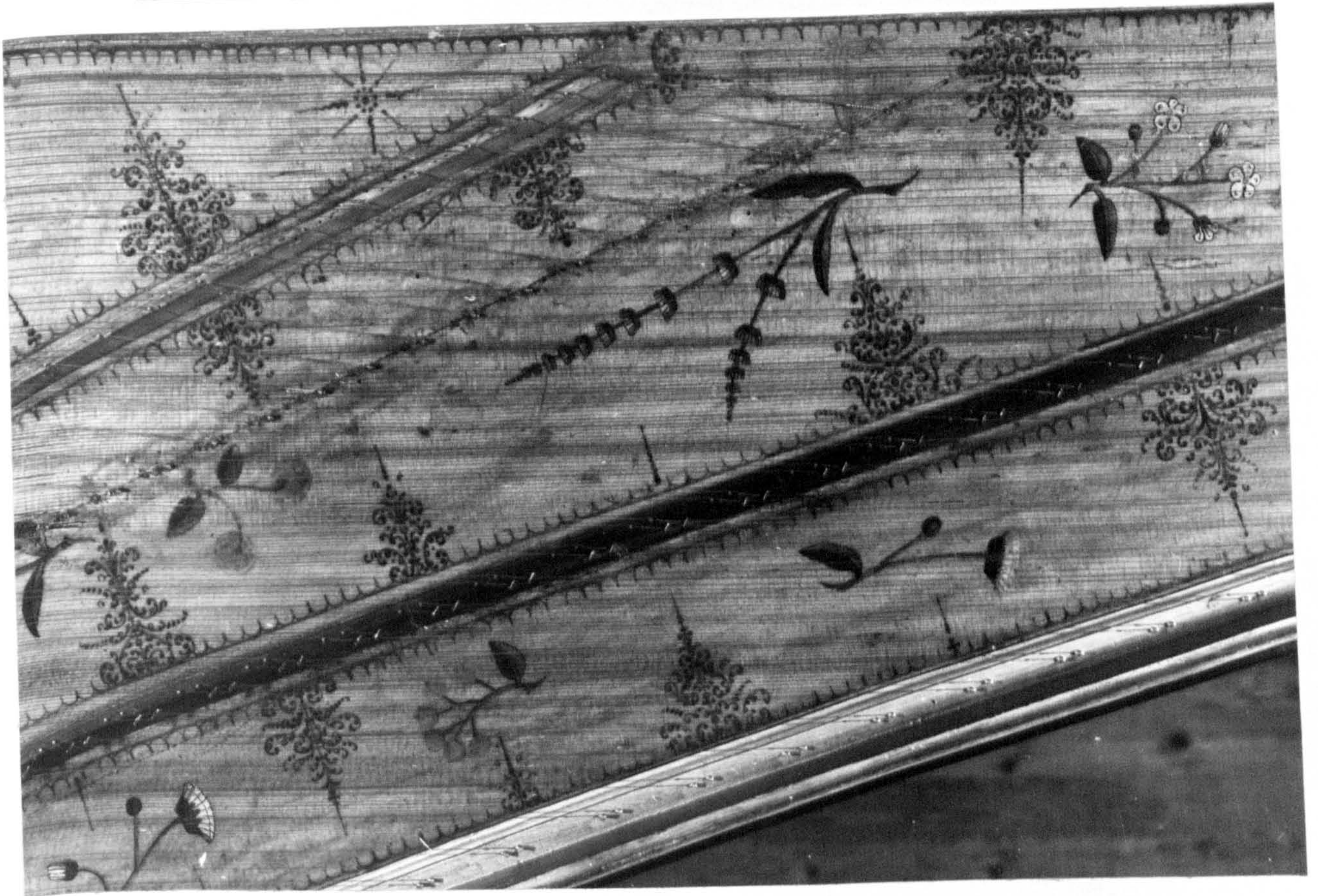

Photo 7-16 (above) and 7-17 (below) Examples of early Ioannes soundboard paintings. At the beginning (1612a HR) the composition was rather sparse (above), compared to that at the end (1624 IR) of this painter's career.

Scale 1:4

esques and flower decorations, but are used only very sparingly.

On the virginals the date is placed on the soundboard. But on the harpsichords the date is written on the wrestplank rather than the soundboard (except for the last extant harpsichord decorated by this painter, the 1624 IR double in Colmar, which is dated on the soundboard between the rose and the spine). A number of Ioannes harpsichords from this period which have suffered a ravalement and lost their original wrestplank or wrestplank veneer are dated either on the non-original namebatten or jackrail, but it seems almost certain that the date was originally painted on the wrestplank.

The early Andreas style

Andreas Ruckers I set up his own workshop separately from his brother Ioannes around 1605. The only instrument which survives from the period in which Ioannes and Andreas worked together, the 5-voet virginal of 1604 in Brussels, is decorated by the early Ioannes decorator. But from 1608 until at least 1624 it is clear that a different decorator was working exclusively for Andreas Ruckers.

The early Andreas decorator seems to have changed his style during his career more than any of the other soundboard painters. The soundboard paintings from 1608 to about 1618 are done in expanses of flat colour, with shading in the flowers and veining in the leaves done in ink. The ones done from about 1620 to 1624 have more shading in paint in both the leaves and the flowers with less

use of ink. Like the early Ioannes painter, the Andreas decorator of this period uses a red and white rope pattern immediately surrounding the rose. The wreath paintings of the 1608 and 1609/^{harpsichords} have small flowers scattered among the intertwined leaves. But from 1614 the flowers in the wreath are large and occupy almost the whole of the width of the band of leaves in the wreath. (The exception to this occurs in the small child virginals which lack the wreath and have instead only the red and white rope pattern and a few blue arabesques). Also only the instruments after 1614 have bird and animal motifs.

One of the most characteristic features of the early Andreas soundboard painter is the sinewy shape he gives to his flowers. The stems and leaves snake their way across the soundboard in a way which is not found in the style of any of the other soundboard painters. Also the paint, especially on the leaves, is built up in thick impasto. This along with the large flowers in the wreath and the arabesques typify the style of the early Andreas painter.

Like the early Ioannes arabesques, the Andreas arabesques of this period are tall and tapering with a strong central axis. The early Andreas arabesques are strongly and heavily painted and make use of double 'S' bends and rounded arcs of circles. The rounded shape of the arabesques is very typical. Also characteristic is the large number of 'stars' and 'bubbles' scattered among the flowers and arabesques. These are more intricate and inventive than those of the early Ioannes painter, and are very numerous.



Photo 7-18 A typical example of the soundboard painting by the early Andreas soundboard painter (1620c AR).

Scale 1:2

A feature of both the early and late Andreas decorators, not found with any of the other Ruckers painters, is that they both often decorated the inside of the harpsichord lid with motifs similar to those found on the soundboards. The early Andreas painter seems to have been especially fond of using birds and animals around the Latin mottoes on the wood-grain papers.

The date is painted on the soundboard of all the instruments decorated by the early Andreas painter. Usually there is also an elaborate red arabesque on either side of the date. On the harpsichords the date is painted between the rose and the spine, or on the lid. The date is recorded only on a non-original namebatten or jackrail on a number of Andreas instruments from this period, probably because the original dated lid is now missing.

The late Ioannes/Couchet style

Ioannes Couchet came to work as an apprentice in his uncle, Ioannes Ruckers', workshop, in 1627. Couchet would then have been only 16 or 17. 1627 also marks the date at which a new soundboard decoration style appears on the Ioannes Ruckers instruments. The two events seem coincidental, however, and it is highly unlikely that Couchet himself began to decorate the soundboards signed by Ioannes Ruckers. Couchet would then have been very young and the output of the workshop was sufficiently great that an apprentice would not have had time to do all the decoration and learn the art of harpsichord-building at the same time. Most importantly, we know from the decoration

on a recently discovered instrument, that the same decorator was working for Gommarus van Eversbroeck in 1659, four years after Couchet died!

This decorator worked for Ioannes Ruckers from about 1627 (there are no dated instruments from the period between 1624 and 1627) until Ruckers' death in 1642, and then for Couchet who took over Ruckers workshop, until Couchet's death in 1655. This decorator is probably the most painterly and naturalistic of all the Ruckers soundboard painters. He uses his paint in layers, building up the paint gradually to create highlights, shadows and at the same time form and depth. There is no use of ink outlines or veining. The use of the rope pattern and wreath of myrtle leaves around the rose was abandoned for an extremely rich and finely painted floral wreath. This wreath is separated from the rose by a black circle painted around the gilded soundboard bevel.

The late Ioannes/Couchet decorator used a much lower, somewhat rectangular arabesque usually consisting of two double 'S' curves with spirals at the ends. The 'S' curves are decorated and elaborated with dots and squiggles in such a way that, although balanced, the arabesque is rather asymmetrical. The 'star' and 'bubble' motifs are not used at all by this decorator.

Aside from the painterly way in which the paintings are executed, the late Ioannes/Couchet decorator is characterised by a number of features. He often paints the flowers in groups with the stems and leaves of different



Photo 7-19 The wreath painting of the 1637a IR harpsichord. The usual black ring around the edge of the rose bevel has been gilded over during a re-touching of the soundboard painting.

Scale 1:2

species crossing, whereas all of the other Ruckers soundboard decorators paint each flower separately. He often uses large fruit like pears, peaches, plums, lemons, etc. as motifs. Also highly characteristic are one or two scampi painted between the 8' bridge and the bentside. The harpsichords usually have one or more large colourful and naturalistic parrots (but no other species of bird). The position and colouring of these parrots, the floral wreath paintings, as well as a number of the individual flower motifs, are identical on a number of the late Ioannes/Couchet soundboards and this indicates that the decorator was following very closely his workshop pattern books. The arrangement of the motifs on the soundboard varies however, so that it is clear that each painting was composed individually by selecting from the painter's repertoire of motifs. The date is always painted on the soundboard - on the harpsichords it is between the spine and the bass end of the 4' bridge.

The single-manual harpsichord by Gommarus van Eversbroek of 1659 in the Paris Conservatoire has a soundboard and lid decorated by the late Ioannes/Couchet painter. Although some new motifs appear (the last dated Couchet instrument with a painted soundboard is the 1650 IC 6-voet/^{virginal} in the Vleeshuis, Antwerp, so it is not surprising to see new motifs at a date 9 years later) many of the motifs are the same as those found on Couchet instruments, the style of the arabesques is the same, and the manner of actually applying the paint is also the same. The exist-

ence of this isolated example of a non-Ruckers instrument painted by one of the Ruckers decorators proves conclusively that the Ruckers/Couchet instruments were not decorated by the Ruckers or by Couchet, but rather by a workshop employee, or at least by someone who contracted to do the decoration for the Ioannes Ruckers/Ioannes Couchet workshop.

The late Andreas style

As with the Ioannes instruments a new soundboard painter began working in the Andreas workshop in the period between 1624 and 1627. It is not known if the occurrence of a change in decorator in both workshops at about the same time is related.

The style of the soundboard decorator of the late instruments signed by Andreas Ruckers is more painterly than the early Ioannes and Andreas decorators, but is not any more naturalistic. In fact identification of some of the species portrayed is very difficult indeed. The shapes of many of the flowers and birds are distorted and exaggerated giving them a very unnatural appearance. The painting technique is characterised by long, thin, narrow brush strokes. The long, thin highlights in particular give the painting a striped appearance which is easily recognised. The rose is surrounded by a floral wreath and not the stylised leaf wreath of the earlier styles. A highly characteristic feature of the double-manual harpsichord soundboard paintings (and some virginal paintings) of this decorator is that the wreath is held by two angels, one on



Photo 7-20 The wreath painting of the 1640a AR single-
manual harpsichord.

Scale 1:2

either side of the wreath. The leaves of the flowers are always rather narrow and pointed and the stems are straight giving the painting a rather stiff appearance somewhat similar to the 'straw-flower' style of Hans Ruckers.

As mentioned earlier many of the motifs are taken from Adrian Collaert's Avium Vivae Icones and Florilegium so that flower and bird species of many types from these sources occur. Also very characteristic of this painter are the scenes with animal and human figures. Among these we find a courting couple being served wine, a gentleman taking off his hat to a musician playing his fiddle to a dancing dog, a knight mounted on his horse, and even a group of monkeys playing instruments and singing. There are usually a number of insects, flies, butterflies, moths, and, not found on any other style of soundboard painting, dragonflies. On the single-manual harpsichords the date is painted simply in red, but on double-manual instruments the date is painted in red across a white ribbon scroll between the rose and spine. This way of painting the date is found only on the double-manual harpsichords painted by the late Andreas Rucker soundboard painter,

The arabesques of this decorator's style are low, but slightly more tapered than those of the late Ioannes/Couchet painter. They are exceptionally beautifully painted, making use of the natural flow of the paint from the brush in a way not characteristic of the other decorators. The arabesques are balanced but in fact highly asymmetrical, and this produces a vitality and rhythm that is lacking



Photo 7-21 Soundboard painting on the 1633b AR double-manual harpsichord. The ribbon containing the date (not legible here) can be seen between the wreath and the spine.
Scale 1:4

in the arabesques of the other Ruckers soundboard painters.

Andreas II became a member of the Guild of St. Luke at the age of 30 in 1637 (Andreas I was then 58). It seems probable that Andreas II, who was also married in 1637, set up his own workshop then independently of his father. This would suggest that Andreas II would have engaged his own soundboard painter to work for him. In fact the single-manual harpsichords of 1637 in Nuremberg and of 1648 in Copenhagen, and some details of the 1644 6-voet double virginal in Leipzig, are painted with a somewhat different style of arabesque, and the leaves are shaded differently, although the motifs and flower heads are painted in a very similar style. Are two decorators involved here? The differences in the painting styles are probably marked enough to justify a division into two separate painting decorators. But the single harpsichord in Antwerp of 1644 signed ANDREAS RVCKERS DEN OVDEN ME FECIT ANTVERPIÆ (i.e. by Andreas I) and the single in Traquair House, Innerleithen signed ANDREAS RVCKERS AND(REAS) F(ILIUS) ME FECIT ANTVERPIÆ (by Andreas II) seem definitely to have been decorated by the same person. It thus does not seem possible to make a distinction between the instruments of Andreas I and Andreas II on the basis of the decoration. Even though the soundboard decoration style seems slightly different on some instruments I have therefore decided not to sub-divide the late Andreas instruments into two clearly separate styles since this does not lead to a distinction between the instruments of the two Andreas, and

because the 1637 and 1648 harpsichord paintings still bear a strong resemblance to the other late instruments signed by Andreas Ruckers.

Soundboard preparation, painting medium and pigments

A number of Ruckers soundboards are varnished over the wood and paint of the soundboard paintings. But most of the Ruckers soundboard paintings are un-varnished and the paint has a light, fresh appearance rather than the thick oily appearance of the paint under varnish. It is clear that the varnish is a later addition and that it was not the Ruckers normal procedure to varnish their soundboards after painting,

On the other hand it is equally clear that the soundboards were prepared in some way before painting so that the paint was not applied directly to the bare wood. All genuine Ruckers soundboards are shiny and reflective underneath the matt appearance of the painted groups, and the pores of the wood are filled. Also the colour of a Ruckers soundboard is a characteristic mellow brown-amber. The material used to size the soundboard is unknown, but was probably a simple thin glue, or more likely a shellac preparation. Both of these would fill the wood grain and prevent the paint from running along the pores away from the intended edge of the painted surface. The colour of the wood is caused by the breakdown of the organic material of the size resulting from exposure to the air and to light, and could occur for either glue or shellac. The surface of Ruckers soundboards is not sticky when touched

with a slightly damp finger as it would be if glue size were used. Although glue may have been used as an initial sizing material, it seems likely that at least the last size application was shellac.

No rigorous investigation has, to my knowledge, been carried out to determine the painting medium or pigment materials used by the Ruckers soundboard painters. Whatever the painting medium is, it is highly water soluble. This means that it is not oil, egg tempera, or an oil emulsion. The most likely possibility is gum arabic, which was used on soundboards in 18th century France and gives similar effects to those found on Ruckers soundboards. Also possible are cherry gum, which produces similar effects to gum arabic and which would have been available locally. A glue size made either from animal or fish bones is also a possibility, although less likely in view of the well established use of gum media in other branches of decorative art.

The pigments available to the Ruckers soundboard painters are quite restricted in number. It is unlikely that a scientific analysis of the pigments will lead to a palette much different from that which is suggested here. The list which follows has been compiled on the basis of several contemporary manuals on painting which give the preparation and use of painting grounds, media, and pigments,⁷⁻⁹⁾ and also a modern knowledge of 16th and 17th century pigments.⁷⁻¹⁰⁾

White: Leadwhite or flake white

Black: Ivory black or bone black; lampblack; charcoal
black or vine black

Browns: Italian umber and burnt umber; brown ochres;
asphaltum

Red-browns: Iron oxide reds - Venetian red; English red;
Indian red; Pozzuoli red; etc.

Reds: Red ochres and red earth; burnt sienna

Reds: Carmine and cochineal (unstable in water colours)
Vermillion or cinnabar

Red lead or minium - heated flake white

Indian lakes

Orange: Realgar - heated orpiment; orange lead or minium

Yellows: Yellow ochre (sienna); massicot - heated flake
white; orpiment; Naples yellow

Greens: Malachite or mountain green or green verditer;
terre verte; verdigris or Spanish green

Blues: Ultramarine; azurite (blue verditer); smalt;
indigo

It seems almost certain that some colours such as orange, green and purple would have been made by mixing pigments of the primary colours. It is thus possible that the actual number of pigments used by the Ruckers decorators was quite small indeed.

Ruckers roses

The rose forms the focal point of the Ruckers soundboard. Surrounded by a wreath painted on the soundboard, the rose and soundboard bevel are gilded with gold leaf,

probably using varnish as a size. The Ruckers roses portray an angel playing a harp with the initials of the builder on either side. The rose is cast with four tabs around its outer edge, over which cloth strips were glued to the lower surface of the soundboard when the rose was glued in position in the rose-hole.

It has often been supposed that the rose was made from a lead-tin alloy similar to that used for organ pipes. However, analysis of the material of two Ruckers roses shows that the material of the rose is almost entirely of lead. The composition has been found to vary from about 98% lead, with 1.7% tin impurity for the 1594 HR single-manual harpsichord⁷⁻¹¹⁾ to 99.9% lead with about 0.1% copper impurity for the 1608 AR double-manual harpsichord.⁷⁻¹²⁾ This variation in composition is well within the limits of what one would expect from the impurities present in naturally occurring lead ores, and indicates that there was no attempt to introduce tin to produce an alloy similar to organ pipe metal.

The very earliest Hans Ruckers instrument, the double muselar virginal of 1581 in New York, is exceptional in that it does not have a rose with the maker's initials. Instead it has three parchment-and-wood soundboard roses cut in geometrical patterns. All of the other Hans Ruckers instruments have the rose shown in Photo 7-22. The 1594 HR harpsichord-virginal combination in Köpenick, East Berlin has this rose in the virginal part and a parchment-and-wood rose in the harpsichord part. The (1591)^b HR double

muselar virginal in Cambridge, Mass. and the (c1600) HR double spinett virginal have the metal HR rose in both the mother and the child parts. But here the rose in the mother has the usual diameter of 65 mm, although the child part has an appropriately smaller rose of diameter 58 mm. In all subsequent Ioannes and Andreas double virginals, the rose is of the same diameter in both the mother and child parts.

All instruments with the rose shown in Photo 7-22 are signed HANS RVCKERS ME FECIT ANTVERPIÆ. But during the period between 1595 and 1598 (unfortunately none of the instruments from this period has an original date), instruments begin to appear which are signed IOHANNES RVQVERS ME FECIT ANTVERPIÆ and use a rose which still has the initials HR, but differs from the earlier rose in several details, most notably in the absence of the angel's right wing (Photo 7-23). The combination of the change in both the signature and the rose seems to suggest that the later instruments are by Hans Ruckers' son Ioannes. Two instruments which can be dated 1598 and 1599, of which one was certainly built after Hans Ruckers' death in 1598, have the later rose and signature and can be ascribed to Ioannes Ruckers. This then leaves only four virginals and one single-manual harpsichord/virginal combination which can be ascribed to Hans. There is no surviving double-manual harpsichord by Hans Ruckers.

Up until 1615, and his court appointment, Ioannes Ruckers used a rose similar to that shown in Photos 7-23 and 7-24.



Photo 7-22 Hans Ruckers rose from the 1594 HR harpsichord.
(Note the presence of the angel's right wing.)

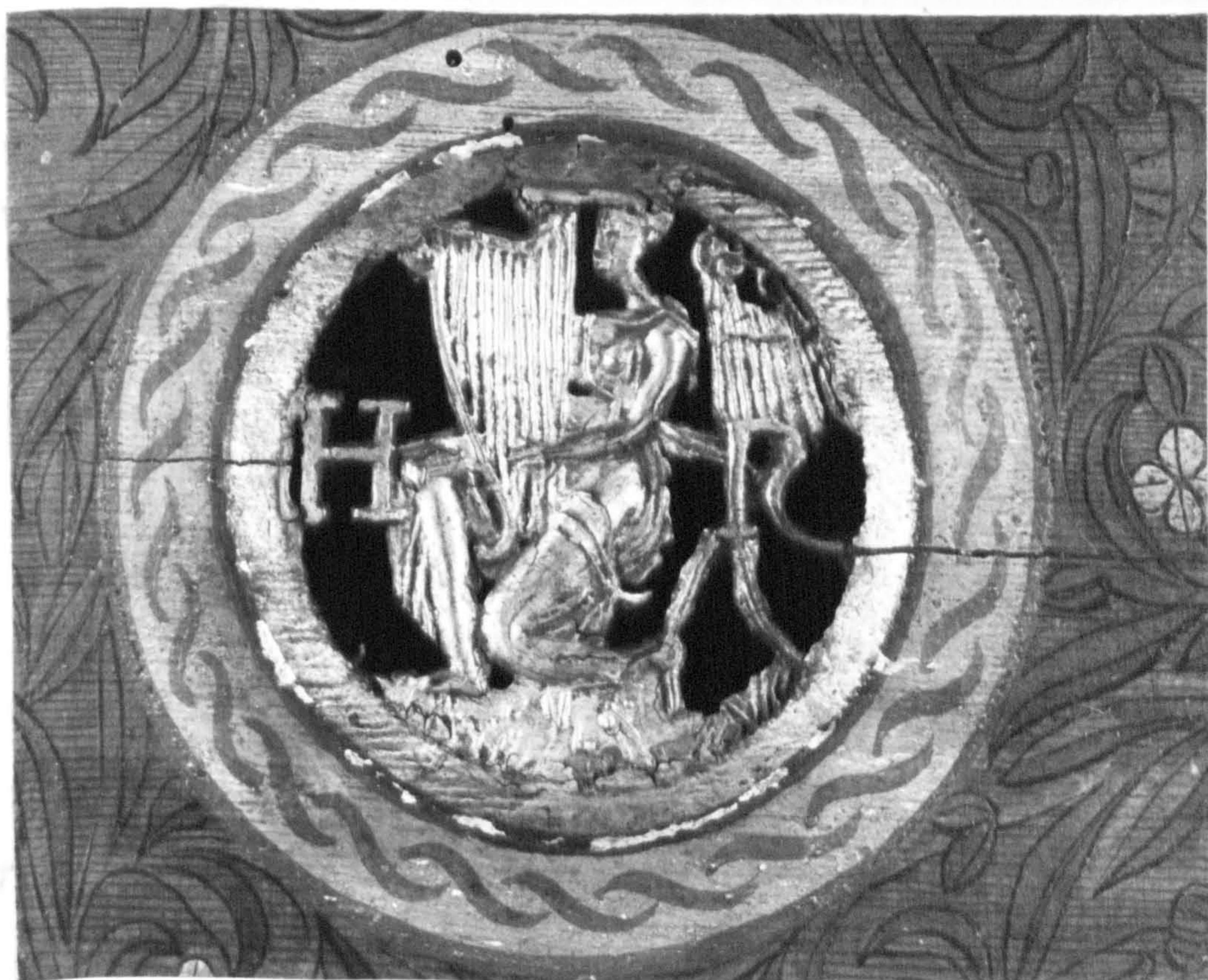
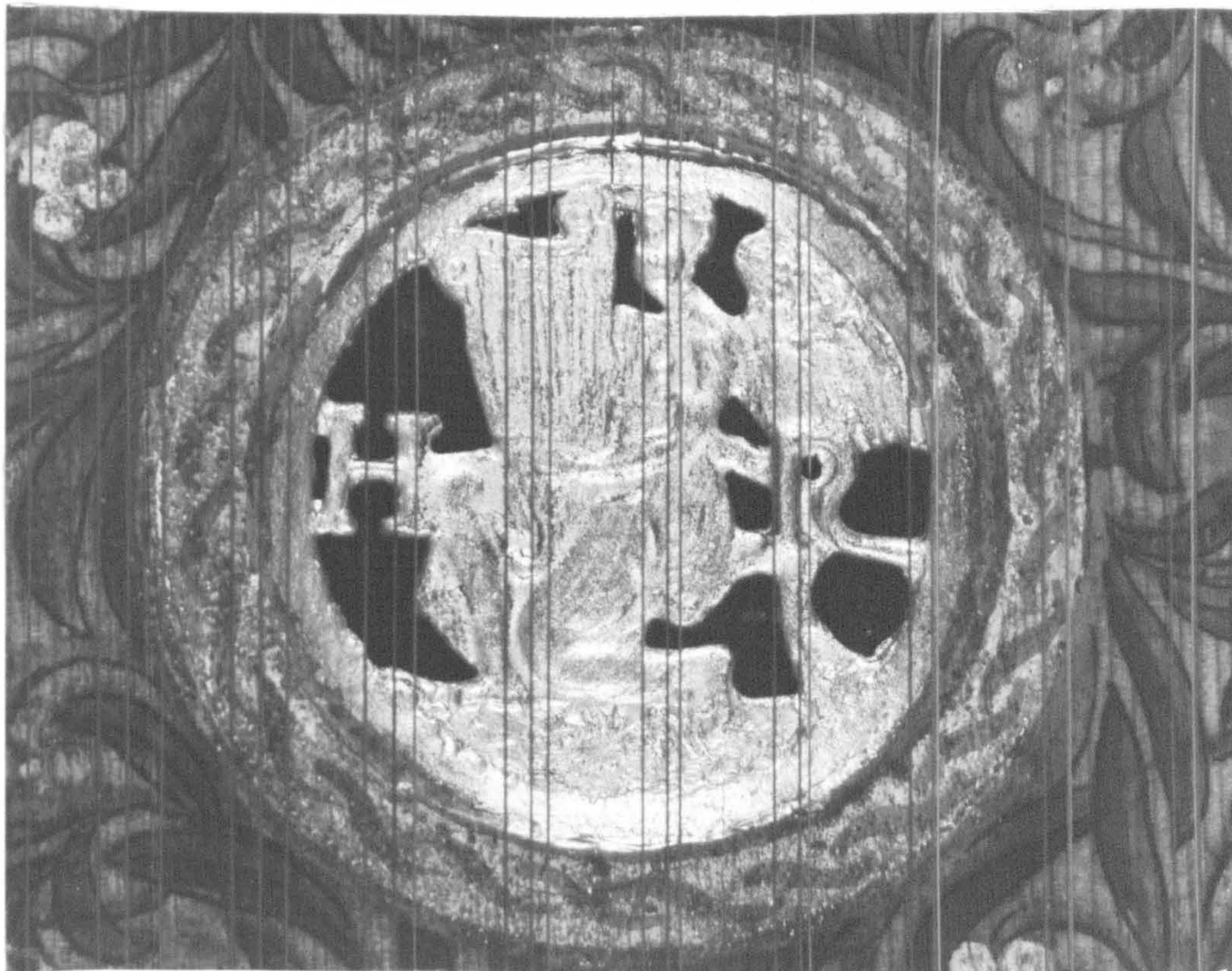

Photo 7-23 and Photo 7-24 Two castings of the HR rose used by Ioannes Ruckers before 1616. The top rose (1612a HR) is sometimes cast in papier mâché. The bottom rose is from the 1610 HR mother virginal. Scale 1:1

A number of different castings were made and sometimes the rose was made of papier mâché instead of the usual lead alloy, but the figure of the angel is always lacking its right wing. Also after 1599, the instruments are signed using the form IOANNES RVCKERS rather than IOHANNES RVQVERS. One instrument from this period, however, has the signature IOANNES ET ANDREAS RVCKERS FECERVNT, and the date 1604, and is clearly from the period in which the two brothers were sharing their father's old workshop. This period ended in about 1605 when Andreas I set up a workshop independently of his brother and began using the AR rose shown in Photo 7-33.

In 1615 Ioannes Ruckers was appointed clavichord and clavecimbel builder and tuner to the archducal court of Albert and Isabella in Brussels. Apparently in keeping with his new image at court, he decided to freshen up the image presented by his instruments by altering the rose in a way which is not only elegant, but which does not seem to have been done before or since the time of Ioannes Ruckers and his successor Ioannes Couchet. Instead of having just one rose re-cast, Ioannes Ruckers now used three different roses, one for virginals, another for single-manual harpsichords, and a third for doubles. Ioannes also now used the initials IR instead of the earlier HR also used by his father.⁷⁻¹³⁾

The rose used in the virginals built by Ioannes Ruckers after 1615 is shown in Photo 7-25, and has, like the earlier HR rose and the AR rose used in all instru-



Photo 7-25 The Ioannes Ruckers virginal rose (1629 IR) used from 1617 to 1640.

Scale 1:1



Photo 7-26 The Ioannes Ruckers virginal rose (1642a IR) used in 1642.

Scale 1:1

ment types, a diameter of about 65 mm. This rose has a characteristic star-shaped pattern on the rear surface, consisting of 4 equally spaced intersecting lines. This pattern seems to have been produced by a backing plate used to squeeze out excess lead during casting, and is lacking on the Andreas Ruckers and Ioannes Couchet roses. In his single-manual harpsichords Ioannes used a 73 mm diameter rose (Photo 7-27) and in the larger double-manual harpsichords he used the larger 85 mm diameter rose shown in Photo 7-28. Both of these harpsichord roses are hollowed out on the rear surface in authentic instruments. This hollowing considerably lightens these roses which have a much greater relief than the other Ruckers roses and was produced by tipping out the excess lead from the mould before the lead in the casting had completely cooled and solidified. Sometime between 1638 and 1642 (the 1640a IR 5-voet virginal now in the Gemeente Museum, The Hague, has lost its original rose) it appears that the old mould for the virginal roses was broken or lost, and a new virginal rose had to be cast. This new rose is very similar to the old virginal rose but is larger and ^{of} a slightly different design (see Photo 7-26). This rose is found only in the 1642 IR virginal in Stockholm. The use of a different rose for each type of instrument was carried on by Ioannes Couchet after his uncle's death. Couchet simply used the same design for each rose as Ioannes Ruckers had done, but in the new castings he changed ^{the} second initial from an R to a C. Naturally, Couchet copied the new Ioannes Ruckers



Photo 7-27 The Ioannes Ruckers single-manual harpsichord rose (1637a IR) used after 1617.

Scale 1:1

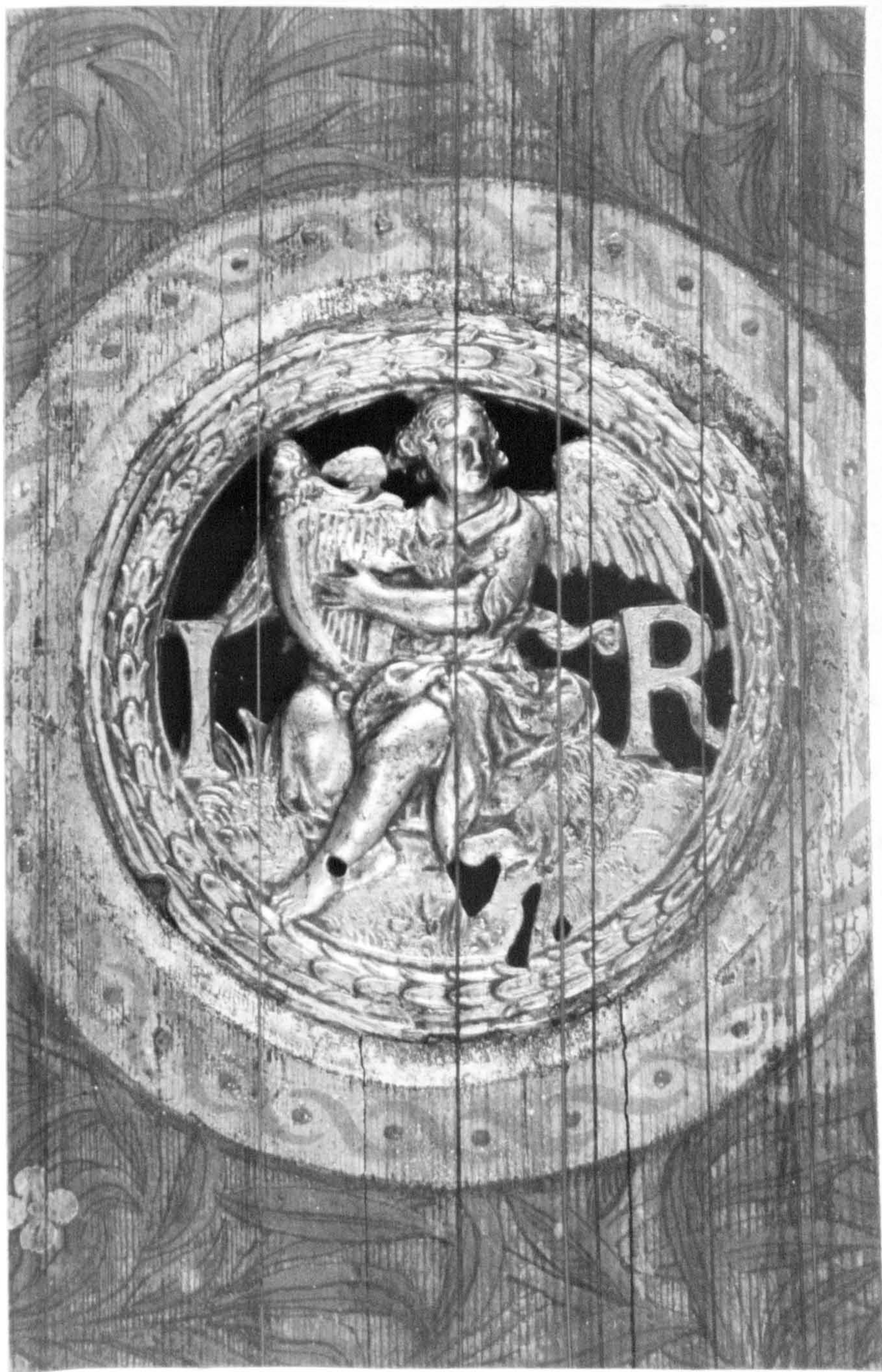

Photo 7-28 The Ioannes Ruckers double-manual harpsichord rose (1618b IR) used after 1617.

Scale 1:1

virginal rose so that the Couchet virginal rose is like the 1642a IR rose and not the earlier Ioannes Ruckers virginal roses. Photos 7-29 to 7-32 show the three types of Ioannes Couchet soundboard roses. Like the Ioannes Ruckers harpsichord roses, the authentic Couchet harpsichord roses are also hollowed out on the rear surface. The only virginal IC rose (1650a IC) has a flat rear surface.

The two Andreases, father and son, were less inventive and used only one type of rose in all instrument models. Several types of AR rose do occur however. The rose shown in Photo 7-33 was used from 1608 to 1636. Around 1637, perhaps for the occasion of Andreas II's entry into the Guild of St. Luke, a new, but only slightly different AR rose, was cast (Photo 7-34). This later rose seems, however, to have been used by both the elder and younger Andreas after 1637 and unfortunately cannot be used to differentiate the work of the two in a way which parallels the method used to distinguish the overlapping activity of Hans and Ioannes. But it should also be noted that the single-manual harpsichord in Traquair House, Innerleithen has a different rose (see Photo 7-35) from the post-1636 rose shown in Photo 7-34. This harpsichord is signed ANDREAS RVCKERS AND(REAS) F(ILIUS) ME FECIT and is therefore definitely by Andreas II, and is the only extant instrument which can definitely be attributed to him. Does this mean that this is the only instrument actually made by Andreas II, that the rose shown in Photo 7-35 was that used by Andreas II, and that all of the others with the rose shown in Photo 7-34 are by Andreas I?

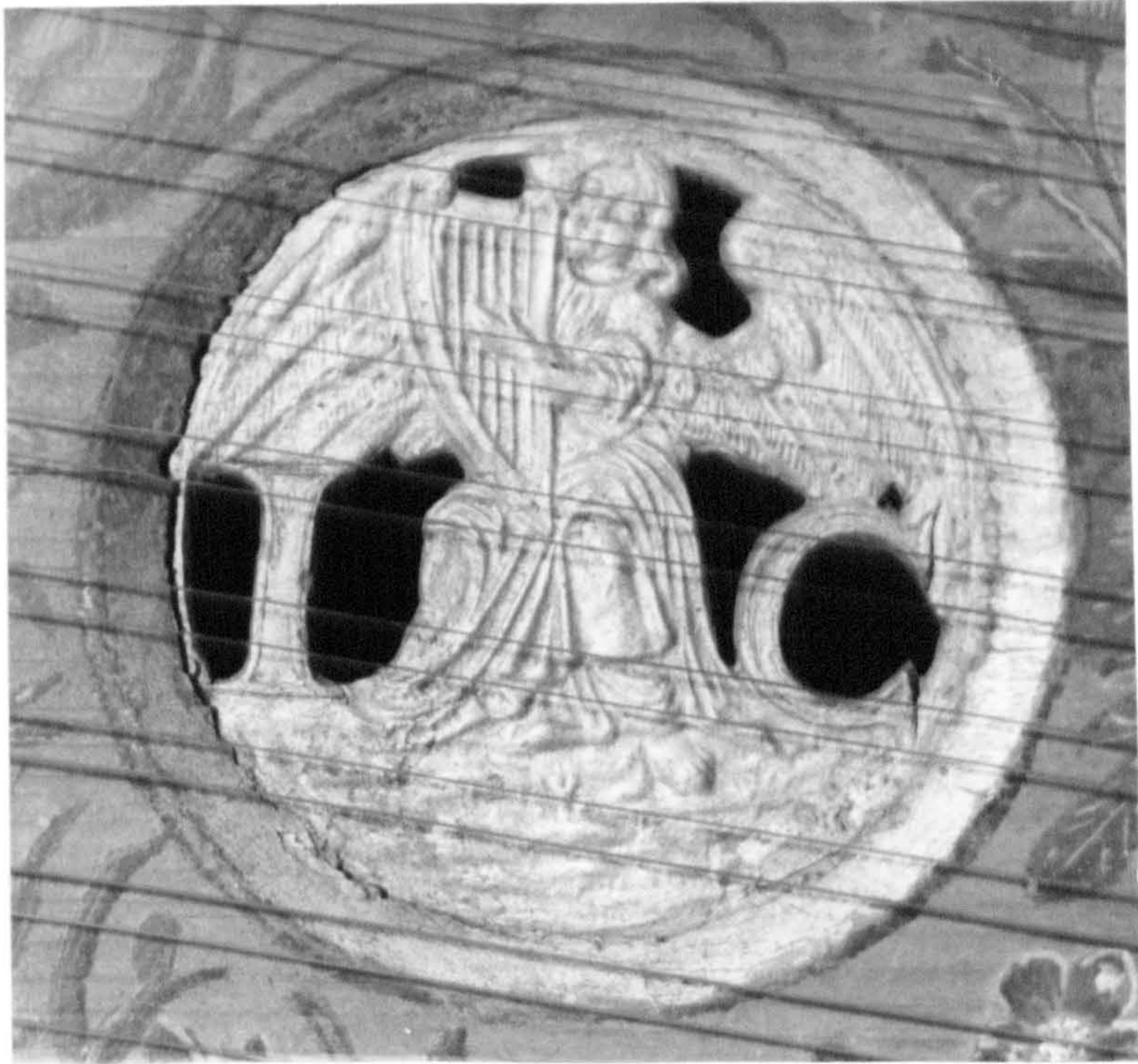

Photo 7-29 The Couchet virginal rose (1650a IR).
Scale 1:1



Photo 7-30 The Couchet single-manual harpsichord rose
(1645 IC).
Scale 1:1

(466)



Photo 7-31 The Couchet double-manual harpsichord rose.

Scale 1:1.

(467)



Photo 7-32 Rear view of the Couchet double-manual harpsichord rose.

Scale 1:1



Photo 7-33 The Andreas Ruckers rose used in all types of instruments from 1608 to 1636.

Scale 1:1



Photo 7-34 The Andreas Ruckers rose used in all types of instruments from 1636 to 1654.

Scale 1:1

The problem is complicated by the uncertainty of the date of the Traquair harpsichord which has been given as 1651 in the literature, but which appears to be 1641 before it was re-touched by J.J.K. Rhodes in a restoration of some years ago (see Photo 7-36). Another harpsichord of 1651, in the Victoria and Albert Museum, London, has the usual post-1636 type of rose, as does the 1654 AR harpsichord in Nuremberg. Was Andreas I, by then aged 75 years, still alive and working in 1654? The uncertainty of the date of the Traquair harpsichord, and the uncertainty of the date of death of Andreas Ruckers II, unfortunately does not allow a definite distinction to be made between the instruments of Andreas I and Andreas II.

Lid and keywell flap decoration

In addition to having painted keywell and soundwell decorations, the earliest Ruckers instruments also have painted lids and keywell flaps. The only surviving examples of these lid paintings are found exclusively on virginals. They appear to be painted in oils, and are colourful if somewhat stiffly painted. Like the soundboard paintings they are stylised, naive decorative art, and do not belong to the fine art of Marten de Vos (1532-1603) or Vredeman de Vries (1527-1606), although they are not far removed from the oil canvasses of say Marten van Valckenborch (1535-1612) or Joris Hoefnagel (1542-1600), all of whom were active around 1580 to 1600.

These earliest lid decorations are genre paintings portraying elegantly dressed figures, some dancing, loung-



Photo 7-35 The Andreas (II?) Ruckers rose in the (1651)a AR single-manual harpsichord.

Scale 1:1



Photo 7-36 Photo of the re-touched painting of the date on the (1651)a AR single-manual harpsichord. Was this 1641 before being re-touched?

Scale 1:1

ing, courting, eating, making music, boating, etc. The scenes usually include a bower or a fountain, a gothic castle, a canal or river with a boating party, and sometimes a hunting scene. They seem designed to show the wealthy middle-class at leisure in elegant surroundings, quietly enjoying themselves.

The Marten van der Biest double virginal in Nuremberg, and the Iohannes Bos virginal in Tordesillas seem to be painted by the same artist as the early Ruckers instruments, and the Iohannes Grauwels virginal in Brussels is painted in a very similar style. The Bos virginal and the (c1600) HR double virginal are interesting hybrids in that they combine a painted lid decoration, with a papered keywell, soundwell and front flap.

A number of later Ruckers instruments have painted lid decorations, and some of these are also genre paintings. Most of them however belong to the sphere of fine art and are by well known Flemish painters: Pieter Codde II (1608 AR), Jan Brueghel I, Hendrik van Balen and Paul Brill (1612 IR) and Artus Wolfort (1640b IR and 1646b AR). Many instruments have extremely fine lid and lid flap paintings by anonymous artists (1628b IR, 1632 IR, 1638b IR, 1642b IR, 1614 AR, 1628 AR, 1636 AR). These and others are dealt with individually as they arise in the catalogue. The correspondence between B. Gerbier and Sir F. Windebank (Appendix 16) indicates that even Rubens was commissioned to paint the lid of a Ruckers harpsichord, although unfortunately no instrument has survived with a lid paint-

ing by this eminent painter.

But most Ruckers clavecimbel probably originally had papered lid and keywell flap decorations. The interior lid decoration consisted of the wood-grain papers with Latin mottoes written across them, and these were surrounded by a strip paper pattern, a strip of clear varnished wood and finally a border next to the edge of the lid painted in black. The joins between the interior wood-grain paper and the strip border, the strip border and the varnished wood, and the varnished wood and the black outside border are each covered by a thin (3-4 mm wide) red line painted in a water soluble vermillion paint. About 12 to 15 mm inside the edge of the paper strip pattern there is another 3-4 mm-wide line usually painted in black around the edge of the wood-grain papers. (Occasionally this line is painted in vermillion, in which case the printed strip paper edges are covered with black paint instead of the usual red.) The corners of these thin edgings, whether black or red, are elaborated with a trefoil, a tear-drop, or some other ornament depending on the decorator and period in which he was working.

In single-manual harpsichord the lid flap is a flat surface like the main portion of the lid and is decorated in a way similar to the main lid. In double-manual harpsichords, the lid flap is framed with a heavy moulding. Here the printed strip pattern touches the inside of the moulding and the wood-grain pattern fills up the whole of the area inside this. The edge of the strip pattern next



Photo 7-37 Interior lid decoration on the 1633a AR
6-voet virginal.

Scale 1:10



Photo 7-38 The interior lid decoration on the 1648 AR single-manual harpsichord.

Scale 1:10

to the moulding is not painted over with a thin line, but the rest of the papered surface is decorated like that of the main lid.

The keywell flap is decorated either with one of the wider paper patterns alone (the dolphin pattern Type 3 or 4 was not used, however), or with a narrow strip pattern and the wood-grain paper with a Latin motto. Of the wide strip patterns Type 2 is by far the most common keywell flap paper, although Type 12 and 15 also sometimes occur. Because the keywell flap is very narrow the varnished border is often lacking. If present it is, like the black edging, narrower than on the main lid or lid flap.

The Latin mottoes are painted in black Roman capitals on the wood-grain papers. The mottoes seem to have been chosen to suit the space they were intended to fill. SIC / TRANSIT / GLORIA MVNDI, for example is particularly well suited to the main lid of a harpsichord which is narrow at the top and wide at the bottom, and needs words whose length is in proportion to the space available. Virginal lids, on the other hand, usually have 4-word mottoes with words each of roughly the same number of letters. Short 3-word mottoes such as ACTA VIRVM PROBANT are used for harpsichord keywell flaps, and longer 4- and 5-word mottoes are used on virginal keywell flaps. When the mottoes did not quite match the space they were required to fill, extra 'bubbles', 'stars', arabesques or other ornaments were used to fill up any left-over space.

The line mottoes used on authentic Ruckers instruments are the following. These do not, of course, include unusual mottoes which have been added to genuine Ruckers instruments by later restorers. Those words in parenthesis are variants and are only sometimes present.

GLORIA DEO

OMNIS SPIRITVS LAVDET DOMINVM

MVSICA DVLCE LABORVM LEVAMEN

SCIENTIA NON HABET INIMICVM NISI INGNORANTEM(sic)

ARS NON HABET INIMICVM NISI IGNORANTEM

DVLCISONVM REFICIT TRISTIA CORDA MELOS

MVSICA MAGNORVM (EST) SOLAMEN DVLCE LABORVM

AVDI VIDE ET TACE SI VIS VIVERE IN PACE

ACTA VIRVM PROBANT

MVSICA LABORVM DVLCE LEVAMEN

CONCORDIA RES PARVAE CRESCVNT DISCORDIA MAXIMAE DILABVNTVR

SOLI DEO GLORIA (ET SANCTVM NOMEN EIVS)

SIC TRANSIT GLORIA MVNDI

MVSICA LAETITIAE COMES MEDICINA DOLORVM

CONCORDIA MVSIS AMICA

MVSICA DONVM DEI

NON NISI MOTA CANO

The sources and significance of some of these mottoes are discussed in an interesting article by Thomas McGeary.⁷⁻¹⁴⁾

Outer case decoration

The virginal outer case decoration seems always to have been done in imitation green porphyry marble. This consists of a dark olive green background colour onto which

off-white paint tinted with the base colour has been splattered while the base colour was still wet. The splattered paint gives the surface a rough texture which is often visible under subsequent layers of more recent paint. I have not found any other type of virginal outer case decoration which I could identify as being definitely original - it was used from the first Hans Ruckers virginal of 1581, right through until the 1640's. The entire case side was painted from top to bottom in imitation porphyry without any upper and lower grey (imitation iron) bands, although some of the early Hans Ruckers virginals have a white line painted around each side of the lid about 35 mm from the edge of each face.

The harpsichords on the other hand have a slightly more elaborate outer case decoration. They were painted to imitate either a red marble with grey iron straps above and below, or to imitate a complicated strap-work pattern with large round or faceted stones held in place by grey iron straps studded with brass buttons against a red marbled background.⁷⁻¹⁵⁾ The marbling is done with a brown/red (iron oxide?) background which was allowed to dry before the scumble was added. The scumbling was done with semi-transparent layers of paint in several shades of grey, a pinkish-yellow ochre and black and white, or sometimes just using darker and lighter shades of the background colour. This seems to have been done with the fingers without the use of a mop or solvent to soften the scumble. The result is not very realistic. The stones



Photo 7-39 Typical plain outer case marbling on a harpsichord (1637b IR).

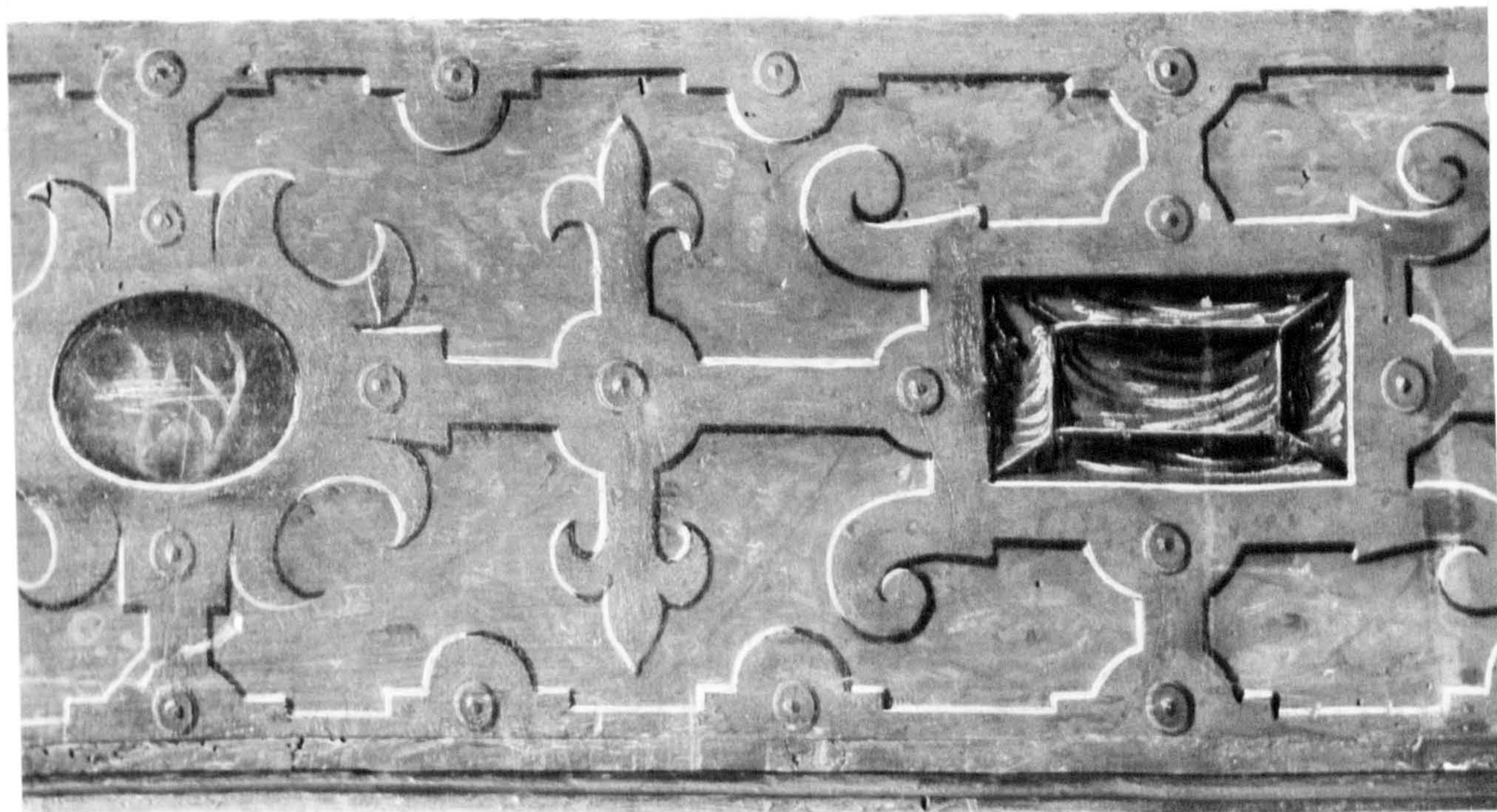

Photo 7-40 Outer case strap-work decoration on a harpsichord (1637 AR).

Scale in both photographs 1:3

of the strap-work pattern are 'marbled' in a manner similar to the background marbling, and highlights and shadows are added to the stones, brass studs, and iron strapping to give the appearance of depth.

The lid and keywell flap are also marbled to match the case sides. Usually the outer reinforcing mouldings on the harpsichord lids and the lid hinges, which are often quite decorative in their own right, are marbled over as though they did not exist. Again I have not found any Ruckers harpsichord which does not seem originally to have been marbled either plainly or with the strap-work design. But I think that even the most ardent admirer of the Ruckers would have to agree that the marbling technique of the Ruckers decorators is at best primitive and naive, and it is little wonder that the original marbling was later removed or over-painted.

Mouldings

The top of the case sides of Ruckers clavecimbels were decorated on the inside edge with an ogee moulding which was left as clear varnished wood, without paint or gilding. On the larger harpsichords and virginals this is positioned normally, but on the smaller virginals (the $4\frac{1}{2}$ -voet, 4-voet, child and $2\frac{1}{2}$ -voet) with thinner case sides, the moulding is placed sideways at 90° to the usual position in order to leave more wood on the top edge of the case side. This top edge is painted black and borders with the outer case marbling or iron straps. The top of the nameboard in harpsichords, and the entire

faceboard and nameboard in virginals is capped with a double moulding consisting of two of the case ogee mouldings placed back to back. A characteristic of the earliest Ruckers instruments (and Flemish instruments generally) is that the lower surface of this added part of the moulding is rounded instead of being flat (see Fig. 5-1). The keyblocks in harpsichords (only the lower manual keyblocks in double-manual harpsichords) also have this same case ogee moulding left in clear varnished wood with the top of the keyblock painted black. Slight differences in the ogee mouldings on the same instrument, and the way in which the mouldings on the keyblocks are cut indicates that a left- and a right-handed moulding plane were used. Use of these two planes was essential to eliminate any problems of the grain direction, and enable the two mouldings on either edge of the jackrail, for example, to be made by planing both mouldings in the same direction. The lid, lid flap and keywell flap are left un-moulded.

The composite keywell moulding at the bottom of the keywell along the front of the baseboard is also left in varnished wood except for a red stripe in the central concave part of the moulding (see Fig. 6-1). The flat un-moulded bottom part of the moulding, the edge of the baseboard and the front flap' recesses in the case sides are all painted black. On the smaller $4\frac{1}{2}$ -voet and 4-voet sizes of virginal only the bottom part of this moulding is used, thus decreasing its total height. This probably

means that the moulding plane used to cut this moulding had two blades, one of which was withdrawn to cut the lower moulding for the small virginals. This same half-moulding also appears on the lower manual batten of the double-manual harpsichords.

The soundboard moulding and the moulding on the 8' hitchpin rail on harpsichords, and the small raised block for the hitchpins of the bass strings in muselar virginals, is left entirely in clear varnished wood. The ovolo mouldings on the interior lid dustcatcher batten are also varnished with the central flat portion of the batten painted black. The moulded parts of the wide interior lid flap on double-manual harpsichords are left in clear varnished wood and the flat sections are painted black. The harpsichord namebatten and its moulding were also left clear, and the signature, bordered by two thin (about 2 mm) black lines, was painted in Roman capitals onto the varnished wood. In double harpsichords the lower manual is decorated with a strip paper pattern with a thin border of vermilion paint around the paper. The rest of the batten is left clear. The moulded part of the top of this batten is the same shape as the bottom part of the lower keywell moulding below the ends of the keys, as already explained (see Fig. 6-1).

Both edges of Ruckers jackrails have ogee mouldings with the same profile as those on the case sides. On harpsichords, the top surface of the jackrail is painted black and covered with one of the strip paper patterns surrounded

by a red vermillion line, and the mouldings are left as usual in varnished wood. On virginals the jackrail always bears the signature of the builder, and this is painted in a manner similar to that of the harpsichord namebatten with black Roman capitals between two narrow black lines on clear varnished wood. Because the virginal jackrail is tapered in width the letters of the signature get smaller and, in proportion, slightly closer together towards the right-hand end of the jackrail. The virginal jackrail supports are also left clear and are decorated on the sides with arabesques of a style similar to those on the soundboard, and with dots and 'I's on their edges.

On Ioannes Ruckers double-manual harpsichords the sides of the lower manual keyblocks are decorated with a rope pattern with dots at the centre of each loop in the rope. The keyblocks on Andreas doubles and some singles are covered with one of the strip patterns. The curved ends of the upper manual keyblocks of both Andreas and Ioannes Ruckers doubles were left undecorated and entirely in clear varnished wood.

Key arcades

Although now missing on most Ruckers clavecimbel's, the keyboards probably all originally had arcades on the keyfronts of the natural keys under the bone plates. The bone plates project about 3 mm beyond the angled front end of the wood of the natural key, and this helped somewhat to protect the arcades, But their extremely fragile nature,

and their exposed position has meant that they have been damaged and lost on most instruments with original keyboards.

Each arcade consists of two parts: the front of the arcade is of a heavy paper embossed with a Gothic design of arches and florets. The edges of the design are incised to leave only the embossed pattern pierced with holes through which the background, the second part of the arcade, can be seen. This background is of parchment or paper dyed red. The dye used to colour the background was highly fugitive (and therefore probably one of the lakes). It is now usually discoloured a dark brown colour except where a bit of the pierced Gothic design has broken away to expose the unaltered original background colour. On the two earliest Ruckers instruments, the background is a piece of re-used parchment with Hebrew characters written on it. It has been suggested that this might reflect the fact that Hans Ruckers lived on the Jodenstraat, the Jewish Street. But Ruckers had not bought 'de clein clavesingel' on the Jodenstraat until 1597, or until at least 14 years after these instruments were made. Nonetheless there were many Jews living in Antwerp at this time and it is not surprising to find a disused parchment written in Hebrew on these instruments.

It appears that the front paper part of the arcade was embossed and incised in one operation. The cutting of each arcade is exactly the same as every other, and often a slight error in the cutting is repeated again and

again on each arcade.

Two slightly different arcades appear to have been used (see Photo 5-4). Type A, which is probably the most common, is found on instruments by Ioannes Ruckers and Ioannes Couchet. Type B has a sort of indented embossing and was used on instruments by Andreas Ruckers.

Locks and strap hinges.

The strap hinges and the locks often found on Ruckers instruments are at once both functional and decorative. Strap hinges seem always to have been used on the lid of double harpsichords, probably because wire hinges were too weak to support the weight of the large lid. But the decorative lock and hasp also found on doubles seem to be a part of the luxury of a large instrument. On single harpsichords and on virginals the lid and flap usually have simple wire hinges and simple wire eye-and-hook closures. But some single harpsichords and some virginals have brass strap hinges and a decorative lock, presumably because the clients who bought these instruments could afford the extra luxury. Photo 3-41 shows a typical main lid strap hinge, a lid flap hinge and a lock.

In conclusion

The purpose of the paper patterns used by the Ruckers family on their instruments seems to have been to imitate the painted vine- or scroll-work, or perhaps the niello or intarsia that was popular in this period. In fact, one of the important principles of Renaissance decoration was that the imitation of exotic woods, marble,

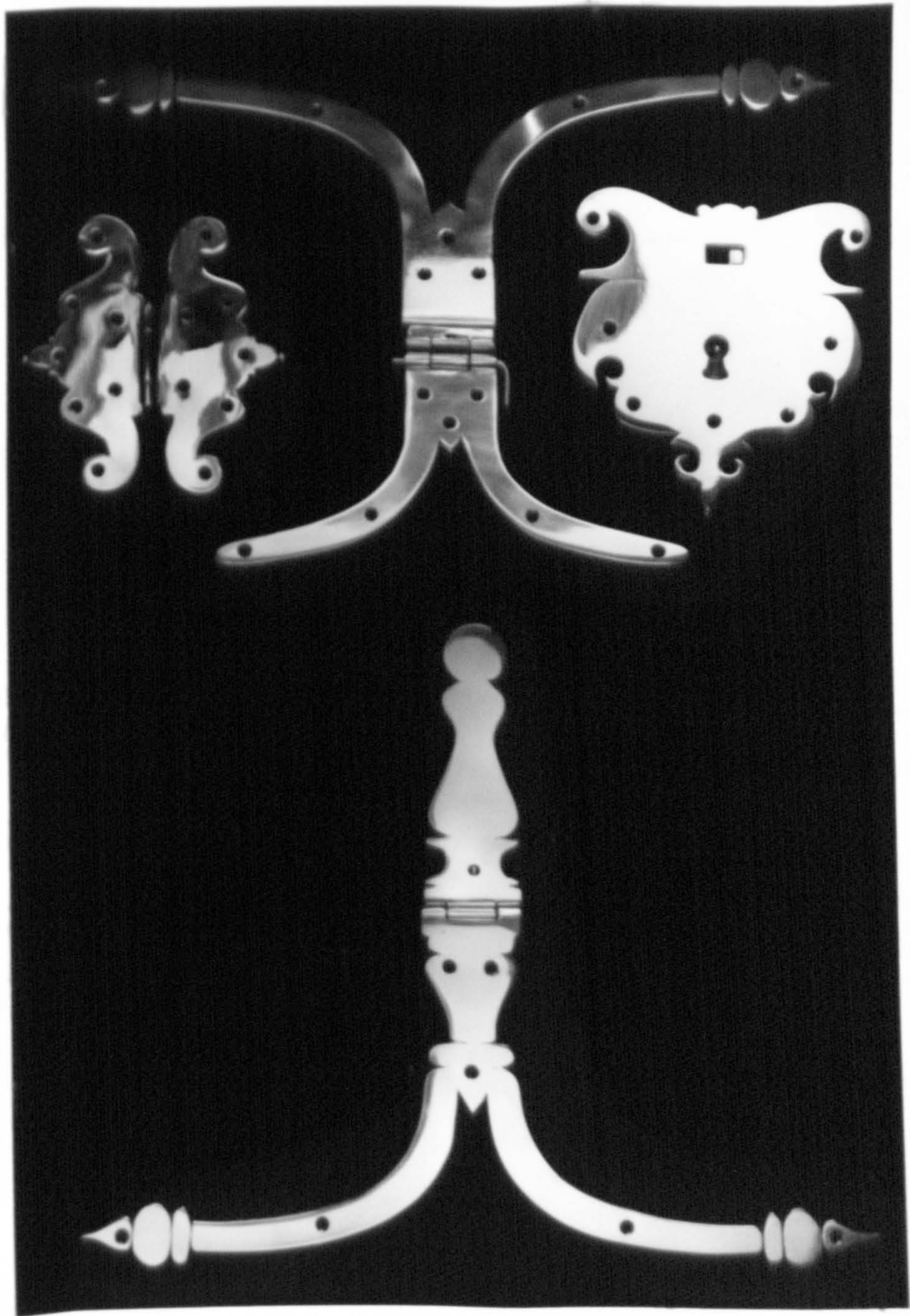

Photo 7-41 Typical Ruckers hardware. Above (from left to right) are a lid-flap hinge, a spine main-lid strap hinge and a lock escutcheon. Below is the lock hasp and its strap hinge. (These are modern copies by the author.)

Scale 1:2

ivory, or any natural material was in bad taste. The fact that most of the decoration on Ruckers instruments is imitative, seems to be not so much a question of their being in bad taste as a reflection of the changing tastes at the beginning of the Baroque, when natural materials were freely imitated, often to the point where it would have been easier to use the genuine substance. This changing taste seems to be clearly indicated in the Ruckers instruments. The two earliest dated instruments, the 1581 HR and the 1583 HR virginals, both have no printed papers but instead have a beautiful and intricate hand-painted decoration. The next two dated instruments 1591a HR and 1594 HR, were both originally papered and it seems fairly certain that all subsequent instruments had block printed paper decorations.

But although the 1581 HR double virginal had painted interior decoration, and not the cheaper papered patterns, the original exterior decoration of the mother virginal was the usual faux porphyry marble which was used to decorate all of the succeeding virginals. Thus even at this early date the use of imitation marble in an instrument intended for the Spanish aristocracy was not considered in bad taste. It was a minor step in terms of the changing taste, from the painted interior decoration, to the paper patterns on the keywell, soundwell and lid, and a major step in reducing the cost of the instruments. Clearly there was fierce competition among the Guild of St. Luke instrument builders for the custom

of the increasingly wealthy middle-class Antwerp population. The changing taste fitted nicely into the desire to reduce the cost of the instruments in order to make them more competitive and within reach of the typical Antwerp burgher.

Footnotes:

- 7-1) A (perhaps unique) original copy is in the Bibliotheque de l'Arsenal in Paris. There is a modern edition limited to 300 copies printed by Jean Schmidt in Paris in 1908.
- 7-2) D.F. Lunsingh Scheurleer, 'Over het Ornament en de Autenticiteit van Bedrukte Papierstrooken in Twee Clavierinstrumenten', Mededelingen van de Dienst voor Kunsten en Wetenschappen, Gemeente Museum, The Hague, (1939) 45. See also: Ernest Closson, 'L'Ornementation en Papier Imprimé des Clavecins Anversois', Revue Belge d'Archéologie et d'Histoire de l'Arte, II, 2 (1932) 105.
- 7-3) Plates 54 and 57 in Edwin Ripin's 'On Joes Karest's Virginal and the Origin of the Flemish Tradition', Keyboard Instruments, ed. E. M. Ripin, Edinburgh (1971)
- 7-4) No. 812 of the Museo degli Strumenti Musicali. See Maria Luisa Cervelli, 'Per un Catalogo degli Strumenti a Tastiera del museo degli Antichi Strumenti Musicali', Accademie e Biblioteche d'Italia, XLIV, No. 4-5 (1976) 305-343.
- 7-5) Horst Appuhn, Kloster Isenhagen, Kunst und Kultur im Mittelalter, Lüneberg (1966) 82.
Ibid., Riesenholzschnitte und Papiertapeten der Renaissance, Unterschneidheim (1976) 87-92.
- 7-6) The history of this wood-grain pattern may be even longer, with yet an additional generation of papers. Also in the Schweitzerisches Landesmuseum in Zurich is a papered door from the Techtermannhaus, the 'Haus zu Salmen', which came from Fribourg in Switzerland. The door is believed to have been papered in about 1540, and the papers used are very similar to the wood-grain papers on the 1598 HR virginal, although they are not identical. They are, however, related and may well be the parent of the Winkelried papers. They are in such poor condition that a photograph

does not show enough of the detail for a detailed comparison to be made. The occurrence of both of these papers in Switzerland definitely points to this country as the origin of the wood-grain paper.

- 7-7) See Th. van Lerijs and Ph. Rombouts, De Liggeren en andere Historische Archieven der Antwerpsche Sint Lucasgilde, Vol. 1 (1872) 273.
- 7-8) A copy of Collaert's Florilegium in the British Library has a facing page (which may be un-related to the rest of the book) which is dated 1586.
- 7-9) T.T. de Mayerne manuscript in the British Library (Sloane, No. 2052). This has been carefully analysed by J.A. van de Graaf, Het de Mayerne Manuscript als Bron voor de Schildertechniek van de Barok, (University of Utrecht doctoral dissertation) Mijndrecht (1958).
Zahira Veliz, 'Francisco Pacheco's comments on Painting in Oil', Studies in Conservation, 27, 2(1982) 49-57.
- 7-10) R.S. Gettens and G.L. Stout, Painting Materials- A Short Encyclopaedia, New York (1942) repn. Dover, New York, (1966).
Rosamond Harley, Artists' Pigments c.1600 - 1835, Butterworths (1982).
- 7-11) Martin Christian Schmidt, 'Ein Beitrag zum Cembalo-bau von Hans Ruckers aus instrumentenkundlicher und handwerklicher Sicht', Neue Museumskunde, 21 1 (1978) 63
- 7-12) I would like to express my thanks to Dr. Jim Tait of the Research Laboratory of the National Museum of Antiquities of Scotland, who carried out the X-ray fluorescence analysis of the 1608 AR rose materials for me.
- 7-13) The name Hans is a variation of Hannes or Johannes, the Germanic form of Ioannes, or in English, John. Both the Germanic Hans and the Flemish Jan were used as familiar forms in 16th and 17th century Flanders.
- 7-14) Thomas McGeary, 'Harpsichord Mottoes', Journal of the American Musical Instrument Society, VII(1981) 5-35.
- 7-15) See p. 252 for a discussion of the case heights of instruments with the strap-work decoration.

Chapter 8 - The Determination of the Original Compass and Disposition of Ruckers Harpsichords

Since the time in which the Ruckers built their instruments, most of them have been subject at some time in their history to alterations. The harpsichords were the most popular instruments and their keyboards, disposition, scalings, cases and decoration were altered to suit the music and taste of the later periods. Virginals on the other hand, were not only less favoured in the period after the Ruckers were working, but were also not as readily adaptable as harpsichords. It is possible to change the compass of a virginal, but its disposition cannot be altered. It is because of the small amount of alteration possible in a virginal, that any modification is comparatively minor and the determination of its original state - which in fact reduces to the determination of its original compass - is relatively easy. It is because the determination of the original compass and disposition of a harpsichord is much more difficult, and because the range in the type of variation is much greater that this study has been made of the alterations to harpsichords, ignoring for the time being those made to virginals. As a result of the application of the methods developed by me to determine the original state of Ruckers instruments, several new instrument models have been discovered and it has been possible to make certain generalisations about the original state of Ruckers harpsichords.

The original disposition and compass of a harpsichord is obvious when the original keyboards remain intact. Unfortunately because of the widespread adaptation of the Ruckers harpsichords in the late 17th and the 18th centuries only 2 double- and 3 single-manual instruments remain with their original keyboards and disposition.

The altered harpsichords vary in the degree to which they have been changed, and usually the difficulty of determining the original compass and disposition increases in proportion to the degree of alteration. Instruments which retain their original keys and keybed, but whose compass has been extended either by removing the keyblocks or widening the case to provide room for the additional keys, usually provide clear clues as to the original compass. The difference between the original and the later, subsequent workmanship of the keys, the re-pinning of the balance rail, and the alterations to the registers and lower guide provide clear evidence about the original state of the instrument. Examples of this type of alteration are the 1627a IR and the 1644a AR single-manual harpsichords, and the 1618b IR and the 1615 AR doubles.

Unfortunately, however, more than half of the extant Ruckers harpsichords have been so drastically altered that the simple analysis afforded by the keys or at least the original keyboard balance rail is of no help whatsoever. Typically the case has been widened, the keys,

keybed, jacks and registers have been replaced, and the bridges and nuts have been extended and re-pinned. In some examples the nuts have been moved or the entire wrest-plank replaced in the process. In such a situation one must resort to more detailed and careful analysis in order to solve the problem of the original state of the instrument.

The starting point in this analysis is the determination of the number of natural keys which were originally contained between the keyblocks. Friedrich Ernst⁸⁻¹⁾ was the first to point out that the Stichmass or 3-octave span in Ruckers instruments is approximately 500 mm. Thus since 3 octaves contain 21 natural keys, the average space occupied by one natural keyplate is $\frac{500}{21} = 23.81$ mm. Hence, for example, the 27 naturals in the common C/E to c^3 compass should then occupy a space of $27 \times 23.81 \text{ mm} = 643 \text{ mm}$. The combined space occupied by the bass and treble keyblocks plus the clearance at either end of the keys is usually of the order of 47 mm for both double- and single-manual harpsichords. Thus in the example chosen the total width of the inside of the case should be about $643 \text{ mm} + 47 \text{ mm} = 690 \text{ mm}$. This agrees to within a few millimetres of the actual inside case widths of a typical single manual with an original C/E to c^3 compass. Any disparity is certainly less than one key width, so that an instrument with an original inside case width near 690 mm must originally have had a compass with 27 naturals, which was almost certain to have been C/E to c^3 .

The original width of the inside of the case can usually be fairly closely estimated from the bentside and nameboard ravalement case joins, or the join forming the extensions to the nuts, bridge or soundboard. This in turn can be used to determine the original number of natural keys with an uncertainty of less than one natural key. Table 8-1 can be used as a guide.

Inside case widths and compasses have been listed in parenthesis here which were not, to my knowledge, used by Ruckers. Such compasses are however, musically quite possible and were sometimes used by other contemporary or earlier or later builders. It is clear that a knowledge of the original number of natural keys is not enough to determine uniquely the original compass. For example, an instrument with 30 natural keys could have any one of the C/E to f^3 , G_1/B_1 to c^3 or C to d^3 compasses, all of which are found on genuine Ruckers instruments and on instruments by other builders. The first two of these would have had altogether 50 notes, the last 51 notes. It is possible that a count of the number of plugged 4' hitchpin holes, or of the plugged tuning pin holes would be enough to determine whether one is dealing with a 50 or a 51 note original compass. If it is a 50 note compass one has still to decide between C/E to f^3 or G_1/B_1 to c^3 . It could be argued that the G_1/B_1 to c^3 compass is historically less likely, and yet Nicolas Meeÿs⁸⁻²⁾ has shown that this compass is original to a harpsichord by a member of the Ruckers family, namely the 1646 IC double in the Brussels Instrument

Table 8-1 - Inside case width used to suggest possible keyboard compass

Based on the Ruckers 3-octave span of 500 mm.

One natural width = $\frac{500}{21} = 23.81$ mm.

No. of Natural Keys	Width of Naturals	Keyblocks plus Clearance	Approx. Width of Inside of case	Possible Compass	No. of Notes
24	571.4 mm	47 mm	618 mm	(F to g^2 , a^2) (F to a^2)	40 41
25	595.2 mm	47 mm	642 mm	C/E to g^2 , a^2 C/E to a^2	41 42
26	619.0 mm	47 mm	666 mm	(F to c^3)	44
27	642.9 mm	47 mm	690 mm	C/E to c^3 (C to a^2)	45 46
28	666.7 mm	47 mm	714 mm	C/E to d^3 (G_1/B_1 to a^2)	47 47
29	690.5 mm	47 mm	737 mm	C to c^3 F to f^3	49 49
30	714.3 mm	47 mm	761 mm	C/E to f^3 G_1/B_1 to c^3 C to d^3	50 50 51
31	738.1 mm	47 mm	785 mm	(G_1/B_1 to d^3)	52
32	761.9 mm	47 mm	809 mm	G_1 to c^3	54
33	785.7 mm	47 mm	833 mm	(G_1/B_1 to f^3) (G_1 to d^3) F_1 to c^3	55 56 56
34	809.5 mm	47 mm	857 mm	F_1 to d^3 (G_1 to e^3)	58 58
35	833.3 mm	47 mm	880 mm	F_1 to e^3	60

Museum. It is clear that a more general method for the determination of the original compass and disposition is required.

Because of the special sonority attributed to the Ruckers soundboards, the process of ravalement carried out on the instruments tended to treat the soundboard and soundboard bridges as inviolate. Whereas the casework was drastically altered, and the action and wrestplank completely renewed, the most that was normally done to the soundboard was to extend it in the treble and to re-pin and extend the bridges. Therefore it is the evidence provided by the original bridge pins and 4' hitchpins which must be used in any detailed determination of the original compass, as often little else remains. Clearly, although the 4' hitchpin rail and bridges may have been re-pinned a number of times, the plugged holes remaining contain the evidence of the original string-band layout. The problem is only to identify which of the plugged holes corresponds to the original Ruckers pinning, and then to determine the relative pitch, and the note played by each string which passed over these pins. When working directly from the original instrument itself or even from an accurate full-scale drawing showing all of the plugged bridge and hitchpin holes, it is difficult to keep track of which are the possible original pin holes and which the subsequent ones, quite aside from the pitch of the associated strings. A more schematic and abstract representation of the string-band is required.

A convenient and permanent record of the pinning of the bridges and 4' hitchpin rail containing all the information relevant to the original compass and the disposition of a harpsichord can be made as follows. A strip of polyester or mylar transparent plastic draughting film is cut about 2 cm wide and slightly longer than the inside width of the instrument being studied. A fold is made in the film about 1 cm from the end and perpendicular to the long edge of the strip. The strip is then glued or otherwise attached to a small rectangular block of wood so that the fold coincides with one of the 90° edges of the block (see Fig. 8-1). The block is then held against and moved along the spine of the instrument such that the fold is at the lower spine side edge of the block and thus corresponds to the position of the spine on the strip. The position of the pins relative to the spine is then marked on the strip by slowly moving the block along, maintaining the strip at right angles to the spine. Different marks are used for the plugged holes than for the actual pinning, and the 8' bridge pin positions are marked along the back edge, the 4' bridge pin positions along the near edge and the 4' hitchpin positions along the middle of the strip. The plugged holes for the 8' back pinning should be marked adjacent to the rest of the bass 8' pinning. The ends of the original bridges as well as bridge additions, the ravalement join in the soundboard, and the joins in the bentside, nameboard and belly-rail should also all be marked and identified on the strip.

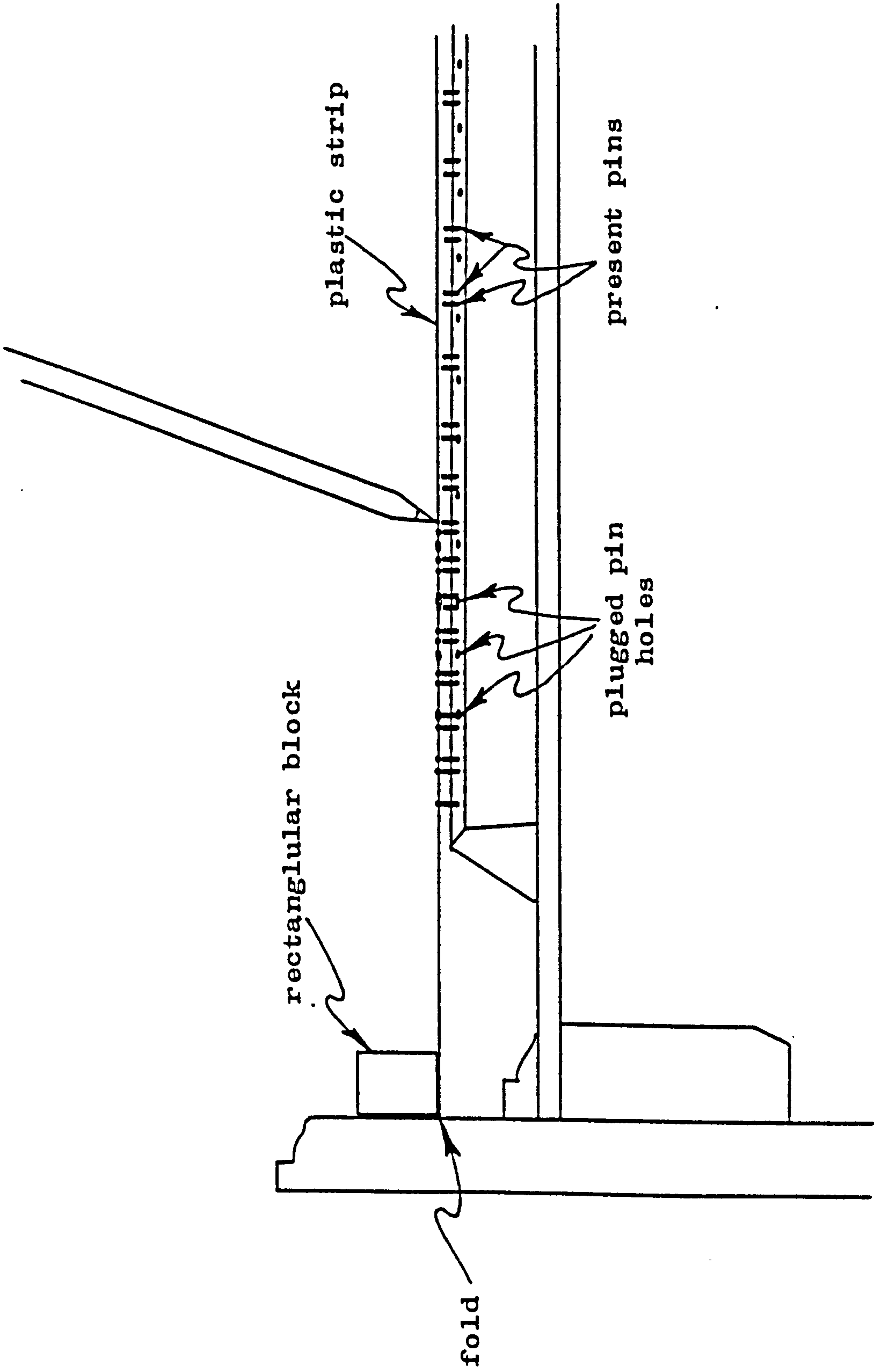

Fig. 8-1 Making the string-band strip

The resulting strip obtained by moving across the entire soundboard area from bass to treble I have decided to call the string-band strip. From the resulting mass of marks on this strip one has to identify those which correspond to the original Ruckers pinning. Here again one relies on the stable conservative building practices of the Ruckers family. It has already been noted that the keyboard 3-octave span is 500 mm. Thus, with 12 strings in each octave the spacing between successive strings is $\frac{500}{36} = 13.89$ mm. Using this spacing a 'Standard' strip can be made from a length of the same transparent plastic film. This standard can then be compared with the strip taken from the instrument.

Because of the single pinning of the 4' bridge, it is usually simpler to make the first comparison here. If the two strips are laid down parallel to one another and the standard is moved along past the strip under study, a position is quickly reached where each of the marks on the standard coincides with one of the marks on the study strip. Often the standard positions coincide in places with some of the plugged holes and in others with some of the positions of the later pinning. The marks which coincide with the standard are those which correspond to the Ruckers pinning of the 4' bridge. Since Ruckers always placed the 4' strings on the left and the 8' strings on the right of the jacks, sliding the standard up and to the right will similarly immediately identify the original 8' pinning. The marks corresponding to the original

Ruckers pinning should be clearly identified on the strip.

Ruckers practice was always to angle the strings away from the spine in the bass, so that the string positions are compressed together at the bass ends of the bridges. Clearly the standard strip will get out of step with the pin positions for the lowest of the bass strings. If the bridges have been re-pinned a number of times it can then be extremely difficult to identify the original pin positions because of their variable spacing. However the single back-pinning positions on the 8' bridge will quickly identify the original pins here since the back pins were placed directly behind and in line with the bridge pins. Ruckers practice, again highly standardised, was to back-pin the bottom octave of 8' strings so that, for example, instruments with a short octave have 9 back-pinned 8' strings from C/E to c inclusive, and instruments with a chromatic bass octave have 13 back-pinned 8' strings.

Having identified the marks on the study strip with the original pinning of the instrument, one is left to identify the pitch of the string associated with each of these pins. In the case of double-manual instruments this is relatively easy because of the double pinning of the $e^b/g^\#$ strings. Thus at each pair of double plugged holes (most readily identifiable on the 4' hitchpin rail and the 4' bridge) one is sure to be dealing with the $e^b/g^\#$ keys. Having identified the original pin positions, one can then work upwards and downwards to identify the bottom and top notes for each manual.

Identification of the associated pitch of the pins on a single-manual harpsichord is not as straightforward as that of a double. However, I have discovered that for both double-and single-manual harpsichords the pitch c^2 8' bridge pin is 49 cm or 19 Flemish duimen from the rear surface of the nameboard. Thus, except for the example of the little 1627 AR harpsichord in the Hague scaled down to quint pitch, it is possible, even when the wrestplank and the nut have been replaced, to identify the pitch c^2 plugged hole in the 8' bridge simply by measuring out 49 cm behind the nameboard. Identifying this plugged hole on the string-band strip then identifies the pitch of all of the strings above and below c^2 .

Determining the pitch of the strings does not necessarily determine the compass in the situations where the pitch of the instrument is other than the normal 'reference' pitch R. Normally the original width of the case determines the number of naturals, and this in turn greatly restricts the number of possible compasses which make musical and historical sense. Also other factors such as the back-pinning of the 8' bridge will help in determining the original compass. But the played note for each string and hence the relative pitch, can be determined unambiguously in the following way.

In laying out the position of the bridges and bridge pins, the Ruckers practice was to place pairs of positioning pins into the soundboard on either side of the bridges close to the played notes \underline{c} and $\underline{f^\#}$ (see p. 308). The holes

for these positioning pins remain beside the bridges and are one of the characteristics of the genuine Ruckers harpsichord. It is always clear whether any pair of positioning holes corresponds to a c or to an f[#] since a misinterpretation of these possibilities normally means that the instrument would then have the unlikely note f[#] as a lowest or highest key. Comparing the played c² string position determined from the bridge positioning holes with the position of the pitch c² string will then uniquely determine both the original compass and the pitch of the instrument.

Having used the string-band strip method to compare with one another the harpsichords of a given type by a given member of the Ruckers family over a long period of his output, it has become clear to me that the distances of the bridge and nut pins from the spine are actually more consistent from instrument to instrument than the string lengths. It thus appears that the position of the bridge and nut pins was marked out from the spine with the 8' bridge pitch c² position at 19 duimen (49 cm) from the nameboard as axis. The accurate positioning of the strings relative to the jacks and to one another was of a first order of importance, and the accuracy of the scalings was only secondary. Thus the correct mechanical operation of the instruments took priority over the slight modifications in the tone caused by slightly variable scalings and plucking positions.

Previously, in identifying the 8' string positions from those of the 4' strings, it was assumed that the

original disposition was 1 x 8', 1 x 4'. From the position of the plugged bridge pin holes and the string-band strips made for a number of harpsichords it is clear that these instruments have been altered to the disposition 2 x 8' by adding another set of strings to the 8' bridge in the position of the original 4' strings, thus effectively lengthening the scale. This disposition seems to have been enormously popular during the second half of the 17th century. The fact that many Ruckers harpsichords were altered, probably early on in their history, to a 2 x 8' disposition, leads immediately to the question of the possible existence of Ruckers instruments with this as an original disposition, but with later alterations which disguise their original state.

The 1627 Ioannes Ruckers single in the Berlin Instrument Museum now has this disposition and Alfred Berner⁸⁻³⁾ suggests that it was original to the instrument. However, neither the present soundboard nor soundboard bridge is original, and the lack of a 4' soundboard bridge is therefore no indication of the original disposition. Since the original jacks which were re-used in the altered instrument include both 4' and 8' jacks, with one damper hole and two damper holes respectively, it seems clear that the original soundboard had both a 4' and an 8' bridge and I can see no evidence that the original disposition was other than 1 x 8', 1 x 4'.

A careful search has been made, both among those instruments which have been radically altered, as well as

those which are little altered, for a harpsichord by a member of the Ruckers family which originally had a disposition other than 1 x 8', 1 x 4'. No instrument signed with the name Ruckers has been found with a 2 x 8' disposition, although two instruments by the Couchets have been discovered which originally had this disposition.

The first of these is the 1652 IC harpsichord which is now a double with the normal 2 x 8', 1 x 4' disposition.⁸⁻¹ The 8' bridge has not been re-pinned, but a 4' bridge has been added which runs across the soundboard covering parts of the original soundboard painting. This 4' bridge also runs over the original barring under the soundboard which was clearly laid out for just a single 8' bridge. The soundboard barring also indicates that originally there was never any provision for a 4' hitchpin rail. The original long 8' string has the usual Ruckers/Couchet scaling of 353 mm.

The second instrument which originally had a 2 x 8' disposition is the 1671/73 IC harpsichord by one of the Couchet sons, probably Ioseph Ioannes. This has also been converted from a single-to a double-manual harpsichord, and in doing so the soundboard has been elaborately respliced to make use of the old wood in the sounding parts of the new soundboard. In doing so all evidence of the original bridges (and their pinning) and of the soundboard barring has been lost. However, traces of the original soundboard painting show the original position of the 8' bridge and rose hole. It is clear from these that there

was never a 4' bridge nor is there any trace of 4' hitch-pin holes in the soundboard. It therefore seems likely that this harpsichord also originally had a 2 x 8' disposition - the only other possibility being the totally anachronistic 1 x 8' disposition,

Besides the evidence found in existing instruments of Ioannes Couchet's use of the 2 x 8' disposition in his harpsichords, there is also documentary evidence that Couchet used this disposition. Letters between Constantijn Huyghens and Gaspard F. Duarte and also between Huyghens and Couchet himself (see Appendices 17 and 18), indicate that Couchet made a harpsichord with the extended compass of F_1 to d^3 and with a 2 x 8' disposition in the summer of 1648. It appears from Couchet's letter that this is the first 2 x 8' harpsichord he had made. So it is not surprising that such a disposition is not found among those instruments signed by the Ruckers, since only 3 Ruckers instruments survive which are dated after 1648.

Most of the harpsichords subjected to the string-band strip analysis were found originally to have been the familiar models made by the Ruckers family. The single-manual harpsichords usually had an original compass of C/E to c^3 at 8' pitch, and the doubles had two manuals with the upper from C/E to c^3 at 8' pitch and the lower from C/E to f^3 at $10\frac{2}{3}$ ' pitch. However, a number of harpsichords have been found which do not fall into the above categories. I would like to illustrate the above methods of determining the original compass and disposition by

discussing some of these non-standard models.

The 1599 harpsichord in the Händelhaus in Halle, has an HR rosette of the type that was used by Ioannes Ruckers before 1618. It is now an aligned double with a compass of F_1 to f^3 chromatic which in the course of its alterations has been given a short scaling which is suitable for brass stringing throughout (see p. 643). The original width of the inside of the case measured from the joins in the bentside and lower belly rail is about 715 mm, indicating an original compass with 28 naturals. Examination of the string band strip shows clearly that there were originally 3 pairs of double $e^b/g^\#$ strings, thus indicating also that the harpsichord originally, as now, had two manuals. Identification of the pitch c^2 string using the 49 cm rule corroborates the pitches of the $e^b/g^\#$ strings. Considering the lower manual where the pitch c^2 string is played by the f^2 key, and counting downwards, the lowest note is found to be the E of the usual C/E short octave. Counting upwards, however, the last original pin hole on the original parts of the bridges remaining, corresponds to g^2 at 8' pitch and c^2 at $10\frac{2}{3}'$ pitch. However the original bridges have been considerably shortened during the ravalement and there is room inside the case for a compass with at least two additional treble notes. The original compass must thus have been C/E to a^2 on the upper manual and C/E to d^3 on the lower. (It seems impossible to determine whether or not there was originally a top $g^{\#2}/c^{\#3}$ accidental or not).

The C/E to a² compass is also found on the 1583 quint virginal in the Collection of the late André Meyer, Paris, and on the virginal part of the 1594 combined harpsichord and virginal in Schloss Köpenick, both instruments being by Hans Ruckers. Thus this is not a totally unknown compass in Ruckers instruments, and represents, along with another non-Ruckers double of the same compass in the Brussels Instrument Museum (No. 2934, see Chapt. 2, p. 74), an early form of the Flemish non-aligned double-manual harpsichord.

One of the most interesting of the Ruckers instruments is the 1612a IR harpsichord which is kept at Fenton House in Hampstead, and which belongs to H.M. Queen Elizabeth II. This is now a brilliantly lacquered double of compass G₁, A₁ to f³. The depth of both the keywell and case have been altered, but both indicate that the instrument was originally also a double-manual harpsichord: the keywell was lengthened in the course of the ravalement in order to accommodate longer keys, but the lap joint used to make the extension indicates that the original keywell depth was at least 212.5 mm, which is far too great for a single-manual instrument. The alteration to the case height was made at the top of the case but the soundboard to baseboard distance is still the original 8 duimen (203 mm) which is also characteristic of Ruckers double-manual harpsichords (see p. 252 and 264). The inside width of the instrument measured from the ravalement join in the bentside is 700 mm, but the extreme end of the original 8' bridge ex-

tends to a point 685 mm from the spine. This indicates that the original cheek must have been at about 710 to 715 mm from the spine (otherwise the treble ends of the bridges would have been sitting on the cheek liner), and thus that the original compass had 28 naturals. A string-band strip has been made for this instrument, and the pitch c^2 pin on the 8' bridge and the original Ruckers pinning on the bridges and 4' hitchpin rail have been identified (the 4' bridge is not original above the present $g^{\#1}$ pin). Counting downwards from the pitch c^2 pin to the bottom note is then found to be A_1 , and upwards the top note would be g^2 . Historically this is a completely unknown compass, and suggests that the harpsichord was originally not at 8' pitch. Assuming therefore, that the instrument was at $10\frac{2}{3}$ ' pitch like the lower manual of a normal double renders the bottom note a D and the top note a^3 . This is an equally unlikely compass. However, if one assumes that the harpsichord was originally at 12' pitch, a quint below 8' pitch, then the pitch c^2 note would have been played by a g^2 key. This then gives an E as the lowest, and d^3 as the top key, which suggests the C/E to d^3 as the original compass at the unusual sub-quint pitch.

The positioning holes beside the bridges for the played notes 'c' and ' $f^{\#}$ ' confirm the assumption that the original compass was C/E to d^3 . This compass is not unique but is found in a 1629 IR virginal belonging to the Brussels Instrument Museum and now on loan to the Russell Collection.

The sub-quint pitch is an octave below the pitch of the 1629 IR virginal at quart pitch. However this harpsichord is to my knowledge unique among keyboard instruments in being designed originally for sub-quint pitch.

Although it seems fairly certain that one of the manuals of this harpsichord was at sub-quint pitch with a compass of C/E to d^3 , the problem of the pitch and compass of the second manual remains. The string-band strip and careful examination of the instrument itself indicates that there were originally no doubled hitchpins for the notes e^b/g^\sharp , or for any other notes. Excluding those instruments with non-original soundboards, and those which were originally singles, this is thus the only Ruckers double-manual harpsichord without the double strings to accommodate mean-tone tuning. This automatically suggests that the instrument was originally designed for and tuned in some well-tempered system in which all tonalities were playable and which did not require the doubled strings. However this possibility seems highly unlikely as such tuning systems were virtually unknown in 1612 and the mean-tone system was thoroughly ingrained in the musical culture of the Low Countries during this period. Most important of all, the instrument originally had a C/E short-octave, so that the tonalities not available in the short-octave bass could not be used, thus negating any advantage that any tuning system other than mean-tone might have.

Therefore, keeping in mind the C/E to d^3 compass,

the sub-quint design pitch, and the utilization of mean-tone tuning, three possibilities suggest themselves. The first possibility is that the two manuals were aligned and at the same pitch. However, there is no historical precedent for such a disposition and no other extant undoubted aligned doubles exist for at least 50 years, although documentary evidence seems to point to the existence of aligned instruments about 10 to 15 years later.⁸⁻⁵⁾ Also it seems unlikely that an instrument with both manuals at the even then extremely uncommon sub-quint pitch should survive whereas there is not a single example of an aligned double at the usual 8' pitch or at a pitch a fourth below this. At any rate such an instrument would not have been an 'expressive' double since analysis of the string band strip shows that the original disposition was 1 x 8', 1 x 4', lacking any unison 8', so that exactly the same disposition would have been available on both manuals. Such an arrangement therefore seems pointless.

A second possibility is that the two manuals were a fourth apart, with compasses of C/E to d^3 and C/E to a^2 like the 1599 IR harpsichord just discussed, but overall a tone lower in pitch. However, such an instrument would require e^b/g^\sharp plates in the same way that the normal double does. These plates had been in regular use since 1599 (e.g. 1599 HR, 1608 AR, 1612b HR, 1612 IR) and so one should expect to find them here if this second supposition were correct. Also the C/E to a^2 upper-manual compass, out of date even in 1599, is completely anachronistic in 1612.

The third possibility is that the instrument was originally a non-aligned double with its two manuals a tone apart. Such a harpsichord would have keyboards with a compass of C/E to d^3 and C/E to c^3 , and would require only one cranked key in the bass for the short octave (see Fig. 8-2).

With the two manuals a tone apart a conflict in the tuning occurs for two sets of notes in every octave, namely c^\sharp/e^b and g^\sharp/b^b , and also the upper manual F would have to be tuned to F^\sharp when using the lower manual E (see Appendix 7). With the tradition of using the e^b/g^\sharp plates well established, it seems odd that similar plates, two to an octave, would not have been used for the notes requiring re-tuning on this harpsichord. However, it is not clear that this instrument was like other doubles in having four registers. Traces of the original jackrail mortice remain on the spine, and, although its original size is indistinct, it is clear that the jackrail and hence the register gap, was not originally as wide as in the normal double-manual harpsichord. This seems to indicate that this may have been another 3-slide instrument. The most likely disposition for a 3-slide harpsichord (see also p. 81) is:

← 4'
 → 8' dogleg
 ← 4'

Here, because the 8' jacks are common to both manuals, the strings with conflicting tunings must be retuned when mov-

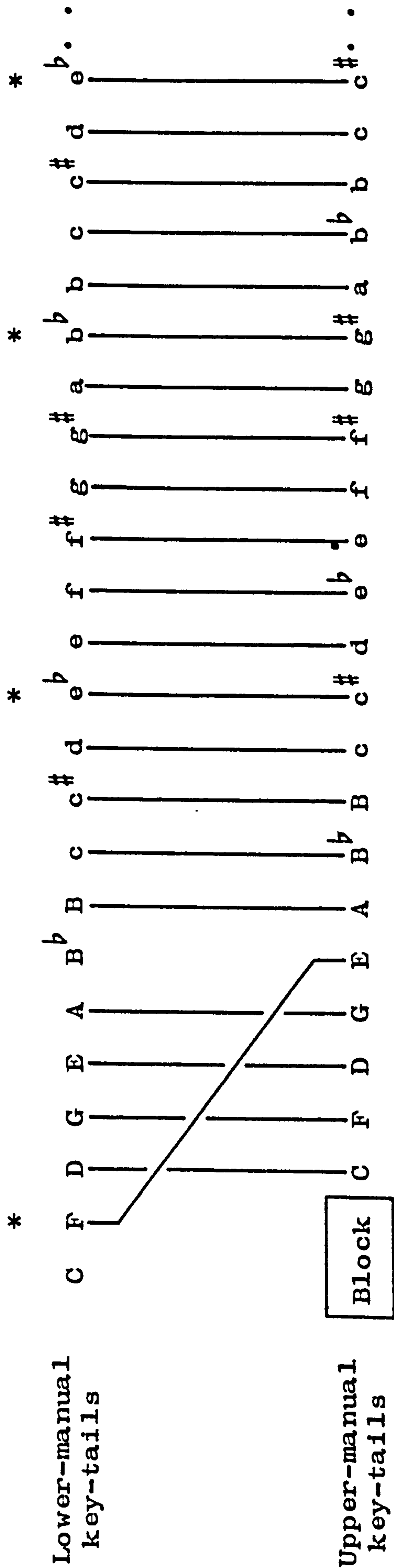

Fig. 8-2 Schematic diagram of a possible arrangement of the bass keys in a double-manual harpsichord transposing by a tone.

* - these notes require either doubled strings or re-tuning.

ing from one manual to another and the plates for the double strings have no point or purpose, hence their absence.

Assuming that the two manuals were a tone apart also explains why the lower-manual compass extends to the unusual d^3 : the upper manual must reach to c^3 in order that the contemporary music be playable, and this in turn means that the lower manual a tone lower, must end at d^3 , one tone higher in pitch.

Although no other Ruckers double-manual harpsichord indicates either that it had its manuals other than a fourth apart or that it had other than 4 registers, the assumption that the manuals of the 1612a IR double were a tone apart seems to solve most of the problems associated with this instrument given that it originally had 3 registers and one manual at sub-quint pitch. The pitch of the second manual also then belongs to the scheme deduced for the other Ruckers instruments (see p. 177): it is at the same pitch as the lower manual of the normal Ruckers double. The tone difference in the two pitch systems is just the tone difference between Praetorius' Kammerton and Chorton.⁸⁻⁶⁾ That instruments were made with a difference of a tone between them is also mentioned by Couchet himself in his letter to Constantijn Huyghens (see Appendix 18). This tone difference is also known in organs⁸⁻⁷⁾ and, most important of all, in the 1537 Hans Müller of Leipzig harpsichord (see Chapt. 2 p. 48) in the Evan Gorga Collection, Rome.⁸⁻⁷⁾ The keyboards and registers of this instrument

indicate that the instrument was designed so that the keyboards could be shifted laterally by an amount equal to one tone (a semitone shift was not possible because of the spacing of the register slots at the top and bottom). Such a harpsichord, although its strings would have to be re-tuned when the keyboard was shifted, would be much less convenient to use than an instrument with two keyboards placed permanently one tone apart.

An example of another non-standard type of harpsichord built by the Ruckers family is the 1616 HR double in private ownership in Paris. This harpsichord, although it is now an aligned double, still has the disposition 1 x 8', 1 x 4' on each manual. The instrument has never been widened and so retains its original inside case width of 806 mm. This seems to imply that the present F_1 to b^2 (without $b^{\flat 2}$) compass which has 32 naturals is original. However, the entire lower-manual keys and keybed and the upper-manual keys are replacements. The upper-manual balance rail is, however, original and shows traces of the original wooden block in the bass which is wide enough to replace three natural keys. The first note after the block was originally an F and not the expected E of a C/E short octave, and the top note was f^3 four chromatic octaves higher. This four-octave compass with the bass wooden block which is 3 naturals wide confirms the 32 natural note inside case width.

The bridge and nuts have not been re-pinned, the wrestplank retains its original doubled tuning pins and

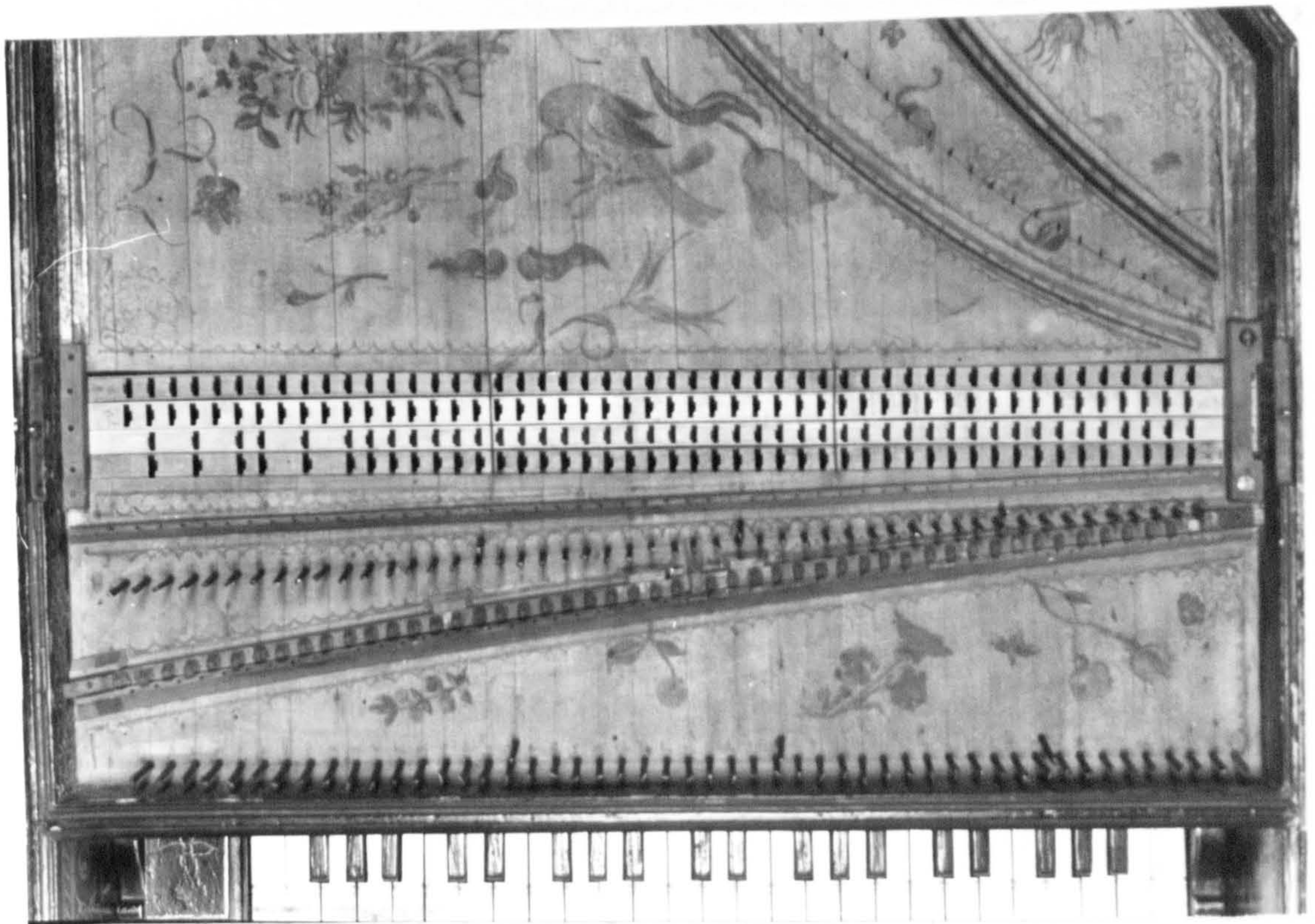

Photo 8-1 Comparison of the wrestplank of the normal (above - 1638b IR) and the 'French' (below - 1616 HR) double-manual harpsichords. Besides being wider, the 'French' double has one extra set of doubled e/g tuning pins and strings for each of the 4' and 8' choirs.

the nuts retain their plates for the doubled $e^b/g^\#$ strings. There are in fact four sets of doubled tuning pins and nut plates instead of the 3 sets of the normal Ruckers double. The doubled strings occur at the position of the $g^\#$ keys of the original upper manual, fixing the e^b key positions of the lower manual and implying a top note of c^3 , a bottom bass G_1 , and a chromatic 54 note compass between. Thus not only do both manuals have a chromatic bass compass but the pitch role of the two keyboards is interchanged compared with the normal double (see Fig. 8-3). This must be the large instrument referred to by Douwes:⁸⁻⁹⁾

"The notes or keyboards of clavecimbel compare with those of most organs, namely from C to C four octaves* But a few large harpsichords go down lower to G or F (i.e. G_1 or F_1) similar to some large organs and encompass four octaves and a fifth."

* i.e. from C to c^3

All four examples of this type of harpsichord (1616 HR, 1627c IR, 1628b IR, 1646b AR) were found in France and appear to have been there for a very long time. This seems to suggest that this model of double-manual instrument with an extended chromatic bass compass was specially made for export to France. I have therefore called this model the 'French' double to distinguish it from the normal double with short-octave bass compasses.

It should be noted at this point that all of the extant Ruckers harpsichords which originally had two manuals were of the non-aligned type⁸⁻¹⁰⁾ with the manuals a fourth apart in pitch or, in the case of the 1612a HR,

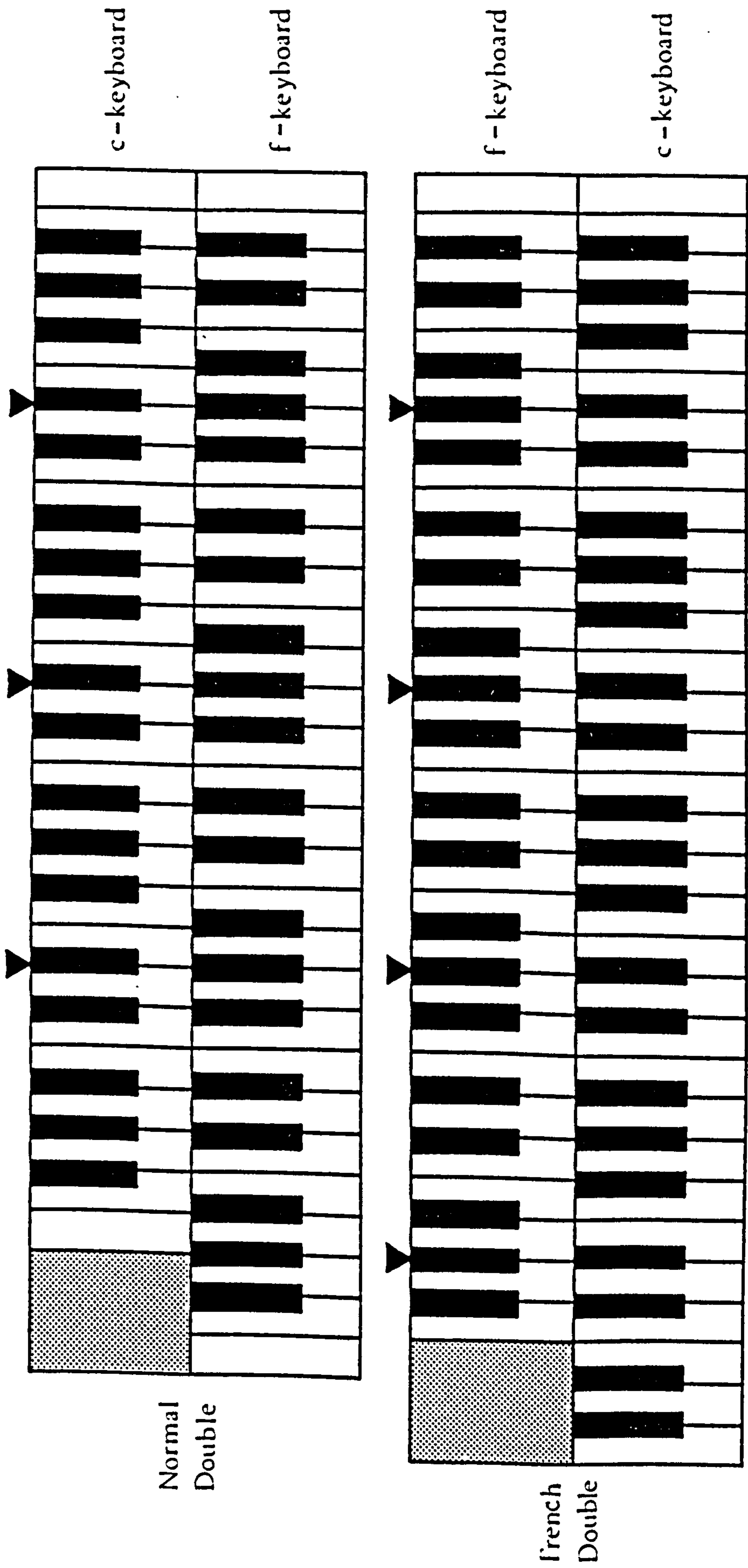

▼ - Notes requiring doubled strings to accommodate meantone tuning.

Fig. 8-3 Comparison of the keyboards on the normal (above) and the chromatic bass compass 'French' (below) double-manual Ruckers harpsichords.

the manuals were apparently a tone apart. Not including the 1612a HR, only five Ruckers harpsichords which are now doubles and which have their original soundboards, do not exhibit evidence of the original double pinning of the e^b/g^\sharp notes. Of these, the 1632 IR, the 1636 AR, 1621 AR, 1651b AR and the 1654 AR, were all undoubtedly originally 4-octave singles, the first two of these actually still retaining their original baseboards onto which the plan of the instrument has been scribed. In addition several instruments which are now doubles, but which were all originally singles were made by the Couchets and these will be discussed later. Therefore, since none of the surviving 2-manual harpsichords was originally of the aligned type it seems likely that no instrument of this type was ever made by any of the Ruckers family.

Another two instruments of interest are very similar, not least in that they were both originally, as now, single-manual harpsichords. The first is the 1637a IR single in the Russell Collection, Edinburgh. This harpsichord has been widened in the 18th century to its present compass of A_1 to f^3 . The original inside width measured from joins in the bentside and nameboard was about 735 mm and this implies a 29 natural note compass. Application of the 49 cm rule confirms the C to c^3 chromatic compass reported by John Barnes in 1970.⁸⁻¹¹⁾ An important feature not pointed out by Barnes is that instead of the usual 9 strings which are backpinned on singles having a C/E short octave, there were originally

13 backpinned notes on this harpsichord. This also confirms the long octave since it means that, as usual, the backpinning covers the full bottom octave.

Almost identical to this is the 1639 IR single built two years later and now in the Victoria and Albert Museum, London. The case of the instrument has never been widened, but the original keyblocks have been narrowed to allow space for a wider keyboard, the gap has been widened to make room for a third register, and the bridges extended and repinned to take the extra notes and two unison sets of 8' strings (see Fig. 8-4). The 18th century keyboards of this harpsichord were lost in a fire in Kirkman's workshops in 1853, but the tuning pins, nut and bridge pins and the registers all indicate that the 18th century compass had 55 notes and was probably G_1, A_1 to d^3 , with a scaling of 339 mm and a 3-octave span of only about 465 mm. The scribed lines on the original baseboard indicate the positions of the original keyblocks and the space between these was originally 722 mm. This implies a compass with 30 natural notes (the total inside case width is 758 mm, the same as the 1638b IR double in Edinburgh also with a compass of 30 natural keys). The stringband strip shows that the original compass had 51 notes, and applying the 49 cm rule to locate the c^2 string gives an original compass of C to d^3 . Like the 1637a IR single in Edinburgh and the 1679 IC in Washington, the chromatic bass octave is confirmed by the presence of 13 original single backpins on the bass end of the 8' bridge. These instruments with a chromatic bass octave to C seem to have been special export models made probably for the English market.

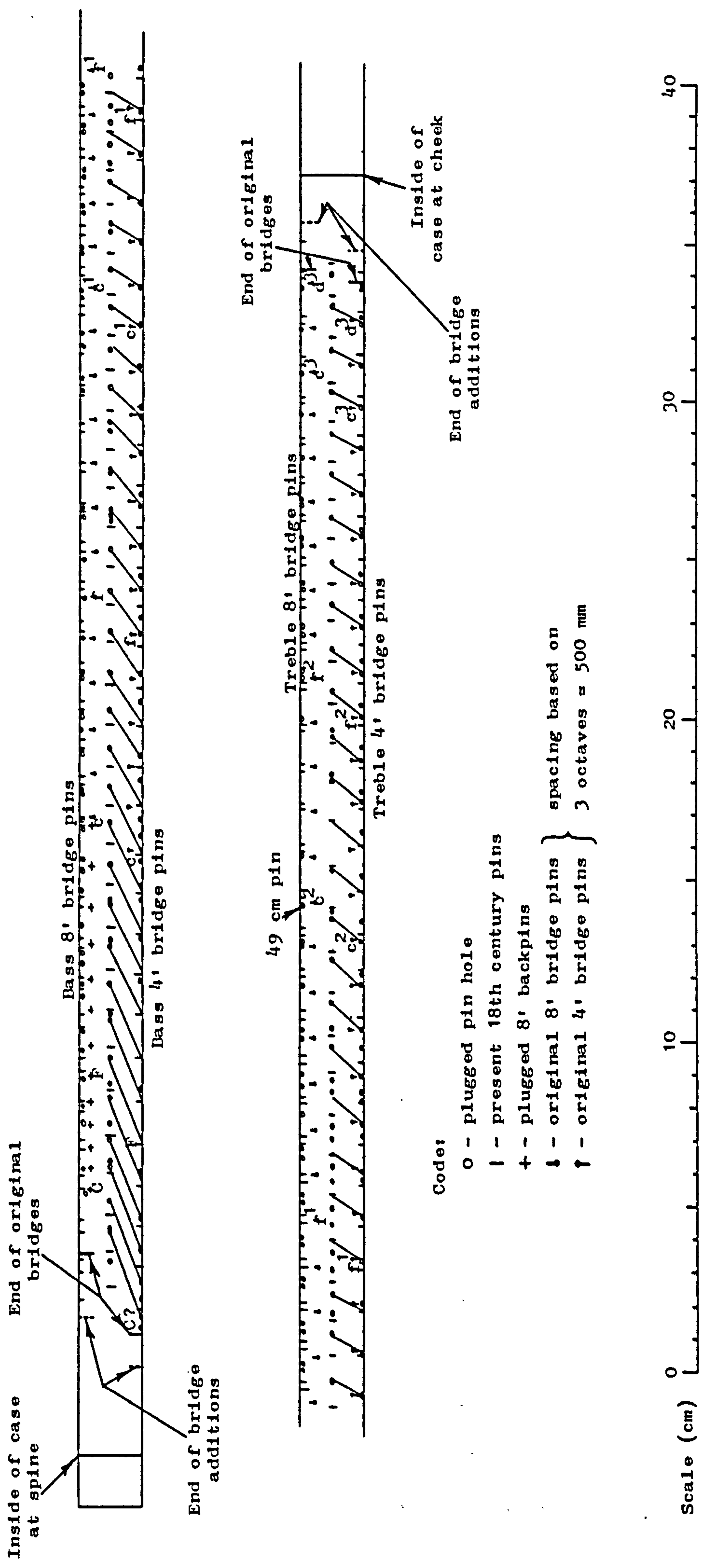

Fig. 8-4 The 1639 IR string-band strip.

In fact two of the four harpsichords with chromatic bass octaves to C (the 1637a IR and the 1639 IR), seem to have been in England from earliest times, and were therefore probably among these special export models. Also Dr. Lambrechts-Douillez reports that in the Antwerp archival documents dealing with Ioannes Couchet's wife and the Hagaerts, harpsichords with a chromatic bass octave to C are referred to as op sijn engels, or 'in the English style'.⁸⁻¹²⁾

During the second half of the 17th century the Couchets continued building instruments in the Ruckers style, but with compasses and dispositions not found in the Ruckers instruments built before about 1650. These instruments had the same keyboard and string spacing as the Ruckers instruments and so the string band strip method can be applied to them to determine their original compass and disposition. Except for the 1646 IC, all of the extant Couchet harpsichords were originally singles.

The (c1650) IC in the Metropolitan Museum, New York, has not been widened and the inside width of the case is 831 mm suggesting that the original compass had 33 naturals. The note names are written beside the original row of tuning pins and these read (transcribed from the old Flemish script): F₁, G₁, A₁, B₁^b, B₁, C...c³, and these confirm the 33 natural note compass. On this harpsichord, 11 of the bass notes were originally back-pinned, and this conforms to the usual practice of back-pinning the the lowest octave of strings - in this case

from F_1 to F without F_1^\sharp and G_1^\sharp . The original pitch c string located using the 49 cm rule was played by the $b^{\flat 1}$ string (353 mm) and the c^2 string/^{length}(314 mm) prove that this harpsichord was one of those which Couchet built to sound a tone above R (see Appendix 18).

One of the few Ruckers-tradition harpsichords with a 2 x 8' original disposition is the 1652 IC in private hands in France. As explained previously the soundboard barring, and the soundboard painting (part of which now lies under the added 4' bridge and the strip of wood glued to the top of the soundboard and used as a 4' hitchpin rail) prove that this harpsichord did not originally have a set of 4' strings. The original and present inside case width is 763 mm which implies an original compass with 30 naturals. The 8' bridges have not been repinned although the new keyboards have a narrower octave span (472 mm) than originally. The present compass is G_1/B_1 to c^3 with a split E^{\flat} , and the 49 cm rule locates the present long c^2 string. This suggests that the present compass is also the original compass except for the bottom split E^{\flat} , for which an extra set of strings was added in the extreme bass. This is confirmed by the pinning and position of the lower strings. Although the 1646 IC double also originally had the G_1/B_1 to c^3 compass, it had this more by default than design, since it is just the transposed compass of the lower manual. The 1652 IC is thus probably the earliest extant harpsichord designed to have the G_1/B_1 short-octave compass.

The 1680 IC in Boston (ravalé by Blanchet in 1758 and by Taskin in 1781) has been altered at least twice in the 18th century and apparently also in more recent times. The cheek shows evidence of a lap joint which extended the length of the keywell to convert it from a single to a double. The original Couchet inside case width can be estimated and is found to be about 863 mm. From Table 8-1 this suggests that the original compass had 3⁴ naturals. Using the 49 cm rule to give the original position of c² locating the plugged original tuning pin hole for this note in the wrestplank and then counting upwards, gives d³ as the original top note. This suggests that the original pitch was R and that the original compass was F₁ to d³ (or perhaps F₁, G₁, A₁ to d³). Unfortunately the bridges and hitchrail have been pinned and replugged so many times that it is now impossible to distinguish the position of the original from the later pin holes. This plus the curious lack of any of the usual construction marks on the soundboard, such as the positioning holes beside the original c and f[#] notes has made it impossible to confirm definitely either the pitch or the compass of this instrument.

Finally the n.d. IC harpsichord in Stockholm which may be the last instrument built in the Ruckers/Couchet tradition, can also be analysed in the usual way. It is now a beautifully decorated double ravalé by Taskin. The case has never been widened, but both the spine and cheek have been lengthened to enlarge the keywell and convert it from a single-to a double-manual harpsichord. The instru-

ment is 887 mm wide inside and this is wide enough for 35 naturals plus about 54 mm for the keyblocks and clearance at the ends of the keys. Locating the pitch c^2 string using the 49 cm rule gives F_1 as the bottom note, and a chromatic bass octave is confirmed by the presence of 13 single back-pinned strings on the 8' bridge. The treble ends of both the 8' and 4' bridges are replacements so that the top note cannot be confirmed directly. A 35 natural note compass from F_1 would give e^3 as the top note and a completely chromatic compass would have 60 notes. However the presence of only 59 original holes (plus later added holes) in the original registers which were later used as lower guides, suggests that the original compass was F_1 to d^3, e^3 . This seems to be confirmed by extrapolating the position of the treble strings on the string band strip. If the e^{b3} were present, then the top string would be placed very close to the cheek and cheek moulding giving virtually no free soundboard in the treble. This compass is thus only two notes smaller than the standard F_1 to f^3 compass which was used in instruments throughout Northern Europe for the next 100 years.

Because the 49 cm rule locates the original c^2 note it might be expected that as usual, this is also the pitch c^2 note in the n.d. IC harpsichord. However the original position of the nut shows that the scalings of c here were about 315 mm, so that the pitch of this harpsichord must have been $R + 1$, like the (c1650)b IC in New York.

The use of the string-band strip method just de-

scribed to determine the original compass and disposition of a Ruckers harpsichord has a number of advantages quite aside from the relative ease of use and the positive nature of the results it gives. As a record of the major part of the musical alterations to an instrument the strip is permanent and stable since the coefficients of humidity and temperature expansion of the plastic film are both small. The rolled strip is very small, and can be stored in a space a fraction of that of a full-scale drawing. Another advantage is that the analysis of the original pin spacing can be done away from the instrument at one's convenience. Furthermore the method is readily applicable to other types of instruments which have undergone alterations. Most 17th century instruments of the Flemish school also used a 500 mm 3-octave span, and the 49 cm rule works on at least two Flemish non-Ruckers harpsichords that I know. Also many Italian instruments used a 3-octave span close to 500 mm, and this can be used at least to determine the original number of natural keys if not to identify the pitches of the strings.

Footnotes:

- 8-1) Friedrich Ernst, 'Four Ruckers Harpsichords in Berlin', Galpin Society Journal, XX (1867) 63-75.
- 8-2) Nicolas Meeÿs, 'Le Clavecin de Johannes Couchet, Anvers 1646', Bulletin of the Brussels Museum of Instruments, 1 (1971) 15.
- 8-3) Alfred Berner, 'Der Ruckers Bestand des Berliner-Musikinstrumentenmuseums', Colloquium. Restauratie-probleem van Antwerpse Klavecimbels. Antwerp (1971) 53-62.

- 8-4) I would like to express my thanks to William Dowd, Sheridan Germann and David Ley, who supplied me with information about this instrument.
- 8-5) Marin Mersenne, Harmonie Universelle, Paris (1636) and English Translation by R.E. Chapman, The Hague, (1957) p. 165.
E.M. Ripin, 'The Two-manual harpsichord in Flanders before 1650', The Galpin Society Journal, XXI (1968) 33 ff.
- 8-6) Michael Praetorius, 'De Organographia', Syntagma Musicum II (1619) Wolfenbüttel (Facs. 1958 Kassel) p. 14 ff.
- 8-7) H.J. Moser, Paul Hofhaimer (1929) Stuttgart/Berlin, p. 22 and 177.
- 8-8) Louisa Cervelli and J.H. van der Meer, 'Conservato a Roma il più antico clavicembalo tedesco', (1967) Rome (Edizioni Paltine).
- 8-9) See Appendix 8.
- 8-10) The aligned double referred to by J.H. van der Meer, 'More about Flemish Two-manual Harpsichords', Keyboard Instruments (ed. E.M. Ripin) Edinburgh (1971) p. 50 ff. is undoubtedly not a product of the Ruckers' workshop.
- 8-11) John Barnes, 'The Flemish Instruments in the Russell Collection, Edinburgh', Colloquium. Restauratieproblemen van Antwerpse Klavecimbels, Antwerp (1971) 35-39.
- 8-12) Personal communication.

Chapter 9 - Trademarks of the Ruckers Instruments

It is clearly very important to be able to establish the authenticity of a Ruckers instrument. Genuine Ruckers instruments display a wide variety of appearances: some are virtually unaltered from their original state and others have been enlarged and re-decorated in a later style and now bear little resemblance to their appearance when they left the Ruckers workshops. Counterfeit instruments have been made which imitate the genuine article in almost all of the stages of alteration which one finds in the authentic instruments. How is one to decide definitely when confronted by a new instrument whether or not it is a genuine product of the Ruckers tradition?

Partly the ability to establish the authenticity of a Ruckers instrument is based upon experience, and recognising which characteristics can be used to authenticate an instrument becomes easier as experience is gained. As one examines more and more instruments, recurrent features become apparent which can be used to decide whether or not an instrument is genuine. After one has seen a number of undoubted examples, all of which have similar features, it is possible to compare these with new instruments which have been altered both musically and decoratively, or which may have lost certain of their identifying features such as their rose and namebatten. This chapter sets out some of the main features of Ruckers instrument which, based on my own experience with the examination of Ruckers

instruments, are useful in distinguishing genuine from counterfeit instruments.

In theory a genuine Ruckers instrument must exhibit all of the features outlined on the construction of Ruckers harpsichords and virginals in Chapters 5 and 6. But in practice it is usually necessary to look for only a few features of the construction and marking out. Fortunately it is only rarely really difficult to decide about the authenticity of an instrument; usually if even a few of the characteristic features are missing or are atypical or wrong, then one soon finds that there is nothing that, in detail, is typical of the Ruckers practice. On the other hand if only some of the characteristics of Ruckers usual practice are present, then as the examination continues more and more features are discovered which are typical of Ruckers practice, until the evidence becomes overwhelming that the instrument is genuine.

Most unauthentic instruments are the products of 18th century workshops outside of Flanders, and usually they are harpsichords and not virginals. I think it is useful to distinguish three different kinds of unauthentic instruments:

1. counterfeit instruments - are conceived from the start by their builders as instruments designed to deceive their purchasers. They are new instruments built and decorated to resemble a Ruckers or Couchet instrument, and probably artificially antiqued to give them the appearance of age.

2. re-decorated instruments - are instruments by another or earlier builder altered by a second party to give them the appearance of a Ruckers instrument, for example by adding printed papers or by staining the soundboard to make it appear older than it really is.

3. re-attributed instruments - are instruments given a Ruckers signature and rose but otherwise not altered. Most unauthentic instruments are fairly easily recognised since usually the methods involved in their manufacture are only superficially like those used in the 17th century in the Ruckers/Couchet workshops.

Counterfeit instruments are most easily recognised since they are usually made in the counterfeiter's normal tradition regarding materials, framing, musical potential, etc. The counterfeiter simply gives his usual type of instrument the decorative appearance of a normal Ruckers harpsichord or virginal. Similarly, re-decorated instruments are usually not difficult to recognise since they are later instruments which have come into the hands of a faker who has then re-decorated them to look like the usual product of the Ruckers workshops. Most re-attributed instruments are just 18th century instruments with a false signature and a casting of a Ruckers or Couchet rose in the soundboard, with no other attempt being made to give the appearance of a Ruckers instrument.

The difficulty in deciding on the authenticity of an instrument signed with the name Ruckers occurs with those instruments which are genuine 17th century Flemish

instruments which have later been re-decorated or reattributed. In this case the woods used, the framing methods, the case joins, soundboard preparation, and even the construction marks and methods are very similar to those used by the Ruckers themselves. These factors will make it more difficult to decide if the instrument is authentic. But I have found that even with 17th century Flemish instruments which have been faked by giving them a Ruckers signature and rose, there are usually a few of the constructional methods which differ significantly from the Ruckers usual practice and establish that the instrument is unauthentic.

The problem of a counterfeiter working in Antwerp at a time contemporary with the Ruckers poses serious difficulties. A good builder working in the same tradition and milieu as the Ruckers themselves, could probably produce an instrument which is now indistinguishable from the genuine article. Although the Ruckers were recognised in their lifetimes as fine builders, their instruments do not seem to have achieved their almost mythical reputation until well after the demise of the family. Probably the reputation of the Ruckers in their own time was not sufficiently great to warrant the risks involved in counterfeiting instruments. Also the Guild of St. Luke was set up specifically as a guard against such activity and functioned to protect the interests of its members in matters such as this. Since there is no record of any action having been taken by the Guild or Courts on behalf of any of the members of the Ruckers family, it seems highly unlikely that any instrument now accepted as genuine might

be the product of a 17th century Flemish counterfeiting workshop.

Ruckers instrument authentication

What then are the characteristics which identify a Ruckers instrument as genuine? It is clear that it must possess all or some of the features of size, construction, original disposition, and decoration already described in the previous chapters. The purpose of the following guide to the identification of a genuine Ruckers instrument is to point out the characteristics which are most often significant in deciding if an instrument under investigation is genuine or unauthentic.

Soundboard construction features

In even some of the most drastically altered Ruckers instruments, the soundboard and bridges usually retain their basic integrity, and are little altered from the state in which they left the Ruckers workshops. It has generally been realized (although unfortunately not always) that the soundboard is the soul of the instrument, and that to tamper with the thickening of the soundboard or bridges, or to alter the basic scalings and plucking points, is to detract from the great beauty and purity of the sound produced by the instrument. Fortunately it is usually possible from the soundboard alone to be able to identify a genuine Ruckers instrument.

A soundboard in a genuine Ruckers instrument will always have the characteristic ribbed surface texture which was produced by the scraper used in the final thickening

of the soundboard. This ribbed texture results when the spongy spring or early wood relaxes into a position above the harder summer or late wood when the wood is sized or varnished after scraping. Indeed this is a feature of most 17th century North European instruments but one which is lacking in almost all 18th century instruments. In the 18th century the soundboards were planed, and the surface of the wood was left completely flat. Also because the Ruckers soundboards were sized or varnished, or both, they have a shiny appearance whereas many 18th century soundboards (especially in France) were unsized, at least in the open areas which were not painted. Because of the degradation of the size or shellac varnish causing it to darken, a genuine Ruckers soundboard therefore also appears a shiny rich golden brown, and is easily distinguished from the flat matt greyish appearance of many later soundboards.

The positioning holes on either side of the bridges and nuts are also a characteristic feature of Ruckers soundboards. In harpsichords and in many virginals these paired holes are located near the bridge pins for the played notes c and f[#], and can therefore help in the determination of the original pitch and compass of the instrument. Underneath the soundboard one will find small nails or bent-over brass pins driven into the bridge and located between each of the successive pairs of positioning holes. Later instruments usually have neither the positioning holes nor the nails securing the bridge to the soundboard. Or if one of these features is present, the other is normally not.

The position of the 4' hitchpins on most 18th and late 17th century North European harpsichord soundboards was not marked out. The hitchpins were simply driven into the soundboard and there is now no apparent indication of how the position of the pins was determined. On Ruckers harpsichord soundboards, in contrast, both the edge of the 4' hitchpin rail and the line of the hitchpins was marked out on the soundboard. A line was scribed underneath the soundboard along the near edge of the 4' hitchpin rail. The position of this line was transferred to the top of the soundboard by piercing several holes along the length of the line scribed beside the 4' hitchrail up through the soundboard. In turn the position of these holes was made more apparent on the upper surface of the soundboard by scribing a short line through each of the holes. This was probably done by using the 4' hitchpin rail itself, lining it up with the holes pierced through the soundboard in the same position the rail would normally occupy underneath the soundboard. The hitchpin rail was then drawn back towards the rear of the soundboard by an amount which was arbitrary, although always less than half the width of the hitchpin rail at each point along its length. A line was scribed along the whole of the near edge of the 4' hitchpin rail, and the 4' hitchpins were driven into this line after the soundboard was eventually glued into the case. The presence of the holes with their associated scribed lines along the near edge of the 4' hitchpin rail, and the scribed line marking the original position of the 4'

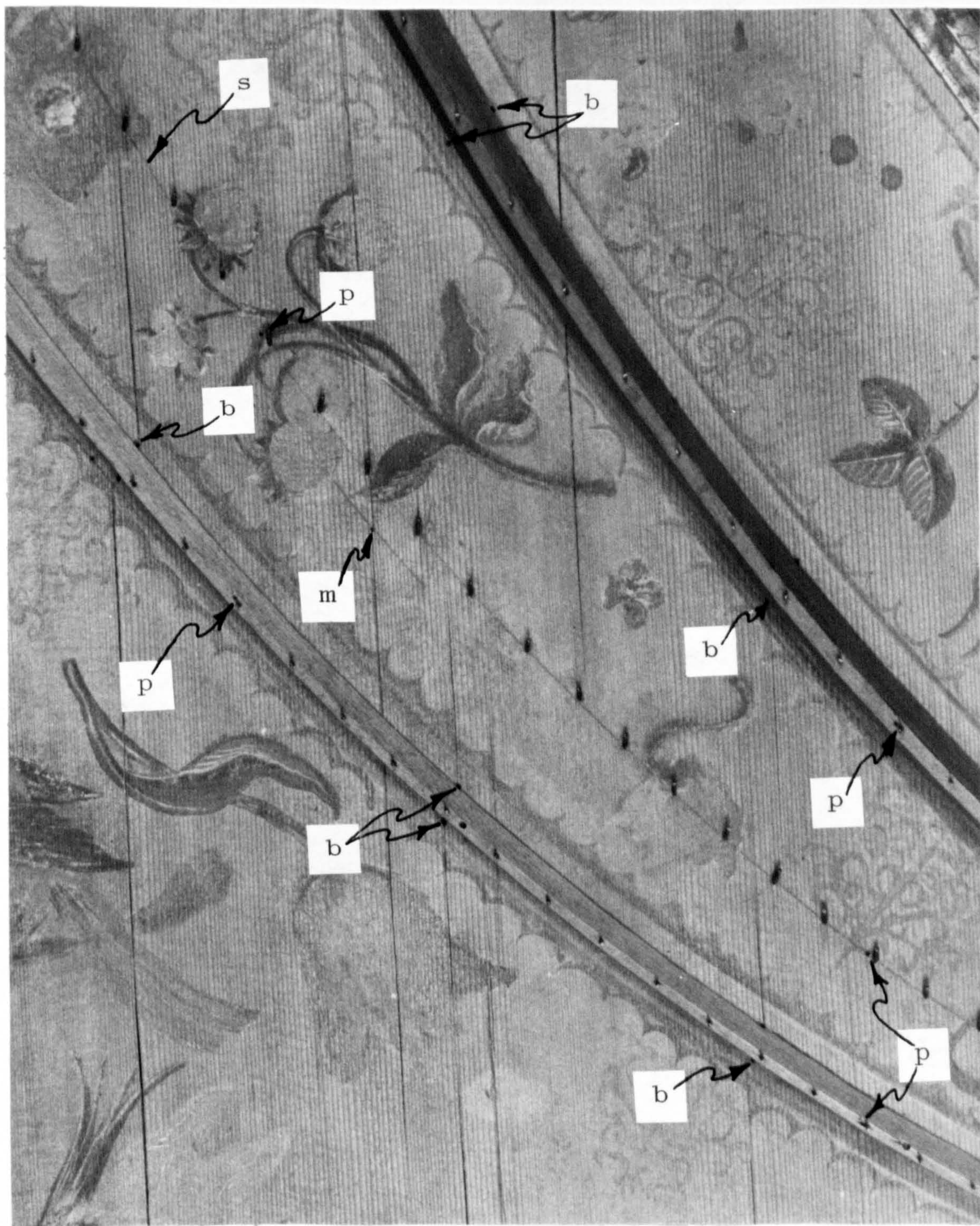

- b - doubled holes for bridge-positioning pins
- p - pins, originally doubled, for the e^b/g[#] strings
- s - scribed line for the 4' hitchpins
- m - mark above the edge of the 4' hitchpin rail

Photo 9-1 Construction marks and features characteristic of a Ruckers soundboard (1638b IR).

hitchpins, are among the most characteristic features of a Ruckers and Couchet harpsichord soundboard, and are not often found in instruments built outside of Antwerp or even in Antwerp in a later period.

Finally, Ruckers soundboards seem always to have been made of spruce (Picea). The distinction between spruce and fir (Abies) can only be made reliably by microscopic examination. And as spruce was also used by other North European builders during all periods, the fact that a soundboard is of spruce may not in itself authenticate an instrument. But an instrument with a fir soundboard is almost certainly a product of an 18th century French faker's workshop, since many French builders used fir instead of spruce as a soundboard material.

Soundboard decoration

All Ruckers soundboards seem originally to have been painted. As part of the deception, a forger would therefore paint the soundboard with flowers and birds and include the usual scalloped borders and the arabesques. Some 18th century counterfeit instruments have very convincing painted soundboards. But most re-decorated and re-attributed and even some counterfeit instruments have soundboards which are clearly not decorated in the style of the Ruckers soundboard painters. But even the most clever counterfeiter or faker usually made some mistake of style, of material, or of dating in executing the soundboard decoration.

Unaware of the family history of the members of

the Ruckers family, the counterfeiter often made mistakes which were not detected at the time, but which are now plainly obvious. The instruments of Hans Ruckers seem to have been most highly regarded in the past. Partly this must have been because Hans was the founding member of the family clavecimbel workshop; partly it must have been because of the reputation gained by Hans Ruckers as a result of the sheer number of instruments with an HR rose in them. But we now know that many instruments with HR roses were made by Ioannes Ruckers after Hans' death in 1598, and before Ioannes' court appointment in 1615. Not knowing this, the counterfeiter often made mistakes by signing an instrument with a soundboard painting in a given style with the name of an inappropriate member of the Ruckers family. As a result, some instruments are signed by Hans Ruckers or have an HR rose, and are dated long after Hans Ruckers' death and after Ioannes Ruckers ceased using an HR rose. Clearly the date, signature and style of the painting must all correlate to the facts known about the family and its history.

The most blatant error a counterfeiter could make would be to sign an instrument with the name of one member of the Ruckers family and imitate the soundboard painting style of another. Few seem to have succumbed to this pitfall. But there are a number of instruments where the dating, signature and painting style do not match. The '1590 HR' (B. 4) double-manual harpsichord in the Paris Conservatoire, now known to be by Goujon, is dated within the life-time of Hans Ruckers, but has a soundboard

painting imitative of the style of the late instruments by Andreas Ruckers. The '1644 HR' (B. 23b) double in private ownership in Switzerland is dated 46 years after Hans Ruckers' death in 1598, and has a sound-board decorated roughly in the style of the early instruments of Ioannes Ruckers. It is mistakes such as these which, usually in conjunction with other features of construction and decoration, confirm that an instrument is a fake.

The use and type of the Ruckers roses

One of the most characteristic features of a Ruckers instrument is the rose, and in any authentic instrument the type of rose (or if the rose is missing, the rose hole diameter) used must correspond to that of its maker and to the period in which the maker was working. This means that the two types of HR rose, one used by Hans, the other by Ioannes until about 1616, must be in instruments with the correct signature and dating. An instrument with an HR rose dated after 1616 is immediately suspect (e.g. B. 23b and 30b). Similarly the casting of the AR rose changed around 1636 (see p. 464). An AR rose of the later casting in a putative Andreas Ruckers instrument dated before 1636 is also liable to suspicion (e.g. B. 89). Ioannes Ruckers used three different types of roses after 1616, and each type had a different diameter. One type was used in virginals, another in single-manual harpsichords and the third in double-manual harpsichords. Because virginals were less valuable in the 18th century, it seems

that Ioannes (and Andreas) virginals were cannibalized and their roses used in counterfeit and fake instruments. Thus a harpsichord with an IR virginal rose taken from one of these cannibalized instruments is almost certainly not an authentic product of the Ioannes Ruckers' workshop (e.g. B. 55). Conversely few other builders used the large harpsichord roses adopted by Ioannes. If an instrument without a rose appears from its construction and decoration to be by Ioannes Ruckers and it has a large rose hole of the correct diameter, then it almost certainly is genuine (e.g. 1624 IR, 1637b IR, 1638b IR).

As has already been mentioned it was a favourite practice among counterfeiters and fakers to attribute instruments to Hans Ruckers. A 'Hans Ruckers' harpsichord had to have an HR soundboard rose, and several methods seem to have been used to satisfy this requirement. Sometimes castings of other makers roses were used in which the initials were changed. The Hans Moermans rose was used in four known fakes (B.24, 25, 29 and 57) with the M changed to an R. Another possibility was to alter either the casting or in some cases even an original AR rose (possibly from a virginal). The two sides of the A were easily cut at the top, spread apart and made parallel, thus converting the A to an H (e.g. B.1). Similarly IR rose castings have been made using the pattern of an AR rose and retaining the left-hand part of the initial A but cutting away the top and bottom of the right-hand part of the letter to make it into an I (e.g.

B.54). When examining a rose to determine whether or not it is genuine, it must be examined in detail. The two HR roses are very similar, and an AR rose altered into an HR rose can at first glance appear to be genuine.

The rose must also fit the hole it is in. If the rose is either too small or too large for the soundboard hole then it is likely that the rose has been fraudulently placed in the instrument (e.g. B.50). An examination of the back of the rose may also help to decide its authenticity. All genuine Ruckers roses have 4 tabs for glueing the rose onto the soundboard. Some of the early Ioannes Ruckers HR roses were made from papier mâché instead of from lead, but since the mould was the same this is only discernible from the back surface of the rose. The three types of rose used by Ioannes after 1616 all have a distinctive appearance from the back: the virginal rose is flat except for four ridged lines forming a star-shaped pattern on the back, and the large harpsichord roses are hollowed out at the back instead of being flat (the large Couchet harpsichord roses also exhibit this feature). The HR roses of Hans, the early HR roses of Ioannes, the Andreas roses and the Couchet virginal roses all have a flat rear surface.

A number of authentic instruments have roses which are either missing or crude later castings, and a number of unauthentic instruments have genuine Ruckers roses. Whether or not an instrument is genuine can only be established by considering the type and initials of the rose

in the context of all the other features of the instrument.

Closely related to the type and diameter of the rose in the instrument is the signature on the instrument. Typically a Ruckers instrument is signed simply: 'X....S RVCKERS ME FECIT ANTVERPIÆ'. I know of no genuine signature which includes the date. The date is always found on the soundboard or wrestplank. Also the word 'Anno' or 'A^o' was never used.

Features of case construction and materials

Most authentic Ruckers instruments, regardless of the extent by which they have been altered, retain most of the case-side material and some of the internal bracing. To be authentic a Ruckers instrument must be constructed of poplar. Softwoods (fir, pine and spruce) and lime, which is a much denser and more finely grained wood than poplar, were never used for the case-sides or internal framing by any of the Ruckers family. Usually the poplar used is a dull creamy colour with reddish brown or sometimes greyish streaks (Populus canescens?).

The actual length and height of the case-sides is also very characteristic in Ruckers instruments. The virginals are always close to their nominal lengths in Flemish voeten, although a certain amount of variation occurs between spinetts and muselars, and in the case of the large mother instruments. Some idea of the limits of the variation in the length of Ruckers virginals is given in the table below. (The heights given do not

include the thickness of the baseboard. When only one value of the height and length is given it means that there is only one known instrument of that type.)

Length and height variation of Ruckers virginals in mm

Type of Instrument	Nominal Length	Length	Height
6-voet mother muselar	1708	1706 - 1786	252 - 254
6-voet mother spinett	1708	1708	254
6-voet muselar	1708	1668 - 1712	239 - 243
6-voet spinett	1708	1660 - 1711	234 - 236
5-voet muselar	1423	1424 - 1500	202 - 205
4½-voet muselar	1281	1304	191
4½-voet spinett	1281	1282	190
4-voet spinett	1139	1136 - 1143	177 - 178
child	--	795 - 819	122 - 127
2½-voet spinett	711	711	-*

*This instrument has sloping case sides.

Unlike the virginals, the harpsichords do not seem to have been made in lengths which were measured in whole or half units of the Flemish voet. However most singles are about 6 voet 4 duimen long, and most doubles are about 7 voet 10 duimen in length. The variation is given below (parenthetical values are unique, but genuine, examples outside of the normal range).

Length and height variation of Ruckers harpsichords in mm

Type of Instrument	Length	Height
Double-manual harpsichord	2210 - 2254 (2274)	252 - 254
Single-manual harpsichord	1813 - 1829 (1864)	228 - 231*
4-voet single-manual harpsichord	1232	190

*The single-manual harpsichords painted with the strapwork decoration instead of the more common marbling are 241 - 242 mm high. Also I have not included here the very late single-manual harpsichords of Ioseph Ioannes Couchet which are much longer and higher than the dimensions given here.

Although there are clearly exceptions, few virginals deviate more than a few millimetres from the nominal length in voeten, and the variation in the length of the harpsichords seldom is greater than about 1% above or below the average. Hence any instrument which has a length or height which deviates markedly from the limits given above must be liable to suspicion.

Virginals were seldom faked or falsified, and I know of only two counterfeit virginals. In deciding if a given virginal is genuine, it must, in addition to having the correct dimensions and case material, have the other characteristics of Ruckers virginals outlined in Chapter 5. It is however worthwhile giving here a few typical features which can be checked quickly before a detailed examination is made. Firstly the case corner-joints are simple mitred joints which are pegged together and are not dove-tailed. Except for the child virginals

the nameboard is removeable to allow access to and removal of the keyboard in a genuine Ruckers virginal, rather than having a fixed nameboard and a removeable namebatten. There are also no keyblocks beside the keys in a genuine Ruckers virginal; instead the outside keys are immediately adjacent to the sides of the keywell formed by the two keywell braces. Also Ruckers virginals have no moulded batten running around the inside of the case above the soundboard (which would be used as a hitchpin rail along the spine and left-hand side of the instrument). The bass strings in the muselar virginals are raised up on a small rectangular block of wood, but other than this there is nothing covering the soundboard near the edge of the case.

In Ruckers harpsichords the case joins are also not dove-tailed. The type of join used is however very characteristic, and will often help to distinguish a genuine instrument from a fake. The spine-tail join is a simple mitre which is pegged together (see Fig. 9-1).

The tail-bentside and bentside-cheek joins are made as shown in Fig. 9-2. If these joins are simple mitre joins, or if the lapped part of the join is on the wrong case side, then the instrument is almost certainly unauthentic.

Another feature often easily recognised is the way the recesses cut into the spine and cheek for the jackrail are made. In Ruckers instruments the jackrail recess is a simple rectangular slot. In many 18th century instruments the jackrail is mitred into the recess so that the

Ruckers

Join found in some fakes

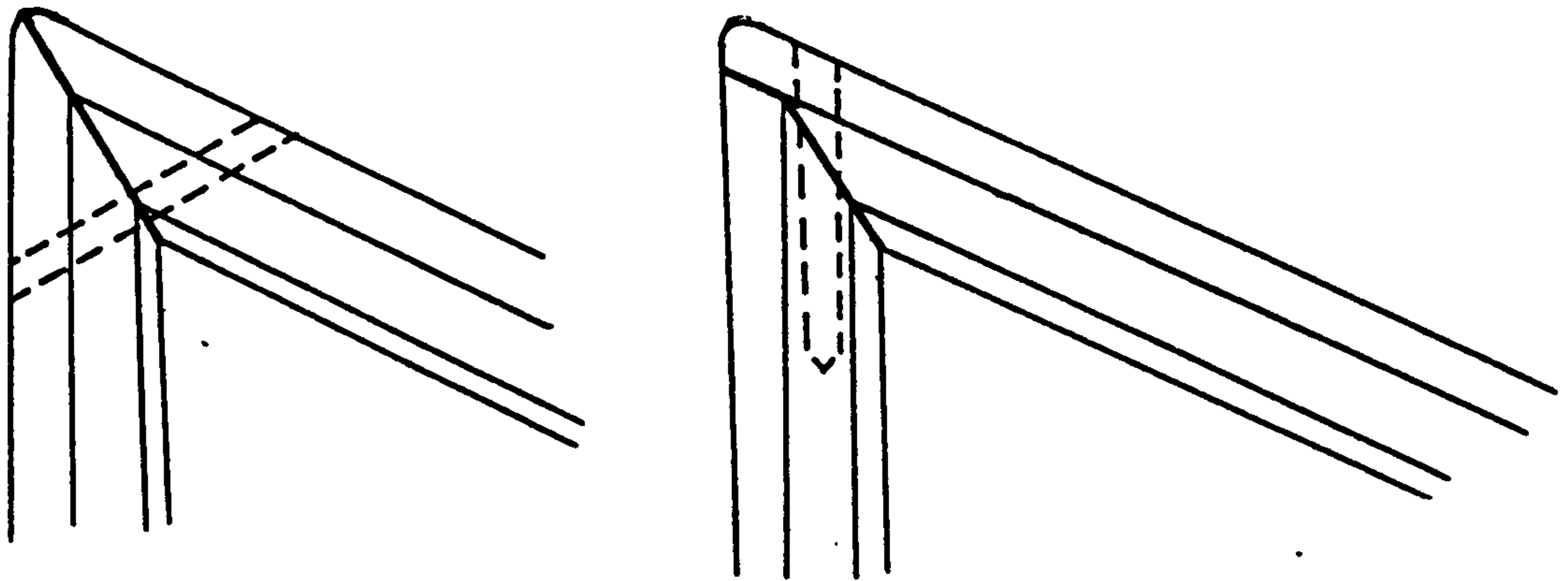

Fig. 9-1 The spine/tail case join.

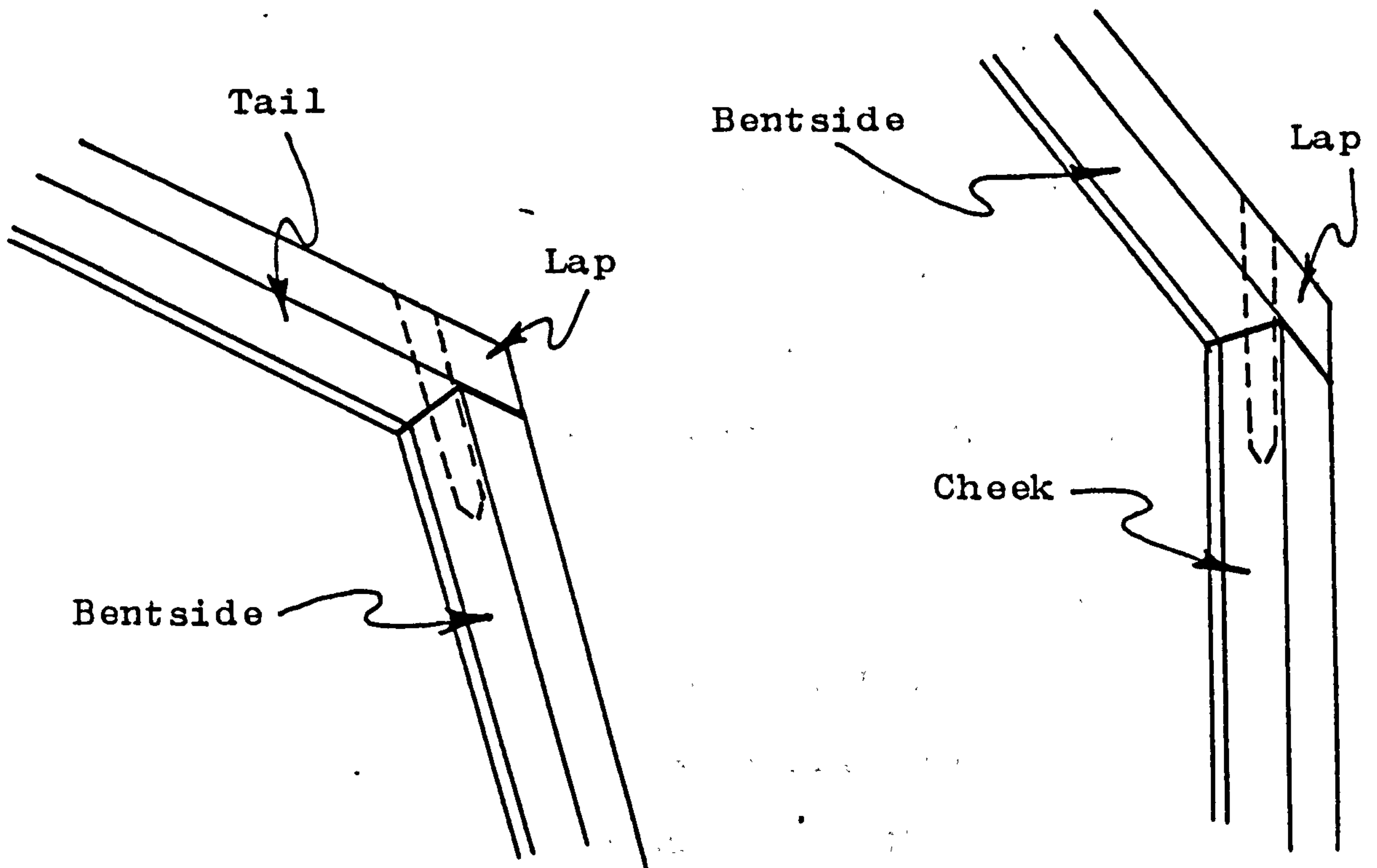

Fig. 9-2 The tail/bentside and the bentside/cheek case joins in authentic Ruckers/Couchet harpsichords.

moulding on the case-side and jackrail meet at 45° . An instrument with a mitred jackrail recess is therefore liable to suspicion unless of course the gap and jackrail have been later widened in the process of adding an extra register.

Whether or not the internal framing has disappeared, most instruments will retain the soundboard liners. The dimensions of these liners are not very constant, but they are about 15 to 20 mm thick and 45 - 65 mm high. Usually the tail liner is thicker and higher than the spine or bentside liner. The feature of the liners which is characteristic of Ruckers instruments is that the lower corner of the liner is chamfered, instead of being left as a sharp edge (see Fig. 9-3). This detail is one that even the most fastidious conterfeiter or faker is sure to have overlooked, and is one that is very often lacking even on 17th century Flemish instruments which have been falsely attributed to one of the Ruckers (e.g. B.106)

Clearly the most difficult instruments to distinguish from a genuine Ruckers is one made by one of the Ruckers contemporaries in Antwerp, and then later misattributed. Besides the chamfering of the soundboard liners, the construction of the toolbox in the harpsichords seems to have been done differently by the Ruckers from most of the other contemporary Antwerp builders. Ruckers harpsichords have a toolbox on the spine side of the instrument. The lid of the toolbox is cut out of the spine itself and is hinged with wire hinges

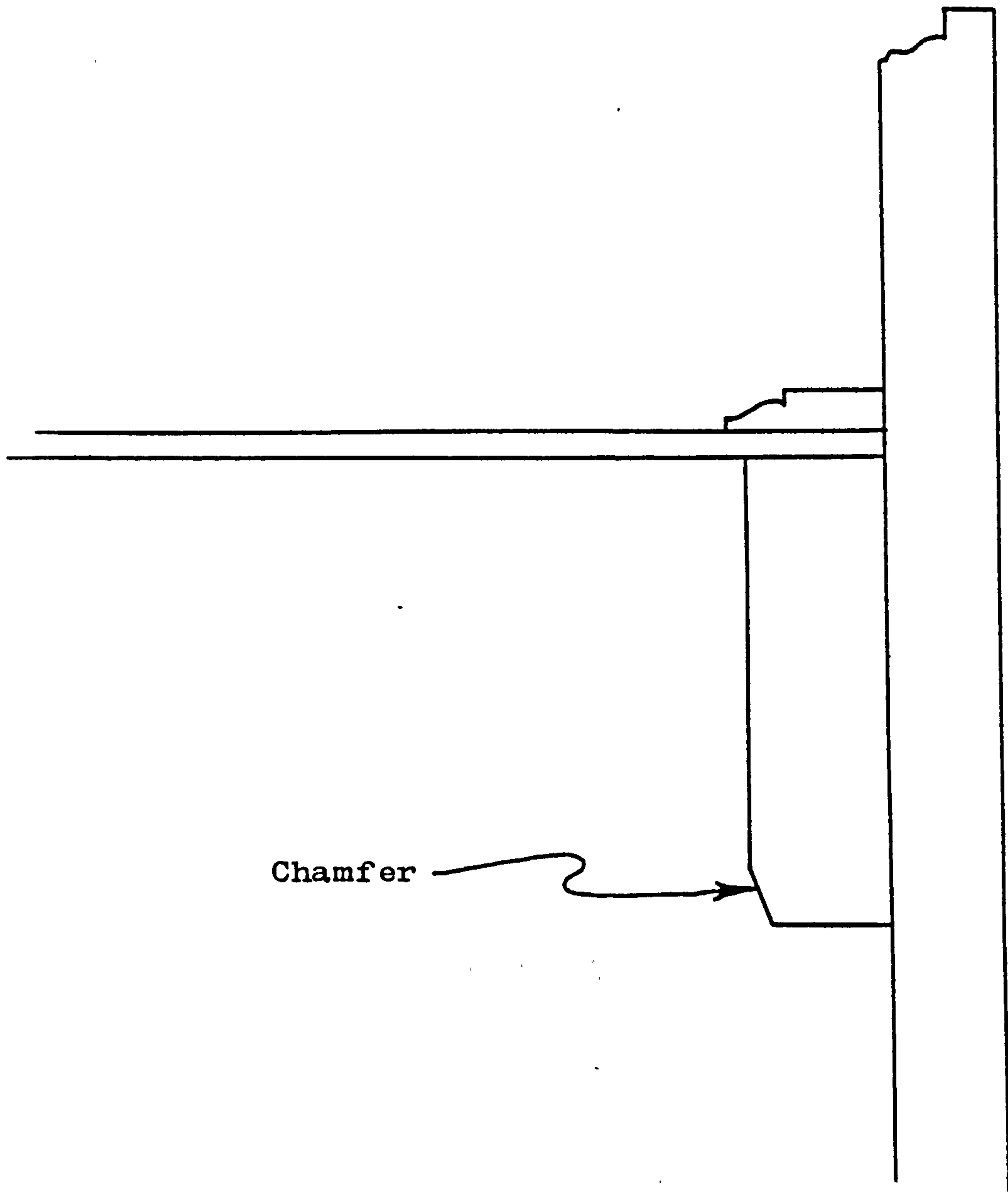

Fig. 9-3 The chamfered soundboard liner in an authentic Ruckers clavecimbel.

to the baseboard. The sides of the toolbox are formed by two baseboard braces which are let into the spine and cheek on either side. The near baseboard brace is just the lower belly rail against which the keyboard butts and to which are fixed the keyboard hold-down blocks. The rear toolbox brace is the same height as the lower belly rail and runs at a slight angle to it, being further from it at the spine (about 200 mm) than at the cheek (about 25 mm). If the two toolbox braces were parallel, then the rear one would be let into the bentside, and only the near one (the lower belly rail) would be let into the cheek; angling them ensures that both are let into the cheek-piece. Other 17th century Flemish builders, if they have a toolbox, usually have toolbox braces that are parallel so that one brace is let into the cheek and one into the bentside at the right. But some Flemish builders simply did not have a toolbox, although the two braces, either angled or parallel may exist. If there is no sign of the former existence of a toolbox flap on the spine, or if the toolbox braces are parallel instead of being slightly angled, then the instrument displaying these features is almost certain to be unauthentic.

Differences in the constructional methods between the various members of the Ruckers family

Considering the long period in which the Ruckers worked - from 1579 for Hans Ruckers, until before 1706 for Ioseph Ioannes Couchet - and considering the fact that at least six different people are involved, the

standardization of the product of their workshops is remarkable. The earliest virginals, and the latest harpsichords, are slightly different in detail from the rest of the instruments built in this period, but otherwise the instruments are so similar in construction that it would be very difficult to tell which member of the family built a given instrument were it not for the signature, rose and decoration.

The differences in the construction of the virginals between the various members of the family seem to be almost non-existent. I have, in fact, found only one difference which might be used to distinguish which maker might have built a given virginal although even this is not universal. The width of the keywell varies slightly in Hans/Joannes virginals from that in Andreas I and II virginals. In Hans and Joannes Ruckers virginals the original width of the keywell varies from 645 to 648 mm, and in Andreas Ruckers instruments the keywell varies from 650 to 652 mm wide. Early and late virginals can be distinguished even if the signature, rose and soundboard decoration have disappeared. Before about 1627 the soundboard would have scribed circles used as a guide in painting the wreath and the red and white rope pattern around the rose. In virginals built after about 1627 these circles were not scribed on the soundboard. Unfortunately the existence or lack of these scribed circles around the rose cannot be used to distinguish Andreas from Joannes Ruckers virginals since

the decorators working in the two workshops changed the style of painting the wreath at almost the same time (in fact it seems likely that entirely new decorators started working in both workshops at about this time).

Fortunately there are a few more differences between the harpsichords built by Andreas and those of Ioannes Ruckers. Most of these are minor differences and have no bearing on the musical qualities of the instruments. However, although I have not had the opportunity of checking this for a large number of instruments, there does seem to be a major and important difference in the way the two Ruckers decided upon the thickness of their harpsichord soundboards. Ioannes Ruckers seems to have tapered his soundboards from 4.3 mm or more under the tenor part of the 8' bridge to less than 2 mm in the extreme treble. Andreas Ruckers harpsichords on the other hand have soundboards tapered from about 3.8 mm in the tenor to about 2.2 mm in the treble. This may mean that, being stiffer in the treble, the Andreas Ruckers harpsichords sustain longer and have slightly less attack there. In the bass the extra stiffness of the Ioannes Ruckers soundboards would sustain better and in addition would tend to reinforce the higher harmonics of the strings increasing slightly the clarity and brilliance in this region of the compass.

The cross-sectional shape of the 4' hitchpin rail is also slightly different in Ioannes and Andreas Ruckers harpsichords, and this is especially noticeable in the treble. The hitchpin rails in Ioannes Ruckers harpsichords

have a distinctly rectangular cross-section in the treble, with one of the shorter faces of the rectangle glued to the soundboard; in Andreas harpsichords the treble part of the 4' hitchpin rail is almost square in cross-section (see Fig. 9-4).

There are in addition two minor features which distinguish the late (i.e. post c 1625) harpsichords of Ioannes and Andreas Ruckers and which are readily visible and measurable from the outside of the instrument. Firstly the moulding on the soundboard liner/8' hitchpin rail is different for the two builders as indicated in Fig.9-5. Also, the harpsichords made after about 1616 have different sized soundboard rose-holes. In Andreas Ruckers harpsichords these are about 65 mm in diameter; in Ioannes Ruckers harpsichords the rose hole has a diameter of about 73 mm in single and about 85 mm in double-manual harpsichords. Unfortunately, the two builders used the same soundboard liner mouldings and rose hole diameters in their earlier instruments.

Ruckers instruments in paintings

Harpsichords and virginals are often depicted in Flemish paintings of the late 16th and 17th centuries. Like the fine interiors of their houses and the elegant furniture they contained, the paintings, rugs, magnificent costumes and musical instruments were all symbols of the wealth of the bourgeoisie, and of course these increasingly wealthy middle-class citizens enjoyed being painted with their finery surrounding them. Breughel, Steen,

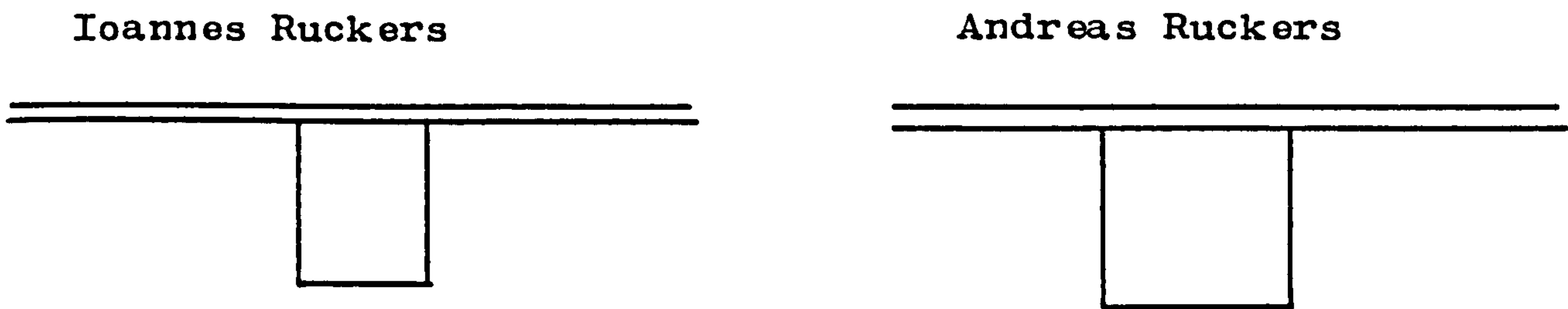

Fig. 9-4 Comparison of the treble section of the 4' hitch-pin in Ioannes and Andreas Ruckers harpsichords.

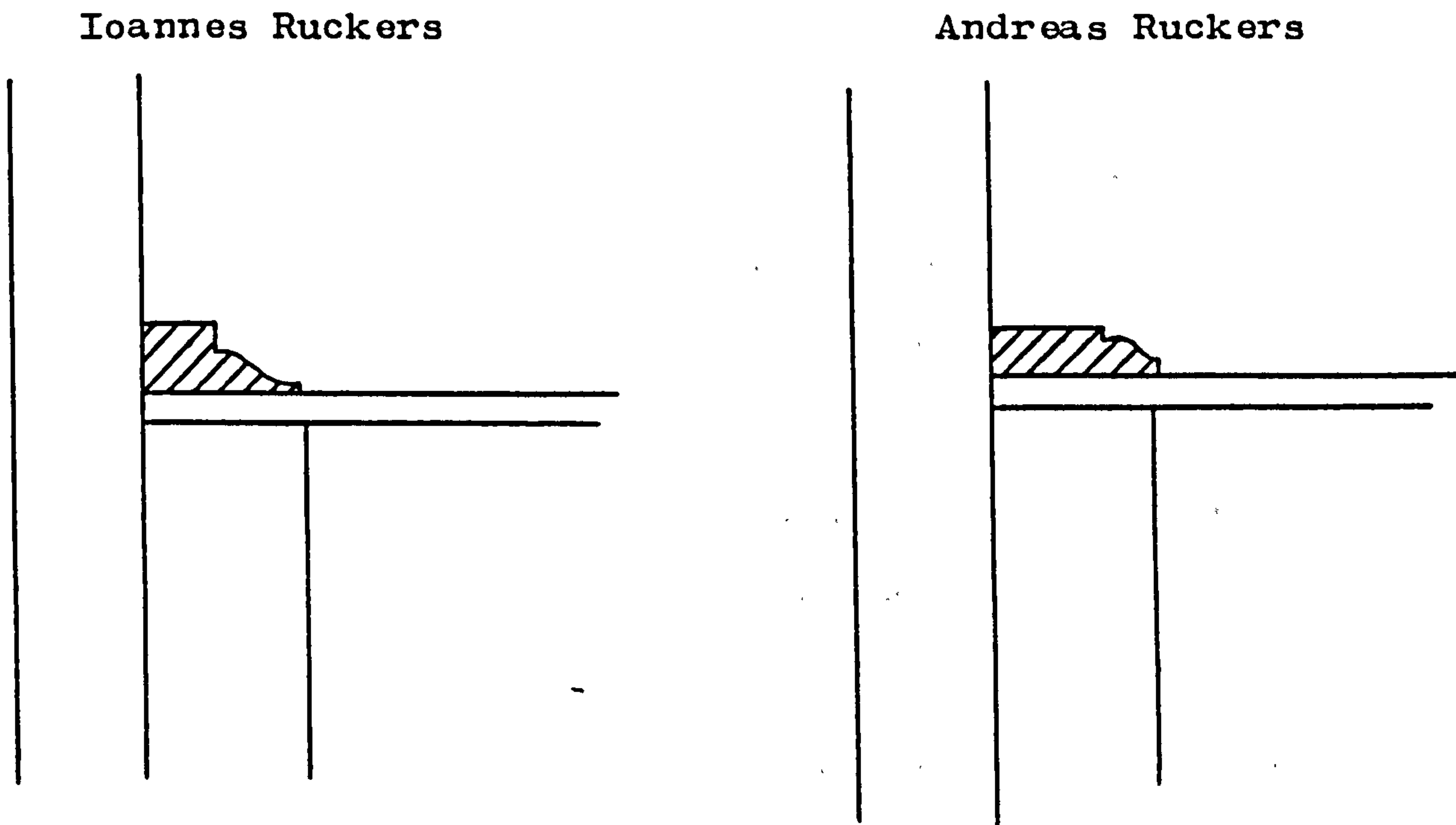

Fig. 9-5 Comparison of the soundboard liner moulding profile in the post-c1625 harpsichords of Ioannes and Andreas Ruckers.

Tilborch, Cornenelius de Vos, Catharine de Hemessen, Metsu, Teniers, Frans Floris, Gonzales Cocques, Vermeer, van Kessel, de Zeeuw and David Ryckaert, all painted genre scenes which include either a Flemish harpsichord or virginal. The question is - are the instruments depicted by one of the Ruckers family?

The answer to this cannot, of course, be definitive since usually neither the signature nor the rose is depicted in the painting. Most often it is clear that the instrument is not by one of the Ruckers, rather than that it can definitely be attributed to a member of the Ruckers family. Usually there are few constructional details to base a decision on, and one must rely on details of the decoration to determine if the instrument might possibly be a Ruckers. Even at the best one is relying on the artist involved to have been accurate in his depiction of the instrument, and not to have exercised artistic license to improve the appearance of the instrument, or to alter proportions to give a more pleasing balance to the canvas.

One of the most obvious constructional features of a harpsichord visible on a painting is the lid. If the lid is only in one long section, without the usual break between the lid flap and main lid, then the instrument portrayed is probably not a Ruckers (although Joseph Ioannes Couchet made the lids for his harpsichords in one long continuous section). All extant Ruckers harpsichords with their original lids are made with the lid

hinged near the position of the far edge of the jackrail into two separate sections. If the instrument depicted is a double-manual harpsichord, then the lid flap should be framed on the inside with a wide black and yellow (varnished wood) picture frame, since all genuine Ruckers doubles which have original lids seem to have this type of lid flap construction. Also the lid-stick was not used on 17th century Flemish harpsichords. Either the lid was held open with a cord, or the instrument was placed near a wall and the lid leaned against a wall.

Other than the hinging of the lid in two sections, few other constructional details are normally visible in a painting. Sometimes the keyblocks (and their decoration), the key arcades, the jackrail, the protruding registers, and the nuts and tuning pins are visible in the painting, and the details of these will have to be compared with Ruckers normal practice before it can be suggested that the instrument might come from the workshop of one of the Ruckers family.

Details of the decoration may also give a clue as to whether the instrument is a Ruckers or not. The marbling of the exterior of the case on the harpsichords should be continuous across the case joins around the instrument. If the marbling is done in panels with vertical borders running up and down the case sides at the joins, then the harpsichord can probably not be attributed to the Ruckers. Sometimes the strapwork decoration, with the large semi-precious stones held against a marbled background by iron

straps, is depicted instead of the more simple marbled decoration. Details of this decoration must be compared with that usually found on Ruckers instruments (see Chapter 7, p. 477) before attributing the harpsichord to the Ruckers. Since all Ruckers virginals seem to have originally had the speckled off-white on green porphyry faux-marbre, the depiction of a Ruckers virginal should also have this sort of decoration. On the other hand, I know of no 17th century Flemish (or other) genre paintings of virginals which show a green porphyry outer decoration.

Usually the printed papers (which are sometimes identifiable as one of the patterns used by the Ruckers), the case mouldings, hinged keywell flap, etc. are visible in the painting. These must of course all be in the usual style of the Ruckers. If the lid is papered, then there should be the usual border of varnished wood and black band surrounding the outer printed paper strip pattern.

Photo 9-2 shows an instrument in a painting by Jan Breughel which quite possibly is by one of the Ruckers. The lid is hinged along a line just behind the jackrail, and the lid flap is framed by a wide moulding with the usual black ink and varnished wood decoration. The outside of the case is marbled and this marbling is continuous around the case and not in panels since there is no vertical 'iron' strap at the front edge of the cheek. The instrument is obviously a transposing instrument and the block of wood in the bass of the upper manual next



Photo 9-2 Detail from Breughel's 'The Sense of Hearing' showing a Flemish harpsichord which is probably by one of the Ruckers.

to the C/E short octave is clearly visible. The upper manual keyblock has roughly the same curved shape as in the normal Ruckers instrument, and it is also plainly decorated with just a coat of varnish. The lower manual, at least, has key fronts decorated with white and red gothic arcades; the artist seems to have forgotten to paint these in on the upper manual. The papers on the batten above the lower manual and the keywell paper are clearly identifiable as Type 17 and Type 12 respectively, and the soundwell paper and the border paper of the keywell flap may be Type 6. The motto on the keywell flap must be (ACTA VIRVM PROB)ANT, and this is a motto often found in this location of Ruckers instruments. The mouldings on the case sides and jackrail are of varnished wood, and the arcaded stand (more of which is visible in the whole painting) is typical of those found with some Ruckers instruments. The line of the 4' tuning pins is visible and even the soft leather buff pads of the buff register can be seen behind the 8' bridge! The instrument as depicted is atypical of Ruckers instruments in only one small detail: the black line between the marbling and the lower 'iron' strap on the cheek should be white instead of black (imitating a highlight produced by the light striking the top edge of this iron band). But so many of the other particulars are so similar in every detail to those of Ruckers instruments that it is at least highly likely that the instrument used as a model for this painting by Breughel was by one of the Ruckers -

the style of the marbling (like the 1615 AR) and the choice of the papers make it more likely to be by Andreas Ruckers.

The value and importance of fake and counterfeit Ruckers instruments

Although a large proportion of those instruments bearing the name Ruckers are not genuine, virtually none of these unauthentic instruments is without its interest or historical value. Despite the hiatus in the musical interest in the harpsichord, which lasted most of the 19th century, the name of Ruckers seemed to have been known among the collectors and musical historians as one of the great names in the harpsichord world. This had the fortunate result that far more instruments signed with the name Ruckers survived than would otherwise have been the case. But until recently both the genuine and unauthentic instruments were accepted, usually without question, as having originated in the Ruckers workshops. This group of instruments, seen as a whole, exhibited such a variety of types and sizes, with many different compasses, dispositions, types of decoration, etc. that no one questioned their authenticity, or found the odd deviant instrument suspect. The result has been to preserve many non-Ruckers instruments which would not otherwise have survived. Had it not been for the Ruckers signature and the inability of the owner to distinguish the genuine from the fake, these instruments would have been destroyed or lost along with the other instruments of their type. Because of this

they are often extremely rare or even unique examples of their type.

Unfortunately however, there is a popular misconception that because an instrument is a fake or counterfeit Ruckers it is worthless and to be ignored. It is true that a counterfeit banknote does not have the same attraction that a genuine banknote does, and that a violin labelled Stradivarius is open to immediate suspicion and is probably not even an Amati or a Klotz which has been falsified by adding the Stradivarius ascription. The same is not true of an unauthentic 'Ruckers' instrument. Even if they are downgraded into being simply anonymous, and in the style of a particular builder or school, their historical and musical value are often greater than they would be if they were genuine. And their monetary value should therefore be at least as great as if they were by one of the Ruckers family.

For example few Flemish virginals exist by any of the Ruckers contemporaries; only instruments by van der Biest, Bos, Grauwels and Bader have survived. But two fake Ruckers virginals, the '1610 HR' in Halle (B.10) and the '1620 HR' in Lisbon (B.23) are both certainly Flemish, but not by Ruckers. As one of the few instruments which was originally a double virginal the '1620 HR' in Lisbon is particularly of interest and is an especially fine example of its type. Few Flemish harpsichords exist which are contemporary with, but not actually by, one of the Ruckers. But two unauthentic singles, the

'1629 IR' in Antwerp (B.50), originally with a very wide compass of G_1 to e^3 , and the '1639 AR' in Brussels (B.106) give a good idea of the original construction practice of two non-Ruckers singles. Also two Flemish doubles, the three-slide transposing harpsichord in Brussels (B.26) (see Chapt. 2, p. 74) and the aligned double '1658 HR' (B.24) are both examples of unusual Flemish construction which would almost certainly not otherwise have survived were it not for the fact that they are both falsified Ruckers. And both are unique examples of instruments which were probably once relatively common and without which we would be totally ignorant of their existence.

Two counterfeit instruments, the '1634 IR' double in Ham House, London (B.54) and the '1646 AR' single (B.116) (and possibly the 1623 double owned by Michael Thomas) are by the same builder and were probably constructed about 1700 to 1720 in England. Harpsichords of any sort from this period and built in England are very rare, and doubles are particularly unusual. These instruments are therefore especially interesting examples of their type, which do not otherwise exist.

Another benefit we receive as a result of the high survival rate of unauthentic Ruckers instruments is that the work of some builders is now more common through their fake and counterfeit instruments than through their own signed instruments. For example, only two instruments (both spinets) signed by Jean Claude Goujon exist. However, at least three harpsichords, all attributed to



Photo 9-3 The soundboard of the '1634 IR' (B. 54). The shape of the case and the layout of the bridges and 4' hitchrail is notably different from that of Ruckers.

Ruckers are by Goujon: the 1732 '1615 HR' (B.21), the 1749 '1590 HR' (B.4), and the 1757 '1632 IR' (B.52a).

These instruments, plus the two genuine Ruckers ravalé by Goujon, the 1632 IR ravalé in 1745, and the 1627c IR, ravalé in 1759, all greatly increase our knowledge of Goujon's work, and establish him as one of the great French 18th century master harpsichord builders.

But probably the greatest benefit we receive from the survival of forged Ruckers instruments is a heritage of very fine musical instruments. The '1590 HR' double harpsichord just mentioned by Goujon, is now recognised as one of the finest 18th century French harpsichords. The '1634 IR' (B.54) double by an anonymous English builder, is interesting not only as an example of early 18th century English counterfeiting practice, but is more importantly a very fine musical instrument. The '1644 HR' (B.23b) anonymous French double manual harpsichord is one of the finest sounding harpsichords I have ever heard. Such instruments are not to be disregarded as mere forgeries; they are extremely fine and highly interesting and valuable instruments in their own right.

Chapter 10 - The Influence of the Ruckers/Couchet Tradition
on Later Harpsichord Building Practice

On the basis of the number of surviving instruments, the most prolific members of the Ruckers family were Ioannes and Andreas (I and II). The last dated instrument from Ioannes comes from 1642, and the last instrument signed Andreas Ruckers is dated 1654. The truly surprising thing is that during the period from 1579 to the middle of the 17th century the instruments built by the Ruckers were very similar to one another and exhibit virtually no development or innovation. With extremely few exceptions the virginals and single-manual harpsichords had the compass C/E to c^3 . Almost all double-manual harpsichords had a C/E to c^3 upper-manual compass and C/E to f^3 on the lower manual. Any variations to these were either the early virginals with a C/E to a^2 compass, or the larger compass of the models apparently made for export: the chromatic C to c^3 singles for England, and the chromatic G_1 to c^3 - F to f^3 doubles for France.

But not only did the compasses remain the same throughout these 70-odd years, but also the disposition of the instruments never altered. Most of the virginals built were single virginals and these perforce had only one set of strings. Among these the smaller virginals, which to the modern musician seem especially restricting because of their high pitch and tessitura, were produced in considerably larger numbers than the big 6-voet vir-

ginals at a pitch R. Even the rate of production of the mother and child virginals, which might have been thought more versatile and expressive, seems to have remained constant during this entire period. Thus the greater potential of the two manuals of the coupled mother and child does not seem to have been exploited, or at least there was no increase in the musical demand for its extra potential for variety and contrast.

Similarly the harpsichord disposition did not change during this period. All harpsichords signed by the Ruckers appear originally to have had the disposition 1 x 8', 1 x 4' and, not a single contrasting double-manual harpsichord with aligned keyboards seems to have been built by the Ruckers; all Ruckers doubles appear originally to have had unaligned keyboards.

The conservatism, both of the building practices of the Ruckers and of the contemporary music, which is implied by these conclusions is rather surprising since at least some change would be expected during a period of 70 years. Ripin¹⁰⁻¹⁾ has suggested from iconographical evidence that 3-register and aligned doubles were built in Flanders. But if the illustrations he cites can be relied upon for details of compass and the number of registers, then they must be assumed to be accurate in other details as well. If so then none of the illustrations is of a Ruckers instrument, since they all depict instruments with particulars uncharacteristic of Ruckers usual practice of construction and decoration.

Thus although other Flemish builders may perhaps have experimented with ways to alter or increase the musical potential of their instruments, this does not seem to be true for the surviving instruments of Hans, Ioannes and Andreas Ruckers.

Ioannes Couchet and the beginning of change

The Couchets, either because they possessed a natural flair for innovation, or because they were under pressure from a change in musical requirements and taste, broke away from the conservative tradition followed by the Ruckers. That is not to say that the materials or methods of construction used in their instruments were different: in this respect the tradition is continuous and unbroken. Although Couchet instruments clearly belong to the Ruckers school from their outward physical appearance and the methods used in their construction, they practically all exhibit a greater musical potential than the earlier Ruckers instruments.

The last two double-manual harpsichords built in the Ruckers tradition were both built in 1646, which year thus marks the end of the epoch in which harpsichords with unaligned keyboards were made. One of these doubles was made by Andreas Ruckers (1646 AR) with keyboards having chromatic compasses from F and G₁ (see p. 514). Although few of this type of large double were made, the construction of this harpsichord cannot be considered a new development since a similar type of harpsichord exists made already in 1616 (1616 HR). However the second

double, made by Ioannes Couchet (1646 IC) is unusual in having two 50 note keyboards; the upper manual with a compass of G_1/B_1 to c^3 , the lower manual a fourth lower with the normal C/E to f^3 compass. Couchet can therefore be credited as being the first person known to have used the G_1/B_1 short octave. The 1646 Couchet instrument is also unusual in being at a pitch $R + \frac{1}{2}$, a semitone above R, a pitch not found originally in any other Ruckers/Couchet instrument.

The last two Ioannes Couchet harpsichords also introduce new musical possibilities not found in earlier Flemish instruments. Both of these instruments have since been converted into double-manual harpsichords although they were originally singles. One, built about 1650 ((c1650)b IC) originally had a compass of F_1, G_1, A_1 to c^3 and was at a pitch $R + 1$. Although it had the conventional 1 x 8', 1 x 4' disposition the compass extending down to F_1 was very advanced for this period and remained the standard bass compass in most of Europe for the next 150 years.

The second and latest surviving Ioannes Couchet instrument shows even more innovation on the part of its builder. This harpsichord (1652 IC) was built originally without a 4' and had a 2 x 8' disposition. But what is totally unexpected is that it had 3 registers probably arranged:

→ 8'

← 8'

→ 8'

Also most unusual is that these 3 registers seem to have been operated by some sort of trapwork connected to pedals or perhaps a genouillère. This is also the first single-manual harpsichord known to have been designed with a bass G_1/B_1 short octave.

Documentary evidence exists which relates to these two instruments and throws an interesting light on the activity of Couchet (see Appendix 17 and Appendix 18). These are letters written in the spring and summer of 1648 between G.F. Duarte and Constantijn Huyghens and between Couchet himself and Huyghens. The earlier letters are those from Duarte. From these we learn that Huyghens had asked for a "large harpsichord with one full keyboard down to the octave of G sol re ut (G_1)". Duarte informs Huyghens that Couchet could build a harpsichord with 3 registers disposed 2 x 8', 1 x 4' and at a pitch he calls Corista (i.e. at a pitch R). The idea of having two sets of 8' strings was clearly novel at this time, and the potential for combining the different registers, or using them alone, was clearly realized. The instrument finally built for Huyghens had "a full keyboard down to the octave of ef fa ut (F_1) and up to the cadence of the la sol re (d^3)", and this presumably means from F_1 chromatic, so that the notes $F_1^\#$ and $G_1^\#$ may not have been missing as in the (c1650)b IC harpsichord.

From Couchet's letter it is apparent that it was disposed 2 x 8' notwithstanding Couchet's personal pre-

ference for the old 1 x 8', 1 x 4' disposition. Although the instrument built for Huyghens was at a pitch R (Corista), Couchet also mentions building harpsichords a tone higher (i.e. at R + 1), and nothing further is said of the 2 x 8', 1 x 4' disposition mentioned by Duarte. Thus the pitch of the (c1650)^b IC harpsichord at R + 1 is not surprising and might be expected in this and other harpsichords built by Couchet and his sons. Couchet also wisely provided some sort of pitch pipe with the instrument to which the note g of the harpsichord was to be tuned.

The Couchet sons and the developing tradition

Three of Ioannes Couchet's sons, Petrus Ioannes, Ioseph Ioannes and Maria Abraham became harpsichord builders. A harpsichord with the signature Petrus Ioannes Couchet and dated 1669 exists in the Gemeentemuseum, The Hague. It has an IC virginal rose in the soundboard, and the signature is on a namebatten which, because it fits the later altered width of the instrument, is not original. The authorship of this harpsichord is therefore in doubt. Although the tradition of using a different type of rose in virginals, single-manual and double-manual harpsichords seems to have ended with Ioannes Couchet, it is possible that both the rose and signature were added to this instrument in a later period. In any case the instrument is built in a style that is quite atypical of the usual Ruckers/Couchet practice and I have therefore not included it among those which clearly belong to that tradition.¹⁰⁻²⁾

This instrument is, however, similar in many respects to those of George Britsen. The relationship between the Couchet sons and Britsen suggested by Dr. Lambrechts-Douillez¹⁰⁻³⁾ might be proved if the instrument were by Petrus Ioannes Couchet, and a definite link in the building practices of the two could be found.

No instrument signed by Maria Abraham Couchet survives, but several harpsichords either signed or attributable to Ioseph Ioannes Couchet exist. These exhibit features which clearly show the desire on the part of builders in the second half of the 17th century to satisfy the changing musical tastes. The 1671/73 IC harpsichord has been so drastically altered that its original compass cannot be easily determined, but there is no doubt that it originally was disposed 2 x 8'. It was almost certainly at a pitch of either R or R + 1, but which of these also cannot be determined. Nevertheless this harpsichord gives evidence of a new preference for a disposition with two sets of 8' strings rather than the traditional 1 x 8', 1 x 4'.

The 1679 IC harpsichord in the Smithsonian, Washington signed by Ioseph Ioannes is preserved in its original musical state. Its compass of C to c³ chromatic must be considered conservative for this date, considering the large compass of some of the instruments built by Ioseph's father Ioannes Couchet some 30 years earlier. Like the 1652 IC it has three registers, and the disposition 1 x 8', 1 x 4'. But there are two 8' registers

of jacks both plucking the same set of strings, and separated by the 4' register to give the maximum possible tonal difference between them.

The 1652 IC harpsichord did not have registers projecting through the cheek, and this along with other evidence (see Catalogue p. 778) suggests that the registration was originally changed with some sort of a machine. Although the 1679 IC has three registers they do project through the cheek, and since there is no other evidence to the contrary it seems unlikely that it had a machine stop. However the two rows of 8' jacks placed on either side of the 4' row gives clear evidence of the new desire for tonal contrast and variety, just as the machine stop does in the earlier 1652 instrument.

Two further instruments, probably also by Ioseph Ioannes Couchet, shows more desire for an increased range than for tonal diversity. The 1680 IC harpsichord had an original compass with 34 naturals from F_1 to d^3 , probably like that described by Ioannes Couchet and Duarte (see Appendix 17 and Appendix 18) with "a full keyboard" down to F_1 . The pitch of the instrument, also like that made for Huyghens was at R or Corista pitch.

The large undated Couchet harpsichord in Stockholm (n.d. IC) is probably the last surviving instrument built in the Ruckers/Couchet tradition. Besides being extremely long (originally about 2630 mm, and so considerably longer than a double-manual Dulcken!) it originally had the very large compass F_1 to d^3, e^3 . This compass (with

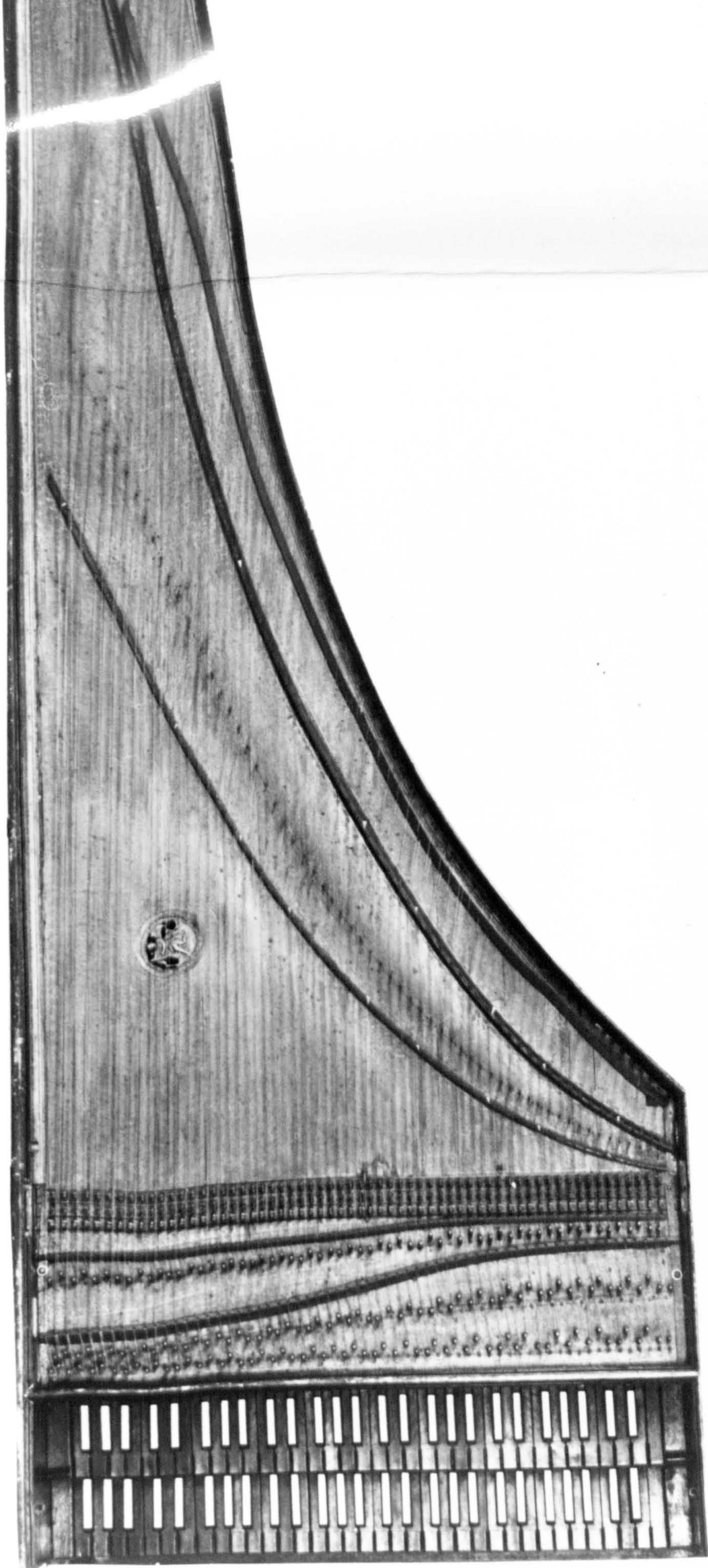

Photo 10-1 Plan view of the n.d. IC harpsichord. The width of the instrument has never been changed, but the keywell has been lengthened in 1768 by Pascal Taskin.

Scale 1:10

e^{b3}) is greater than that found on English instruments of the 1720's and was that still used by Blanchet in the 1730's! The reason for designing such a long instrument is not clear. The (c1650)b IC and the 1680 IC harpsichords which also originally went down to F₁ are slightly longer than those which went down to G₁, but there is no precedent for the length of this unusual harpsichord. At a pitch of R + 1, the bass strings are so long that only the 8' note F₁ could be strung in red brass. If red brass were used any higher up in the compass the scalings are so long that red brass strings would break. Was the instrument therefore designed specifically to have scalings suitable for only yellow brass stringing right down to the lowest note? Such a possibility suggests that, not only were the Couchets involved in experiments with registration and compass, but also with stringing and scalings.

It seems unlikely that only one instrument of this type was built. And although it is even longer and uses longer brass scalings than the instruments built by Dulcken it seems clear that the model provided by the Stockholm Couchet is the prototype for the later 18th century instruments made by Dulcken. Thus although Dulcken's instruments are longer than those of his contemporaries working in France, Germany and England, their length is not an innovation on Dulcken's part. But rather he was following in the path already trodden some 60 to 70 years earlier by Couchet.

The Ruckers tradition in England in the 18th century

It is known that by 1706 Joseph Ioannes Couchet was dead. However, as he was born in 1652, it would have been quite possible for him to have lived into the early seventeenth hundreds, although it is not known if he built any instruments after 1680. Nevertheless, whether any of the harpsichord building Couchets survived into the 18th century or not, the tradition to which they were the heirs was carried on after their demise.

James Shudi Broadwood, writing in 1838, says that Hermann Tabel brought the Ruckers/Couchet tradition with him from Antwerp to England. Tabel was born in the Low Countries, and according to several sources,¹⁰⁻⁴⁾ worked with the successors of the Ruckers in Antwerp, i.e. with the Couchets. After working with the Couchets and learning harpsichord building with them, Tabel removed to London in the early years of the 18th century before 1716. There he set up his own workshop and began building and selling harpsichords for the English market.

Unfortunately only one instrument by Tabel survives (for a complete description see Mould 1971). This is a double-manual harpsichord dated 1721 and is in the County Museum, Warwick. Although this instrument most closely resembles the later harpsichords of Shudi and Kirkman and the other 18th century English builders, the influence of the Ruckers/Couchet tradition is strong. Unlike the short-scaled, thin-cased instruments by such contemporary builders as Barton and Hancock, who seem to have been

influenced by the earlier English virginal building traditions, the Tabel has thick case sides and a long scaling suitable for iron stringing. The bridges, although not tapered in thickness as much as in Ruckers instruments have the usual Ruckers cross-section. Unfortunately the interior is inaccessible and cannot be examined, so the internal framing and soundboard barring cannot be compared with Ruckers normal practice. However, from the fact that the soundboard barring of the later builders Shudi and Kirkman who learned their craft from Tabel is in the style of Ruckers, it seems likely that the Tabel soundboard is also similarly barred. The disposition with 2 x 8', 1 x 4', a dogleg coupler and a lute stop is typically English and like other earlier and contemporary English harpsichords. However, although the English influence is also apparent in such details as the veneered case, the turned stand and the brass hinges, the influence of the Flemish tradition as mentioned above is very strong indeed.

In 1718 Burkat Shudi came from the canton of Glarus in Switzerland to settle in London, and there he began to work with Tabel, and to learn harpsichord construction from him. Shudi became Tabel's foreman, and then sometime before 1729, set up on his own independently of Tabel, and began making his own instruments. In 1761 John Broadwood of Cockburnspath in Scotland came to work in Shudi's shop, and after marrying Shudi's daughter Barbara in 1769 he was taken into partnership with Shudi's son

Burkat the Younger. In 1782 Broadwood took over direction of the firm, in 1795 he took his son into partnership with him, and thus began the firm of John Broadwood and Sons. This firm, still in business today making pianos, can thus trace its origins right back to the Couchets and Ruckers, and to the roots of the Flemish clavecimbel tradition.

Shortly after Shudi left Tabel's workshop, Jacob Kirkman, immigrant from Alsace, came to work with Tabel, and also eventually became his foreman. After Tabel's death in 1738, Kirkman married Tabel's widow, and took over the workshop under his own name. Kirkman carried on building harpsichords, and like the Shudi/Broadwood firm began building pianos in the early part of the 19th century. As a piano building firm they also carried on business until recently, and only ceased productions some 20-odd years ago.

Kirkman was a prolific builder of harpsichords. Today three times as many instruments survive by Kirkman as those of Shudi. Assuming the survival rate of instruments by Kirkman and Shudi is the same (about 40%) then Kirkman must have built about 4000 instruments, averaging about 80 instruments per year in the 1780's. This rate of production, consisting almost entirely of harpsichords, is twice the annual rate of each of the Ruckers workshops whose output consisted of both harpsichords and the smaller, less time-consuming virginals. Thus a vast number of harpsichords were built in 18th century England in the

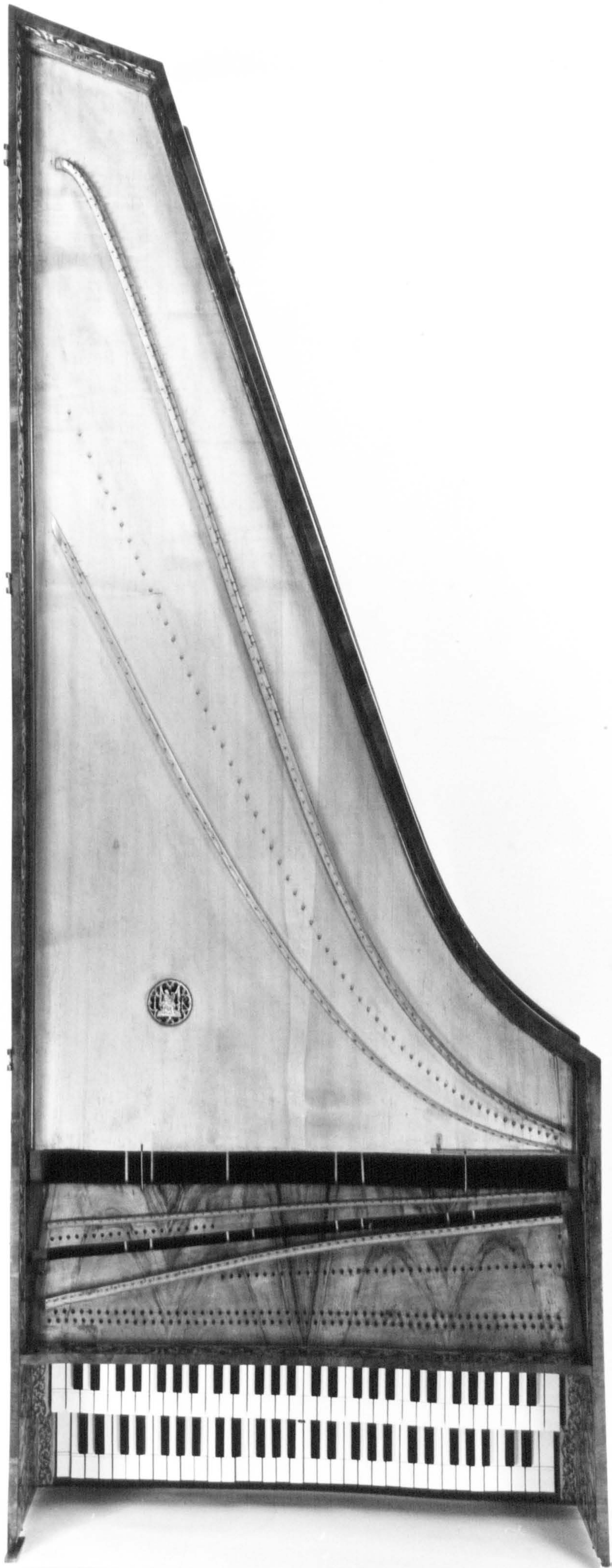

Photo 10-2 Plan view of the 1755 Jacob Kirkman harpsichord, in the Russell Collection, Edinburgh. The soundboard layout and barring, the bridge cross-sections and the scalings all owe much to the principles also used by the Ruckers.

Scale 1:10

Ruckers style, even if one considers only the Shudi and Kirkman workshops. But Hitchcock, Mahoon, Willbrook, Craig, etc. were also all building instruments in the Ruckers tradition in the same period in which Kirkman and Shudi/Broadwood were working.

The Ruckers style of construction influenced harpsichord building in England in two ways. A large number of instruments actually built by the Ruckers survived into the 18th century and among their owners were, Handel, Queen Charlotte and numerous members of the aristocracy. Because of the beauty of their sound, these instruments were used as models for their own instruments by the English builders. But also, as explained above, there was a direct master/apprentice succession involving the two most important English builders, Shudi and Kirkman, which went right back to the origins of the Flemish tradition.

The Ruckers tradition in 18th century France

The appreciation of the Ruckers style of instrument building seems to have developed rather differently in France from that just described for England. So far as is known there was no master-apprentice relationship between any of the French 18th century builders and the Ruckers family. The French harpsichord makers seemed to have absorbed the Ruckers style of building directly from the Flemish instruments which were imported into France. Much of the activity of 18th century French makers went into the re-building, or ravalement, of the old Flemish

instruments, and also into the faking or counterfeiting of instruments. Such activity could not have taken place without the French builders having totally understood the Ruckers style of building before incorporating it into their own instruments. This style is the dominant influence in the construction practice of virtually all of the 18th century French builders.

Because of the lack of extant instruments to study, not a great deal is known about 17th century French harpsichord building, and of course even less is known about the previous centuries. However the few 17th century French harpsichords that survive by Desriusseaux, Thibault, Vaudry, etc. show a number of features in common. The cases are often made partly of walnut, or walnut is used inside the instrument to line the keywell and ornament the keyboards. The case sides, bridge sections and framing are usually lighter than those found in Flemish (and later French) harpsichords, and the general impression one gets from these instruments is that they are lighter and more delicate than their Flemish counterparts. The roses were usually of pierced and layered parchment instead of being cast and gilded lead. The scalings are usually much shorter - 300 to 330 mm instead of about 355 mm - than those found in contemporary Flemish instruments. But probably more important even than the change in tone caused by the use of shorter scalings, these French harpsichords had soundboards with barring which passed underneath the bridges, in-

stead of having the soundboard area near the bridges completely free and using the barring to control only the areas of vibrating soundboard as is the standard practice in the Flemish instruments. Virtually all the surviving French 17th century harpsichords are double-manual instruments and date from the second half of the century. The French instruments had aligned keyboards, a disposition with 2 x 8' and 1 x 4' and the compass was usually G_1/B_1 to c^3 . The keyboards had black ebony naturals and (usually solid) white ivory or bone sharps and the ends of the natural key levers were cut away underneath to give an arcade of three connected arches. The stands of these instruments are very characteristic and usually have six to eight (usually spiral) turned legs connected together with a stretcher just above floor level.

However, although French instruments from the first half of the 17th century are very scarce, it should be remembered that the Ruckers were apparently building instruments during this period especially for the French market. All the large double-manual Ruckers harpsichords (see p. 514) originally with chromatic basses down to F and G_1 are now in France and seem to have been since earliest times. This almost certainly means that these instruments were made especially for export to France where the larger compass down to G_1 must have been needed. The building of these instruments - 1616 HR, 1627c IR, 1628b IR and 1646b AR - covers most of the first half of the century and this suggests that, as in other

parts of Northern Europe, the use of harpsichords with keyboards at different pitches was known in France and that, as in England, the use of a chromatic base octave was a requirement of the music. (What the musical necessity for a chromatic bass octave during this period was is not known, since I know of no original French music now extant that required this.) Also importation of these instruments over such a long period suggests that they were continually appreciated in France and that, at least in the first half of the 17th century, the limited 1 x 8', 1 x 4' disposition that the Flemish instruments had was sufficient for the music being played.

The four large 'French' doubles now extant are doubtless only a small fraction of the total number of such instruments imported into France in the first half of the 17th century. It seems likely also from the number of instruments now extant there, that the smaller normal doubles were also imported into France, along with single-manual harpsichords and virginals. As a result of the number of their instruments in France, and especially in Paris, the Ruckers gained a reputation there for having built some of the finest sounding harpsichords. Apparently these instruments were appreciated even more than the native harpsichords since by the close of the 17th century, such builders as Richard, Nicolas Blanchet and Dumont were building instruments which conformed very closely to the style of instruments

made by the Ruckers. The instruments had heavier moulded cases of lime (a wood which is very similar to the poplar used by the Ruckers), and the roses (often copying Ruckers roses but with the initials changed) were of cast and gilded lead. The scalings were similar to those used by Ruckers and the soundboard barring system copied the Flemish model very closely.

By the beginning of the 18th century the Flemish style of building seems to have become predominant and firmly established, and I know of no harpsichords in the style of the Thibault/Desruisseaux/Vaudry instruments built after 1700. And for the rest of the 18th century builders such as François Étienne Blanchet, Goujon, Goermans, Stehlin, Hensch, Taskin, Vater, Dedebar, etc., all built instruments very much in the Ruckers tradition. They were of course longer instruments with a wider compass, aligned keyboards, and a more versatile disposition, but the structure, framing, scalings and soundboard construction, layout and barring were all clearly modelled on that found in the Ruckers instruments.

But the effect of the Ruckers tradition was felt also through the influence of the Ruckers instruments that were being heard 'in the flesh' as a result of the efforts of many builders who re-worked the old Flemish instruments, enlarging them, aligning the keyboards, adding extra strings and generally bringing them up to date. The 1778 Geneva edition of the Encyclopédie (see Appendix 13) says:



Photo 10-3 Plan view of the 1764 Jean Goermans harpsichord in the Russell Collection, Edinburgh. This harpsichord was re-worked by Pascal Taskin in 1783/84. Because of its basic similarity in sound and construction to a Ruckers/Couchet harpsichord, Taskin was able to alter the IG Goermans rose to IC (Ioannes Couchet), stain the soundboard to make it look old, and resell it as a genuine Couchet ravalé by Taskin!

Scale 1:10

"The best harpsichords that have been made up to now for the beauty of their tone are those of the three Ruckers (Hans, Ioannes and Andreas) as well as those of Ioannes Couchet, who, all working in Antwerp in the previous century, made an immense quantity of harpsichords, of which a very large number of originals are found in Paris, and recognized as such by the true connoisseurs."

Much of the activity of the French (especially Parisian) builders seems to have been directed towards the ravalement of old Flemish instruments. Of the extant oeuvres of such builders as Blanchet, Goujon, and Taskin, by far the largest number are re-worked instruments, and not instruments begun and built entirely by the makers themselves. As one would expect this high proportion of re-worked instruments among a builder's output must also have existed in the 18th century. In an inventory dated 1780 of the instruments of Louis XVI at Versailles¹⁰⁻⁵), 23 harpsichords are listed. Of these, two are by Blanchet, but a total of 8 are listed as having 'claviers de Blanchet'. And of these ravalé harpsichords 7 are Ruckers instruments.

The many inventories of 18th century Parisian harpsichord builders¹⁰⁻⁶) all list Ruckers and Flemish instruments among the other effects found in the Paris workshops. Among these we find 'Deux petit clavecins Ruckers pour prendre la table', 'Trois clavecins vieux pour mettre en pièce', '1 clavecin de Ruckers avec ses claviers', etc. Flemish instruments 'a grand ravalement' (ie. with 5 octaves F_1 to f^3) are common among the other instruments listed. But it is among the inventories where the prices of the instruments are listed that one gets a true idea of how the

Ruckers were valued by the French. As an example, the inventory dated March 2, 1737 of the effects of the deceased harpsichord builder Jacques (I) Bourdet (see footnote 10-6, Samoyault-Verlet (1966), p. 135) lists a number of harpsichords by French builders mostly of the 17th century valued at up to 80 livres, but averaging about 60. Then we find 'un clavecin . . . a ravalement de Jean Ruckers' with a price of 450 livres, or roughly 9 times the price of the locally made French instruments.

By the eighteenth century, the decoration of the Ruckers instruments was completely out of date. Even in the 17th century, the marbled exterior and papered interiors seemed rather provincial and old-fashioned. When the cases of the old Flemish harpsichords were widened, the original decoration was of course destroyed. So the instruments were re-decorated in the style current at the time of the re-building. In the simplest form the new decoration would consist of a lacquered lid and case decoration ornamented with bands of gold leaf, and a stand either with cabriole legs in the style of Louis XV, or later with turned and fluted legs in the style of Louis XVI. But the more elaborately decorated instruments had paintings inside the lids by one of the fashionable contemporary artist and had more elaborately carved, inlaid or gilt stands and outer case decoration. Unfortunately most of these more elaborately decorated instruments were lost at the time of the French Revolution. But we can get some idea of what they would have been like from their descriptions in the contemporary

sale notices (see Appendix 15). Unfortunately no extant Ruckers harpsichords have paintings attributable to Watteau or Oudry, or stands with Boule decoration. However, the 1646b AR double-manual harpsichord has a beautiful outer case decoration in verniss martin, that is, with delicately painted motifs on a background of gold leaf.

The lists of instruments for sale in Paris (see Appendix 15) usually give asking prices. In the period between about 1750 and 1780 the average price for a double-manual harpsichord made by a Parisian builder was about 300 to 400 livres. A Ruckers or Couchet double, on the other hand, was listed usually either for 600 or 1,000 livres. But prices as high as 2,000 to 5,000 livres were asked, and in 1778 a harpsichord listed without details simply as a 'Clavecin d'André Ruckers' asked 1,000 louis, or 20,000 livres! Naturally when a harpsichord with a Ruckers name-board and rose could fetch 30 times or more the price of a new instrument many builders were unable to resist the temptation to counterfeit Ruckers instrument, and to fake old Flemish or old French harpsichords to appear to be the genuine Ruckers article.

To what extent this practice was a legitimate part of the activity of these French builders, and to what extent their clients realized that the instruments they were buying were not genuine, is not known. Perhaps some clients were knowingly deceived, others not. Although some instruments, such as the 1788 Taskin instrument in Milan signed 'ANDREAS RVCKERS', and the '1590 Hans Ruckers' by Jean

Goujon (made sometime before 1749), are particularly clever imitations of Ruckers instruments, and seem to have been made purposefully to deceive, the practice of counterfeiting instruments seems to have been an accepted part of the occupation of a harpsichord builder. Inventories of the property of many builders which were made during their active career - as opposed to after their death when exposing any disreputable activity could not have damaged their future prospects - include entries such as:

'Un clavecin fait par Goujon ayant pour titre Hans Ruckers'

'1 clavecin portant le nom Ruckers, fabriqué par le feu Paschal Taskin, . . .'

However, the fact remains that most of these contrefait instruments were accepted until recently as genuine. Also the obvious financial benefits of producing fake and forged instruments and selling them as authentic would not encourage builders to tell their customers that their newly acquired instruments were not genuine Ruckers or Couchets. Probably the 18th century public buying instruments was deceived to the same extent as many modern collectors and museums have been. Even in the 18th century the public was deceived into thinking that it was hearing the authentic Ruckers sound. The fact that such a deception was possible shows the extent to which the Ruckers style of building was understood and appreciated by the 18th century harpsichord builders. It was so well absorbed and under their control that their contrefait instruments were indistinguishable from a genuine Ruckers harpsichord mis à grand ravalement.

The effect of the Ruckers tradition in the rest of Northern Europe.

The Ruckers style of building seems to have made no impact at all on the Italian harpsichord builders of the 18th century. I know of no Italian instruments made in the Flemish style. In Northern Europe the influence of the Ruckers tradition was very strong in France and England, but although the Ruckers style did touch upon the harpsichord making traditions outside of these countries, it is useless to try to find a comparable effect on harpsichord building elsewhere in Europe.

In central Europe, because of the lack of harpsichords from the 17th century, it is impossible to trace the influence of the Ruckers tradition there, if indeed it existed. In the 18th century, harpsichord building in the German speaking part of Europe was centred mainly around Hamburg in the North and Dresden in Saxony in the East. The instruments of the Hamburg school, typified by builders like Hass, Fleischer and Zell, are not unlike those of the Ruckers, but do have characteristics all of their own. The harpsichord tails, instead of being mitred, are rounded so that the bentside has an elongated 'S' shape. The bridges are usually tall and narrow and have an almost rectangular cross-section. The scalings of the Hamburg instruments are very similar to those used in France and England during this period, and from what little evidence exists, the use of brass and iron, and the actual gauges of the strings, were also similar to those of the English and French 18th



Photo 10-4 Plan view of the 1764 J.A. Hass harpsichord in the Russell Collection, Edinburgh. Although the tail is curved instead of being mitred, the scalings, soundboard layout and barring, and the bridge sectional area are all very similar to those used by the Ruckers.

Scale 1:10

century builders. But most importantly of all the soundboard barring with the 4' hitchpin rail separating the 8' and 4' bridges, and a cutoff bar running almost parallel to the 4' bridge, are very similar in concept to that used in the Ruckers tradition. Also, although the bridges have a different cross-sectional shape, their stiffness and rigidity are roughly the same as in the Ruckers tradition. Thus even with the characteristics that differentiate the Hamburg school from the other Ruckers-derived traditions, the sound of the instruments of the two disciplines have more features in common than they have differences.

In Saxony the influence of the Ruckers style was much stronger. The 18th century instruments built in and around Dresden were built in a manner clearly based on the Ruckers tradition. The cases were heavily constructed with the sides sitting on the baseboard. The tails were mitred and not rounded as in the Hamburg instruments, so that the general appearance of these instruments is also similar to their contemporary Ruckers-derived French and English counterparts. Their scalings are similar and the soundboards are similarly barred and ribbed. Only the shape of the bridges is distinctly different from that of the Ruckers tradition. The instruments of Gräbner and Horn have bridges which, except for a recess cut for the bridge pins and a sloping top behind this, are almost square in cross-section. The bridges in instruments by Hartmann and Johan Heinrich Silbermann (the latter, although working in Strassbourg, learned his craft from his uncle Gottfried in Freiberg in

Saxony) are similar to Gräbner and Horn except that they are slightly wider at the base than at the top of the bridge.

Not surprisingly, the Ruckers tradition was strongly felt in Flanders itself in the 18th century. But unlike France and England, and even Germany, harpsichord building was carried on on a very modest scale in Flanders in the 18th century. We have only a few surviving Flemish instruments from this period by Bull, van den Elsche and Heine-mann. However, Dulcken, working first in Antwerp and then in Brussels, and Delin working in Tournai seem to have been more prolific, or at least their instruments are more prone to survival. As with their contemporary English and French colleagues, the 18th century Flemish builders made harpsichords in the style of the Ruckers and Couchets, but with a wider compass, and a greater musical potential as a result of the addition of an extra set of 8' strings and sometimes extra registers such as the closeplucking lute stop, the soft leather-quilled peau de buffle stop, etc.

The instruments of Delin particularly resemble those of Ruckers. The soundboard layout and barring, the bridge cross-sections, the scalings - in fact all of the important features of his instruments - are similar to the Ruckers. Delin even used an Andreas Ruckers rose, modifying the initials from AR to AD. Delin also used jacks with blind damper holes - clearly modelled on the jacks found in the earlier Ruckers and Couchet instruments.

The instruments of Dulcken, although they have more

individual characteristic features than those of Delin are also built closely in the style of Ruckers and Couchet. Although the soundboard barring and layout, and the bridge cross-sections are in the 17th century Flemish style, the scalings are very long: 370-385 mm, and therefore longer even than the contemporary low-pitched French instruments. The cases of Dulcken's instruments are also longer than those of his contemporary English and French colleagues who seemed to base their instruments on the two-manual harpsichords of the Ruckers. It seems clear, as mentioned earlier, that Dulcken's instruments are based on the long single-manual harpsichords built by Ioseph Ioannes Couchet.

Footnotes

- 10-1) E.M. Ripin, 'The Two-Manual Harpsichord in Flanders before 1650', The Galpin Society Journal, 21 (1968) 33-39.
- 10-2) The decoration, soundboard construction marks, 3-octave span of the keyboards and strings, the materials and the mouldings are all different from those used by the Ruckers and the rest of the Couchet family.
- 10-3) J. Lambrechts-Douillez, 'Aperçu historique sur la facture de clavecin à Anvers aux XVI^e et XVII^e siècles', La facture de clavecin du XV^e au XVIII^e siècle, (1980) 59-66.
- 10-4) James S. Broadwood, Some notes made by J.S. Broadwood in 1838, with observations by H.P. Broadwood, 1862, (1862).
- W. Dale, Tschudi. The Harpischord Maker, (1913) (reprint Boston 1978) 21.
- C.M. Mould, 'The Tabe| Harpsi chord', Keyboard Instruments, (Ed. E.M. Ripin) (1971) 57.



Photo 10-5 Plan view of the 1668 Stephen Keene spinett virginal in the Russell Collection, Edinburgh. Because virginals were never as popular after 1650 as they had been during Ruckers time, the influence of the Ruckers virginal building tradition is difficult to establish. Nonetheless, the similarity of this instrument to the typical Ruckers spinett virginal (see Photo 3-19) is very strong.

Scale 1:10

- 10-5) S. Marcuse, 'The Instruments of the King's Library at Versailles', The Galpin Society Journal, 14 (1961) 34-36.
- 10-6) C. Samoyault-Verlet, Les facteurs de clavecins parisiens. Notes biographiques et documents (1550 - 1793), (1966).
- F. Hubbard, Appendix C p. 256.
- P.J. Hardouin, 'Harpsichord Making in Paris: Eighteenth Century', Galpin Society Journal, 10 (1957) 10; 12 (1959) 73; 13 (1960) 52.

Chapter 11 - The ravalement of Ruckers and Couchet instruments

In order to adapt the instruments of the Ruckers and Couchets to play music of the 18th century they had to be altered. In 18th century France a harpsichord with a compass greater than 4 octaves C to c³ was said to be en ravalement, so that any Ruckers or Couchet instrument which had been widened beyond this compass had been mis en ravalement. Modern authors (e.g. Russell, Hubbard, Boalch, Ripin, Chambure) have called the process of alteration ravalement, and have distinguished two types of alteration or re-working of the old Flemish instruments. When only the keyboard compass was widened by using narrower keyblocks or a narrower 3-octave span, or both, the process is called petit ravalement. If the case sides were moved out to widen the whole instrument the process was called grand ravalement.¹¹⁻¹⁾ .

The methods used to achieve these ravalements are almost as numerous as the instruments themselves and not all of them can be dealt with here individually. But the general process, the problems raised during this process and some of the solutions are important and are dealt with below.

1. Ravalement of virginals

Usually when one speaks of ravalement it is in connection with harpsichords. But virginals were also altered to up-date them and make them more fashionable

and suitable for the later musical literature. Virginals are inherently single-register instruments so obviously only their compass can be widened. The use of the short-octave declined as composers began to write in more remote keys which required the use of the chromatic bass notes for accompaniment. Therefore the most obvious alteration to a virginal was to extend the compass down to C chromatically by adding four notes in the bass (or down to C without C[#] adding three notes). This did not require lengthening the instrument itself since the bottom note was still the same, and thus lengthening the strings was also unnecessary. Usually extending the bass to play chromatically down to C was accompanied by an extension of the treble compass up to e³ or f³.

The extension of the virginal compass could be carried out in one of three ways. In the first and most common method the extra keys and notes were added at the ends of keyboards, registers and bridges leaving the original spacing of keys, jackslots and strings in the middle. This meant moving the keywell braces out to accommodate the extra width of the added keys, and piercing extra jackslots at the ends of the registers. This was relatively easy to accomplish but posed problems for the strings and bridges of the notes at the extremes of the compass. In the bass, the strings added to the extra sections of bridge were positioned closer to the player and touched the back of the removeable nameboard at its right-hand end. A channel was therefore cut in

it and the treble keywell brace so that the bass strings could vibrate freely. In the treble, the added pieces of bridge were so long that they ran onto the area of soundboard above the spine liner. Since the ends of the bridges were therefore not free to vibrate, the added treble notes produced a very bad tone.

The next alternative, which was much more work to carry out, avoided these problems but created a new problem of its own. Here the three-octave span of the keyboard was reduced so that a new keyboard and new registers had to be made. Usually this was done by removing the leather of the upper guide from the soundboard and slicing out the portion of the soundboard with the jack-slots cut into it. A new piece of soundboard wood was inserted into the hole created and this was covered with a new piece of leather. The new jackslots were cut into this and a completely new lower guide, in such a way that the spacing of the slots matched the new keyboard 3-octave span. Because of the re-spacing of the jacks, the bridges had to be re-pinned. But because the geometry of the bridges was based on the original 3-octave span of 500 mm, the scalings were thus altered and, quite aside from any raising or lowering of the pitch which resulted, the scalings were no longer Pythagorean in the treble. In those instruments modified by this method but having only a bass extension to the compass, both keywell braces were usually moved outward to accommodate the wider keyboard. This means that the keyboard

was effectively moved towards the treble, resulting in shorter scalings and giving the instrument a higher pitch as well. But because the new scalings were no longer Pythagorean, comparing the scalings in different parts of the compass does not lead to a consistent pitch comparison before and after the alteration. However, the resulting shortening of the scalings usually corresponds to at least a tone rise in pitch at some point of the compass and even more at other points.

The final alternative for widening the compass of a virginal attempts to avoid both the alteration to the pitch and the non-Pythagorean scalings. Here the keyboard and registers are re-made as above, and in addition new bridges are made and positioned so that their new geometry gives scalings that are both Pythagorean and roughly the same as originally so that the pitch is unaltered. This inevitably means that the new bridges are located in positions different from the original. But since the original soundboard barring and the placement of structural members under the soundboard was designed for the original location of the bridges, re-locating the bridges inevitably compromises the tone of the instrument in its altered form.

Numerous variations of the above three methods of ravalement are to be found. Bass compass extensions to B_1 ($G_1/B_1?$) and treble extensions to d^3 , e^3 , f^3 or g^3 are possible variants. Sometimes the keyboard is moved a semitone or a tone in either direction to centralize

it in the new space in the widened keywell. A few mother and child instruments have also been ravalé. If the bass keywell brace of a muselar mother virginal is moved to the left, the original space for the child will become too small. This means that in the ravalement of a double virginal either the mother's keywell must not be widened or the child is left permanently in its playing position above the mother (e.g. 1610 HR). The problem of not being able to put the child back into the mother after the ravalement of the mother doubtless explains the separation of many mother and child instruments.

2. Ravalement of Ruckers harpsichords

Because of the enormous reputation that Ruckers harpsichords acquired in the period after they were built, few escaped without having had either their compass or disposition altered in some way. To an 18th century musician a Ruckers harpsichord in its original state with a bass short-octave and a disposition of only 1 x 8', 1 x 4', was totally outmoded and very restricting. So there was a strong temptation and a very real reason for both musicians and harpsichord builders alike to modernize these instruments. It is thus little wonder then that only the 1637 AR, the 1679 IC singles, and the 1638b IR double harpsichord have survived with their original disposition and compass, and without having had these modified at some time (the 1618 AR and 1627 AR single harpsichords and the 1637b IR double are now in their original state, but only after earlier

modifications having been removed). The unmodified instruments are extremely valuable in our search for an understanding of Ruckers building practices and the musical potential of the instruments as they were originally built. Because they are so extremely rare and highly important they must be the focus of attention for conservation without further alteration or deterioration.

a) Petit ravalement of single-manual harpsichords

The person altering a single-manual harpsichord to modernise it could change any or all of the compass, disposition or the number of manuals. No single-manual harpsichord now exists in which only the disposition was changed without altering the compass. But an analysis of the string-band strips made for a number of single-manual harpsichords shows that the first alteration that took place in many instruments was to replace the 4' stop by an 8' stop without altering the compass. This was done by placing the new added 8' string directly above the position of the original 4' string. Either a new set of jacks was made to pluck the added string or, more likely, the original 4' jacks were lengthened so that the plectra reached up to the height of the new 8' strings. Because the added 8' string was positioned to the left of the pair of jacks used for any particular note, the new string was longer than the original 8' string by an amount corresponding to an increase in the scaling of almost a semitone. This is a problem that will be encountered throughout this discussion of the ravalement of harpsichords.

Van Blankenburg (1739) recognised this problem (see Appendix 10) and its consequences. He says that, because Ruckers designed their instruments with scalings as long as possible to give strings with tensions just below the breaking point, increasing the scalings by this amount would result inevitably in string breakages. Because of the fundamental nature of this problem to the ravalement of all harpsichords I have decided to call it the van Blankenburg problem (see Fig. 11-3 on page 613).

One way to avoid the problem is suggested by van Blankenburg himself. This is to move the keyboard up toward the treble by one semitone. This possibility has the effect of decentralising the keyboard in the keywell. Another possibility is to move the 8' nut in the treble so that the 8' scalings are decreased by the required amount. This avoids the problem of string breakages, but changes the plucking points and therefore the tone colour in the treble.

No matter how the alteration to give the 2 x 8' disposition was carried out, it was very common. The fact that many instruments of the late 17th century and early 18th century were made with this disposition in Flanders (Hagaerts), France (Bellot, Blanchet) and England (Hasard, Hancock), indicates that it was an extremely popular disposition and therefore an entirely appropriate choice for a harpsichordist playing music of this period.

Just as few single-manual harpsichords survive with an alteration to their disposition without an alteration

to their compass so there are few singles with an alteration to their compass but with the original disposition. Only one instrument, the harpsichord part of the n.d. IR combined harpsichord and virginal, has its original 1 x 8', 1 x 4' disposition, but with a compass widened to C to c³ from C/E to c³.

The petit ravalement of single-manual harpsichords, involving a change in both the compass and disposition is relatively common in extant instruments. In its simplest form the alteration consisted of increasing the dimension of the keyboards by the width of two naturals and altering the disposition to 2 x 8', 1 x 4'. The (c1605) AR, 1635 AR and the 1644a AR singles were altered in this way. But usually the transformation was slightly more complicated, involving the widening of the keyboard and giving the instrument the disposition 2 x 8', 1 x 4' by adding a third register to the gap. In carrying out these alterations several problems had to be overcome.

To increase the compass from C/E to c³ to C to c³ (or C, D to c³) two extra naturals were required and 4 (or 3) notes had to be added. If the original keyboard was used and the spacing of the keytails, jacks and strings maintained, then the keyblocks had to be narrowed and the bridges and registers extended to carry the extra notes. Since the keyboard was widened only in the bass, but the space gained for the wider keyboard came from both the bass and treble sides, the keyboard had to be moved towards the treble relative to its original pos-

ition. If two notes were added to either end of the bridges and registers then the movement of the keyboard resulted in a shortening of the effective scalings by two semitones. Adding an extra set of 8' strings lengthened the scalings by a semitone so that the new scalings were roughly one semitone shorter than originally as a result of the two operations, and the 4' scalings were two semitones shorter than originally. These shorter scalings would have a somewhat detrimental effect on the tone of the instrument, but at least string breakages would occur less frequently, and any deleterious effect on the tone was more than compensated for by the advantage of the increased compass and updated disposition.

Most petit-ravalement singles have neither their original keyboards with a bass enlargement nor their original string spacing. Instead the keyblocks have been thinned to enlarge the space between them, new keyboards and registers with a smaller 3-octave span have been made, and the bridges have been re-pinned to match. This means that an extra natural can be squeezed in the treble increasing the compass to C to d^3 . Reducing the string spacing destroys the geometry of the instrument's scalings, and gives string lengths which do not double with each octave drop in pitch in the treble. However adding the extra notes $c^{\#3}$ and d^3 in the treble effectively moves the keyboard to the left and enforces longer scalings than when the top note was c^3 as above. This lengthening of the scalings is more than the semitone

needed to return the ravelment scalings to their original value even when the bridges are extended as far as possible toward the treble. Normally the result gave string lengths which were so long that string breakages were unavoidable. The solution to the problem of string breakages was to move the nut toward the bridges. In fact normally it is necessary to move only the 8' nut: the 4' scalings are not affected by adding a second 8' choir, and as mentioned above the 4' scalings are about a semitone shorter (at 4' pitch) than the new added long 8' choir. Therefore string breakages are a problem only for the long added 8' choir, and not the short 8' choir or the 4'.

The 1639 IR single was originally one of the large 'English' chromatic bass octave single-manual harpsichords with an original compass of C to d^3 . This was enlarged by the method above, to a 55 note compass which was probably G_1 , A_1 to d^3 (as the keyboards are now lost there is no way of knowing the 18th century compass for certain). Here the keyblocks were thinned, new registers and keyboards were made with a 3-octave span of only 455 mm, and the bridges were extended and re-pinned. Space for a third register in the gap to give a 2 x 8', 1 x 4' disposition was gained by cutting away both the wrestplank and upper belly rail. Although the altered instrument did not have the full resources of an 18th century English harpsichord it was capable of playing most of the literature at least in the early and middle part of the century, and this was achieved with a relatively small amount of

work installing a new action, and with no alteration at all to the case work.

b) Grand ravalement of single-manual harpsichords

The problem of crowding a large number of notes into the small case of the single-manual harpsichords was easily solved by widening the case of the instrument. Normally this was done by adding material only on the treble side of the case leaving the spine side unaltered.

Here again the ravalement procedure can be carried out either by using the original keyboard and keys or by re-making these and the registers with a narrower 3-octave span. The 1627a IR harpsichord has had its compass widened from C/E to c^3 to C to e^3 simply by adding the additional keys to those already existing on the keyboard, and increasing the width of the case by about 90 mm on the treble side. Adding the notes to the bass side of the keyboard has the effect of pushing the keyboard up toward the treble, so that the original keys play strings with lengths much shorter than originally. Adding an extra set of strings to the 8' choir effectively lengthens the scalings of the 8' strings. But even allowing for this the new scalings correspond to string lengths a minor third shorter for the 8' strings and a major third shorter for the 4' strings. For some reason the soundboard has been replaced in this instrument, and a new soundboard with only an 8' bridge has been installed. But advantage was not taken of altering the position of the new bridge to give scalings closer to the originals, and the present scaling of the long 8'

c^2 is 305 mm, a minor third shorter than Ruckers normal scalings.

Most grand ravalements of single-manual harpsichords avoid the problem of shortening the scalings by re-making the keyboard with a smaller octave span. For the normal C/E to c^3 singles the new compass is usually C to f^3 . Adding the extra notes in the bass pushes the keyboard toward the treble but, by using a shorter 3-octave span and reducing the width of the bass keyblock, the treble keys are located nearer the bass side of the instrument. The combination of these two plus moving the nuts away from the gap was used to give string lengths which, although they were no longer accurately Pythagorean, were at least closer to the original Ruckers scalings. Most important of all these new scalings gave strings tensioned close to their breaking point. Instruments ravalé in this way are the 1609 AR, 1618 AR and the 1645 IC.

The grand ravalement of the 1637a IR single which had an original compass of C to c^3 chromatic offered a bit more scope than the narrow C/E to c^3 instruments just discussed above. Here the bass compass could be extended below C and the treble extended above c^3 . By narrowing the 3-octave span and the bass keyblock, and by making the lowest natural touchplate narrower than the rest of the touchplates, the bass compass was extended down to A_1 , and by widening the case extended up to f^3 in the treble. The extension of the bass compass downwards gives rise to a new problem not encountered in

those instruments where the bass short-octave compass was replaced by a chromatic bass octave, but where the lowest played note, namely C, was the same in both cases. Here, extending the compass down to A_1 gives bass string lengths which are intended for C but now sound A_1 a minor third lower. Ideally they should therefore be 20% longer than they are. To help to compensate for the shortness of the strings the nut was moved as close to the tuning pins as possible in the bass. This then altered the plucking point and gave strings which were more centre-plucking in the bass. The resulting loss of clarity in the bass is noticeable, and a serious disadvantage. The bass extension of these short instruments compromises the sound of the lowest notes, and there is no solution to the inherent problem of strings which are too short for the notes they are expected to play.

c) Conversion of single-manual harpsichords to double-manual harpsichords

The conversion of a single-manual harpsichord into a double involves a considerable amount of work. New keyboards, jacks and registers have to be made and the case sides and baseboard have to be lengthened to accommodate the second keyboard. The nameboard has to be narrowed to allow the second keyboard to slide under it, and the lid front flap has to be widened and lengthened. In comparison to all this, only a relatively small amount of extra work was involved in moving the treble cheek piece outwards to extend the compass above the original c^3 .

Not surprisingly therefore most of the single-to-double conversions are of the grand ravalement type with a treble and sometimes a bass compass extension achieved by moving the case sides.

Exceptions to this are the few large Couchet singles which, because of their initial wide compass, were converted to doubles without widening the case, and are therefore of the petit ravalement type. Examples are: the (c1650)b IC where the compass was F_1, G_1, A_1 to c^3 altered to F_1, G to c^3 , the 1652 IC with compass of G_1/B_1 to c^3 where only the bottom E^b key was split to give B^b/E^b , and the n.d. IC where the F_1 to d^3, e^3 compass was increased by first decreasing the 3-octave span of the keyboards and re-pinning the bridges to F_1 to e^3 , and then later F_1 to f^3 . In the case of the first two of these instruments ((c1650)b IC and 1652 IC) even the original pinning and string spacing were used. And in all three cases the new disposition was 2 x 8', 1 x 4'.

The single-to-double conversion of the small C/E to c^3 singles were all grand ravalements. By decreasing the 3-octave span of the keys and by moving the treble case-side outwards the compass was extended in both the treble and bass. Since the bass scalings could not be increased it is rather surprising that the bass compass was extended downwards as far as G_1 , either chromatically, by missing out $G^{\#}_1$ (G_1, A_1), or by using a G_1/B_1 short octave. Examples of the conversion of C/E to c^3 singles are: 1639b AR (G_1 to d^3), 1651b AR (G_1, A_1 to f^3) and 1654 AR (G/B_1

to f^3). The spine of the 1651b AR has been moved outwards and new soundboard wood added on the bass side, but the bass scalings have not been much increased and are still almost 20% shorter than those of the normal Ruckers double which sounds the same note (G_1). The other two instruments have even shorter scalings in the bass, with even graver consequences to the sound of the lowest notes.

Two examples, both unique, exist of large singles converted into doubles. The 1636 AR originally had a compass of C to c^3 . It was converted to a double by widening the case in the treble and replacing the original wrestplank with a new longer and wider one. The nameboard and wrestplank were repositioned closer to the player on the spine side, and the spine lengthened accordingly. Because the original bass scalings seem to have been somewhat longer than the earlier singles (see also 1651a AR), the use of a wide repositioned wrestplank, relatively wide registers and the positioning of the bass portion of the nut near the new nameboard position gave bass scalings which are relatively long, even for the new bottom note of F_1 (which was still shorter than the Ruckers doubles going down only to G_1).

The second large single-to-double conversion was made to the 1680 IC which probably had an original compass of F_1 to d^3 . This instrument was widened only on the bass side. The original spine was cut off at the belly-rail and cut down to the level of the soundboard. A new full height spine was glued to the side of the old

spine thus widening the instrument by an amount equal to the width of the original spine. The new compass was F_1 to f^3 which, with only two extra naturals, was easily fitted into the new space by using a smaller keyboard octave span. However the new scalings are very non-Pythagorean, and the extreme treble scalings, intended for the note d^3 but now sounding f^3 are extremely long and must have required the use of a very hard-drawn wire.

In the discussion above, the ravalement of single-manual harpsichords was carried out leaving the soundboard, and usually the bridges, intact. New soundboard wood (or at least non-original soundboard wood from old instruments) was added to the treble or bass side or both. However, it was also the practice to use the wood from an old Ruckers soundboard and to re-splice it with additions to form a new soundboard. Completely new bridges and soundboard barring were added to the composite soundboard in the usual style of the builder carrying out the work. Although unconventional, this practice was quite common: in fact it was more common than it would otherwise appear from this discussion since there are a number of Flemish (but non-Ruckers) and early French instruments whose soundboards have been used in this way to make false 'Ruckers' instruments, and which do not otherwise appear in this discussion (e.g. '1590 HR', '1612 HR', '1615 HR', 'n.d. IR', etc.).

The soundboard of the 1632 IR is basically a single-manual Ruckers soundboard with added sections on the

spine , tail and treble side attached to it to make it into a double-manual soundboard. The rose has been re-positioned to locate it in a more normal position and the old rose hole has been carefully filled in with new wood. The wreath has been re-painted very much in the style of the original. The added sections of soundboard wood were painted with flowers and arabesques in the style of those already on the original part of the soundboard. The resulting instrument has long bass scalings and all of the design features necessary for good sound production.

The soundboard of the 1671/73 IC was re-spliced in an even more complicated fashion. Here the original wood which is normally inactive and located between the cutoff bar and the spine was replaced with new wood. As far as possible this original wood was re-used in the acoustically active part of the new composite soundboard under the bass section of the new 4' and 8' bridges. Inevitably, small sections near the spine had to be filled in with new wood, and new wood was added in the treble. Here also the original rose-hole was carefully filled in and the majority of the original soundboard decoration (consisting only of bronze powder scallops and arabesques with no flower or bird painting) was obliterated. Thus, beginning with what appears to have been a small C to c single, a brilliant new F_1 to f^3 double was made. The new bridges, extended in the bass to give long scalings there, sit almost entirely on old original soundboard wood.

The soundboard of the 1621 AR has also been re-

spliced to convert it from a single-to a double-manual harpsichord. The section of the soundboard which was originally on the bass side of the instrument and which contained the rose was jointed to two new pieces of wood, and was also lengthened with new wood. New wood was also added to the treble side of the soundboard. The original soundboard painting was retained and new flower groups were added to the new wood in a style similar to later Andreas instruments. Only about a half of the new composite soundboard is original Andreas Ruckers soundboard wood since a very large area of wood especially in the bass had to be added to accommodate the downward extension of the compass to F_1 .

Instruments altered in the manner of the last three harpsichords, the 1632 IR, the 1621 AR and the 1671/73 IC, doubtless sounded very good when the ravalement was completed. The scalings, plucking points, and soundboard barring and layout were typical of the best instruments produced before, during and after the time in which these alterations were made. However, it is clear that the altered instruments, especially those in which the soundboard consists of pieces patched together from elsewhere on the original board, did not have a thickness contour similar to that of the original instrument or of a comparable Ruckers double-manual instrument. The stiffness of the soundboard with bridges located on it in positions different from that intended by the original maker, produced a sound which was also different from that ex-

pected by the original builders. Such instruments must therefore be considered to have a sound ideal characteristic not of 17th century Flanders but of their 18th century re-builders.

d) Alignment of double-manual harpsichords

As has been mentioned elsewhere, no Ruckers double-manual harpsichords seem to have been made with aligned keyboards (see Chapter 8, p. 514). Because the fashion or musical taste for double-manual instruments with unaligned keyboards declined around 1650, the first and simplest alteration which could be made to a double was to align the keyboards without altering the number of string choirs or the jacks or registers. The pitch which survived into the latter half of the 17th century and the 18th century was the so called Corista pitch at R. For the normal transposer this meant that the upper manual at this pitch was left basically unaltered except that the wooden block in the bass and the short-octave cranked keys were removed. New keys were made to fill the space left by these and the result extended the compass down to G_1/B_1 . The alteration to the lower manual keys was slightly more complicated. Within the original compass C/E to f^3 of the lower manual there is already a sufficient number of keys to yield the aligned compass G_1/B_1 to c^3 of the upper manual; it is necessary only to alter their order. The simplest method of doing this was to move the keys of the notes for c^3 to e^3 down to the bass to become the notes C to E and to shift all the remaining keys up toward the treble. The bottom key became G_1/B_1 and the top key became c^3 and

these were left unaltered:

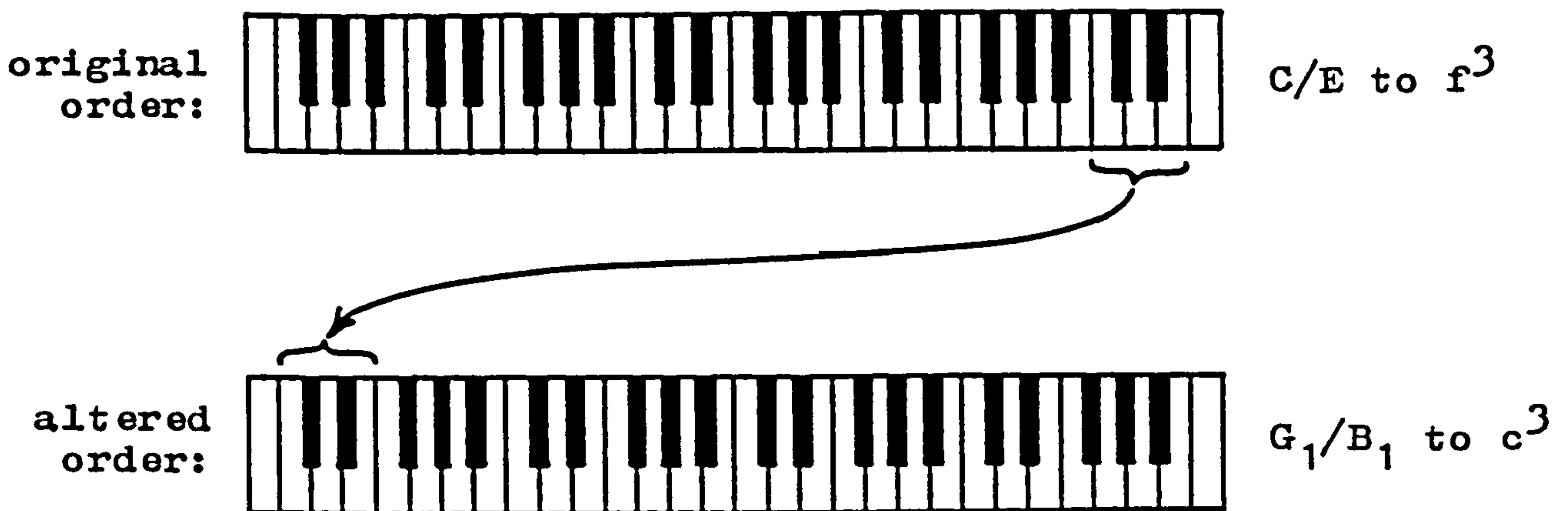

Fig. 11-1 Alignment of the Ruckers lower manual - method 1.

But it was also possible to move each note \underline{b}^b up to become new $\underline{f}^\#$ so that the intervening natural \underline{b} and \underline{c} became \underline{e} and \underline{f} :

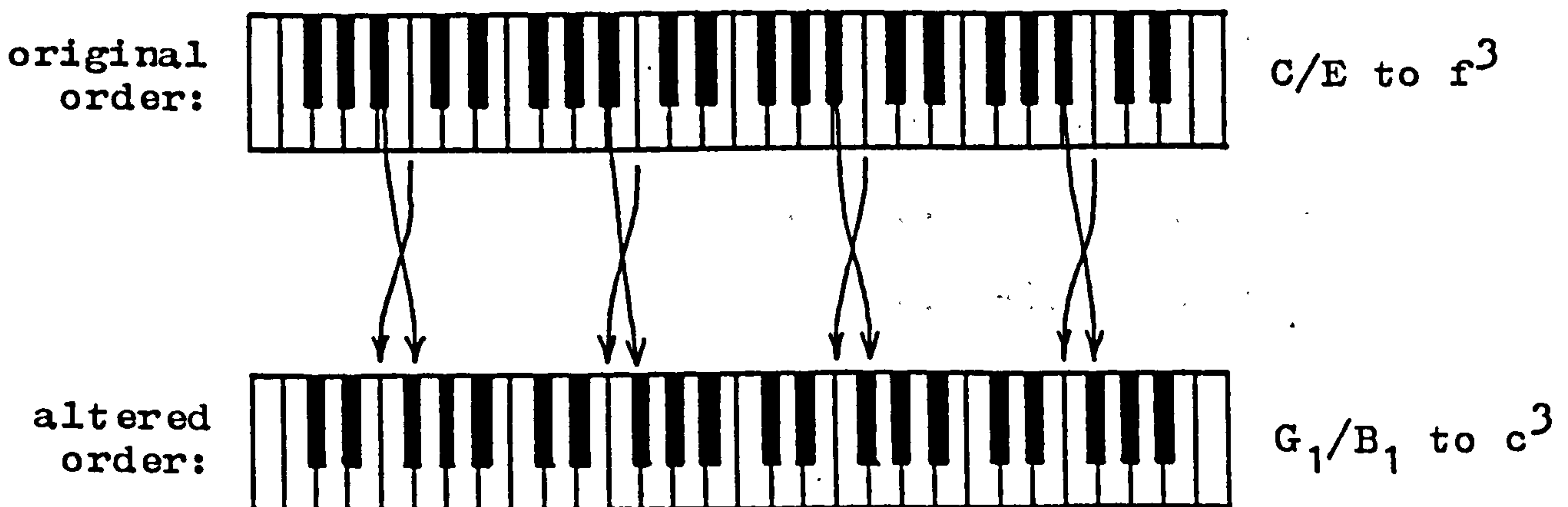

Fig. 11-2 Alignment of the Ruckers lower manual - method 2.

Whichever method was used a problem arose in that the lower-manual balance rail is slightly angled, being closer to the player in the bass than in the treble. This meant that

the holes for the balance pins for the altered keys had to be re-drilled either in the keys or the balance rail. Normal Ruckers double-manual harpsichords which were aligned without adding an extra set of 8' strings are the 1615 AR and the 1640b AR (the 1633b AR was converted into a single-manual harpsichord using its original lower manual with its C/E to f^3 compass at a pitch R - 4).

The problem of the alignment of the larger 'French' Ruckers doubles (see p. 515) is similar to that already described, except that the pitch role of the manuals is interchanged. The lower manual with its G_1 to c^3 compass at a pitch R can be left entirely unaltered. The upper manual with a block in the bass followed by the F to f^3 compass, has to be aligned with the lower manual. Again the simplest method of doing this is to move the notes c^3 to e^3 down to the bass to become C to E and then to shift the F to b^2 keys up to the treble. New keys for G_1 to B_1 have then to be made to fill out the space left by the removal of the wooden block. The 1616 HR was altered in this way (at some time the top c^3 key was moved to the bass to become an F_1 to give the extraneous F_1 to a^2, b^2 compass (see Russell 1959/1973 plate 36)).

As a next step to the simple alignment of the keyboards, a number of Ruckers doubles also had an extra set of 8' strings added, thus altering the disposition from the original 1 x 8', 1 x 4' to 2 x 8', 1 x 4'. The addition of the second set of 8' strings can be represented schematically - see Fig. 11-3.

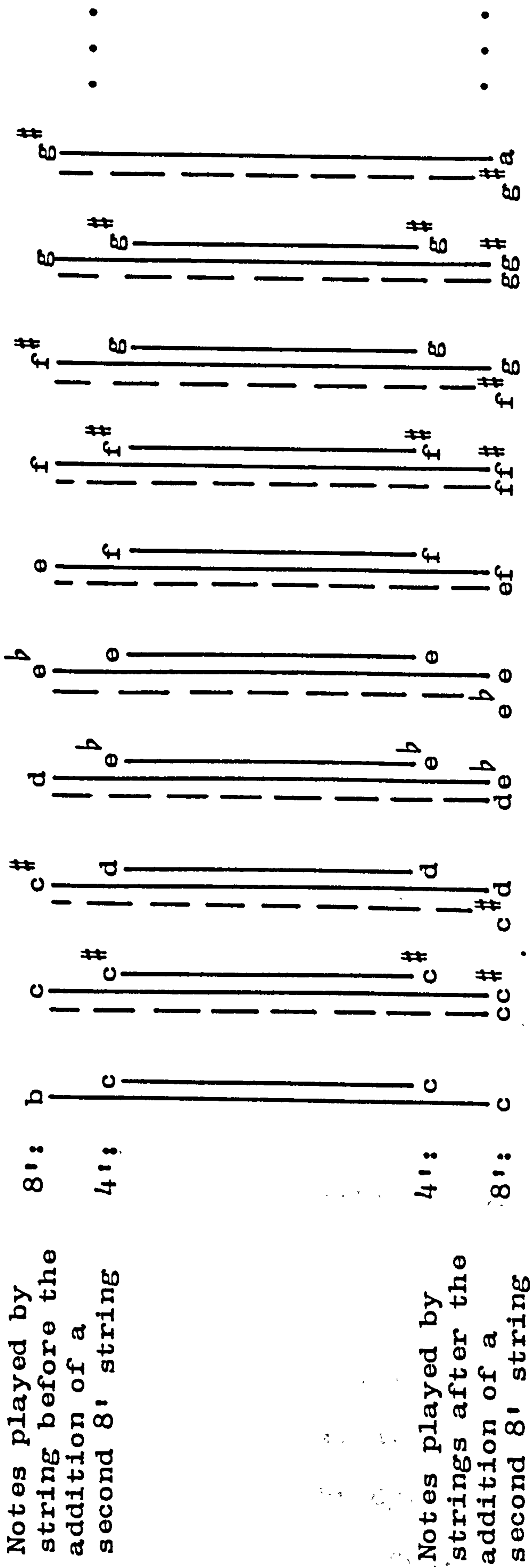

Fig. 11-3 The van Blankenburg problem. After the addition of the second 8' string, the original 8' string must play a note at a pitch a semitone higher. The pitch of the 4' strings remains unchanged.

Here the added strings are represented by a dashed line, the 4' strings by a short solid line and the original 8' strings by a long solid line. It can be seen clearly that the original string is now plucked by the jack for the note one semitone higher than originally. This means that the effective scalings are increased by an amount equivalent to one full semitone, with all of the implications this has on string breakages, strength of the wire used, and problems of pitch. It is the van Blankenburg problem.

Strangely, a number of instruments with aligned keyboards, a G_1/B_1 to c^3 compass and an added set of 8' strings, but no other alterations, seem to have ignored the van Blankenburg problem. The scalings of the long 8' strings are simply a semitone too long (e.g. 1637b IR and 1640b IR). Whether this means that stronger wire was used to string these instruments so that they could be tuned to the same pitch, or whether they were tuned a semitone flat to their previous pitch now seems impossible to discover.

But there are instruments in which it is clear that whoever altered them was aware of the van Blankenburg problem and took measures to avoid it. Sometimes the measures taken were very drastic. Fleischer, in aligning the 1618c IR double, replaced the soundboard and bridges with entirely new bridges and a soundboard which gave the instrument a long 8' scaling of about 340 mm (4' scaling = $2 \times 160 \text{ mm} = 320 \text{ mm}$). Although this is about a

semitone shorter than Hass (1723), Fleischer's Hamburg contemporary, with a scaling of 366 mm, it compares with Gräbner (1739) at 339 mm and Horn (c1780) at 349 mm. A less drastic and very ingenious method of overcoming the van Blankenburg problem was adopted by the person who aligned the 1627b IR double. The compass was left at G_1/B_1 to c^3 although new keyboards were made. The bass notes, which actually benefit by having an increased scaling, were left with the jacks plucking strings with a scaling longer than in the original design. But a space was left in both the key tails and the string band between the notes d and e^b , so that all the keys from e^b to c^3 are cranked one semitone toward the treble. This shortens the tenor and treble scalings by one semitone reducing the 8' scalings to their original values. As mentioned earlier van Blankenburg (see Appendix 10) suggests a similar solution when all of the keys are moved one semitone toward the treble and an extra A_1 is added in the bass to fill up the space left by shifting up the keyboard. But the solution adopted by the rebuilder of the 1627b IR double is superior to van Blankenburg's since the foreshortening of the bass strings is reduced and the treble 8' scalings are left unaltered.

The alignment of the 1608 AR double was done in a rather unusual way. Here the compass was changed from G_1/B_1 to c^3 to C to d^3 for both manuals. Because the new compass has one more note an extra key was made for $c^{\#3}$ and an extra set of strings added in the treble. Here

the 8' scalings are increased by two semitones - one semitone from moving the keyboard toward the bass, and one semitone by adding an extra string. The 4' scalings are increased by one semitone. The scalings were reduced somewhat by moving the treble ends of both the 8' and 4' nuts towards the gap. But the amount the nuts can be moved is limited: the 4' nut is already very near the gap and the space between the 8' and 4' nut is partly filled with the 4' tuning pins. The result is that the treble scalings are still left relatively long. The 8' c^2 scaling is 379 mm and the 4' c^2 scaling is $2 \times 178 = 356$ mm, compared with the original scalings of about 351 mm and $2 \times 175 = 350$ mm respectively. The 1618c IR double, although it was aligned and given a compass of G_1/B_1 to c^3 by Fleischer in 1724, was also later altered to a C to d^3 compass and its scalings are also now relatively long (8' $c^2 = 382$ mm and the 4' c^2 is $180 \times 2 = 360$ mm).

e) Petit ravalement of Ruckers double-manual harpsichords

Although the lowest key of a normal Ruckers double-manual harpsichord in its original state sounded a string whose pitch was G_1 , musically the key being played was a C. Aligning the keyboards therefore effectively extended the compass musically down a fourth to G_1 and enabled musicians to play notes below C. Although the top note c^3 was all that was required in Flanders until about 1650, by the time that harpsichords were being aligned in the second half of the 17th century, the need for two-pitch harpsichords had been replaced by a need for instruments

with a larger treble compass as well. Initially at least, the most common requirement was the treble d^3 and a number of instruments exist with d^3 as the top note.

Several of the instruments with a petit ravalement use the original spacing of the strings and keys. Adding the extra natural width to the keyboard requires more space and this was achieved by thinning the keyblocks on one or both sides of the keywell. Adding notes to the treble part of the keyboard exacerbates the van Blankenburg problem. This is because the extra notes added in the treble force the keyboard to be moved towards the bass, further lengthening the scalings instead of shortening them. The usual solution is to move the nuts toward the gap to reduce the scalings, and to gain as much space from the keywell on the treble side as possible so that moving the keyboard as a whole towards the bass is avoided. Examples of petit ravalement instruments altered to give a G_1/B_1 to d^3 compass are the 1612b HR, 1618b IR and the 1642b IR doubles.

By re-spacing the strings and making a new keyboard with a smaller octave span, two effects can be achieved. Firstly by narrowing the treble keyblock, space for the extra d^3 can be made. The smaller octave span of the keys and stringband moves the position of the strings towards the treble and shortens their effective scalings. Obviously the amount the scalings are shortened is greater for the bass strings than for the treble strings: Fortunately the small strings used for the treble notes would



Photo 11-1 The 1642b IR double-manual harpsichord. This is a good example of an aligned double₃ with a petit ravalement compass of G_1/B_1 to d^3 , and a fine later outer decoration and stand.

be more work hardened, and therefore stronger, and could withstand the long scalings in the extreme treble without breaking. The second effect of reducing the octave span of the strings and keys is that more notes can be added in the bass, in addition to the extra $c^{\#3}$ and d^3 added in the treble. The 1624 IR was altered in this way to give a compass of G_1, A_1 to d^3 and the 1628 AR to give A_1 to d^3 .

Clearly the large 'French' double could also be given a petit ravalement to increase the treble compass to d^3 . The 1628bIR large double was given a G_1 to d^3 compass by making new keyboards for it with a smaller octave span, but the spacing of the strings was left unaltered. To achieve this the keys splay out in the treble to reach the new added notes which were added only on the treble side. The scalings were thus increased by only one semitone as a result of adding an extra choir of 8' strings. No attempt was made to shorten the scalings by moving the nuts, probably because the instrument, obviously altered in France judging from the style of the keyboards, registers and decoration, was ideally suited to play at the low French chamber pitch without problems of string breakages.

Not so far mentioned in this discussion of the alignment and petit ravalement of Ruckers double-manual harpsichords is the question of the coupling of the two manuals. In their original state the two manuals of a Ruckers harpsichord, intended to play at different pitches

and not for contrast in volume and tone colour as on later harpsichords, operated completely independently of one another. In a few instruments (e.g. 1612b HR, 1616 HR, 1615 AR and 1640b AR) the manuals were left uncoupled after alignment and ravalement and the disposition left unaltered from the original 1 x 8', 1 x 4'. With a single 8' and 4' on each manual and no coupling the only effect of having two manuals was the slight contrast in tone colour resulting from the different plucking point of the two rows of jacks plucking the same string. Because of the problem of damper interference the two manuals could not be played simultaneously with the tone colour of one manual contrasted against the other. Either one manual or the other could be played, and, as with the instrument in its original state with unaligned keyboards, the jacks of one manual had to be pulled off before the other manual could be played. Since in the 'off' position the dampers had to leave the strings completely, the dampers must have been cut with an obliquely angled (rather than horizontal) edge touching the string. Nonetheless the fact that at least four instruments survive without the possibility of coupling the manuals means that, to many musicians and harpsichord builders, rapid tonal and volume contrast between manuals was not very important.

In those aligned/petit ravalement instruments where manual coupling is a feature, it is most easily achieved by using a dogleg row of jacks. If the ends of the upper-

manual keys are shortened slightly then they can operate on the 2nd row of jacks with doglegs cut in them in the usual way. Sometimes the register for the 4th row of jacks is blanked off (e.g. 1618b IR) but often this register is used as well as the other three rows to give typical dispositions like:

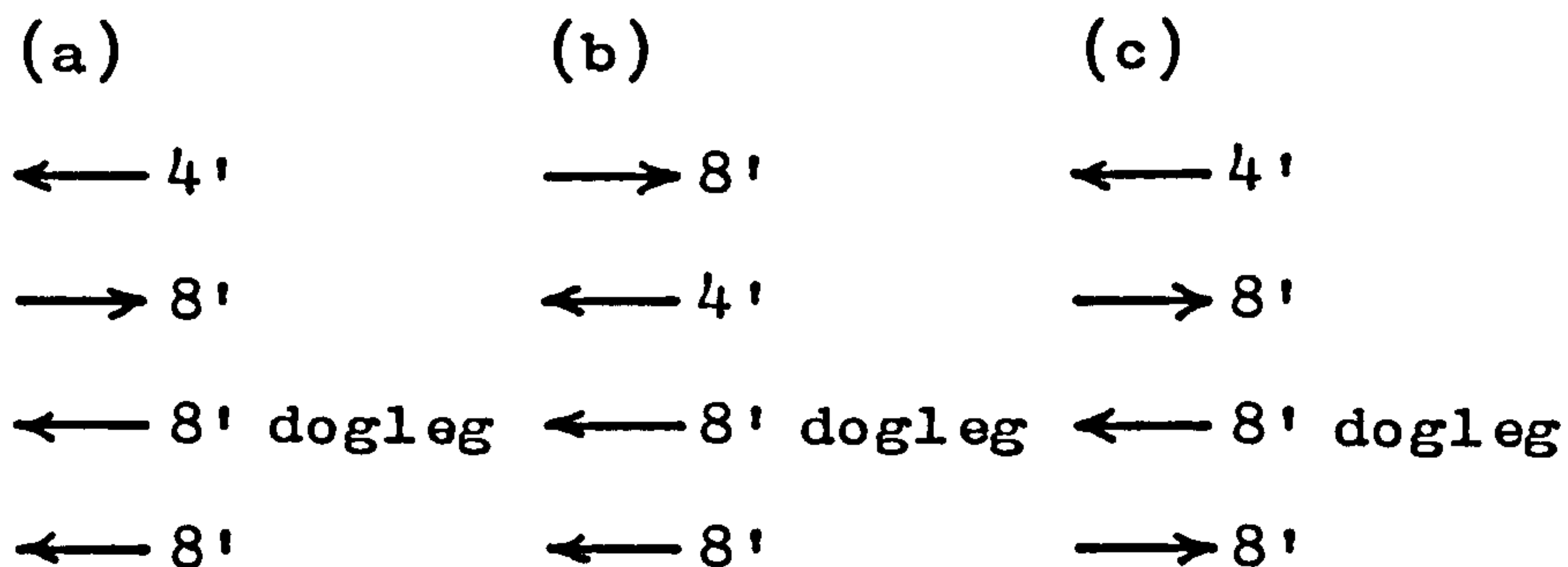

Disposition (a) leaves the original two rear rows of jacks plucking in the same direction as in the original Ruckers state, but disposition (b) provides more contrast between the lower manual 8' and the upper manual 8'. However in both (a) and (b) a single 8' on one manual can be dialogued against a single 8' on the other manual to play pièce croisée and any or all of the registers available on the lower manual can be contrasted with the single 8' dogleg. This gives a very versatile disposition although it requires an extra row of jacks compared with the French manual shove-coupler discussed below, which offers much the same versatility. Not so versatile is disposition (c) - either with the two rear registers as indicated or in the position shown in (b). Many instruments ravalé in Flanders have this disposition however, as do many Flemish instruments which were newly built in the 18th century. Here a dialogue between a single 8' on both manuals is impossible -

i.e. it is impossible to play pièce croisée. However it is possible to play two 8's on the upper manual, a possibility not found in any other North European instruments.

In France the usual solution to the problem of coupling was to abandon the fourth register completely; either by making wide registers to fill up the space in the gap, or simply by inserting a strip of wood into the gap to fill the space left vacant. Such instruments use a typical French shove coupler. Dogs on the lower manual keys reach up and activate the ends of the upper manual key-levers when the upper keyboard is in its rear position. This is the method found also on French grand ravalement single harpsichords, and naturally in doubles newly made in the 18th century.

f) Grand ravalement of Ruckers double-manual harpsichords

As the musical need for a larger compass and a greater flexibility of disposition grew during the 18th century, so the desire increased to enlarge the old Ruckers instruments to a state which matched the contemporary harpsichords then being built. Because a double-manual harpsichord à grand ravalement, that is to say, with 5 octaves from F_1 to f^3 , with a manual coupler, and perhaps even a peau de buffle register and genouillère, best satisfied this desire, there are a relatively large number of Ruckers and Couchet instruments which have been subjected to this process.

The enlargement of the case of a Flemish instrument on both the spine and cheek side was a major undertaking,

and this probably accounts for the fact that most instruments were widened only on the treble side. For the normal size of transposer, two different compasses are found in those instruments in which the original key spacing and string spacing was retained. In the first of these only the treble part of the compass is increased. The widening of the case and soundboard in the treble, and the extension of the compass are all carried out leaving the keyboard in its original position in the instrument. Such instruments (e.g. 1620c AR, 1646 IC) have a G_1/B_1 to f^3 compass and are therefore simply aligned instruments extended in the treble. Two instruments of the second type (1599 HR and 1624 AR - the latter now a single) have adopted a unique and unusual method of grand ravalement. Here the original keyboard is extended down to F_1 by adding new extra keys below the original B_1 , and up to f^3 as well. The case and soundboard are widened on the treble side by an amount sufficient to accommodate the new keyboard which is now wider by the width of 6 Ruckers naturals with additions in both the treble and bass. The altered keyboard was inserted into the instrument with the bottom F_1 key in the position of the original B_1 key. In this position the original keys are shifted towards the treble so that they play strings sounding at a pitch an augmented fourth - F_1 to B_1 - higher than originally. Adding the second 8' string lengthens the string by a further semitone so that this, in conjunction with the shortening caused by shifting the keyboard gives scalings suited to a pitch a per-

fect fourth higher than the original scaling. Since the average Ruckers harpsichord scalings are about 356 mm, this gives new scalings of $356 \times 3/4 = 267$ mm. By way of comparison the c^2 scalings of the 1599 HR harpsichord are now 270 mm, and that of the 1624 AR double are 261 mm. It seems unlikely however that these instruments were strung in iron and tuned a fourth higher than R. It is possible that they may have been strung in brass - which requires shorter scalings than iron - and tuned to a pitch R or slightly higher.

Rather than using the original Ruckers octave span as above, re-spacing the strings and making new keyboards with a narrower octave span gave the person carrying out the ravalement more flexibility in his approach. If a narrower octave span was used and the keys as a whole shifted towards the treble then extra bass notes could be added and the van Blankenburg problem avoided simultaneously. Instruments altered in this way are the 1612a HR (G_1, A_1 to f^3) the 1617 IR (G_1 to f^3) and the 1614 AR (A_1 to e^3) doubles. Obviously the shorter the scalings are made, the further the keyboard can be shifted toward the treble, and the more notes can be added in the bass. Sometimes as on the 1623 AR a new wrestplank was made which was wider than the original but which still left enough room for 3 registers in the gap. This enabled the nuts to be positioned closer to the bridge. The resulting shorter scalings enabled the keyboard to be shifted far enough toward the treble to allow the bass compass to be extended

down to F_1 to give F_1 , G_1 to f^3 .

Because of their larger original bass compass the big 'French' doubles were relatively easy to alter to give the grand ravalement 5-octave compass of F_1 to f^3 . By re-pinning the bridges, making new keyboards with a smaller octave span to match the new string spacing, and by extending the case by less than 50 mm it was possible to alter the 1646b AR double to give a full F_1 to f^3 compass. Since the instrument originally went down to G_1 , the extension down to F_1 was easily accomplished by using a keyboard with a smaller octave span. The van Blankenburg problem was solved partly by inserting the extra bass notes so as to push the keyboard towards the treble to shorten the scalings, and partly by moving the new nuts towards the gap.

By way of contrast to the simple, efficient way in which the 1646 AR 'French' double was altered by reducing the spacing of the strings, the grand ravalement of the 1627c IR 'French' double, although carefully carried out is clumsy in conception. Here the original string spacing and bridge and nut pinning is maintained. The extension of the compass down to F_1 and up to f^3 was accomplished by widening the case on both sides. On the bass side the original spine was cut down to the level of the soundboard liner and a new spine was positioned a few millimetres from the original. A new strip of soundboard wood was jointed to the original wood and runs over the original cut-down spine to the new spine liner. The extensions to the bass end of the bridges, which were add-

ed to take the extra bass strings, run over the original spine and spine liner. To try to free the bass end of the bridges to enable them to vibrate, a saw cut was made through the original spine and liner a few millimetres below the soundboard level for both the 4' and 8' bridges. This must have helped to allow the soundboard area and bridges to vibrate somewhat, but the ends of the bridges are still much stiffer than if the soundboard had been left completely free. On the treble side the original cheek has also been left in position behind the keywell with a new cheek positioned beside it. But unlike the spine, the original cheek has been cut down to a level below the soundboard. This enables the extension to the 4' hitchpin rail to run unhindered to the new cheek liner, and also the new extensions to the soundboard and bridges are left completely free to vibrate.

The ravalement of the 1627c IR harpsichord in which both the treble and bass sides were enlarged was considerably more work than the ravalement of the 1646 AR harpsichord. The advantage of the method of ravalement of the 1627c IR instrument is that, because the original pinning of the bridges and nuts was not altered, the spacing of the strings was not changed and therefore the scalings remained Pythagorean in the treble. In the 1646 AR instrument, and of course all others in which the string spacing is altered, the string lengths in the treble do not accurately halve with each octave rise in pitch. To some extent this can be compensated for by repositioning the

nuts, but in fact the slight inaccuracies in the scalings in those instruments with reduced octave spans does not seem to have a noticeably detrimental effect on the sound. Therefore the advantage of maintaining the Ruckers spacing of the strings, especially when the bass sound is compromised by the bridges running over the original spine and spine liner as in the 1627a IR instrument, is minimal. Unfortunately we will probably never know whether the harpsichord builders of the 18th century who altered these instruments considered the advantages and disadvantages of one type of ravalement over another, and whether or not there was a general consensus about the importance of accurately Pythagorean scalings, new versus old soundboard wood and the stiffness of the soundboard and bridges.

Just as some single-manual harpsichords were reworked by re-splicing their soundboards and incorporating these with a new case, so this process of ravalement occurred for double-manual instruments. Whereas three instruments survive which were converted from single-manual instruments into large doubles by re-splicing the soundboard, there is only one extant example of this process having been carried out for doubles. The reason for this is fairly obvious. The double-manual Ruckers harpsichords were already fairly large instruments which were designed to sound the note G_1 in the bass. The bass strings were therefore already sufficiently long to sound G_1 and the extension to F_1 could be carried out with little compromise so far as length is concerned, although in the nor-

mal doubles finding the extra space to add the naturals from G_1/B_1 down to F_1 was a problem. In the large 'French' doubles which went down to G_1 chromatically there was little problem or compromise either in string length or space constraints involved in extending the compass down to F_1 . For both the normal and the 'French' doubles the treble had to be extended by moving the cheek out to achieve the grand ravalement compass of f^3 . A builder not willing to make any compromises at all in the ravalement of a Ruckers double is faced with one alternative: the soundboard must be re-spliced and the case both widened and lengthened.

The ravalement of the 1612 IR double in the Paris Conservatoire is an example of such an uncompromising ravalement process. Here the length of the spine was increased by almost 200 mm and the width of the tail by about 40 mm. The inside width of the instrument was increased from about 760 mm to 878 mm to allow ample room for the grand ravalement F_1 to f^3 compass with enough space at both the bass and the treble ends of the bridges to allow the free vibration of the soundboard there. About 75 mm of new wood was added in the middle of the soundboard, and 45 mm along the bass side. New bridges were made as well as new barring and a new 4' hitchpin rail under the soundboard.

The new design is extremely good and a great credit to the (anonymous) builder. The string scalings are accurately Pythagorean in the treble and double in length right down to c^1 in both the 8' and 4' (see catalogue entry for 1612 IR). The lengths of the bass strings are very

long and exceed those of other French builders such as Goermans, Taskin and Blanchet by 50 to 150 mm. The ingenuity and subtleness of the new design is reflected in the exceptionally fine sound of the instrument.

FOOTNOTES

- 11-1) In 18th century France an instrument à grand ravale-
ment meant that it was an instrument with a 5-octave
compass from F_1 to f^5 .

Condensed Catalogue of Authentic Ruckers Instruments

Hans Ruckers

1581 HR Double mus. virg. Met. Museum, N.Y.
 1583 HR 4-voet spin. virg. F. Meyer, Paris
 1591a HR Polyg. 6-v. sp. vg. Gruuthuuse, Bruges
 (1591)b HR Double mus. virg. Yale Univ.
 1594 HR Sing. harps. & virg. Schl. Köpenick

Ioannes Ruckers

1595 HR Child virginal Cincinnati Mus.
 1598 HR 6-voet spin. virg. Paris Conserv.
 1599 HR Double harpsichord Händelhaus
 (c1600) HR Double spin. virg. Milan
 1604 HR 5-voet mus. virg. Brussels Museum
 1610 HR Double mus. virg. Brussels Museum
 1611 HR 6-voet mus. virg. Vleeshuis
 1612a HR Double harpsichord Fenton House
 1612b HR Double harpsichord Amiens
 (1614) HR 6-voet mus. virg. Brussels Museum
 1616 HR Large double harps. Nirouet, Paris

 n.d. IR Sing. harps. & virg. Berlin
 (1612) IR Double harpsichord Paris Conserv.
 1617 IR Double harpsichord R. Johnson, L.A.
 1618a IR Child virginal Paris Conserv.
 1618b IR Double harpsichord Schl. Cappenberg
 1618c IR Double harpsichord Lund, Sweden
 1619 IR Doub. harps. & virg. Brussels Museum
 1620 IR 6-voet mus. virg. Boston
 1622 IR 6-voet mus. virg. Met. Museum, N.Y.
 1623 IR Double mus. virg. Stuttgart
 1624 IR Double harpsichord Colmar, France
 1627a IR Single harpsichord Berlin
 1627b IR Double harpsichord Villebon
 1627c IR Large double harps. Private, Switzer.
 1628a IR Mother mus. virg. Brussels Museum
 1628b IR Large double harps. Versailles
 1629 IR 4½-voet spin. virg. Brussels Museum
 1632 IR Double harpsichord Neuchatel
 1636 IR 6-voet mus. virg. Harvard
 1637a IR Single harpsichord Edinburgh
 1637b IR Double harpsichord Rome
 1638a IR 6-voet mus. virg. Brussels Museum
 1638b IR Double harpsichord Edinburgh
 1639 IR Single harpsichord V. & A., London
 1640a IR 5-voet mus. virg. Gemeentemuseum
 1640b IR Double harpsichord Münster
 1642a IR 5-voet mus. virg. Stockholm
 1642b IR Double harpsichord H. Gough, N.Y.

Ioannes Couchet

1645 IC Single harpsichord Edinburgh
 1646 IC Double harpsichord Brussels Museum
 1650a IC 6-voet mus. virg. Vleeshuis
 (c1650)b IC Double harpsichord Met. Museum, N.Y.
 1652 IC Double harpsichord Private, France

Andreas Ruckers

(1605) AR Single harpsichord Vleeshuis
 1608 AR Double harpsichord Edinburgh
 1609 AR Single harpsichord P. Williams
 (c1610)a AR 2½-voet virginal Australia
 1610b AR 4½-voet mus. virg. Boston
 1613a AR 4-voet spin. virg. Brussels 2274
 1613b AR 4-voet spin. virg. Brussels 22928
 1613c AR Child virginal Cincinnati Mus.
 1614 AR Double harpsichord Elmhirst, Devon
 1615 AR Double harpsichord Vleeshuis
 1617 AR 6-voet spin. virg. Munich
 1618 AR Single harpsichord Berlin
 1620a AR 4-voet spin. virg. Washington
 1620b AR 6-voet mus. virg. Brussels Museum
 1620c AR Double harpsichord Berlin
 1620d AR 6-voet mus. virg. Labeyrie, Gif
 1621 AR Double harpsichord St. Etienne
 1623 AR Double harpsichord Private, England
 1624 AR Single harpsichord Gruuthuuse, Bruges
 (1626) AR Child virginal Sterckshof, Dourne
 1627 AR Quint single harps. Gemeentemuseum
 1628 AR Double harpsichord Pilkington, Port.
 1632 AR 4-voet spin. virg. Brussels Museum
 1633a AR 6-voet mus. virg. Brussels Museum
 1633b AR Single harpsichord Leipzig
 1634 AR Child virginal Paris Conserv.
 1635 AR Single harpsichord M. Thomas
 1636 AR Double harpsichord M. Thomas
 1637 AR Single harpsichord Nuremberg
 1639a AR Child virginal Gemeentemuseum
 1639b AR Single harpsichord Gemeentemuseum
 1640a AR Single harpsichord Yale Univ.
 1640b AR Double harpsichord Namur, Belgium
 1643a AR 5-voet mus. virg. Gemeentemuseum
 1643b AR Double harpsichord Germann, Boston
 1644a AR Single harpsichord Vleeshuis
 1644b AR Double mus. virg. Leipzig
 1646a AR Single harpsichord Vleeshuis
 1646b AR Large double harps. Paris Conserv.
 1648 AR Single harpsichord Copenhagen
 (1651)a AR Single harpsichord Traquair House
 1651b AR Double harpsichord V. & A., London
 1654 AR Double harpsichord Nuremberg

Joseph Ioannes Couchet

n.d. IC Double harpsichord Stockholm
 1671 IC Double harpsichord K. Gilbert
 1679 IC Single harpsichord Washington
 1680 IC Double harpsichord Boston