

**Germar Rudolf (Ed.)**

# **Dissecting the Holocaust**



**The Growing Critique  
of 'Truth' and 'Memory'**



**2nd, revised  
paperback  
edition**

# DISSECTING THE HOLOCAUST



# Dissecting the Holocaust

The Growing Critique  
of 'Truth' and 'Memory'

Edited  
by  
Germar Rudolf



Theses & Dissertations Press

**HOLOCAUST HANDBOOKS, Vol. 1:**

Gerhard Rudolf (ed.):

*Dissecting the Holocaust: The Growing Critique of 'Truth' and 'Memory'.*

Translated by Victor Diodon

Chicago (Illinois): Theses & Dissertations Press, August 2003

Theses & Dissertations Press is an Imprint of

Castle Hill Publishers, PO Box 243, Uckfield, TN22 9AW

Second, corrected, paperback edition

ISBN 0-9679856-2-5

ISSN 1529-7748

Original German edition:

Gauss, Ernst (*i.e.*, Gerhard Rudolf) (Hg.):

*Grundlagen zur Zeitgeschichte:*

*Ein Handbuch über strittige Fragen des 20. Jahrhunderts.*

Tübingen: Grabert, 1994

Veröffentlichungen des Institutes für deutsche Nachkriegsgeschichte; Bd. 22

ISBN 3-87847-141-6

ISSN 0564-4186

Original German edition: © November 1994 by Grabert-Verlag, Postfach 1629, D-72006 Tübingen

First English edition: © 2000 by Theses & Dissertations Press (ISBN 0-9679856-0-9)

Second English edition: © 2003 by Theses & Dissertations Press, imprint of Castle Hill Publishers

Translated by Victor Diodon

Online:

German: [www.vho.org/D/gzz](http://www.vho.org/D/gzz)

English: [www.vho.org/GB/Books/dth](http://www.vho.org/GB/Books/dth)

All Rights reserved. No part of this book may be reproduced in any manner whatsoever without written permission except in the case of brief quotation in articles and reviews.

# Table of Contents

	Page
Preface.....	7
ROBERT FAURISSON	
The Controversy about the Extermination of the Jews · An Introduction .....	13
GERMAR RUDOLF	
The Case of Walter Lüftl · Contemporary History and the Justice System.....	61
WERNER RADEMACHER	
The Value of Testimony and Confessions Concerning the Holocaust.....	85
MANFRED KÖHLER	
Witnesses to the Gas Chambers of Auschwitz.....	133
ROBERT FAURISSON	
The German Justice System: A Case Study .....	145
CLAUS JORDAN	
Holocaust Victims: A Statistical Analysis .....	181
GERMAR RUDOLF	
The Gas Vans: A Critical Assessment of the Evidence .....	215
INGRID WECKERT	
Do Photographs Prove the NS Extermination of the Jews? .....	243
UDO WALENDY	
Air Photo Evidence .....	269
JOHN CLIVE BALL	
National Socialist Concentration Camps: Legend and Reality .....	283
JÜRGEN GRAF	
Some Details of the Central Construction Office of Auschwitz.....	311
HANS JÜRGEN NOWAK AND WERNER RADEMACHER	
Some Considerations about the ‘Gas Chambers’ of Auschwitz and Birkenau .....	337
GERMAR RUDOLF	
The Crematoria Ovens of Auschwitz and Birkenau.....	373
CARLO MATTOGNO	
The Gas Chambers of Majdanek.....	413
CARLO MATTOGNO	
Diesel Gas Chambers: Ideal for Torture – Absurd for Murder .....	435
FRIEDRICH PAUL BERG	
The Treblinka Holocaust.....	471
ARNULF NEUMAIER	
Babi Yar: Critical Questions and Comments .....	501
HERBERT TIEDEMANN	
Reprisals and Orders From Higher Up.....	529
KARL SIEGERT, WITH COMMENTS BY GERMAR RUDOLF	

Appendix 1: <i>Wood Preservation through Fumigation with Hydrogen Cyanide: Blue Discoloration of Lime- and Cement-Based Interior Plaster</i> .....	557
HELMUT WEBER, WITH COMMENTS BY GERMAR RUDOLF	
Appendix 2: <i>Dissecting the Holocaust: Expert Report</i> .....	563
JOACHIM HOFFMANN	
Appendix 3: <i>Censorship in Germany? Never! Unless...</i> .....	567
ANTON MÄGERLE	
A Brief History of Holocaust Revisionism .....	579
WILLIS A. CARTO	
Bibliography .....	583
Index .....	601

---

*“The Natural sciences [like other scholarly disciplines] are extremely conservative and dogmatic. Any corroboration of a paradigm is welcome, whereas any innovation or revision will long meet with resistance; the instinct for preservation (including self-preservation!) is stronger than the search for truth. Therefore, new findings usually gain acceptance only when sufficient numbers of researchers vouch for them: then the dogmatic status quo topples, a ‘scientific revolution’ occurs, a new paradigm replaces the old [...] The bottom line is that no student, no researcher and no layman should believe any facts to be ‘conclusively proven’, even if the textbooks present them as such [...]”*

Professor Walter Nagl, Ph.D., *Gentechnologie und Grenzen der Biologie*,  
Wissenschaftliche Buchgesellschaft, Darmstadt 1987, pp. 126f.

---

*“The error [of numbers of Auschwitz victims], though committed a long time ago and by others, remains tendentious. And it was ‘our’ error, if ‘our’ refers to the enemies of fascism and racism. [...] I admit that it is sometimes necessary to conceal the truth – i.e., to lie – at times even for noble reasons, for example out of pity or tact. But it is always profitable to know why one does so, and what such deviations from the truth entail [...]”*

*While truth is not always good, lies are much more often evil [...]”*

Ernest Skalski, *Der Spiegel*, no. 30/1990, p. 111

---

*“A democracy requires free citizens who are willing to say publicly unpopular things to provoke critical debate.”*

Robert Reich, *Los Angeles Times*, May 13, 1998, p. B13

---

Throughout this book, double quotation marks (“”) are used for “quotations” (set *always* in italics), single marks (‘’) for otherwise non-emphasized text of ‘so-called’ and ‘so-to-say’ character (except when used for quotations inside quotations). Quotations are introduced *once* with a single “-mark and ended with a ”-mark (to break with the American tradition to introduce every paragraph in a quotation with a “-mark, but never closing it, which, strictly speaking, is an “*unterminated string error*”). Entire sentences or paragraphs of quoted text are rendered in small italic font and left indentation. Any addition to quoted text is rendered non-italic and surrounded by brackets, so are added omission ellipses [...], which could otherwise not be distinguished from ellipses in the original.

Titles of books and journals are set in italics without quotation marks. References have the order: a) books: author(s)/editor(s), *title*, [volume,] [edition,] [publishing house,] town year[, pages]; b) journals: author(s), [“*title of article*”], *name of journal*, volume[(issue)] (year)[, pages] (items in brackets optional).

## Preface\*

ROBERT FAURISSON

Historical revisionism is the great intellectual adventure of the end of the 20<sup>th</sup> century.

Despite its size, the present handbook offers only a glimpse of that adventure; and so it seems necessary here first to specify the precise historical problem upon which the Revisionists have concentrated their research, then how revisionism arose in the 1940s and how it developed in the years 1950 to 1978; and finally how it really took off in the years 1978 to 1979, to experience such an increase in the present day that nothing any longer seems likely to halt its onward march.

In the Nuremberg Trial (1945-46), Germany had been judged and condemned for “*crimes against peace*”, for “*war crimes*” and for “*crimes against humanity*”. The Revisionists have been led in a way by their successive discoveries concerning these three points to call for a revision of the Nuremberg Trial. Regarding the first two points, the Revisionists have been able to present their arguments without too much difficulty, and it is probable that no serious historian today would contend that anyone is in a position to lecture Germany concerning “*crimes against peace*” and “*war crimes*”: as a matter of fact, it has become evident that the Allies bear their share of responsibility in the starting of the war, and that they themselves committed innumerable “*war crimes*” (if that expression has any meaning, given that war itself may be held a crime). On the other hand, concerning the third point, that is with regard to “*crimes against humanity*”, they keep on dinning into our ears that Germany attained a peak of horror all her own with the ‘genocide’ of the Jews. It is on the study of this precise point that the Revisionists have specifically concentrated their efforts. And so, by degrees, historical revisionism has become what the Americans now call ‘Holocaust revisionism’.

According to the accusers, Germany was not content just to persecute the Jews, to deport them and put them into concentration camps or forced labor camps; those ‘crimes’ – as every historian knows – are unfortunately frequent in the history of mankind, and we have only to turn on our TV sets today to note that all kinds of human societies continue to suffer such ‘crimes’. Germany, her accusers still contend, went far beyond that. Taking a giant leap in horror, in 1941-1942 she allegedly decided on the total extermination of the European Jews, and in order to perpetrate this *specific* crime, supposedly devised and utilized a *specific* weapon: the homicidal gas chamber (or gas van). Making use of abominable chemical slaughterhouses, she allegedly began a collective assassination of industrial proportions. That crime (the genocide) and that weapon used in the crime (the homicidal gas chamber) are in that sense inseparable, and it is consequently impossible to maintain, as some do, “*that whether or not there was a gas chamber makes no fundamental difference*”. Germany thus presumably committed an intrinsically evil crime against the Jews. The Jews say further that the whole world *knowingly* allowed the Germans to perpetrate that crime. The paradoxical result of so enormous an accusation is that today in the dock of the accused, ‘criminals’ Hitler, Himmler, and Goering are joined by their ‘accomplices’, Roosevelt, Churchill, Stalin, Pope Pius XII, and the International Committee of the Red Cross, as well as the representatives of many other countries and organizations.

Things are such that in the United States, for instance, from Los Angeles to Washington, they hammer away at it in the ‘Holocaust museums’, where today’s Jews have set themselves up as accusers of the whole world; they go so far as to incriminate the Jews in positions of responsibility

---

\* This preface was translated from the French original by Tom Kerr.



who were living in Europe, in America, or in Palestine during the war: they have the effrontery to reproach them for their collaboration or their indifference, or for the spinelessness of their reaction to the ‘systematic extermination’ of their co-religionists.

The earliest rumors of a gassing of Jews by the Germans apparently circulated in December of 1941 in the Warsaw ghetto.<sup>1</sup> But throughout the war such rumors found only a feeble echo in circles hostile to Germany. One has only to read a book such as that of Walter Laqueur’s *The Terrible Secret*<sup>2</sup> to realize that the skepticism was general. People still held long-lived memories during the Second World War of the invention of atrocities during the First World War, when stories were already being spread about the gassing of civilians (in churches or elsewhere), as well as stories about corpse factories. The Foreign Office saw the new rumors of the Second World War only as Jewish inventions, and many in American circles shared that conviction.<sup>3</sup> Edward Beneš, President of Czechoslovakia (in exile in London), announced in November 1942, *after inquiry by his staff*, that the Germans, contrary to what had been reported to him, were not exterminating the Jews.<sup>4</sup> The American Jew, Felix Frankfurter, a Supreme Court judge, stated to Jan Karski on the subject: “*I can’t believe you.*”<sup>5</sup> In August of 1943, Cordell Hull, Secretary of State, warned the U.S. ambassador in Moscow by telegram that in planning a joint Allied statement on “*the German crimes in Poland*”, it would be advisable to eliminate any mention of the gas chambers, since, as the British pointed out, there was “*insufficient evidence*” in the matter.<sup>6</sup>

Even after the war, high-ranking Allied officials such as Eisenhower, Churchill and De Gaulle, in their respective memoirs, would refrain from mentioning the existence and operation of ‘Nazi gas chambers’. In a manner of speaking, all these skeptics were in their own way Revisionists. Neither the Vatican, nor the International Committee of the Red Cross, nor the anti-German Resistance acted as if they put any faith in the rumors which, moreover, took the most fantastic forms: invariably the Germans were said to be exterminating the Jews, but as to the methods of extermination they were most varied: steam, gas, electricity, fire, acid, an injection of air, drowning, vacuum pump, etc. Why gas wound up the winner in the *Greuelpropaganda* competition is not exactly known.

The Frenchman Paul Rassinier was the first true Revisionist of the postwar period. In 1950, this former deportee began to denounce the “*myth of the gas chambers*” in *Le Mensonge d’Ulysse*<sup>7</sup> and in a whole series of works. In 1976, the American engineer Arthur Robert Butz published *The Hoax of the Twentieth Century*<sup>8</sup> which is the most profound revisionist work written to date on the subject of the alleged genocide and the gas chambers. In 1979, a German judge, Dr. Wilhelm Stäglich, in

---

<sup>1</sup> “*Stockholm, Dec. 21 (JTA). – More than 1,000 victims of spotted fever in the densely crowded Warsaw ghetto have been put to death by gas [...], it is learned today from reliable sources*” (*The Jewish Telegraphic Agency Bulletin*, December 22, 1941, p. 1).

<sup>2</sup> *The Terrible Secret. An Investigation into the Suppression of Information about Hitler’s “Final Solution”*, Weidenfeld and Nicolson, London 1980.

<sup>3</sup> *Ibid.*, see “*Foreign Office*” in the index as well as pp. 83, 91, 94, 116, 225, etc.

<sup>4</sup> *Ibid.*, pp. 162f.

<sup>5</sup> *Ibid.*, p. 237.

<sup>6</sup> *Foreign Relations of the United States, Diplomatic Papers*, US Printing Office, Washington 1963, vol.1 of 1943, pp. 416f.

<sup>7</sup> *Le Mensonge d’Ulysse*, La Librairie française, Paris 1950 (online: [abbc.com/aaargh/fran/archRassi/prmu/prmu.html](http://abbc.com/aaargh/fran/archRassi/prmu/prmu.html)).

<sup>8</sup> *The Hoax of the Twentieth Century. The Case Against the Presumed Extermination of the Jews*, Institute for Historical Review, P.O.Box 2739, Newport Beach, California 92659, USA. It is advisable to read the 1993 edition which contains, in three separate supplements, the lectures given by the author in 1979, 1982, and 1992. In the 1982 lecture, I recommend the dazzling demonstration contained in pages 350-362 about “*The story of the invisible elephant.*”

turn published *Der Auschwitz Mythos*,<sup>9</sup> a study devoted principally to the manner in which the German courts of law were able to collaborate in the fabrication of a myth, somewhat the same way that the judges of the witchcraft trials in the past, above all from 1450 to 1650, lent their support to even the most preposterous stories told about the stake, the grill and Satan's ovens.

Without wishing to diminish the great importance of Paul Rassinier, of Arthur Butz, and of Wilhelm Stäglich, I hope I may be permitted to say that, at the end of the seventies, revisionism would for once become materialistic and scientific with the research conducted on the ground by Ditlieb Felderer, the Swedish Revisionist, as well as with my own discoveries at Auschwitz proper, my observations on the use of Zyklon B for disinfestation (delousing), and my reflections on the utilization of hydrogen cyanide gas in the gas chambers of US-American penitentiaries for the execution of men condemned to death. Neither Rassinier, nor Butz, nor Stäglich had gone to Poland to the supposed sites of the crime, and none of them, moreover, had really utilized to their fullest extent the arguments of a physical, chemical, topographical, and architectural nature which today, following the investigations of D. Felderer and my own inquiries, are currently employed by the younger generation of revisionist researchers. As for the Jewish researchers, who defend the theory of the extermination of the Jews, they have resolutely remained what I call *paper historians*: Léon Poliakov and Raul Hilberg have stayed with paper and words and in the realm of speculation.<sup>10</sup>

It is surprising that this vast field of properly scientific argument was not seen by Germany, which has so many chemists and engineers, and by the USA, itself with no lack of scientific minds who even had the examples right there before them of their own gas chambers using hydrogen cyanide. In 1976 at Auschwitz, I discovered both the exact configuration of the crematories that were supposed to contain homicidal gas chambers, of the delousing gas chambers (*Entlausungsgaskammern*), and the plans (hidden until then) of certain crematories. In 1978/1979, I published two articles in *Le Monde*<sup>11</sup> in which I summarized some of my discoveries. In 1979, at the first conference of the Institute for Historical Review, in Los Angeles, I presented those discoveries in detail. Among those present in the audience was one Ernst Zündel, a German now living in Toronto. From 1985 on, this man would prove to be the most ardent, the most effective, and also – though many seem not to know it – one of the most innovative minds among all the Revisionists. He was the first to understand why I so insisted on the chemical argument and, in particular, on the importance that the technology of the American gas chambers in the thirties and forties had for us. He understood why I wanted a specialist in these American gas chambers to go and examine the alleged execution gas chambers on the spot, in Poland. Thanks to my correspondence with American penitentiaries in the seventies, I had already discovered such a specialist in the person of Fred Leuchter, but it was Ernst Zündel, and he alone, who had the brilliant idea of asking him not only to make an examination of the buildings, but to take constituent samples of material from the disinfestation gas chambers on the one hand and from the alleged execution gas chambers on the other. In February of 1988, he took the risk of sending Fred Leuchter and an entire team to Poland at his own expense to study the alleged gas chambers of Auschwitz, Birkenau and Majdanek. The results of the study of the buildings and of the analysis of the samples taken proved spectacular and totally in favor of the

<sup>9</sup> *Der Auschwitz-Mythos. Legende oder Wirklichkeit? Eine kritische Bestandsaufnahme*, Grabert-Verlag, Tübingen 1979 (online: vho.org/D/dam). The work was destroyed on orders of the German authorities. A second edition was published in Great Britain: *Der Auschwitz-Mythos* [...], Vorwort von Mark Weber, Beitrag von R. Faurisson, Bemerkungen von Revilo Oliver, Charles E. Weber u. Arthur R. Butz, Historical Review Press, 20 Madeira Place, Brighton, Sussex, England BN2 1TN, 1984. In both editions, the photographic documentation is from my archives.

<sup>10</sup> For a detailed critique of Raul Hilberg's work see Jürgen Graf, *The Giant With Feet of Clay. Raul Hilberg and his Standard Work on the "Holocaust"*, Theses & Dissertations Press, Capshaw, AL, 2001 (online: vho.org/GB/Books/Giant) (note of the editor).

<sup>11</sup> *Le Monde*, 29 December 1978 and 16 January 1979.

revisionist thesis. In the following years, other reports would confirm the basic accuracy of the *Leuchter Report*:<sup>12</sup> first the very learned report of Germar Rudolf,<sup>13</sup> then the involved and secret specialist's report of the Poles,<sup>14</sup> and finally the study of the Austrian Walter Lüftl.<sup>15</sup>

It only remains to be said that if Germany's accusers are not satisfied with these studies, they are at liberty to initiate their own specialist's report. What has kept them from doing it publicly, in broad daylight, these past fifty years?

We must understand the disarray of Germany's accusers in the face of revisionism's successes. For half a century they have sincerely believed that the tragedy undergone by the Jews during the Second World War was of exceptional seriousness and magnitude, whereas, when reduced to its proper proportions – that is, without genocide and without gas chambers – their tragedy was just one of many other tragedies of that terrible conflict. Under the thrust of revisionist inquiries their historians step by step have had to admit

- that there was neither an order, nor a plan, nor a budget for the alleged genocide of the Jews;<sup>16</sup>
- that 'Wannsee' was at best only a "silly story";<sup>17</sup>
- that there existed no specialist's report on the weapon of the crime concluding that 'the building (whether intact, "reconstructed", or in ruins) served as a homicidal gas chamber';
- that there is no autopsy that would allow us to conclude: 'This is the corpse of a deportee killed by poison gas';
- that the confession of Rudolf Höß was no longer of any value ("*Höß was always a very weak and confused witness*"<sup>18</sup>);
- that their alleged witnesses had probably never seen gas chambers or gassings inasmuch as the best of them, the famous Rudolf Vrba, in 1985, had been obliged to admit before a Canadian

---

<sup>12</sup> *An Engineering Report on the alleged execution gas chambers at Auschwitz, Birkenau and Majdanek, Poland*, April 5, 1988, 193pp. (online: [www.zundelsite.org/english/leuchter/report1/leuchter.toc.html](http://www.zundelsite.org/english/leuchter/report1/leuchter.toc.html)) Ernst Zündel published this report on 23 April 1988, with a preface written by me (Samisdat Publishers, Toronto).

<sup>13</sup> Rüdiger Kammerer and Armin Solms (eds.). *Das Rudolf-Gutachten*, Cromwell Press, London 1993 (online: [vho.org/D/rga/rgatoc.html](http://vho.org/D/rga/rgatoc.html)); Engl.: Germar Rudolf, *The Rudolf Report*, Theses & Dissertations Press, Chicago, IL, March 2003 (online: [vho.org/GB/Books/trr](http://vho.org/GB/Books/trr)).

<sup>14</sup> *Die offizielle polnische Antwort auf dem Leuchter-Bericht* [The official Polish reply to the Leuchter Report]. Translation of the Polish by T. Rudolph, distributed by E. Zündel (address see note 11). [A different report was published in 1994: J. Markiewicz, W. Gubala, J. Labedz, *Z Zagadnien Nauk Sadowych*, Z. XXX (1994), pp. 17-27; editors note.]

<sup>15</sup> Walter Lüftl, "Holocaust", in *The Journal of Historical Review* 12 (4), Winter 1992/93, pp. 391-420 online: [ihr.org/jhr/v12/v12p391\\_Lueftl.html](http://ihr.org/jhr/v12/v12p391_Lueftl.html)).

<sup>16</sup> In 1961, in the first edition of *The Destruction of the European Jews* (Quadrangle Books, Chicago, p. 177), Raul Hilberg calmly affirms the existence of an order (and even of two consecutive orders!) for the extermination of the Jews. In 1985, in the second edition of his book (Holmes and Meier, New York), he totally changes his explanation of the facts; he no longer mentions any order; he writes that there was no "basic plan" (p. 53) and that "no single organization directed or coordinated the entire process [of destruction]" (p. 55); he adds: "No special agency was created and no special budget was devised to destroy the Jews of Europe" (p. 62). He explains the whole supposed business of the extermination of the Jews by ... thought transmission or telepathic divination within the German bureaucracy: "an incredible meeting of minds, a consensus-mind-reading by a far-flung bureaucracy" (remarks made in a lecture on 22 February 1983 and confirmed by R. Hilberg at the time of his cross-examination in the Zündel trial in Toronto in 1985, per shorthand transcription, pp. 846-848)!

<sup>17</sup> Yehuda Bauer, Professor at the Hebrew University in Jerusalem, states precisely: "The public still repeats, time after time, the silly story that at Wannsee the extermination of the Jews was arrived at" (*The Canadian Jewish News*, 20 January 1992, p. 8, reproducing a dispatch of the Jewish Telegraphic Agency in London).

<sup>18</sup> Professor Christopher Browning, a contributor to the *Encyclopedia of the Holocaust*, to Christopher Hitchens, "Whose history is it?", *Vanity Fair*, December 1993, p. 117. The professor had the gall to add: "The revisionists use [R. Höß] all the time for this reason, in order to try and discredit the memory of Auschwitz as a whole."

judge and jury that in his famous book on the subject he had made use of “*poetic licence*” or “*licentia poetarum*”,<sup>19</sup>

- that the “*Jewish soap*” had never existed;<sup>20</sup>
- that the figure of four million victims at Auschwitz was only a fiction<sup>21</sup>;
- and that the

“*sources for the study of the gas chambers are at once rare and unreliable [...]. Besides, from 1942 to 1945, certainly at Auschwitz, but probably overall, more Jews were killed by so-called ‘natural’ causes [starvation, disease, sickness and overwork] than by ‘unnatural’ ones.*”<sup>22</sup>

Since 2 July 1982, at the end of an international symposium the exterminationists had organized at the Sorbonne (Paris) to attempt to answer me, they had shown themselves incapable of producing the slightest proof of the existence and the operation of a single gas chamber. In March of 1992, I hurled my challenge:

“*Show me or draw me a Nazi gas chamber!*”

Jean-Claude Pressac, on whom the exterminationists so much counted, had proven himself incapable of bringing forth anything but what he called “*traces of the crime*”, and he had taken great care not to provide us with a total physical representation of the weapon used in the crime.<sup>23</sup>

On 30 August 1994, I had a meeting with Michael Berenbaum, the scientific director of the Holocaust Memorial Museum in Washington, in his office and in the presence of four witnesses (two on his side and two on mine). I forced him to admit that, paradoxically, his museum contained no actual representation of a ‘Nazi gas chamber’ (the model of Krema II being only an artistic creation bearing no relation to reality). I asked him why. He finally replied:

“*The decision had been made [by us] not to give any physical representation of the Nazi gas chambers.*”

His response was equivalent to that of a Catholic priest – Mr. Berenbaum is a Jewish theologian – who decided to eliminate any representation of the cross from his church. To be driven to such extremities, one must surely feel that he has his back to the wall.

I think that the co-religionists of Mr. Berenbaum will at last abandon the gas chamber as they have abandoned the Jewish soap and the Auschwitz 4 million. They will go farther than that. As in the two previous cases, they will present themselves as the discoverers of the myth and accuse the Germans, the Poles, or the Communists of having fabricated the ‘myth of the gas chambers’. In support of their impudent thesis, they will then invoke the names of Jews who are Revisionists totally or in part (J.G. Burg, Jean-Gabriel Cohn-Bendit, Roger-Guy Dommergue, Arno Mayer, David Cole, Christopher Hitchens, Joel Hayward ...). They will then assign themselves the starring role.

<sup>19</sup> Zündel Trial in Toronto in 1985, transcription, pp. 1447-1448, 1636. The book in question is: R. Vrba, *I Cannot Forgive*, Bantam Books, Toronto 1964.

<sup>20</sup> Shmuel Krakowski, archives director of Yad Vashem, and Professor Yehuda Bauer finally admitted in 1990 that “*the Nazis never made soap from human fat*” (*The Jerusalem Post International Edition*, 5 May 1990). In a cemetery of Nice (France), there is a monument which bears the following inscription: “*This urn contains soap from human fat manufactured by the Germans of the Third Reich with the bodies of our deported brothers.*”

<sup>21</sup> In Jean-Claude Pressac’s opinion, the total number of deaths at Auschwitz, in round numbers, lies between 630,000 and 710,000; among them we must count 470,000 to 550,000 Jews who were gassed: *Die Krematorien von Auschwitz. Die Technik des Massenmordes*, Piper-Verlag, Munich 1994, p. 202.

<sup>22</sup> Arno J. Mayer, *Why did the Heavens not Darken? The “Final Solution” in History*, Pantheon Books, New York 1988, pp. 362, 365. The author, of Jewish origin, is a Professor of History at Princeton University (USA).

<sup>23</sup> It is noteworthy that although he knows how to draw, in none of his works does J.-C. Pressac venture to offer us a concrete representation of an entire gas chamber with an explanation of its “*technique and operation*”. In his huge book (*Auschwitz: Technique and Operation of the Gas Chambers*, The Beate Klarsfeld Foundation, New York 1989), he says that no “*direct proof*” exists but only “*criminal traces*” or “*indirect proofs*” (p. 429).

At the same time, however, transforming the ‘Holocaust’ of the Jews into a religious belief, this time divested of all material content, they will be only the more inflexible in denouncing authentic Revisionists as ‘deniers’, or ‘negationists’, as being intolerant, heartless, basely materialistic and hostile to the free expression of religious sentiments. For those Jews, the true Revisionists will thus continue to be diabolical in spirit even if they must be acknowledged to be in the right from a factual point of view.

The Revisionists are neither diabolical nor negative. By no means are they ‘naysayers’. They are positive in outlook. At the conclusion of their research – which is positivist in character – they affirm that certain beliefs are just myths. *Such myths are harmful in that they feed hatred.* The Revisionists strive to describe what has taken place and not what has not taken place. In sum and substance, what they proclaim to a wretched humanity is good news. Seeking only historical accuracy, they find themselves fighting against calumny and for justice. They have suffered and they will continue to suffer, but I believe, all things considered, that history will declare them right and render them justice.<sup>24</sup>

ROBERT FAURISSON, September 23, 1994

---

<sup>24</sup> A basic work, indispensable for the study of historical revisionism, is that of Canadian trial lawyer Barbara Kulaszka, *Did Six Million Really Die? Report of the Evidence in the Canadian “False News” Trial of Ernst Zündel – 1988*, Samisdat Publishers, Toronto 1992 (online: [www.zundel.org/english/dsmrd/dsmrdtoc.html](http://www.zundel.org/english/dsmrd/dsmrdtoc.html)).

# The Controversy about the Extermination of the Jews

## An Introduction

GERMAR RUDOLF

“No student, no researcher and no layman should believe any facts to be ‘conclusively proven’, even if the textbooks present them as such.”<sup>1</sup>

### 1. A German-Jewish Vision of the Future

When the cultural and social integration of the Jews in Germany became a reality in the course of the 19<sup>th</sup> century, this development also heralded one of the greatest and most fruitful symbioses that ever connected two peoples. For one, the identification of the central and partly also of the eastern European Jews with German culture and even with the German nation could not be overlooked. The high points of Jewish participation in the fate of the German nation no doubt include the many Jewish front-line soldiers of World War I, some of whom were highly decorated for their valor.<sup>2</sup> Another manifestation of this solidarity, however, was the opinion widely shared by the Zionists, that the official language of the future state of Israel would be German.<sup>3</sup>

But the interconnectedness of these two peoples goes much deeper than that. Who still remembers today the name Eduard von Simson, the son of formerly Jewish parents who later converted to the Protestant faith? He was the one who played decisive roles in all stages of Germany’s state unification in the 19<sup>th</sup> century, a process in which he was far more important than, for example, King Wilhelm I or Heinrich von Gagern.<sup>4</sup>

Who could forget the great and immensely important Jewish sector of the German intellectual elite, the philosophers and poets, scientists and artists who contributed so decisively to Germany’s world-wide fame in art and science for the past three centuries? An examination of a list of Nobel laureates for the first part of the 20<sup>th</sup> century reveals not only the striking predominance of German scientists, but also, among these, the large numbers of adherents to the Jewish faith.<sup>5</sup>

Could this symbiosis, so profitable for the whole world, be possible once again today?

If it seems a distant, utopian dream: why?

Today, German-Jewish relations are dominated by the accounts of suffering between 1933 and 1945. These years seem to have irretrievably poisoned German-Jewish relations, which are marked

---

<sup>1</sup> Walter Nagl, *Gentechnologie und Grenzen der Biologie*, Wissenschaftliche Buchgesellschaft, Darmstadt 1987, p. 127.

<sup>2</sup> Also in WWII, many Jewish soldiers and highly decorated officers with Jewish ancestry fought in the German Wehrmacht for the victory of the German nation; cf. the results of historian Bryan Mark Rigg, *Hitler’s Jewish Soldiers: The Untold Story of Nazi Racial Laws and Men of Jewish Descent in the German Military*, University Press of Kansas, Lawrence, KS, 2002.

<sup>3</sup> Cf. John C. G. Röhl, »Kaiser Wilhelm II. und Theodor Herzl im Heiligen Land – Ein deutsches Protektorat in Palästina?«, *Die Zeit*, Nr. 42/1998 (online: [www.humboldt-foundation.de/automat\\_db/wt\\_show.text\\_page?p\\_text\\_id=85](http://www.humboldt-foundation.de/automat_db/wt_show.text_page?p_text_id=85)); cf. Patricia Willms, “Kaiser Wilhelm II. und Theodor Herzl im Heiligen Land”, *Vierteljahreshefte für freie Geschichtsforschung (VffG)*, 4(3&4) (2000), S. 375-380 (online: [vho.org/VffG/2000/3/Willms375-380.html](http://vho.org/VffG/2000/3/Willms375-380.html)).

<sup>4</sup> Cf. G. Meinhardt, *Eduard von Simson*, Habelt, Bonn 1981. For an outline of Jewish contributions to modern German society prior to WWII see Dietrich Bronder, *Bevor Hitler kam*, 2<sup>nd</sup> ed., Marva, Genf 1975, pp. 333-346.

<sup>5</sup> Until 1933 there were 38 German Nobel laureates, of which five were of Jewish faith, that is 13%; much less than 1% of all Germans were Jewish at that time.

by a pattern of never-ending accusations on the one side and equally never-ending penitence on the other. What falls by the wayside is any recollection of such events of our common history that have positive value and could serve as a model for future co-existence.

It is my wish that both peoples should come together again in a partnership of mutual respect, so as to take up the traditions of an era that brought the world, Jewry, and the German people such immense benefit. It is also my wish that the time may come, at long last, where all the reciprocal contempt or disdain, mutual distrust and fear are eroded and ultimately removed. I long for the end of an era that has brought the world, Jewry, and the German people as much misfortune as perhaps no era before.

Michael Wolffsohn, Professor of History at the University of the German Bundeswehr in Munich, realized that the Jewish side in particular considers the constant remembrance of the Holocaust<sup>6</sup> to be the third main pillar of Jewish identity today, right next to the Jewish religion and Jewish nationalism.<sup>7</sup> This attitude, however, can result in the Jewish side's perpetual consideration of Germany and the German people as 'the enemy', which can only detract from the peaceful co-existence of the two peoples.<sup>8</sup> A discussion thus seems called for regarding the part which the Holocaust should play in the way Jews see themselves, so that both peoples may share a future relationship based on partnership.

A reconciliation between both people, however, requires more than that. Reconciliation can progress only in a climate which fosters speaking from the heart and listening with an open mind and spirit; where opinions are expressed rather than choked back or even suppressed; where points of contention are discussed in a civilized manner and not hidden by hushing-up, distractionism, or violence.

Therefore, it is not only a matter of a discussion of the Holocaust's proper place in Jewish self-perception; it is also a matter of the question whether historical accounts as they are presented today are correct. It is a question of whether the tendency, pointed out by Professor Wolffsohn, to remodel the Holocaust into a new transcendental pillar of Jewish identity, might have contributed to exaggerations and hence distortions of the way in which the events in question are themselves portrayed.

With this handbook of free scientific expression of opinion regarding the historiography of the Holocaust, I wish to extend a general invitation to an open discussion of these matters among equals, despite – or because of – the fact that, unlike most other publications on this topic, the position taken here is a controversial one. For the sake of such a discussion it is imperative that neither party disputes the other's honesty and desire for reconciliation. The first and foremost goal of this discussion is the joint and sincere search for truth, in order to contribute to a reconciliation between Jews and Germans, which may perhaps result in a realization of my dream of a revival of the German-Jewish symbiosis.

---

<sup>6</sup> The word 'Holocaust' itself is an ambiguous term. Frequently this word is used to denote all anti-Jewish measures taken by the German National Socialist government and its allies, but since persecution has unfortunately not been unusual in history, this definition seems far too broad. Used here, it means the intentionally committed, or only implied, *genocide* of the European Jews (allegedly) by the National Socialists, mainly with the murder weapon 'gas chamber'.

<sup>7</sup> Michael Wolffsohn, "Eine Amputation des Judentums?", in *Frankfurter Allgemeine Zeitung (FAZ)*, April 15, 1993, p. 32; for the psychological significance of the Holocaust, cf. also H. F. Stein, *The Journal of Historical Review (JHR)* 1(4) (1980) p. 309-322 (online: [ihr.org/jhr/v14/v14n5p28\\_Stein.html](http://ihr.org/jhr/v14/v14n5p28_Stein.html)); M. A. Hoffman II, *JHR* 6(4) (1985) p. 467-478 (online: [.../v06/v6p467\\_Hoffman.html](http://.../v06/v6p467_Hoffman.html)).

<sup>8</sup> Moshe Zimmermann as well has recognized the conversion of the Holocaust into a mythical entity – a conversion that accelerates as time goes on – as an obstacle to any return to German-Jewish normalcy; cf. Zimmermann, in *Aus Politik und Zeitgeschichte* 42(1-2) (1992) p. 33-43, esp. p. 34.

## 2. The Central Taboo of Our Time

But does this discussion, conducted in a spirit of partnership, also include the Holocaust? Whatever happened to the Jews in Hitler's sphere of control between 1941 and 1945, was it not bad enough in any case? Does any specific how and how much even matter? And so, isn't any discussion of it superfluous?

Let us assume for a moment that how and how much do not matter; to an extent, this view is certainly morally justified. Why then is there a need today for official insistence, backed up at least in most countries of Europe with threats of criminal prosecution, that things were exactly as we are being told they were, and not a whit different? If the details really do not matter very much at all, then why is there such adamant refusal to discuss them and to consider other opinions? If no one questions the morally reprehensible nature of the persecution of the Jews *per se*, why should it not be possible to discuss individual aspects of this persecution in a controversial manner? Is it a social taboo that must be respected, as Professor Arnd Simon said?<sup>9</sup> In the mid-1980s, the theories of the German historian Professor Ernst Nolte caused a stir because he not only demanded a scientific comparison between National Socialism and Stalinism,<sup>10</sup> but also introduced arguments regarding the motivation behind the National Socialist persecution of the Jews which had previously been the sole province of right-wingers, and which therefore were frowned upon.<sup>11</sup> That alone sufficed to warrant criticizing Nolte severely for these breaches of taboo. Since historical and political developments as well as recent findings following the opening of the archives of former Eastern Bloc nations confirmed Nolte's position as being self-evident, the hue and cry has now died down.

However, Ernst Nolte was not content with this, and elaborated his point further: in 1993 he published his work *Streitpunkte*, an overview of the topics which are still in dispute regarding the historiography of the Third Reich.<sup>12</sup> He included not only such points of contention as are accepted by establishment historians, but also focused emphatically on the theories of 'radical revisionism' which dispute, and attempt to refute, any planned genocide of the Jews by the Third Reich, specifically through the use of poison gas in stationary or mobile gas chambers. According to Nolte this thesis "can no longer be dismissed as merely absurd or malicious [...]."<sup>13</sup> After careful examination of the revisionist body of literature, which he outlines in part, along with its theses or claims, he

<sup>9</sup> In a conversation with Gernar Rudolf on May 3, 1993, at the Max-Planck-Institute for Solid State Research, Stuttgart. Compare with that the very interesting experiments conducted by Robert Hepp, Professor of Sociology, with his students. Exposing them to revisionist theses during his lectures resulted in reactions that resembled very much the reactions of members of 'primitive' cultures when their social taboos are violated: R. Hepp, "Die Kampagne gegen Hellmut Diwald von 1978/79. Zweiter Teil: Richtigstellungen", in Rolf-Josef Eibicht (ed.), *Hellmut Diwald. Sein Vermächtnis für Deutschland. Sein Mut zur Geschichte*, (ed.), Hohenrain, Tübingen 1994, endnote 46, p. 140. In Germany, everything concerning Jewish matters is indeed a very strong taboo. One can establish this by asking Germans, what they think is the greatest taboo of German society. In most cases, they would not even dare to spell out the word "Jew", but would name other topics, like 'sex' or 'foreigners'. In a society that claims to have no social taboos, naming a subject 'taboo' is identical with an accusation of this society, and that equals a violation of selfsame taboo most people don't dare to commit.

<sup>10</sup> The comparability of the two totalitarian regimes has long been a central theme in Nolte's research; cf. Nolte, *Der Faschismus in seiner Epoche*, Piper, Munich 1963; also Nolte, *JHR* 14(1) (1994) p. 15-22.

<sup>11</sup> High point: E. Nolte, *Der Europäische Bürgerkrieg 1917-1945*, Ullstein, Frankfurt am Main / Berlin 1987. For a synopsis of the so-called Historians' Dispute, together with a comprehensive bibliography, cf. I. Geiss, *Der Hysterikerstreit*, Bouvier, Bonn 1992; cf. R. Kosiek, *Historikerstreit und Geschichtsrevision*, 2<sup>nd</sup> ed., Grabert, Tübingen 1988.

<sup>12</sup> E. Nolte, *Streitpunkte*, Ullstein, Frankfurt am Main / Berlin 1993; cf. also the revisionist response by M. Köhler, *Auch Holocaust-Lügen haben kurze Beine*, Cromwell Press, Brighton 1994; now available from CHP, PO Box 118, Hastings TN34 3ZQ, UK (online: vho.org/D/Nolte).

<sup>13</sup> E. Nolte, *op. cit.* (note 12), p. 8.



grants that the revisionist school of thought is based on a scientific standard which, as far as a comprehension of source materials is concerned, is at least equal to that of the establishment historians,<sup>14</sup> even though he concludes that he cannot share the opinions of the Revisionists.<sup>15</sup> No doubt the statements he made in his book represent a much greater breach of taboo than did those which led to the ‘Historians’ Dispute’, since after all in this book he rendered the Revisionists and their theories and arguments socially acceptable – something which, according to Nolte, had been carefully avoided previously by means of rejection, slander or simply hushing-up. Nevertheless, his professional colleagues as well as the media kept perfectly quiet after his publication.

Needless to say that the radical leftists did take counter-measures – not in the form of published rebuttals, but in the form of violence. When Nolte was to give a lecture in Berlin in early February 1994, he was attacked and prevented from speaking by some 30 persons; not by anarchists, but by normal ‘anti-fascist’ intellectuals, who attacked him verbally with cries of “Nazi!”, as well as physically with tear gas, blows and kicks. The *Frankfurter Allgemeine Zeitung* correctly called it “*terrorism of conviction*” in the Federal capital.<sup>16</sup> I wonder whether Professor Nolte still accuses Robert Faurisson, the French Professor of Text and Document Criticism, the best-known Revisionist world-wide, of being himself partly to blame for the violent assaults against him, since after all he had allegedly phrased some of his theories in a polemic and aggressive manner?<sup>17</sup>

### 3. Germany’s Paralysis By Political Correctness

Non-German readers are probably not the only ones who will need an explanation regarding the continuing decay of democratic values in Germany and how this came about.<sup>18</sup>

In a recent speech, Günther H. Rehak, Austrian Social Democrat and formerly the personal secretary to the Austrian Federal Chancellor Dr. Kreisky, showed how the anti-Fascist movement – which fights so vehemently against any critical assessment of historiography, especially that of the Third Reich – differs from the other ‘anti’-movements.<sup>19</sup> Whereas anti-Capitalism or anti-Communism, for example, were always a matter of personal convictions and never became institutionalized, anti-Fascism has become organizationally firmly entrenched and structured on all social levels, especially in the German-speaking countries. There are, for example, anti-Fascist cafés (such as in Vienna and Berlin), anti-Fascist bookstores, and an almost endless number of organizations that incorporate the term ‘anti-Fascist’ in their name or at least somewhere in their statutes. While one’s reply to the question ‘are you anti-Communist?’ or ‘are you anti-Capitalist?’ has few noteworthy social repercussions, how to reply to ‘are you anti-Fascist?’ is becoming more and more of a sixty-four-thousand-dollar-question for people especially in German-speaking countries: anyone who then fails to clearly establish his anti-Fascist sentiments has all but disqualified himself morally.

Gerard Radnitzky has given an excellent account<sup>20</sup> of the origin, mechanisms and effects of German anti-Fascist opinion terrorism, a phenomenon which is also generally downplayed as ‘political correctness’ (PC). While PC has shown social effects in the United States, it has remained largely without pronounced consequences in the political and especially the legal arena there, and has also

---

<sup>14</sup> *Ibid.*, p. 304.

<sup>15</sup> *Ibid.*, p. 9, 290, 297.

<sup>16</sup> *Frankfurter Allgemeine Zeitung (FAZ)*, Feb. 4, 1994, p. 4, and Feb. 5, 1994, p. 27.

<sup>17</sup> E. Nolte, *op. cit.* (note 12), p. 306.

<sup>18</sup> The intolerance against scientology, which is making waves in the United States, also belongs in this category.

<sup>19</sup> G.H. Rehak, “*Wandlungen des Antifaschismus*”, *Kommentare zum Zeitgeschehen*, Nr. 33, August 1997, Postfach 543, A-1171 Vienna.

<sup>20</sup> G. Radnitzky “*Die ‘Politische Korrektheit’ gefährdet die Meinungsfreiheit. Totalitäre Tendenzen im Rechtsstaat*”, in R. von Schrenck-Notzing (ed.), *Freiheit braucht Mut*, Kronos, Munich 1997, pp. 125-176 (online: [vho.org/D/fbm/radnitzky.html#Radnitzky](http://vho.org/D/fbm/radnitzky.html#Radnitzky)).

prompted considerable counter-currents.<sup>21</sup> Primarily in German-speaking countries, on the other hand, it has increasingly become the yardstick by which all political and legal decisions are measured. The origins of this development are complex. For one thing, by means of the provisions for compulsory licensing<sup>22</sup> the so-called re-education program of the post-WWII American government in Germany ensured that socially influential positions, particularly those in the major print and broadcast media, in historiography, and in sociology, were held by decidedly anti-Fascist, *i.e.*, pronouncedly leftist persons, and that anti-Fascist and anti-national attitudes were deliberately fostered there. There was no free press and no academic freedom at the universities until 1955, when Germany was granted partial sovereignty. Conservative or right-wing publications could not counter-balance the economic advantages held in 1955 by the media that had been established in 1945 or shortly thereafter. The same goes for certain academic circles in German colleges and universities, where ideologically defined elements constantly perpetuate themselves. And to make sure that the situation could not change in political respects either, the so-called Office for the Protection of the Constitution was established in Germany; besides combating openly Communist political parties, this Office does all it can to shunt all conservative, national or right-wing parties and their members into a juridical void. Consequently, Germany has no major conservative or right-wing media, next to no such university or college professors, and no such political parties of any significance.

The second break which Radnitzky identifies in German post-war history is the so-called ‘Student Revolt’ of 1968, in the course of which German students, incited by the leftist or even Communist teachings of their professors whom the Allied occupation armies had installed in the German universities two decades earlier,<sup>23</sup> provoked severe riots with their pro-Communist slogans.<sup>24</sup> A small part of this movement descended into left-wing terrorism that kept Germany on tenterhooks in the 1970s, while the majority of these leftists began its march into the country’s various institutions.<sup>25</sup> Today, in the late 20<sup>th</sup> century, this generation with its Socialist to Communist ideas is at the height of power. Its members are strongly represented in all facets of German society<sup>26</sup> and are very adept indeed at bringing public opinion under their control by means of the so-called ‘Fascist Two-by-Four’<sup>27</sup>, *i.e.*, the way in which any and all opposition is silenced by the automatic fear of being accused of Fascist leanings. Radnitzky exposes the methods with which this manipulative, mendacious and falsifying elite uses media campaigns to bring about the downfall of persons holding dissenting opinions, and how this elite does not even balk at using or at least tolerating violence, for example in the form of assassination and arson of (insignificant) right-wing politicians or publications. The voices warning that the intellectual climate in Germany is becoming more and more poi-

<sup>21</sup> Cf. J.F. Garner, *Politically Correct Bedtime Stories*, New York 1994.

<sup>22</sup> Until 1955, a newspaper or broadcast media could be operated in Germany and Austria only if one had been licensed by the victors to do so. To be licensed, openly anti-national and anti-Fascist leanings were imperative, cf. C. von Schrenck-Notzing, *Charakterwäsche. Die Politik der amerikanischen Umerziehung in Deutschland*, Ullstein, Berlin 1993; G. Franz-Willing, *Umerziehung*, Nation Europa, Coburg 1991.

<sup>23</sup> Names such as Max Horkheimer, Theodor Adorno, Herbert Marcuse etc.

<sup>24</sup> Communist leaders such as Ho Chi Min, Che Guevara and Mao Tse Tung were shamelessly cheered in those days.

<sup>25</sup> One of the more prominent figures of this movement is today Germany’s Foreign Minister: Josef Fischer. Most members of the current government of Germany actually have their ideological roots in left wing extremism of the 1968s.

<sup>26</sup> According to M. Behrens, R. von Rimscha, *“Politische Korrektheit” in Deutschland. Eine Gefahr für die Demokratie*, Bouvier, Bonn 1995, p. 112, at least 48% of all leading opinion-makers in Germany describe themselves as leftist to leftist-radical, 19% as liberal and only 10% as Christian-socialist to conservative – and this in a political opinion-climate which for 50 years now has been shifting the zero coordinates of the political spectrum permanently towards the left. An analysis of this success story is presented, for ex., by Rüdiger Proske, in *Vom Marsch durch die Institutionen zum Krieg gegen die Wehrmacht*, Von Hase & Köhler, Mainz 1997.

<sup>27</sup> Hans-Helmuth Knütter, *Die Faschismus-Keule*, Ullstein, Frankfurt/Main 1993.

soned by this opinion terrorism and that Germany's democracy is in grave danger are now growing louder,<sup>28</sup> but of course the German media, those “*enemies of free society*”,<sup>29</sup> keep these voices from the public, and the rest of the world also studiously ignores them. Obviously, as was already the case before World War Two, a weak and self-destructive Germany, descending into a new totalitarian state in whose internal affairs the powers-that-be meddle at will, is again preferred to a strong German democracy, which would obviously present unwelcome economic, political and moral competition.

The chief mechanism with which these leftist circles hystericize and psycho-terrorize the German people is the so-called ‘theory of collective guilt’, sometimes veiled as ‘collective shame’ or ‘collective responsibility’. Radnitzky<sup>20</sup> gives excellent examples describing how this method attempts to hold the German people morally, politically, and economically liable for Hitler’s crimes until the end of time. The prerequisites for an implementation of this concept are: 1. the absolute acceptance of all allegations of German guilt, as well as 2. the moral (and increasingly, the legal) rejection of all attempts of revision and the hushing-up of similar or even worse crimes committed against the German people by others. By now this behavior pattern has won out not only in large sectors of German historiography and the media, but is also practiced almost without exception by the German people’s political representatives. And once such practices have morally branded Germany’s history and the German people in their capacity as its carriers as being ‘Fascist’, the self-proclaimed anti-Fascists are in a morally unassailable position, with which they can get away with almost anything.

Perhaps the best analysis of the situation of the historians engaged in exploring German contemporary history was presented by Backes, Jesse and Zitelmann in 1990.<sup>30</sup> They describe the sheer impossibility of getting public attention for new findings – much less even getting them published – as soon as they are considered by the public opinion to improve the image of the Third Reich. Many historians are more interested in preserving the politically correct image of this period of history rather than in supporting impartial research.<sup>31</sup> Unfortunately, in most European countries the situation worsened during the last decade, perhaps because more and more historians as well as non-historians are no longer willing to accept these illegal restrictions, and as a result, the media as well as the political and legal systems in Europe react with even more persecutions and legal restrictions.

#### 4. Total Juridical Blockade

If terrorism against one’s convictions or opinions was the only problem we had to wrestle with today, we might almost consider ourselves lucky, since, after all, one might expect that the authorities would protect us from this if they want to be acknowledged as authorities of a legitimate ‘state un-

---

<sup>28</sup> Besides G. Radnitzky, *op. cit.* (note 20) and M. Behrens, R. von Rimscha, *op. cit.* (note 26), cf. also Ch. Anstötz, R. Hegelmann, H. Kliemt, *Peter Singer in Deutschland: Zur Gefährdung der Diskussionsfreiheit in der Wissenschaft*, Lang, Frankfurt 1995; R. Baader (ed.), *Die Enkel des Perikles – liberale Positionen zu Sozialstaat und Gesellschaft*, v. 2, Resch, Gräffelfing 1995; G. Habermann, *Der Wohlfahrtsstaat. Geschichte eines Irrwegs*, Ullstein, Berlin 1994; E. Jesse, “‘Political Correctness’ in den USA und in Deutschland”, *Mut*, 12/1995, pp. 18-21; H. Kappel, A. von Stahl, *Für die Freiheit*, Ullstein, Berlin 1996; R.K. Laprecht, “Oligarchie in Karlsruhe: Über die Erosion der Gewaltenteilung”, *Neue Juristische Wochenschrift*, 50 (1994), pp. 3272ff.; K. Löw, *Von “Hexen” und Hexenjägern*, Baierbrunn 1993, all according to G. Radnitzky, *ibid.*; G. Detlefs, *Die Pervertierung der Meinungsfreiheit*, Hohenrain, Tübingen 1995.

<sup>29</sup> G. Bacher, according to G. Radnitzky, *op. cit.* (note 20), p. 139.

<sup>30</sup> U. Backes, E. Jesse, R. Zitelmann (eds.), *Die Schatten der Vergangenheit*, Propyläen, Berlin 1992 (online: [vho.org/D/dsdv/dsdv.html](http://vho.org/D/dsdv/dsdv.html)).

<sup>31</sup> Cf. especially in the aforementioned book: Uwe Backes/Eckhard Jesse/Rainer Zitelmann, “Was heißt: ‘Historisierung des Nationalsozialismus?’”, p. 25; Franz W. Seidler, “Lebensborn e.V. der SS. Vom Gerücht zur Legende”, p. 291; Eckhard Jesse, “Philosemitismus, Antisemitismus und Anti-Antisemitismus. Vergangenheitsbewältigung und Tabus”, p. 543; Uwe Backes, “Objektivitätsstreben und Volkspädagogik in der NS-Forschung. Das Beispiel der Reichstagsbrand-Kontroverse”, p. 614. (all online: [vho.org/D/dsdv/dsdv.html](http://vho.org/D/dsdv/dsdv.html)).

der the rule of law'. However, the problem is much greater than that, at least in most parts of Europe and, *e.g.*, lies hidden in Article 5 of the German Basic Law, which covers the right of free expression of opinion, academic freedom, and freedom of research and teaching.

According to Nolte, and in accordance with the UN Human Rights Convention, science and research must be permitted to question everything without exception.<sup>32</sup> Anyone wishing to criminalize such doubts, formulated as theses and evidence and published in an objective manner, violates the principle of academic freedom in a way which must be sharply rebuffed.<sup>33</sup> But what is the situation like in reality? Can one be sure of the protection of German Law if one postulates that certain aspects of the complex described as the Holocaust of the Second World War did not take place? Let's look at some relevant court decisions. Regarding freedom of opinion and of research, these verdicts indicate that the same are limited by the basic right of the inviolability of human dignity (Article 1 of the Law), which certainly no one will contest. If someone makes slanderous statements, or such tending to public incitement, this is beyond the legal pale of the free expression of opinion. But now it has become the rule for German courts to decree that even the mere supposition that certain specifics of the Holocaust did not take place constitutes an insult to the victims of the Holocaust. For this reason, they state, such claims are not protected by Article 5 of the Law. The question arises, of course, whether the thesis that not as many Jews died as had been presumed, and particularly not in the manner believed, can possibly constitute an insult to our Jewish fellow-citizens. To reword this in neutral terms: can a person who to date has believed that all his five missing siblings lost their lives in some horrible events be insulted by a third party advancing the claim that four of the five siblings did not die in said gruesome events, but rather had been dispersed throughout the world by the upheavals of war, and had assumed different names, which makes them impossible to trace today? One might at least expect the person in question to listen to the arguments presented, and then to draw fresh hope from, or even rejoice in, this piece of potential good news. The question, in other words, is whether it can be an insult to someone to claim that a certain injustice or misfortune did not befall him or his relatives. Is it not rather the case that if the theory proved to be correct, one should be mutually happy that the injustice did not occur? In other words, the situation hinges on the proof.

But will German courts permit such proof? The German justice system works on the presumption that the Holocaust, both in its entirety and in specifics, is 'self-evident', and unrefuted by public life and events, and that therefore any claims to the contrary are considered patently false until proven otherwise.<sup>34</sup> In such cases of 'self-evidentness' the German Code of Criminal Procedure exempts the Prosecuting Attorney's Office and the Court from the obligation to bring evidence in their own

<sup>32</sup> Following Karl R. Popper, one of our most renowned contemporary philosophers, this is the central point of human dignity, cf. *Objektive Erkenntnis*, 4<sup>th</sup> ed., Hoffmann und Campe, Hamburg 1984. For more detail cf. G. Rudolf, "Über richtige und falsche Erkenntnisse", in H. Verbeke (ed.), *Kardinalfragen zur Zeitgeschichte*, Vrij Historisch Onderzoek, Berchem 1996, pp. 19-47 (online: [vho.org/D/Kardinal/Erkenntnis.html](http://vho.org/D/Kardinal/Erkenntnis.html): English: [vho.org/GB/Books/cq/percept.html](http://vho.org/GB/Books/cq/percept.html)).

<sup>33</sup> E. Nolte, *op. cit.* (note 12), p. 308.

<sup>34</sup> In the USA and Canada, the situation is in some respect similar; cf. the case of *Institute for Historical Review v. Mel Mermelstein*, as described in *IHR Newsletter*, No. 82, October 1991, and M. Weber, *JHR* 3(1) (1982), pp. 31-51 (online: [ihr.org/jhr/v03/v03p-31\\_Weber.html](http://ihr.org/jhr/v03/v03p-31_Weber.html)); see also Michael Collins Piper, *Best Witness. The Mel Mermelstein Affair and the Triumph of Historical Revisionism*, Center for Historical Review, Washington, D.C., 1994; Theodore J. O'Keefe, "History and Memory: Mel Mermelstein's 'Eyewitness' Evidence", *JHR* 16(4) (1997), pp. 2-13 (online: [v16/v16n4p-2\\_Okeefe.html](http://v16/v16n4p-2_Okeefe.html)); cf. the verdict of the second Zündel trial in Toronto (Queen v. Zündel), Barbara Kulaszka (ed.), *Did Six Million Really Die? Report on the Evidence in the Canadian "False News" Trial of Ernst Zündel – 1988*, Samisdat Publishers Ltd., Toronto 1992, pp. 424f. (online: [www.zundel.org/english/dsmrd/dsmrdtoc.html](http://www.zundel.org/english/dsmrd/dsmrdtoc.html)); even though the Canadian Court admitted physical evidences, it completely ignored them in its verdict.

case.<sup>35</sup> In fact, however, the courts go even farther, by interpreting the paragraph in question in such a way that the defense is not permitted to bring counter-evidence against the generally accepted tenet!

This §244 of the German Code of Criminal Procedure also offers a theoretical possibility for overcoming the court's refusal of evidence. The paragraph states that evidence already present at the trial may only be refused if it is proven to be utterly unsuitable. In other words, if, with respect to a point at issue, the defense moves to hear an expert witness who is present in the courtroom and who has been summoned by the defense in accordance with proper procedure, the Court can refuse to hear the evidence only if an examination of the qualifications of the expert witness reveals that he is not properly qualified, either by a relevant educational background or by equivalent practical professional experience, to give expert testimony on the point at issue. In actual fact, however, Federal German courts as a rule refuse not only to hear present evidence but also present expert witnesses, dispensing with any examination of qualifications on the grounds of self-evidentness or of utter unsuitability. To date there has only been one exceptional case where an expert witness was even so much as questioned on his qualifications. The court decided that the educational status of the witness as *Diplom-Chemiker* (academically accredited chemist) was insufficient to allow him to give expert testimony on questions relating to chemistry. That, they decided, would require at least a doctorate.<sup>36</sup> It is important to note that this accredited chemist was the author of this article and that following my appearance at the court, the Central Council of German Jews intervened with my employer in order to put a stop to my activities as expert witness.<sup>37</sup> There can be no doubt that this intervention contributed to my subsequent dismissal without notice from my term position with the Max-Planck-Society.<sup>38</sup> Further, the University of Stuttgart denied me my doctorate despite the fact that I had met all formal and qualitative academic criteria. It is very likely that the aim of all these backstage arrangements was to ensure that I would not make even more trouble for standard historiography,<sup>39</sup> a plan that did, however, fail completely.

But back to 'self-evidentness'. Since the law generally accepts that matters considered by our society and hence our courts to be patently true are not necessarily always so – old 'truths' are forever being upset by new findings – written German law grants the defense the right to disestablish 'self-evidentness' and thus to open the doors for further hearing of evidence. This may be done in two ways:<sup>40</sup>

1. The defense must show that the evidence it wishes to present is superior to all evidence previously presented at German courts, which was used to justify the ruling of self-evidentness, or
2. the defense must prove that there is marked public dissent regarding the opinion deemed self-evident. A few publications from questionable sources are not enough – a considerable portion of the public establishment must hold a contrary opinion.

In fact, however, in recent years all motions by defense counsels to prove the superiority of new evidence have also been refused on the grounds of the self-evidentness of the Holocaust, even

---

<sup>35</sup> §244 Section 3 Clause 2, German Code of Criminal Procedure.

<sup>36</sup> Trial of O. E. Remer, District Court Schweinfurt, Ref. 1 KLS 8 Js 10453/92.

<sup>37</sup> Letter of the Secretary of the Central Council of German Jews, H. Jaeckel, to Professor Dr. H. F. Zacher, President of the Max-Planck-Society, dated June 22, 1993.

<sup>38</sup> In a lawsuit this dismissal without notice was changed to a conjoint termination of the employment contract; cf. Industrial Tribunal of Stuttgart, Ref. 14 Ca 6663/93.

<sup>39</sup> For details, cf. W. Schlesiger, *Der Fall Rudolf*, Cromwell Press, Brighton 1994 (online: [vho.org/D/dfir/Fall.html](http://vho.org/D/dfir/Fall.html)); Herbert Verbeke (ed.), *op. cit.* (note 32).

<sup>40</sup> Cf. *Oberlandesgericht* (Provincial High Court and Court of Appeal) at Düsseldorf, Ref. 2 Ss 155/91 – 52/91 III; Federal Constitutional Court, Ref. 2 BrR 367/92.

though the Holocaust itself was not even the point at issue in the motions; the point having been merely the claim that the new evidence was superior to the old.<sup>41</sup>

Anyone who considered this suppression of evidence to be a violation of the German Code of Criminal Procedure, had to face the fact that only recently even the German Federal Supreme Court does not deign to respond to appeals brought by the defense against this state of affairs. The dismissal of motions to examine the qualitative superiority of new evidence over old on the grounds of the self-evidentness of the Holocaust was declared to be correct because it concurred with the decision-making process of all Federal German courts.<sup>42</sup> In other words, the German courts cite each other as proof of their own claims.

Just recently the German Federal Constitutional Court took an especially easy way out when it decided that one particular researcher's scientific theses pertaining to the same subject represented an allegation of fact which, not being a statement of opinion, was not protected by the right of free expression thereof and hence could be banned outright.<sup>43</sup> Even the testimony of an expert witness who is to appear in court to testify with regard to the topic at issue is no longer free today, even disregarding for the moment the aforementioned ruinous professional consequences which such activity entails. Presiding Judge Peter Stockhammer of the Nuremberg District Court, for example, cautioned the author of the present article that he might be committing a criminal offence if he were to support the theses of the accused, A. Vogt, which proposed that the gas chambers in Auschwitz had not existed.<sup>44</sup> This was the first time that a German court stated outright that an expert witness on the subject of the Holocaust must always arrive at a pre-set conclusion if he wishes to avoid committing a criminal offense. But what are the implications of this for the value of all those expert reports drawn up to date on this subject of history, if the experts writing them never had any choice but to conform to Allied and German political handicaps? An indirect answer to this was given by a renowned expert witness, the historian Hans-Heinrich Wilhelm:<sup>45</sup>

*"Today the history of the Holocaust is considered to be by far one of the best-researched chapters of recent history. A closer look at this subject, however, usually reveals very quickly that our understanding is still based on a very unstable foundation. Often the congruity of the various research can only be explained by the historians' practice of uncritically copying each other's work [sic!] – while at the same time court files, which to this day are not generally accessible, continue to harbor undiscovered documents which even the prosecutors who dealt with the 'case' at the time may not remember today. Demands requiring historical expert witnesses to keep silent also at times cause the 'state of research' to lag behind the state of knowledge and awareness held by some few individuals."*

So what are "demands requiring historical expert witnesses to keep silent"? This appears to be nothing less than the admission of a renowned expert witness that incomplete and thus biased testimony by those witnesses is the rule rather than the exception, *i.e.*, that they all commit perjury, probably partly because they are convinced that this is morally (in other words, politically) correct, or because they are simply afraid of the public reaction that is to be expected if they break the unwritten rules of Germany's strongest taboo.

<sup>41</sup> Revealing in this context are the admissions of a Munich judge who said to the defense lawyer Dr. Klaus Goebel right away, that he will never succeed in presenting revisionist evidences since there are political orders which are prohibiting the acceptance of these evidences, cf. O.E. Remer (ed.), *Die Zeit lügt!*, Verlag Remer-Heipke, Bad Kissingen 1992, p. 9 (online: [vho.org/D/Beitraege/Zeit.html](http://vho.org/D/Beitraege/Zeit.html)), and personal communications of Dr. K. Goebel.

<sup>42</sup> Ref. 1 StR 193/93.

<sup>43</sup> Federal Constitutional Court, decision of June 9, 1992, Ref. 1 BvR 824/90, *Neue Juristische Wochenschrift* 1993, p. 916.

<sup>44</sup> Ref. 6/38 Ns 341 Js 31951/92, cf. *Süddeutsche Zeitung*, March 17, 1994, p. 52; more details about this entire juridical scandal: Karl Salm, "Der Justizskandal in Fall Thomas-Dehler-Stiftung", *Staatsbriefe*, 5(12) (1994) (online: [vho.org/D/Staatsbriefe/Salm6\\_2-4-6.html](http://vho.org/D/Staatsbriefe/Salm6_2-4-6.html)).

<sup>45</sup> H.-H. Wilhelm, in U. Backes, E. Jesse, R. Zitelmann (eds.), *op. cit.* (note 30), p. 403.

In light of these circumstances it seems sheer mockery that the courts state that one of the prerequisites for the disestablishment of ‘self-evidentness’ is that there must be noticeable public dissent, especially since anyone who dissents is mercilessly prosecuted in court and has not even the shadow of a chance to prove his objections, as he is denied the right to bring any evidence towards this end. In late March 1994, Federal Minister of Justice Leutheusser-Schnarrenberger, summarily slandering all dissidents as ‘neo-Nazi’ liars, stated that the underlying purpose of declaring the Holocaust to be self-evident was precisely to make it impossible for those disputing certain aspects of official historiography to explain their theses and their evidence in court and in public:

*“Hearing evidence [regarding the Holocaust] is therefore [i.e., due to its self-evidentness] superfluous. To many this may seem trivial, but it prevents the neo-Nazi liars from gaining a forum in the courts and the public.”*<sup>46</sup>

The German Federal Supreme Court has decided in 1994 that, contrary to previous court practices, simply denying the destruction of the Jews in the Third Reich does not in itself constitute public incitement (§130, German Criminal Code) or incitement to racial hatred (§131). Rather, it must be proven that such denial was related to the National Socialist school of thought regarding the Jews, or alternatively that it was insinuated that the Jews had set up the ‘Holocaust-Lie’ in order to blackmail, plunder or destroy the German people, etc. (the “*qualified Auschwitz-Lie*”). In its decision, the German Federal Supreme Court confirmed again the ‘self-evidentness’ of the murders in the gas chambers.<sup>47</sup> In other words, objective revisionist research into the Holocaust and the publication of resultant findings would not come under the threat of prosecution under §§130f., even though they cannot be presented as evidence against the ‘self-evident truth’ about the Holocaust. Following a massive uproar in the media,<sup>48</sup> the Federal Supreme Court stated in its written opinion that the mere denial of certain National Socialist mass murders – if presented in a scholarly way or not – certainly could disparage the memory of the people (supposedly) killed in these mass murders, as well as insulting Jews living today, and might thus be punishable under §§185, 189 of the German Criminal Code.

## 5. From Juridical Blockade to Juridical Terror

Following this German Supreme Court decision, it was to be expected that German legislators would endeavor to render even the so-called “*basic Auschwitz-Lie*” – the objective scientific disputation of the Holocaust – a criminal offense under §§130f., as is already the case in Austria and France and as several German political parties have also demanded for Germany following the Supreme Court decision.<sup>49</sup> And indeed, Section 3 of the revision of §130, which came into effect at December 1, 1994, provides that anyone is guilty of incitement of the people

*“[...] who, publicly or at an assembly, approves, denies or trivializes, in a manner suited to disturbing public law and order, any act committed under the National Socialist regime which comes under §220a Section 1 [genocide; G.R.]”*

---

<sup>46</sup> Federal Minister of Justice S. Leutheusser-Schnarrenberger, in *Allgemeine Jüdische Wochenzeitung*, March 24, 1994, p. 2.

<sup>47</sup> Federal Supreme Court, verdict of March 15, 1994, Ref. 1 StR 179/93.

<sup>48</sup> Cf. publications of the German daily press of April 22, 1994.

<sup>49</sup> *Münchener Merkur*, March 17, 1994, p. 4. H. Däubler-Gmelin, SPD Vice Chairwoman and Minister of Justice of the SPD shadow cabinet, is particularly active in her support of this; *Süddeutsche Zeitung*, April 21, 1994; cf. also the Federal Minister of Justice (note 46). The *FAZ* took a counter-position (April 7 and 27, July 7, 1994).

Although the German Federal Constitutional Court has decided before that laws which prohibit certain opinions are unconstitutional and therefore illegal,<sup>50</sup> the revised §130 created a special law which does exactly this: it provides for the punishment of approval, denial or trivialization of specifically and exclusively those acts of genocide actually or allegedly committed under the National Socialist regime. Such a revision would be constitutional only if it prohibited the approval, denial or trivialization of any and all acts of genocide ever committed.<sup>51</sup>

However, suits against this law are always dismissed, and complaints by German judicial experts, stating that this special law against freedom of speech,<sup>51</sup> which was not thought through to the end,<sup>52</sup> is an “*assault against the intellectual freedom of all dissidents*”<sup>53</sup> and that its “*legitimacy is at least questionable*”<sup>54</sup>, are generally ignored. Even a doctoral dissertation written by a student of a fervent anti-revisionist professor of law, which solely focused on the “*Punishability of the Auschwitz-Lie*” and concluded that outlawing radical revisionism is unconstitutional, went totally unheeded.<sup>55</sup>

By now, clearly even historians perceive the politicians’ and jurists’ efforts to grossly restrict contemporary historians’ freedom of research as very oppressive. For example, the late historian Joachim Hoffmann of the German Armed Forces’ own Research Centre for Military History wrote:<sup>56</sup>

*“The efforts of the political parties to restrict the legally guaranteed freedom of scientific research are gradually taking on truly grotesque proportions. The result [...] would be that controversies relating to contemporary history would, in future, be laid before the court, and decided by criminal courts according to criminal law.”*

Elsewhere he becomes even more explicit with respect to measures of censorship, for example on p. 185:

*“The Auschwitz problem has recently become the object of intensive journalistic debate, generally conducted both knowledgeably and intelligently in all its aspects, both in Germany and abroad, even if many groups zealously exceed the proper limitations of this debate due to their political motivations. This controversy is being conducted less in the “official” literature than in rather remote publications, and is not a little influenced by official prohibitions against certain forms of thought and speech, suspiciously watched over by a system of political denunciation. The related prevention of free discussion of an important problem of contemporary history, no matter how unfortunate it may be today, will, of course, be ineffective in the long run. Experience shows that free historical research can only be tempo-*

<sup>50</sup> Karl-Heinz Seifert, Dieter Hömig (ed.), *Grundgesetz für die Bundesrepublik Deutschland*, 2<sup>nd</sup> ed. Nomos Verlagsgesellschaft, Baden Baden 1985, cf. comments to article 5 of German basic law.

<sup>51</sup> Stefan Huster, “*Das Verbot der ‘Auschwitz-Lüge’, die Meinungsfreiheit und das Bundesverfassungsgericht*”, *Neue Juristische Wochenschrift* 1995, p. 487ff., here p. 489. A synopsis of the present legal position of revisionist research may be found in K. C. Holmar, *Deutschland in Geschichte und Gegenwart (DGG)* 42(2) (1994) p. 4f.

<sup>52</sup> Dreher/Tröndle (eds.), *Strafgesetzbuch*, 47<sup>th</sup> ed., Rdnr. 18 zu §130)

<sup>53</sup> Daniel Beisel, “*Die Strafbarkeit der Auschwitz-Lüge*”, *Neue Juristische Wochenschrift* 1995, p. 997-1000, here p. 1000.

<sup>54</sup> Karl Lackner, *Strafgesetzbuch*, 21<sup>st</sup> ed., Beck, Munich 1995, Rdnr. 8a zu §130; critical comments regarding this law are legion, cf. Hans A. Stöcker, *NSStZ* 1995, p. 237-240; Manfred Brunner, *FAZ*, August 17, 1994; Prof. Ernst Nolte, *FAZ*, September 8, 1994; Ronald Dworkin, *tageszeitung*, May 17, 1995; Horst Meier, *Die Zeit*, September 15, 1995; *ibid.*, *Merkur*, 12/1996, p. 1128-1131; Prof. H. Hoffmann, *FAZ*, May 21, 1994, letter to the editor, p. 9; cf. *FAZ*, May 21, 1994, p. 10: “*Strafbarer Irrtum*”; *ibid.*, April 7 and 27, 1994.

<sup>55</sup> Thomas Wandres, *Die Strafbarkeit des Auschwitz-Leugnens*, Duncker & Humblot, Berlin 2000; cf. review by G. Rudolf, *VffG*, 5(1) (2001), pp. 100-112 (online: [vho.org/VffG/2001/1/Rudolf100-112.html](http://vho.org/VffG/2001/1/Rudolf100-112.html)). Wandres prepared his PhD thesis under Prof. Gerhard Werle, who himself is an uncritical supporter of all Holocaust claims, cf. G. Werle, T. Wandres, *Auschwitz vor Gericht. Völkermord und bundesdeutsche Straffjustiz*, Beck, München 1995.

<sup>56</sup> Joachim Hoffmann, *Stalin’s War of Extermination 1941 – 1945*, Theses & Dissertations Press, Capshaw, AL, 2001, p. 334, fn 3.



rarely hindered by criminal law as it exists in many European countries. Historical truths usually continue to exert their effects behind the scenes, only to emerge triumphantly at a later time.”

These and other politically incorrect views prompted the leftist press to call Hoffmann’s book “a scandal”.<sup>57</sup> Since Hoffmann’s former superior, Manfred Kehr, who was still in office at the time, had written the preface to this book, certain circles attempted to initiate penal or at least disciplinary action against him, but their efforts failed.<sup>58</sup> Perhaps the most noteworthy comment was that of Daniel J. Goldhagen, who repeatedly stated in German-language media that the undemocratic German “Auschwitz Lie law” ought to be abolished, and the sooner the better.<sup>59</sup> Heinz Höhne, for many years the editor of the leftist German weekly news magazine *Der Spiegel*, also recently commented critically on the ever-intensifying inquisition to which his colleagues are subjected:

“But if historians, in the course of their research, touched on this Manichaeian idea of good and evil, they could easily end up in a mine field of taboos and forbidden thoughts, where bizarre coalitions of ‘pedagogues for the people’, self-proclaimed ‘High Court judges of history’, and paragons of political correctness jealously guard their own brand of historical truth. They are driven by the gnawing suspicion that, given professional historiographers’ penchant for revision, there will eventually be little or nothing left of the once so solidly established view of the Fascist regime of terror.”<sup>60</sup>

As a result of the tightening of criminal law, the spring of 1995 saw a wave of book destruction in Germany, in which history books of revisionist nature as well as political books went the way of the state shredder; these books were exclusively of a right-wing nature, some of them even only allegedly so.<sup>61</sup> The fact that books with historical or political content can be destroyed in Germany on the orders of a court is largely unknown. This may be due to the fact that such campaigns of book destruction are not generally publicized – in other words, they are carried out behind the public’s back. Since book confiscations are accompanied by corresponding criminal proceedings against all persons involved in the production, import and/or distribution of forbidden literature – *i.e.*, against authors, editors, publishers, booksellers, printers, and multiple-copy purchasers, even in cases where the books were produced, distributed or bought at a time when they were not yet banned<sup>62</sup> – the list of persons being prosecuted for “thought crimes” in Germany is growing at an alarming rate. These account for a considerable portion of those cases which have led to the recent enormous increase in the category of alleged “right-wing crimes” in Germany.<sup>63</sup> Because censorship, book burning, and the persecution of people for “propaganda offenses” in Germany is such an important, but hardly ever discussed topic, we have included a more detailed study about that by Anton Mägerle in Appendix 3 of this handbook.

The first seize-and-destroy order that was issued after the legal revision of December 1, 1994, was carried out in late March 1995 against the German edition of the book you are holding in your hands, *Grundlagen zur Zeitgeschichte*.<sup>64</sup> Though some 1,000 German academics protested against

<sup>57</sup> K. Naumann, “Stalins Vernichtungskrieg?”, *Die Zeit*, October 10, 1995; cf. also M. Grill, “Amtliche Schützenhilfe für Legendenbildung”, *Badische Zeitung*, December 23, 1995; letters to the editor, *ibid.*, December 29, 1995; conversely, objective comments: G. Gillissen, “Der andere große Verderber Europas”, *FAZ*, October 10, 1995; W. Birkenmaier, “Hitlers Angriff – Stalins totaler Krieg”, *Stuttgarter Zeitung*, July 28, 1995, p. 24.

<sup>58</sup> Pers. comm. by J. Hoffmann and Wolfgang Bergt.

<sup>59</sup> E.g. in *Profil* (Vienna), September 9, 1996, p. 75.

<sup>60</sup> H. Höhne, *Gebt mir vier Jahre Zeit*, Ullstein, Berlin 1996, p. 8.

<sup>61</sup> An overview of the current situation is available online at [vho.org/censor/Censor.html](http://vho.org/censor/Censor.html).

<sup>62</sup> German legislators simply assume that books are not made illegal by a state decree, but rather that they start out that way, by virtue of their contents.

<sup>63</sup> Regarding the suppression and persecution of German patriots in general, cf. R.-J. Eibicht, *Unterdrückung und Verfolgung Deutscher Patrioten*, Hutten Verlag, Viöl 1997.

<sup>64</sup> We cannot discuss all cases here, but would like to refer to some publications about the probably most prominent cases: U. Walendy, “Ausgehebelte Grundrechte”, *Historische Tatsachen* no. 69, Verlag für Volkstum und

this book-burning,<sup>65</sup> and two distinguished historians have even testified in court in favor of it,<sup>66</sup> the court nevertheless decided that the book has to be destroyed, the publisher to be fined (30,000 DM), the editor jailed, some authors imprisoned, and several book sellers and purchasers fined or imprisoned as well. Though apparently supported by the German Federal Constitutional Court,<sup>67</sup> this ruling is quite obviously a violation of human rights, for this interpretation strikes at the heart of the fundamental right to freedom of research, *i.e.*, the right to freedom of choice in the selection of one's theses and the right to openness of research findings (cf. Karl R. Popper<sup>32</sup>).

The trial concerning the 'freedom' of this very book *Grundlagen zur Zeitgeschichte* in Germany – that is, concerning the freedom of its authors, editor, publisher, printer, sellers and buyers – will likely drag on for several more years and is indeed a crucial case which will contribute significantly to shaping the future course of human rights in Germany.

But unfortunately this was not the final turn of the ever-tightening thumb screws on freedom of speech in Germany. The next round was rung in by the Cologne physician Prof. Dr. Wolfgang de Boor, who stated in a letter-to-the-editor that Revisionists ought not to be put into prison, but into insane asylums due to their obvious mental aberration,<sup>68</sup> which is reminiscent of the abuse of psychiatry by totalitarian systems to 'treat' dissidents.<sup>69</sup> The fact that the justice system in the German-speaking regions did not even wait for this suggestion before acting in this vein is demonstrated by the case of the Austrian Revisionist Emil Lachout, whom the Austrian justice system had tried in vain, in 10 years of preliminary proceedings, to drag into court for his beliefs. When the European Court decided in early 1997 that such lengthy preliminary proceedings were a violation of human rights,<sup>70</sup> the appropriate District Court in Vienna hurriedly barreled the trial through on July 1, 1997, and summoned the psychiatrist Dr. Heinrich Pfolz as expert witness to assess the accused's capacity for criminal responsibility. Since this psychiatrist was unable to actually examine the accused, who had refused to attend the hearing, he indicated in his expert report on Lachout's mental condition that if he had been able to examine the accused, he would have concluded that he was partially mentally enfeebled! On the basis of this 'expert report', the case against Lachout was dis-

---

Zeitgeschichtsforschung, Vlotho/Weser 1996; H. Verbeke (ed.), *op. cit.* (note 39); H. Schmidt, *Jailed in "Democratic" Germany. The Ordeal of an American Writer*, Guderian Books, Milton/FL 1997; G. Anntohn, H. Roques, *Der Fall Günter Deckert*, DAGD/Germania Verlag, Weinheim 1995; furthermore, the periodicals *VffG* and *The Revisionist* (PO Box 118, GB-Hastings TN34 3ZQ / PO Box 257768, Chicago, IL 60625, USA) report about censorship and other kinds of intellectual suppression in general quite frequently (online: [vho.org/VffG](http://vho.org/VffG); [vho.org/tr](http://vho.org/tr); [vho.org/censor/Censor.html](http://vho.org/censor/Censor.html)).

- <sup>65</sup> "Appell der 100 Die Meinungsfreiheit ist in Gefahr", *FAZ*, May 17, 1996; in the *Stuttgarter Nachrichten* and the *Stuttgarter Zeitung* on July 19, 1996, with 500 signatures; in the *Westfalen-Blatt* on Sept. 13 and 18, 1996, with 1,000 signatures each.
- <sup>66</sup> Expert reports by Prof. Dr. Ernst Nolte and Dr. Joachim Hoffmann, Tübingen County Court, Ref. 4 Gs 173/95; the latter was published in *VffG*, 1(3) (1997), pp. 205ff; see Appendix 2 at the end of this volume for the English translation.
- <sup>67</sup> In a not quite comparable, but at least similar case, the German Federal Constitutional Court (ref. 1 BvR 408f./83) approved the confiscation of Wilhelm Stäglich's book *Der Auschwitz Mythos. Legende oder Wirklichkeit? Eine kritische Bestandsaufnahme*, Grabert-Verlag, Tübingen 1979 (online: [vho.org/D/dam](http://vho.org/D/dam); Eng.: *The Auschwitz Myth: A Judge Looks at the Evidence*, Institute for Historical Review, Newport Beach, CA 1986; online: [codoh.com/trials/tristagintro.sht](http://codoh.com/trials/tristagintro.sht)), see the appendix in Wigbert Grabert (ed.), *Geschichtsbetrachtung als Wagnis*, Grabert, Tübingen 1984, pp. 287ff.
- <sup>68</sup> W. de Boor, "Bei Angeklagten mit Monoperceptose", *FAZ*, May 8, 1995, p. 12; cf. W. de Boor, D. Meurer (ed.), "Über Monoperceptosen", *Zeitschrift für das gesamte Sachverständigenwesen*, 4(2) (1983), pp.
- <sup>69</sup> Eg. H. Festge-Weinrother, "Eingespannte Psychiatrie", *FAZ*, May 13, 1995; in a later published book on this topic de Boor backed down a bit from his earlier opinions: Wolfgang de Boor, *Wahn und Wirklichkeit. Psychiatrische Grenzfälle vor Gericht*, Verlag C. H. Beck, Munich 1997; cf. the review in *VffG* 2(1) (1998), pp. 56-60 (online: [vho.org/VffG/1998/1/Buecher1.html#Kammerer](http://vho.org/VffG/1998/1/Buecher1.html#Kammerer)).
- <sup>70</sup> Cf. *VffG*, 1(1) (1997), p. 52.

missed due to insufficient capacity for criminal liability.<sup>71</sup> A similar farce may soon take place in Berlin, where the Tiergarten County Court has commissioned the psychiatrist Dr. Platz to determine whether the accused in this particular case, a Berlin publisher who is being prosecuted for publishing revisionist articles and books, is criminally responsible or perhaps suffers from a

*“mental disorder, a profound disturbance of consciousness, or a severe mental aberration.”*<sup>72</sup>

For as long as such psychiatric assessments only result in the corresponding cases being dismissed, one can take a certain degree of comfort. However, one must of course ask oneself how soon the next step will follow: namely, when the accused will not be released after their cases have been dismissed, but rather will be sent to a closed psychiatric institution, that is, an insane asylum, for their *“profound disturbance of consciousness or severe mental aberration”*. At that point there would be no difference left between the former communist German Democratic Republic and the reunited Germany of today.

The latest development is a decision by the German Federal Supreme Court which ruled in late 2002 that defense lawyers who dare to ask for the introduction of revisionist evidence in a trial against a revisionist defendant accused of *“denying the Holocaust”* is breaching the same law and has to be prosecuted and sentenced as well. In this specific case, Attorney at law Jürgen Rieger had simply filed a motion to hear the author of the present article as an expert witness on chemical and technical aspects of the gas chambers of Auschwitz, a request the German Supreme Court considered to be illegal and punishable with up to five years in prison.<sup>73</sup>

In light of the aforementioned experiences with European courts and the reactions of the public it must seem downright miraculous that there are in fact members of the establishment who dare to tackle the taboo surrounding the Holocaust. Walter Lüftl, President of the Austrian Federal Chamber of Engineers until spring 1992, is certainly one of these. When he expressed his doubts about details of the Holocaust due to technical considerations, the Austrian justice system struck as mercilessly as is the rule in France or Germany. Since the academically accredited engineer Lüftl, being an ‘average’ citizen and exceedingly well qualified in his area of specialization (architecture), had not expected such behavior from his ‘state under the rule of law’, this meant a painful learning process for him. W. Rademacher describes the case of Lüftl as an introduction to our topic, to show how Johnny Doe and respected public personalities alike can suddenly find themselves caught up in the wheels of a dubious state-administered justice system bent on safeguarding a taboo. At the same time he shows the contrast between the treatment accorded to expert witnesses in trials pertaining to National Socialist crimes and to similar witnesses in normal trials, and acquaints the reader with our topic by means of some technical explanations.

## 6. Dubious Evidence for the Holocaust

What kind of evidence is it that provides the foundation for those verdicts which German courts cite time and again in their claims of self-evidentness? To date, in its trials of the so-called National Socialist mass murders of Jews, the Federal German justice system – and others as well – has con-

---

<sup>71</sup> *Standard* (Vienna), July 2, 1997. Before that, four other psychiatrists had refused to certify Lachout as abnormal (pers. comm. by E. Lachout). Obviously the Austrian justice system kept looking until they had found a psychiatrist who was ‘willing to co-operate’.

<sup>72</sup> Ref. 271 Ds 155/96, issued by Madam Justice Maietti am 8.7.1997; cf. *VffG* 2(1) (1998), pp. 35f. (online: [vho.org/VffG/1998/1/Toepfer1.html](http://vho.org/VffG/1998/1/Toepfer1.html)); a criminal court case against the Austrian Revisionist Franz J. Scheidl was closed down in the later 60’s because the court assumed that the defendant suffered a mental disorder; personal information by W. Rademacher. Scheidl’s books are online available at [vho.org](http://vho.org).

<sup>73</sup> German Federal Supreme Court, ref. 5 StR 485/01, *Neue Juristische Wochenschrift* 2002, p. 2115, *Neue Strafrechts-Zeitung* 2002, p. 539.

cerned itself merely with convicting individual accused persons of sole or joint guilt. The crimes themselves were never investigated by a court, but presumed to be self-evident, namely on the basis of the conclusions of the Nuremberg War Crimes Tribunals. These too, however, dispensed with any on-site investigations of the presumed crimes and based their conclusions on eyewitness testimony and documents, both obtained by dubious means, as we will learn later.

The self-evidentness of the National Socialist genocide of the Jews, therefore, exists even though neither the whole of the genocide nor parts thereof were ever investigated by a court, *e.g.*, by means of examining the remains of victims, the murder weapons, perpetrators, or even the crime itself. But if the Holocaust is considered to be self-evident from the start and any court investigation is thereby automatically blocked, no court can or may ever come to any conclusion other than that the crimes attested to were in fact committed. Under these conditions it is especially important to view eyewitness testimony in a critical light, for it is to be expected that testimony which disputes a crime or a set of crimes will be rejected as worthless without any reason for such rejection, while incriminating testimony is indiscriminately accepted as truth. For the courts, in other words, the overall nature of the crimes is settled from the start at any trial, and evidence is superfluous except for purposes of determining the degree of guilt and the punishment thereof.

In the second section of this volume, Manfred Köhler outlines the conditions under which eyewitness testimony and confessions came about in the five decades that have passed since the Second World War. He has deliberately refrained from a critique or even an assessment of the testimony itself. His objects were strictly the peripheral conditions of the post-war trials, whether conducted under Allied or especially under Federal German control, as well as the social atmosphere particularly in the Federal Republic of Germany. The results are perforce shocking, as they are remarkably similar to the conditions of the 16<sup>th</sup> and 17<sup>th</sup> century witch trials: a general conviction of the infallibility of official views, and a profound disgust and consternation at the alleged crimes which through its intensity inhibits any ability to think critically. Especially during the Allied post-war trials, these two factors necessarily led to an extensive undermining of those marginal conditions of any state under the rule of law which are indispensable to the determination of truth. The verdicts handed down by the International Military Tribunal and in the related other trials set the historical norm which no one questioned even in Federal German courts until quite recently. In other words, self-evidentness practically came into existence as early as 1946, and Federal German courts have sought ever since to reinforce this view of history unquestioningly without encountering opposition from any quarter. And what is more: the mental climate prevailing in Germany as well as everywhere else in the world, molded by the story of the Holocaust, inhibited any doubts, even nipped them in the bud with methods which it is quite fair to compare with the violent attacks employed against Professor Nolte, as described previously.<sup>74</sup>

Of course all this does not necessarily mean that the thousands of eyewitness reports and confessions regarding the Holocaust are false. But our justice system knows from centuries of experience that eyewitness testimony is the least valuable evidence, being the most unreliable kind. Therefore it

---

<sup>74</sup> Professor Robert Faurisson, for example – the revisionist known the world over – was physically attacked ten times, four of which times he was injured severely and once even near-fatally. Not to mention the many ruinous trials which invariably end in convictions (fines and imprisonment), the professional dismissals and the revocations of academic degrees to which revisionists everywhere must submit. For a summary of the anti-revisionist oppression cf. R.-J. Eibicht, *op. cit.* (note 63), and R. Hepp, *op. cit.* (note 9). In early 1998 this book was confiscated in Germany because of an endnote written in Latin (!!!), in which the author expressed his doubt about the general excepted version regarding the NS gas chambers. Cf. DGG, “*Lateinischer Satz quält Staatsanwälte. Neue Grotteske der Political Correctness*”, *Deutschland in Geschichte und Gegenwart* 46(2) (1998), pp. 13f.; (online: [vho.org/D/DGG/DGG46\\_2.html](http://vho.org/D/DGG/DGG46_2.html)) *VffG* 2(1) (1998), p. 1, 81.

must not be forbidden under any circumstances to seek or to demand other, better evidence before accepting a certain view of history as correct.

That there is also more than a little wrong with eyewitness testimony where content is concerned is easily proven by a critical examination of these witness statements. Köhler shows that Revisionists have been doing this for decades, so that we will dispense with a comprehensive study in the present volume even though much research is certainly still needed in this area before all testimony has been adequately assessed. A vitally important subsection of such testimony, however, will be discussed in detail – namely, the witnesses, *i.e.*, their testimony regarding the gassing of human beings in the alleged execution gas chambers of Auschwitz and Birkenau. Professor Faurisson has specialized his studies on this problem for some time already, for this is the heart of the Holocaust story. The results of an analysis of the pertinent testimony, however, is shocking: as soon as the alleged eyewitnesses are questioned more closely, for example in cross-examination in a courtroom, they fall apart entirely. What remains is a mere skeleton of all the testimony, which a Canadian court has credited with the quality of a work of fiction at best – or perhaps even the quality of a fairy-tale? A more recent study by the author of this article shows a similar result: In an interview with a former SS-man of Auschwitz he could establish that accounts of eyewitnesses 50 years after the end of the war are inconsistent, mixed up with rumors, biased due to media impressions, incongruent with reality and therefore absolutely unreliable.<sup>75</sup>

Subsequently we are shown the trial of an alleged National Socialist criminal, from the perspective of the friends of the accused's family. To date the literature about the Federal German trials of alleged National Socialist criminals has been written almost exclusively from the perspective of prosecutors and judges; only Laternser has reported from the position of the defense.<sup>76</sup> The accused themselves, or their relatives and friends, have never yet been able to tell how such a trial appears from their side of things.<sup>77</sup> The report included here represents the first step towards rectifying this deficit. It is admittedly subjective in its approach, but in light of the enormous preponderance of no less subjective portrayals by judges and prosecutors it is no more than a necessary corrective to be welcomed in a pluralistic society.<sup>78</sup> If one accepts as correct the facts brought to light by Claus Jordan in his years-long, self-sacrificing struggle for fair treatment for the accused Gottfried Weise – as one will have to do until and unless these facts are disproved – then one can but hope that the tragic miscarriage of justice which resulted in an innocent old man being sentenced to imprisonment for life is an isolated case. Like almost all other verdicts in trials of National Socialist crimes, the verdict of life imprisonment handed down against Weise is based primarily on the testimony of witnesses for the prosecution, who – as Claus Jordan proves – were mistaken, at the least.

Unfortunately, the actions of Federal German – as they are graphically demonstrated by Manfred Köhler and borne out by the experiences of many defense counsels in such trials – allow only the opposite conclusion, namely that the trial of Gottfried Weise is nothing short of a model for thousands of other cases. Only the facts that Herr Weise had many courageous friends who helped him every minute of their spare time and that his trial continued into a time where new evidence has

---

<sup>75</sup> G. Rudolf, "Auschwitz-Kronzeuge Dr. Hans Münch im Gespräch", *VffG* 3(1) (1997) p. 139-190 (online: [vho.org/VffG/1997/3/RudMue3.html](http://vho.org/VffG/1997/3/RudMue3.html)).

<sup>76</sup> H. Laternser, *Die andere Seite im Auschwitzprozeß 1963/65*, Seewald, Stuttgart 1966.

<sup>77</sup> Aside from the trial reports about Weise (R. Gerhard (ed.), *Der Fall Gottfried Weise*, 2<sup>nd</sup> ed., Türmer, Berg 1991), and aside from a few at times polemical publications, such as Deutscher Rechtsschutzkreis (ed.), *Zur Problematik der Prozesse um "Nationalsozialistische Gewaltverbrechen"*, Schriftenreihe zur Geschichte und Entwicklung des Rechts im politischen Bereich, issue 3, Bochum 1982; G. Stübiger, *Der Schwammerbergerprozeß in Stuttgart*, *ibid.*, issue 4, May 1992.

<sup>78</sup> Also J. Tüchel's opinion in J. Weber and P. Steinbach (eds.), *Vergangenheitsbewältigung durch Strafverfahren?*, Olzog, Munich 1984, p. 141f.

come to light through the opening of many Eastern Bloc archives as well as through the advanced researches of historians, among which Revisionists number not a few – only these facts render this case different from the others. However, our hope that the requested retrial would end like the trial of Demjanjuk did,<sup>79</sup> namely with an acquittal, was disappointed. Gottfried Weise was released from jail in April 1997 on behalf of mercy (he was severely ill), and died in early 2000.

## 7. Six Million Jews are Missing, So Who Cares About Details?

### Or: Even One Victim is One Too Many

Once the first hurdle in a discussion with Johny Doe has been taken – in other words, once a realization of the inadequacy of eyewitness testimony has been achieved and understanding gained for the fact that a charge as horrendous as that of the destruction of the European Jews requires supplemental and better evidence – the question usually crops up whether it is even appropriate to quibble about details of this destruction and its provability, since after all the disappearance of six million Jews during the Second World War is an undeniable fact.

Examining the literature which discusses the statistics of Jewish losses during World War II, one soon finds that there are only two detailed works on this topic: the revisionist publication *The Dissolution of the Eastern European Jewry* by Walter N. Sanning (1983)<sup>80</sup> and the 1991 compilation edited by Wolfgang Benz, *Dimension des Völkermords*.<sup>81</sup> Whereas Sanning's work places the number of unexplained losses of European Jews at about 300,000, Benz's findings agree with the beliefs of the status quo and cite a loss of approximately six million. The contradiction between the two works is clearly apparent and undeniable, and hence a comparison is imperative.

It is interesting to note that it was once again the Revisionists who were the first to present a study regarding a central aspect of the Holocaust.<sup>82</sup> Even though the work by Wolfgang Benz was clearly a reaction to the revisionist book, Nolte's observation regarding the treatment that the establishment historians accord the Revisionists also applies in this instance: they are either hushed up or defamed. At no point in Benz's book is there any objective discussion of the arguments presented by Sanning. It only remains, therefore, to compare the two works in terms of the data they present and to assess the relative merits of the authors. The results of this comparison, as they are presented by me in this volume, are, first of all, that the two works give completely different definitions of what constitutes a victim of the Holocaust. While Sanning sums up only those victims who died as a result of direct measures taken in the course of a National Socialist policy of destruction, Benz credits all European Jewish casualties to the Holocaust, *i.e.*, including those Jews who died in the service of the Red Army, those who fell victim to Soviet deportation and forced-labor camps, and those population decreases resulting from the rise in natural mortality rates, religious conversion, etc.

What is more important, however, is the fact that Benz gives no attention to the matter of population migrations during and after the Second World War. But this is the core of our statistical investigation. Benz simply ignores the emigration of the Jews from Europe that has become known as another Exodus and which began prior to World War II, was largely interrupted in 1941 and reached its high point between 1945 and 1947. Benz also largely disregards the migrations of the Jews in eastern Europe, as well as the questions of how many Polish Jews managed to escape from the German army and how great a number of Jews was deported by the Soviets in 1941 and 1942.

---

<sup>79</sup> See A. Neumaier's contribution for that.

<sup>80</sup> W. N. Sanning, *The Dissolution of the Eastern European Jewry*, Institute for Historical Review, Newport Beach, CA 1983; German: *Die Auflösung des osteuropäischen Judentums*, Grabert, Tübingen 1983.

<sup>81</sup> W. Benz (ed.), *Dimension des Völkermords*, Oldenbourg, Munich 1991.

<sup>82</sup> The revisionists also acted as pioneers in terms of expert criticism of testimony and documents as well as in the call for and provision of material evidence.

These are points where Sanning's survey shines with a wealth of documentation, so that one cannot avoid the impression that Benz, not knowing with what to counter Sanning, simply jettisoned the uncomfortable topic.

Of course this does not answer the question: Which of these two works comes closer to the historical truth? This decision is left to the reader, since far more detailed research is needed before anything can be stated with certainty where the touchy subject of Jewish world population statistics is concerned. An example may serve to clarify: whereas David B. Barrett, a missionary statistician working in the United States, asserted for many years that the number of people professing the Jewish faith stagnates at some 18 million worldwide,<sup>83</sup> – a figure strikingly similar to pre-war figures – the *American Jewish Yearbook* had given the number of Jews worldwide as being static at only 14 million as early as 1979.<sup>84</sup> After an intervention of the statisticians of the *American Jewish Yearbook* in 1994, Barrett reduced his number of worldwide Jewish population down to just under 13.5 million.<sup>85</sup> The reason for this reduction is that the responsible editors of the *American Jewish Yearbook* do not accept Jews of different race such as Jews with black skin or Indian Jews, whose communities include several hundred thousand members.<sup>86</sup> Whoever approaches population statistics with such different and – regarding the statisticians of the *American Jewish Yearbook* – arbitrary methods, must be questioned if his goal is to deceive the public rather than to inform it.

Already we are confronted with the next objection: it really doesn't matter how many Jews lost their lives in the German sphere of influence, through whatever circumstances, because even one victim is one too many.

Doubtless it is correct that even one is one too many, and really one must go even farther than that: even those measures of Third Reich persecution which did not result in outright deaths were in every respect unacceptable. But this is not a valid argument against the statistical investigation of the 'whether' and 'how' of the destruction of the Jews, and for three reasons.

First of all, this objection does not satisfy simply for the reason that it is precisely the number of victims that has been considered sacrosanct for decades. If the number of victims did not matter, it would not be necessary to protect it as a social and even criminal taboo. Evidently there really is more to the six-million figure than merely the fact that it includes a great many individual fates: what is at stake is a symbol not to be easily relinquished, since justified doubts about the number might quickly lead to further undesirable skepticism about further subsections of the Holocaust complex. While not wishing to deny the victims the tragedy of their individual fates in any way, science must nevertheless insist that numbers must always be open to discussion. It is downright irrational that those, on the one hand, who doubt the six-million figure are socially persecuted or even subjected to criminal litigation while society and the justice system, on the other hand, react to valid arguments against this selfsame six-million figure by suddenly declaring this figure to be irrelevant and insisting instead on the dignity of even the very first victim. Is the six-million figure a standard deserving of protection by criminal law, or is it irrelevant? It cannot be both at once.

Secondly – and this is the most important argument – the ethically correct evaluation that even one victim would be too many must not be a pretext for prohibiting scientific research. This is intolerable for the simple reason that science must always be allowed to find precise answers. What would we think of an official who demanded that a physicist not be allowed to determine the exact

---

<sup>83</sup> In: *Britannica Book of the Year*, Encycl. Brit. Inc., Chicago, edition 1986: 18,0 Mio; 1987: 18,1 Mio; 1988: 18,2 Mio.; 1989: 17,4 Mio.; 1990: 17,4 Mio.; 1991: 17,6 Mio.; 1992: 17,8 Mio.; 1993: 18,2 Mio.; numbers rounded up; cf. *Junge Freiheit*, April 1, 1994, p. 4.

<sup>84</sup> *American Jewish Yearbook*, New York 1980, vol. 81, pp. 285-289; cf. W.N. Sanning, *op. cit.* (note 80), p. 272.

<sup>85</sup> In: *Britannica Book of the Year*, Encycl. Brit. Inc., Chicago, editions 1994f.

<sup>86</sup> Explanation of Prof. D. Barrett from *Global Evangelization Movement* at Regent University in Richmond, VA 23230, USA, in a letter to E. Heer, July 5, 1995.

value of his stress experiment, because even a small value would be bad enough? A physicist subjected to such an absurd demand would quickly arrive at incorrect results and would be a threat to any company that hired him. The same holds true for the historian. If the historian is forbidden to conduct critical investigations because they might be considered morally untenable, then we have to assume that the results of such skewed historiography are unreliable. And since our knowledge of contemporary history exerts a direct influence on politics, our public policies are mistaken and unreliable as well. It is the key function and responsibility of every branch of science to provide accurate figures and values. The principles which hold true for engineering, physics, and chemistry can not suddenly be abandoned in historiography for political reasons – unless one is intellectually prepared to retreat deep into the darkest middle ages.

Thirdly and finally, the morally correct view that even one victim is one too many cannot on principle be a barrier to the scientific investigation of a crime which is generally called so morally reprehensible as to be unique and unparalleled in the history of mankind.<sup>87</sup> An allegedly uniquely reprehensible crime must be open to a procedure that is standard for any other crime as well, namely that it is – and must be – investigated in detail. I would go even further: anyone who postulates a crime to be unique must be prepared for an uniquely thorough investigation of the alleged crime before its uniqueness is accepted as fact. If a person or group blocks investigation of an allegedly unique crime on grounds of moral outrage, then that person or group is guilty of a unique crime itself. This unique crime consists of first denying defense against preposterous allegations, then disallowing criticism of such tyrannical methods on a pretext of unusual guilt. This was the precise fate of Germany following World War II, with the result that Germans were first brutalized, then slandered and denied opportunity to defend themselves. The treatment of vanquished Germany by the victorious Allies has been truly unique in modern times, since the same Allies otherwise allow even the most notorious murderers opportunity to defend themselves in court.

## 8. Largely Uncontested Matters of National Socialist Injustice

In discussing the postulated murder of the Jews, the historians of the *status quo* identify the technical and organizational origins of this mass murder as to be found in the program of euthanasia which was enforced as of the beginning of the war – the killing of so-called ‘life not worthy of life’, in other words, mentally and/or physically severely disabled people. The reason for this assumption is the considerable overlap, *i.e.*, continuity of staff in both areas.<sup>88</sup> However, it seems to me a very dubious practice to attempt to construe this continuity as evidence for the mass murder, since it may very well mean only that the leadership had wished to retain staff which had previously proven loyal in one socially extremely controversial operation, for a subsequent, no less controversial purpose. And whether this controversial purpose was the resettlement, ghettoization, or mass murder of the Jews, is still an open question.

To the best of my knowledge there have been no doubts advanced by the revisionist side regarding the factuality of those killings effected within the scope of euthanasia; these killings number some 100,000.<sup>89</sup> The moral assessment of such an elimination of totally incapacitated persons is a differ-

<sup>87</sup> By E. Nolte as well, by the way, even if the opposite has occasionally been alleged; cf. *Der europäische Bürgerkrieg 1917-1945, op. cit.* (note 11), p. 516; *Streitpunkte, op. cit.* (note 12), Section II. 5., p. 381ff., also p. 421ff.

<sup>88</sup> For example, cf. G. Sereny, *Am Abgrund*, Ullstein, Frankfurt am Main/Berlin 1979; K. A. Schleunes, in E. Jäckel and J. Rohwer (eds.), *Der Mord an den Juden im Zweiten Weltkrieg*, Deutsche Verlags-Anstalt, Stuttgart 1985, p. 70ff., esp. p. 78.

<sup>89</sup> Cf. K. Dörer, *Vierteljahrshefte für Zeitgeschichte (VfZ)* 15 (1967) p. 121-152; L. Gruchmann, *VfZ* 20 (1972) p. 235-279; H.-W. Schmuhl, in M. Prinz and R. Zitelmann, *Nationalsozialismus und Modernisierung*, Wissenschaftliche Buchgesellschaft, Darmstadt 1991, p. 239-266.



ent matter. In the western democracies in particular, this topic was the subject of much controversial discussion and in some cases was even practiced right until the end of the war,<sup>90</sup> and only recently the question whether passively and actively assisted suicide should be expanded, in severe cases, to include euthanasia as well, has once again taken center stage.<sup>91</sup> Far be it from me, a non-specialist, to advance an opinion of my own on this explosive topic. Like Nolte,<sup>92</sup> however, I cannot help but remark in amazement that people today are morally outraged by the killing of 100,000 generally severely disabled persons for perhaps dubious reasons of ‘genetic public welfare’ during the 12 years of National Socialist dictatorship, whereas those same people are not shocked in the slightest by the willful murder of unborn, but healthy persons numbering some four million in the last 12 years in Germany alone – murders in most cases motivated solely by materialistic and egoistical considerations. Clearly the moral categories by which we judge today are completely different than those between 1933 and 1945 in Germany. I doubt that they are better.

But back to the supposed genocide of the Jews. Aside from some aspects of the so-called *Reichskristallnacht* of November 9, 1938,<sup>93</sup> the Revisionists and the historians of the establishment do not differ very much in their accounts of the various stages of National Socialist persecution of the Jews up to the alleged start of an extermination in the summer of 1941 – although there are occasional differences in the accounts of specifics regarding the extent and the intentions behind individual measures: exclusion from professions, dismissals, ‘Aryanization’ of commercial enterprises, freezing of assets, forced labor, expulsion, *i.e.*, resettlement into ghettos, confiscation of property and assets, identification with the Star of David, rationing of food, and deportation to transit and concentration camps.<sup>94</sup> The Revisionists, of course, also accept that negligence, at the least, cost thousands of Jews their lives especially in the context of deportation, ghettoization and forced labor. But even the question whether there were also deliberate murders of Jews due solely to their different faith has no consensus among the Revisionists; personally I consider these murders as given, but cannot

---

<sup>90</sup> See Dietrich Bronder, *op. cit.* (note 4), pp. 312-323; cf. also André N. Sofair, Lauris C. Kaldjian, »*Eugenic Sterilization and a Qualified Nazi Analogy: The United States and Germany, 1930-1945*«, *Annals of Internal Medicine*, 132 (Feb. 15, 2000), pp. 312-319.

<sup>91</sup> The starting point for this more recent debate was the comparison of human euthanasia with the practice of mercy-killing of animals; cf. the British author Peter Singer’s book *Practical Ethics*, Cambridge UP, Cambridge 1979, esp. p. 127f (p. 175f. in 2<sup>nd</sup> ed., 1993). Only recently a German translation of a British book supporting the principle of euthanasia was cancelled by a northern German publisher due to massive public pressure; cf. Ch. Anstötz *et al.*, *op. cit.* (note 28).

<sup>92</sup> E. Nolte, *op. cit.* (note 12), p. 285.

<sup>93</sup> For the position taken by the establishment, cf. H. Graml, *Der 9. November 1938. “Reichskristallnacht”*, 4<sup>th</sup> ed., Schriftenreihe der Bundeszentrale für Heimatdienst, Heft 4, Bundeszentrale für Heimatdienst, Bonn 1956; H. Lauber, *Judenpogrom “Reichskristallnacht” November 1938 in Großdeutschland*, Bleicher, Gerlingen 1981; for an older revisionist position, cf. I. Weckert, *Flashpoint: Kristallnacht 1938 – Instigators, Victims and Beneficiaries*, Institute for Historical Review, Newport Beach, CA 1991, who doesn’t believe the NS-government was the instigator (online in German: [vho.org/D/Feuerzeichen](http://vho.org/D/Feuerzeichen)). Contrary to this thesis are the entries in Goebbels Diary, cf. D. Irving, *Die geheimen Tagebücher. Der unbekannt Dr. Goebbels*, Focal Point, London 1995, esp. pp. 407-411; Irving, *Goebbels. Mastermind of the Third Reich*, *ibid.*, 1996. However, some research still has to be done regarding the authenticity of these documents, see, e.g., I. Weckert, “*Dr. Joseph Goebbels und die ‘Kristallnacht’*”, *VffG* 5(2) (2001), pp. 196-203 (online: [vho.org/VffG/2001/2/Weckert196-203.html](http://vho.org/VffG/2001/2/Weckert196-203.html)). With regard to Hitler’s reactions, he must have agreed with this pogrom, and its results must have been too mild in his eyes, since he prevented the German insurances to pay any compensations to the Jews and forced the German Jews to pay an additional fine of 1 billion (!) Reichsmark. This *post facto* behavior alone explains enough.

<sup>94</sup> As an example, cf. the accounts given in the standard work of Holocaust history by R. Hilberg, *The Destruction of the European Jews*, Quadrangle Books, Chicago 1961; 2<sup>nd</sup> ed., Holmes & Meier, New York 1985.

comment on their extent or whether they were approved or even decreed from higher-up, due to lack of evidence.<sup>95</sup>

Even where the National Socialists' plans regarding the future of the Jews in their sphere of influence up to mid-1941 are concerned, there certainly are similarities in the views held by the Revisionist and the so-called functionalist school of historians. In light of the actual policies of the National Socialists, M. Broszat pointed out in 1977 that, aside from verbal threats on Hitler's part, there is no evidence in political events until mid-1941 for any National Socialist plans for extermination. Rather, documents as well as the actual results of Hitler's policies proved that until October and November 1941 all measures were aimed at removing the Jews from the German sphere of influence by means of resettlement.<sup>96</sup> In this respect, the contemporaneous documents which mention evacuation, deportation, resettlement etc. of the Jews are in no way examples of a 'code' language; they simply say exactly what they mean. This view was recently supported by Jerusalem historian Yehuda Bauer.<sup>97</sup>

So let us consider this part of the National Socialist injustice towards the Jews, on which Revisionists and exterminationists agree, in the light of the legal definition of genocide of post-war legislation – which is defined in the current German Criminal Code as follows:

“§220a. *Genocide. Anyone who, in the intent to completely or partially destroy a national, racial, religious or ethnic group per se,*

1. *kills members of said group,*

2. *inflicts [...] severe physical or mental harm on members of said group,*

3. *subjects said group to living conditions suited to bringing about its complete or partial physical destruction,*

4. *institutes measures designed to prevent births within said group, [...]*

*shall be punished with imprisonment for life.”*

Accepting this definition, one could indeed consider that the crime of genocide would exist even without a planned, industrial-style mass extermination of the Jews, especially through poison gas and mass executions. Revisionists do not deny that the National Socialist regime deliberately, or at least through gross negligence, subjected the Jews in its sphere of influence to conditions which, in part, inflicted severe physical and mental harm, resulted in part in their physical destruction, and caused a deliberate reduction in their birth rate through the segregation of the sexes. Certainly, there is an argument between Revisionists about to what extent the government of the Reich was aware of the conditions in the concentration camps and ghettos, to what degree it approved them, failed to adequately improve them, or perhaps even promoted them, all of which would affect the judicial valuation of the National Socialist measures against the Jews. But these interesting and important questions are beyond the scope of this volume. I am sure that a lot of research still has to be done in that field.

<sup>95</sup> Cf more recently: Germar Rudolf, Sibylle Schröder “*Partisanenkrieg und Repressaltötungen*”, *VffG*, 3(2) (1999), pp. 145-153 (online: [vho.org/VffG/1999/2/RudolfSchroeder145-153.html](http://vho.org/VffG/1999/2/RudolfSchroeder145-153.html)), which is an updated and enhanced version of my introduction to Prof. Siegert's article in this volume.

<sup>96</sup> M. Broszat, *VfZ* 25 (1977) pp. 739-775, esp. pp. 748ff., in response to D. Irving, *Hitler's War*, Hodder & Stoughton, London 1977; for the intentionalist school of thought which claims that Hitler cherished plans for mass murder from the start, see for ex. C. Browning, *VfZ* 29 (1981) pp. 97-109; also E. Goldhagen, *VfZ* 24 (1976) pp. 379-405; and recently: S. Friedländer, *Nazi Germany and the Jews*, v. 1: *The Years of Persecution*, Harper & Collins, New York 1997; for a discussion of the decision-making process, cf. E. Jäckel and J. Rohwer (eds.), *op. cit.* (note 88); cf. also S. Goshen, in *Zeitgeschichte* (Vienna), 14 (1986/87), p. 221-243.

<sup>97</sup> Y. Bauer, *Jews for Sale?*, Yale University Press, New Haven 1994.

But even if points 2. to 4. of above quoted §220a would apply, could the National Socialist government have been punished for this after the war? The above definitions of genocide under points 2. to 4. were introduced into the German Penalty Law and accepted internationally only a few years after the end of WWII. This means: it was not considered a crime until after the final defeat of the Third Reich. And since in a state under the rule of law nobody can be punished due to a law made *ex post facto*, Hitler and his comrades could not have been punished under this law, but only under then existing laws, a fact which rendered actual German post-war trials in such cases somewhat clumsy. Additionally one must consider that the leaders of the victorious powers made sure that they could not be punished for similar or even worse crimes: post-war treaties with Germany have determined that no citizen of the allied nations can be prosecuted by German authorities, and amnesty declarations set an end to any prosecution in many countries. Thus, neither Stalin nor Roosevelt, neither Churchill nor Tito, neither de Gaulle nor Edward Beneš and their millions of “*willing executioners*” could have been punished for the genocides they committed against the German people during the war (by air raids) and mainly after the war (‘ethnic cleansing’ of eastern Europe, POW camps, GULag). Subsequently, the genocide against the German people, perhaps the biggest genocide in the history of mankind, is nearly forgotten.<sup>98</sup> Under this perspective, the entire ‘Nazi’-witch-hunt, which has lasted more than 50 years, is nothing more than a gigantic hypocrisy.

Thus, even if one cannot doubt the National Socialist’s persecution of the Jews in principal, doubts about subsections of this topic must be permissible, such as individual killing measures or higher-up intentions, plans and orders to implement mass murder.

## 9. Of Documents Ignored to Date, or Accepted Without Question

In the functionalists’ opinion, it was not until mid- to late 1941, when the German war situation had become desperate and it had proven impossible to expel the Jews from Europe, that the National Socialists resorted to murdering the Jews. This is where revisionist criticism comes in, as documentary evidence for this theory is more than scarce or even indicates that the opposite is true. Arthur Butz has shown how the authorities of all major powers during WWII, including the western Allies, the Vatican, the Red Cross, Jewish organizations as well as resistance fighters in occupied eastern Europe, acted throughout the war as if they *knew* that the Jews were *not* exterminated.<sup>99</sup> Carlo Mattogno has pointed out that the series of documents that emanated from high German governmental authorities and reported about evacuations, deportations, resettlements etc., by no means broke off even after November 1941.<sup>100</sup> On the other hand, not a single bureaucratic document exists dealing with the summary extermination of Jews, specifically no order signed by Hitler which

---

<sup>98</sup> Though it may not be the biggest mass murder of the history of mankind, because communism certainly has killed more people since 1917 in Russia as well as in China, and even the mass murder against the Indians in America or the victims of the slave trade may exceed the number of killed Germans. But in none of these cases has there been a plan of ‘ethnically cleansing’ America from the Indians, Africa from the Blacks, China from the Chinese or Russia from the Russians. Perhaps the famine of the Ukraine in the 30’s may be considered a genocide comparable to German losses in and after WWII; cf. R. Conquest, *The Harvest of Sorrow*, Oxford University Press, Oxford / New York 1986.

<sup>99</sup> Arthur R. Butz, “*Context and Perspective in the ‘Holocaust’ Controversy*”, *JHR* 3(4) (1982), pp. 371-405 (online: [vho.org/GB/Journals/JHR/3/4/Butz371-405.html](http://vho.org/GB/Journals/JHR/3/4/Butz371-405.html)).

<sup>100</sup> Carlo Mattogno, “*Le Mythe de l’extermination des juifs*”, *Annales d’Histoire Révisionniste (AHR)* 1 (1987) pp. 15-107 (online: [abbc.com/aaargh/fran/archVT/AHR/AHR1/Mattogno/CMexterm1.html](http://abbc.com/aaargh/fran/archVT/AHR/AHR1/Mattogno/CMexterm1.html)), esp. 41ff.; English: “*The myth of the extermination of the Jews: Part I*”, *JHR* 8(2) (1988) p. 133-172 (online: [vho.org/GB/Journals/JHR/8/2/Mattogno133-172.html](http://vho.org/GB/Journals/JHR/8/2/Mattogno133-172.html)); part II: *JHR* 8(3) (1988) p. 261-302 (online: [.../3/Mattogno261-302.html](http://.../3/Mattogno261-302.html)). For a detailed discussion, see C. Mattogno, *La Soluzione Finale: Probleme e polemica*, Edizioni di Ar, Padova 1991.

states the like.<sup>101</sup> Attempts to explain this fact relate it to the strict secrecy surrounding this mass murder; in other words, the supposed criminals avoided creating, or carefully saw to the destruction of any documentary evidence.<sup>102</sup> If one tried to reconstruct the Holocaust story only on the basis of documents, one would have to assume that as of autumn 1941 the documents no longer really mean what they say and that at about this time a code language came into effect in whose terminology formerly innocuous words, like ‘resettlement’ and ‘special treatment’, meant ‘murder’. This is exactly the interpretation of today’s historians and has found the ultimate expression in the book by E. Kogon, H. Langbein and A. Rückerl, where the section “*Unmasking the Code Terms*” enlightens the reader to the effect that he can only understand the documents correctly if he interprets them as saying something other than what they actually say.<sup>103</sup>

Now it may well be that in many cases terms such as ‘special treatment’ were demonstrably used as euphemisms for an execution.<sup>104</sup> On the other hand, it is also true that this was not always the case. Rather, the term included many different measures, for example disinfection and quarantine, punishments as well as preferential treatments of all kinds, and much more.<sup>105</sup> It is thus impossible to use a number of proven cases as basis for a generalization about all those other cases that have not been cleared up to date. Such a practice would require genuine documents giving guidelines for the general use of a code language, *i.e.*, the exact definition of the terms to be used.<sup>106</sup> However, no such key has ever yet been found. After all, one must wonder how the recipients of coded orders would know when to take the wording of an order literally and when to go against it, and in which way – and all this in light of the fact that acting against orders carried at times very severe punishments in the Third Reich. This point of utmost significance was recently raised by this author,<sup>107</sup> but as is the norm in matters of factual revisionist questions, the opposing side completely ignored this point in their reply.<sup>108</sup> However, the establishment’s view of history, based as it is on the anti-literal interpretation of these documents, stands or falls with the answer to this question. While the issue

<sup>101</sup> C. Cross, *Adolf Hitler*, Hodder & Stoughton, London 1973, p. 313; J.C. Fest, *Hitler*, Vintage Books, New York 1975, p. 681; S. Friedländer, in *Colloque de l’Ecole des Hautes Etudes en sciences sociales* (ed.), *L’Allemagne nazie et le genocide juif*, Gallimard and Le Seuil, Paris 1985, pp. 177f.; D. Irving, *Hitler’s War*, Focal Point, London 1991, p. 19f.; W. Laqueur, *Was niemand wissen wollte: Die Unterdrückung der Nachrichten über Hitlers Endlösung*, Berlin-Vienna 1981, p. 190; J.J. Martin, *The Man who invented “Genocide”: The Public Career and Consequences of Raphael Lemkin*, Institute for Historical Review, Torrance 1984, p. 40; A.J. Mayer, *Why did the Heavens not Darken? The “Final Solution” in History*, Pantheon Books, New York 1990, p. 235f.; J. Noakes, G. Pridham (ed.), *Nazism: A History in Documents and Eyewitness accounts 1919-1945*, vol. 2, Schocken Books, New York 1988, p. 1136; L. Poliakov, *Breviaire de la haine*, Calmann-Lévy, Paris 1979, p. 134; W. Shirer, *The Rise and Fall of the Third Reich*, Fawcett Crest, New York 1960, p. 1256; C. Zentner, *Adolf Hitler*, Mein Kampf, Delphin, Munich 1979, p. 168.

<sup>102</sup> Aside from M. Broszat, *op. cit.* (note 96), cf. also W. Scheffler, in *Aus Politik und Zeitgeschichte*, 32(43) (1982) p. 3-10.

<sup>103</sup> E. Kogon, H. Langbein, A. Rückerl *et al.* (eds.), *Nationalsozialistische Massentötungen durch Giftgas*, Fischer Taschenbuch, Frankfurt am Main 1985, Section II.

<sup>104</sup> Cf. for this additionally to E. Kogon *et al.*, *ibid.*: Joseph Wulf, *Aus dem Lexikon der Mörder. “Sonderbehandlung” und verwandte Worte in nationalsozialistischen Dokumenten*, S. Mohn, Gütersloh 1963; both books have obviously selected only those documents which support their thesis. A more discriminating publication needs to be compiled.

<sup>105</sup> See the examples quoted by A. R. Butz, *The Hoax of the Twentieth Century: The Case Against the Presumed Extermination of European Jewry*, Institute for Historical Review, Torrance, CA 1985, pp. 112ff.

<sup>106</sup> A document frequently quoted to be such a definition is IMT doc. 3040-PS, from *Allgemeine Erlaßsammlung* (general compendium of decrees) (AES), part 2, A III f (Treatment of foreign civilian workers), issued by the RSHA. It includes regulations for the punishment of foreign civilian workers in case of severe criminal offenses (including “*Sonderbehandlung*” as capital punishment which “*takes place by hanging*”). However, this can not be applied automatically to all other cases, and certainly not to Jews being deported to ghettos and concentration camps.

<sup>107</sup> *DIE ZEIT lügt!*, Remer-Heipke, Bad Kissingen 1992, p. 18f. (as authors of this brochure appear H. K. Westphal, W. Kretschmer, C. Konrad, R. Scholz, which are pseudonyms of the author, cf. online: [vho.org/D/Beitraege/Zeit.html](http://vho.org/D/Beitraege/Zeit.html)).

<sup>108</sup> T. Bastian, *Auschwitz und die “Auschwitz-Lüge”. Massenmord und Geschichtsfälschung*, Beck, Munich 1994.

represents a gap in historical research which it is beyond the scope of the present volume to fill, a group of revisionist researchers is currently working on this problem.<sup>109</sup>

Of course there are also other documents and subsections of the Holocaust complex which the historians of the establishment believe provide evidence for the entirety of the postulated extermination of the Jews. There have been many revisionist critiques of these arguments,<sup>110</sup> so that this handbook will give only a few examples. What is most astonishing in this context is that the establishment historians almost entirely neglect their most important task – the factual criticism of the documents on which they base their view of history. The unquestioning acceptance of any and all documents which may incriminate Germany is a common phenomenon, a scandal, which reached its high point in the scandal of the forged Hitler diaries – a scandal which was only exposed through the contribution of a foreigner, namely David Irving, who has since become fully revisionist in his views.

Historians should take general warning from the fact that the Allies and their accessories found every conceivable means for forgery at their disposal after the war – original letterhead stationery, typewriters, rubber stamps, printing presses etc. It is all the more amazing to see how credulous and naive today's historians – mostly Germans, but others as well – are in their approach to supposed documents of those days.<sup>111</sup>

Almost every one of the authors contributing to the present handbook encountered, in the course of his or her chapter, the need for critical analysis of a wide range of documents which cannot all be enumerated here, so that I will restrict myself to a brief introduction of those chapters dealing almost exclusively with document criticism. The voluminous revisionist critiques of the so-called 'Wannsee Conference Protocol' is one of the foremost examples which – symptomatic of many other topics – has been completely ignored by historians of the establishment to date. Only E. Nolte pointed out as early as 1987 that there are doubts as to the authenticity of the protocol.<sup>112</sup> Since the establishment seems to have been unable to come up with anything by way of reply to the many and varied arguments of the Revisionists – summarized in the German edition of this book by Johannes Peter Ney<sup>113</sup> – it appears that this 'document' is quite clearly a forgery, and of no value whatsoever as documentation for any possible plans for extermination on the part of the government of the German Reich.

<sup>109</sup> First results were published by W. Stromberger, "Was war die 'Sonderbehandlung' in Auschwitz?", *DGG*, 44(2) (1996), pp. 24f (online: [vho.org/D/DGG/Strom44\\_2.html](http://vho.org/D/DGG/Strom44_2.html)); cf. also Carlo Mattogno, "'Sonderbehandlung' and Crematory II" (currently online only: [www.russgranata.com/sonder.html](http://www.russgranata.com/sonder.html)). Carlo Mattogno, "Sonderbehandlung" *ad Auschwitz. Genesi e significato*, Edizioni di Ar, Padova 2001; (updated German and English editions will later appear by Castle Hill Publishers and Theses & Dissertations Press, respectively).

<sup>110</sup> For example, cf. A. R. Butz, *op. cit.* (note 105); W. Stäglich, *Der Auschwitz-Mythos*, Grabert, Tübingen 1979 (online: [vho.org/D/dam](http://vho.org/D/dam); Eng.: *The Auschwitz Myth: A Judge Looks at the Evidence*, Institute for Historical Review, Newport Beach, CA 1986; online: [codoh.com/trials/tristagintro.sht](http://codoh.com/trials/tristagintro.sht)); U. Walendy, *Historische Tatsachen*, Nos. 1 through 77, Verlag für Volkstum und Zeitgeschichtsforschung, Vlotho 1975-1997, the latter considered to be more a quarry for future research rather than a structured scientific series.

<sup>111</sup> As examples for today generally excepted forgeries: The Hitler-Diaries, Rauschnig's talks with Hitler (both: Karl Corino (ed.), *Gefälscht!*, Rowohlt, Reinbek 1992; cf. Eberhard Jäckel, A. Kuhn, H. Weiß, *VfZ* 32 (1984) pp. 163-169), Katyn (Franz Kadell, *Die Katyn Lüge*, Herbig, München 1991), SS-identity card of John Demjanjuk (D. Lehner, *Du sollst nicht falsch Zeugnis geben*, Vohwinckel, Berg o.J.).

<sup>112</sup> E. Nolte, *op. cit.* (note 11), p. 592; also cf. Nolte, *op. cit.* (note 12), p. 313f.

<sup>113</sup> Because of a veto by the author, we could not include an English translation of this article in this book; see instead online [vho.org/GB/Books/dth/fndwannsee.html](http://vho.org/GB/Books/dth/fndwannsee.html); see also: Hans Wahls, *Zur Authentizität des »Wannsee-Protokolls«*, Zeitgeschichtliche Forschungsstelle, Ingolstadt 1987; Roland Böhlinger, Johannes P. Ney, *Zur Frage der Echtheit des Wannsee-Protokolls*, 2<sup>nd</sup> ed., Verlag für ganzheitliche Forschung und Kultur, Viöl 1992, 1994; Roland Böhlinger (ed.), *Die Stellungnahme der Leitung der Gedenkstätte Haus der Wannsee-Konferenz zu dem von Böhlinger und Ney verfaßten Gutachten zur Frage der Echtheit des sogenannten Wannsee-Protokolls und der dazugehörigen Schriftstücke*, Verlag für ganzheitliche Forschung, Viöl 1995.

Another point, much more important, is the criticism Ingrid Weckert presents regarding the documents treating the alleged ordering, modification and use of the so-called gas vans in which, it is claimed, countless thousands of Jews were murdered by means of exhaust fumes. Here, too, the evidence and circumstantial proofs strongly indicate that the crucial ‘incriminating documents’ are forgeries. Ms. Weckert also discusses the credibility of the eyewitness testimony accompanying this topic.

Next, Udo Walendy examines the alleged visual documents – photographs – that are claimed to prove the atrocities perpetrated by the National Socialists against the Jews. The question at issue is what exactly the pictures show, whether they were retouched or whether they may even be completely fabricated, *i.e.*, montages or drawings. A pile of dead bodies or an open mass grave, for example, can be presented as evidence for the gas chamber murders, but what is there to prove that the pictures do not in fact show the German victims of Allied air-raids, or the victims of starvation or epidemics in German or Allied camps, soldiers killed in action, victims of pogroms, or even persons killed by the Soviet secret service? Udo Walendy discusses the criteria by which an altered or completely forged photo can be identified as such, and then shows, with some examples, that the falsification of photographs for purposes of incriminating the Third Reich is rather more the rule than the exception. It is astonishing to note that there are usually many different versions of a forged photograph, which makes it easy to spot cases of alteration. Proof of the common nature of such forgeries does not, of course, indicate anything one way or the other about the factuality of the crimes in whose support the faked photographs are cited, so that the criticism of photo documents cannot refute such claims. But really it should be the case that accusations must be proven with incontestable evidence before one must accept them as fact. The photo documents known to us, however, do not serve the purpose of incontestable evidence, even if the modern-day public and especially our magazine- and television-oriented consumer society likes to rashly accept them as proof, on the premise that ‘if I saw it with my own eyes, it must be true.’ What is commonly overlooked in this reasoning is that it is not only the eye that determines what one believes one has seen, but that, rather, certain associations with the pictures are responsible for the viewer’s interpretation of the context of the pictures. These associations are as a rule provided by accompanying text and commentary which, however, tend not to stand up to closer scrutiny.

There are also, of course, photo documents which have taken us a good step further in the investigation of the supposed Holocaust. These are the aerial photographs which were taken by German or Allied reconnaissance planes, in areas and at times where the alleged extermination of the Jews is purported to have taken place. In his chapter, professional air photo interpreter John Clive Ball presents the most important air photos of Treblinka, Babi Yar and Auschwitz-Birkenau and shows that the allegations of mass exterminations at these sites, while decreed to be correct by court verdicts, not only cannot be proven by the aerial photographs, but are even for the most part conclusively disproved by them. J. C. Ball’s work as well, even though it already dates from late 1992,<sup>114</sup> has yet to receive a single word of notice from the establishment historians. Once again, what is clearly irrefutable is simply ignored. A solitary exception is a former director at the federal *Militär-geschichtliche Forschungsamt*, based in Freiburg and Potsdam, who at least calls in doubt in his recently published book *Stalin’s War of Extermination 1941-1945* that the National Socialist committed a mass killing of Jews in Kyiv in 1941.<sup>115</sup>

---

<sup>114</sup> J. C. Ball, *Air Photo Evidence*, Ball Resource Services Ltd., Suite 160-7231, 120th Street, Delta, B.C., V4C 6P5, 1992 (online documents are available at: [www.air-photo.com/](http://www.air-photo.com/)).

<sup>115</sup> J. Hoffmann, *op. cit.*, (note 56), p. 214-219, cf. p. 334f. Michael Shermer discussed Ball’s claims by referring to things he was *told* by alleged air-photo experts! Michael Shermer, *Why People Believe Weird Things*, Freeman & Co. New York 1997; cf. Gernmar Rudolf, “*Das Rudolf Gutachten in der Kritik, Teil 2*”, *VffG* 3(1) (1999), pp. 77-82 (online: [vho.org/VffG/1999/1/RudDas1.html](http://vho.org/VffG/1999/1/RudDas1.html)). Even worse is Brigitte Bailer-Galanda, who simply distorts facts

While the greater part of the revisionist research presented here was generally aimed to attack and refute establishment notions – to be destructive, as it were – its future focus will no doubt shift to constructive research, *i.e.*, to resolving the questions of how things really were if traditional accounts are false. The predominantly destructive nature of revisionist research in the past decades was frequently the result of the fact that Revisionists, working as they were individually and with ridiculously meager financial means, and even under conditions of massive state repression, were dependent for their material on the crumbs that fell to them from the banquet tables of the establishment historians who enjoy worldwide organization and countless millions in state funding. This will change in the future, if only because access to archives is becoming ever easier in both the East and the West, and because the numbers of Revisionists as well as their means are increasing with their growing public acceptance. After all, once it has been proven that the view taken to date of this historical complex is not quite correct, it cannot but dawn even on state and academic circles that there is a need for new, constructive research and that new explanations must be sought and found.

Today we find ourselves right in the middle of the radical change-over from the desperate defense of the old, to the search for new approaches. While on the one hand much of the work of revision pertaining to the evidence on which historiography has been based to date has not yet been done – due to the dearth of qualified researchers with the will to revise, the means for its implementation and, most importantly, access to the evidence. Most Revisionists have already begun to work on new approaches. As early as 1991, for example, Steffen Werner postulated that even after 1941 there was a continued National Socialist emigration policy with respect to the Jews, which resulted in a massive Jewish settlement in White Russia and the Ukraine.<sup>116</sup> Once again, establishment historians do not see fit to even comment.<sup>117</sup> The documents from the Auschwitz Central Site Office of the Police and Waffen-SS, recently discovered in Prague, also provide completely new perspectives, showing that the German authorities invested tens of millions of *Reichsmark* in the construction of the Birkenau camp – which hardly indicates extermination to have been the purpose of this camp, but certainly does suggest that the complex was a straight-forward forced-labor camp.<sup>118</sup> Aside from these documents there are still extensive records to be gone through in the United States, in Moscow, Prague, Warsaw, Lublin and Auschwitz. Research into these archives has only been begun so far by such supporters of the extermination theory as G. Fleming<sup>119</sup> and J.-C. Pressac.<sup>120</sup> In their studies, however, these researchers only ever search for documents that might serve to strengthen the establishment position, and particularly the findings of Pressac are more than scant.<sup>121</sup> No estab-

---

without even trying to prove anything: Brigitte Bailer-Galanda, Wolfgang Benz, Wolfgang Neugebauer (eds.), *Wahrheit und Auschwitzlüge*, Deuticke, Vienna 1995, p. 25; see the critique of G. Rudolf, “Zur Kritik an ‘Wahrheit und Auschwitzlüge’”, in H. Verbeke (ed.), *Kardinalfragen zur Zeitgeschichte*, Vrij Historisch Onderzoek, Berchem 1996, p. 96 (online: [vho.org/D/Kardinal/Wahrheit.html](http://vho.org/D/Kardinal/Wahrheit.html); English: [vho.org/GB/Books/cq/critique.html](http://vho.org/GB/Books/cq/critique.html)).

<sup>116</sup> S. Werner, *Die 2. babylonische Gefangenschaft*, originally self-published by author, Pfullingen 1990; 2<sup>nd</sup> ed.

Grabert, Tübingen 1991 (online: [vho.org/D/d2bg/I\\_II.html](http://vho.org/D/d2bg/I_II.html); English: [vho.org/GB/Books/tsbc](http://vho.org/GB/Books/tsbc)).

<sup>117</sup> An exception is E. Nolte, once again, who mentions Werner’s theses but rejects them out of hand without giving any reason for this; *op. cit.* (note 12), p. 317.

<sup>118</sup> Cf. F. Freund, B. Perz, K. Stuhlpfarrer, in *Zeitgeschichte* (Vienna) 20 (1993/94) p. 187-214; cf. also B. Wegner, in *VfZ* 40 (1992) p. 311-319; cf. H.J. Nowak, “Kurzwellen-Entlausungsanlagen in Auschwitz”, *VffG* 2(2) (1998), pp. 87-105 (online: [vho.org/VffG/1998/2/Nowak2.html](http://vho.org/VffG/1998/2/Nowak2.html)), and his contribution in this handbook.

<sup>119</sup> G. Fleming, “Engineers of Death”, in *The New York Times*, July 18, 1993, p. E19; cf. F. Toben, “Ein KGB-Novellist: Gerald Fleming”, *VffG* 2(1) (1997) p. 87-91 (online: [vho.org/VffG/1997/2/Toben2.html](http://vho.org/VffG/1997/2/Toben2.html)).

<sup>120</sup> J.-C. Pressac, *Les Crématoires d’Auschwitz, la Machinerie du meurtre de masse*, CNRS, Paris 1993; Engl. only as a short and modified article, coauthored by R.-J. van Pelt, in Y. Gutman, M. Berenbaum (eds.), *Anatomy of the Auschwitz Death Camp*, Indiana University Press, Bloomington 1994.

<sup>121</sup> Cf. the corresponding critiques in A.N.E.C., R. Faurisson, S. Thion, P. Costa, *Nouvelle Vision* 31 (1993) p. 11-79; R. Faurisson, *Réponse à Jean-Claude Pressac*, R.H.R., Colombes Cedex 1994; H. Verbeke (ed.), *Auschwitz: Nackte Fakten*, Vrij Historisch Onderzoek, Berchem 1995 (online: [vho.org/D/anf](http://vho.org/D/anf); Engl.: [vho.org/GB/Books/anf](http://vho.org/GB/Books/anf)).

lishment researcher has ever gone through the enormous wealth of these archives with an eye to find materials in support of new approaches, or even only different interpretations than that of the extermination theory.

## 10. What Material Evidence Can Reveal

Time and again, the Federal German justice system, and hard on its heels historiography, concluded that the National Socialists had covered up the evidence of their crime so well that no clues remained to be found today: all gas chambers and gas vans were destroyed, mass graves dug up, the bodies contained therein burned and no traces left, and evidence of the graves was destroyed by filling-in and landscaping.<sup>122</sup>

But is it really conceivable for a number of people almost twice the population of Berlin to vanish from the face of the earth without leaving a trace?

Some of the alleged gas chambers in, for example, the concentration camps of the original Reich (borders of December 31, 1937), Austria, and Alsace are in fact still in fairly good condition where on-site investigations could be performed. Few people know, for instance, that the dispute regarding the existence of the gas chamber at Dachau<sup>123</sup> could be resolved easily enough if someone mustered up the courage to use an induction locator to find the water pipes in the ceiling of the alleged gas chamber which to this day could supply the showerheads installed in the ceiling with hot water if the water boiler was once again activated.<sup>124</sup> This conclusion is a logical necessity, for if the room described as a gas chamber really was one, then there would have been no shower installed for the inmates in this disinfestation complex with its many delousing chambers for material objects. But it has been proved that there certainly was a shower there, since this was where many thousands of inmates were deloused and showered. So, Dachau's gas chamber is nothing other than exactly what it seems to be: a shower room.

Other, equally simple and straight-forward checks regarding the authenticity and serviceability of the facilities presented as gas chambers or other execution sites in all sorts of camps formerly under German control would be an easy matter for architects, construction engineers etc. to perform.<sup>125</sup> But the authorities never so much as lift a finger towards this end, preferring instead to lop off the heads of the Revisionists if they get half a chance to do so. It is a fact, after all, that any exposure of a massive gas chamber fraud in the concentration camps of the original German Reich would beg the logical question: Why should the eyewitness testimony and reports about camps of the East,

<sup>122</sup> A classic example of this is the verdict of the Auschwitz-Trial in Frankfurt (Ref. 50/4 Ks 2/63, p. 108ff.), which saw itself forced to admit that it lacked “*almost all the means of evidence available in a normal murder trial*”, including “*the bodies of the victims, autopsy reports, expert reports on the cause and time of death, [...] evidence as to the criminals, murder weapons, etc.*”

<sup>123</sup> Whereas the US post War trials established Dachau as a camp where mass gassing took place, this was later refuted even by leading historians after a legal battle about this as described in E. Kern, *Meineid gegen Deutschland*, Schütz, Göttingen 1968, pp. 263ff., cf. correction, M. Broszat, Institut für Zeitgeschichte, *Die Zeit*, Aug. 19, 1960, as well as a letter on IfZ stationery to a Swedish addressee, dated July 17, 1961; also H. Wendig, *Richtigstellungen zur Zeitgeschichte*, issue 5, Grabert, Tübingen 1993, p. 50; extensive source material in F. A. Leuchter, *The Second Leuchter Report*, Samisdat, Toronto 1989 (online: [www.zundelsite.org/english/leuchter/report2/leucha.html](http://www.zundelsite.org/english/leuchter/report2/leucha.html)).

<sup>124</sup> I owe this information to A. Schimmelpfennig who has already used such a device successfully to locate the water pipes. Further, the manager of the Dachau Memorial Site, Ms. Barbara Diestel, pointed out to him that there is in fact a report, commissioned by the Dachau Memorial Site, which has found that the showers of the ‘gas chamber’ could be brought back into service practically overnight. Water-showers, mind you – not gas-showers! More reasons to doubt the existence of gas chambers in the ‘normal’ concentration camps were provided by E. Lachout in a memo of July 26, 1994, regarding Mauthausen, which should be starting point for further investigations, cf. E. Gauss (ed.), *Grundlagen zur Zeitgeschichte*, Grabert, Tübingen 1994, p. 405 (online: [vho.org/D/gzz](http://vho.org/D/gzz)).

<sup>125</sup> *The Second Leuchter Report*, *op. cit.* (note 123), can be seen as a first attempt to accomplish such research.



which have been locked away behind the Iron Curtain for decades, be any more trustworthy than those reports about western camps which would then have been exposed as false statements or downright lies?<sup>126</sup> This is why the establishment's view of history cannot afford to question the existence of even one gas chamber of the Third Reich, and it is also the reason why even the official German *Institut für Zeitgeschichte* (Institute for Contemporary History) persists in the claim that there were gas chambers even in the concentration camps of the original German Reich, even if it concedes that no *mass* gassings actually took place there.<sup>127</sup>

I am proud that Jürgen Graf has contributed an article to this handbook which takes a look at the National Socialist concentration camp system in general, that is, primarily at the conditions prevailing in them and at mortality rates and reasons, and also addresses false allegations about extermination of prisoners in concentration camps located in the Reich proper, with some more details about the Sachsenhausen camp north of Berlin.<sup>128</sup> Showing how false atrocity stories about these camps came into being, how they are refuted and lead to a general revision of the historiography of these camps, teaches us a lot about the alleged extermination camps in eastern Europe, as the propaganda history of the western camps is often a mirror image of that of the eastern camps.

Not only the camps of the original German Reich, but also those of Auschwitz, Birkenau and Majdanek still have more or less well-preserved remnants of buildings where mass murders are alleged to have taken place, and even where such buildings have been completely destroyed, experts can still come to very important insights based on building plans and blueprints.

In this regard it should be pointed out that the only expert report about the possible interpretation of the blueprints of the alleged gas chambers of the Auschwitz and Birkenau crematoria ever presented to a court to date concluded that it was neither possible to identify those rooms as gas chambers nor to convert them into gas chambers. This sensational report was given in the early 1970's in Austria, but was covered up by the media, and the court files about this report have vanished.<sup>129</sup>

First steps towards a resolution of engineering and architectural questions regarding this complex are currently being taken by two groups of revisionist researchers, relying mainly upon the vast archival resources of several eastern European cities like Moscow, Prague, and Warsaw. But since it is too early to come to any final conclusions, we have decided to include only two selected topics combined in a single article in this handbook.

The first part of this contribution, by Hans Jürgen Nowak, reveals a fascinating insight into how the camp authorities in Auschwitz tried to save the lives of their inmates by using high-tech devices to combat lice. During World War II the Germans developed microwave ovens, and the only place where this technology was used during the war was as a delousing device in Auschwitz.

The second part of this article addresses the vexing question of what the infamous “*gas-tight*” doors were really all about which the SS authorities ordered for the Auschwitz camp. In fact, the original German documents, discovered by Rademacher and Nowak in the files of the former

---

<sup>126</sup> A standard argument of revisionism, summarized most recently by M. Köhler, *op. cit.* (note 12), p. 18f.; cf. also R. Faurisson, *JHR* 1(2) (1980) p. 101-114 (online: [ihr.org/jhr/v01/v01p103\\_Faurisson.html](http://ihr.org/jhr/v01/v01p103_Faurisson.html)).

<sup>127</sup> M. Broszat, in *Die Zeit*, August 19, 1960; cf. E. Kern, *Meineid gegen Deutschland*, 2<sup>nd</sup> ed., Schütz, Preußisch Oldendorf 1971, pp. 233ff.

<sup>128</sup> Jürgen Graf's more comprehensive article of the NS concentration camps replaces Mark Weber's contribution featured in the first English edition. The later was basically a reprint of earlier articles on the Buchenwald and Bergen-Belsen camps published in the *Journal of Historical Review*, 7(4) (1986), pp. 405-418, and 15(3) (1995), pp. 23-30, respectively (online: [ihr.org/jhr/v07/v07p405\\_Weber.html](http://ihr.org/jhr/v07/v07p405_Weber.html) and [ihr.org/jhr/v15/v15n3p23\\_Weber.html](http://ihr.org/jhr/v15/v15n3p23_Weber.html)).

<sup>129</sup> Cf. M. Gärtner, “*Vor 25 Jahren: Ein anderer Auschwitzprozeß*”, *VffG*, 1(1) (1997), pp. 24f. (online: [vho.org/VffG/1997/1/Gaertner1.html](http://vho.org/VffG/1997/1/Gaertner1.html)), and personal conversation with the expert in charge. Prof. Robert van Pelt had access to these court files, but he did not mention that an expert report on architectural matters was included: *The Pelt Report, Irving vs. Lipstadt* (Queen's Bench Division, Royal Courts of Justice, Strand, London, David John Cawdell Irving vs. (1) Penguin Books Limited, (2) Deborah E. Lipstadt, Ref. 1996 I. No. 113; p. 135, fn 59).

Auschwitz construction office of the Waffen-SS, show that there is nothing sinister with these gas-tight doors.

Since the research is ongoing, we hope to present more results in a subsequent book that is dedicated exclusively to a documentary historiography of the Auschwitz and Birkenau camps.

In the following contributions of this handbook, Gernar Rudolf and Carlo Mattogno address the alleged mass-execution function attributed to the crematoria of Auschwitz and Birkenau and the material-delousing facilities of Majdanek. Whereas Mattogno has drawn up the first-ever expert assessment of the crematoria of Auschwitz that deserves the title ‘expert’, Rudolf presents a few decisive observations and conclusions from the perspective of construction engineering, regarding the use of some facilities as execution gas chambers. In contribution based on new findings from recent studies in Polish archives, Mattogno presents his research results about the alleged gas chambers of the concentration camp Majdanek. The bottom line of these investigations is clear: a criminal use of the buildings examined cannot be proven and has even, the author believes, been clearly refuted.

Aside from these construction engineering reports, studies in the fields of toxicology, chemical engineering and machine dynamics are required to determine which poison gas would have brought about which results through which methods and under which circumstances, whether the scenarios of mass murder attested to were technically even possible, and whether there ought to be evidence surviving to the present. The chemical and toxicological portion of this volume is carried by this author. In it, I describe the discussion launched by Fred A. Leuchter<sup>130</sup> about the issue of the formation and detectability of cyanide compounds of iron (marked by long-term chemical stability) produced by the poison gas Zyklon B, and if these compounds are to be expected and can be found in the gas chambers described in Auschwitz/Birkenau, Majdanek and Stutthof.

The inconsistency between the results of analyses performed in the alleged homicidal gas chambers of Auschwitz and Birkenau on one hand and Majdanek and Stutthof on the other is something that should be put at the heart of the discussion about chemical residues. In all cases it is claimed that the facilities were used as execution gas chambers utilizing Zyklon B, but only at the facilities of Majdanek and Stutthof cyanide residues can be found. Since the establishment school of historians has settled the discussion about the gas chambers of Auschwitz and Birkenau to their satisfaction by authoritatively concluding that execution gassings did not allow for the formation of chemical residues, the question arises why large quantities of cyanide residues could form in Majdanek and Stutthof, where the procedure was allegedly exactly the same as in Auschwitz and Birkenau.<sup>131</sup> According to their own dogma, these cyanide residues are a result of delousing procedures (and I agree with that). But if the ‘gas chambers’ in Majdanek and Stutthof were used as delousing facilities instead, how do we assess all the eyewitnesses who testified that these rooms did *not* serve as delousing chambers, but exclusively as homicidal gas chambers? And if we consider these eyewitnesses as unreliable, how can we assume that similar eyewitness accounts about Auschwitz and other camps are more reliable? And how can it be proven by other means than eyewitness accounts that these rooms were used both for delousing *and* killing? There appears to be no other way. The establishment historians have driven themselves into a corner where it is impossible to prove or refute

---

<sup>130</sup> F. A. Leuchter, *The Leuchter Report: An Engineering Report on the Alleged Execution Gas Chambers at Auschwitz, Birkenau and Majdanek, Poland*, Samisdat Publishers Ltd., Toronto 1988 (online: [www.zundelsite.org/english/leuchter/report1/leuchter.toc.html](http://www.zundelsite.org/english/leuchter/report1/leuchter.toc.html)).

<sup>131</sup> Whereas the alleged gas chambers of Auschwitz and Birkenau officially served as morgues, the alleged gas chambers of Majdanek and Stutthof were officially used as delousing chambers, see Jürgen Graf, Carlo Mattogno, *Concentration Camp Majdanek. A Historical and Technical Study*, Theses & Dissertations Press, Chicago, IL, 2003 (online: [vho.org/GB/Books/cem](http://vho.org/GB/Books/cem)); Graf, Mattogno, *Concentration Camp Stutthof and its Function in National Socialist Jewish Policy*, *ibid.* 2003 (online: [vho.org/GB/Books/ccs](http://vho.org/GB/Books/ccs)).

their claims, which is a certain indicator that their thesis is unscientific.<sup>132</sup> We are eager to see whether and how they will manage to get themselves out of it.

The question, under what sorts of conditions it would have been possible to use Diesel engines – the murder weapon alleged for Treblinka and Belzec – to suffocate people to death, was already addressed in detail by Friedrich Paul Berg in 1984, but, in keeping with tradition, the literature of the historians of the establishment dispensed with any reaction to his report.<sup>133</sup> Berg’s analysis was updated and expanded for this handbook, and concludes that the conditions attested to for the alleged gassings with Diesel exhaust fumes would not have allowed for successful mass killings, and also that it would have been ridiculous, if not to say downright idiotic, to resort to this method in the first place, considering that a method using wood-gas generators was available and both cheaper as well as hundreds or even thousands of times more effective. In Berg’s opinion, the tale of Diesel exhaust gassings is an instance of Soviet propaganda that backfired. The direct implications of this analysis for the alleged extermination camps Treblinka and Belzec are obvious.

In his chapter, Arnulf Neumaier considers problems of construction engineering associated with the alleged gas chambers of Treblinka, and particularly the issues of whether the methods which witnesses claim were used to destroy the evidence – in this instance, the complete incineration of almost one million people – were at all technically possible, what sorts of evidence one ought nevertheless to expect, and how these conclusions compare with the evidence that has in fact been found. The bottom line is devastating: the scenarios described by the witnesses are ridiculous and completely unrealistic, and do not agree even remotely with the results of on-site investigations.

Next, Herbert Tiedemann introduces us to a different field: The alleged mass shootings by German armed forces in Russia during World War Two. He presents an extensive critique of eyewitness testimony and media representation of the alleged mass execution of Jews from Kyiv by German task forces in the valley of Babi Yar in autumn of 1941. Since his study incorporates critiques of eyewitness testimony and documents as well as technical and scientific elements, it represents, in a way, a methodological synopsis of revisionist criticism on the basis of one specific example, and is thus a fitting conclusion to our handbook.

The wide variety and inconsistency of the testimony and accounts of this case alone practically beg for extreme skepticism, and the absolute lack of any such skepticism on the part of our historians, journalists, and politicians makes us doubt their capacity for common sense. Unfortunately this is only a model case for many other subsections of the Holocaust complex as well.

Babi Yar is also a starting point for the critique of a body of documents which revisionist research has hardly dealt with to date: the reports about the mass executions of Russian Jews. These are divided into two main groups:

1. The so-called *Ereignismeldungen* (Event Reports) which were allegedly drawn up by German authorities and collected in Berlin, where they were found by the Allies at the end of the war and were subsequently presented as evidence at the Nuremberg trials. These “*Event Reports*” give very detailed accounts of the Babi Yar incident.
2. A number of radio reports which were sent by the Einsatzgruppen from Russia to Berlin and which were deciphered by the British Intelligence Service. These documents were released only recently, which has led to some speculations about whether the western Allies may have known much earlier about a German policy of extermination of the Jews and whether perhaps even more than 6 million Jews were killed by the Germans in World War Two.<sup>134</sup>

---

<sup>132</sup> When, for logical reasons, a thesis can neither be proved nor refuted, it must be called “*unscientific*” or “*pseudo-scientific*”.

<sup>133</sup> F. P. Berg, *JHR* 5(1) (1984) p. 15-46 (online: [ihr.org/jhr/v05/v05p-15\\_Berg.html](http://ihr.org/jhr/v05/v05p-15_Berg.html)).

<sup>134</sup> Richard Breitman, “*Holocaust Secrecy Now Abets More Genocide*”, *New York Times*, November 29, 1996; Douglas

However, nobody took much notice of a similar case where the British Government published excerpts from exactly these documents as early as 1981.<sup>135</sup> Perhaps this was because these excerpts included the exciting revelation that the British Intelligence Services had succeeded in 1942 and 1943 in deciphering top-secret radio messages from the administration of the German camps, in which details about deceased and killed prisoners were reported to Berlin, including the method of their execution and other circumstances of death. The reason for this media cover-up may be rather simple, as the following shows:

*“The messages from Auschwitz, with 20,000 prisoners the largest of the camps, mentioned illness as the main cause of death, but also included references to shootings and hangings. There were no references in the decrypts to gassings.”*<sup>136</sup>

Why should the persons responsible, in their top-secret messages, report to Berlin about shootings and hangings, but keep silent about gassings? In fact, the gas chambers seem to be ever decreasing in importance as a killing method, as opposed to mass shootings. The Dutch historian M. Korzec was the first to offer the theory that not more than a few hundred thousand Jews were killed in gas chambers, but that many millions were killed by mass shootings in Russia.<sup>137</sup> This theory would require that many more Germans were involved in these mass killings than would have been necessary if one assumes the gas chambers as the main weapon. Consequently, this theory is more suited to supporting a different theory, *i.e.*, that of the collective guilt of at least the German soldiers of the eastern front, if not of all Germans, for the Jewish Holocaust. This logical conclusion was drawn by Daniel J. Goldhagen,<sup>138</sup> who merely repeated Korzec’s theses and added a new aspect: an anti-Semitic gene that led specifically the German people to commit such a cruel deed. The reaction of the German historians in particular was appropriately furious, even if those same historians had backed somewhat similar theses in the previous decades.<sup>139</sup> They simply harvested what they themselves had sown.

---

David, “*British Documents: 7 million died in Holocaust*”, *Jerusalem Post*, May 20, 1997; *The Daily Telegraph*, same date; *dpa*, “*Briten wußten vom Judenmord*”, German daily press, November 11, 1996; “*Neue Quelle speist das Wissen über den Holocaust*”, *Frankfurter Rundschau & taz*, November 14, 1996; *Welt am Sonntag*, November 17, 1996, p. 5.

<sup>135</sup> F. H. Hinsley, *British Intelligence in the Second World War*, v. II, Her Majesty’s Stationary Office, London 1981, pp. 669-673.

<sup>136</sup> *Ibid.*, p. 673; cf. H. Herrmann, “*Entschlüsselt aus Auschwitz*”, *FAZ*, September 13, 1993, p. 12.

<sup>137</sup> M. Korzec, “*De mythe van de efficiente massamoord*”, *intermediair*, December 15, 1995, p. 19-23; in an interesting private communication with S. Verbeke prior to the publication of this article, Korzec told him quite frankly that he no longer believes in the gas chambers but is afraid to write this, so he will simply reduce the number of victims in a kind of “*policy of small steps*”; cf. this and even more admissions by other Holocaust historians: H. Verbeke, “*Aufgeschnapp!*”, *VffG*, 1(2) (1997), p. 59 (online: [vho.org/VffG/1997/2/VerAuf2.html](http://vho.org/VffG/1997/2/VerAuf2.html)).

<sup>138</sup> D.J. Goldhagen, *Hitler’s Willing Executioners*, Little, Brown & Co., New York 1996, p. 521: “*In fact, the Germans continued to shoot Jews en masse throughout the war. It is not at all obvious that gassing was a more ‘efficient’ means of slaughtering the Jews than shooting was. There were many instances in which shooting was clearly more efficient. The Germans preferred gassing for reasons other than some genocidal economic calculus. Understanding this suggests that, contrary to both scholarly and popular treatments of the Holocaust, gassing was really epiphenomenal to the German’s slaughter of Jews. It was a more convenient means, but not an essential development. Had the Germans never invented the gas chambers, then they might well have killed almost as many Jews.*” Ger.: *Hitlers willige Vollstrecker. Ganz gewöhnliche Deutsche und der Holocaust*, Siedler, Berlin 1996.

<sup>139</sup> *dpa*, “*Holocaust, Historiker und der PR-Zirkus*”, *Allgemeiner Anzeiger*, August 5, 1996: in a survey “*German historians accuse Goldhagen of self-righteousness and of ignoring arguments*”; M. Wolffsohn “*spoke of a PR-circus and of vain quarreling among colleagues*”; “*Yowling’ over Hitler-book*”, *Allgemeine Zeitung*, August 23, 1996: “*The Allgemeine Jüdische Wochenzeitung described the local reactions to Daniel Goldhagen’s book as ‘collective yowling’*”: “*The grandparents were horrible, the grandchildren are just pathetic*”; N. Frei, “*Ein Volk von ‘Endlösern’?*”; J. Joffe, “*Hitlers willfähige Henker*”, *Süddeutsche Zeitung*, April 13/14, 1996, p. 13; P. Gauweiler, “*Ein deutsches Phänomen*”, *Bayernkurier*, Oktober 12, 1996; A. Chaitkin, “*Goldhagens Buch: Eine ‘britische Provokation’ aus Harvard*”, special reprint from *Neue Solidarität*, no. 36, September 4, 1996; cf. the critique by former

The tendency in recent historiography seems to be more and more to abandon the gas chambers, for which the sources are “*at once rare and unreliable*”, as Prof. Arno J. Mayer put it,<sup>140</sup> or for which there are absolutely no “*documents, traces or material evidence*” at all, as French historian Jacques Baynac recently said.<sup>141</sup> This is no doubt the result of past revisionist research, which urged the historians of the establishment to concede that their old story is wrong. They now seek to restore their damaged image by trying to rescue the ‘Holocaust’ by sidestepping into a field where they believe revisionist criticism cannot reach them: into the endless Russian steppe. But I am not certain that they will succeed. Hans-Heinrich Wilhelm,<sup>142</sup> one of the most renowned experts regarding the Einsatzgruppen, stated as early as 1988 that he is not sure that the numbers given in these Event Reports are correct. As a result of his skepticism, he warns his colleagues:<sup>143</sup>

“*If the reliability [of these reports] is no greater in non-statistical respects – something which could be corroborated only by a comparison with other sources from the same region – then historical research would be well advised to make much more cautious use of SS sources than it has done to date.*”

This was only logically consistent, since in his first book about this topic he had already raised a few doubts about the reliability of those documents, *i.e.*, he suspected the figures given in them to be exaggerated.<sup>144</sup> Sybille Schröder recently added more points to this ever growing list of criticism.<sup>95</sup> We must therefore demand more reliable, *i.e.*, physical evidence for the accusations directed against several German armed forces in the East, before we can accept the data given by these suspicious documents.

From the air photos discussed by J. C. Ball, for example, it is apparent – and this has not been refuted to date – that the mass murder of Jews allegedly committed by the Einsatzgruppen in a valley called Babi Yar, near Kyiv, never took place. Thus it is clear that at least these Event Reports and, accordingly, the corresponding radio messages, if there should be any, are false. Further research, for example with the aid of air photos yet to be discovered, is needed to determine the conclusions to be drawn from this with respect to the hundreds of other related reports, and I am quite sure that we can expect even more surprises. Another case with a different approach may have a similar impact on the thesis of ‘Goldhagen & Co.’: In the summer of 1996 the town of Marijampol, in Lithuania, decided to erect a Holocaust Memorial to the tens of thousands of Jews allegedly slaughtered and buried there by German Einsatzgruppen. In order to build the Memorial at the correct location,

---

colleague of D. J. Goldhagen, R. B. Birn, “*Revising the Holocaust*”, *The Historical Journal*, (Cambridge University Press), 40(1) (1997), p. 193-215 (available online on: [abc.com/aaargh/engl/crazygoldie/BIRN.html](http://abc.com/aaargh/engl/crazygoldie/BIRN.html)); cf. N.G.

Finkelstein, “*Daniel Jonah Goldhagen’s ‘Crazy’ Thesis: A Critique of Hitler’s Willing Executioners*”, *New Left Review* (London), no. 224, July 1997, p. 39-88. (available online on [abc.com/aaargh/engl/crazygoldie/FINKEL1.html](http://abc.com/aaargh/engl/crazygoldie/FINKEL1.html)); cf.

N.G. Finkelstein, Ruth Bettina Birn, *A Nation on Trial: The Goldhagen Thesis and Historical Truth*, Metropolitan Books, New York 1998.

<sup>140</sup> A.J. Mayer, *Why did the Heavens not Darken? The “Final Solution” in History*, Pantheon Books, New York 1988, pp. 362, cf. the Preface by Robert Faurisson in this Book, his note 22.

<sup>141</sup> *Le Nouveau Quotidien* (Lausanne), September 2 and 3, 1996, p. 16 & 14; cf. R. Faurisson, “*Keine Beweise für Nazi-Gaskammern!*”, *VffG*, 1(1) (1997), p. 19ff. (online: [vho.org/VffG/1997/1/FauBay1.html](http://vho.org/VffG/1997/1/FauBay1.html)).

<sup>142</sup> Together with Helmut Krausnick, co-author of the famous book *Die Truppe des Weltanschauungskrieges. Die Einsatzgruppen der Sicherheitspolizei und des SD 1938-1942*, Deutsche Verlags-Anstalt, Stuttgart 1981.

<sup>143</sup> H.-H. Wilhelm, Lecture given at the International History Conference at the University of Riga, September 20-22, 1988, p. 11. Drawing on this lecture, Wilhelm wrote his contribution “*Offene Fragen der Holocaust-Forschung*”, in *op. cit.* (note 45), in which this passage is not included. I owe this information to C. Zaverdinos, who provided it in his opening speech at a historical conference held on April 24, 1995, at the University of Natal, Pietermaritzburg, and to Robert H. Countess, who got Wilhelm’s paper from Wilhelm personally.

<sup>144</sup> H.-H. Wilhelm, *op. cit.* (note 142), p. 515, states that it seems likely “*that even here several tens of thousands of exterminated Jews were added in order to ‘improve’ the results of the destruction of partisans, which otherwise apparently seemed to be unacceptably low*”. On p. 535 he notes that one of the Event Reports was manipulated by adding a zero to the number 1,134, resulting in 11,034.

they tried to find where the mass graves are. They excavated the site described by the witnesses, but did not find a trace.<sup>145</sup> Further digging throughout an entire year, all around the alleged killing site, has revealed nothing but undisturbed soil.<sup>146</sup> So, did the Germans do a perfect job by destroying all traces and even restoring the original sequence of soil layers? Did they perform miracles? Or are the witnesses wrong?

To allow for an idea of the cruel conditions under which the Germans were forced to fight in at the eastern front, and which rules of warfare were generally accepted regarding partisan actions and reprisals, we have translated an excellent legal expert report of Karl Siegert about the legitimacy of reprisals in wartime. This report was prepared in the 1950s for the defense of a German soldier accused of having committed war crimes in Italy by shooting civilians as reprisal for partisan warfare. In order to understand the historical context of German reprisals in eastern Europe, this author has written an introduction and some concluding remarks about the cruel and illegal partisan warfare as it was initiated and conducted mainly by the Soviet Union. These contributions were not included in the German edition of this volume.<sup>147</sup>

Of course the evidence presented in this volume is but a bare introduction to what else is possible, and necessary, for a comprehensive resolution of the Holocaust complex. Other, similar studies could support our findings – or refute them. With today's modern technology it is no doubt possible to improve considerably upon our present level of knowledge. Archaeologists, for example, are able today to apply the techniques of aerial photography to locating the remnants of human settlements, deserted for many millennia and at times located far below the earth's surface. Archaeologists are also able, on the basis of very meager remnants of Stone Age fire sites, to determine from which period the fire dates and under what sorts of conditions it burned (kind of wood, size and kind of camp, diet based on the presence of certain animal bones, degree of civilization based on the presence of tools and refuse, etc.).

We firmly believe, therefore, that the aerial photographs taken by German as well as by Allied reconnaissance planes during World War II, which in part still reside untouched in the archives today, are a source of reliable insight into the events of those days, and further, that air photos taken today would still allow scientists to determine the size of former mass graves, or even the foundations of buildings no longer extant. What is more, excavations and the analysis of sediments and residue can certainly still determine the size of mass graves or the kind and quantity of residue from burning sites – if only one cares to investigate.

The fact that to this day no one sees fit to gather this evidence, which the Soviet anti-Fascist propaganda of the past decades would not have been the only one to jump at, makes me wonder, to put it mildly; all the more so because nowadays, expert reports on technical matters are required for even the most routine court case following, say, a car accident, never mind for murder trials, where a single life was lost! So why does the establishment refuse to bring, or to allow, even one bit of material evidence in court in this case of an allegedly unparalleled mass murder? Because they fear that their thesis of the collective guilt of the German people (and accordingly, the collective innocence of the Jewish people) might be *completely* refuted?

## 11. The Purpose of This Book

The trend pointed out by Nolte – that the establishment historians, the media, justice system and even society in general suspect revisionist authors of being followers or at least sympathizers of a

---

<sup>145</sup> *Lietuvos Rytas* (Lithuania), August 21, 1996.

<sup>146</sup> Personal communication of M. Dragan.

<sup>147</sup> An enhanced German version appeared in *VffG*, see note. 95.

National Socialist ideology – can be traced through a series of publications<sup>148</sup> and culminated in the work by Kogon, Langbein and Rückerl, where the Revisionists are slandered outrageously and suspected of all sorts of things, while their names are never mentioned nor any revisionist publications cited to enable the reader to confirm the editors' allegations for himself.<sup>149</sup> In the end, this type of pseudo-argumentation by the establishment historians always comes down to the same thing, namely to impute to the Revisionists an apologia for the National Socialist system, in other words, the unconditional resolution to defend the National Socialist system even against supposed reality. Anyone who stands up for something considers that something worth defending, *i.e.*, in this case must be a sympathizer with the National Socialist system.

It must be said here and now that none of the authors contributing to the present work considers himself ideologically anywhere in the vicinity of National Socialism.<sup>150</sup> This aside, however, such an accusation is no argument suited to invalidating our own. It seems reasonable to suspect that the establishment historians resort to this verbal garrote merely to distract attention from those factual questions, which they obviously do not feel competent to field. In any case, it is clear that anyone who evades factual arguments by means of political accusations cannot have any scientific motivation for doing so, since a scientifically motivated researcher is interested first and foremost in factual arguments. Political motivation is the only thing that could possibly prompt these historians to voice political accusations; this, however, places the charge of political choreography of our understanding of history squarely back on their own shoulders.

Every reader ought to examine the intentions with which he approaches this volume, for:

*“If you must worry about motive, however, it is incumbent on you to examine as well the motives of those who consistently argue against intellectual freedom on this one issue. If you don't want to examine the motives of those on both sides of the issue, perhaps (forgive me) you should examine your own.”*<sup>151</sup>

We will also not accept the change of topic to certain marginal issues within the debate on the Holocaust which certain Revisionists may have started – for example, the discussion about the definitely eccentric theory that the National Socialists had resorted to the murder of the Jews in self-defense following the publication of T. N. Kaufman's book *Germany must perish!*,<sup>152</sup> or the theory (untenable under international law) that following the declaration of war which had in fact been made against the Third Reich by international Jewish private (!) organizations,<sup>153</sup> the National So-

<sup>148</sup> For example, see I. Arndt, W. Scheffler, *VfZ* 24 (1976) p. 105-135; A. Suzman, D. Diamond, *Aus Politik und Zeitgeschichte* 28(30) (1978) p. 4-21; J. S. Conway, *VfZ* 27 (1979) p. 260-284; W. Benz, *VfZ* 29 (1981) p. 615-630; Dokumentationszentrum des österreichischen Widerstandes, Bundesministerium für Unterricht und Kultur (ed.), *Amoklauf gegen die Wirklichkeit*, Vienna 1991; G. Wellers, *Dachauer Hefte* 7(7) (1991) p. 230.

<sup>149</sup> E. Kogon, H. Langbein, A. Rückerl et.al. (eds.), *op. cit.* (note 103), Section I: “*Einleitung*”.

<sup>150</sup> I am well aware that when it comes right down to it, certain ladies and gentlemen do not care where we Revisionists consider ourselves to fit into the ideological spectrum, since after all they always know better than we do what and how we think – right?

<sup>151</sup> B. R. Smith, *Campus Update No. 2, Committee for the Open Debate on the Holocaust*, P. O. Box 3267, Visalia, CA 93278, Spring 1994.

<sup>152</sup> Cf. the correction by W. Benz, *VfZ* 29 (1981) p. 615-630.

<sup>153</sup> “*Judea Declares War on Germany – Jews of all the World Unite – Boycott of German Goods*”, in *Daily Express*, March 24, 1933, one day after the Enabling Act was passed. The German reaction to this declaration of war is well known: on Saturday, April 1, 1933, the government of the Reich called for a half-day boycott of Jewish stores. A similar declaration of war was given by Samuel Untermyer, President of the World Jewish Economic Federation, on August 7, 1933, in the *New York Times*. After war had broken out in Poland, another Jewish declaration of war was issued by Chaim Weizmann, President of the Jewish Agency, *Jewish Chronicle*, September 8, 1939. In 1985 Professor Ernst Nolte mentioned this declaration in a British publication, as well as the thesis based on it, namely that the internment of the Jews by Germany was therefore not in violation of international law. No doubt this was one of the main triggers of the Historians' Dispute; cf. E. Nolte, *Das Vergehen der Vergangenheit*, Ullstein, Frank-

cialists had rightly interned all the Jews in their sphere of influence as members of an enemy nation. What is more, this erroneous thesis is usually advanced by people who simultaneously condemn the Soviet deportation of the Volga-Germans at the start of Germany's Russian Campaign in the summer of 1941, or the USA's internment of Germans and Japanese when Japan entered the war.<sup>154</sup> This kind of peripheral phenomenon is not our issue. It is not our goal in this volume to justify or in any way rationalize a proven injustice. Our issue is solely and exclusively the question whether the evidence offered for the Holocaust – defined as the intentional, planned mass murder of the Jews in the sphere of influence of the Third Reich – suffices to give it continued credibility in its present form, especially with respect to the mass gassings, or whether new evidence may perhaps require the revision of historiography.

The thesis that the Holocaust as defined above may not have taken place is naturally an explosive topic for the study of contemporary history, as for all aspects of social life directly or indirectly associated with it. We are fully aware of this. But it is important to keep in mind that since 1955 at the latest, when the official *Institut für Zeitgeschichte* determined that it was the Soviets who had perpetrated the 1940 massacre of more than 20,000 members of the Polish elite at Katyn and elsewhere,<sup>155</sup> the federal German media could have been disseminating the truth about Katyn, despite Soviet propaganda to the contrary, which continued to lay its own guilt for this crime at Germany's door as late as 1990. Yet right until the late 1980s, the leftist media in particular thoughtlessly parroted this Communist propaganda.<sup>156</sup> The reason for this is probably to be found in the politically, *i.e.*, non-scientifically motivated desire to keep the Third Reich from being exonerated from historical guilt even where this has become inevitable, the greater purpose being to prevent, by thwarting even the partial revision of historiography, any farther-reaching revisions which might ultimately cast doubt upon the politically desirable, unique and unparalleled evil of the National Socialist regime.

But this is not the only contentious issue in which the media deny the truth for ideological reasons. There are subsections of contemporary history where neither the media nor many historians are particularly concerned about honesty. For four decades, for example, almost all of German contemporary historiography has championed the claim that the German campaign against Russia had been a merciless attack intended solely to gain territory in the East, at the expense of the Slavs living there. This claim persisted until V. Suvorov<sup>157</sup> and E. Topitsch<sup>158</sup> both presented compelling proof that the Russian Campaign was in fact a preventive war against the Soviet Union which had been poised to strike – which, of course, does not preclude a policy of *Lebensraum* (living space) on the part of the Third Reich. Following the collapse of the Soviet Union and the opening of Soviet archives it has suddenly grown quiet among the ranks of those historians who formerly argued against the thesis of the preventive war; especially the German media, however, continue to propa-

---

furt am Main / Berlin 1987, p. 20f., 170f.; declarations of war and other threats by Jewish individuals and organizations against Germany were very common at that time, cf. Hartmut Stern, *Jüdische Kriegserklärungen an Deutschland*, FZ-Verlag, Munich 2000.

<sup>154</sup> Cf. the detailed study by I. Fleischhauer, *VfZ* 30 (1982) p. 299-321; Arnold Kramer, *Undue Process: The Untold Story of America's German Alien Internees*, Rowman and Littlefield, Lanham, MD, 1997; see also G. Eberbach's study of Allied concentration camps: *DGG* 42(2) (1994) p. 15-23.

<sup>155</sup> H. Thieme, *VfZ* 3 (1955) p. 408-411.

<sup>156</sup> Cf. F. Kadell, *Die Katyn-Lüge*, Herbig, Munich 1991.

<sup>157</sup> V. Suvorov, *Icebreaker: Who Started the Second World War?*, Hamish Hamilton, London 1990; Suvorov, *Der Tag M*, Klett-Cotta, Stuttgart 1995.

<sup>158</sup> E. Topitsch, *Stalins Krieg*, 3<sup>rd</sup> ed., Busse Seewald, Herford 1998; cf. W. Post, *Unternehmen Barbarossa*, Mittler, Hamburg 1995; F. Becker, *Stalins Blutspur durch Europa*, Arndt Verlag, Kiel 1996; Becker, *Im Kampf um Europa*, 2<sup>nd</sup> ed., Leopold Stocker Verlag, Graz/Stuttgart 1993; W. Maser, *Der Wortbruch. Hitler, Stalin und der Zweite Weltkrieg*, Olzog Verlag, Munich 1994.



gate the lie of the attack on peace-loving Russia<sup>159</sup> – in contrast to the Russian media.<sup>160</sup> Neither Topitsch, the philosopher, nor Suvorov, the Russian officer in exile, are German historians, yet their researches have resulted in a radical re-thinking process. Admittedly, many historians as yet shy away from the theses of Suvorov and Topitsch, since it is a matter of principle with them to feel ill at ease with a thesis which exonerates the Third Reich from one of its evil deeds.

Another sensitive subject also had to be broached by a foreigner first before the German historians began to consider the topic. In 1989 James Bacque, a Canadian, published a work in which he proved that in the years between 1945 and 1947 the Americans, Canadians, and French together deliberately starved some one million German civilian internees to death, which constitutes genocide.<sup>161</sup> Since according to Bacque the Soviet archives reveal that some 450,000 abducted German prisoners died in Russia after the war, and since it has been a known fact for years that approximately 1.4 million Germans never returned from Allied imprisonment, Bacque feels that he can state the number of losses in the camps of Germany's current friends, the western Allies, quite precisely at one million.<sup>162</sup> Considering all deaths caused by the Allied policy of destroying Germany, he totaled the German post-war losses as high as at least 5.7 million.<sup>163</sup> Some historians reacted to this Canadian (self-)accusation that the USA, Canada and France had committed genocide against the German people by denying the correctness of Bacque's analysis and jumping to the defense of the Allies.<sup>164</sup>

The extensive field of research related to the many concentration camps established after the war in eastern and southeastern Europe for purposes of the indiscriminate internment of mostly German victims, many of whom were to die an agonizing death there, was also introduced to a broader international public by a non-German, namely John Sack. In his book he describes how mostly Jewish concentration camp guards in Polish camps took gruesome revenge on innocent Germans who had been rounded up more or less at random.<sup>165</sup> The attempt to publish this book in Germany shows just what a state this country is in. Although the Munich publishing firm Piper Verlag had already printed the German edition, it decided just prior to the release date to pulp, in other words to destroy, the entire press run, since they did not want to contribute to a 'relative' perspective of the German crimes against the Jews and also did not wish to expose the Jews as perpetrators.<sup>166</sup> Eventually Sack did succeed in finding a German publisher.

<sup>159</sup> Cf. R. Augstein, in *Der Spiegel*, no. 6, February 5, 1996, pp. 100-125.

<sup>160</sup> Cf. for the ongoing discussion in Russia expert Wolfgang Strauß in *Staatsbriefe*, no. 3 & 4/1996, no. 8 & 9-10/1996, no. 4, 9, 10 & 11-12/1997 (online: [vho.org/D/Staatsbriefe](http://vho.org/D/Staatsbriefe)); cf. Strauss, *Unternehmen Barbarossa und der russische Historikerstreit*, Herbig, München 1998

<sup>161</sup> J. Bacque, *Other Losses*, Stoddart, Toronto 1989.

<sup>162</sup> J. Bacque, in *FAZ*, March 12, 1994, p. 8; cf. M. Messerschmidt, *FAZ*, Feb. 1, 1994; letters to the editor, *FAZ*, Feb. 10, 1994, March 26, 1994; B. Schöbener, *FAZ*, March 16, 1994.

<sup>163</sup> J. Bacque, *Crimes and Mercies*, Little, Brown & Co., Toronto 1996. acc. to Bacque, between 1945 and 1950 at least 10 million Germans died as a result of the implementation of a deliberate and vengeful Allied policy – the evil *Morgenthau Plan* – whose purpose was, quite simply, genocide for Europe's German people.

<sup>164</sup> Cf. Stephen E. Ambrose, "Ike and the Disappearing Atrocities. James Bacque's 'Other Losses'", *New York Times Book Review*, February 24, 1991; G. Bischof, S.E. Ambrose (ed.), *Eisenhower and the German POWs: Facts against falsehood*, Louisiana State University, Baton Rouge 1992; John Keegan, *The Times Literary Supplement*, July 23, 1993; James Bacque, *ibid.*, August 20, 1993.

<sup>165</sup> John Sack, *An Eye for an Eye*, BasicBooks, New York 1993; Ger.: *Auge um Auge*, Kabel Verlag, Hamburg 1995; cf. S. Jendryschik, *Zgoda*, Verlag für ganzheitliche Forschung, Viöl 1997, regarding a Polish extermination camp for Germans in the Polish town of Zgoda; cf. Österreichische Historiker-Arbeitsgemeinschaft für Kärnten und Steiermark (ed.), *Völkermord der Tito-Partisanen 1944-1948*, 2<sup>nd</sup> ed., O. Hartmann Verlag, Sersheim (Germany) 1993, regarding the genocide of the Yugoslav partisans against the German minority under J.B. Tito in the former Yugoslavia.

<sup>166</sup> Cf. *Die Welt*, March 2, 1995; *Süddeutsche Zeitung*, May 1, 1995; *FAZ*, June 30, 1995.

The situation regarding the blame for the bombing of the German civilian population has been no less paradoxical for decades. Whereas the British openly acknowledge their guilt (and are even proud of it),<sup>167</sup> a great many of the German historians insist that Hitler was to blame for absolutely everything, including the bombing war against the German civilians.

If one adds to these more than half a million German victims of the Allied bombing<sup>168</sup> (which violated international law) the 1.4 million victims of Allied starvation camps, at least 2.1 million victims from the expulsion from the German eastern territories,<sup>169</sup> and uncounted hundreds of thousand victims of starvation and diseases resulting from the initial implementation of the genocidal Morgenthau plan, one arrives at a total of around 6 million Germans killed by the Allies and their accessories, deliberately or at least through gross negligence, and in contravention of international law. This total approaches another, heavily symbolic number.

In the face of these disasters that have befallen German researchers in contemporary history in recent years, it is understandable that the majority of German historians *feel* that at least the Holocaust must remain intact if they are not to lose even their last shred of credibility. In 1977, in light of the fact that no document has ever yet been found in which Hitler ordered the murder of the Jews or which reveals his awareness or approval of the mass murder, D. Irving (another non-German national) postulated that Hitler may not even have known of the murders.<sup>170</sup> M. Broszat commented rightly:

*“Rather, Irving’s theory touches the nerve of the credibility of historiography regarding the National Socialist period.”*<sup>171</sup>

But what is left of this credibility if the Holocaust did not take place as generally believed? This revisionist thesis, advanced in the last decades primarily by, once again, citizens of the western Allied nations, not only touches the nerve of the credibility of historiography, it shatters it outright. And now that this handbook is published, one will have to expect reactionary responses by unnerved historians. But can the issue at stake take into consideration the poor state of the nerves of certain historians and their followers, or is the ascertainment of historical truth the more important issue? And is it not also particularly the question whether academia and the right to the free expression of opinion are in fact still free in Europe, in other words, whether human rights, the moral foundation of western civilization, really still deliver what they promise? In any case, the semi-conservative German daily newspaper *Welt* demanded in a fit of outrage at the above mentioned Federal Supreme Court verdict (Supreme Court v. Deckert, cf. Note 47) that Revisionists should not only be convicted for their attack on Jewish dignity without the prior unnecessary ado of hearing evidence, but claimed as further justification that

*“[a]nyone who denies Auschwitz [...] also shakes the very foundations of this society’s self-perception.”*<sup>172</sup>

The leftist German weekly paper *Die Zeit* also explained why the disputers of the Holocaust must be silenced by the justice system and Defense Forces of the Constitution:

*“The moral foundation of our Republic is at stake.”*<sup>173</sup>

<sup>167</sup> J. M. Spaight, *Bombing Vindicated*, Geoffrey Bles, London 1944.

<sup>168</sup> In its conservative estimate, the German Federal Bureau of Statistics postulates 600,000 victims; cf. D. Irving, *Und Deutschlands Städte starben nicht*, Weltbild Verlag, Augsburg 1989, p. 373; cf. M. Czesany, *Europa im Bombenkrieg 1939-1945*, Leopold Stocker, Vienna 1998.

<sup>169</sup> The overcautious estimate of the German Federal Ministry for Expellees postulates at least 2.1 million victims; cf. Alfred Maurice de Zayas, *The German Expellees: Victims in War and Peace*, St. Martin’s Press, New York 1993, p. 149-150.

<sup>170</sup> D. Irving, *op. cit.* (note 96).

<sup>171</sup> M. Broszat, *op. cit.* (note 96), p. 745.

<sup>172</sup> P. Philipps, “*Quo vadis, BGH?*”, *Die Welt*, March 16, 1994, p. 6.

No, my dear ladies and gentlemen of the press, quite the reverse is true! Anyone who threatens academic freedom and freedom of the expression of opinion shakes the very foundations of the German society's self-perception and endangers the moral foundation of Germany!

Unless, yes, unless the Federal Republic of Germany defines itself not in terms of the human rights set out in her constitution, but in terms of the prevailing belief in the Holocaust. But before anyone expects us to accept this theocratic approach, it would have to be set down in black on white in the Constitution – after prior approval by the German people.

The fact that the above newspaper reports were not simply a passing craze was proven a short time later by the *Welt*, which wrote:

*“Anyone who denies the truth about the National Socialist extermination camps betrays the principles on which the Federal Republic of Germany was built. This state is supposed to be a valiant democracy that defends itself when anti-democrats try to subvert it.”*<sup>174</sup>

Well, there we have it: anyone who holds a contrary opinion on certain topics is anti-democratic. That makes about as much sense as the statement that nights are colder than outdoors.

Regarding the *Welt*'s indirect accusation that the authors of this volume are anti-democratic, I just want to point out that in my opinion an increase in democratic rights in the form of popular plebiscitary participation in the state's decision-making process would be a major boon to Germany. In view of the conditions described in this introduction, to which we researchers and scientists are subjected in Germany and other western nations, it is evident that these nations suffer from considerable deficits of democratic and human rights – not only in terms of freedom of opinion, research, and science, but also in terms of access to the media.

Further examples show that the above quoted media statements are not just the opinion of some few media people, but rather that it is the honest conviction of most of the German elites. The former German Federal President R. von Weizsäcker, for example, is quoted as having said that “*it is not NATO, but Auschwitz, that constitutes the [German] reasons of state*”.<sup>175</sup>

This view was recently confirmed by the German Minister for Foreign Affairs, Josef Fischer:<sup>176</sup>

*“All democracies have a base, a foundation. For France this is 1789. For the USA it is the Declaration of Independence. For Spain it's the Civil War. Well, for Germany it is Auschwitz. It can only be Auschwitz. In my eyes, the remembrance of Auschwitz, the 'never again Auschwitz', can be the sole foundation of the new Berlin Republic.”*

German lawyers offer similar arguments:<sup>177</sup>

*“The Holocaust and its admission is the normative foundation of our [German] Constitution. Our Basic Law's legitimacy – in the sense of deserving recognition – is built upon the acknowledgement of National Socialist crimes, which claimed the lives of the Jews in en masse technological destruction.”*

In the German *Bundestag* (parliament) this view is expressed and confirmed with applause from all (!) parties:<sup>178</sup>

*“Anyone who trivializes or denies the National Socialist mass murder of the Jews – in other words, the Holocaust – must know that he is attacking democratic foundations.”*

---

<sup>173</sup> K.-H. Janßen, “*Die Rattenfänger*”, *Die Zeit*, December 31, 1993, p. 51.

<sup>174</sup> R. Wassermann, “*Die Justiz hat Klarheit*”, in *Die Welt*, April 28, 1994, p. 4.

<sup>175</sup> Josef Fischer, according to *Der Spiegel*, no. 28/1987.

<sup>176</sup> J. Fischer to Bernard-Henri Lévy, *FAZ*, Feb. 18, 1999, p. 46.

<sup>177</sup> Lawyer H. Stomper, quoted as per Herbert Verbeke (ed.), *op. cit.* (note 32), p. 56.

<sup>178</sup> H. de With, MdB (SPD), in the German Parliament (Bundestag), May 18, 1994, *Bundestagsprotokoll* p. 19669.

The kind of fire they are playing with here was shown clearly by Patrick Bahners when he wrote, in reference to the verdict against the leader of the right-wing National Democratic Party of Germany,<sup>47</sup> Günter Deckert:

*“If Deckert’s [revisionist] ‘view of the Holocaust’ were correct, it would mean that the Federal Republic of Germany was based on a lie. Every presidential address, every minute of silence, every history textbook would be a lie. In denying the murder of the Jews, he denies the Federal Republic’s legitimacy.”*<sup>179</sup>

Anyone who tries to make the legitimacy of the Federal Republic of Germany’s existence hinge on the truth or falsehood of historiography about a detail of contemporary history (and almost all the major media and many politicians have been doing this lately), suffers from a profound misconception of the foundations of this Republic, which is not based on the Holocaust but on the agreement of its citizens and on inalienable human and national rights. At the same time, such a person commits several unpardonable sins. First, he gives the actual enemies of the current German republic an easy means for destroying this system. Further, it is both irresponsible and ridiculous to make the weal and woe of a nation dependent on a ‘detail of history’. Everybody who is confronted with this opinion must wonder what he should think of a state that tries to define certain views of history as the ultimate truth by means of the threat of prosecution, and which slanders dissidents as enemies of democracy. Friedrich Karl Fromme, co-editor of the German daily newspaper *Frankfurter Allgemeine Zeitung* and certainly above suspicion where anti-democratic leanings are concerned, recently wrote:

*“Historical truth cannot be established by criminal law; such endeavors do not become a state committed to liberality, no matter how painful or embarrassing it may be in individual cases.”*<sup>180</sup>

One might expect that the truth will hold its own in a factual, scientific encounter even without the protection of criminal law. On the other hand, it is almost impossible for truth to prevail under the constant threat of criminal prosecution.

So, what is such a state to do when it turns out that the Revisionists really are right? Is it supposed to dissolve itself? Or is it supposed to ban the study of history and to jail all historians? It is easy to see how far from the straight and narrow such erroneous views lead: someone who pretends to wish to protect this Republic through the ruthless defense of the standard Holocaust tales will, in the crunch, find himself forced to undermine the actual pillars of this state, which are freedom of expression, freedom of research, teaching and science, and an independent justice system under the rule of law. He thus becomes, not the protector of a free and democratic fundamental order, but its greatest threat.

That this threat is more than real was shown by the reactions to the infamous Mannheim verdict against Günter Deckert. In this instance, one of the foremost principles and prerequisites of a state under the rule of law, namely the independence of the trial judges, was annulled in that two of the three judges were punished for their verdict by means of their (forcibly extracted) ‘notification of illness’ and subsequent forced retirement, while all the time threatened to be prosecuted for an Orwellian, *Brave New World* type “*perversion of justice*”. They were accused not only of having sentenced Deckert too leniently, but also of having considered the subjective aspects of Deckert’s offense in too much detail and too benevolently.<sup>181</sup> While such in-depth and benevolent evaluation of subjective aspects was introduced as part of the liberal policies of the past few decades, and is very much desired when what is at issue is the sentencing of common criminals or even Leftist political offenses (such as violent demonstrations against industrial construction projects), this practice is suddenly turned into a

<sup>179</sup> Patrick Bahners, “*Objektive Selbstzerstörung*”, *Frankfurter Allgemeine Zeitung*, Aug. 15, 1994, p. 21.

<sup>180</sup> “*Strafrecht und Wahrheit*”, in *FAZ*, April 22, 1994, p. 1.

<sup>181</sup> Cf. the German daily and weekly press of the first two weeks of August 1994; cf. also Günther Herzogenrath-Amelung “*Gutachten im Asylverfahren von Gernmar Rudolf*”, *VffG*, 6(2) (2002), S. 176-190 (online: [vho.org/VffG/2002/2/Amelung176-190.html](http://vho.org/VffG/2002/2/Amelung176-190.html))

scandal when it benefits a right-winger. Whether the overemphasis on subjective aspects, to the detriment of deterrence, is an advantageous facet of our modern justice system or not is a moot point. What should be cause for concern, however, is the obvious fact that in trials against persons who dispute certain aspects of the National Socialist persecution of the Jews, it is no longer only the objective facts of the case – for example, the question of whether the claims made by the accused are true or not – which are decided on by the justice system even before start of the trial, namely through the ‘judicial notice’ credo. If the media, the politicians, and even many jurists have their way, the subjective aspects are now also supposed to be settled beforehand! A Holocaust Revisionist *may* not, on principle, have any good character traits, he *must* perforce have only evil intentions and *must* therefore be sentenced without mercy or compassion – that is the basic trend in the media’s reactions. This renders the trials against Holocaust disputers nothing more than show trials whose results and verdicts are already set in advance.

Beyond that, it would be little short of a miracle if the judges in the Federal Republic of Germany had not learned – from the way in which their Mannheim colleagues’ careers were abruptly cut short – that if they wish to keep their own jobs, they better convict Revisionists without mercy. My statement, that a point at issue for the judges in trials against Revisionists is always whose head it is that will roll: that of the accused or that of the judge – a statement that was controversial in 1993<sup>182</sup> – has thus been proven entirely correct only one year later. In practice it has even been taken a step further: to save his own skin it does not suffice for the judge to merely convict the accused; no, in addition he must also show the accused to be a monster, and must punish him as harshly as possible.<sup>183</sup>

The parallel drawn by M. Köhler (in his chapter in this book) between the medieval witch trials of suspected demonic agents and today’s trials against suspected ‘Holocaust Deniers’ has thus proven more than true.<sup>184</sup>

The misconception about the foundations of the free and democratic basic order of the Federal Republic of Germany also gives rise to another danger for this order. This danger lies in the circumstance that the advocates of this misconception also declare as enemies of the state such people who wish no evil on this state and its citizens, or who are even prepared to serve and benefit it; these people are demonized merely for the reason that they hold different opinions about certain aspects of contemporary history. Consequently, imaginary enemies are created. By means of the incitement against them, loyal citizens of the state are practically forced into the role of enemy – in other words, the process creates the very enemy it pretends to fight. This self-generated enemy is then used to justify the escalating restrictions on the fundamental rights guaranteed by the German Constitution, as described. With the increasing scientific success of revisionism, this forcing of basically well-meaning citizens into an unwanted enemy role must lead to social polarization which is anything but beneficial to the internal peace of the Federal Republic of Germany.

*To protect the status and reputation of Germany, therefore, it is high time to strive for objective, scientific dialogue and to assign to the Holocaust the role it deserves, namely as merely one stone in the mosaic of history.*

Scholarship is a process of constant revision. As this edition appears, portions of it may be superseded by new findings. That is so in almost every field of science. Now that the archives of the former Eastern Bloc nations have at last become accessible, our view of the Second World War and the events associated with it is changing rapidly. In order to give our readers the opportunity to keep

---

<sup>182</sup> E. Gauss, *Vorlesungen über Zeitgeschichte*, Grabert, Tübingen 1993, p. 261 (online: [vho.org/D/vuez/v4.html](http://vho.org/D/vuez/v4.html)).

<sup>183</sup> The revocation of the judges’ independence was also acknowledged by the jurist Dr. Martin Kriele, “*Ein Eingriff mit Präzedenzwirkung*”, *Frankfurter Allgemeine Zeitung*, Sept. 15, 1994, p. 14.

<sup>184</sup> Cf. W. Kretschmer, “*Der mittelalterliche Hexenprozeß und seine Parallelen in unserer Zeit*” (The medieval witch trials and its parallels in our time), *DGG* 41(2) (1993), pp. 25-28 (online: [vho.org/D/DGG/Kretschmer41\\_2.html](http://vho.org/D/DGG/Kretschmer41_2.html)).

abreast of the latest developments, we have added Internet addresses to the footnotes of this book which, it is hoped, will continue to make developments in this discussion accessible to the public for years to come, despite increasing attempts in western countries to censor precisely this kind of content.<sup>185</sup>

This book does not pretend to give definitive answers to the many whats and hows of the history of the Holocaust, as everything has to be permanently revised due to new findings. Nor does it try to describe, in detail or in brief, how certain events happened, as do most history books. This book rather goes to the very roots of historiography: document criticism and detailed, interdisciplinary expert analysis of certain (alleged) historical events. It simply attempts to build, or to reveal, a solid and exact scholarly foundation about a few sections of contemporary history, on which a source discriminating historiography can rely in its future research.<sup>186</sup>

Furthermore, the purpose of this book is the factual, scientific *debate* about the question of where the truth is to be found regarding the Holocaust. This volume is to serve as a *beginning*, not as conclusion to this debate. Everything else may follow. We hereby introduce our theses regarding subsections of the Holocaust and look forward to objective replies and possibly refutations. Anyone, however, who can think of no better reply to our work than cheap polemics has disqualified himself from a factual point of view from the outset.

## 12. About Academic Freedom

*“The protection that the Law provides for academic freedom depends neither on the correctness of methodology or the results, nor on the soundness of the arguments or line of reasoning, nor on the completeness of the points of view and evidence forming the basis of a scientific treatise. Good or bad research, truth or untruth of findings can only be assessed scientifically [...] Thus, academic freedom also protects minority opinions as well as approaches to, and findings yielded by, research that proves incorrect or flawed. Similarly, unorthodox or intuitive approaches are protected by the Law. The only prerequisite is that what is in question is scientific or academic; this includes anything which, by virtue of form and content, is to be regarded as a serious attempt to ascertain truth [...]*

*No work may be denied scientific or academic character for the sole reason that it is one-sided or incomplete or neglects to adequately consider contrary opinions. [...] A work fails to qualify for scientific or academic character only if it fails to meet the requirements of scientific or academic approach not only in individual respects or as defined by specific schools of thought, but systematically. In particular, this is the case when the work is not intended to ascertain truth but merely to give an appearance of scientific origin or provability to preconceived opinions or findings. One indication of this may be the systematic disregard of facts, sources, opinions and conclusions which cast the author’s views into doubt. On the other hand, it does not suffice for a work to be deemed unscientific in the course of intra-disciplinary controversy between diverging material or methodological approaches.”*

Verdict of the German Federal Constitutional Court,  
January 11, 1994, Ref. 1 BvR 434/87, pp. 16f.

---

<sup>185</sup> We tried to give the URLs for all articles available online at the time this book went to the printers, but since the amount of articles and books available online increases rapidly (and addresses keep changing), it might be advisable to go to the revisionist database at [vho.org/i](http://vho.org/i) for current file locations. In May 1998, this site was censored by the German Federal Review Office for Youth-Endangering Publications (*Bundesprüfstelle für jugendgefährdende Schriften*, ref. Pr. 273/98 UK/Schm, May 12, 1998, cf. online: [vho.org/censor/BPjS\\_vho.html](http://vho.org/censor/BPjS_vho.html)). Other top leading websites are: [codoh.com](http://codoh.com); [www.air-photo.com](http://www.air-photo.com) (this site was banned in Germany as well); [ihr.org](http://ihr.org) (*The Journal of Historical Review*); [aaargh.vho.org](http://aaargh.vho.org) (mainly French).

<sup>186</sup> That is, by the way, the origin of the German title of this book: *Foundations for Contemporary History*.

A comparison of establishment history writing on the so-called Holocaust with more recent revisionist publications reveals a fundamental difference between the two scholarly communities. In the following I would like to consider this difference, and how it illuminates the concerns addressed in this book.

As already mentioned, the establishment historiography dealing with the National Socialist persecution of the Jews *assumes* that certain events of recent history took place in a certain, widely accepted manner. When writing about the actual events of physical extermination of the Jews, witness statements are almost the exclusive form of evidence in establishment historiography. These statements are rarely examined critically, nor can any comprehensive document criticism be found; the interpretation of a document in the framework of the thousands of other documents that provides its context is particularly rare.<sup>187</sup>

Often it is considered sufficient to cite portions of documents out of their proper context, or arbitrarily select a few documents from many others of relevance. The well-known book by Daniel J. Goldhagen represents in effect the climax of this approach,<sup>138</sup> and it has been massively criticized for this even from the establishment side. However, Goldhagen's work is merely the logical, radical conclusion of this general tendency to selectively interpret source materials. Consequently, the criticism directed at Goldhagen generally reflects poorly on his establishment critics themselves.<sup>139</sup> Two prominent examples for such poor historiography are the well-known authors Jean-Claude Pressac<sup>188</sup> and Danuta Czech.<sup>189</sup> Both profess to reconstruct the history of Auschwitz (or Auschwitz-Birkenau) on the basis of documents and, in the case of Danuta Czech, also of eyewitness testimony.

Aside from the fact that, where gas chambers and mass extermination are concerned, both authors clearly give eyewitness testimony priority over all other forms of evidence and thus proceed in a grossly unscientific manner, their books also exhibit two other grave errors. First, neither of the two authors has attempted to draw on the hundreds of thousands of documents stored in the Moscow, Auschwitz and Prague archives to write a history of the camp as reflected in the original documents. Both authors content themselves with choosing, from amongst the masses of all that is available, only such documents that they find appealing, and then combining them into an overall picture that reflects their bias.

Furthermore, in almost every one of its treatises, the science of history as espoused by the historians of the establishment ignores, on principle, any opposing scientific or academic view that the Revisionists submit regarding the Holocaust. A prime example of this are Jean-Claude Pressac's books, frequently propagated in the late 80's and early 90's as the 'last word' of Holocaustology.<sup>188</sup> Despite claiming to refute the Revisionists' arguments, Pressac systematically disregards any and all facts, sources, opinions and conclusions that cast his own view into doubt. No revisionist work is cited, not one single revisionist argument is discussed. One could live with that if at least he did justice to what he promises in his book's title, namely to present a treatise sound in technical, *i.e.*, technological respects. In fact, however, his work contains not a single source from a technical pub-

---

<sup>187</sup> With this, I include all the speeches, addresses, articles, diaries and calendars of the witnesses Hitler, Himmler, Goebbels, Frank, and all the others. Whatever these documents reveal, at best, they reflect what these persons thought they knew, what they felt or intended, what they wanted their audience to hear and their readers to read. In most cases, these documents do not, by themselves, prove what happened, when, where, by and to whom. All they can do is to raise our suspicions that something might have happened. What actually occurred will be made clear with the support of material and documentary evidence directly related to the alleged events.

<sup>188</sup> *Auschwitz: Technique and Operation of the Gas Chambers*, The Beate Klarsfeld Foundation, New York 1989; Pressac, *op. cit.* (note 120); by the way: Pressac is a pharmacist, not an engineer, not an architect, not a toxicologist, not a chemist, not an historian.

<sup>189</sup> D. Czech, *Auschwitz Chronicle, 1939-1945*, Henry Holt, New York 1989.

lication. It does not contain even one conclusion drawn from his own technical studies or those of others. Further, he mingles his own frequently unfounded opinions indistinguishably with the contents of documents he quotes – an academically most unsound procedure.<sup>121</sup> One would be fully justified in saying that Pressac systematically disregards not only arguments running counter to his own views, but also the scientific method as a whole.

Exactly the same is true for Prof. Robert Jan van Pelt's works.<sup>190</sup> Pelt does not quote a single source of the expert literature about toxicology, chemistry, engineering, or architecture. He does not perform a single calculation, and he does not care about the vast research done by others, like GERMAR RUDOLF, CARLO MATTOGNO, FRANCO DEANA, WERNER RADMACHER, FRIEDRICH PAUL BERG.<sup>191</sup>

Not surprisingly, such a *modus operandi* results in the grotesque situation where documents of 'innocent' or at best ambiguous content are taken out of their proper context, declared to be "*criminal traces*" (J.-C. Pressac), and promoted to the status of central evidence for the Holocaust, even though these documents have nothing at all unusual about them when considered in context.<sup>192</sup> A truly scientific study of the Auschwitz concentration camp, however, would have to consider all other documents as well and would have to assign each document its proper place and significance in the context of the many others. It is telling that no-one has tackled this gargantuan task to date. Evidently none of the many Holocaust 'scholars' springing up like mushrooms, especially in the United States, is interested in a solid history of this camp, based on documentary evidence. Or are they simply too lazy?

One reason for their missing motivation can be found by simply looking at the editorial board of the world's leading Holocaust journal *Holocaust and Genocide Studies*. Aside from historians and political scientists, one of the leading professions represented is – theology.<sup>193</sup> This is not surprising, since it is widely accepted that the Holocaust is a "*founding myth of Israel*"<sup>194</sup> and a sort of a new

<sup>190</sup> R. van Pelt, D. Dwork, *Auschwitz: 1270 to the Present*, Yale, University Press 1996; van Pelt, *op. cit.* (notes 120, 129); cf. review by Carlo Mattogno, "Architektonische Stümpereien zweier Plagiatoren", *VffG*, 4(1) (2000), pp. 25-33 (online: [vho.org/VffG/2000/1/Mattogno25-33.html](http://vho.org/VffG/2000/1/Mattogno25-33.html); English: "Auschwitz 1270 to the Present", [www.russgranata.com/irving.html](http://www.russgranata.com/irving.html)); Robert Jan van Pelt, *The Case for Auschwitz. Evidence from the Irving Trial*, Indiana University Press, Bloomington/Indianapolis 2002; see also Robert H. Countess "Van Pelt's Plea against Sound Reasoning", *The Revisionist* 1(1) (2003), pp. 99-104 (online: [vho.org/tr/2003/1/Countess99-104.html](http://vho.org/tr/2003/1/Countess99-104.html))

<sup>191</sup> For a detailed critique of van Pelt's flawed *The Pelt Report* see GERMAR RUDOLF, "Gutachter- und Urteilsschelte", *VffG* 4(1) (2000), pp. 33-50 (online: [vho.org/VffG/2000/1/Rudolf33-55.html](http://vho.org/VffG/2000/1/Rudolf33-55.html); Engl.: [vho.org/GB/Contributions/RudolfOnVanPelt.html](http://vho.org/GB/Contributions/RudolfOnVanPelt.html) and [.../CritiqueGray.html](http://vho.org/GB/Contributions/CritiqueGray.html)); by the way: Dr. van Pelt, Professor for Architecture, is not an architect, but a cultural historian who has specialized on the history of architecture!

<sup>192</sup> W. Rademacher discusses a few of Pressac's "*criminal traces*", cf. his contribution in this volume. For more details see there.

<sup>193</sup> Three members of the editorial advisory board are theologians by profession: Eugene J. Fisher, Secretariat for Catholic-Jewish Relations; Robert McAfee Brown, Pacific School of Religion; John T. Pawlikowski, Catholic Theological Union. Deborah E. Lipstadt, Professor for Modern Jewish and Holocaust Studies at the Department of Religion at Emory University, received her M.A. and Ph.D. in Jewish Studies, *i.e.*, Jewish Religion, from Brandeis University. Maybe there are even more, but this cannot be discerned from their name and/or position. At the Stockholm International Forum on the Holocaust (26-28 January 2000), the religious nature of the Holocaust was clearly stated by Rabbi Michael Berenbaum in the group discussion attended by Press accredited member of the Institute for Historical Review, Dr. Robert H. Countess. Berenbaum said (paraphrase): "As I observe young people in relativistic societies seeking an absolute for morals and values, they now can view the Holocaust as the transcendental move away from the relativistic, and up into the absolute where the Holocaust confronts absolute Evil [=Nazism] and thus find fundamental values." Workshop no. 6, on Holocaust and "Testimony in Education", January 27, 2000, Room Ed 6, 16:30-18:00. Present: Berenbaum, Chairman, Kitty Hart, Renée Firestone, Trudy Gold, Malka Tor, Ben Helfgott, Barbara Engelking (about 16 persons total).

<sup>194</sup> Cf. Roger Garaudy, *Les mythes fondateurs de la politique israélienne*, La Vieille Taupe, Paris 1995 (online: [codoh.com/inter/intmythgarind.html](http://codoh.com/inter/intmythgarind.html)); English: *The Founding Myths of Modern Israel*, Institute for Historical Review, Costa Mesa, CA, 2000 (online: [codoh.com/zionweb/zionmythgar.html](http://codoh.com/zionweb/zionmythgar.html).)



secular religion of modern Jewry<sup>195</sup> that is used by Jewish organizations to garner support for Israel, promote Jewish identification, and advance the cause of multi-culturalism.<sup>196</sup> And it is well known that religions and political ideologies are more interested in defending dogma than in searching for truth.

Among the Revisionists, on the other hand, aside from historians, there are many engineers and exact scientists (physicists, chemists, geologists).<sup>197</sup> Since scholars in the exact sciences have a completely different approach to their fields – “*You must never trust an eyewitness account.*”<sup>198</sup> –, it is no surprise that their results are completely different from those of scholars swayed by theology.

First of all, the discussion of the opinions on the Holocaust as they are recorded in the works of establishment historians is the heart of the matter of this handbook. Nothing is disregarded. The intensive examination of facts, sources, opinions and conclusions of the opposing side is the foremost reason for the publication of this book.

Secondly, the critique of documents and witness testimony has always been the domain of revisionist analysis and fundamental criticism. The present volume contains several chapters on this subject, so I will dispense with a detailed discussion here.

Finally, in insisting on hard, *i.e.*, documentary and material facts, the revisionist side has begun the task of writing a reliable history of the Holocaust basing almost entirely on the *total* documentary and material record available, and supported by proper and exact scientific expertises.

*This is, what science is all about. And it is a heinous crime to punish revisionist scientists for their findings, as many European countries do today.*

However, due to constraints of time and finances, the Revisionists’ focus has been on resolving one detail after the other, fitting the mosaic together piece by piece. But since the Revisionists are being increasingly persecuted for their labors by state prosecution, especially in Europe (lately the

---

<sup>195</sup> Cf. Moshe Zimmermann, *Aus Politik und Zeitgeschichte* 42(1-2) (1992) p. 33-43.

<sup>196</sup> Cf. for this Peter Novick, *The Holocaust in American Life*, Houghton Mifflin, Boston 1999; Norman Finkelstein, *The Holocaust Industry: Reflections on the Exploitation of Jewish Suffering*, Verso, London/New York 2000. In this context, attention may be drawn to Kevin MacDonald’s trilogy about Judaism, published by Praeger, Westport (Connecticut) as part of the series *Human Evolution, Behavior, and Intelligence*, with series editor Seymour W. Itzkoff. This trilogy seeks to develop an understanding of Judaism that is based on modern social and behavioral sciences, specifically the theory applied to animal behavior known as Group Evolutionary Strategy. In the first volume, *A People That Shall Dwell Alone* (1994) MacDonald presents the positives of his thesis, conceptualized as successful Jewish cultural and genetic segregation and protection from Gentile societies. In *Separation And Its Discontents* (1997) he presents the negative reactions to this Jewish evolutionary group strategy from Gentiles, an ethnic conflict generally referred to as “*Anti-Semitism*”. In *The Culture Of Critique* (1998) MacDonald demonstrates a more narrow focus – that of the 20th century – wherein the Boasian school of anthropology, Freudian psychoanalysis, leftist political ideology and behavior, the Frankfurt School of Social Research, and New York Jewish intellectuals have both openly and covertly attempted to alter western societies in order to end “*Anti-Semitism*”. At bottom, the evidence contained in these volumes demonstrates that Jewish group strategy reveals that Jews and Gentiles have different interests in the construction of culture. This trilogy is most relevant to the present handbook inasmuch as the “*Holocaust*” – whatever that term means for Jews – has been formed and utilized by Jews for the advantageous promotion of narrowly ethno-centric Jewish interests. Universal applications of the “*Holocaust*” are tangential when applied to non-Jewish interests and values.

<sup>197</sup> Regarding the authors of this book: Engineers: John C. Ball, Friedrich P. Berg, Arnulf Neumaier, Werner Rademacher, Hans Jürgen Nowak; historians: Ingrid Weckert, Carlo Mattogno, Joachim Hoffmann; political scientist: Udo B. Walendy; lawyer: Karl Siegert; geologist: John C. Ball; chemist: Gernar Rudolf; Robert Faurisson, now retired, was professor for text, document and witness account criticism.

<sup>198</sup> This was the response of my Ph.D. supervisor Prof. Dr. Dr. hc. Hans Georg von Schnering when one of his assistants, Dr. Harald Hillebrecht, quoted a statement of a colleague as proof for an allegation (January 20, 1993, 9:48, room 4D2, Max-Planck-Institut für Solid State Research, Stuttgart.). Needless to say, Prof. von Schnering rejects his own maxim where the ‘Holocaust’ is concerned.

Federal German government has even tried to exert diplomatic pressure on eastern European countries to make it more difficult for us to access the archives there),<sup>199</sup> their work will probably take many more years. This volume contains only a few examples; of these, Carlo Mattogno's articles in particular are based on intensive archival research, which he has been conducting for many years. Further findings worthy of publication in book form will likely become available in the coming months and years.<sup>200</sup>

### 13. The Scientist's Ethical Responsibility

Let us assume for the moment that our theses are correct. Should this be kept from the world, or should it be made known? Or, to put it more clearly: can the dissemination of our theses have negative consequences for the co-existence of different peoples? It is a negative possibility; but it is also possible that it may have positive consequences, just as it is conceivable that the dissemination of the view commonly held of the Holocaust today may also have had, and may continue to have, not only positive but also negative effects on the co-existence of different peoples, especially as far as the Germans are concerned. The crucial factor in determining the political ramifications of a scientific theory, *i.e.*, insight, is its treatment in politics and, today, especially in the media. A theory or insight cannot be eliminated by attempts to suppress or even to ban it, by whatever means. Even self-denial on the part of the scientist can result at most in a delay, but never in a termination of the process of learning and discovery. Friedrich Dürrenmatt described this accurately in his drama *The Physicists*. No power on earth can stop the process of learning and discovery. That is why a wise politician must strive to incorporate this process into a framework in accordance with his ideas and goals. This implies that politics must determine its objectives at least roughly in accordance with the state of scientific knowledge.

At present many people in the western hemisphere have grown very comfortable with the standard view and vigorously oppose new insights and findings on the Holocaust. They are loath to give up their simplistic view of good vs. evil historical personages and ideologies. Recently, however, new untamed forces have appeared on the horizon, forces that won't be slain by the conservative inertia that paralyzes the increasingly decrepit Great Powers: these forces are nationalism and Islamic fundamentalism. It is difficult to say at this point whether they will prove to be a curse or a blessing. Yet it is already clear that these two forces have the power to revolutionize the current system of world politics, and the decrepit Great Powers know it.

Historical revisionism is the first great intellectual adventure of the 21<sup>st</sup> century. Judging from the way things look today, this revisionist adventure will in the future be more than just an intellectual one, though.

Whoever controls the histories of nations controls those nations and their peoples. The Second World War ended in the total victory of the enemies of the Third Reich and its allies. Their victory gave the conquerors a power to write the world's history that was unprecedented in scope. But the power that brings total victory intoxicates. Like their predecessors, the victors, in their hubris, would write a history that was arbitrary, self-serving, and at odds with what actually happened. No less inevitable than this intoxication of victory, however, is the gradual erosion of their one-sided view of history, and thus an erosion of the power based upon it. Viewed in this way, historical revi-

---

<sup>199</sup> Cf. epd/AFP, "Herzog: Sudendentische sollen Nachbarschaft gestalten", *Frankfurter Allgemeine Zeitung*, Oct. 17, 1997; cf. W. Rademacher, G. Rudolf, "Appell an unsere Unterstützer", *VffG* 2(1) (1998), pp. 83-86 (online: [vho.org/VffG/1998/2/RadRud2.html](http://vho.org/VffG/1998/2/RadRud2.html)); G. Rudolf, "Wer zu spät kommt, den bestraft das Leben", *VffG* 2(3) (1998), p. 165 (online: [vho.org/VffG/1998/3/Rudolf3.html](http://vho.org/VffG/1998/3/Rudolf3.html)).

<sup>200</sup> Cf. the books published by *Theses & Dissertations Press* in its Holocaust Handbooks Series ([tadp.org](http://tadp.org)), as well as current papers published in *VffG* (online: [vho.org/VffG](http://vho.org/VffG)) and *The Revisionist* ([vho.org/tr](http://vho.org/tr)).

sionism is a weapon against abusive political power. Nor does it function as such a weapon only at present: it has in the past, and will do so in the future.

The possible political impacts of the findings of Holocaust revisionism become apparent if one considers what in our world is being dominated by the Holocaust taboo. I have shown elsewhere that the social sciences of western societies suffer under severe restrictions as soon as topics are involved which somehow can be brought into context with the Third Reich, even if the way it is brought into such a context is sometimes quite pathological.<sup>201</sup> Subsequently, western societies are increasingly incapable to solve their social problems. Willis Carto has drawn attention to the financial consequences for U.S. taxpayers as a result of the Holocaust taboo, which is in the order of magnitude of many hundred billion dollars.<sup>202</sup> Robert Hepp has summarized what would be at stake, should it turn out publicly that our opinion about Second World War in general and the Holocaust in particular is seriously wrong: basically the entire postwar world order.<sup>203</sup> Under these circumstances, simply everything might be jeopardized on which the reigning power elites depend.

The new, emerging forces of nationalism and Islamic fundamentalism have obviously understood this, and are grasping the intellectual weapon of revisionism which will enable them to dethrone the old and waning powers once and for all. It is my conviction that awaiting us after the intellectual adventure of revisionism is a second, political adventure at the outset of the 21<sup>st</sup> century that will draw its ammunition to no small extent from the findings of historical scholarship.

The role of the scientist in this process ought to be to repeatedly remind politicians of the aforementioned insight: banning something does not eliminate it, it only makes it all the more interesting to those factions that enjoy working in the twilight of the semi-legal or illegal. But most of all, the legislators and powers-that-be who impose bans on research and science invariably place themselves in the wrong in the eyes of the public, and thus lose all their credibility, for anyone who forbids discussion is quickly suspected of having something to hide, or of lacking sound arguments of his own.

Anyone who wishes to keep certain insights or theses from being misused by extremist groups can only succeed by addressing the issues in question himself. In other words, if Racists, National Socialists and anti-Semites are to be prevented from using Holocaust revisionism for their own political purposes, their opponents have to cover revisionism themselves. Responsibility and leadership has to be taken *inside* Holocaust revisionism in order to determine, how unavoidable revisions of our views of history affect the self-understanding of our societies. One has to take an offensive rather than a defensive approach to revisionism.

It ought therefore to be the foremost concern of moderate politics to see to it that the discussion about the Holocaust spreads to social circles other than radical or extremist ones, so that any potential consequences of a revision of historiography can be represented and implemented credibly and competently by respectable and respected politicians. And the foremost concern of the scientist must be to alert the politicians to this fact and to accompany them as they steer their way among the cliffs of scientific insights.

It is to be hoped that revisionist historians will be able to resist the Faustian temptation to intoxicate themselves on their power that probably will increase in future.

Thus, this book is offered as intellectual ammunition, but is *not* meant to serve any political ideology. Scholarship serves a cause, the cause of Truth. Historiography must follow the motto of the

---

<sup>201</sup> Germar Rudolf, "Wissenschaft und ethische Verantwortung", in Andreas Molau (ed.), *Opposition für Deutschland*, VGB, Berg am Starnberger See 1995, pp. 260-288.

<sup>202</sup> Willis Carto, "Why is 'The Holocaust' important", in Michael Collins Piper, *Best Witness. The Mel Mermelstein Affair and the Triumph of Historical Revisionism*, Center for Historical Review, Washington, D.C., 1994, pp. 227-234.

<sup>203</sup> R. Hepp, *op. cit.* (note 9), note 49, pp. 141f.

Greek Muse Clio: “*Get it right!*” As a proper guideline, I have added a few paragraphs written by Bruno Leoni. May the reader be inspired by this.

Germar Rudolf,<sup>204</sup> Rothenburg o.d.T., August 25, 1994  
revised: Chicago, IL, April 29, 2003

---

Bruno Leoni, *Freedom and the Law*, Indianapolis, Liberty Fund, 1991, pp. 148-150:

*“No truly scientific result has ever been reached through group decisions and majority rule. The whole history of modern science in the West evidences the fact that no majorities, no tyrants, no constraint can prevail in the long run against individuals whenever the latter are able to prove in some definite way that their own scientific theories work better than others and that their own view of things solves problems and difficulties better than others, regardless of the number, the authority, or the power of the latter. Indeed, the history of modern science, if considered from this point of view, constitutes the most convincing evidence of the failure of decision groups and group decisions based on some coercive procedure and more generally of the failure of constraint exercised over individuals as a pretended means of promoting scientific progress and of achieving scientific results. The trial of Galileo, at the dawn of our scientific era, is in this sense a symbol of its whole history, for many trials have since actually taken place in various countries up to the present day in which attempts have been made to constrain individual scientists to abandon some thesis. But no scientific thesis has ever been established or disproved in the end as a result of any constraint whatever exercised upon individual scientists by bigoted tyrants and ignorant majorities.*

*On the contrary, scientific research is the most obvious example of a spontaneous process involving the free collaboration of innumerable individuals, each of whom has a share in it according to his willingness and abilities. The total result of this collaboration has never been anticipated or planned by particular individuals or groups. Nobody could even make a statement about what the outcome of such a collaboration would be without ascertaining it carefully every year, nay every month and every day throughout the whole history of science.*

*What would have happened in the countries of the West if scientific progress had been confined to group decisions and majority rule based on such principles as that of the ‘representation’ of the scientists conceived of as members of an electorate, not to speak of a ‘representation’ of the people at large? Plato outlined such a situation in his dialogue *Politikos* when he contrasted the so-called science of government and the sciences in general with the written rules enacted by the majority in the ancient Greek democracies. One of the characters in the dialogue proposes that the rules of medicine, of navigation, of mathematics, of agriculture, and of all the sciences and techniques known at his time be fixed by written rules (*syngammata*) enacted by legislatures. It is clear, so the rest of the characters in the dialogue conclude, that in such a case all sciences and techniques will disappear without any hope of reviving again, being banished by a law that would hinder all research, and life, they add sadly, which is so hard already, would become impossible altogether.*

*Yet the final conclusion of this Platonic dialogue is rather different. Although we cannot accept a state of affairs like this in the scientific field, we must, said Plato, accept it in the field of our law and our institutions. Nobody would be so clever and so honest as to rule over his fellow citizens in disregard of fixed laws without causing many more inconveniences than a system of rigid legislation.*

*This unexpected conclusion is rather similar to that of the authors of the written codes and written constitutions of the nineteenth century. Both Plato and these theorists contrasted written laws with the arbitrary*

---

<sup>204</sup> Earlier versions of this article were signed with the name Ernst Gauss, which is a pen name Germar Rudolf chose in 1992/1993 for his first book *Vorlesungen über Zeitgeschichte* (Grabert, Tübingen 1993) to protect himself from German state persecution which indeed started shortly afterwards. In 1994, the publisher of the original German version of this handbook, Grabert Verlag, urged Rudolf to continue using this pen name since it had gained reputation, and for safety reasons for both the publisher and the editor. Since there is currently no danger for the editor of this book, he decided to use his real name openly.

*actions of a ruler and maintained that the former were preferable to the latter, since no individual ruler could behave with sufficient wisdom to secure the common welfare of his country.*

*I do not object to this conclusion provided we accept its premise: namely, that the arbitrary orders of tyrants are the only alternative to written rules.*

*But history supplies us with abundant evidence to support the conclusion that this alternative is neither the only nor even the most significant one open to people who value individual freedom. It would be much more consistent with the historical evidence to point out another alternative - for instance, that between arbitrary rules laid down to particular individuals or groups, on the one hand, and spontaneous participation in the law-making process on the part of each and all of the inhabitants of a country, on the other.*

*If we view the alternative in this light, there is no doubt about the choice in favor of individual freedom, conceived of as the condition of each man making his own choices without being constrained by anybody else to do unwillingly what the latter imposes.*

*Nobody likes arbitrary orders on the part of kings, state officials, dictators, and so on. But legislation is not the appropriate alternative to arbitrariness, for arbitrariness may be and actually is exercised in many cases with the help of written rules that people must endure, since nobody participates in the process of making them except a handful of legislators.*

*Professor Hayek, who is one of the most eminent supporters of written, general, and certain rules at the present time as a means of counteracting arbitrariness, is himself perfectly aware of the fact that the rule of law 'is not sufficient to achieve the purpose' of safeguarding individual freedom, and admits that it is 'not a sufficient condition of individual freedom, as it still leaves open an enormous field for possible action of the State.' (F. A. Hayek, *The Political Ideal of the Rule of Law*, National Bank of Egypt, Cairo 1955, substantially republished in his *The Constitution of Liberty*)*

*This is also the reason why free markets and free trade, as a system as much as possible independent of legislation, must be considered not only as the most efficient means of obtaining free choices of goods and services on the part of the individuals concerned, but also as a model for any other system of which the purpose is to allow free individual choices, including those relating to the law and legal institutions.*"<sup>205</sup>

---

<sup>205</sup> Thanks to Michael Humphrey who discovered and sent me this excellent excerpt.

# The Case of Walter Lüftl

## Contemporary History and the Justice System

WERNER RADEMACHER

### 1. Introduction

In Germany, in the early spring of February 1992, many Austrian and German newspaper dailies<sup>1</sup> reported the resignation of the President of the Federal Austrian Chamber of Engineers, Walter Lüftl, who stepped down from his prestigious position after voicing doubts about the Holocaust. Things calmed down fairly quickly in Germany, while in Austria a fair-sized scandal ensued. The President of the Federal Chamber of Engineers, it was alleged, had expressed ‘Nazi’ sentiments, and cries for the public prosecutor were to be heard.

More sensible and aware persons, however, perked up their ears, since, after all, an engineer and many-thousand-time forensic expert witness from Austria’s high society must surely have had his reasons if he questioned the technical feasibility of some aspects of the Holocaust.

Insiders had realized as early as winter 1991 that something was in the wind, since Lüftl had already published preliminary hints in the engineering paper *Konstruktiv* that not all was right with some historical eyewitness testimony. He did not at that time make reference to the Holocaust, leaving it up to the reader instead to make the connection based on the facts and questions raised.<sup>2</sup>

The basic legal principles of a state under the rule of law demand that subject experts sworn in by the state must accord greater significance to material evidence than to any eyewitness accounts. Lüftl, being such an expert and acting in accordance with this logical stipulation, was more than a little surprised to realize that the generally accepted qualitative hierarchy of evidence appears to be reversed where the Holocaust is concerned: historiography of the Holocaust is dominated by the eyewitness testimony which, he found, frequently does not stand up to expert criticism, but which is nevertheless accepted unquestioningly and is given precedence over the material findings of experts.

He was also surprised to find that the courts take “*judicial notice*” of the events of the Holocaust as described by eyewitnesses – *i.e.*, they consider these accounts to be self-evident and proven facts – not only in order to obviate the need for their formal proof and thus to spare themselves the bother of bringing evidence for these events, but that they also make use of this “*judicial notice*” in order to deny the opposing side the right to bring evidence to the contrary. Lüftl considers this practice to be a violation of human rights, since judicial notice should be taken only of such matters as are also undisputed by both prosecution *and* defense – such as water is wet, fire is hot, and ice is cold. However, as soon as there is any justified and reasonable dispute of any point, such a point must be open to discussion.

Does someone hiding behind rulings of judicial notice not in fact reveal that he does not care to know the truth if it differs from the traditional version (that which is ‘desirable from the perspective of public education’), and that he wishes to keep this truth, by whatever means, from those who would prefer to see actual knowledge replace blind faith? Surely someone who is truly convinced

---

<sup>1</sup> E.g., “*Rücktritt nach Zweifel am Holocaust*”, *Süddeutsche Zeitung*, March 14, 1992.

<sup>2</sup> W. Lüftl, *Konstruktiv* 166 (1991) p. 31f.; cf. also E. Gauss, *Vorlesungen über Zeitgeschichte*, Grabert, Tübingen 1993, pp. 44ff. (online: [vho.org/D/vuez/v1.html](http://vho.org/D/vuez/v1.html))

that the *official* truth corresponds to *his* truth has nothing to fear from any material evidence proffered, which after all he ought to be easily able to refute. But the forensic reality with respect to the Holocaust is that any and all dissenting evidence proffered is dismissed from the start as being “*pseudo-scientific*”. Truth is the sole province of the status quo. ‘Everything has been proved a thousand times over. Arguments to the contrary have been refuted *ad nauseam*’, goes the hollow standard objection, which is simply not true. This arbitrarily assigned self-evidence is the muzzle that is put on truth.

## 2. Austria’s Special Laws

Austria is an oddity which can only be understood if one knows Austria’s history. Since the early Middle Ages, Austria had been part of the German-dominated Holy Roman Empire, to whose name the phrase “*of German Nation*” was later added. Since the end of the Middle Ages at the latest, Austria and its royal house of the Habsburgs was the dominant power in Germany. This did not change until the Silesian Wars, when the Prussian Hohenzollerns under Friedrich the Great, with much martial luck, wrested Silesia from the Habsburgs. Since then, Prussia had claimed equal standing with Austria in Germany, which ever since the late Middle Ages had consisted of hundreds of small kingdoms and principalities. It was not until 1806, when the Holy Roman Empire of the German Nation collapsed under Napoleon’s onslaught, that Austria gave up its leading role in Germany, a role which was assumed by Prussia 60 years later when Prussia again defeated Austria in the Austro-Prussian War.<sup>3</sup> As early as 1848, when the German people urged the princes on to a political unification of the German states, it was clear that due to their involvement in the Balkans the Habsburgs could not participate in the first German unification of 1871, which was being envisaged even then – although the inhabitants of Austria wanted this unification no less than all the other Germans, regardless whether they lived in Bohemia, Moravia, Prussia, Bavaria, Swabia, Saxony, or wherever. The unification of 1871 encompassed only the northern German states, which became the so-called German Reich. However, the relations with Austria-Hungary were very close, and neither side ever gave up hoping or striving for an eventual reunification of both empires into one “*whole Germany*”. This did not become possible until the Austro-Hungarian Empire collapsed after World War One, but at that time the western Allies forcibly prevented the unification of Austria with the rest of the German empire, even though the unification had already been formally agreed upon. Both sides continued to hope that sooner or later the Allies would comply with the Austrian Germans’ right to self-determination, and so, unofficial negotiations continued after 1918 to prepare for Austria’s unification with the rest of Germany, by coordinating laws and decrees. As we know, actual unification did not come about until 1938, when it finally became fact as a result to Adolf Hitler’s no-nonsense approach; and it is important to note that even though the circumstances were perhaps less than ideal, this unification did take place with the overwhelming agreement of the Austrian Germans. Even after World War Two the Austrian Germans did not want to give up their affiliation with “*whole Germany*”, yet again the victorious Allies denied them this option.

This time, however, the Allies went all the way. They established the so-called *Prohibition Order* as prerequisite for ending their military occupation of Austria. This Order provides for severe penalties for any activities serving National Socialist interests, including severe punishment for anyone attempting to undermine Austria’s independence, for example by preparing for or carrying out its reunification with Germany. At the same time, a totalitarian re-education program similar to that imposed on Germany was also instituted in Austria; one of its aims was to strip the Austrians of

---

<sup>3</sup> Formally speaking, the dispute was about who would hold supremacy in Schleswig-Holstein.

their German identity and to define them as a separate people. By now this endeavor has largely succeeded.

The so-called *Prohibition Order* – a separate, independent criminal law existing parallel to the Austrian Criminal Code – is a relic from occupation times which still has the power to impose harsh penalties for certain poorly-defined ‘thought crimes’ labeled as being ‘Nazi’ in nature. Its hazy definition, as well as the randomness with which it criminalizes certain beliefs and convictions, puts this law outside the norms of human rights. Beyond that, it also violates fundamental principles of international law, such as the right of self-determination. What is more, the *Prohibition Order* even violates the Austrian Constitution, which is in compliance with internationally accepted human rights and international laws. But due to the special lie that Austria lives – namely, to consider itself “*Hitler’s first victim*”, but now a “*liberated nation*” – it is impossible for Austria to dispense with this law if it does not wish to jeopardize its own statehood. And since the international community has no wish to see the cooperation between Austria and Germany grow closer, these shortcomings are generously ignored.

### 3. Lüftl’s Violation of a Special Law

In the late 1980s the Holocaust Revisionists became more active in Austria as well. At that time the Austrian Criminal Code did not contain any explicit means for punishing such dissidents. Falling back on the so-called *Prohibition Order*, which provides for severe punishment for any revival of National Socialist activity, turned out to be problematic, however, for the government. Admittedly, judges did not hesitate to impute National Socialist convictions to the accused, and to assume that these intended their revisionist theories to make National Socialist ideology socially acceptable again, in order to restore it to influence and power at some future date. However, the *Prohibition Order* in force at the time provided for a minimum sentence of five and a maximum sentence of twenty years in prison for offenses of this kind, and most judges were hesitant to pass such harsh sentences for mere ‘thought crimes’, so that – in the opinion of the media and of the politicians – the bottom line in all too many cases was an acquittal. A rectification of the matter was demanded by several pressure groups.

The reader will no doubt wonder how any conflict with this law could be possible for a person ‘like you and me’, a person who has lived a decent, industrious life, has no prior convictions – not even a traffic violation –, who has devoted considerable efforts to working on a volunteer basis for the public good. It would take an entire page just to list all the functions and offices W. Lüftl has held and who was ultimately elected to serve in a politically unaffiliated and independent capacity as President of the representative body of his profession – the Federal Austrian Chamber of Engineers. How can it be possible for such a man to come into conflict with the law previously set out and be branded as *dangerous* criminal subject to twenty years imprisonment?

What follows in this article will detail the case of this academically accredited engineer, *Walter Lüftl*.

For Lüftl, it all began with two press releases in the Viennese daily paper *Die Presse* on March 23 and 29, 1991. Both articles reported about the debates by the SPÖ [Austrian Social Democratic Party] and the ÖVP [Austrian People’s Party] regarding the introduction of a new special definition of a crime, namely “*incitement*”, as §283a of the Austrian Criminal Code. This suggested paragraph provides for a term up to one year in prison for anyone “*who denies the fact that millions of human beings, Jews in particular, were killed in concentration camps of the National Socialist regime as part of a program of planned genocide.*”<sup>4</sup>

<sup>4</sup> This suggested paragraph was later abandoned in favor of a new paragraph 3h of the *Verbotsgesetz*.



This prompted Lüftl to write two letters, one to the newspaper *Die Presse* and one to Dr. Michael Graff, the Chairman of the Justice Committee of the Austrian National Council. Their contents in brief: all that the new law will do is promote denunciation. Following a visit to the concentration camp Dachau in 1990, Lüftl had found that the tourist attraction exhibited there as ‘gas chamber’ not only “*had not been used*”, as the tour guide briefly summed up the truth, but was in fact a fake that had been set up by a group of laypersons. Lüftl asked whether this fact, which could be easily proved, would in future brand anyone mentioning it as suggesting perhaps a ‘Dachau Lie’?

Dr. Graff did not respond; the Editor-in-Chief of the *Presse*, Dr. Thomas Chorherr, informed Lüftl on April 5, 1991, that unfortunately his letter could not be published, as it might be misunderstood by the public. On April 10, 1991, Lüftl replied to this with the following letter:

“Vienna, April 10, 1991

Your Ref.: Dr. Ch/P

Re.: Your letter of April 5, 1991

Dear Dr. Chorherr, Editor-in-Chief:

*Thank you for your response; it is rather unusual for an editor-in-chief to reply to the writer of a letter to the editor. It shows that my letter was received with a thoughtful and open mind on your part. I agree that my letter might be misunderstood, particularly when someone wants to misunderstand it; there is also the potential danger of approval from the wrong parties.*

*For this reason I am sending you a memo authored by me and documented with publicly available sources. This memo is not intended in defense of anyone, it is merely intended to raise doubts in the sense of: I cannot tell whether it was this way because I wasn't there, but if it wasn't necessarily this way then one ought to be allowed to talk about it.*

*Even a judge and jury may not convict a defendant if they still have doubts.*

*I ask you to please treat this memo as confidential. It is only for your personal information.*

*If it should raise doubts in your mind as well, then Die Presse must nevertheless take a stand AGAINST §283a; not, however, due to the cause per se (again, I agree with you regarding the potential for misunderstandings), but due rather to the hazard posed to our state under the rule of law. A handful of neo-Nazis are not worth jeopardizing the maxims of a state under the rule of law.*

*Very sincerely yours,*

[signed] *Walter Lüftl*”

The memo mentioned in this letter was a study, *Die neue Inquisition*, which Lüftl had by then written on the basis of information from his own library and of otherwise easily accessible sources.

Lüftl had decided to inform some Deputies to the National Assembly as well as some other ‘opinion leaders’ of the doubts he, as an impartial expert, was entertaining. Naively enough, he hoped that if such doubts were expressed by an expert, not by a ‘neo-Nazi’, they would prompt second thoughts in the persons addressed. Chorherr’s negative attitude had baffled him somewhat, since he recalled that Chorherr had voiced rather vehement objections in the *Presse* when the movie *Holocaust* had been broadcast on Austrian television. What had happened since then to turn this Saint Paul back into a Saul?

In his memo *Die neue Inquisition*, Lüftl, drawing on his subject knowledge of that time, severely criticized a number of core topics of the historiography of the Holocaust,<sup>5</sup> denounced the Austrian legislators’ attempt to prevent the search for truth *ex lege* (by legal means) as being state-proscribed terrorism of conviction, and asked whether the Minister of Justice and the Parliament intended that

---

<sup>5</sup> A later, revised version titled “*Holocaust: Belief and Facts*” was published in *The Journal of Historical Review* 12(4) (Winter 1992-93) p. 391-420.

in the future historians and technical-scientific experts, or even perfectly average persons who merely expressed their doubts, would be dragged into court and convicted without any chance to defend themselves. As the case of Lüftl shows, both the Minister of Justice as well as the Parliament did indeed intend this!

#### 4. Lüftl's Work Behind the Scenes

Since Dr. Graff had not responded to Lüftl's letter of March 23, 1991, Lüftl wrote him again on May 9, 1991, after he had received a visit from the former Club Representative [party whip] of the ÖVP, to whom he had entrusted some documents with the request to pass them on to Dr. Graff. Lüftl drew Graff's attention to the results of his researches to date: irreconcilable inconsistencies and well-founded doubts. 'Contemporary history' and technology simply could not be made to agree. This time Dr. Graff responded, with a letter dated May 13, 1991:

*"Thank you for your letter regarding the planned §283a. The 'Leuchter Report' which you sent me is already known to me. I must say, however, that the personal recollections of so many witnesses who described the atrocities of Auschwitz impress me more than the expositions of the 'Leuchter Report'. I do, however, fully agree with you on the point that only science, not a trial judge, can determine what is truth and what is falsehood."*

On May 19, 1991, Lüftl responded to this letter and pointed out, with examples, that the eyewitness testimony and confessions of alleged perpetrators which he had examined were factually incorrect, and informed Dr. Graff of the contents of a letter he (Lüftl) had sent to Professor Jagschitz on May 10, 1991.

The District Criminal Court of Vienna had summoned Dr. Gerhard Jagschitz, Professor for contemporary history in Vienna, as expert witness in the trial of the Austrian Holocaust Revisionist Gerd Honsik (26b Vr 14.186/86); in a January 10, 1991, letter to the District Court, Jagschitz had mentioned **fundamental doubts about matters of judicial notice**.

Lüftl informed Professor Jagschitz of his own well-founded doubts and urged him to consult the expertise of engineers in order to resolve the questions at issue: had there really been mass executions by means of poison gas, and were there really gas chambers in Auschwitz? Lüftl further wrote to Professor Jagschitz on August 12, October 5, October 21, 1991, and February 20, 1992, pointing out many facts (forgeries and false testimony), providing references to relevant literature, and finally asking him the decisive question:

*"How do you as contemporary historian expect to judge whether a witness is in a position to know something, if you do not consider the material evidence offered by technical experts (Wittgenstein, On Certainty, Clause 441)? All you can do is to quote other sources, without being able to really check the facts! One example: how do you deal with the testimony of a 'witness of atrocities' who claims that '...flames several meters high shot out of the chimneys...'? I know the witness is lying, and I can prove it by means of my expert knowledge, and by calculations and experimentation if need be. But how can you, on the other hand, '...prove that the witness was in a position to know...'?"*

Lüftl therefore urged Professor Jagschitz to recommend to the Court that engineering experts should be consulted. Professor Jagschitz responded for the sake of politeness, but evaded the issue. Germar Rudolf also generously offered Professor Jagschitz his services. The following critique of the *Jagschitz Report* shows the consequences of the Professor's refusal to consider these recommendations.

#### 5. Lüftl's Commission as Expert on the Holocaust

By this time, Lüftl had written the outline for parts of *Holocaust (Belief and Facts)* and was working on corrections and supplements; since his work had meanwhile become known, the German

lawyer Hajo Herrmann of Düsseldorf commissioned him on May 24, 1991 to draw up a report “*about the alleged gassing of human beings during the war in the concentration camps of Auschwitz I and 2, based on on-site investigation*”. An active exchange of letters developed between Lüftl and the lawyer, who wrote the former on June 7, 1991, that the documents he had received showed him a “*chemical and medical aspect*” and that he had therefore written to Germar Rudolf for more information. This was the starting point for the report of academically accredited chemist Germar Rudolf; the reader will find a summary of this report further on in the present volume. For reasons of time it was not possible for Lüftl to go to Auschwitz for on-site investigation, and so his correspondence with attorney Herrmann ended with a letter of July 16, 1991, without Lüftl’s having completed a report. He merely handed in the results he had worked out by then as well as the relevant documents, and answered a number of questions. He amended and supplemented his work *Holocaust* on the basis of the information he had been given by the experts consulted, and concluded his work in August 1991.

Prior to this time Lüftl had sent copies of his work – always the currently up-to-date version – to a number of politicians, including the Minister of Justice, a Club representative, several Deputies to the National Assembly, a Head of Provincial Government, etc., and in February 1992 to a number of Senate Chairmen of the Supreme Court. One of these gentlemen, whose name is here withheld out of gratitude, sent him the following remarkable reply:

*“Walter Lüftl, Accredited Engineer  
Head of Planning and Building Control, h.c.  
President of the Federal Chamber of Engineers*

*March 3, 1992*

*Dear Mr. President,*

*I read your work with great interest. According to press reports the National Assembly has decided to pass the enclosed amendment into law.*

*As far as I am concerned, a law that criminalizes the scientific debate about issues of contemporary history is unconstitutional, and irreconcilable with the basic principles of a state under the rule of law.*

*The new criminal law §3h operates largely with vague legal concepts, but I personally consider it untenable to try to interpret this paragraph to mean that (public) scientific works endeavoring to question or even to refute the accounts given by academics or institutions of certain historical events represent a violation of the law.*

*The scientific endeavor to refute, by technical arguments, the opinion generally held of certain killing methods or the numbers of victims does not in my opinion fall within the province of this law at all, unless the National Socialist genocide or other National Socialist crimes are thereby denied or grossly trivialized. The other potential ways of violating the law do not enter into the picture at all in the case at hand.*

*Of course I cannot give an authoritative interpretation or a prediction of the law’s interpretation by the Supreme Court.*

*Sincerely, [...]*”

The study *Holocaust (Belief and Facts)* was published in English in volume 12, issue 4 (winter 1992/1993) of the *Journal of Historical Review*. It should be briefly mentioned that in it Lüftl stated the motives that had prompted his work, and further, that he believed that a crime begins with the very first person wrongly killed and that it was not the issue to try to argue for a reduction of the number of victims, but rather that the numerous contradictions and the factually incorrect, even deliberately false claims he had pointed out needed to be critically appraised and analyzed by tech-

nical experts. In any case, the doubts entertained by Revisionists were not unfounded, he said, and much more readily reconciled with technological realities than the claims made by orthodox Holocaust writers to date. If, contrary to the expectations of the Revisionists, scientific investigations of the Holocaust – notably by means of material evidence – were to establish the Holocaust as a fact, then the Revisionists, too, would have to accept this. To Lüftl, the questionable aspect of the Holocaust was particularly the alleged mass gassings; the other forms of killing are not mentioned at all by Lüftl due to his lack of familiarity with these topics.

## 6. The Scandal

In February 1992 the Austrian National Assembly had passed the amendment into law.<sup>6</sup> The revised paragraph 3g) and the new paragraph 3h) of the Austrian Special Criminal Code (*Verbotsgesetz*), which is analogous to the contents of the planned §283a Criminal Code, now read as follows:

*“g) Anyone engaging in activities reflecting National Socialist sentiments in any way other than set out in §§3a to 3f – and providing that there is no other law providing for a more severe sentence – shall be punished by a term of imprisonment ranging from one to ten years, and in cases of particular menace posed by the perpetrator or by his actions, by up to 20 years’ imprisonment.*

*h) §3g also applies to anyone who, whether through publication, broadcasting, any other media, or other manner suited to public dissemination, denies, grossly trivializes, applauds or seeks to justify the National Socialist genocide or other National Socialist crimes against humanity.”*

Thus, Lüftl considered his work on this problem to be finished. He had no wish to be a tilter at windmills.

Only a few days later an article appeared in issue 11/92 of the *Wochenpresse / Wirtschaftswoche* titled “*The Nazi Blabber of Walter Lüftl*“ [“*Die Nazisprüche des Walter Lüftl*“], written by a journalist named Reichmann in the typically manipulative style so characteristic of today’s ‘investigative journalism’. Reichmann took factually undeniably true statements such as “*bodies are not fuel; their incineration requires a great input of energy, and a long time*”, out of their proper context and denounced them as “*Nazi blabber*”. He ignored entirely the motives, which had prompted Lüftl’s work.

The outrage was not long in coming. “*Architecture Chief denies Auschwitz*” was the style of one of the more harmless headlines. No researches were initiated, to the contrary. At best there were two or three telephone inquiries whose subsequent print editions usually claimed exactly the opposite of what Lüftl had explained.

The scandal was complete.

The Professional Engineering Associations as well were abuzz with outrage both real (based on ignorance) and induced. Especially the Association of Social Democratic Academics [*Bund Sozialdemokratischer Akademiker*, BSA]. Masonic institutions outdid themselves in screaming for Lüftl’s resignation as President of the Austrian Chamber of Engineers. Being President, Lüftl really could neither be dismissed nor voted out of office, but he did not see the point in trying to continue working with artificially outraged representatives of the civil engineering profession. He had assumed that engineers, of all people, would investigate first and judge later. The President of the Vienna Chamber of Engineers, a Socialist, tried to make stepping down a tempting option for Lüftl by pointing out that the BSA would not pursue legal proceedings against him. What the word of this Social-Democrat is worth was demonstrated by the fact that even with all the induced outrage and boat-rocking there were only two reports to the police: that of Dr. Neugebauer, the professional de-

<sup>6</sup> On February 26, 1992, *Bundesgesetzblatt* 127/92.

nouncer of the Documentation Center of the Austrian Resistance [*Dokumentationszentrum des österreichischen Widerstandes*], and that of the BSA.

Since the office of President of the Federal Chamber of Engineers was no sinecure, but required great sacrifice of time and money from anyone who was truly committed to this function, and to spare his family further grief, Lüftl resigned on March 12, 1992.

It was not long before he received a summons from the District Criminal Court. A preliminary inquiry had been instituted against him on the basis of the two aforementioned denunciations. But the examining magistrate did not care to ascertain the truth; his sole concern was to determine how excerpts of Lüftl's work had found their way into 'radical right-wing publications'. No notice was taken of Lüftl's comment that surely the important point was the correctness of his work and not its place of publication, which might have been the *Atlanta Church News* for all he cared. No, the issue was the 'National Socialist sentiments' that clearly come up whenever anyone records undesirable truths (*i.e.*, such as are directed against matters of judicial notice). There is obviously a sort of 'relative truth' that depends on the medium in which it appears. It is surprising that no one went so far as to speculate that Lüftl himself just might have instigated Herrn Reichmann of the *Wochenzeitung* to carefully select tendentious quotations from his work *Holocaust* and to publish these in his article "*Nazi Blabber*", namely as clandestine "*glorification of the National Socialist regime*"...

Neither the prosecuting attorney nor the examining magistrate could come up with even so much as one sentence, or part of a sentence, that would show Lüftl to have grossly trivialized, approved or justified National Socialist crimes, much less genocide.

On January 15, 1993, Lüftl was informed that on the request of the Public Prosecutor's Office the preliminary inquiry, which evidently had not yielded any incriminating findings, had been 'upgraded' to preliminary investigation, a more serious proceeding.

A motion by Lüftl's defense attorney to abandon the proceedings was rejected on June 28, 1993, on the remarkable grounds

"[...] *that it is clear from the formulation of the work that it is fundamentally suited, when used in a palliative or exculpatory manner, to facilitate the violation of §3g VG [...].*"

In plain English this means that to state the fact that hydrogen cyanide hydrogen cyanideboils at 78.3°F represents National Socialist revivalism if a 'radical right-winger' uses this fact to raise the question of how it could then have been possible to 'gas' people with Zyklon B in only a few minutes in unheated basements. What is more, even to suggest that someone should answer this question for himself by referring to a chemistry text (approved by the Ministry of Education) would be a clear case of "*National Socialist revivalism*". But since Lüftl was no longer accused of 'denial', his defense counsel drew the crystal-clear conclusion in his subsequent objection

"[...] *that the findings [of his work] are obviously correct. In this respect we agree with the Court [...].*"

What we have here is a law clearly in violation of human rights. Lüftl wrote to a good number of Deputies to the National Assembly and asked them whether at the time they had voted this bill into law they had desired the sort of thing that was happening to him. A single deputy wrote back:

"*Your letter disturbs me. I wanted no such thing.*"

## 7. Further Research

Lüftl now saw himself forced to continue working on his study *Holocaust*, even if only for the sake of backing up his defense, as well as to fulfill the requirements of the *Stenographische Protokolle* of the Austrian National Assembly, which permit the "*strictly serious scientific research into specific topics*". Through the intensive study of source literature and through exchange of infor-

mation with qualified experts, his knowledge grew exponentially, since he could now devote to these pursuits the time he had previously spent on volunteer service to the Engineering Chamber. On those points where he had had only ‘educated guesses’ or ‘personal convictions’ to draw upon while writing *Holocaust*, he could now supplement his knowledge to the point of virtual certainty. Today Lüftl feels confident that he can prove each and every claim advanced in *Holocaust* with technical certitude, replicable with all technical evidence and verifiable results. A case in point is his critique of the *Jagschitz Report* that had been submitted in the *Honsik Trial*, discussed in the following (Section 8).

## 8. The Honsik Trial

It is natural that Lüftl took the greatest interest in the *Honsik Trial* which was held before the District Criminal Court of Vienna from late April to early May 1992. He was particularly interested in a report which, contrary to all judicial custom, had not been presented in writing prior to the main hearing. In other words, had only been introduced in the course of the main hearing. This was the Jagschitz Report, by the expert witness Dr. Gerhard Jagschitz who, as ‘contemporary historian’, fought a losing battle from the start where the issue of ‘mass extermination with poison gas’ was concerned.

Even a child could glean from news media coverage that this was no expert report, but rather an accounting to the Court of what the expert had read and what he personally believed. According to his own claims made under oath – so we must believe him, until and unless he is proven false – the expert witness had read 5,000 to 7,000 statements of witnesses and found some two-thirds to be false. However, the expert fails to state his criteria for this examination, which presumably took no more than ten minutes per witness statement. Further, *only* the Court should be in a position to evaluate testimony, and only such testimony as was made before a Court, since after all the accused and his defense counsel must be able to question each witness and possibly to refute this testimony.

But only one single eyewitness statement was introduced in detail into the trial proceedings. This was the documented testimony of “Dr.” Horst Fischer who, however, according to the *Dienstaltersliste der Waffen-SS*, was not a physician at all at the time in question, and hence cannot have performed the functions he testified he performed in Auschwitz.<sup>7</sup> His statement is rife with absurdities, which the expert Dr. Jagschitz failed to recognize as such – and in fact he could not possibly have recognized them, due to his lack of qualifications on the subject. Did he deem Dr. Fischer’s statement to be a “key statement”? Or did he simply fail to find a more incriminating one, one he deemed ‘more credible’? More of that later.

It is self-evident, as well as confirmed by expert observers of the trial, that it was only the massive intervention of the Presiding Judge that saved the expert witness from greater embarrassment during cross-examination by the defense attorney. The fact that in complicated issues it is necessary to provide clarifying commentary before asking one’s question in order to ensure that matters are clear to everyone concerned and that there is no more or less deliberate talk at cross-purposes makes it possible for the Presiding Judge to cut short any preliminary statements that might prove uncom-

<sup>7</sup> B. Meyer (ed.), *Dienstaltersliste der Waffen-SS*, Stand 1.7.1944, Biblio Verlag, Osnabrück 1987. Horst Fischer was “SS-Führer of the Medical Corps” with no medical degree, and SS-Hauptsturmführer. His written statement, that he participated in gassings in 1942 in the capacity of SS physician, is thus false; in a recent publication, the professional denouncers of the Documentation Center of the Austrian Resistance repeat Jagschitz’s allegation about the “Dr.,” but refuse to give any evidence: B. Bailer-Galanda, in B. Bailer-Galanda, W. Benz, W. Neugebauer (eds.), *Wahrheit und Auschwitzlüge*, Deuticke, Vienna 1995, p. 97; cf. Germar Rudolf, “Zur Kritik an ‘Wahrheit und Auschwitzlüge’”, in H. Verbeke (ed.), *Kardinalfragen zur Zeitgeschichte*, Vrij Historisch Onderzoek, Berchem 1996, p. 96 (online: vho.org/D/Kardinal/Wahrheit.html; English: vho.org/GB/Books/cq/critique.html).

fortable for the expert witness, merely by saying, “*Ask your question, please!*” But anyone who truly wishes to ascertain the truth will not hesitate to permit even long-winded introductions in such important matters, since these serve the purpose of determining what is the truth. Within the framework of current criminal procedure, however, it is clearly not good form in such cases to let the defense ‘have its say’ and listen patiently. We wonder why?

Just consider how the defense attorney would have driven the expert witness into a corner if the report had been made available *before* the main hearing and if subject experts could have critically examined the statements of the report, which were downright amateurish on some technical points in question. But this was not possible until afterwards, when the transcript of the hearing was available.

Prof. Jagschitz did repeatedly stress that he was no engineer – which, since it had already been established as fact by the Court, really needed no further avowal. Still, he constantly presumed to interpret such technical documents as he considered to be genuine. However, a genuine document need not be correct. A ‘contemporary historian’ is not in a position to judge. Further, an opportunity to examine the expense account of the expert witness revealed that not only had the Court ‘commissioned a reading’, but that Jagschitz as well, due to inadequate facility in the Polish language, had commissioned third parties to ‘read for him’ and had then presented their findings as his own conclusions. In Austria court experts must swear an oath *that what they present to the Court are their observations in a true and complete manner*. It is quite incomprehensible how Jagschitz could arrive at any ‘true and complete’ findings at all without relying on translations by Austrian court translators. These translations, however, should have been available to the accused and his defense counsel at an appropriate time, as well as the complete overall findings, so as to permit thorough preparations on the part of the defense. But that was not considered to be important. On the contrary, when the accused made the thoroughly sensible suggestion (which would no doubt have been acted on in any other trial) that one should at least call in experts from the Viennese crematorium to refute the false and incorrect document regarding the incineration capacity of the crematoria of Auschwitz, he was cut off. Was that fair?

Nevertheless, Jagschitz did do away with certain ‘stereotypes’ such as ‘soap from Jewish bodies’ and ‘four million gassed in Auschwitz’. Despite a great many shortcomings, his report is a step in the direction of the manifestation of ‘true’ truth. Nothing is more foolish than to dispute actual facts. But if these facts, which are terrible enough in themselves, are exaggerated, there is a danger that this exaggeration will result in *nothing* being believed any more in the future.

Lüftl examined Professor Jagschitz’s report only through ‘spot checks’. The following sets out his findings. These few examples hint at how the defense might have acted to the benefit of the accused, had it had refutations by engineers at its disposal.

## 9. Why Should Engineering Reports be Obtained Before Reports are Issued on Contemporary History?

Even though Professor Jagschitz was alerted to the fact that in light of the complexity of the issue relating to ‘mass exterminations with poison gas’ it would be useful and advisable to obtain prior engineering and scientific reports on this subject, he – in his capacity as expert on contemporary history summoned by the Court for the Honsik Trial – neglected to have the technical questions settled by engineering experts at the outset.

In drawing up his report, he relied on witness testimony given in other trials, on claims made by other persons, and on documents which he apparently deemed genuine and true. The following expositions, co-authored by Lüftl, are intended to show in a replicable manner that *neglecting to consult engineering experts* resulted in false conclusions that could have been avoided.

## 9.1. Mortuary as Gas Chamber

On April 30, 1992 (page 471 of the court transcript), expert Jagschitz explained that in a letter dated March 6, 1943, the Chief of the Central Construction Management / Waffen-SS, a man by the name of Bischoff, had ordered preheating facilities for mortuary I, with ventilation and aeration from crematoria II and III in the concentration camp of Auschwitz-Birkenau. The court expert now takes this order as proof that mortuary I was in fact a gas chamber,

- since the heating facility was needed “*because Zyklon B works properly only at temperatures between 75 and 79°F*” (what vast ignorance in engineering, physical and chemical respects is revealed by even these few words!), and
- no heating facility would have been needed for a mortuary, since such a room would need to be cool.

Disregarding the question of whether the document is even genuine<sup>8</sup> (the process of planning and construction described leaves room for considerable doubt), it must be stated first of all that the court expert merely stated precisely the same thing here as Jean-Claude Pressac.<sup>9</sup> He came to the same false conclusion. However, what Pressac points out but Jagschitz seems not to know is the fact that the preheating installation for crematorium II was dropped from these facilities even prior to its first use due to a faulty construction of the aeration and ventilation device. The same installation was cancelled for crematorium III from the start.<sup>10</sup> Did Jagschitz skip over that part in his reading? Or is he not that familiar with Pressac’s work after all? Consequently, how can he draw up a report about ‘mass extermination with poison gas at Auschwitz’ without being aware of Pressac’s voluminous findings?

Furthermore, there may very well have been a technical need to install heating facilities in a mortuary, for two reasons:

- For reasons of hygiene it was no doubt necessary to have water pipes connected to the mortuary, for cleaning purposes.<sup>11</sup> If one wants to avoid having to routinely drain all facilities manually in winter when there is danger of frost, then one must surely keep the room temperature above 32°F, and
- Neufert’s *Bauentwurfslehre*<sup>12</sup> clearly states that a mortuary should be kept at a temperature between 35.5 and 53.5°F, since freezing bodies burst open and may freeze to whatever they are lying on (as well as to each other, if they are stacked). On May 24, 1945, eyewitness Henryk Tauber stated with respect to crematorium I:<sup>13</sup>

“*All the bodies were frozen and we had to separate them from each other with axes.*”

Therefore, planning for “*mortuary heating facilities*” is by no means proof that said mortuary was used as homicidal ‘gas chamber’. At any rate, no engineering expert would have dreamed of incompletely quoting Jean-Claude Pressac, without stating his source, and without critical, replicable technical arguments. And further to present these incomplete quotation as the result of his own replicable thought process, as his own ‘expert report’. And what is more, the cancellation of the order in question renders this ‘proof’ for the existence of ‘gas chambers’ *per se* quite irrelevant.

<sup>8</sup> Letter of Bischoff, Chief of the Central Construction Management, Waffen-SS, dated March 6, 1943, published, e.g., in J.-C. Pressac, *Auschwitz: Technique and Operation of the Gas Chambers*, Beate Klarsfeld Foundation, New York 1989, p. 221.

<sup>9</sup> J.-C. Pressac, *ibid.*, p. 223, bottom right.

<sup>10</sup> J.-C. Pressac, *ibid.*, p. 230.

<sup>11</sup> The blueprints of the mortuaries in question do in fact show water taps; J.-C. Pressac, *ibid.*, pp. 311f. These are said to have been removed later: *ibid.*, p. 286.

<sup>12</sup> E. Neufert, *Bauentwurfslehre*, Ullstein Fachverlag, Frankfurt am Main 1962, p. 423.

<sup>13</sup> J.-C. Pressac, *op. cit.* (note 8), p. 482.



## 9.2. Capacity of the Crematoria

Due to the characteristic nature of court expert Jagschitz's presentation (without adequate technical verification, but proportionately all the more adamant!), the document pertaining to the capacity of the crematoria<sup>14</sup> will be briefly discussed.

The document<sup>15</sup> of June 23, 1943, states the five crematoria of Auschwitz Stammlager and Birkenau were able to process 4,756 corpses in 24 hours.

The figure regarding total capacity was purely hypothetical.

The first point here is that the SS Central Construction Management includes in its statement crematorium I of Auschwitz Stammlager, even though it was to be reconstructed into an air-raid shelter a few weeks later. Crematorium II frequently had to be taken out of service because of damage to its chimney and was fully serviceable only from May to July 1944(!). Crematorium III was never used to full capacity, and crematorium IV suffered from constant damage to its ovens and chimney (taken out of service in May 1943, repairs attempted in vain in April 1944) and was shut down for good after the inmates' revolt of October 7, 1944. In crematoria V as well, ovens and chimneys frequently burned out. The document in question is well-known and has already been declared to be absurd several times (Stäglich, Butz, Walendy and others).<sup>16</sup> The figures it cites are sheer fantasy, as the following will show. Aside from the claim that the capacity of the individual retorts in crematoria II through V allegedly was 96 persons per day,<sup>17</sup> the capacity of crematorium I would have been only half as great – even though the supplier (Topf & Söhne) clearly manufactured the ovens based on the same patent.

But if one compares this document with the memo of March 12, 1943,<sup>18</sup> regarding the consumption of coke fuel recorded there, then one finds something truly remarkable. In a non-stop 24-hour operation the 4,416 bodies (4,756 – 340 for crematorium I = crematorium II through V) could allegedly be cremated with 34,574 lbs. of coke fuel, *i.e.*, 7.8 lbs. per body. This is utterly incredible, since normally it takes 88 to 110 lbs. per body. Anyone who does not believe this is free to go to the crematorium of any larger city and ask the older staff members there, who remember the 'coal-fired age'.<sup>19</sup>

The maximum delivery of coke fuel in March 1943 amounted to 144.5 metric tons,<sup>20</sup> this alleged peak capacity was possible for only nine days in March 1943 – but at that time crematoria II through V were not yet ready for full operation! At other times, average consumption was about 71 metric tons per month; in other words, the crematoria could have been used at peak capacity for only 4.5 days per month. Even if the fabulous capacity of 4,416 persons per day were fact, no more than a maximum 20,000 bodies could have been cremated per 'average month' in 1943. If one takes into consideration a realistic fuel consumption rate, which may be conservatively estimated at 55 to 66 pounds (greater than the alleged by a factor of 7 to 8!), then the cremation capacity of the crematoria cannot have exceeded an average of 2,500 to 3,000 bodies per month. This means that the method by which the victims of the mass gassings were disposed of is yet to be determined. In any

---

<sup>14</sup> Court transcript, page 475.

<sup>15</sup> J.-C. Pressac, *op. cit.* (note 8), p. 247.

<sup>16</sup> For the latest critique see Carlo Mattogno, "'Schlüsseldokument' – eine alternative Interpretation", *VffG* 4(1) (2000), pp. 50-56 (online: [vho.org/VffG/2000/1/Mattogno50-56.html](http://vho.org/VffG/2000/1/Mattogno50-56.html); Engl. "*The Auschwitz Central Construction Headquarters Letter Dated 28 June 1943: An Alternative Interpretation*", [www.russgranata.com/lalett.html](http://www.russgranata.com/lalett.html)).

<sup>17</sup> 15 minutes per body! In 1940 the technology available required 1.5 to 2 hours per body!

<sup>18</sup> J.-C. Pressac, *ibid.*, p. 223, column 3.

<sup>19</sup> Anyone who wishes to study the problems of cremation and power consumption by various means and methods is referred to the standard work on this topic: F. Schumacher, *Die Feuerbestattung*, Gebhardt's Verlag, Leipzig 1939. Cf. also the chapter by C. Mattogno and F. Deana chapter, this volume.

<sup>20</sup> J.-C. Pressac, *op. cit.* (note 8), p. 224.

case, the crematoria were not up to such a task. Possibilities that have been suggested include burning the bodies in pits and on pyres, for instance with methanol (boiling point 148°F!), or with wood: quantities of 330 to 440 lbs per body would be required; and the question whether such an operation would even be possible at all becomes clear from the testimony of crematoria expert Lagacé, see Section 9.4.

For the double-/triple-/eightfold retorts respectively, the consumption of coke fuel (based on a calculation of the energy balance) per body, in continuous operation (*i.e.*, in the theoretical ideal case), for ‘normal bodies’, would amount to 50.1/33.7/24.9 lbs, and for extremely emaciated bodies, to 67.7/45.0/33.7 lbs, which means an approximate average of 44.1 lbs.<sup>21</sup> One must add to this approximately 20% for periods of firing-up and discontinuity. In other words, between April and October 1943 (consumption approx. 497 metric tons<sup>18</sup>),  $497,000/24 = 20,000$  to 21,000 bodies could be cremated. This means an average of barely 3,000 cremations per month, or roughly 100 per day. Therefore, if one considers the actual consumption of fuel, the crematoria were incapable of cremating thousands of bodies per day. Furthermore, after a maximum of 3,000 cremations the retort is ‘burned out’, that is, the wall and ceiling tile must be completely replaced, which, as can also be proved, was never done for any of the retorts.<sup>21</sup>

### 9.3. No Smoke from the Crematoria Chimneys

Regarding the absence of smoke from the crematoria chimneys in Auschwitz-Birkenau on the USAF aerial reconnaissance photos,<sup>22</sup> court expert Jagschitz suggested that the Americans

“*probably used a filter [...] its purpose was to screen out thin clouds [...]*”<sup>23</sup>

However, even if such a filter had successfully “*screened out*” smoke trails, expert Jagschitz should know that their shadows would still have been visible on the ground, and thus on the photos, as clearly and precisely as the shadows of the stacks are visible. Aside from this fact, the filters, for whose use Jagschitz cannot cite any source or evidence, clearly were *not* used, since the bombs dropped by the Allies caused fires on the ground, and thus smoke trails; and these smoke trails are clearly visible on other photos.<sup>24</sup>

### 9.4. The “*Fabulous*” Crematorium Expert

Questioned by defense attorney Dr. Herbert Schaller, court expert Jagschitz stated that he did not understand how some (later “*some fabulous*”) crematorium expert could say that there had only been hundreds (of cremations), ... [thousands] are just physically unrealistic... unimaginable...<sup>25</sup> By studying the sworn testimony of the “*fabulous*” crematorium expert (a Canadian citizen before a Canadian court on April 5 and 6, 1988, in the second ‘Zündel Trial’!), expert witness Jagschitz could easily have discovered technical reality.

The “*fabulous crematorium expert*” is Ivan Lagacé, Manager of the Bow Valley Crematorium in Calgary, Alberta, Canada. The Bow Valley Crematorium is the hottest and therefore the fastest crematory in operation in North America. By virtue of its natural gas burner a cremation can be completed in only 90 minutes.

<sup>21</sup> Cf. the chapter by C. Mattogno and F. Deana, this volume.

<sup>22</sup> CIA Report, *The Holocaust Revisited*, February 1979, ST-79-10001, p. 11.

<sup>23</sup> Court transcript, page 478.

<sup>24</sup> Cf. the photos in J. C. Ball, *Air Photo Evidence*, Ball Resource Services, Delta (BC, Canada) 1992, pp. 41, 48, 65, 74.

<sup>25</sup> Report of expert witness Professor Jagschitz for the District Criminal Court of Vienna in the trial of Gerd Honsik, Ref. 26b Vr 14.186/86, pp. 20 and 42 of the court transcript.

Lagacé had completed the two-and-a half-year Funeral Services program at Humber College in Ontario and in 1979 obtained his diploma and Ontario license. In 1983 he obtained his Alberta license. He has cremated more than 1,000 bodies. In clear testimony Lagacé meticulously explained the problems of cremation and the hazards involved. He showed, in replicable and verifiable manner, that the (coal-stoked!) crematoria of Birkenau were less efficient than crematoria using natural-gas burners (where power can be simply shut off). He was also familiar with the plans for the Birkenau crematoria and compared them to the similar facilities in Bow Valley.

Lagacé also discussed in detail the practice of open-air burning and the issue of how to deal with typhus-infected corpses. Regarding open-air burning, he testified that even with the use of gasoline, in 90% of all cases it would be only the skin that charred, perhaps the limbs would also be burnt, but the torso was very difficult to cremate.

That was the “*fabulous*” crematorium expert, whose testimony is doubtless of much greater value than a patently *false* document. A physically impossible scenario does not become true even if it is alleged in a ‘genuine’ document, or one considered to be ‘genuine’ by court expert Jagschitz.

Even Raul Hilberg knows that crematorium I was operational only until spring 1943.<sup>26</sup> So why the SS would still detail its capacity on June 23, 1943, in this case is “*unimaginable*” for this author.

## 9.5. The Powerful Ventilators

On May 4, 1992, court expert Jagschitz discussed the “*considerably large ventilators*” (“*I found that clearly in Moscow*”, page 19 of court transcript; “*these enormous ventilators that vent air out of the mortuaries*”, “*rather there were considerably large ventilators at least in crematoria II and III*”, page 34 of court transcript).

These ventilators had engines of 3.5 hp. Given a necessary vacuum capacity of 6 inches water-column and considering the length of the conduit cross-sections, conduit course (numerous right-angle diversions), interior surfaces of the conduit (undressed brick, wood) and the nature of the vent openings (coarsely punched metal), this suffices for a maximum of ten exchanges of air in the ‘gas chamber’ per hour.

Considering the ventilation time of 30 minutes, this means that the concentration of hydrogen cyanide may then have dropped to a minimum of approximately  $\frac{1}{100}$  of the initial concentration. But since the method of alleged introduction of the Zyklon B from above means that the evaporation of hydrogen cyanide cannot be simply ‘shut off’, as it were (that works only in the American gas chambers using hydrogen cyanide generators), the evaporation would continue and at a greater rate than before, since the less than atmospheric pressure created in ventilation (lowering of the boiling-point) promotes evaporation. This means that until almost right before the end of the evaporation process – which can take from a few to many hours, depending on the ambient temperature and humidity – the ventilators with their capacity of only 3.5 hp would have had to perform a Sisyphean task without succeeding in lowering the concentration below the lethal level.

The question how the ventilators really worked, given a chamber crowded to bursting with dead bodies and given the air intake and exhaust configuration, is a matter that still needs to be settled by ventilation experts, for the used air was exhausted from below even though heating and increased moisture content caused by the presence of the victims would have made it lighter than the incoming fresh air. Another problem is the fact that the air intake and exhaust openings are located too close to each other – 6.5 feet apart on the same wall, vs. a distance of 24.5 feet from the opposite wall of the room blocked by the dead bodies. This means that there would be a ‘short-circuit’ of air in the chamber.

---

<sup>26</sup> R. Hilberg, *The Destruction of the European Jews*, Holmes & Meier, New York 1985, Table 75.

Given an initial hydrogen cyanide concentration of 5 g/m<sup>3</sup>, complete ‘shut-off’ of gas production, five air exchanges per half hour and ideal ventilation conditions, the concentration of hydrogen cyanide remaining will be only 50 mg/m<sup>3</sup> after half an hour and it will be safe to enter the gas chamber without a gas mask. But since Zyklon B continues to outgas for hours, entering the gas chamber after 30 minutes and without protective clothing as claimed would be fatal. Even gas masks equipped with a special filter J, guaranteeing safety for 30 minutes, would be inadequate under such conditions. Furthermore, the location of the air intake and exhaust vents on the roof ridge, approximately 15 feet apart,<sup>27</sup> begs the question as to what would happen whenever there was a breeze from the exhaust vent towards the intake opening. Again, it would be a matter of a ‘short-circuit of air’. No self-respecting German engineer worth his epaulets would design a ‘gas chamber’ this poorly.

The ventilator for the dissecting room and the rooms for washing up and for laying out the corpses – all of them situated above-ground and with windows – had a capacity of 1 hp, while that for the much larger mortuary 1 (‘gas chamber’) had 3.5 hp. As Carlo Mattogno has shown, the performance of all air extractions systems of the different rooms in crematoria II and III in Birkenau (oven room, mortuary 1, mortuary 2, dissecting and washing room) was considered to be nearly the same: 11,5 to 16,6 air exchanges per hour.<sup>28</sup> And Mattogno provided evidence that this was the standard power required for morgues according to contemporary German expert literature,<sup>29</sup> whereas air extraction systems for hydrogen cyanide gas chambers (delousing chambers) required at least 72 air exchanges per hour.<sup>30</sup> Thus, mortuary 1 was certainly not suited to exchange the given volume of air, enriched with 5 g/m<sup>3</sup> (according to Pressac,<sup>31</sup> it was even 12 g/m<sup>3</sup>!) and within the space of time (30 minutes) claimed in Holocaust literature (eyewitness reports), nor was it suited to exchange the given volume of air a sufficient number of times to allow the ‘gas chamber’ to be entered after this ventilation process without powerful gas masks and protective clothing. The bottom line of all this is that the ventilation facilities of crematoria II and III were designed strictly for purposes of normal ventilation, and not for the removal of highly toxic quantities of gas in a short period of time (20 to 30 minutes).<sup>32</sup>

## 9.6. An SS-Colonel as Traveling Repairman

‘Court expert’ Jagschitz also omits to go directly to the source of things in non-technical matters, as he had initially stated he would (court transcript page 261).

As proof of the existence of gas chambers he cites the so-called fact (transcripts page 390) that specialists for ‘gas chambers’ were evidently called in from Berlin when repairs were needed:

*“When gas facilities [sic] were broken, there was a man who was called in from Berlin to repair them. This was a certain Herr Eirenschmalz [...]”*

A quick glance into a standard work of ‘Holocaust literature’ reveals that the “*certain Herr Eirenschmalz*” was Chief of the Office C-4 (Finances!) in Group C (Construction) of the WVHA

<sup>27</sup> J.-C. Pressac, *op. cit.* (note 8), p. 291.

<sup>28</sup> C. Mattogno, “*Auschwitz: Das Ende einer Legende*”, in H. Verbeke (ed.), *Auschwitz: Nackte Fakten*, Vrij Historisch Onderzoek, Berchem 1995, pp. 133ff. (online: [vho.org/D/anf/Mattogno.html](http://vho.org/D/anf/Mattogno.html)); Engl: *Auschwitz: The End of a Legend*, Granata Publishing, Palos Verdes, CA, 1994 (online: [vho.org/GB/Books/anf/Mattogno.html](http://vho.org/GB/Books/anf/Mattogno.html)).

<sup>29</sup> *Ibid.*, p. 140; cf. W. Heepke, *Die Leichenverbrennungsanstalten (die Krematorien)*, Verlag von Carl Marhold, Halle a.S. 1905, p. 104.

<sup>30</sup> C. Mattogno, *op. cit.* (note 28), p. 141f.; cf. G. Peters, E. Wüstinger, “*Sach-Entlausung in Blausäure-Kammern*”, *Zeitschrift für hygienische Zoologie und Schädlingsbekämpfung* 10/11 (1940), p. 195; F. Puntigam, H. Breymesser, E. Bernfus, *Blausäuregaskammern zur Fleckfieberabwehr*, Sonderveröffentlichung des Reichsarbeitsblattes, Berlin 1943, p. 50.

<sup>31</sup> J.-C. Pressac, *ibid.*, pp. 16 and 18.

<sup>32</sup> This is also the opinion of J.-C. Pressac, *ibid.*, pp. 224 and 289.

(*Wirtschafts-und Verwaltungshauptamt*, Main Economic and Administrative Office of the SS).<sup>33</sup> He held the rank of *Standartenführer*, approximately equivalent to that of Colonel in the US Army.

Does anyone with half a brain really believe that an SS *Standartenführer*, who normally commands a regiment in the Army and who was evidently the Chief Paymaster of the Construction Office, would come running from Berlin clutching his toolbox whenever a hinge stuck on some input chute for Zyklon B?! Particularly when there were enough workshops and trained personnel available in Auschwitz itself?

## 9.7. The Unusual Consequences of Hydrogen cyanide Poisoning

‘Court expert’ Jagschitz also claims (court transcript page 441f.) that in an interview in Warsaw with an “*inmate who had a relationship of personal trust with SS-man Breitwieser*” he had learned that Breitwieser had been present at “*this particular gassing*” (of Soviet prisoners-of-war on September 4, 1941, in Block 11 of the Auschwitz main camp, which now, according to Pressac, apparently did not take place until December<sup>34</sup>). Breitwieser had removed his gas mask too soon and had suffered facial hemiplegia, paralysis of one half of his face, as a result.

The expert is here quoting a false statement, presumably given by the inmate, one Michal Kula. Asking a toxicologist or forensic doctor about this would reveal that paralysis of one half of the face cannot be the result of hydrogen cyanide poisoning, as such poisoning has no permanent effects if it is not immediately fatal.<sup>35</sup>

## 9.8. Further Details, Conclusions and Questions

### 9.8.1. Uncritical Acceptance of Eyewitness Testimonies

Incidentally, Jagschitz concludes (transcript pages 499-501) that there is room for correction in individual subsections of this complex subject and that considerable academic efforts are still required to look into the numerous questions of detail.

But this is exactly what was neglected in the trial!

Not one single question of detail was examined by engineers, chemists, doctors, etc. summoned for the purpose. On the contrary: experts whose interest in contemporary history prompts them to raise critical questions for discussion (*i.e.*, who do exactly what court expert Jagschitz urges) are being embroiled in criminal trials under §3h of the revised Austrian Criminal Code or §§130f., 185 of the Criminal Code in Germany dealing with jeopardizing the public peace, incitement to hatred, and slander.<sup>36</sup>

On January 10, 1991, in a preliminary report prior to submission of his expert report, Jagschitz had commented that

*“fundamental doubts about some basic issues have been reinforced” and “that there is only a relatively small body of scientific literature, as opposed to a considerably greater number of personal accounts or non-scientific summaries.”*

His presentations during the main hearing and the transcript thereof were thus studied with eager interest. Nothing important however, emerged from this presentation that had not already been well-known. Jagschitz bases his summary value judgment, that

---

<sup>33</sup> R. Hilberg, *op. cit.* (note 26), Table 72, p. 559.

<sup>34</sup> J.-C. Pressac, *Les Crématoires d’Auschwitz, la Machinerie du meurtre de masse*, CNRS, Paris 1993.

<sup>35</sup> W. Forth, D. Henschler, W. Rummel, *Allgemeine und spezielle Pharmakologie und Toxikologie*, 5<sup>th</sup> ed., Wissenschaftsverlag, Mannheim 1987, pp. 751f.

<sup>36</sup> Eg., the trial against G. Rudolf, academically accredited chemist, for his report; cf. the chapter by G. Rudolf, this volume.

**the mass murder with poison gas is a proven fact,**

primarily on documentary evidence and on his observation that in examining the accounts of witnesses and perpetrators he had found approximately two-third of these accounts to be false and some third to be correct.

An interesting forensic aspect is the ‘expert’s’ assessment of the evidential value of the testimony of persons who were not even questioned by this Court!

But court expert Jagschitz withholds the testimonies themselves, as well as his criteria for evaluating them. The only one he quotes, as example typical for all of them it seems, is the statement of a ‘perpetrator’, the “*SS-physician*”, Dr. Fischer. Since it is incriminating, it must be true?

An objective and unbiased observer ponders with some surprise is how it was possible, as late as the 1960s, to persuade a ‘perpetrator’ to personally record such physically impossible nonsense as:

1. the victims die within two minutes of the introduction of Zyklon B;
2. an elevator for the corpses leads directly to the doors of the crematoria ovens;
3. his ‘eyewitness’ could never have seen a crematorium from the inside, much less supervised an execution with hydrogen cyanide gas derived from Zyklon B.

Let us critically examine only two details from the statement of “*Dr.*” Fischer. These pertain to gassings in the ‘Sauna’ (trial transcript p. 443, supplement), a renovated farmhouse which, interestingly enough, is not shown or recognizable in so much as one single aerial photograph ever taken!

- “[...] *only 4-lb. cans were used* [...]”

As Pressac states, only cans with a net weight of 1, 2 and 3 lbs. of hydrogen cyanide were available.<sup>37</sup>

- “[...] *the gas chamber was opened after about 20 minutes [...] the doors were left open for approximately 10-15 minutes so that the poison gas could escape the gas chamber. There were no ventilation facilities in the ‘sauna’. Now the inmates (from the Corpse Commando) [...] pulled the dead bodies out [...] with 6-foot poles that had a bent iron hook at the end [...]*”

Since Zyklon B continues to release hydrogen cyanide for hours, and ventilation by means of natural draft would have taken days rather than hours, these inmates must have been immune to the highly toxic hydrogen cyanide! How does that agree with the Special Order issued by Camp Commandant Hoess,<sup>38</sup> August 12, 1942, which stated that after gassed (more correctly: fumigated!) facilities are opened, members of the SS not wearing gas masks must keep at a distance of 45 feet for at least 5 hours and must also be mindful of wind direction, since there had already been some accidents?

Insofar as the documents quoted by Jagschitz are even genuine and correct – which is frequently very doubtful for technical reasons – they certainly also permit other technical interpretations than those which the expert witness ascribes to them. One document, for example, discusses a gas-proof door in crematoria II having dimensions of 39.4" × 75.6". According to the building plans however the mortuaries 1 of crematoria II and III had double doors measuring 70.9" × 78.7". But how does one gas-proof a double-door opening of 70.9" × 78.7" with a single door measuring 39.4" × 75.6"?

Two other examples from ‘Holocaust literature’ and the Jagschitz Report are examined subsequently.

<sup>37</sup> J.-C. Pressac, *op. cit.* (note 8), pp. 16f.

<sup>38</sup> J.-C. Pressac, *ibid.*, p. 201; also p. 445 of court transcript.

### 9.8.2. “10 Gas Detectors”

In spring 1943, the Central Construction Management of Auschwitz ordered “10 gas detectors” from the oven manufacturing firm of Topf and Sons.<sup>39</sup> If these gas detectors had had anything to do with hydrogen cyanide they would have been ordered by the appropriate health authorities from the company DEGESCH, not by the Central Construction Management from the oven manufacturer Topf and Sons.

As even contemporaneous subject literature shows, “gas detectors” were in fact devices used for analyzing combustion gas for the presence of CO or CO<sub>2</sub>, which are produced by the ‘gasification’ of coke fuel in the generator of the crematorium oven.<sup>40</sup> The number of gas detectors ordered (ten) also indicates strongly that this is what they were intended for, since the two crematoria II and III, constructed as mirror images of each other, had a total of ten waste-gas flues, where the gauges were probably placed.

This matter took a strange turn when Pressac recently found a document in the KGB archives in Moscow in which the company Topf and Sons confirms the aforementioned order of the gas detectors.<sup>41</sup> This document makes reference to the telegram with the words “*Re.: Crematorium, gas detectors*”, but in the main text it is mentioned that it had not yet been possible to locate a supplier of “*indicators of hydrogen cyanide residue*”. So this document would have us believe that gas detectors were in fact devices for detecting hydrogen cyanide. But several factors ought to make an engineer suspicious:

1. According to the subject literature of the time, devices for the detection of hydrogen cyanide residue were called *Blausäurerestnachweisgeräte*.<sup>42</sup> The term used in the letter, however, is *Anzeigergerät für Blausäure-Reste*. (No German would write *Blausäure-Reste* as two words, hyphenated!) But since, according to their letter, Topf and Sons by that time had received responses from three suppliers regarding such devices, the correct name of said devices ought to have penetrated even to Topf and Sons. Besides: “*kommen wir Ihnen sofort näher*” [we shall come close to you immediately] is nonsense. It should read ‘kommen wir sofort auf Sie zu’ [we shall get in contact with you immediately].
2. The regulations of that time stipulated that after every delousing procedure utilizing hydrogen cyanide, a hydrogen cyanide residue detector had to be used to test the fumigated facilities to determine whether ventilation had been successful. Only then could the deloused rooms be entered without a protective gas mask.

Since delousing had been carried on in Birkenau on a large scale ever since 1941, it is utterly implausible that no one should have seen to the provision and the suppliers of these devices until spring 1943.

3. The health authorities of the Auschwitz camp had been responsible for the ordering, distribution and use of Zyklon B and all the materials necessary for its use (delousing facilities, gas masks, hydrogen cyanide residue detectors etc., and allegedly for the mass gassings as well) ever since the Birkenau camp had been set up in 1941. In other words, they had two years experience in this field. So why should the Central Construction Management, which was not responsible for this field and not competent in matters related to it, suddenly step in in spring 1943 and order the purchase of hydrogen cyanide residue detectors?

---

<sup>39</sup> J.-C. Pressac, *ibid.*, p. 371; also p. 471 of court transcript.

<sup>40</sup> Akademischer Verein Hütte (ed.), *Hütte*, 27<sup>th</sup> ed., Ernst und Sohn, Berlin 1942, p. 1087.

<sup>41</sup> J.-C. Pressac, *op. cit.* (note 34), plate 28. Compared to his first book this is the only new document introduced here. The rest of the book in essence only repeats and condenses the expositions of the book from note 8.

<sup>42</sup> Cf. the guidelines for the use of hydrogen cyanide (Zyklon) for pest control (disinfestation), issued by the Gesundheitsanstalt des Protektorats Böhmen und Mähren, Prague, n.d.; IMT Document NI-9912(1).

4. Why was the order given to the oven manufacturing firm Topf and Sons, who were so out of their depth in this field that they clearly did not even know who the suppliers of these devices might be, when the health authorities of camp Auschwitz had already been continually supplied with these devices for two years, and thus knew the suppliers (which actually were the selfsame which supplied Zyklon B)? Very probably the health authorities even had some spare devices in stock.
5. From the text of the order placed by the Central Construction Management ("Ship 10 gas detectors immediately, as discussed [...] quote price later.") it also becomes clear that after a discussion with the firm of Topf and Sons the Central Construction Management was in a position to expect that the devices would be shipped without delay and that the price would be up to Topf. Both, however, could only have been the case for products that were part of Topf's standard stock, and thus not possibly for hydrogen cyanide residue detectors. The latter is also clearly apparent from Topf's reply, which indicates the necessity for laborious research to locate the manufacturers of these detectors.
6. It has never been customary in German business practice to confirm receipt of telegrams with a proper letter, in which the entire telegram itself is quoted (!), as was allegedly done in this case. And what is more: after the collapse of the 6th Army in Stalingrad in the winter of 1942-43, the Reich suffered from a severe labor shortage, so that especially in administrative respects every step that could possibly be dispensed with was eliminated to save work. Thus one can be quite certain that telegrams were not confirmed in those days.

Prof. Dr. J. A. Topf & Söhne, Zof 8/3. 17/43

**J. A. TOPF & SÖHNE**  
MASCHINENFABRIK · FEUERUNGS-TECHNISCHE BAUUNTERNEHMUNG

An die  
 Zentral-Bauleitung der  
 Waffen-SS und Polizei,  
 Auschwitz / Ost-Oberschl.

<b>Eingang:</b> 15. MRZ. 1943	<b>Stellvertreter</b> 24328/43
<b>Trüb. / Abt.</b>	<b>Manung</b>
<b>Buchhaltg.</b>	<b>Rechnungsw.</b>
<b>6.3.43</b>	<b>ERFURT, den 2.3.43</b>
	<b>hes.</b>

Befr.: **Krematorium, Gasprüfer.**      Ihr Zeichen:      UNSERE ABTEILUNG: **DIV**

-- *W. Krauß*      Prof. *K. R. R. 30*

Wir bestätigen den Eingang Ihres Telegrammes, lautend:  
 " Absendet sofort 10 Gasprüfer wie besprochen  
 Kostenangebot später nachreichen "

Hierzu teilen wir Ihnen mit, dass wir bereits vor 2 Wochen bei 5 verschiedenen Firmen die von Ihnen gewünschten Anzeigeräte für Blausäure-Reste angefragt haben. Von 3 Firmen haben wir Absagen bekommen und von 2 weiteren steht eine Antwort noch aus.

Wenn wir in dieser Angelegenheit Mitteilung erhalten, kommen wir Ihnen sofort näher, damit Sie sich mit einer Firma, die diese Geräte baut, in Verbindung setzen können.

Heil Hitler!  
**J. A. TOPF & SÖHNE**

ppa. *[Signature]*      i.V. *[Signature]*

Erledigt durch Schreiben  
 vom 194... Bftgb. Nr. \_\_\_\_\_

Reichsbank-Giro-Konto 75/851 — Postcheck-Konto Erfurt 1792  
 Telegramme: Topfwerke — Fernsprecher: Sammelnummer 25125

---

*Document in facsimile in: J.-C. Pressac, Die Krematorien von Auschwitz, Piper, Munich 1994. Doc. Plate No. 28.*

*Translation:*  
 [...] We confirm the reception of your telegram, saying:  
 'Send off immediately 10 gas detectors as discussed. Hand in estimate later.'  
 In this regard, we let you know that already two weeks ago we asked 5 different firms about the indicators of hydrogen cyanide residue requested by you. We received negative answers from 3 firms, and from two others an answer is still outstanding.  
 In case we receive notification in this matter, we shall come close to you immediately so that you can get in contact with the firm producing these devices.  
 Hail Hitler!  
 [...]



7. It is somewhat puzzling that this document, which was celebrated in the press as the irrefutable proof of the existence of gas chambers,<sup>43</sup> was not discovered until 1993, and then in the oh-so-trustworthy archives of the KGB!

Therefore, this alleged new document is probably a forgery. This needs to be conclusively determined by an expert analysis of the supposed original document. But even if it would be genuine, it does not prove the existence of *homicidal* gas chambers.<sup>44</sup>

### 9.8.3. “210 anchors for fixing the gas-tight doors”

Who would need 210(!) door anchors<sup>45</sup> for the lethal gas chamber of crematorium IV if the “*gas-tight doors*” had indeed been doors to the ‘gas chamber’? The technical work *Blausäuregaskammern zur Fleckfieberabwehr* explains how hydrocyanic-acid-gas-proof doors must be anchored:<sup>46</sup> the 8 wall anchors per door (supplier, Otte & Co., Vienna) are already welded onto the doorframe so that the door cannot warp. 210 anchors for fixing gas-tight doors are no proof for gassings of human beings. However, they might be a proof for the fact that gas tight doors, windows and shutters were installed everywhere in Auschwitz as protection devices against poison gas attacks by allied bombers, as author Samuel Crowell pointed out.<sup>44</sup>

These examples clearly show how many details would require attention before a comprehensive value judgment based on a solid foundation of factual questions answered to scientific satisfaction can be rendered in this historical issue that sincerely concerns many who seek the truth.

## 9.9. Summary

In his report, court expert Jagschitz corrected the “*symbolic number of 4 million Jewish victims*” insofar as he stated that “*several hundreds of thousands, up to a maximum of 1.5 million were killed by gassing*” in Auschwitz.

In light of the aforementioned technical facts, one can agree with Jagschitz’s lower limit regarding the magnitude of number of victim – with perhaps, some reservations with respect to the actual cremation capacities. However, this does not comprehensibly settle the number of killed, on the one hand, and the number of deceased on the other. All the more so since Kazimierz Smoleń, an author certainly above suspicion of revisionist leanings, stated:<sup>47</sup>

“[...] *Several hundred died in the camp daily. Mortality was particularly high during the typhus epidemics, and when diarrhea occurred on a large scale [...]*”

So if “*several hundred*” actually died on a daily basis,<sup>48</sup> then in light of the limited capacity of the crematoria there was no leeway left for the removal of the victims of alleged ‘mass gassings’.

---

<sup>43</sup> Cf. *FAZ*, Oct. 14, 1993; *Die Welt*, Sept. 27, 1993; *Welt am Sonntag*, Oct. 3, 1993; *Der Spiegel*, 49/1993; *L’Express*, Sept. 23, 1993; *Libération*, Sept. 24, 1993; *Le Monde*, Sept. 26, 1993; *Le Nouvel Observateur*, Sept. 30, 1993.

<sup>44</sup> A different approach to this document was given by S. Crowell, “*Technik und Arbeitsweise deutscher Gasschutzbunker im Zweiten Weltkrieg*”, *Vierteljahrehefte für freie Geschichtsforschung (VffG)* 1(4) (1997), pp. 226-244 (online: [vho.org/VffG/1997/4/Crowell4.html](http://vho.org/VffG/1997/4/Crowell4.html); Engl.: [codoh.com](http://codoh.com)); for a recent summary of the discussion regarding this document see Carlo Mattogno, “*Die ‘Gasprüfer’ von Auschwitz*”, *VffG* 2(1) (1998), pp. 13-22 (online: [vho.org/VffG/1998/1/Mattogno1.html](http://vho.org/VffG/1998/1/Mattogno1.html)).

<sup>45</sup> J.-C. Pressac, *op. cit.* (note 8), p. 451.

<sup>46</sup> F. Puntigam, H. Breymesser, E. Bernfus, *Blausäuregaskammern zur Fleckfieberabwehr*, Sonderveröffentlichung des Reichsarbeitsblattes, Berlin 1943, p. 44.

<sup>47</sup> Prior to the collapse of the Communist regime in the Eastern Bloc, Kazimierz Smoleń had been Director of the Auschwitz Museum. Quoted from Smoleń, *Auschwitz 1940-1945*, Ullstein, Frankfurt/Main 1961, p. 63.

<sup>48</sup> “*Died*”, not “*were killed*”; of course no one, not even Revisionists, will seriously contest that killings also occurred on the side!

Smoleń made this statement while still believing in the ‘4 million’. He still allowed for ‘mass gasings’. But if one combines the findings of Jagschitz (several hundreds of thousands, up to a maximum total of 1.5 million) with Smoleń’s (several hundred dead per day) and with the capacity of the crematoria, then the final picture is quite a different one.

But the statistics Jagschitz arrived at place this court expert in sharp conflict with Galinski, the late Chairman of the Central Council of Jews in Germany, who as late as mid-1990 vehemently clung to the traditional figure of 4 million mostly Jewish victims of Auschwitz:

*“I consider it a historically proven fact that four million persons died in the worst extermination factory in the world.”*<sup>49</sup>

This statement is reminiscent of Germany’s Supreme Court’s ruling of “*judicial notice*” based on information given in the *Brockhaus* encyclopedia. However, *Brockhaus* also states that cremation takes from 90 to 100 minutes!

One wonders whether this part of Jagschitz’s report will yet come back to haunt him? On the other hand, perhaps Simon Wiesenthal’s recent statement will exculpate Lüftl. Wiesenthal was quoted as having said that 1.5 million is now supposed to be the final, definitive number of victims. Only those who claim a lesser figure run the risk of incurring Wiesenthal’s wrath.<sup>50</sup>

Furthermore, from press releases it has been evident since early March, 1993, that according to the Polish agency PAP the updated number of victims is between 1.2 to 1.5 million:

*“[...] the 4-million-figure was part of Soviet propaganda [...]”*

So what do the courts consider to be “*judicially noticed*” since March, 1993? Will those persons who have been censured in the past for claiming figures between 1.5 and 6 million now be pardoned or rehabilitated, or even paid compensations?

In his new book Pressac writes that only 630,000 persons perished in the gas chambers of Auschwitz and that no more than 800,000 persons died in Auschwitz altogether.<sup>51</sup> In the German edition of this contribution this author already questioned which figure will be granted judicial notice in 1994.<sup>52</sup> Now we know according to the German edition of Pressac’s latest book, there are some 470,000 to 550,000 gassed Jews and some 710,000 victims altogether.<sup>53</sup> In 2002, Fritjof Meyer, an editor of Germany’s largest weekly magazine *Der Spiegel*, published an article in which he stated, the death toll of Auschwitz did not exceed 510,000, of which not more than 356,000 were allegedly gassed.<sup>54</sup> What number will be “*judicially noticed*” in 2003? What number in the year 2004? Which in 2010?

Drawing exclusively upon the Jagschitz Report, on ‘non-revisionist’ sources such as Pressac, Hilberg, documents from the archives of the Auschwitz Museum, and on other sources such as standard subject-reference works which are certainly above suspicion, Walter Lüftl has shown that the material presented by court expert Jagschitz can be interpreted in other, equally plausible ways, to arrive at the opposite conclusion, namely that

**the mass murder with poison gas cannot be proven.**

Even though only seven points (and some details) from the court expert’s report were discussed here, an examination of the whole of the court transcript reveals a plenitude of points, a scrutiny of whose technical components (and, as the example of “*Eirenschmalz*” shows, even merely the organ-

<sup>49</sup> *Rheinische Post*, July 18, 1990.

<sup>50</sup> *Kleine Zeitung*, Klagenfurt, Aug. 1, 1992.

<sup>51</sup> *Op. cit.* (note 34), p. 147.

<sup>52</sup> E. Gauss (ed.), *Grundlagen zur Zeitgeschichte*, Grabert, Tübingen 1994, p. 58.

<sup>53</sup> J.-C. Pressac, *Die Krematorien von Auschwitz. Die Technik des Massenmordes*, Piper-Verlag, Munich 1994, p. 202.

<sup>54</sup> F. Meyer, “*Die Zahl der Opfer von Auschwitz*”, *Osteuropa*, 52(5) (2002), pp. 631-641.

izational components) allows precisely the opposite conclusion than that drawn by court expert Jagschitz.

## 10. Do All Expert Witnesses Have Equal Rights?

For an outside observer, the following question arises: if, after careful examination of sources and consultation with subject experts, and working in a replicable and verifiable manner, court expert Jagschitz had arrived at the opposite of his actual conclusion – *would he too have been in violation of §3h of the Criminal Code?*

In any western nation under the rule of law one must naturally answer this in the negative. And therefore such a violation also cannot be alleged against a private researcher such as Walter Lüftl, who has looked into this issue and concluded as the result of an examination of the facts and of his own replicable and verifiable reasoning that the ‘truth desirable from the perspective of public education’ is as yet open to doubt since it stands in contradiction to natural laws and what is technically possible. Such an allegation would be all the more inappropriate since the examination of individual aspects of the overall subject has been expressly declared to be outside the province of the law cited (cf. Stenographic Transcripts of the Austrian National Assembly).

It is purposely left up to the reader to determine for himself that the above expositions as a whole are at least equal to the scientific and academic standard of Jagschitz’s presentation. In any case every value judgment has been thoroughly founded on fact, and adequately supplemented with documentation permitting the replication and verification of findings.

## 11. Author’s Statement

At no point does the above article contain any statement or claim, whether of direct or indirect nature, which was intended or meant to be taken as

- denial,
- approval, or
- gross trivialization of the judicially noticed National Socialist mass murder.

This author sincerely condemns National Socialist crimes with all appropriate force and affirms that a crime begins with the very first victim wrongfully killed.

However, he claims for himself the *fundamental principle of academic freedom* as expressed in the February 5, 1992, report of the Justice Committee of the Austrian National Assembly.<sup>55</sup>

The above study, being a serious academic and scientific endeavor, concerns itself with *individual aspects of a historical complex of events* and should be regarded first and foremost as a critical post-verdict statement pertaining to the *individual aspects of a report* drawn up by an ‘expert’ summoned by the court and *discussing the historical complex of events in question*.

In particular, the author wishes to stress a statement of the Chairman of the Justice Committee of the Austrian National Assembly:

*“I do, however, fully agree with you on the point that only science, not a trial judge, can determine what is truth and what is falsehood.”* (Dr. Michael Graff)

What is more, where and by whom this work is published is quite irrelevant,  
**for the truth is indivisible.**

---

<sup>55</sup> Cf. No. 387, Supplements to the Transcripts of Proceedings of the National Assembly, XVIII of the transcript, Point 4, p. 5.

## 12. The End of the Matter

On June 15, 1994, Lüftl received a notice from the District Criminal Court of Vienna, dated June 8, 1994,<sup>56</sup> and stating that the initial investigation that had been instituted against him had been dropped since there were no further grounds for prosecution.

The Holocaust lobby who had learned even before Lüftl that the case had been abandoned (whatever happened to ‘official secrecy’?) considered this a severe blow.<sup>57</sup> In an open letter to Justice Minister Michalek, professional denouncer Wolfgang Neugebauer from the Documentation Center of Austrian Resistance lamented the outcome of these events and charged the Minister of Justice, who had only acted correctly, with “*full responsibility*”:

“*A severe setback in the battle against denial of the Holocaust, and carte blanche for all future Holocaust-deniers.*”

Meanwhile, the Holocaust lobby had realized that in denouncing Lüftl they had shot themselves in the foot. Prior to the revision of the Criminal Code, what Lüftl had written in his study *Holocaust* had not been an indictable offense; the only point at issue had been whether or not he had written it in the spirit of “*National Socialist revivalism*”, for which the legal persecution and preliminary investigation to which he had been subjected for more than two years had failed to turn up even the slightest shadow of evidence. But the loud and vociferous manner in which the press reported on the “*scandal*”, grossly distorting the truth in the process, ensuring that the matter drew attention around the globe, prompted a great many people to independent thought. And in the eyes (and for the purposes) of the Holocaust lobby, the results of such reflection were certainly counterproductive.<sup>58</sup>

Thus, Lüftl, vindicated by the District Criminal Court of Vienna, could state with impunity:

1. In light of natural laws and technical possibilities vs. impossibilities, the mass gassings with Zyklon B, as they are described by ‘contemporaneous witnesses’ and ‘perpetrators who confessed’, cannot have taken place.
2. The Kurt Gerstein Statement is (verbatim) “*a whopping lie*”.<sup>59</sup>
3. By virtue of the composition of the exhaust gases, mass gassings with Diesel exhaust fumes cannot have taken place. Had there really been execution chambers or ‘gas vans’ operating with exhaust gas, the Germans would have used the more efficient internal combustion engines, or the even more efficient wood-gas generators.
4. Crematoria chimneys do not spew flames during the cremation process. All ‘eyewitness’ testimonies asserting such a phenomenon are false.
5. The number of cremated victims is considerably exaggerated since the capacity of the crematoria would have been insufficient to handle mass gassings. The quantity of fuel actually used delimits the true number of bodies cremated.
6. No homicidal mass gassings took place in the concentration camp Mauthausen. The method of gassing described by witnesses is nonsense and would have been fatal for the executioners.<sup>60</sup>
7. Homicidal mass gassing using bottled carbon monoxide is technically impossible nonsense.

<sup>56</sup> Ref. 26b Vr 4274/92.

<sup>57</sup> Cf. reports in the Austrian daily press of June 15, 1994, as well as *Profil*, June 20, 1994.

<sup>58</sup> In the meanwhile, Lüftl succeeded in being reelected for the Austrian Chamber of Engineers, cf. “*Lüftl wieder in Kammer. ‘Schwieriges Problem’*”, *Standard*, September 19, 1994.

<sup>59</sup> For a brief discussion of Gerstein’s statement see F.P. Berg’s article in this handbook.

<sup>60</sup> See the interesting admissions that no traces of killing devices of the concentration camp Mauthausen could ever found and that the gas chamber shown to visitors is a post war fabrication with no relation to reality: Florian Freund, Bertrand Perz, Karl Stuhlpfarrer, “*Historische Überreste von Tötungseinrichtungen im KZ Mauthausen*”, *Zeitgeschichte* (Vienna), 22 (1995), pp. 297-317; review: I. Schirmer-Vowinkel, *VffG*, 2(1) (1998), pp. 68f. (online: [vho.org/VffG/1998/1/Buecher1.html#ISV2](http://vho.org/VffG/1998/1/Buecher1.html#ISV2)).

8. Auerbach's attempt at discrediting the Leuchter Report<sup>61</sup> can easily be refuted by experiment.
9. Zyklon B and Diesel exhaust fumes have lost all credibility as alleged 'murder weapons' used in the "*planned extermination of millions of human beings, especially Jews, as part of a program of planned genocide.*"
10. Natural laws hold true for 'Nazis' no less than for anti-Fascists.
11. Material evidence will refute the testimony of perjured 'eyewitnesses' and the confessions of 'perpetrators'.
12. Should the objective and scientific investigation of the Holocaust nevertheless prove the "*planned genocide by means of gas chambers*", then the Revisionists too will have to accept this.
13. *Who* is it that wants to stifle any and all discussion of this topic by means of criminal laws, and for what reasons?
14. Are we entering an era of 1984 totalitarianism after all, albeit through the back door?

However, considering the new revised paragraph 3h) of Austria's *Prohibition Order*, it seems to be necessary to advise others not to make similar claims today, since the above statements were made before the new law came into effect. A national-liberal Austrian publisher who published these statements in 1995 as part of a documentation of Lüftl's case,<sup>62</sup> was charged with "*Holocaust denial*" according to the new §3h)<sup>63</sup> and consequently sentenced to 10 month imprisonment on probation and a fine of ÖS 240,000 (\$24,000).<sup>64</sup>

---

<sup>61</sup> H. Auerbach, November 1989, published in U. Walendy, *Historische Tatsachen (HT)* No. 42, Verlag für Volkstum und Zeitgeschichtsforschung, Vlotho 1990, pp. 32 and 34.

<sup>62</sup> Hans Moser, "*Naturgesetze gelten für Nazis und Antifaschisten*", *Aula*, 7-8 (1994), p. 15.

<sup>63</sup> Cf. "*Ein rauhes Lüftl*", *Bau*, 5 (1995), p. 8.

<sup>64</sup> Staatsanwaltschaft Graz vs. Herwig Nachtmann, Ref. 14 St 4566/94-8, April 4, 1995.

# The Value of Testimony and Confessions Concerning the Holocaust

MANFRED KÖHLER

“To deny that Jews had been maliciously killed en masse by Germany in a tribunal whose very existence was based upon the intent to establish without doubt that Jews had been killed was as fatal to the defendant in 1946 as it would have been to an accused medieval heretic who before his inquisitors guaranteed his condemnation on whatever charge by throwing in for the hell of it a denial of the existence of the Trinity and the Divinity of Jesus.”<sup>1</sup>

## 1. Introduction

In the debate about the Holocaust one of the main arguments of popular opinion is that there are a great many statements of eyewitnesses to document the National Socialist mass extermination, and that especially the many confessions of perpetrators among the SS are irrefutable proof of the existence of a program of deliberate extermination of the Jews in the Third Reich.<sup>2</sup> For this reason, it is claimed, the lack of documentary and material evidence is irrelevant.<sup>3</sup>

First of all, it is incorrect to say that there is no material evidence. The present work is a compendium of such material evidence, which, however, all goes to refute certain aspects of the Holocaust as these are related by witnesses and maintained accordingly by the courts and by academia. The justice system as well as academics of the establishment ignore this material evidence; nevertheless, the question arises as to how eyewitness testimony is to be evaluated.

It is important to note that neither objective historians nor jurists may uncritically accept everything that someone recounts as being the plain truth, but must establish the value of such reports. The first step in this process is to fit eyewitness testimony properly into the hierarchy of the various types of evidence. Then one must consider how the individual testimony came to be – for example, whether there were manipulative factors that may have impinged on the witness and influenced his testimony.

Since most of the eyewitness statements concerning the Holocaust were made in the course of preliminary legal proceedings and of trials, we shall first clarify the value accorded to eyewitness testimony in court.

## 2. The Value of Eyewitness Evidence in General

In academia as well as in the justice system of a state under the rule of law, there is a hierarchy of evidence reflecting the evidential value. In this hierarchy, material and documentary evidence is always superior to eyewitness testimony.<sup>4</sup> Thus, academia as well as the justice system regard eyewitness testimony as the least reliable form of evidence, since human memory is imperfect and easi-

---

<sup>1</sup> W. B. Lindsey, *The Journal of Historical Review (JHR)* 4(3) (1983) pp. 261-303, here p. 265 (online: [vho.org/GB/Journals/JHR/4/3/Lindsey261-303.html](http://vho.org/GB/Journals/JHR/4/3/Lindsey261-303.html)).

<sup>2</sup> The most prominent advocate of this thesis is Professor Nolte, in his book *Streitpunkte*, Propyläen, Berlin 1993, pp. 290, 293, 297.

<sup>3</sup> For example, the verdict of the *Schwurgericht* [jury court] of Frankfurt am Main stated that there is no evidence as to the crime, its victims, the murder weapon, nor even the perpetrators themselves; Ref. 50/4 Ks 2/63; cf. I. Sagel-Grande, H. H. Fuchs, C. F. Rüter (eds.), *Justiz und NS-Verbrechen*, v. XXI, University Press, Amsterdam 1979, p. 434.

<sup>4</sup> Cf. E. Schneider, *Beweis und Beweiswürdigung*, 4<sup>th</sup> ed., F. Vahlen, Munich 1987, pp. 188 and 304; additional forms of evidence are “*Augenscheinnahme*” [visual assessment of evidence by the Court], and “*Parteieinvernahme*” [the questioning of disputing parties, i.e., prosecution and defense], a particularly unreliable form of testimony.

ly manipulated.<sup>5</sup> According to Rolf Bender, a German expert on the evaluation of evidence, its unreliable nature renders eyewitness testimony merely circumstantial evidence, in other words, not direct evidence.<sup>6</sup>

What standards must be met for eyewitness testimony to be usable in court?<sup>7</sup>

*1. The witness must be credible.*

While making no claims to completeness, the following lists a few criteria for determining credibility:

- a) Emotional involvement. If witnesses are emotionally too involved in the cases under investigation, this may distort the testimony in one direction or the other, without this necessarily being a conscious process.
- b) Veracity. If it turns out that a witness is not overly concerned about truthfulness, this casts doubts upon his further credibility.
- c) Testimony under coercion. The frankness of testimony may be limited if a witness is subjected to direct or indirect pressure that makes him deem it advisable to configure his testimony accordingly.
- d) Third-party influence. A person's memory is easy to manipulate. Events reported by acquaintances or in the media can easily become assimilated as 'personal experience'. Thus, if a witness has been exposed intensively to one-sided accounts of the trial substance prior to testifying, this can very well affect his testimony to reflect these impressions.
- e) Temporal distance from the events to be attested to. It is generally known that the reliability of eyewitness testimony diminishes greatly after only a few days, and after several months has been so severely influenced and altered by the replacement of forgotten details with subsequent impressions that it retains hardly any value as evidence.<sup>8</sup>

*2. Testimony must be plausible.*

- a) Internal consistency. Testimony must be free of contradictions and in accordance with the rules of logic.
- b) Correctness of historical context. Testimony must fit into the historical context established conclusively by higher forms of evidence (documents, material evidence).
- c) Technical and scientific reality. Testimony must report such matters as can be reconciled with the laws of nature and with what was technically possible at the time in question.

While the issues listed under 2. are easily verified, the circumstances listed under 1. are often difficult or impossible to determine and thus involve the greatest effort for the least return. One must keep in mind that every witness experienced a certain event differently, from a purely subjective and personal point of view. He or she internalized it differently, depending on his/her physical and psychological state. He/she will ultimately recount the experience in a strictly subjective manner depending on his/her abilities and on the occasion at hand. So even if two witnesses are completely impartial and credible and their statements are plausible, they nevertheless may not report the same thing.<sup>9</sup>

---

<sup>5</sup> E.g., cf. §373, German Code of Civil Procedure.

<sup>6</sup> R. Bender, S. Röder, A. Nack, *Tatsachenfeststellung vor Gericht*, 2 vols., Beck, Munich 1981, vol 1, p. 173.

<sup>7</sup> Cf. also the detailed accounts of E. Schneider, *op. cit.* (note 4), p. 200-229, and R. Bender, S. Röder, A. Nack, *op. cit.* (note 6), v. 1 part 1.

<sup>8</sup> Cf. esp. R. Bender, S. Röder, A. Nack, *ibid.*, pp. 45ff.

<sup>9</sup> In this case in particular, cf. J. Baumann, in R. Henkys, *Die NS-Gewaltverbrechen*, Kreuz, Stuttgart 1964, pp. 280f.; also R. Bender, S. Röder, A. Nack, *op. cit.* (note 6), *passim*.

The testimony of parties in dispute before the Court – *i.e.*, the statements of the prosecution and the defense – must naturally be considered in an especially critical light since each party has a vested interest in incriminating its opponent and exonerating itself.<sup>10</sup> But even impartial witnesses are often very far removed from the objective truth, and the fact that (although this has been well known for centuries) eyewitness testimony is still accorded disproportionately great significance in court even today, has repeatedly drawn sharp criticism from qualified sources<sup>11</sup> and has frequently resulted in gross miscarriages of justice.

From a judicial point of view, confessions – both in and out of court – are considered to be circumstantial evidence, since past experience has shown that a large part of all confessions are false. False confessions may be made in order to

- cover for a third party;
- bask in the limelight of a crime;
- put a stop to grueling interrogation;
- gain a mitigated sentence by exhibiting remorse and repentance;
- as a result of psychological disorders; etc...

In the Federal Republic of Germany as well, miscarriages of justice unfortunately occur time and again as a result of false confessions.<sup>12</sup> The same goes accordingly for self-incriminating testimony which need not always be true. It is all the more surprising, therefore, that the otherwise knowledgeable R. Bender would categorize a self-incriminating witness as being generally truthful.<sup>13</sup>

### 3. Forms of Evidence in Holocaust Studies

#### 3.1. Material and Documentary Evidence

In orthodox Holocaust studies material evidence is practically nonexistent:

- To date, not a single mass grave has been searched for, found, exhumed or examined relative to this subject complex.<sup>14</sup>
- Not one of the allegedly numerous and giant burning sites has been looked for, located, dug up or examined.
- In no case were the alleged murder weapons sought and found, *i.e.*, examined forensically by international committees or by courts under the rule of law.

It is thus not surprising that Ruckerl dispenses with any mention of material evidence and instead declares documentary evidence as the best and most important form of evidence even without any material evidence with respect to the authenticity and correctness of the documents themselves.<sup>15</sup>

Otherwise, only Revisionists have presented material evidence, as other authors will do in the following.

<sup>10</sup> E. Schneider, *op. cit.* (note 4), pp. 310ff.

<sup>11</sup> For ex., cf. S. Klippel, *Monatsschrift für deutsches Recht*, 34 (1980) pp. 112ff.; E. Schneider, *op. cit.* (note 4), p. 188.

<sup>12</sup> *E.g.*, the case of two defendants falsely convicted of murder; reported on *Spiegel-TV*, RTL-Plus, July 15, 1990, 9:45 pm.

<sup>13</sup> R. Bender, S. Röder, A. Nack, *op. cit.* (note 6), p. 76.

<sup>14</sup> Exceptions: cf. A. Neumaier, this vol., about the Treblinka camp site by the State Court at Siedlice; J. C. Ball, this vol., about Auschwitz-Birkenau. Both studies have been kept from the public to date; recently, excavations were made in Belzec, with results confirming revisionist theses, cf. S. Crowell, “*Comments on the Recent Excavations at Belzec*” (online: [codoh.com/newvoices/ncrowell/nrvsbelzecdig.html](http://codoh.com/newvoices/ncrowell/nrvsbelzecdig.html)); Germ.: “*Ausgrabungen in Belzec*”, *Vierteljahreshefte für freie Geschichtsforschung (VffG)* 2(3)(1998), S. 222 (online: [vho.org/VffG/1998/3/Forschung3.html#Crowell](http://vho.org/VffG/1998/3/Forschung3.html#Crowell)). For some strange reasons, the results of this excavation have not yet been published (Spring 2000).

<sup>15</sup> A. Ruckerl, in J. Weber, P. Steinbach (eds.), *Vergangenheitsbewältigung durch Strafverfahren?*, Olzog, Munich 1984, p. 77.



It is always surprising to see how aggressively the historians of the establishment respond to any objection that a document, which allegedly proves the Holocaust, might be forged or falsified, irrelevant, or might have been misinterpreted. On this point our contemporary historians exhibit the same aversion to detailed document criticism<sup>16</sup> as they also cherish where material evidence is concerned. After all, document criticism is nothing more nor less than the expert assessment of a document. In other words, it is the furnishing of material evidence regarding the authenticity and factual correctness of a document.

## 3.2. Eyewitness Evidence in the Orthodox View of the Holocaust

### 3.2.1. Media Statements as Evidence for Historiography?

Part of the testimony or statements regarding the Holocaust came in the form of written declarations or, more recently, as radio and television programs. In both cases it is easy to assess these statements in terms of the points listed under 2, but there is usually no opportunity to speak with the witness personally in order to learn more details and to establish his credibility and the plausibility of his testimony, for example by means of cross-examination. Critiques of the statements published in the various media are both numerous and extensive,<sup>17</sup> and a more comprehensive work was presented recently.<sup>18</sup> However, these witnesses usually evade the requests of critical contemporaries to make themselves available to cross-examination.<sup>19</sup> And while radio and television regularly present new witnesses, they never ask them any critical questions, and deny interested researchers and lawyers access to these witnesses by keeping their address or even their entire identity secret. But these

<sup>16</sup> Cf. the chapter by J. P. Ney in the original German issue of this book: “*Das Wannsee-Protokoll – Anatomie einer Fälschung*”, in E. Gauss (ed.), *Grundlagen zur Zeitgeschichte*, Grabert, Tübingen 1994, pp. 169-191. Ney refused to see his contribution included in this volume.

<sup>17</sup> Aside from the studies of other authors in the present volume, cf. also, e.g., P. Rassinier, *Deutsche Hochschullehrer Zeitung* 2 (1962) pp. 18-23; P. Rassinier, *Das Drama der Juden Europas*, Pfeiffer, Hannover 1965; Paul Rassinier, *Debunking the Genocide Myth*, The Noon Tide Press, Torrance, CA, 1978; W. D. Rothe, *Die Endlösung der Judenfrage*, Bierbaum, Frankfurt/Main 1974, v. 1; W. Stäglich, *Der Auschwitz-Mythos*, Grabert, Tübingen 1979 (online: vho.org/D/dam); W. Stäglich, *Deutschland in Geschichte und Gegenwart (DGG)* 29(1) (1981) pp. 9-13 (online: vho.org/D/DGG/Staeglich29\_1.html); W. Stäglich, U. Walendy, *Historische Tatsache Nr. 5 (HT 5)*, Verlag für Volkstum und Zeitgeschichtsforschung, Vlotho 1979; U. Walendy, *HT 9* (1981), *HT 12* (1982), *HT 31* (1987), *HT 36* (1988), *HT 44* (1990), *HT 50* (1991); I. Weckert, *HT 24* (1985); D. Felderer, *JHR* 1(1) (1980) pp. 69-80 (online: vho.org/GB/Journals/JHR/1/1/Felderer69-80.html); D. Felderer, *JHR* 1(2) (1980) pp. 169-172 (online: .../2/Felderer169-172.html); B.R. Smith, *JHR* 7(2), pp. 244-253; C. Mattogno, *Annales d’Histoire Révisionniste* 5 (1988) pp. 119-165; C. Mattogno, *JHR* 10(1) (1990) pp. 5-47 (online: vho.org/GB/Journals/JHR/10/1/Mattogno5-24.html and .../Mattogno25-47.html); C. Mattogno, “*Medico ad Auchwitz*”: *Anatomia di un falso*, Edizioni La Sfinge, Parma 1988; C. Mattogno, *Il rapporto Gerstein. Anatomia di un falso*, Sentinella d’Italia, Monfalcone 1985; R. Faurisson, *DGG* 35(2) (1987) pp. 11-14; R. Faurisson, *Annales d’Histoire Révisionniste* 4 (1988) pp. 135-149, 163-167; E. Aynat, *Los ‘Protocolos de Auschwitz’: Une fuente histórica?*, García Hispán, Alicante 1990; R. Faurisson, *Nouvelle Vision (NV)* 28 (1993) pp. 7-12; P. Marais, *En lisant de près les écrivains chantres de la Shoah – Primo Levi, Georges Wellers, Jean-Claude Pressac*, La Vielle Taupe, Paris 1991; G. Rudolf, Germar, *The Rudolf Report*, Theses & Dissertations Press, Chicago, IL, March 2003 (online: vho.org/GB/Books/trr); O. Humm, *VffG* 1(2), pp. 75-78 (online: vho.org/VffG/1997/2/Humm2.html); H. Pedersen, *ibid.*, pp. 79-83 (online: .../2/Pedersen2.html); G. Rudolf, *ibid.*, 1(3) (1997), pp. 139-190 (online: .../3/RudMue3.html); G. Baum, *ibid.*, pp. 195-199 (online: .../3/Baum3.html), J.-M. Boisdefeu, E. Aynat, “*Victor Martin y el ‘rapport’ Martin. Estudio de su valor como fuente histórica*”, in Boisdefeu, Aynat, *Estudios sobre Auschwitz*, publ. by E. Aynat, Valencia 1997; from the opposite side, cf. the responses (few and far between) by, for ex., J. S. Conway, *Vierteljahrshefte für Zeitgeschichte (VfZ)* 27 (1979) pp. 260-284, as well as the devastating critique by J.-C. Pressac, *Auschwitz: Technique and Operation of the Gas Chambers*, Beate Klarsfeld Foundation, New York 1989, pp. 124ff., 161f., 174, 177, 181, 229, 239, 379ff., 459-502.

<sup>18</sup> J. Graf, *Auschwitz. Tätergeständnisse und Augenzeugen des Holocaust*, Verlag Neue Visionen, Würenlos (CH) 1994 (online: vho.org/D/atuadh).

<sup>19</sup> For two interesting exception cf. G. Rudolf, and G. Baum, both *op. cit.* (note 17).

paper- and celluloid-witnesses can only be accorded evidential value once their statements have stood up to critical examination. In the following chapter, Robert Faurisson reports about the first two of such a critical examination of this kind of witness to date. In this section, therefore, we will focus primarily on statements made in court, particularly since the supposed justness of the German justice system prompts the public to accord these a greater significance.

### 3.2.2. Court Testimony as Evidence for Historiography?

The very critical view, at least theoretically, taken by courts of witness and party testimony is based on the understanding of human nature gained in the course of centuries by many jurists. It should be accepted as a valid guideline by historians as well, even if the methods used to determine truth in scientific pursuits are necessarily different than those employed in court. For example, while a Court must reach an absolute decision regarding what is true and what is false, and must do so within a limited period of time, science cannot, indeed may not reach a conclusive and final verdict if it wants to remain true to its maxim of openness in every respect. Whereas in a court case the close relation of the proceedings to a human fate causes emotion to exert a strong and distorting influence on the process by which the verdict is reached, this influence usually is, or should be, minor in scientific pursuits.

When we discuss in the following the witness testimony and confessions that represent almost the entirety of the foundation on which the structure of the Holocaust rests, we must bear in mind that for the most part these statements were made in the course of trials or at least for the purpose of incriminating or exonerating someone before a court or the public. Practically no eyewitness accounts exist that were made outside a courtroom situation and free of emotion. The subject matter itself and the emotions with which it is charged have seen to that. The truth of testimony and confessions must therefore be carefully examined before the court by qualified experts – something that regularly does *not* happen in the so-called “NSG trials”.<sup>20</sup> And all the more we must ask to what extent such testimony can serve the cause of a science dependent for its closest possible approach to the truth on reports not tainted by emotion. It is already a very questionable procedure to try to ‘write history’ through eyewitness testimony in court and through the verdicts based thereon, even if both were the result of trials conducted strictly under the rule of law. The procedure becomes all the more suspect when those who ‘write the history’ draw on eyewitness testimony as evidence even when this testimony was rejected by the ruling court as lacking credibility.<sup>21</sup>

The science of historiography is thus faced with the dilemma that it has only these at least partially questionable statements to rely on, and must therefore make do with them. But then it is all the more important for this science to consider the circumstances under which these statements came about, for their value depends not least of all on how fairly the prosecution, the defense and the Court, but also the media and the general public were disposed towards the witnesses and the accused.

### 3.2.3. An Expert Opinion about the Value of Testimony Regarding the Holocaust

There is currently no topic of human history that is treated more emotionally and one-sidedly in public than the Holocaust. It represents the central taboo of western civilization, and to question it is the epitome of heresy, and punishable by imprisonment in many western democracies.

---

<sup>20</sup> NSG = Nationalsozialistische Gewaltverbrechen, *i.e.*, violent National Socialist crimes; NSG trials = the trials prosecuting violent crimes allegedly committed by the National Socialist regime.

<sup>21</sup> *E.g.*, E. Kogon, H. Langbein, A. Rückerl *et al.* (eds.), *Nationalsozialistische Massentötungen durch Giftgas* (Fischer, Frankfurt/Main 1983), base their studies on documents and testimony from the archives of various Public Prosecutors’ Offices; it cannot be verified, however, whether these were ever accepted as evidence by the Courts in question.

Given this state of affairs, the expert on the evaluation of eyewitness testimony, Professor Elisabeth Loftus, pointed out in 1991 that, for many different reasons, testimony pertaining to actual (or merely alleged) National Socialist atrocities, witnessed in a particularly high stage of emotion, is less reliable than almost any other testimony. Elaborating, she observes:

- a) The time elapsed since the end of World War II has contributed to an inevitable fading of recollections.
- b) In trials of alleged National Socialist criminals pre-trial publicity has meant that witnesses had generally known the identity of the defendants and the crimes they were charged with already before the trial.
- c) Prosecutors have asked witnesses leading questions, such as whether they could recognize the accused as the perpetrator. Witnesses have rarely been called on to identify the accused from a number of unknown people.
- d) It is fairly certain that witnesses have discussed identifications among themselves, which facilitated subsequent ‘identifications’ by other witnesses.
- e) Photos of defendants have been exhibited repeatedly, each additional showing of the pictures making witnesses more familiar with the face of the accused, and thus increasingly certain.
- f) The extremely emotional nature of these cases further increases the risk of a distortion of memory, since the accused to be identified by the witnesses were more than alleged tool of the National Socialists – they were devils incarnates: said to have tortured, maimed and mass-murdered prisoners. They were allegedly responsible for the murder of the witnesses’ mothers, fathers, brothers, sisters, wives and children.<sup>22</sup>
- g) Professor Loftus, herself Jewish, uses her own experience to describe how a false sense of loyalty to her heritage and her people and “*race*”, as she puts it, prevented her from taking a stand against the obviously false testimony of her fellow Jews. It is safe to assume that this is a widespread, common reflex among Jews.<sup>23</sup>

However, she omits three further factors that can contribute additionally to the massive distortion of memory where the Holocaust is concerned:

- a) Accounts of witnesses’ personal experiences have always – and not only during criminal trials – been widely disseminated by word of mouth, print and broadcast media, and particularly among the witnesses themselves through personal correspondence and all sorts of relief organizations.
- b) Since at least the late 1970s the topic of the Holocaust has been ever-present in the mass media, and in an extremely one-sided manner, so that memories inevitably become standardized.
- c) Where the Holocaust is concerned, it is not only unforgivable but at times even a criminal offense not to know, not to admit, or perhaps only to doubt, certain things. There is thus a very strong social (or even legal) pressure on witnesses in particular to recall certain ‘facts’ and to repress others.

If one considers all these factors and combines them with studies on the manipulability of human memory, such as the one recently published by Prof. Loftus in a leading scientific journal,<sup>24</sup> then one *cannot help* but conclude that there is in fact no eye witness testimony less reliable than those

---

<sup>22</sup> E. Loftus, K. Ketcham, *Witness for the Defense*, St. Martin’s Press, New York 1991, p. 224; cf. review in J. Cobden, *Journal of Historical Review (JHR)*, 11(2) (1991) pp. 238-249 (online: [vho.org/GB/Journals/JHR/11/2/Cobden238-249.html](http://vho.org/GB/Journals/JHR/11/2/Cobden238-249.html)). The author thanks R. Faurisson for the latter reference.

<sup>23</sup> *Ibid.*, pp. 228f.

<sup>24</sup> E. Loftus, “*Creating False Memories*”, *Scientific American*, September 1997, pp. 50-55, with more references to more recent expert literature; German: “*Falsche Erinnerungen*”, *Spektrum der Wissenschaft* Januar 1998, pp. 62-67; see also David F. Bjorklund (ed.), *False-Memory Creation in Children and Adults*, Lawrence Erlbaum Ass., Mahwah, NJ, 2000.

on the Holocaust. If in normal scientific and legal proceedings one accepts as a rule that eyewitness testimony is the least reliable kind of evidence, then insofar as the Holocaust is concerned it is necessary to observe that here the eyewitness testimony may only serve to flesh out the framework of historical events as established by documentary evidence, and perhaps to give clues to events whose occurrence has yet to be proven by documents or material evidence. But anyone who relies chiefly on eyewitness testimony and assigns it a greater value as evidence than documentary or even material evidence cannot seriously claim to adhere to the scientific method in his work. Thus, the present volume pays particular attention to the critical analysis of many claims made by witnesses.

### 3.3. Methods of Obtaining Testimony

#### 3.3.1. Allied Post-War Trials

In order to assess the value of eyewitness testimony and confessions relating to the Holocaust, one must first examine the conditions prevailing in the Allied post-war trials in Nuremberg and elsewhere. For it is the verdicts handed down in these trials which recorded, in sketchy outlines, the accounts of the Holocaust given by eyewitness testimony and putative confessions. These Allied trials may be roughly divided into two types, namely those carried out by the respective occupying powers as these saw fit, and those carried out with at least initial co-operation between the victorious powers within the framework of the International Military Tribunal (IMT) in Nuremberg.<sup>25</sup>

##### 3.3.1.1. American Trials

Immediately after the end of the war the Americans placed all Germans who held leading positions in the Party, the state or the economy under “*automatic arrest*” without trial.<sup>26</sup> In this way hundreds of thousands ended up in prison camps consisting in the main only of fenced-in meadows. Shortly after the end of the war all German prisoners were stripped of their status as prisoners-of-war.<sup>27</sup> The Allies considered civilian internees to have no rights whatsoever; particularly in the American and French spheres of influence, these prisoners lived mostly in burrows in the ground, received insufficient food, were denied all medical assistance, and neither the International Red Cross nor other organizations nor even private individuals were allowed to help. In this way the prisoners in the American run camps died like flies by the hundreds of thousands.<sup>28</sup>

Military Government Ordinance No. 1 required every German, on pain of lifetime imprisonment, to give the Allies any and all information they required.<sup>29</sup> Thus German witnesses could be forced to give evidence by imprisoning them for years, subjecting them to hours of interrogation, or threatening to hand them over to the Russians.<sup>30</sup> A separate department, “*Special Project*”, was responsi-

<sup>25</sup> A remarkable study about the Nuremberg Trials was presented by M. Weber, *JHR* 12(2) (1992) pp. 167-213 (online: [ihr.org/jhr/v12/v12p167\\_Webera.html](http://ihr.org/jhr/v12/v12p167_Webera.html)).

<sup>26</sup> R. Hilberg, *The Destruction of the European Jews*, Quadrangle Books, Chicago 1961, p. 691; M. Lautern, *Das letzte Wort über Nürnberg*, Dürer, Buenos Aires 1950, p. 18; cf. the accounts of personal experience by J. Gheorge, *Automatic Arrest*, Druffel, Leoni 1956; J. Hiess, *Glaserbach*, Welsermühl, Wels 1956; L. Rendulic, *Glaserbach – Nürnberg – Landsberg*, Stocker, Graz 1953; M. Brech, W. Laska, H. von der Heide, *JHR* 10(2) (1990) pp. 161-185 (online: [vho.org/GB/Journals/JHR/10/2/Brech161-166.html](http://vho.org/GB/Journals/JHR/10/2/Brech161-166.html) and following).

<sup>27</sup> D. Irving, *Der Nürnberger Prozeß*, 2<sup>nd</sup> ed., Heyne, Munich 1979, p. 26; R. Tiemann, *Der Malmedy-Prozeß*, Munin, Osnabrück 1990, pp. 70, 93f. Since D. Irving published a more sophisticated book about Nuremberg, (D. Irving, *Nuremberg. The Last Battle*, Focal Point, London 1996) the reader should refer to this, even though it could not be included in detail in this study which was written prior to its publication.

<sup>28</sup> J. Bacque, *Other Losses*, Stoddart, Toronto 1989.

<sup>29</sup> Enacted on Aug. 16, 1945; A. von Knieriem, *Nürnberg. Rechtliche und menschliche Probleme*, Klett, Stuttgart 1953, p. 158.

<sup>30</sup> F. Utley, *The High Cost of Vengeance*, Regnery, Chicago 1949, p. 172.

ble for obtaining incriminating evidence against reluctant witnesses. The material obtained in this way was used to bend the witnesses to the Allies' will, since this information was used to threaten them with prosecution if they refused to give incriminating evidence against others.<sup>31</sup>

This fact alone shows that after the war every German was practically outlawed and became fair game for persecution, and found himself unexpectedly in a situation where he would give the Allies any information they sought – even if such information was false – rather than suffer the blows of arbitrary despotism looming over him at every turn.

In the American Occupation Zone, trials against various defendants were conducted under the United States' or U.S. Army's sovereignty in Dachau, Ludwigsburg, Darmstadt and Salzburg.<sup>32</sup> These trials fell roughly into three categories:

- crimes in concentration camps (including the cases of euthanasia);
- murders of bailed-out Allied plane crews;
- the alleged war crime of Malmedy at the Ardennes Offensive.

Preparation for these trials included the interrogation of suspects and witnesses in various camps and prisons known as torture chambers today, such as Ebensee, Freising, Oberursel, Zuffenhausen and Schwäbisch Hall.<sup>33</sup> Rückerl comments succinctly:

*“Even the Americans themselves soon objected to the way in which some American military tribunals conducted their trials, particularly to the fact that what was repeatedly used as evidence in these trials were confessions of the accused which had been obtained in preliminary hearings, sometimes under the worst possible physical and psychological pressure.”*<sup>34</sup>

In fact, until 1949 there were several American investigating committees which looked into a part of those accusations that had been brought by German and also by American defense attorneys, particularly by R. Aschenauer, G. Froeschmann and W. M. Everett.<sup>32,35f.</sup> However, these committees – whose reports were published only in part, and not until public pressure had been brought to bear<sup>37</sup> – were accused by the American side of being merely symbolic fig-leaves for the Army and for politics alike, since they had served merely to cover up the true extent of the scandal.<sup>38</sup> For example, the National Council for Prevention of War commented on the conclusions of the Baldwin Commission, which exonerated the Army from grave misdemeanors, as follows:

*“The Commission concluded its report with recommendations for reform of future proceedings of this sort – but these recommendations give the lie to all the excuses and exonerations making up the greatest part of the report. In effect, the bottom line stated, ‘Even if you didn’t do it, we don’t want you to do it again’ [...].”*<sup>39</sup>

Senator J. McCarthy, who had been sent by the American Senate to act as an observer, turned out to be especially committed. Protesting against the collaboration between the members of the investigating committee and the American Army in their efforts to cover up the scandal, he resigned his

---

<sup>31</sup> *Op. cit.*, p. 171; M. Lautern, *op. cit.* (note 26), p. 24.

<sup>32</sup> R. Aschenauer, *Macht gegen Recht*, Arbeitsgemeinschaft für Recht und Wirtschaft, Munich 1952, p. 5; cf. also *ibid.*, *Zur Frage einer Revision der Kriegsverbrecherprozesse*, pub. by author, Nuremberg 1949, see esp. pp. 14ff.

<sup>33</sup> R. Tiemann, *op. cit.* (note 27), pp. 71, 73; F. Oscar, *Über Galgen wächst kein Gras*, Erasmus-Verlag, Braunschweig 1950, pp. 77ff.

<sup>34</sup> A. Rückerl, *NS-Verbrechen vor Gericht*, C. F. Müller, Heidelberg 1984, p. 98.

<sup>35</sup> Regarding G. Froeschmann cf. O. W. Koch, *Dachau – Landsberg, Justizmord – oder Mord-Justiz?*, Refo-Verlag, Witten 1974.

<sup>36</sup> Regarding W. M. Everett cf. R. Tiemann, *op. cit.* (note 27), esp. pp. 82, 103ff. This also contains the best account of the activities of the various investigative committees.

<sup>37</sup> R. Tiemann, *ibid.*, p. 144.

<sup>38</sup> *Ibid.*, esp. pp. 160ff., 175ff., 282ff.; R. Aschenauer, *Macht gegen Recht*, (note 32), p. 65f.

<sup>39</sup> R. Tiemann, *op. cit.* (note 27), p. 181.

function as observer after only two weeks and gave a moving address to the U.S. Senate.<sup>40</sup> The manner in which the Americans extorted confessions from accused persons, or statements from reluctant witnesses subjected to automatic arrest both in the prisons for those awaiting trial as well as during the main hearing in Dachau, left clearly visible marks: the methods used were:

- skin burns
- destruction of the bed of the (finger-, *i.e.*, toe-)nails with burning matches
- torn-out fingernails
- knocked-in teeth
- broken jaws
- crushed testicles
- wounds of all kinds due to beatings with clubs
- brass knuckles and kicks
- being locked up naked in cold, damp and dark rooms for several days
- imprisonment in hot rooms with nothing to drink
- mock trials
- mock convictions
- mock executions
- bogus clergymen, and many more.<sup>41,42</sup>

According to Joachim Peiper, principal defendant in the Malmedy Trial, what was even worse than these so-called third-degree interrogation methods was the feeling of being completely at the mercy of others while being totally cut off from the outside world and one's fellow prisoners. Another method the Americans used, which was often successful, was to play the prisoners off against each other with threats and promises in order to obtain false incriminating statements. This would help to break the prisoners' resistance, which had its roots in the solidarity among them (second-degree interrogations).<sup>43</sup>

The protocols of these interrogations, which lasted for hours and even days, were cut-and-pasted into so-called affidavits by the prosecution; those parts which exonerated the accused were deleted, and contents were frequently distorted by re-wording.<sup>44</sup> Aside from these dubious affidavits, anything and everything was admissible as evidence, including, for example, un-notarized copies of documents as well as third-hand statements (hearsay).<sup>45</sup> In one case even the unfinished, unsigned affidavit of one accused whom all the abuse had driven to suicide was used as evidence!<sup>46</sup> And Order SOP No. 4 promised that any accused who offered to give State's evidence to incriminate others

<sup>40</sup> Congressional Record-Senate No. 134, July 26, 1949, pp. 10397ff., reprinted in its entirety in R. Tiemann, *op. cit.* (note 27), pp. 269ff.

<sup>41</sup> Aside from McCarthy, *op. cit.* (note 40), also cf. R. Aschenauer, *Macht gegen Recht*, (note 32), F. Utley, *op. cit.* (note 30), esp. pp. 190ff.; F. Oscar, *op. cit.* (note 33), pp. 38ff.

<sup>42</sup> J. Halow, *JHR* 9(4) (1989) pp. 453-483 (online: [vho.org/GB/Journals/JHR/9/4/Halow453-483.html](http://vho.org/GB/Journals/JHR/9/4/Halow453-483.html)); J. Halow, *Siegerjustiz in Dachau*, Druffel, Leoni 1993; for a typical example, cf. the case of Ilse Koch in A. L. Smith, *Die "Hexe von Buchenwald"*, Böhlau, Cologne 1983; for Malmedy cf. also R. Merriam, *JHR* 2(2) (1981) pp. 165-176 (online: [.../2/2/Merriam165-176.html](http://.../2/2/Merriam165-176.html)).

<sup>43</sup> R. Tiemann, *op. cit.* (note 27), pp. 86, 220f.

<sup>44</sup> A. von Knieriem, *op. cit.* (note 29), pp. 159, 169; M. Lautern, *op. cit.* (note 26), p. 41ff.; see also the chapter by I. Weckert, this volume.

<sup>45</sup> R. Aschenauer, *Macht gegen Recht*, (note 32), pp. 32f.; cf. Article 7, Ordinance No. 7 of the Military Government of the American Zone, in A. von Knieriem, *op. cit.* (note 29), p. 558.

<sup>46</sup> R. Tiemann, *op. cit.* (note 27), p. 102.

would be set free.<sup>47</sup> The effects of this regulation was demonstrated by Lautern, who described two cases in which the accused bought their freedom with false statements incriminating third parties.<sup>48</sup>

Up to the start of the trials the accused had no legal representation whatsoever, and even during the trials the defense attorneys rarely provided effective support, since these defense counsels (appointed by the Court) in many cases were themselves citizens of the victorious powers, usually with a poor command of the German language. They showed little interest in defending their clients and sometimes even acted blatantly as prosecutors, going so far as to threaten the defendants and to persuade them to make false confessions of guilt.<sup>49</sup> But even if, like American attorney W. M. Everett for example, they were willing to carry out their duties as defense counsels, the prosecution and the Court made this almost impossible for them: the defense was reluctantly given only partial access to pertinent documents, and conversations with the accused were not possible until just before and sometimes not even until after the trials had begun, and only ever under Allied supervision. Frequently it was not until just before the trial that the defense was informed of the charges, which tended to be sweeping and general in nature.<sup>50</sup> Motions to hear witnesses for the defense, or to contest evidence such as extorted statements, were usually refused.<sup>51</sup> And this was fully in accordance with the regulations of the American Occupation Power; Article 7 of Ordinance Number 7 of the Military Government for the American Zone states, with respect to the charter of certain military tribunals:

*“The Tribunals shall not be bound by technical rules of evidence [...] The tribunal shall afford the opposing party such opportunity to question the [...] probative value of such evidence as in the opinion of the tribunal the ends of justice require.”*<sup>52</sup>

It was left to the Court to decide what was necessary. In other words, the protocol was purely arbitrary.

It is an interesting matter to determine how the incriminating statements, especially those made by former inmates of the concentration camps, are to be evaluated. The prosecution used a special technique to obtain these statements – so-called “*stage shows*” or “*revues*”.<sup>53</sup> For this purpose the prosecution gathered up former concentration camp inmates and put them into an auditorium. The accused were placed on a well-lit stage while the former inmates sat in the darkened room and could bring any and all conceivable accusations against the accused, accompanied at times by furious yelling and the most vile curses. In those cases where, contrary to expectation, no charges were made against an accused, or when those accusations that were made seemed insufficient, the prosecution helped matters along by persuading and sometimes even threatening the witnesses.<sup>54</sup> If this shameful tactic still did not suffice to obtain incriminating statements, the prosecution nevertheless did not shy away from a trial; exonerating statements were simply destroyed by the prosecution.<sup>55</sup> These stage-shows continued until an American officer donned an SS uniform and appeared on the stage before the howling witnesses, who promptly incriminated him as a concentration camp thug.<sup>56</sup>

---

<sup>47</sup> Address by J. McCarthy, *op. cit.* (note 40); R. Tiemann, *op. cit.* (note 27), p. 275.

<sup>48</sup> M. Lautern, *op. cit.* (note 26), p. 32, regarding E. von dem Bach-Zelewski and F. Gaus. The cases of W. Höttl and D. Wisliceny are similar – and the list could go on.

<sup>49</sup> R. Aschenauer, *Macht gegen Recht*, (note 32), pp. 29f., 43f.

<sup>50</sup> R. Aschenauer, *ibid.*, pp. 26ff.; F. Utley, *op. cit.* (note 30), p. 197.

<sup>51</sup> R. Tiemann, *op. cit.* (note 27), pp. 91, 96f., 103.

<sup>52</sup> A. von Knieriem, *op. cit.* (note 29), p. 558.

<sup>53</sup> Cf. R. Aschenauer, *Macht gegen Recht*, (note 32), pp. 18ff.; O. W. Koch, *op. cit.* (note 35), p. 127.

<sup>54</sup> R. Aschenauer, *ibid.*, p. 24ff., 33f.

<sup>55</sup> R. Aschenauer, *ibid.*, p. 21.

<sup>56</sup> Gesellschaft für freie Publizistik, *Das Siegertribunal*, Nation Europa, Coburg 1976, pp. 69f.

Defense witnesses from the concentration camps were withheld, threatened, sometimes even arrested and abused by the prosecution.<sup>57</sup> Many former concentration camp inmates threatened their one-time fellow sufferers with reprisals against their families or even with incriminating statements and indictments against them if they failed to give sufficiently incriminating testimony or statements against third parties. Even threats of murder are documented to have been made against fellow prisoners.<sup>58</sup> The VVN (*Vereinigung der Verfolgten des Naziregimes* = Organization of Persons Persecuted by the Nazi Regime),<sup>59</sup> the organization that decided which former inmates living in the starving Germany of those days would receive food rations, housing authorization etc., used its power to pressure many former fellow prisoners into not taking the stand as defense witnesses. It even expressly forbade the former fellow prisoners to give exonerating testimony.<sup>60</sup>

Those witnesses who were willing to give incriminating evidence were conspicuous by virtue of their frequent appearance, sometimes in groups, at various trials where they could expect to receive considerable compensation, both financial and in goods. In many cases these “*professional witnesses*”, who openly coordinated their testimony amongst themselves, were criminal ex-convicts who had been promised exemption from punishment in return for their cooperation.<sup>61</sup> Judges G. Simpson and E. L. van Roden, whom the U. S. Army had appointed as investigating commission, are said to have used the term “*scum of humanity*” in this context.<sup>62</sup> Even when such or other witnesses were found to have perjured themselves, they were never prosecuted.<sup>63</sup> On the contrary: only if a witness told the Court of the methods with which his testimony had come about, and thus rescinded his statements – only then did the prosecution take steps against him.<sup>64</sup>

In principle, the trials in Dachau were all the same, regardless of whether they dealt with crimes in the concentration camps, with murders of airmen, or with the Malmedy Case. F. Oscar correctly points out<sup>65</sup> that torture was worse in the Malmedy Case due to the dearth of ‘witnesses’, while the superfluity of ‘witnesses’ in the concentration camp cases resulted in “*stage shows*” instead. In the euthanasia and physicians cases the method of choice was the confiscation of exonerating documents and the suppression of exculpatory statements.<sup>66</sup> Freda Utley stated<sup>67</sup> that the concentration camp cases were even worse than the Malmedy Case, which was already unparalleled.<sup>68</sup>

What must one think of historians who, like Thomas A. Schwartz, claimed as late as 1990 and in Germany’s foremost periodical on contemporary history, that the American trials had been conducted in accordance with the stipulations of the Geneva Convention; that the main problem with these trials had merely been the lack of opportunity for appeal and the uncertain future treatment of the convicted; that the cases of Ilse Koch<sup>63</sup> and Malmedy were the only ones of particular significance;

<sup>57</sup> R. Aschenauer, *Macht gegen Recht*, (note 32), pp. 42f.; R. Tiemann, *op. cit.* (note 27), p. 98ff., 103.

<sup>58</sup> F. Utley, *op. cit.* (note 30), pp. 195.

<sup>59</sup> Later on the VVN was declared an unconstitutional Communist association.

<sup>60</sup> R. Aschenauer, *Macht gegen Recht*, (note 32), pp. 42f.; F. Utley, *op. cit.* (note 30), p. 198; O. W. Koch, *op. cit.* (note 35), p. 53; Gesellschaft für freie Publizistik, *op. cit.* (note 56), p. 67.

<sup>61</sup> R. Aschenauer, *Macht gegen Recht*, (note 32), pp. 21, 24ff.; F. Utley, *op. cit.* (note 30), pp. 195, 198; O. W. Koch, *op. cit.* (note 35), pp. 48, 55; cf. note 48 (‘Crown witness’).

<sup>62</sup> Gesellschaft für freie Publizistik, *op. cit.* (note 56), p. 69.

<sup>63</sup> M. Lautern, *op. cit.* (note 26), pp. 33, 51.

<sup>64</sup> M. Lautern, *ibid.*, pp. 42f., describes such a case; cf. also the fate of E. Puhl, Vice President of the Reichsbank, during the IMT: H. Springer, *Das Schwert auf der Waage*, Vowinkel, Heidelberg 1953, pp. 178f.

<sup>65</sup> R. Aschenauer, *Macht gegen Recht*, (note 32), p. 13; F. Oscar, *op. cit.* (note 33), pp. 67f.

<sup>66</sup> For the best-documented example of a miscarriage of justice concerning a physician, cf. Zeitgeschichtliche Forschungsstelle Ingolstadt (ed.), *Der Fall Rose. Ein Nürnberger Urteil wird widerlegt*, Mut-Verlag, Asendorf 1988.

<sup>67</sup> F. Utley, *op. cit.* (note 30), p. 194.

<sup>68</sup> To date, the only example of a Dachau trial that has been reviewed in detail: cf. A. L. Smith, *op. cit.* (note 42), esp. pp. 110ff.



and that the committee appointed by the U.S. Senate had exonerated the American occupation authorities from the more serious charges?<sup>69</sup> One must think that Schwartz was either extremely ignorant or extremely perverse!

### 3.3.1.2. British Trials

In the first post-war years the British, on the whole, acted no differently than the Americans. According to Aschenauer, the main features of the American post-war trials also characterized those British trials taking place in Werl,<sup>70</sup> where leading officers of the Wehrmacht as well as concentration camp guards from Auschwitz, Bergen-Belsen and Natzweiler were tried.<sup>71</sup> One fundamental difference, however, was that no investigating commissions were introduced during or after these trials, so that the internal proceedings of, for example, the British interrogation camps and prisons – most notably Minden,<sup>72</sup> Bad Nenndorf<sup>73</sup> and Hameln – remained sub-surface.

From two examples, however, it becomes clear that interrogation methods of second and third degree were the rule there as well. The first example is the torture of the former Commandant of Auschwitz, Rudolf Höß, in the prison of Minden. This torture was not only mentioned by Höß himself in his autobiography,<sup>74</sup> but has also been confirmed by one of his torturers<sup>75</sup> who, rather as an aside, also mentioned the torture of Hans Frank in Minden.<sup>76</sup> And further, in his testimony before the International Military Tribunal (IMT), Oswald Pohl reported that similar methods were used in Bad Nenndorf and that this was how his own affidavit had been obtained.<sup>77</sup> The example of Höß is especially important since his statement was used at the IMT as the confession of a perpetrator, to prove the mass murder of the Jews (see 3.3.1.5). In 2001, Patricia Meehan revealed some ugly features of the network of secret “*Direct Interrogation Centres*” the British had set up in their occupational zone of Germany. Those centers are indeed best characterized as torture chambers to receive ‘evidence’ for the upcoming trials.<sup>78</sup>

---

<sup>69</sup> T. A. Schwartz, “*Die Begnadigung deutscher Kriegsverbrecher*”, *VfZ* 38 (1990) pp. 375-414.

<sup>70</sup> R. Aschenauer, *Macht gegen Recht*, (note 32), pp. 72ff.

<sup>71</sup> A. Ruckerl, *op. cit.* (note 34); for a comprehensive discussion of the British trial of the suppliers of Zyklon B to Auschwitz, cf. W. B. Lindsey, *op. cit.* (note 1).

<sup>72</sup> According to R. Faurisson, *Annales d’Histoire Révisionniste* 1 (1987) p. 149 (online: [abbc.com/aaargh/fran/archFaur/1986-1990/RF8703xx1.html](http://abbc.com/aaargh/fran/archFaur/1986-1990/RF8703xx1.html)); Minden/Weser was the interrogation headquarters of the British military police.

<sup>73</sup> R. Aschenauer, *Macht gegen Recht*, (note 32), p. 72, tells of the infamous Special Camp Bad Nenndorf, where preliminary hearings culminated in severe physical abuse.

<sup>74</sup> R. Höß, in M. Broszat (ed.), *Kommandant in Auschwitz*, dtv, Munich 1983, pp. 149f.; cf. R. Faurisson, *op. cit.* (note 72), p. 137-152; in English: *JHR* 7(4) (1986) pp. 389-403; in German: *DGG* 35(1) (1987) pp. 12-17 (online: [vho.org/D/DGG/Faurisson35\\_1.html](http://vho.org/D/DGG/Faurisson35_1.html)); cf. also R. Faurisson, *NV* 33 (1994) pp. 111-117.

<sup>75</sup> B. Clarke, as quoted in R. Butler, *Legions of Death*, Arrow Books Ltd., London 1986, pp. 236f.

<sup>76</sup> R. Butler, *ibid.*, pp. 238f.

<sup>77</sup> O. Pohl, “*Letzte Aufzeichnungen*”, in U. Walendy, *Historische Tatsachen Nr. 47*, Verlag für Volkstum und Zeitgeschichtsforschung, Vlotho 1991, pp. 35ff.; M. Lautern, *op. cit.* (note 26), pp. 43ff.; D. Irving, *Der Nürnberger Prozeß*, *op. cit.* (note 27), pp. 80f.; Pohl considered himself legally innocent, since he had neither caused nor tolerated any atrocities: cf. O. Pohl, *Credo. Mein Weg zu Gott*, A. Girnth, Landshut 1950, p. 43; cf. also A. Moorehead’s account of the rough interrogation methods used by the British in Bergen-Belsen, published in the British monthly *The European*, March 1945; quoted from: F. J. Scheidl, *Geschichte der Verfemung Deutschlands*, pub. by author, Vienna 1967, v. 3, pp. 83ff.; cf. Alan Moorehead’s essay “*Belsen*”, in Cyril Connolly (ed.), *The Golden Horizon*, Weidenfeld & Nicolson, London 1953, pp. 105f.

<sup>78</sup> Patricia Meehan, *A Strange Enemy People: Germans Under The British 1945-50*, Peter Owen Publishers, 2001

### 3.3.1.3. French Trials

We know comparatively little about the French trials of the camp staff of the concentration camps Neue Bremme and Natzweiler.<sup>79</sup> However, judging from the French conduct towards German civilians under “*automatic arrest*”<sup>80</sup> as well as towards the population of the occupied territories<sup>81</sup> – which was just as bad as, if not worse than, the conduct of the Americans – one may conclude that the French were equal to the Americans in every way.

### 3.3.1.4. Soviet-Russian Trials

The trials in the Soviet Occupation Zone can be considered as part of the continuation of the war crimes tribunals that had been held in the Soviet Union ever since the outbreak of hostilities in 1941. In 1950, an official report confirmed that these war crimes trials were a violation of international law.<sup>82</sup> Maurach reports that the preliminary hearings were characterized by continuous, *i.e.*, non-stop interrogations, physical abuse of all kinds, distorted protocols, playing prisoners off against each other, forced denunciation of others, etc; and the main hearings by summary mass trials before special courts governed by arbitrary rules of procedure.<sup>83</sup> There is a general consensus of opinion regarding these procedures, and even the Federal German Ministry of Justice has commented to this effect.<sup>84</sup> In a recent publication by a renowned Russian historian and based on original Russian archives, these early German expert reports were confirmed.<sup>85</sup> The same goes for comparable trials held by the Soviet satellite states in the first few years following the war. Buszko, for example, reports that in Poland, just as with the IMT, a special court was set up whose verdicts were incontestable.<sup>86</sup> Further, the Federal Ministry of Justice has described the early trials in the German Democratic Republic as arbitrary trials<sup>87</sup> whose darkest chapter, the so-called Waldheim Trials, was recently set out in detail by Eisert.<sup>88</sup>

<sup>79</sup> A. Rückerl, *op. cit.* (note 34), p. 99.

<sup>80</sup> Aside from J. Bacque, *op. cit.* (note 28), see also the accounts of brutal torture of internees in Landesverband der ehemaligen Besatzungsinternierten Baden-Württemberg (ed.), *Die Internierung im Deutschen Südwesten*, pub. by ed., Karlsruhe 1960, esp. pp. 73ff.; cf. also A. L. Smith, *VfZ* 32 (1984) pp. 103-121, who bases his study exclusively on official accounts of Allied sources. Would it be equally appropriate to report about the conditions in German concentration camps exclusively on the basis of official contemporaneous accounts of German governmental and administrative sources?

<sup>81</sup> F. Utley, *op. cit.* (note 30), pp. 287ff.

<sup>82</sup> C. Roediger, *Völkerrechtliches Gutachten über die strafrechtliche Aburteilung deutscher Kriegsgefangener in der Sowjetunion*, Heidelberg 1950.

<sup>83</sup> R. Maurach, *Die Kriegsverbrecherprozesse gegen deutsche Gefangene in der Sowjetunion*, Arbeitsgemeinschaft vom Roten Kreuz in Deutschland (British Zone), Hamburg 1950, pp. 79ff.

<sup>84</sup> Reproduced in part in A. Rückerl, *op. cit.* (note 34), p. 100. See also the chapter by I. Weckert, this volume.

<sup>85</sup> A.E. Epifanow, H. Mayer, *Die Tragödie der deutschen Kriegsgefangenen in Stalingrad von 1942 bis 1956 nach russischen Archivunterlagen*, Biblio, Osnabrück 1996; cf. E. Peter, A. Epifanow, *Stalins Kriegsgefangene*, Stocker, Graz 1997.

<sup>86</sup> J. Buszko, *Auschwitz. Geschichte und Wirklichkeit des Vernichtungslagers*, Rowohlt, Reinbek 1980, pp. 193ff.; R. Henkys, *op. cit.* (note 9), p. 191, believes that in 1947 the Polish took care to ensure that trials were conducted in accordance with the principles of rule-of-law. But since hardly any of these trials at that time in the sphere of influence of Stalin were conducted as such, one wonders on which information Henkys relies.

<sup>87</sup> A. Rückerl, *op. cit.* (note 34), p. 211.

<sup>88</sup> W. Eisert, *Die Waldheimer Prozesse*, Bechtle, Munich 1993; for an account of a more recent trial regarding Oradour and Lidice, cf. H. Lichtenstein, *Im Namen des Volkes?*, Bund, Cologne 1984, pp. 132ff. According to Lichtenstein, the defense acted as secondary prosecution in this trial.

### 3.3.1.5. The International Military Tribunal and its Successor Tribunals

The actual International Military Tribunal consisted of prosecutors and judges from the four Allies Powers – hardly an objective tribunal. It brought 22 of the most important figures from the Third Reich to trial. This Tribunal was followed by twelve further trials of various offices and functions – for example the Reich Government, the Wehrmacht Supreme Command, and the SS Economic-Administrative Main Office – and of professional groups, such as lawyers, and chemical and steel workers. These trials, however, were conducted exclusively by the Americans, since by then the other victorious powers had lost interest.<sup>89</sup>

The London Agreement, which defined the legal framework of the International Military Tribunal (IMT),<sup>90</sup> decreed in its Article 3 that the Tribunal cannot be challenged, and in Article 26 it categorically ruled out any contestability of its verdicts. In accordance with Article 13, the Court also determined its own rules of procedure. These points alone already suffice to strip this tribunal of any legality. Three articles pertaining to the rights of the Court are particularly significant. Article 18, for example, determined that the Court should

“confine the Trial strictly to an expeditious hearing of the issues raised by the charges [sic]”

and that it could refuse any and all questions and explanations it deemed unnecessary or irrelevant. Article 19 states verbatim:

“The Tribunal shall not be bound by technical rules of evidence. It shall adopt and apply to the greatest possible extent expeditious and nontechnical procedure, and shall admit any evidence which it deems to have probative value.”

And Article 21 – the effect of this article still today gives the cloak of respectability to anti-scientific legal conclusions:

“The Tribunal shall not require proof of facts of common knowledge but shall take judicial notice thereof [...].”

According to the London Agreement, these “facts of common knowledge” included anything which any office or commission from any Allied nation claimed in documents, files, reports and protocols. Thus, all ‘evidence’ produced in the trials discussed in 3.3.1.1 to 3.3.1.4 was deemed to be a matter of fact needing no further substantiation. The IMT categorized the SS and the Waffen-SS, for example, as criminal organizations primarily on the basis of the ‘evidence’ produced in the Dachau Trials.<sup>91</sup>

In the time leading up to the trial, the Soviets bluntly stated that they wished to execute the accused without a trial or at most after a summary show-trial, since their guilt was self-evident anyhow.<sup>92</sup> While some voices were raised in agreement on the side of the western Allies,<sup>93</sup> the under-

---

<sup>89</sup> A. Rückerl, *op. cit.* (note 34), pp. 95ff.

<sup>90</sup> Reprinted in its entirety in T. Taylor, *The Anatomy of the Nuremberg Trials*, Little, Boston 1992, pp. 645ff. For accounts of the IMT, cf. also H. Härtle, *Freispruch für Deutschland*, Schütz, Göttingen 1965; H. H. Saunders, *Forum der Rache*, Druffel, Leoni 1986; F. J. P. Veale, *Advance to Barbarism*, Institute for Historical Review, Newport Beach, CA 1983; W. Maser, *Das Exempel*, Blaue Aktuelle Reihe 9, Mut-Verlag, Asendorf 1986; W. E. Benton, G. Grimm (eds.), *Nuremberg. German Views of the War Trials*, Southern Methodist UP, Dallas 1955; C. Haensel, *Der Nürnberger Prozeß*, Moewig, Munich 1983; M. Bardèche, *Nürnberg oder die Falschmünzer*, Priester, Wiesbaden 1957; Reprint: Verlag für ganzheitliche Forschung und Kultur, Viöl 1992; A. R. Wesslerle, *JHR* 2(2) (1981) pp. 155-164 (online: [vho.org/GB/Journals/JHR/2/2/Wesslerle155-164.html](http://vho.org/GB/Journals/JHR/2/2/Wesslerle155-164.html)); C. Porter, *Not Guilty at Nuremberg: The German Defense Case*, Historical Review Press, Brighton 1990 (online: [codoh.com/trials/trintgt.html](http://codoh.com/trials/trintgt.html)); Porter, *Made in Russia: The Holocaust*, *ibid.* 1988 (online: [codoh.com/trials/trimirth.html](http://codoh.com/trials/trimirth.html)).

<sup>91</sup> E.g., L. Greil on the Malmedy Trial in *Oberst der Waffen-SS Jochen Peiper und der Malmedy-Prozeß*, Schild, Munich 1977, p. 90; for the view taken of the SS and Waffen-SS in the IMT, cf. G. Rauschenbach, *Der Nürnberger Prozeß gegen die Organisationen*, L. Röhrscheid, Bonn 1954; cf. also R. Hilberg, *op. cit.* (note 26), p. 692.

<sup>92</sup> A. von Knieriem, *op. cit.* (note 29), pp. 127f.

standing that only a ‘real’ trial could be effective did predominate.<sup>94</sup> The fact that chief prosecutor R. Jackson stated in one of his addresses that this military tribunal was only a continuation of the war against Germany by other means, and that said tribunal was not bound by any limiting conditions imposed by legal systems coming down to modern times through tradition, should instill in any researcher a healthy dose of skepticism regarding the conditions providing the framework of this trial.<sup>95</sup>

Irving described the early investigations of the IMT prosecution as a private event put on by the American Secret Service OSS [Office of Strategic Services], until R. Jackson reduced this influence.<sup>96</sup> Von Knieriem gives a very detailed account of the consequences ensuing from the fact that the prosecution had unlimited access to the entire executive apparatus of all occupation authorities – permitting, for example, their arrest of any witness they chose, the confiscation of all documents and files of the Third Reich, as well as access to the files of the victors – while the defense was completely without means and influence.<sup>97</sup> Since the IMT was conducted in the style of Anglo-Saxon trials, in which – unlike in German trials – the prosecution is not obliged to ascertain and submit any evidence that would serve to exonerate the accused but rather strives to prove the guilt of the accused in a one-sided manner, this unequal ‘arsenal’ of prosecution and defense could not but result in grave miscarriages of justice.<sup>98</sup> Even the Presiding Judges – provided they had been willing to equalize the situation – could not have helped the defense to improve its situation very much, for these judges were merely *de facto* guests of the prosecution, which latter decided all material and personnel matters in Court.<sup>99</sup> The judges had no authority to issue directives, neither to the Occupation Powers nor to the prosecution – not even with regard to the obtainment or hearing of evidence.<sup>100</sup>

In many and sweeping respects the conduct of the IMT was shockingly similar to that of the trials described previously in Section 3.3.1.1. Von Knieriem and many others recount threats of all kinds, of psychological torture,<sup>101</sup> of non-stop interrogation<sup>102</sup> and of confiscation of the property<sup>103</sup> of defendants as well as of coerced witnesses. Intimidation, imprisonment, legal prosecution and other means of coercion was applied to witnesses for the defense,<sup>104</sup> distorted affidavits,<sup>105</sup> documents<sup>106</sup>

<sup>93</sup> D. Irving, *Der Nürnberger Prozeß*, *op. cit.* (note 27), pp. 24ff.; R. Hilberg, *op. cit.* (note 26), pp. 684, 691; cf. C. Haidn, *DGG* 34(3) (1986) pp. 11-14.

<sup>94</sup> A. von Knieriem, *op. cit.* (note 29), pp. 128f.; for a detailed description of the creation of the IMT ‘Lynch Law’ cf. D. Irving, *Nuremberg. The Last Battle*, *op. cit.* (note 27), pp. 1-119.

<sup>95</sup> R. H. Jackson, third address of the Prosecution to the International Military Tribunal in Nuremberg, July 26, 1946, in R. H. Jackson, *Staat und Moral*, Nymphenburger Verlagshandlung, Munich 1946, p. 107.

<sup>96</sup> D. Irving, *Der Nürnberger Prozeß*, *op. cit.* (note 27), p. 39.

<sup>97</sup> A. von Knieriem, *op. cit.* (note 29), pp. 130-200, esp. p. 195: “De facto the Prosecution acted as one of the top occupation authorities.”

<sup>98</sup> Also A. Rückerl, *op. cit.* (note 34), p. 91; J. Weber, *Aus Politik und Zeitgeschichte* 18(48) (1968) pp. 3-31, here p. 11.

<sup>99</sup> M. Lautern, *op. cit.* (note 26), p. 20.

<sup>100</sup> A. von Knieriem, *op. cit.* (note 29), p. 149.

<sup>101</sup> A. von Knieriem, *ibid.*, pp. 158, 189ff.; D. Irving, *Der Nürnberger Prozeß*, *op. cit.* (note 27), pp. 41f., 59, 61; M. Lautern, *op. cit.* (note 26), pp. 47ff., describes the effect of a threat of extradition on Friedrich Wilhelm Gaus, formerly the Chief of the Legal Department of the Foreign Ministry, Ribbentrop’s right-hand man. In the face of this threat the frightened Gaus invented the most dreadful cock-and-bull stories in his attempts to incriminate Ribbentrop and thus to pull his own head out of the noose, which he in fact succeeded in doing. Cf. also F. Utley, *op. cit.* (note 30), p. 172; H. Springer, *op. cit.* (note 64), p. 96; cf. also the interesting statements of R. von Weizsäcker, former president of Germany, in his biography *Vier Zeiten. Erinnerungen*, Siedler, Berlin 1997, p. 125f., who co-defended his father Ernst von Weizsäcker at the IMT.

<sup>102</sup> A. von Knieriem, *op. cit.* (note 29), p. 189; H. Springer, *op. cit.* (note 64), p. 35.

<sup>103</sup> A. von Knieriem, *ibid.*, p. XXIV; F. Utley, *op. cit.* (note 30), pp. 171, 183.

<sup>104</sup> A. von Knieriem, *ibid.*, pp. 191, 198; R. Aschenauer, *Landsberg. Ein dokumentarischer Bericht von deutscher Sicht*, Arbeitsgemeinschaft für Recht und Wissenschaft, Munich 1951, p. 34; D. Irving, *Der Nürnberger Prozeß*, *op. cit.* (note

and synchronized translations;<sup>107</sup> arbitrary refusal to hear evidence,<sup>108</sup> confiscation of documents<sup>109</sup> and the refusal to grant the defense access to documents;<sup>110</sup> as well as to the systematic obstruction of the defense by the prosecution<sup>111</sup> such as, for example, making it impossible for the defense to travel abroad in order to locate defense witnesses,<sup>112</sup> or censoring their mail.<sup>113</sup> We know of professional witnesses who had been interned in concentration camps for severe crimes.<sup>114</sup> Last but not least, we know of verdicts flying crassly in the face of what the evidence demanded,<sup>115</sup> and justified with “*arguments unrivalled in their crudity.*”<sup>116</sup>

When the American attorney E. J. Carroll was prevented from acting as defense counsel in the Krupp case, he sent a letter of protest to General Clay criticizing the IMT trials for, among other things, lengthy and inhumane detention awaiting trial; the withholding of documents by the prosecution and the Court, hearsay evidence, the random nature of documentary evidence, the suppression of witnesses for the defense, and the mandatory presence of members of the prosecution at any discussions held with witnesses; the disappearance of exonerating evidence; the confiscation of property; testimony under duress; and the intimidation of witnesses.<sup>117</sup>

Irving calls the manner in which the IMT prosecution conducted interrogations “*Gestapo methods*”.<sup>118</sup> The prisoners, cut off as they were from the rest of the world and suffering from hunger and cold, were not granted any medical care for injuries they had sustained through abuse by their captors,<sup>119</sup> and even their defense counsels ran the risk of being arrested if they insisted on the rights they might have expected in legal trials – as it happened, for example, to the defense counsel of von Neurath,<sup>120</sup> or to all the defense attorneys in the Krupp Trial.<sup>121</sup> As far as the incriminating testimony provided by former inmates is concerned, Aschenauer detects significant parallels between the concentration camp trials conducted by the USA in Dachau on the one hand, and the trial of the SS Economic-Administrative Main Office in Nuremberg on the other, since in both cases the testimony

27), pp. 63, 78, 80; F. Oscar, *op. cit.* (note 33), pp. 85f., 88f; M. Lautern, *op. cit.* (note 26), pp. 42f., 46.

<sup>105</sup> Aside from note 44 (‘Affidavit’), cf. also the account of a distorted, not to say a downright forged affidavit regarding B. von Richthofen, in Gesellschaft für freie Publizistik, *op. cit.* (note 56), p. 89-92; also L. Rendulic, *op. cit.* (note 26), pp. 59ff.

<sup>106</sup> A. von Knieriem, *op. cit.* (note 29), pp. 193f.

<sup>107</sup> A. von Knieriem, *ibid.*, p. 179ff.

<sup>108</sup> A. von Knieriem, *ibid.*, pp. 168f., 176f.; D. Irving, *Der Nürnberger Prozeß*, *op. cit.* (note 27), p. 82.

<sup>109</sup> A. von Knieriem, *ibid.*, pp. 142, 148; M. Lautern, *op. cit.* (note 26), p. 18.

<sup>110</sup> A. von Knieriem, *ibid.*, pp. 149, 175f.; R. Aschenauer, *op. cit.* (note 104), pp. 34f.; M. Lautern, *op. cit.* (note 26), p. 9ff.; H. Springer, *op. cit.* (note 64), pp. 35, 243.

<sup>111</sup> A. von Knieriem, *op. cit.* (note 29), pp. 149f., 189, 199f.; M. Lautern, *op. cit.* (note 26), pp. 23, 27f.; Lautern is fair and also describes the advantages that the defense counsels enjoyed: free travel within the American Zone, army mail service privileges, the support of Occupation authorities in proceedings instituted against them by the Law Societies, some of which had an active dislike of attorneys who defended ‘Nazis’; cf. pp. 22f.

<sup>112</sup> A. von Knieriem, *op. cit.* (note 29), p. 196.

<sup>113</sup> A. von Knieriem, *ibid.*, p. XXIV.

<sup>114</sup> A. von Knieriem, *ibid.*, p. 191; R. Aschenauer, *op. cit.* (note 104), pp. 32f.; F. Oscar, *op. cit.* (note 33), pp. 89ff.

<sup>115</sup> A. von Knieriem, *ibid.*, p. 178.

<sup>116</sup> A. von Knieriem, *ibid.*, p. 185.

<sup>117</sup> F. Oscar, *op. cit.* (note 33), pp. 32ff.

<sup>118</sup> D. Irving, *Der Nürnberger Prozeß*, *op. cit.* (note 27), p. 37. In this context M. Lautern mentions second-degree interrogations, *op. cit.* (note 26), p. 41; W. Maser terms the interrogations aggressive and harsh: *Nürnberg – Tribunal der Sieger*, Econ, Düsseldorf 1977, p. 127.

<sup>119</sup> D. Irving, *Der Nürnberger Prozeß*, *op. cit.* (note 27), p. 59; H. Springer, *op. cit.* (note 64), pp. 38ff.

<sup>120</sup> For 6 weeks! D. Irving, *Der Nürnberger Prozeß*, *op. cit.* (note 27), p. 80.

<sup>121</sup> F. Utley, *op. cit.* (note 30), pp. 172f.; M. Lautern, *op. cit.* (note 26), pp. 51ff.; one case in the IG-Farben-Trial is described on pp. 60ff.

was provided by the same criminal “*professional witnesses*”.<sup>122</sup> And of course the VVN’s threats and intimidation of former fellow inmates to prevent exonerating testimony were also not lacking in the IMT trials.<sup>123</sup>

Opinions regarding abuse and torture during the IMT trials are divided. Whereas Irving acknowledges them in the form of constant harassment and minor maltreatment,<sup>124</sup> von Knieriem assumes that “*apparently*” there were none.<sup>125</sup> We do know, however, of the severe abuse of J. Streicher, which he described during his interrogation before the IMT.<sup>126</sup> His account about having been tortured was stricken from the protocol at the request of the prosecution.<sup>127</sup> Lautern reports the torture of SS-Gruppenführer Petri,<sup>128</sup> and in his last records O. Pohl told of the maltreatment of Standartenführer Maurer.<sup>129</sup> Mark Weber details a number of additional cases of abuse.<sup>130</sup> This suggests that the main defendants who received much public attention suffered only a lesser degree of physical abuse, while those who received less publicity also risked abuse in Nuremberg if they were not quick enough to cooperate.

The investigating committees mentioned in Section 3.3.1.1. resulted in the revision of some of the verdicts handed down by the IMT and its successor tribunals. In these cases the German Federal government insisted on greater leniency – the result of rearmament following the Korea crisis.<sup>131</sup>

### 3.3.1.6. The Consequences of Allied Post-War Trials

The American trials in Dachau and the similar trials conducted by the other Allies allegedly proved the atrocities committed in the concentration camps and in eastern Europe. The SS and Waffen-SS have been deemed criminal organizations ever since, even if for example the German courts do not treat their members as criminals, but this may be only due to the necessity to avoid illegal retroactive application of new laws. The IMT itself reinforced this assessment through the repeated presentation of ‘evidence’ largely obtained in the aforementioned trials.

The best summary of the consequences of the evidence presented to the IMT may be found in the memoirs of H. Fritzsche. All the main defendants of Nuremberg insisted that prior to the IMT proceedings they had not known of any mass murder of the Jews.<sup>132</sup> After the screening of a dubious film about the concentration camp Dachau and other camps had achieved the desired psychological effect, but had failed to convince completely, the testimonies of R. Höß and O. Ohlendorf finally persuaded most of the accused to accept the mass murder as fact.<sup>133</sup> The murder of the Jews, which was ultimately accepted as proven by most of the accused, affected the defense and the accused and

<sup>122</sup> R. Aschenauer, *op. cit.* (note 104), p. 32.

<sup>123</sup> F. Oscar, *op. cit.* (note 33), p. 85.

<sup>124</sup> D. Irving, *Der Nürnberger Prozeß*, *op. cit.* (note 27), pp. 59ff.

<sup>125</sup> A. von Knieriem, *op. cit.* (note 29), p. 158.

<sup>126</sup> *Times*, London, April 27, 1946. Thanks is due to Prof. R. Faurisson for this reference. Cf. H. Springer, *op. cit.* (note 64), p. 166.

<sup>127</sup> International Military Tribunal, *Trial of the Major War Criminals, (IMT)*, Nuremberg 1947, v. XII, p. 398.

<sup>128</sup> M. Lautern, *op. cit.* (note 26), p. 45.

<sup>129</sup> U. Walendy, *op. cit.* (note 77), p. 37.

<sup>130</sup> M. Weber, *JHR* 12(2) (1992) pp. 167-213, regarding J. Aschenbrenner, F. Sauckel, H. Frank, A. Eigruher, J. Kramer etc (online: [vho.org/GB/Journals/JHR/12/2/Weber167-213.html](http://vho.org/GB/Journals/JHR/12/2/Weber167-213.html)).

<sup>131</sup> R. Rückerl, *op. cit.* (note 34), pp. 97, 130ff.; R. Rückerl, *NS-Prozesse*, C. F. Müller, Karlsruhe 1972, p. 165; R. Hilberg, *op. cit.* (note 26), p. 697; T. A. Schwartz, *op. cit.* (note 69).

<sup>132</sup> R. Hilberg, *op. cit.* (note 26), pp. 688-689; H. Springer, *op. cit.* (note 64), pp. 113ff. Incidentally, Göring insisted until his death that this allegation was untrue, p. 118; cf. also *IMT*, *op. cit.* (note 127), v. IX, p. 618.

<sup>133</sup> H. Springer, *op. cit.* (note 64), p. 87. It is unknown whether Ohlendorf was treated like Höß or Pohl, but in his case even an almost undetectable, ‘gentler’ psychological treatment may have sufficed.

even the fate of the entire nation like a paralyzing curse, since now no one dared still object.<sup>134</sup> Nevertheless the accused were left with the impression that the investigative requirements had not been met:

“*The incomprehensible was proven in a makeshift sort of way, but it was by no means investigated.*”<sup>135</sup>

The fact that the publication *Vierteljahrshefte für Zeitgeschichte* regards the IMT as a fair trial sincerely striving for justice, whose only fault was to be found in its legal foundation, will not surprise anyone familiar with the leftist, partial *Institut für Zeitgeschichte*, the body publishing that periodical.<sup>136</sup>

### 3.3.2. Trials ‘Under the Rule of Law’

The basic treaty establishing the partial sovereignty of the Federal Republic of Germany decreed that the verdicts of the IMT were final and binding for all official and judicial authorities of the Federal Republic.<sup>137</sup> The establishment considers this a handicap, since due to the demands of the Korea Crisis the United States released most of those they had convicted in their post-war trials in fairly short order, with the German justice system missing out on the pleasure of re-charging them even in light of new evidence.<sup>138</sup> But one might also consider the decree to be a handicap in the sense that, through Article 7 of the Treaty, the Allies effectively placed the view of history resulting from their post-war judicial conclusions and verdicts beyond revision even for German courts.

Regarding the significance of witness testimony to the verdicts in trials particularly in the Federal Republic of Germany and Israel, it must first be pointed out that the view of history as the IMT established it with regard to the Holocaust is generally considered to be self-evident and true today. The question of how great a role the transition treaty played in this remains open. Thus, motions to take evidence – particularly material evidence regarding the refutation or even the examination of this ‘truth’, or to question its self-evidence – are refused sight-unseen by the Courts, especially in Germany. These motions to hear evidence are dismissed as mere tactics intended to delay the trial.<sup>139</sup> Anyone who nevertheless insists publicly on his dissenting claims, *i.e.*, beliefs in, or points out technical and scientific counter-arguments, soon finds himself the object of prosecution for slander of the Jews, disparagement of the memory of persons deceased, hate-mongering, or incitement to hatred.<sup>140</sup> Since 1985 this is even considered an offense so grave that proceedings are brought directly by the Public Prosecutors’ Departments even without a prior report or complaint by someone considering himself slandered.<sup>141</sup> The only thing anyone will achieve by speaking out in court against the self-evident ‘truth’ will be to receive an all the more severe sentence for stubborn lying and lack of repentance, and his arguments will be ignored. This insurmountable and blindly dogmatic persecution of dissenting viewpoints hobbles any and all research deviating in content from the officially sanctioned view.<sup>142</sup> But let us take a look at some examples afforded by Israel and the

---

<sup>134</sup> H. Springer, *ibid.*, pp. 101, 112f.

<sup>135</sup> *Ibid.*, p. 119.

<sup>136</sup> L. Gruchmann, *VfZ* 16 (1968) pp. 385-389, here p. 386.

<sup>137</sup> “*Vertrag zur Regelung aus Krieg und Besatzung entstandener Fragen, 26. 5. 1952*”, *Bundesgesetzblatt (BGBl)* II (1955) pp. 405f.

<sup>138</sup> *E.g.*, A. Rückerl, *op. cit.* (note 34), pp. 130ff., 138f.

<sup>139</sup> The *Bundesgerichtshof* [German Federal Supreme Court] has confirmed the legality of such measures: Ref. 1 StR 193/93.

<sup>140</sup> §§130, 131, 185, 189 German Criminal Code.

<sup>141</sup> For the amendment of §194 Sect. 2 German Criminal Code, cf. *BGBl* I (1985) p. 965.

<sup>142</sup> Thus the opinion of some German historians as A. Plack, *Hitlers langer Schatten*, Langen Müller, Munich 1993, pp. 308ff.; H. Diwald, *Deutschland einig Vaterland*, Ullstein, Frankfurt/Main 1990, p. 70; E. Nolte, *Streitpunkte*, Propyläen, Berlin 1993, p. 308; J. Hoffmann, *Stalin’s War of Extermination 1941 – 1945*, Theses & Dissertations

Federal Republic of Germany, to see in what sort of setting the trials of supposed violent National Socialist criminals took and continues to take place in countries calling themselves modern western-styled democracies under the rule of law.

### 3.3.2.1. The Investigations

The dubious starting point of many investigations – whether shortly after the war, or sometimes even today – are conclusions that were drawn in the course of Allied post-war trials, in judicial opinions, in witness statements, confessions of perpetrators, or other documents at the disposal of the investigating bodies.<sup>143ff.</sup> It is also cause for concern to consider how the rules of procedure were circumvented in order to facilitate the prosecution of Germans who were merely *suspected* of having committed crimes. Until 1951, the German justice system was permitted by the laws of the Allied Control Council to deal only with crimes committed by Germans against other Germans or stateless persons.<sup>146</sup> But even after partial sovereignty had been attained in 1955, certain circles were not satisfied with the scope of the German justice system's investigative activities and results. Ruckerl explains this dissatisfying condition with the fact that under existing laws, Public Prosecutors' Offices can take action only when a supposed criminal is resident in their region or when the crime was committed in their sphere of responsibility. Since the putative National Socialist crimes are predominantly said to have been committed abroad and frequently by person or persons unknown, there was no investigation at all in many cases.<sup>147</sup>

In 1958, in order to get around this obstacle, the Ministers of Justice of the Federal German states established the *Zentrale Stelle der Landesjustizverwaltungen zur Aufklärung nationalsozialistischer Verbrechen* [State Administration of Justice, Central Office for Investigation of National Socialist Crimes] in Ludwigsburg, to circumvent the above regulations and conduct worldwide researches in the form of preliminary investigations to determine where which crimes might have been committed in the name of Germany, and by whom – an act that is unique in the history of law and justice.<sup>148</sup> To this day this Central Office continues to draw on all possible sources (archives, witness statements, court documents, books, accounts of personal experience, movies, press releases) to obtain information on crimes supposedly committed abroad by Germans under the National Socialist regime. When the Central Office believes that sufficient evidence has been found against certain suspects, it passes its findings on to the appropriate Public Prosecutors' Offices which then proceed to initiate the standard investigations.

After refusing for years to examine and make use of the archives of the Eastern Bloc,<sup>149</sup> the Federal German government finally overcame its reluctance in the wake of the 1964 Auschwitz Trial, and appealed to all nations of the world to make as much documentation about National Socialist crimes available to Germany as possible. Some parties even demanded that a European Legal

---

Press, Capshaw, AL, 2001, p. 24: “*In contrast to the spirit and letter of “freedom of research” as proclaimed under the German Basic Law, it is, unfortunately, advisable today to have many passages of a historiographical text revised for ‘criminal content’ prior to publication—an almost disgraceful situation.*”

<sup>143</sup> Cf. A. Ruckerl, *NS-Prozesse*, *op. cit.* (note 131), pp. 83f., 88.

<sup>144</sup> A. Ruckerl, *Nationalsozialistische Vernichtungslager im Spiegel deutscher Strafprozesse*, dtv, Munich 1978, pp. 39f., 43ff., regarding Treblinka Trial cf. pp. 43ff., regarding Chelumno cf. p. 243.

<sup>145</sup> Regarding the Auschwitz Trial: B. Naumann, *Auschwitz*, Athenäum, Frankfurt/Main 1968, pp. 67f., 132.

<sup>146</sup> A. Ruckerl, *op. cit.* (note 34), p. 107f., 124. For the scope of these trials and the problems involved, cf. M. Broszat, *VfZ* 29 (1981) pp. 477-544.

<sup>147</sup> A. Ruckerl, *op. cit.* (note 34), p. 128.

<sup>148</sup> E. Schüle, *VfZ* 9 (1962) pp. 440-443; A. Ruckerl, *op. cit.* (note 34), pp. 142ff.

<sup>149</sup> As late as 1962, when the German Democratic Republic (East Germany) made its general offer to provide incriminating evidence regarding National Socialist criminals, the Federal Republic (West Germany) decried this as a propagandist campaign intended to discredit the Federal Republic. A. Ruckerl, *op. cit.* (note 34), p. 159.



Commission should be set up expressly and exclusively to prosecute supposed National Socialist criminals.<sup>150</sup> This appeal by West Germany caused East Germany, for example, to declare that it had sufficient incriminating material in its archives to prosecute hundreds of thousands.<sup>151</sup> Aside from these eastern European sources, the western archives (including especially those in Israel) as well as the standard Holocaust literature and inmates' organizations are the chief sources of the material collected by the Head Office.<sup>152</sup> S. Wiesenthal<sup>153</sup> and H. Langbein, a former inmate, have been particularly assiduous in providing material. The *Schwurgericht* [jury court] of Frankfurt even certified to the latter that he had played an especially important part in the preparations for the Auschwitz Trial and its execution,<sup>154</sup> and on the occasion of Langbein's presence at the examination of a witness the Public Prosecutor went so far as to thank him openly for his assistance.<sup>155</sup>

But what is of key importance is the fact that, as has been proven now in five separate cases, the Central Office or the Public Prosecutors' Offices compiled so-called Criminals' Dossiers which they made available to all potential witnesses, as well as to domestic and foreign investigative bodies, for the purpose of further dissemination to witnesses. In these Dossiers all supposed perpetrators are listed along with their photographs both of today and from National Socialist times, and a description of the crimes imputed to them – as well as such crimes which *may* have taken place but for which witnesses and clues to the identity of the perpetrators are still lacking. The witnesses are then asked to treat the issue as a matter of confidence but to assign the criminals to the crimes and to add other crimes which may be missing from the Dossier.<sup>156</sup> It is clear that under such circumstances the memory of these witnesses was 'refreshed', *i.e.*, distorted. Thus, subsequent testimonies and especially the identifications of the alleged perpetrators in court are a farce.<sup>157</sup> And finally, Ruckerl<sup>158</sup> and Henkys<sup>159</sup> report that due to new findings that had come to the attention of the investigating authorities, or due to discrepancies between witness testimony and the beliefs of the investigating authorities, the witnesses were questioned over and over again. It would not be surprising if this fact by itself already resulted in a sort of 'streamlining' of testimony. In this context Ruckerl points to cases of manipulation of witnesses by investigating authorities as well as by private rec-

<sup>150</sup> W. Maihofer, *Aus Politik und Zeitgeschichte* 15(12) (1965) pp. 3-14, here p. 14.

<sup>151</sup> A. Ruckerl, *op. cit.* (note 34), pp. 169f.

<sup>152</sup> A. Ruckerl, *ibid.*, p. 158; A. Ruckerl, *NS-Prozesse*, *op. cit.* (note 131), pp. 25, 43f., 57; A. Ruckerl, *op. cit.* (note 144), p. 44.

<sup>153</sup> Cf. his confessions regarding 'Nazi'-hunting in *Recht, nicht Rache*, Ullstein, Frankfurt/Main 1991.

<sup>154</sup> H. Langbein, *Der Auschwitz-Prozeß*, Europäische Verlagsanstalt, Frankfurt/Main 1965, v. 2, p. 858.

<sup>155</sup> H. Langbein, *ibid.*, v. 1, pp. 31f.; Langbein even searched for witnesses per newspaper ad: R. Hirsch, *Um die Endlösung*, Greifenverlag, Rudolstadt 1982, p. 122; cf. H. Langbein, *Menschen in Auschwitz*, Europa-Verlag, Vienna 1987, p. 554.

<sup>156</sup> Case 1 is the Sachsenhausen Trial. The entire witness dossier is available in copy form: letter of the Chief of the North Rhine-Westphalian Central Office for Investigation of National Socialist Mass Crimes in Concentration Camps, held by the Chief Public Prosecutor in Cologne, Dr. H. Gierlich, Ref. 24 AR 1/62 (Z); Case 2 is described without mention of the trial, by J. Rieger: Deutscher Rechtsschutzzkreis (ed.), *Zur Problematik der Prozesse um "Nationalsozialistische Gewaltverbrechen"*, Schriftenreihe zur Geschichte und Entwicklung des Rechts im politischen Bereich 3, Bochum 1982, p. 16; Case 3, regarding the Sobibor Trial, is described by F. J. Scheidl, *op. cit.* (note 77), v. 4, pp. 213f., based on *National Zeitung*, Sept. 30, 1960, pp. 3ff.; Case 4, regarding the Majdanek Trial, is set out in *Unabhängige Nachrichten*, 7 (1977) pp. 9f.; cf. W. Stäglich, *Die westdeutsche Justiz und die sogenannten NS-Gewaltverbrechen*, Deutscher Arbeitskreis Witten, Witten 1978, p. 14; W. Stäglich, *JHR* 3(2) (1981) pp. 249-281 (online: [vho.org/GB/Journals/JHR/2/3/Staeglich247-281.html](http://vho.org/GB/Journals/JHR/2/3/Staeglich247-281.html)); for Case 5, in the trial of G. Weise, see R. Gerhard (ed.), *Der Fall Gottfried Weise*, Türmer, Berg 1991, p. 63.

<sup>157</sup> Cf. the 'identification' farces enacted by witnesses, in B. Naumann, *op. cit.* (note 145), pp. 151, 168, 176, 471; F. J. Scheidl, *op. cit.* (note 77), v. 4, pp. 164, 213; H. Lichtenstein, *Majdanek. Reportage eines Prozesses*, Europäische Verlagsanstalt, Frankfurt/Main 1979, pp. 68, 82.

<sup>158</sup> A. Ruckerl, *NS-Prozesse*, *op. cit.* (note 131), p. 88.

<sup>159</sup> R. Henkys, *op. cit.* (note 9), pp. 210ff.; cf. also B. Naumann, *op. cit.* (note 145), p. 69.

ords centers – while of course considering these cases to be exceptions to the rule.<sup>160</sup> The frequently very difficult investigations resulted in the accused persons being detained, awaiting trial, for three to five years and sometimes even longer, which can contribute to the emotional attrition of the accused and which the European Court is not alone in condemning as a violation of human rights.<sup>161</sup>

It must be noted that both Rückerl<sup>162</sup> and Henkys<sup>163</sup> considered it a necessity that politically particularly reliable personnel were employed for the first few decades of these special investigations, since many employees and officials might have been biased due to their own activities during National Socialist times. It is safe to assume that only such persons were employed as had never even dreamed of doubting the reality of the alleged crimes to be investigated. Given such eager, ideologically persuaded and trained personnel, it is quite within the realm of the possible that witnesses who were reluctant to testify were threatened in the course of preliminary investigations in order to obtain the desired testimony. Lichtenstein describes the results of a second-degree interrogation, which he expressly states is necessary in order to force reluctant witnesses to talk:

*“The witness [Barth<sup>164</sup>] hesitates, [...] suffers or fakes a nervous breakdown. [...] Before leaving the witness stand he takes back his claim that the police officer who had interrogated him had ‘blackmailed’ him into telling what had happened at that time. He now states rather lamely that the officer had ‘been rather tough with him’, which is certainly necessary with witnesses of this sort. [sic!]”<sup>165</sup>*

All in all, the Central Office seems to regard itself more as an institute for historical research operating with unconventional methods than as an office for criminal prosecution: Rückerl, in any case, considers its findings historical facts.<sup>166</sup> Steinbach even suggests that in the future, after the end of the NSG trials, the Central Office ought to be turned into an institute for historical research,<sup>167</sup> which apparently is the plan of German politicians, too.<sup>168</sup>

An interview with a former SS-man, however, revealed that probably not even this task of historical research is performed properly. According to this interview it seems that the members of the Central Office *never* try to find out what really happened, but are only interested in information about crimes and alleged criminals.<sup>169</sup> This procedure must inflate the crimes and can only hide the truth.

### 3.3.2.2. Judges and Prosecuting Attorneys

For the alleged major crime categories of the Third Reich (*Einsatzgruppen*, concentration camps and other camps), the trials of individual persons were supplemented by a mammoth trial conducted at a central location, to which dozens of accused and sometimes hundreds of witnesses were summoned.<sup>170</sup> Although this was a financial and technical necessity, it was nevertheless inevitable that

<sup>160</sup> A. Rückerl, *op. cit.* (note 34), p. 256.

<sup>161</sup> For ex., cf. the time spent awaiting trial in the Auschwitz Trial, Frankfurt, in B. Naumann, *op. cit.* (note 145), pp. 15f.; regarding the decision of the European Court: J. G. Burg, *NS-Prozesse des schlechten Gewissens*, G. Fischer, Munich 1968, p. 187; cf. also R. Henkys, *op. cit.* (note 9), p. 265.

<sup>162</sup> A. Rückerl, *op. cit.* (note 34), pp. 163f.

<sup>163</sup> R. Henkys, *op. cit.* (note 9), p. 210.

<sup>164</sup> H. Barth was convicted in an East German show trial in 1983 for his participation in the events in Lidice and Oradour-sur-Glane; cf. H. Lichtenstein, *op. cit.* (note 88).

<sup>165</sup> H. Lichtenstein, *op. cit.* (note 157), p. 52, cf. also p. 55.

<sup>166</sup> A. Rückerl, *op. cit.* (note 144), p. 33.

<sup>167</sup> J. Weber, P. Steinbach (eds.), *op. cit.* (note 15), pp. 35f., 207.

<sup>168</sup> “In Ludwigsburg werden weiter Nazi-Verbrechen aufgeklärt”, *Frankfurter Allgemeine Zeitung (FAZ)*, June 14, 1997, p. 5.

<sup>169</sup> G. Rudolf, “Auschwitz-Kronzeuge Dr. Hans Münch im Gespräch”, *op. cit.* (note 17).

<sup>170</sup> Cf. A. Rückerl, *op. cit.* (note 34), pp. 263ff. In the Auschwitz Trial, for ex., there were 23 defendants and more than 350 witnesses: cf. H. Laternser, *Die andere Seite im Auschwitzprozess 1963/65*, Seewald, Stuttgart 1966, pp. 13, 23.

the question of the individual guilt of each defendant would perforce be drowned out. In the face of such a deluge of evidence and information, neither the defense nor the prosecution, neither judge nor jury can keep track of everything for years on end.<sup>171</sup>

Even though there has been much emphasis on the point that it cannot be the task of the Court to dabble in historiography, R ckerl stresses that particularly the trials concerned with the alleged National Socialist extermination camps are of historical relevance and that the elucidation of historical events frequently took center-stage in those trials.<sup>172</sup> No secret is made of the fact that the ‘historical’ findings of these investigations make up the chief pillars on which contemporary historiography has based its research.<sup>173</sup> Steinbach even states that it is unique in the history of historiography for this area of inquiry to have been left up to non-historians, *i.e.*, prosecuting attorneys and judges, and that this chapter is therefore the best-researched in German history.<sup>174</sup>

And indeed the courts are superior to historians in one respect, namely in the obtainment of witness testimony. R ckerl notes correctly that unlike historians, investigators and judges in criminal trials are able, thanks to the apparatus of state, to obtain a great many statements from witnesses and to probe them for the truth by means of questioning, *i.e.*, interrogation.<sup>175</sup> But whether these statements, on which such fateful decisions hinge, are true – this is something that is far more difficult to determine. Bader and Henkys suggest that this would be possible only if the Court were allowed to exert physical force, which is prohibited in a state under the rule of law.<sup>176</sup> It is rather amazing to find that in our times there actually are German adults who believe that force can ascertain the truth. Tuchel limits the historical usability of legal findings to those that are based on good and complete legal research.<sup>177</sup> But *who* assesses quality and completeness, and by which criteria?

The most prominent example of the NSG trials is the Auschwitz Trial in Frankfurt. Contrary to the claims of the then Presiding Judge, this trial is generally regarded as the epitome of historical trials.<sup>178</sup> Thus it is not surprising that the only expert reports which the Court commissioned to elucidate the issue were historical reports about the National Socialist regime in general and about the persecution of the Jews in particular,<sup>179</sup> but no criminological reports about the evidence for the supposed and alleged deeds of the defendants.<sup>180</sup> How two-faced, therefore, of the Federal Supreme Court to have quashed the acquittal resulting from one particular NSG trial – giving for its decision the reason that the Court allegedly had done nothing to determine whether the crime had even taken place!<sup>181</sup> But this is precisely what the courts entrusted with the NSG trials *never* do in the only reli-

<sup>171</sup> H. Laternser, *ibid.*, pp. 12f., 143ff.

<sup>172</sup> A. R ckerl, *op. cit.* (note 144), pp. 7, 17ff., 22ff., 90ff., 254ff.; also R. M. W. Kempner in R. Vogel (ed.), *Ein Weg aus der Vergangenheit*, Ullstein, Frankfurt/Main 1969, p. 216; also in H. Lichtenstein, *op. cit.* (note 88), p. 7.

<sup>173</sup> A. R ckerl, *op. cit.* (note 34), pp. 260f., 324; cf. also M. Broszat’s preface in A. R ckerl, *op. cit.* (note 144); also H. Langbein, *op. cit.* (note 154), v. 1, p. 12; cf. W. Scheffler, in J. Weber, P. Steinbach (eds.), *op. cit.* (note 15), pp. 123ff.

<sup>174</sup> P. Steinbach in J. Weber, P. Steinbach (eds.), *ibid.*, pp. 25, 35.

<sup>175</sup> A. R ckerl, in J. Weber, P. Steinbach (eds.), *ibid.*, p. 72.

<sup>176</sup> K. S. Bader, in K. Forster (ed.), *M glichkeiten und Grenzen f r die Bewltigung historischer und politischer Schuld in Strafprozessen*, Studien und Berichte der katholischen Akademie in Bayern, no. 19, Echter-Verlag, W rzburg 1962, p. 126; quoted in R. Henkys, *op. cit.* (note 9), p. 220.

<sup>177</sup> J. Tuchel, in J. Weber, P. Steinbach (eds.), *op. cit.* (note 15), p. 143.

<sup>178</sup> A. R ckerl, *op. cit.* (note 144), p. 18; B. Naumann, *op. cit.* (note 145), p. 7.

<sup>179</sup> Regarding the Auschwitz Trial, cf. H. Laternser, *op. cit.* (note 170), pp. 82f. For these historical expert reports, see H. Buchheim, M. Broszat, H.-A. Jacobsen, H. Krausnick, *Anatomie des SS-Staates*, 2 vols., Walter Verlag, Freiburg 1964; regarding Sobibor: A. R ckerl, *op. cit.* (note 144), pp. 87, 90ff.; regarding Treblinka: *ibid.*, p. 82; regarding Majdanek: H. Lichtenstein, *op. cit.* (note 157), p. 30.

<sup>180</sup> The Frankfurt *Schwurgericht* [jury court] admits this frankly in its Reasons for Sentence, cf. R ter, *op. cit.* (note 3); A. R ckerl, *op. cit.* (note 34), pp. 214f., claims that aside from visits to the sites of the crimes only documentary and material evidence is used.

<sup>181</sup> H. Lichtenstein, *op. cit.* (note 88), p. 117f., on a verdict of the District Court of Bielefeld, Ref. Ks 45 Js 32/64,

able way available, namely non-historical, *i.e.*, technical, scientific, and forensic expert reports. Yet the Federal Supreme Court clearly is not bothered by this when the result is a conviction rather than an acquittal.

Another element for concern is the fact that in these large-scale, well-publicized NSG trials, both the prosecution and the witnesses produced a show-trial-style, graphic overall impression of the alleged horrors of the Holocaust.<sup>182</sup> This contributed nothing to the establishment of truth regarding the charges brought against the accused, instead it added to the Court bias against them. Rückerl explains that graphic presentation of the gruesome context within which the alleged crime was committed serves to increase the severity of the sentence.<sup>183</sup> Bader comments:

“Trials which are conducted in order to furnish evidence for historians are evil trials and represent a sinister approach to show-trials.”<sup>184</sup>

The Court’s value judgment of the evidence is also significant. Rückerl reports that it is practically impossible to find a suspect guilty on the sole basis of documentary evidence, so that especially with the increasing time span separating fact from trial it is almost always necessary to fall back on witness testimony even though its unreliable nature is clear, and particularly so in these NSG trials.<sup>185</sup> He states further that the conviction of an accused on the strength of the testimony of only one witness is questionable due to the possibility of error on the part of the witness, but that several witnesses, all giving incriminating testimony, would convince the Court.<sup>186</sup> This is reminiscent of the trial technique sometimes used in ancient times, where it was the number of witnesses rather than the quality of the evidence they gave that decided someone’s guilt or innocence.<sup>187</sup> It is a particular point for concern that the courts, due to their lack of proper evidence, are increasingly accepting hearsay testimony,<sup>188</sup> even though it is generally acknowledged that this type of evidence is worthless and that it is extremely dangerous to rely on it, since doing so practically *ensures* a miscarriage of justice.<sup>189</sup>

The external conditions surrounding such trials also violated the judicial standards of a state under the rule of law. For example, Laternser criticizes filming and photographing in the courtroom, which was (unlawfully) permitted during the Auschwitz Trial and resulted in the defendants being besieged much like lions in a zoo.<sup>190</sup> During their statements the defense or the defendants were subjected to insults and even threats from courtroom spectators without any intervention from the Court;<sup>191</sup> that the accused were subjected to insults from the prosecutors and witnesses and even to

---

regarding the evacuation of the Wladimir-Wolynsk ghetto. The Federal Supreme Court commented that even where several suspects as well as unrefuted exonerating defense evidence exist, the Court can still find the defendant guilty!

<sup>182</sup> H. Laternser, *op. cit.* (note 170), pp. 34f.; Rückerl considers this absolutely necessary: *NS-Prozesse, Op. cit.* (note 131), p. 32; P. Steinbach, in J. Weber, P. Steinbach (eds.), *op. cit.* (note 15), p. 26; in the Eichmann Trial in Jerusalem the corresponding witnesses were officially known as “*witnesses-of-Jewish-suffering*”: H. Arendt, *Eichmann in Jerusalem*, Reclam, Leipzig 1990, p. 335, cf. pp. 355ff.; cf. also F. J. Scheidl, *op. cit.* (note 77), v. 4, pp. 235ff.

<sup>183</sup> A. Rückerl, *op. cit.* (note 144), p. 328.

<sup>184</sup> K. S. Bader, *op. cit.* (note 176), p. 219.

<sup>185</sup> A. Rückerl, *op. cit.* (note 34), p. 249; *op. cit.* (note 144), p. 34; *NS-Prozesse, op. cit.* (note 131), pp. 27, 29, 31.

<sup>186</sup> A. Rückerl, *op. cit.* (note 34), p. 257; H. Lichtenstein, *op. cit.* (note 157), p. 49.

<sup>187</sup> Cf. Salzburg District Court judge Dr. F. Schmidbauer’s letter-to-the-editor in *Profil*, 17/91; the author thanks W. Lüftl for this reference.

<sup>188</sup> H. Laternser, *op. cit.* (note 170), pp. 29, 151f., 171.

<sup>189</sup> E. Schneider, *op. cit.* (note 4), p. 189; R. Bender, S. Röder, A. Nack, *op. cit.* (note 6), v. 2, pp. 178ff. Unfortunately, unlike under Anglo-Saxon law, hearsay evidence is admissible in German courts!

<sup>190</sup> H. Laternser, *op. cit.* (note 170), p. 39; B. Naumann, *op. cit.* (note 145), p. 141; cf. H. Lichtenstein, *op. cit.* (note 157), p. 29.

<sup>191</sup> H. Laternser, *op. cit.* (note 170), pp. 15, 30f., 80.

disparagement by the judges;<sup>192</sup> that the prosecution participated in an exhibit held in the *Paulskirche* [Church of St. Paul, an important national memorial of Germany] during the trial and at which the accused were ‘convicted’, complete with their photos, life history and details of their alleged crimes.<sup>193</sup>

Prosecutor Helge Grabitz reports that in the face of the horrible events described by the witnesses it was next to impossible for judges and prosecutors alike to remain objective and that they sometimes even declared themselves to be biased since they felt rage, shame or despair.<sup>194</sup> This bias – or “*interest*”, as it is called – became particularly evident when the Jury Court of Frankfurt in charge with the Auschwitz case visited the site of the alleged crime. Grabitz comments:

“*When the trial moves out of the courtroom and to the site of the crime, a profound sense of consternation predominates.*”<sup>195</sup>

This is vividly reminiscent of those Auschwitz pilgrims who shuffle through the camp with heads bowed, who pray before a *hot-air delousing* chamber, in which the prisoners’ clothes were fumigated, in memory of the victims they, albeit mistakenly, believe to have been murdered therein. To truly honor the dead, a cursory attempt to find out to which use these buildings and facilities were really put should be done. Instead of explaining the true purpose for *all* buildings and camp centers by the experts, the courts used these opportunities only in order to increase their dismay.

If Laternser is correct, then it is also a point for concern that the prosecution in the Auschwitz Trial failed to comply with its duty (§160 of the Code of Criminal Procedure) to also search for evidence that would exonerate the accused.<sup>196</sup> Chief prosecutor Grabitz’s comment regarding the responsibility of the prosecution in cases where a defendant plays down or denies the crimes he is charged with is rather revealing in this instance:

“*It is the task of the prosecution to refute these claims of the accused by bringing convincing evidence, especially eyewitness testimony.*”<sup>197</sup>

Despite claims to the contrary, most of the prosecutors were indeed concerned solely with incriminating the accused. Thus, these trials came to be more and more like Anglo-Saxon trials, in which the prosecution concerns itself only with proving guilt, and not with attempting to establish innocence.

The means available to investigative authorities (described in Section 3.3.2.1.) to conduct investigative proceedings against future accused for many years and with the support of several hundreds of experts, all the governments in question, and any and all archives they may need,<sup>198</sup> result in an inequality of resources between prosecution and defense that is similar in scope to that characterizing the Allied post-war trials. Arendt ascertained this inequality of resources, analogous to the IMT, for the Eichmann Trial in Jerusalem.<sup>199</sup>

Once someone accused of NSG crimes has been convicted, he has next to no chance to prove his innocence through an appeal or a retrial. Whereas retrials were not uncommon shortly after the war, they are almost always refused today.<sup>200</sup> Oppitz suggests that the reason for this is that courts today

---

<sup>192</sup> H. Laternser, *ibid.*, pp. 29, 35f., 52f., 56f., 59, 154f.; B. Naumann, *op. cit.* (note 145), p. 62, 135, 266, 270, 281, 383.

<sup>193</sup> H. Laternser, *op. cit.* (note 170), pp. 94ff., 417ff.; B. Naumann, *op. cit.* (note 145), p. 383.

<sup>194</sup> H. Grabitz, *NS-Prozesse – Psychogramme der Beteiligten*, C. F. Müller, Heidelberg 1986, p. 11; cf. also H. Grabitz, *Zeitgeschichte* (Vienna), 14 (1986/87) pp. 244-258.

<sup>195</sup> H. Grabitz, *NS-Prozesse ...*, *op. cit.* (note 194), p. 18, cf. pp. 149ff.

<sup>196</sup> H. Laternser, *op. cit.* (note 170), p. 32; A. Rückerl, *op. cit.* (note 34), p. 249, disagrees.

<sup>197</sup> H. Grabitz, in J. Weber, P. Steinbach (eds.), *op. cit.* (note 15), p. 86.

<sup>198</sup> A. Rückerl, *op. cit.* (note 34), pp. 242f., 262f.

<sup>199</sup> H. Arendt, *op. cit.* (note 182), pp. 352f.

<sup>200</sup> U.-D. Oppitz, *Strafverfahren und Strafvollstreckung bei NS-Gewaltverbrechen*, pub. by auth., Ulm 1979, pp. 63ff., 327ff.

regard eyewitness testimony in a much more critical light than they did right after the war, which means that miscarriages of justice have become far less likely.<sup>201</sup> We shall see to which extent this is in fact so.

### 3.3.2.3. Defense Counsels

Trial reports written by defense counsels in NSG trials are few and far between, since those few counsels who are willing to assume the defense in such trials tend to be more than fed up with the trouble they incur through their involvement with the trial *per se*. As a rule they therefore avoid the further trouble that would be theirs in the event of a publication. Also, for a self-employed lawyer it is very difficult to come up with the time and money necessary to write a book, not to mention that it is next to impossible to find a publisher for such a book. H. Laternser, who was himself convinced that the Holocaust story is fundamentally correct,<sup>202</sup> is the only attorney to date to publish a detailed account of this kind. Since the trial in question drew a great deal of public interest, it was even possible to find an establishment publisher for the book. Laternser's expositions also hold true more or less for all other NSG trials, whose general conditions have been discussed in less mainstream publications.<sup>203</sup> Laternser, who already served as defense counsel during the IMT trials, describes the atmosphere pervading the Auschwitz Trial in Frankfurt as follows:

*“In the major international criminal trials in which I participated, there was never as much tension as in the Auschwitz Trial – not even at the International Military Tribunal in Nuremberg.”*<sup>204</sup>

One point of criticism of this trial which he cites from the perspective of the defense is that hardly any prosecutors and members of the press were present during the summation of the defense. In other words, there was no interest in a balanced view of the matter.<sup>205</sup> He further criticizes that the defense was severely restricted in its questioning of witnesses and that their motions to hear evidence were suppressed, not granted, or refused without reason.<sup>206</sup> The defense was also not granted access to the audio-taped records of witness testimony.<sup>207</sup> Reviewing and summarizing the many eyewitness statements was thus quite impossible for the defense. The fact that even this judicial straitjacket was not tight enough for some is revealed by Ruckerl, who complains that the trials took too long, allegedly because of the ever-increasing deluge of evidence introduced by the defense,<sup>208</sup> and Lichtenstein claims, in the same vein, that the defense did not have sufficient restrictions put on it.<sup>209</sup>

A telling factor was the reaction of the Court and the public in the case where an attorney dared approach the witnesses whom the prosecution authorities had located, and questioned these witnesses prior to the trial without identifying himself as defense counsel. In Court it later turned out that the statements of these witnesses, which had been inconsistent and contradictory before the trial, were now brought into mutual accord and had been purged of their most unbelievable elements.<sup>210</sup>

<sup>201</sup> U.-D. Oppitz, *ibid.*, pp. 230ff.

<sup>202</sup> H. Laternser, *op. cit.* (note 170), pp. 12f.

<sup>203</sup> Cf. H. Laternser, *ibid.*, also, e.g., E. Kern, *Meineid gegen Deutschland*, Schütz, Preussisch Oldendorf 1971; F. J. Scheidl, *op. cit.* (note 77), esp. v. 4, pp. 198ff.

<sup>204</sup> H. Laternser, *op. cit.* (note 170), p. 28, cf. also p. 32.

<sup>205</sup> *Ibid.*, p. 57.

<sup>206</sup> *Ibid.*, pp. 37, 40f., 46ff., 61, 112, 117 etc.

<sup>207</sup> *Ibid.*, pp. 46ff., 146f.

<sup>208</sup> A. Ruckerl, *NS-Prozesse*, *op. cit.* (note 131), p. 270.

<sup>209</sup> H. Lichtenstein, *op. cit.* (note 157), p. 113, quoting the *Frankfurter Allgemeine Zeitung* of March 31, 1979.

<sup>210</sup> Deutscher Rechtsschutzkreis, *op. cit.* (note 156), pp. 15f., re attorney Ludwig Bock

The public condemned the attorney in question for his investigations, and the chief witness nations, Poland and Israel, banned him from entering their respective countries in the future.<sup>211</sup>

It is further food for thought that defense attorneys in NSG trials are exposed to public attacks which at times go as far as physical assault and professional disciplinary hearings or even criminal prosecution, *should they ask for or try to present evidence that challenges the self-evidentness of the Holocaust.*<sup>212</sup>

Thus it is not surprising that many defense counsels, appointed to the case by the Court, take themselves to their task with great reluctance originating with ideological reservations or with fear of harm to their reputation, and prefer to cooperate with the judge or even with the prosecution rather than represent their clients effectively, and even consider resigning their appointment under the pressure of media campaigns.<sup>213</sup> This resulted in the failure of any joint strategy on the part of the various defense attorneys, who instead even turned on each other at times.<sup>214</sup> In one case it has been proven that this went so far as to prompt one such appointed defense attorney to advise his client to try to obtain leniency from the Court by making false confessions of guilt, which the defendant did in fact proceed to do.<sup>215</sup> Similar strategies are recommended to the defense by third parties, as the defendants' insistence on their innocence, which no one is willing to believe, seems pathetic and cowardly to the public.<sup>216</sup>

In reading Laternser's trial documentation one notices that he never comments critically on the fact that no material evidence was ever brought with regard to victims, murder weapons or the site of the crime, and that eyewitness testimony was also not subjected to any expert critical analysis. In this respect Laternser follows in the traditional footsteps of other defense counsels of the IMT and the Federal German trials, none of whom harbored any doubts as to the factuality of the various Holocaust stories until just recently. It thus never so much as occurred to them to demand proof of the crime prior to negotiations about the guilt of the accused, as is the standard course of procedure in any court case relating to normal murders and even to trivialities such as traffic accidents. Laternser also fails to critically address the practice of keeping the accused in custody for many years, sometimes for more than five years in detention awaiting trial, thus subjecting them to psychological attrition that persuades almost any accused person to cooperate with the Court and the prosecution to some extent if only doing so will serve to make his own fate more bearable.

And finally, as an aside it should be noted that Eichmann's defense counsel was not permitted to speak with his client privately, and that he was not granted access to the transcripts of Eichmann's interrogations<sup>217</sup> – once again, methods reminiscent of the International Military Tribunal.

---

<sup>211</sup> *Ibid.*, pp. 15f.; also H. Lichtenstein, *op. cit.* (note 157), p. 89; H. Grabitz, *NS-Prozesse...*, *op. cit.* (note 194), p. 15.

<sup>212</sup> H. Lichtenstein, *op. cit.* (note 157), pp. 70f., 89, 97f. regarding attorney L. Bock; in 1999, Attorney at Law Ludwig Bock was sentenced to pay DM 10,000 (\$5,000), because in a trial against the Revisionist Günter Deckert (see G. Anntohn, H. Roques, *Der Fall Günter Deckert*, DAGD/Germania Verlag, Weinheim 1995; online: [vho.org/D/Deckert](http://vho.org/D/Deckert)), he dared to ask for the 'wrong' evidence, cf. Rudi Zornig, *VffG* 3(2) (1999), p. 208 (online: [vho.org/VffG/1999/2/Zornig208.html](http://vho.org/VffG/1999/2/Zornig208.html)); in 2002, Attorney at Law Jürgen Rieger was sentenced for "stirring up the people" for having asked a Hamburg Court to hear expert witness Germar Rudolf, this author, on the gas chambers of Auschwitz; German Federal Supreme Court, ref. 5 StR 485/01, *Neue Juristische Wochenschrift* 2002, p. 2115, *Neue Strafrechts-Zeitung* 2002, p. 539

<sup>213</sup> B. Naumann, *op. cit.* (note 145), p. 383.

<sup>214</sup> H. Laternser, *op. cit.* (note 170), pp. 76ff.; H. Lichtenstein, *op. cit.* (note 157), pp. 86, 99.

<sup>215</sup> H. Laternser, *op. cit.* (note 170), p. 81.

<sup>216</sup> E.g., E. Bonhoeffer, *Zeugen im Auschwitz-Prozeß*, Kiefel, Wuppertal 1965, pp. 52f.

<sup>217</sup> F. J. Scheidl, *op. cit.* (note 77), v. 4, pp. 239f.

### 3.3.2.4. Witnesses

#### 3.3.2.4.1. Witnesses for the Prosecution

Rückerl, Henkys and Langbein<sup>218</sup> are well aware that eyewitness testimony is unreliable not only due to the natural forgetting process and to bias, but also because things heard or seen in the reports of third parties or in the media frequently become internalized and regarded as personal experiences. It is almost impossible for courts to differentiate between personal and second-hand experiences in eyewitness testimony.

On the one hand, Rückerl and Henkys<sup>218</sup> write that the misery of camp life dulled the inmates' ability to absorb the events around them, which explains faulty testimony and makes it not only excusable, but in fact even more credible than it would otherwise have been.<sup>219</sup> On the other hand they suggest that particularly horrible and thus indelibly impressive events may be retained unchanged in an inmate's memory like a photograph for 30 years and more, thus making highly detailed eyewitness testimony credible.<sup>220</sup> Even if this theory should be correct, the question remains: how is a court to differentiate between photographically precise memories and testimony that has been unconsciously warped by time and external influences?

Elisabeth Loftus takes the opposite position, *particularly* in the context of Holocaust witnesses: of all the categories of witnesses, she says, these are the most unbelievable, due to the world-wide media exploitation and the emotionally highly charged mood characterizing the topic of the Holocaust.<sup>221</sup> Admittedly, she has held this view only since attending the Demjanjuk Trial in Jerusalem, where the scales fell from her eyes. In the end, this trial produced a verdict of not guilty, since the unreliable nature of *all* the witnesses for the prosecution had become too apparent<sup>222</sup> – and this included witnesses who had given similar testimony two decades earlier in two Treblinka trials in Germany, where they had been deemed credible and had helped to decide the outcomes of these trials.<sup>223</sup>

In many German trials experts on the credibility of witnesses had concluded that, on the whole, said credibility was intact even after 30 years, at least where the heart of the testimony was concerned. Oppitz believes that in the future, motions to examine credibility should be refused on grounds of self-evidence.<sup>224</sup> Since Rückerl feels that only vagueness and inconsistency are the hallmarks of quality in eyewitness testimony,<sup>225</sup> it is not surprising that there is a general tendency to demand that the scrutiny of incriminating eyewitness testimony pertaining to the Holocaust be condemned as reprehensible practice.<sup>226</sup> It has also been noted that in the face of the paralyzing horror

<sup>218</sup> A. Rückerl, *NS-Prozesse*, *op. cit.* (note 131), pp. 26f.; *op. cit.* (note 144), pp. 88f.; *op. cit.* (note 34), pp. 251ff.; R. Henkys, *op. cit.* (note 9), pp. 209f.; H. Langbein, *Menschen in Auschwitz*, *op. cit.* (note 155), pp. 334ff., 544f.

<sup>219</sup> R. Bender, S. Röder, A. Nack, *op. cit.* (note 6), v. 1, pp. 146ff., comment rightly that an overly detailed account is perforce unbelievable, since no witness can remember everything in precise detail, least of all after such a long time.

<sup>220</sup> On the one hand, H. Lichtenstein is practically in raves about the marvellous memory of the witnesses for the prosecution: *op. cit.* (note 157), p. 64f., 78, but on the other hand he considers contradictions in eyewitness testimony to be quite understandable, p. 75.

<sup>221</sup> E. Loftus, *op. cit.* (note 22); H. Grabitz, *NS-Prozesse...*, *op. cit.* (note 194), pp. 64, 67, also recognizes the problem that results from the Jewish witnesses' role as victims.

<sup>222</sup> Cf. A. Neumaier's chapter, this volume.

<sup>223</sup> Cf. H. Lichtenstein, *op. cit.* (note 88), pp. 196ff.

<sup>224</sup> U.-D. Oppitz, *op. cit.* (note 200), p. 352.

<sup>225</sup> A. Rückerl, *op. cit.* (note 34), p. 253; also the Court in the trial of G. Weise: R. Gerhard (ed.), *op. cit.* (note 156), pp. 56, 59, 65, 75.

<sup>226</sup> A. Rückerl, *op. cit.* (note 34), pp. 253f., 257f., is very understanding of this bias; H. Arendt, *op. cit.* (note 182), pp. 338f., considers it an inhumane practice to question the veracity of the Holocaust witnesses, but deems it necessary and just to consider the accused guilty from the start – a thoroughly 'normal' attitude among our contemporaries; cf. H. Lichtenstein, *op. cit.* (note 157), pp. 75, 99, 104; H. Lichtenstein, *op. cit.* (note 88), p. 120; I. Müller-Münch, *Die*



which witnesses for the prosecution bring to vivid life in the courtroom, the Courts themselves appear to lose all their critical faculties where this testimony is concerned, and are prepared to regard the witnesses strictly as innocent, guileless and defenseless victims, even in the courtroom,<sup>227</sup> and there are even those who deem such stunned horror on the part of the Court and the public to be a necessity without which the suffering of the victims cannot be properly appreciated.<sup>228</sup> Grabitz explains that where “*victim witnesses*” are concerned, one must be especially empathic, understanding, and restrained in one’s questions,<sup>229</sup> a sentiment which culminates in her comment:

“*As a human being one simply wants to take this witness into one’s arms and to weep with him.*”<sup>230</sup>

But it did not take the Demjanjuk show trial to show that some of these witnesses are up to no good. Oppitz<sup>231</sup> demonstrated with a number of examples that even in the German courts there are both professional and vengeful witnesses which, however, are only rarely condemned for perjury, or which – as one may well suppose, in light of the German Courts’ uncritical and credulous attitude towards Holocaust witnesses for the prosecution – were not even recognized as perjurers. Particularly dramatic cases include those where the defendants are accused by witnesses of having murdered certain persons who later turn out to be still alive, to never have existed in first place, or to have died long before the time of the NS regime.<sup>232</sup>

With reference to the Auschwitz Trial, Laternser reports something that goes for all NSG trials on the whole: foreign witnesses departed again immediately after testifying, making it impossible to call them to account later when it turned out that they had committed perjury. Neither the judges nor the prosecutors took any steps to examine or test the statements of witnesses for the prosecution. Any and all attempts by the defense to do so were “*nipped in the bud*”,<sup>233</sup> since it would be wrong to persecute the victims of yesterday all over again today.<sup>234</sup> Lichtenstein gives an outraged account of one exceptional case where the prosecution as well as the Court condemned the eyewitness statements as fairy-tales.<sup>235</sup>

Grabitz distinguishes between three categories of Jewish witnesses:<sup>236</sup>

- a) *Objective, matter-of-fact witnesses.* According to Grabitz these stand out for their detailed testimony regarding the character and conduct of those participating in the crime/s. Further, they often cite the memory of the sacrifices of their family or their people as their reason for feeling obliged to testify. What Grabitz fails to see here is that even an apparently unemotional, discriminating statement need not be true, and that the remembrance of the sacrifices of family and coreligionists is by no means a motivation inherently proof against a desire for vengeance.
- b) *Jewish witnesses striving for objectivity and matter-of-factness.* Grabitz includes in this category those witnesses whose dreadful experiences make it difficult for them to maintain their composure; characteristics include crying fits and nervous breakdowns, but also bursts of invective expressed during or after testimony. In other words, Grabitz excuses the at times unobjective ac-

*Frauen von Majdanek*, Rowohlt, Reinbek 1982, p. 156; E. Bonhoeffer, *op. cit.* (note 216), pp. 22f.

<sup>227</sup> The Majdanek Trial is a typical example of this; cf. I. Müller-Münch, *op. cit.* (note 226), p. 142; also B. Naumann, *op. cit.* (note 145), p. 281.

<sup>228</sup> H. Lichtenstein, *op. cit.* (note 157), p. 127.

<sup>229</sup> H. Grabitz, *NS-Prozesse...*, *op. cit.* (note 194), pp. 12ff., 78, 87.

<sup>230</sup> H. Grabitz, *ibid.*, p. 12.

<sup>231</sup> U.-D. Oppitz, *op. cit.* (note 200), pp. 113, 239ff., 258, 350f.

<sup>232</sup> Cf. F. J. Scheidl’s accounts of this: *op. cit.* (note 77), v. 4, pp. 198ff.; also Deutscher Rechtsschutzzkreis, *op. cit.* (note 156).

<sup>233</sup> H. Laternser, *op. cit.* (note 170), pp. 37f., 57f., 85, 157.

<sup>234</sup> Claimed in another trial, cf. Deutscher Rechtsschutzzkreis (ed.), *op. cit.* (note 156), p. 19.

<sup>235</sup> H. Lichtenstein, *op. cit.* (note 88), p. 113ff., 120.

<sup>236</sup> H. Grabitz, *NS-Prozesse...*, *op. cit.* (note 194), pp. 64-90.

counts of those witnesses on the grounds of the awful nature of their experiences. But what if the awful experiences attested to are not true? How is one to examine such testimony if the sympathy that the testimony inspires for these witnesses prohibits any questioning of their statements?

- c) *Witnesses characterized by hatred.* According to Grabitz these project injustices they suffered onto innocent persons because they can no longer incriminate the actual guilty party, or magnify the guilt of someone present at the crime or injustice. By now it has been shown time and again that these “*hate witnesses*” are capable of the total fabrication of the crimes they allege, but this fact does not occur to Grabitz.

Public prosecutor Grabitz is probably in accord with most prosecutors, and with judges as well, when she states that her witness categories are a) credible, and thus not to be cross-examined, b) unreliable in parts, but also not to be cross-examined due to the witnesses’ horrible experiences (which of course cannot but be true), and c) factually correct, but distorted with respect to the perpetrators. In other words, she sees no reason whatsoever to doubt the credibility of Jewish witnesses –

“[...of] *these witnesses, who want to testify in order to bring the truth to light – why else would they have voluntarily come from abroad [...].*”<sup>237</sup>

The height of naïveté, surely, by this prosecutor allegedly *seeking* truth!

The free rein that as a rule was granted the witnesses for the prosecution, and frequently not even restricted by the defense counsels,<sup>238</sup> no doubt did not contribute to the veracity of these witnesses. What makes matters worse is that in German criminal proceedings the taking of verbatim transcripts is not required, meaning that the Court does not record eyewitness testimony exactly as it is given, neither in written form nor taped.<sup>239</sup> Until the end of the seventies the German Courts rather took a protocol of results, in which only the essential results of the trial were summarized. Accounts of witnesses as well as statements of defendants, lawyers and judges therefore cannot be reconstructed precisely if later evidence produces contradictions. At the end of the seventies even the duty to prepare a protocol of results was lifted for all higher Courts (District and Provincial High Courts). They only prepare pro forma protocols since. Regarding the statements of defendants and witnesses one can read therein only something like: “*The witness made statements about the matter*”, or: “*The defendant filed a declaration*”. Nothing occurs in those protocols about the content of the statements and declarations. Since trials against alleged NSG criminals are being held in higher instances right from their start because of the gravity of the alleged crime (which denies the defendants a second instance with a hearing of evidences), this leads to a situation where the Courts have absolutely free hand regarding the ‘interpretation’ of the statements of witnesses and defendants. This situation throws the gates wide open for untruths on the part of witnesses, but also for interpretations of statements against their actual wording by the Courts.<sup>240</sup> The media as well only publicize select portions of testimony, whose value as evidence is suspect from the start.<sup>241</sup>

<sup>237</sup> *Ibid.*, p. 13.

<sup>238</sup> In the Eichmann Trial, for ex., defense counsel R. Servatius declined to cross-examine the “*witnesses-of-Jewish-suffering*”, see R. Servatius, *Verteidigung Adolf Eichmann*, Harrach, Bad Kreuznach 1961, pp. 62f. (cf. note 182).

<sup>239</sup> The Frankfurt Auschwitz trial was an exception, as these proceedings were taped, but exclusively for the judges. The defense did never get access to these tapes, nor did the prosecution.

<sup>240</sup> Cf. the report on the trial against G. Weise: R. Gerhard (ed.), *op. cit.* (note 156), which shows how the Court judges the wording of a witness account against its actual content; in trials against revisionists, German Courts proceed rather similar, cf. G. Rudolf, “*Webfehler im Rechtsstaat*”, *Staatsbriefe* 1/1996, pp. 4-8; reprint in H. Verbeke (ed.), *Kardinalfragen zur Zeitgeschichte*, Vrij Historisch Onderzoek, Berchem 1996 (online: [vho.org/D/Kardinal/Webfehler.html](http://vho.org/D/Kardinal/Webfehler.html); English: [vho.org/GB/Books/cq/flaws.html](http://vho.org/GB/Books/cq/flaws.html)).

<sup>241</sup> Unfortunately, H. Langbein’s book *Der Auschwitz-Prozess*, *op. cit.* (note 154), based on his own notes, also contains only those witness statements that he deems credible, v. 1, p. 15 – but even they seem unbelievable in places.

In several instances Oppitz and Ruckerl have noted the influencing or prejudicing of witnesses by inmate organizations such as the covertly Communist VVN, the “*Organization of Persons Persecuted by the Nazi Regime*”.<sup>242</sup> But what is considerably more serious than the aforementioned manipulation by the investigative authorities is the way in which the witnesses coming to the Federal Republic of Germany from the Eastern Bloc nations were checked out for their reliability and even put under massive pressure, both by eastern secret service organizations as well as by Ministries of Justice and of the Interior, and even during the trials by Embassies and Consulates. They were even escorted into the courtroom by public servants. Reliable Communists and such witnesses as were willing to incriminate the accused were usually the only ones to be granted permission to leave the eastern states.<sup>243</sup> B. Naumann called this *modus operandi* of the Eastern Bloc nations “*inquisition*”,<sup>244</sup> and Langbein rejoiced that in spite of this discovery the German courts still did not question the credibility of these witnesses.<sup>245</sup> Further, Latenser reports that the witnesses for the Auschwitz Trial were able, even before the trial began, to tell their stories in the media or even in Witness Information Pamphlets published especially for this occasion, so that impartial and objective testimony became quite an impossibility. As well, the witnesses were monitored by many different organizations and persons, which also renders their prejudicing very likely.<sup>246</sup> As an aside, it should be pointed out that many witnesses travelled from one trial to the next, pocketing outrageously high witness fees as they went.<sup>247</sup>

The influence of the constant barrage of Holocaust stories on European, American and Israeli witnesses is demonstrated by Ruckerl on the basis of Australian witnesses. Whereas western witnesses can almost always make definite statements on certain complexes of the matter at issue, investigators in Australia usually come away empty-handed. Nobody can quite remember anything any more there.<sup>248</sup>

Of course, there is another component to some ‘eye witness accounts’, and that is political propaganda. It is well known that many communists and socialists were incarcerated in German concentration camps. It is more than likely that these persons co-operated with external underground movements as well as with the Soviets in what is today generally acknowledged as atrocity propaganda. For example, the famous Auschwitz inmates Ota Krauss and Erich Schön-Kulka,<sup>249</sup> Rudolf Vrba and Alfred Wetzler,<sup>250</sup> Filip Müller<sup>251</sup> and Stanislaw Jankowski<sup>252</sup> all were members of the so-

<sup>242</sup> A. Ruckerl, *op. cit.* (note 34), p. 256; U.-D. Oppitz, *op. cit.* (note 200), p. 113f., 239; cf. H. Latenser, *op. cit.* (note 170). VVN = Verein der Verfolgten des Naziregimes.

<sup>243</sup> H. Latenser, *ibid.*, pp. 37, 99ff., 158ff., 171ff.; H. Lichtenstein, *op. cit.* (note 88), p. 29, describes how the KGB manipulated Soviet witnesses.

<sup>244</sup> B. Naumann, *op. cit.* (note 145), pp. 438f.

<sup>245</sup> H. Langbein, *op. cit.* (note 154), v. 2, p. 864; the fact that witnesses were pressured was confirmed by the German Federal Supreme Court, but was rejected as grounds for revision; Criminal Division of the Federal Supreme Court, Ref. StR 280/67.

<sup>246</sup> H. Latenser, *op. cit.* (note 170), pp. 86ff., 170; U.-D. Oppitz documents a case of pressuring by monitors: *op. cit.* (note 200), p. 113.

<sup>247</sup> H. Latenser, *op. cit.* (note 170), pp. 113ff., 161ff.; this too was confirmed by the Federal Supreme Court (note 245), and rejected as grounds for revision; cf. F. J. Scheidl, *op. cit.* (note 77), v. 4, pp. 153-159.

<sup>248</sup> A. Ruckerl, *op. cit.* (note 34), pp. 258f.

<sup>249</sup> Ota Kraus and Erich Schön-Kulka, *Továrna na Smrt*, Cin, Prague 1946, p. 121f.

<sup>250</sup> Authors of the famous War Refugee Board Report, see “*German Extermination Camps - Auschwitz and Birkenau*” in David P. Wyman (ed.), *America and the Holocaust*, volume 12, Garland, New York/London 1990. see also R. Vrba, *I Cannot Forgive*, Bantam Books, Toronto 1964.

<sup>251</sup> Filip Müller, *Auschwitz Inferno: Testimony of a Sonderkommando*, Routledge & Kegan Paul, London 1979.

<sup>252</sup> *Hefte von Auschwitz*, special issue 1, “*Handschriften von Mitgliedern des Sonderkommandos*”, Verlag Staatliches Auschwitz-Museum, 1972, pp. 42 ff.

called camp partisans of Auschwitz who were involved in what they themselves called “making propaganda.”<sup>253</sup> The communist Bruno Baum even declared:

*“The whole propaganda which started about Auschwitz abroad was initiated by us with the help of our Polish comrades.”*<sup>254</sup>

*“It is no exaggeration when I say that the majority of all Auschwitz propaganda, which was spread at that time all over the world, was written by ourselves in the camp.”*<sup>255</sup>

*“We carried out this propaganda in [for] the world public until our very last day of presence in Auschwitz.”*<sup>256</sup>

The most striking admission of being a preposterous liar is perhaps that by famous Jewish Auschwitz ‘survivor’ Rudolf Vrba to his fellow-Jew and fellow-‘survivor’ Georg Klein. Asked if everything is true that Vrba had said about Auschwitz during an interview made for Claude Lanzmann’s movie *Shoa*, Vrba answered with a sardonic smile on his face:<sup>257</sup>

*“I do not know. I was just an actor and I recited my text.”*

These admissions of blatant lies are rare.<sup>258</sup> If one does not wish to accuse all witnesses of lying, but would rather give them the benefit of the doubt, then one must perforce seek other explanations. Many approaches to explanations have already been made, some of whom are discussed here briefly.

Gringauz was the first who described the Jewish perception and description of their persecution as biased:

*“The hyper-historical complex may be described as judeocentric, lococentric and egocentric. It concentrates historical relevance on Jewish problems of local events under the aspect of personal experience. This is the reason why most of the memoirs and reports are full of preposterous verbosity, graphomantic exaggerations, dramatic effects, overestimated self-inflation, dilettante philosophizing, would-be lyricism, unchecked rumorism, bias, partisan attacks and apologies.”*<sup>259</sup>

The question whether it is possible that events which someone has not personally experienced, or not experienced in the degree claimed, may be ‘remembered’ *ex post facto* so intensively that this affects a person’s psyche – in other words, that people experience the horror retroactively after actually having heard about it only through the media or through third parties, was answered recently. This question became especially relevant after the Demjanjuk Trial in Jerusalem when it turned out that not only the witnesses themselves were not credible, but that the deluge of forged documents and false testimony were also shaking the very core and foundation of their testimony as a whole.<sup>8:</sup>  
<sup>222</sup> As already mentioned, Elisabeth Loftus, the Jewish-American specialist on eyewitness testimo-

<sup>253</sup> See Bruno Baum, *Widerstand in Auschwitz*, Kongress-Verlag, Berlin (East) 1957, chapter “*Success of Propaganda*”, p. 97.

<sup>254</sup> “*Wir funken aus der Hölle*”, *Deutsche Volkszeitung* (Soviet paper in occupied Germany) July 31, 1945; see also an unpublished manuscript of Baum “*Bericht über die Tätigkeit der KP im Konzentrationslager Auschwitz*” (report on the activities of the communist party in the concentration camp of Auschwitz) from June 1945 in Vienna, Langbein estates in Dokumentationsarchiv des österreichischen Widerstandes, Vienna.

<sup>255</sup> Bruno Baum, *Widerstand in Auschwitz*, *op. cit.* (note 253), 1949, p. 34.

<sup>256</sup> *Ibid.*, p. 35.

<sup>257</sup> Georg Klein, *Pietà*, Stockholm 1989, p. 141; cf. Ernst Bruun, “*Rudolf Vrba exposes himself as a liar*”, *The Revisionist*, 1(2) (2003), pp. 169f. (online: [vho.org/tr/2003/2/Bruun169f.html](http://vho.org/tr/2003/2/Bruun169f.html))

<sup>258</sup> In the eastern block, they fell victim to censorship, as K. Bäcker has shown: “*Ein Kommentar ist an dieser Stelle überflüssig*“, *VffG* 2(2) (1998), pp. 120-129, here FN 29. In later editions, the sentences quoted here were ‘defused’ by deleting words like “*propaganda*” and replacing them with “*information*” and “*publication*”, see Bruno Baum, *Widerstand in Auschwitz*, East Berlin 1957 and 1961, p. 89, and 88, resp.

<sup>259</sup> S. Gringauz, “*Some Methodological Problems in the Study of the Ghetto*”, in Salo W. Baron, Koppel S. Pinson (ed.), *Jewish Social Studies*, vol. XII, New York 1950, pp. 65-72.

ny, recently published a book in which she describes the mechanisms by which most human brains produce ‘memories’ of events they actually never experienced, especially in situations of heavy emotional stress.<sup>260</sup>

Otto Humm described in an recent article how typhoid fever, an epidemic which raged in many German concentration camps and claimed ten thousands of lives, leads to a psychotic behavior of the patient who has extremely terrible hallucinations. If not treated appropriately, these hallucinations may be believed by the recovered patient as real events.<sup>261</sup>

Hans Pedersen offers a more psychological explanation based on a case in Denmark at the beginning of 19<sup>th</sup> century, where a young Jewish girl exhibited bizarre personal phenomena by injuring herself and simulating handicaps in order to attract public attention and a higher social status. She tricked all of her guardians and curiosity seekers, including most renowned physicians who were brought in to explain her baffling physical conditions. Most stunning in this case was *not* the behavior of the the young lady, a quite common kind of behavior in disturbed adolescents, but the incapability of the ‘experts’ to recognize the obvious signs of deceit as such because of their will to believe in the innocence of the girl and in the reality of the physiological miracles she apparently performed.<sup>262</sup>

Howard F. Stein appointed out another possible explanation when he recognized that the Holocaust has become a central focus of modern Jewish identity, and that the majority of the Jewish people lose themselves in identity-creating group fantasies of martyrdom.<sup>263</sup> And what is more: the Jewish side even demands the constant and ever-increasing “*traumatization*” of particularly the young Jewish generation by means of the deeply affective re-experiencing of all real and supposed Holocaust atrocities, intended to achieve their “*almost physical identification*” and solidarity with their people.<sup>264</sup> Thus, the Holocaust is considered today to be the core of the “*civil religion*” of at least the Israelis, if not of all Jews.<sup>265</sup>

Of course these almost pathological fixations of many Jews to the Holocaust led to massive criticism even from the Jewish side.<sup>266</sup> Even one of the most popular Holocaust authors, the Nobel Peace prize-winner Elie Wiesel, recently admonished not to let the Holocaust be a central point of reference for the Jewish identity. Under the title “*Do not get obsessed with the Holocaust*” he is quoted as follows:

“*The Holocaust has become too much of a central point in Jewish history. We need to move on. There is a Jewish tendency to dwell on tragedy. But Jewish history does not finish there.*”<sup>267</sup>

A conference of Ukrainian and Polish physicians in American exile, held in January 1993 towards the end of the Demjanjuk Trial, concluded that many Jews have forgotten their true and sometimes just as horrible experiences in the concentration camps, and are increasingly replacing them with

---

<sup>260</sup> E. Loftus, K. Ketcham, *op. cit.* (note 22), and E. Loftus, *op. cit.* (note 24).

<sup>261</sup> O. Humm, “*Die Gespensterkrankheit*”, *op. cit.* (note 17).

<sup>262</sup> H. Pedersen, “*The Hole in the Door*”, *The Revisionist*, 1(1) (2003), pp. 52-56.

<sup>263</sup> H. F. Stein, *The Journal of Psychohistory* 6(2) (1978) pp. 151-210; H. F. Stein, *ibid.*, 7(2) (1979) pp. 215-227 (online cf. [ihr.org/jhr/v01/v1n4p309\\_Stein.html](http://ihr.org/jhr/v01/v1n4p309_Stein.html)).

<sup>264</sup> C. Schatzker, *Aus Politik und Zeitgeschichte* 40(15) (1990) pp. 19-23, esp. pp. 22f.

<sup>265</sup> M. Zimmermann, “*Israels Umgang mit dem Holocaust*”, in R. Steininger (ed.), *Der Umgang mit dem Holocaust*, v. 1, Böhlau, Vienna 1994, p. 387-406, here p. 389; cf. T. Segev, *The Seventh Million*, Hill and Wang, New York 1993.

<sup>266</sup> Besides note 265 cf. A. Elon, “*Die vergessene Hoffnung*”, *FAZ*, June 28, 1993, p. 28; M. Wolffsohn, “*Eine Amputation des Judentums?*”, *FAZ*, April 15, 1993, p. 32; Yair Auron, *Jewish-Israeli Identity*, Tel Aviv 1993, p. 105, 109; cf. also G. Gillissen, “*Bedenkliche Art der Erinnerung*” *FAZ*, August 4, 1992, p. 8; in more detail cf. M. Zimmermann, “*Israels Umgang mit dem Holocaust*”, in R. Steininger (ed.), *Der Umgang mit dem Holocaust*, v. 1, Böhlau, Vienna 1994, p. 387-429; T. Segev, *The Seventh Million*, Hill and Wang, New York 1993.

<sup>267</sup> *Jewish Chronicle* (London), 31.5.1996, p. 10

group fantasies of martyrdom and with horror fairy-tales as spread by the media, which latter accounts are circulated with particular vigor in the Jewish communities due to their identity-building effect. Such phenomena have already been described in relevant medical literature and are known as *Holocaust Survivor Syndrome*.<sup>268</sup>

Finally, greed and political power may be seen as another driving force behind the tendency to invent, exaggerate, and distort events when it comes to the Holocaust, as Jewish-American scholar Norman G. Finkelstein pointed in 2000.<sup>269</sup>

#### 3.3.2.4.2. Witnesses for the Defense

How different, in comparison, is the Courts' treatment of witnesses for the defense! The most devastating example is that of G. Weise, for whose trial a great number of witnesses for the defense appeared, *i.e.*, were suggested to the Court. However, they were either not summoned by the Court, or their testimony was construed as incriminatory (contrary to its actual content) or simply declared irrelevant on the grounds that only incriminating testimony could clear up the facts of the crime. Anyone who knew nothing of the alleged crime had simply been in the wrong place at the wrong time.<sup>270</sup> In the end Weise was convicted on the basis of *one* witness for the prosecution, while the more than ten defense witnesses were utterly disregarded. Rieger reports that another Court scornfully dismissed two defense witnesses with the comment that it was a mystery why these witnesses would lie.<sup>271</sup> Burg reports that as defense witness he was regularly threatened and even physically assaulted.<sup>272</sup>

German defense witnesses who were not confined to concentration camps and ghettos at the time in question are on principle treated with distrust by the courts. If they cannot remember the atrocities alleged by witnesses for the prosecution, or if they should even dispute them (which is generally the case),<sup>273</sup> they are declared unreliable and are therefore not sworn in.<sup>274</sup> Prosecutor Grabitz expresses revulsion and loathing for such witnesses, as for the accused who testify in a similar vein and whom she would like nothing better than to slap resoundingly in the face.<sup>275</sup> Ruckerl even insinuates perjury,<sup>276</sup> and in fact some witnesses have been prosecuted to this effect.<sup>277</sup> Lichtenstein reports a case where such "*ignorant*" witnesses were charged *en masse* with lying and perjury and where threats of arrest, and actual arrests, were repeatedly made.<sup>278</sup> He quotes the judge's response to one witness who avowed that he was telling the plain and simple truth:

"You will be punished for this truth, I promise you."<sup>279</sup>

<sup>268</sup> Polish Historical Society, Press release of Jan. 25, 1993, PO Box 8024, Stamford, CT 06905, about a conference of Polish and Ukrainian physicians in the Polish Consulate, New York, on Jan. 24, 1993; cf. P. Chodoff, "*Post-traumatic disorder and the Holocaust*", *American Journal of Psychology – Academy Forum*, Spring 1990, p. 3.

<sup>269</sup> N. G. Finkelstein, *The Holocaust Industry. Reflections on the Exploitation of Jewish Suffering*, Verso, London/New York 2000.

<sup>270</sup> R. Gerhard (ed.), *op. cit.* (note 156), pp. 33, 40, 43-47, 52f., 60, 73.

<sup>271</sup> Deutscher Rechtsschutzkreis (ed.), *op. cit.* (note 156), p. 17; similar comments about defense witnesses in the Majdanek Trial: H. Lichtenstein, *op. cit.* (note 157), pp. 50, 63, 74.

<sup>272</sup> J. G. Burg, *Zionnazi Zensur in der BRD*, Ederer, Munich 1980 (Majdanek Trial).

<sup>273</sup> U.-D. Oppitz, *op. cit.* (note 200), pp. 115, 260; R. Henkys, *op. cit.* (note 9), pp. 210ff.; A. Ruckerl, *op. cit.* (note 34), pp. 250f.; H. Langbein, *op. cit.* (note 154), v. 1, p. 15; H. Langbein, *op. cit.* (note 155), p. 334.

<sup>274</sup> Cf. B. Naumann, *op. cit.* (note 145), pp. 272, 281, 294f., 299, 318, 321, 404.

<sup>275</sup> H. Grabitz, *NS-Prozesse...*, *op. cit.* (note 194), pp. 40f., 46, 48.

<sup>276</sup> A. Ruckerl, *op. cit.* (note 34), p. 251.

<sup>277</sup> U.-D. Oppitz, *op. cit.* (note 200), p. 353.

<sup>278</sup> H. Lichtenstein, *op. cit.* (note 88), pp. 63ff.

<sup>279</sup> H. Lichtenstein, *ibid.*, p. 80.

In the Auschwitz Trial, witness Bernhard Walter, whose testimony was not to the prosecution's liking, was placed under arrest until he had revised his statements.<sup>280</sup> It is clear that such actions by the Court cannot but have intimidated witnesses. But Lichtenstein merely fumes that despite all this some witnesses were still so insolent as to continue to deny everything.<sup>281</sup> German defense witnesses for the 'criminal side' who were willing to testify for Adolf Eichmann in the Jerusalem trial were always threatened with arrest by the prosecution, so that they stayed away from the proceedings.<sup>282</sup>

The dilemma of the German witnesses who had been 'outside the camps or ghetto fences' is demonstrated by H. Galinski, who demands that all members of the concentration camp guard staffs should be summarily punished for having been members of a terrorist organization.<sup>283</sup> Ruckerl explains that the only reason why this demand cannot be met is that at the time of the Third Reich the legal concept of a terrorist organization did not yet exist, and today's laws cannot be applied retroactively.<sup>284</sup> Nevertheless he and many others conclude that *anyone* from the Third Reich who had any contact whatsoever with the alleged events always has one foot in prison,<sup>285</sup> since the witnesses who are frequently motivated by hatred often regard any such person as a criminal merely because of the position he held at the time.<sup>286</sup> Langbein devotes an entire chapter to the opinion, expressed by many inmates, that all SS-men were devils incarnate,<sup>287</sup> and he even admits that each and every Holocaust survivor is a perpetual accuser of all Germans.<sup>288</sup> It is thus easy to understand that only a very few defense witnesses from the ranks of the SS, SD, Wehrmacht and Police have the stomach for giving unreserved, candid testimony, since any witness for the prosecution can fashion a noose out of it for them with their considerable talent for coming up with all sorts of incriminations. The show trial character of these anti-German and anti-Germany trials is pregnantly obvious to thoughtful onlookers.

And if defense witnesses should get carried away and presume to claim that they know nothing of gas chambers, and perhaps even dare to dispute their existence, then the least that will happen to them is that they are declared unreliable. Even the judge himself may become abusive.<sup>289</sup> But how the judges change their tune in those exceptional cases where a former SS-man 'confesses':

*"A valuable witness, one of the few who confirm at least some of what everyone knows anyhow."*<sup>290</sup>

Indeed, the author has hit the nail on the head! Since everything is "*judicially noticed*" and considered self-evident anyhow, it would be much easier to dispense with all the laborious proceedings

<sup>280</sup> H. Latenser, *op. cit.* (note 170), pp. 34ff., 57f., 414ff.; B. Naumann, *op. cit.* (note 145), pp. 272, 281, 299f.

<sup>281</sup> H. Lichtenstein, *op. cit.* (note 88), p. 77.

<sup>282</sup> R. Servatius, *op. cit.* (note 238), p. 64.

<sup>283</sup> I. Müller-Münch, *op. cit.* (note 226), p. 57.

<sup>284</sup> A. Ruckerl, *op. cit.* (note 34), pp. 235f.; cf. pp. 222ff.

<sup>285</sup> U.-D. Oppitz, *op. cit.* (note 200), p. 260; H. Lichtenstein, *op. cit.* (note 157), pp. 52, 58ff., 60; A. Ruckerl, *op. cit.* (note 144), pp. 13, 89, 181, 311; cf. also the desperate arguments of E. Bauer, who was sentenced to life imprisonment and could think of nothing better to say in his own defense than that all the other participants were at least as guilty as he: P. Longerich (ed.), *Die Ermordung der europäischen Juden*, Piper, Munich 1990, pp. 360ff.; in Israel, defense witnesses from the former SS and similar organizations can expect to be arrested on the spot, since in that country the law has fewer scruples regarding the retrospective application of laws; e.g., for the Eichmann Trial cf. F. J. Scheidl, *op. cit.* (note 77), v. 4, p. 239.

<sup>286</sup> A. Ruckerl, *op. cit.* (note 34), p. 236; U.-D. Oppitz, *op. cit.* (note 200), p. 114; I. Müller-Münch, *op. cit.* (note 226), pp. 109, 174; B. Naumann, *op. cit.* (note 145), pp. 18, 108, 114, 120; R. Gerhard (ed.), *op. cit.* (note 156), pp. 61, 63.

<sup>287</sup> H. Langbein, *Menschen in Auschwitz*, *op. cit.* (note 155), pp. 333ff.; cf. pp. 17f.

<sup>288</sup> *Ibid.*, p. 547.

<sup>289</sup> Cf. B. Naumann, *op. cit.* (note 145), p. 265; I. Müller-Münch, *op. cit.* (note 226), p. 107: "*What all do you think you can make this Court believe? I will dispense with any further testimony of yours.*," also pp. 116, 172.

<sup>290</sup> H. Lichtenstein, *op. cit.* (note 157), p. 56; *op. cit.* (note 88), pp. 72f.: "[...] *the Chief of the District Court said, well, we get this sort of witness too sometimes. 'Thank God!', one might add.*"

and simply hand down the verdict as soon as the witnesses for the prosecution have had their say as in typical show trials.

The courts frequently conclude from these circumstances that witnesses for the defense cannot contribute anything of value to an investigation anyhow, and thus disregard their testimony or even dispense with summoning them in the first place.<sup>291</sup>

Finally, it should be mentioned that many former inmates who, during interrogations by the police or state attorneys prior to the actual trials, made exonerating statements about purported historical events in general or certain defendants in particular, were simply never summoned by the courts as witnesses. The transcripts of these pre-trial interrogations are not accessible to the public. Only recently, I managed to receive a complete set of photocopies of these investigation files leading to the infamous Frankfurt Auschwitz trial by means not to be described here (and Jürgen Graf managed to receive a copy of the investigation files of the Majdanek trial). These documents are currently analyzed, results of which will be published step by step. A preliminary study has already revealed that the German authorities have been – and probably still are – engaged in the suppression of exonerating evidence on a massive scale.

### 3.3.2.5. The Defendants

While the situation of witnesses from the SS and similar backgrounds is critical, that of the accused can only be described as hopeless. They are the target of the unbridled hatred and malice of the witnesses for the prosecution as well as of the media.<sup>292</sup> It borders on the miraculous that in light of the conditions pointed out here, by far the majority of the accused *do* in fact dispute any participation in the alleged crimes. On the other hand, they do not as a rule dispute the crimes *per se*; in view of the “*self-evidence*” of these matters, any such attempt would only serve to diminish their credibility in the eyes of the Court anyway. The accused frequently express dismay and disgust at the crimes alleged. Jäger<sup>293</sup> comments that these exclamations might be prompted by tactical considerations, and by a change of heart brought about by later influences from outside, and can thus hardly be regarded as evidence for an awareness of guilt at the time in question – and we would like to add here that for the same reasons they can also not be taken as evidence for the crime itself, particularly since the often ambiguous statements of the alleged perpetrators, as recorded in contemporaneous diaries, letters, speeches etc.,<sup>294</sup> almost never suggest any awareness of guilt.

Frequently, however, the accused do not speak out against the allegations made against them, or cannot remember. They merely attempt to dispute any participation in the crime, and to shift the blame onto third parties – mostly unknown, dead or missing comrades.<sup>295</sup> Statements made by the accused in their own defense are interpreted by the Court and the prosecution as lies intended to

<sup>291</sup> Cf. H. Lichtenstein, *ibid.*, p. 106.

<sup>292</sup> Regarding the prior conviction by the media, cf. H. Latenser, *op. cit.* (note 170), p. 12f., “*Devil incarnate*”, pp. 33, 86, 147f.

<sup>293</sup> H. Jäger, in P. Schneider, H. J. Meyer (eds.), *Rechtliche und politische Aspekte der NS-Verbrecherprozesse*, Johannes Gutenberg-Universität, Mainz 1966, pp. 56f.; cf. H. Jäger, *Verbrechen unter totalitärer Herrschaft*, Walter-Verlag, Olten 1966.

<sup>294</sup> H. Langbein, *...wir haben es getan*, Europa Verlag, Vienna 1964, esp. pp. 125ff.; cf. also G. Schoenberner, *Wir haben es gesehen*, Fourier, Wiesbaden 1981.

<sup>295</sup> A. Rückerl, *op. cit.* (note 34), pp. 237ff.; *NS-Prozesse*, *op. cit.* (note 131), pp. 30, 34; *op. cit.* (note 144), pp. 25, 30f., 40, 70, 78, 81f., 85f., 88ff., 253, 319f.; U.-D. Oppitz, *op. cit.* (note 200), p. 261; R. Henkys, *op. cit.* (note 9), pp. 210ff.; H. Langbein, *Menschen in Auschwitz*, *op. cit.* (note 155), pp. 566ff.; cf. also the closing comments of the defendant in the Auschwitz Trial, Frankfurt: H. Langbein, *op. cit.* (note 154); also B. Naumann, *op. cit.* (note 145); H. Lichtenstein, *op. cit.* (note 88), pp. 30f., 34, 47, 86f., 110, 128, 202, 206, 210; H. Grabitz, *NS-Prozesse...*, *op. cit.* (note 194), pp. 38, 41, 64, 120, 145.



serve as cover,<sup>296</sup> which is often the case since many defendants will try any and all possible and impossible tricks in order to distance themselves from the place and time of the alleged crime, which of course they do not always succeed in doing. But these tactics, often doomed to failure, are easy to understand, since the accused are given next to no chance to disprove the crime itself. Thrust into the helpless defensive in this way, the accused fall silent at many of the charges brought against them. A statement of the Presiding Judge at the Auschwitz Trial in Frankfurt is significant:

*“We would have come a good bit closer to the truth if you had not persisted in hiding behind such a wall of silence.”*<sup>297</sup>

But which truth did the judge want to hear? Some of the accused did not admit even a certain measure of guilt until after they had suffered dramatic heart attacks, nervous breakdowns and hysterics.<sup>298</sup> Outrage at the boundless lies of the witnesses is a constant with all the defendants.<sup>299</sup>

Even after they have been convicted, and sentenced to many years or even a lifetime in prison, most of them continue to “*obstinately*” deny their guilt, which is absolutely unusual otherwise for criminals of this kind. Remorse, repentance and an awareness of guilt seem to be alien to them.<sup>300</sup> Even in those few cases where guilt is admitted, a strange dichotomy of perception occurs, where the alleged criminals are not truly penitent and ready to atone from the heart, but continue to seek to place part of the blame elsewhere, to invent justifications for the acts in question, and to complain of injustices done to them. Sereny<sup>301</sup> and Draber<sup>302</sup> speak of the existence of two different levels of conscience and consciousness and even of self-alienation and disturbances of consciousness.

A particularly devastating example is that of Oswald Kaduk, one of the accused in the Auschwitz Trial, a very simple soul. He was badgered so dreadfully that he suffered a nervous breakdown,<sup>303</sup> attempted during his trial to refute even testimony in his favor,<sup>304</sup> and ultimately said with resignation,

*“Well, I’m a murderer, no one will believe me anyway.”*<sup>305</sup>

Anyone who would like to recreate for himself Kaduk’s complete mental confusion is referred to Demant’s interviews with him and two other convicts of the Auschwitz Trial.<sup>299</sup> Anyone who reads them attentively will all but trip over this scandalous travesty of justice.

Considering these circumstances it is utter mockery for Langbein to claim:

*“There is nothing to keep them [the accused] from dismissing or disproving exaggerated allegations.”*<sup>306</sup>

The last straw is provided by Oppitz, who criticizes that after their release from prison some of those who had been convicted of NS crimes are monitored with an eye to their political activity – an unlawful and no doubt unparalleled act of police-state surveillance.<sup>307</sup> Clearly our state desires to ensure that these people do not become active as Revisionists. The same is true for prisoners who

---

<sup>296</sup> A. Rückerl, *op. cit.* (note 34), p. 266; H. Langbein, *op. cit.* (note 154), v. 1, p. 15; H. Grabitz, *NS-Prozesse...*, *op. cit.* (note 194), pp. 110ff.

<sup>297</sup> B. Naumann, *op. cit.* (note 145), p. 507, cf. pp. 62, 265, 294.

<sup>298</sup> For ex., cf. I. Müller-Münch, *op. cit.* (note 226), p. 98; B. Naumann, *op. cit.* (note 145), pp. 130, 132, 137.

<sup>299</sup> B. Naumann, *ibid.*, pp. 144f., 189, 378; H. Lichtenstein, *op. cit.* (note 157), p. 74; E. Demant (ed.), *Auschwitz – “Direkt von der Rampe weg...”*, Rowohlt, Reinbek 1979, pp. 90f., 111, 128.

<sup>300</sup> U.-D. Oppitz, *op. cit.* (note 200), pp. 165f.

<sup>301</sup> G. Sereny, *Am Abgrund*, Ullstein, Frankfurt/Main 1979, p. 123, cf. also pp. 130, 141, 400.

<sup>302</sup> A. Draber, in J. Weber, P. Steinbach (eds.), *op. cit.* (note 15), p. 110.

<sup>303</sup> B. Naumann, *op. cit.* (note 145), p. 130.

<sup>304</sup> H. Langbein, *Menschen in Auschwitz*, *op. cit.* (note 155), pp. 552f.

<sup>305</sup> B. Naumann, *op. cit.* (note 145), p. 150.

<sup>306</sup> H. Langbein, *op. cit.* (note 154), v. 1, p. 10.

<sup>307</sup> U.-D. Oppitz, *op. cit.* (note 200), pp. 315f.

were released on parole: They do not dare to get in contact with independent researchers and do not want to talk about the events half a century ago since they are threatened to be imprisoned immediately if they show some kind of revisionist behavior. Thus for example Kurt Franz, former camp commander of Treblinka concentration camp, who was released on parole in 1994, refuses to speak about the past since he fears to get imprisoned again.<sup>308</sup> He should not have any reason to do so if everything German Courts have stated in their verdicts about Treblinka is correct.<sup>309</sup>

In view of the glaring discrepancy between the gruesomeness of the alleged crimes and the good and decent harmless nature of the accused, Helge Grabitz<sup>310</sup> seconds Hannah Arendt<sup>182</sup> in her observations on the commonplace face of evil. It even occurs to her that the reason for the stubborn denials of the accused, and for the contrast between the crimes and the alleged criminals, just might be that the crimes in fact never actually took place – but she immediately rejects this “*seductive*” idea as cynically flying in the face of the evidence.<sup>311</sup>

### 3.3.2.6. Public Reaction

The circumstances and conditions of the NSG trials regarding the drawing-up of historical summaries of the alleged National Socialist atrocities, pointed out in Section 3.3.2.2., already suggest that these proceedings exhibit strongly their show-trial nature. Admissions to the effect that the NSG trials are of importance first and foremost to the cause of public education, *i.e.*, opinion-leading are numerous. For example, the public prosecutor at the Auschwitz Trial, Fritz Bauer, admitted this truth,<sup>312</sup> as did B. Naumann, the *FAZ* correspondent at this trial. The latter wrote that the Auschwitz Trial was of “*ethical, socially educational significance.*”<sup>313</sup> And H. Langbein, the *éminence grise* behind the trial scene, commented:

“*The special element in these criminal trials is their political impact.*”<sup>314</sup>

A. Rückerl wrote that the ‘clearing-up’ of National Socialist crimes was

“*of an overall public and historical relevance that went far beyond the criminal prosecution per se*”,  
and:

“*The combined results of historical research and criminal investigation lend themselves to impressing upon the man on the street such matters as he ought to bear well in mind, in his own interest – regardless of how unpleasant this may be for him.*”<sup>315</sup>

With thematic consistency, Scheffler suggests that the NSG trials ought to be a permanent focus of public life since they deal with an issue of our society’s very existence,<sup>316</sup> and according to Steinbach the NSG trials provide an important contribution to the shaping of German identity.<sup>317</sup>

The logical consequence of all this is that, for educational reasons, entire school classes and armed forces units are regularly taken to observe such trials,<sup>318</sup> which are at times also attended by high

<sup>308</sup> Personal note from K. Franz, handed over by M. Dragan.

<sup>309</sup> District Court Frankfurt, Ref. 14/53 Ks 1/50; District Court Düsseldorf, Ref. 8 I Ks 2/64; *ibid.*, Ref. 8 Ks 1/69.

<sup>310</sup> H. Grabitz, *NS-Prozesse...*, *op. cit.* (note 194), p. 115.

<sup>311</sup> H. Grabitz, *ibid.*, p. 147, refers to E. Aretz, *Hexen-Einmal-Eins einer Lüge*, Hohe Warte, Pähl 1973, a book that is certainly not representative of revisionism, and outdated as well. It would have been more appropriate to quote A. R. Butz, *The Hoax of the Twentieth Century*, Institute for Historical Review, Newport Beach, CA 1976, or W. Stäglich, *Der Auschwitz-Mythos*, Grabert, Tübingen 1979 (online: vho.org/D/dam).

<sup>312</sup> C. von Schrenck-Notzing, *Charakterwäsche*, Seewald, Stuttgart 1965, p. 274.

<sup>313</sup> B. Naumann, *op. cit.* (note 145), p. 7.

<sup>314</sup> H. Langbein, *op. cit.* (note 154), v. 1, p. 9.

<sup>315</sup> A. Rückerl, *op. cit.* (note 144), pp. 7 and 23; cf. A. Rückerl, *op. cit.* (note 34), p. 323; cf. also H. Lichtenstein, *op. cit.* (note 88), pp. 213f.

<sup>316</sup> W. Scheffler, in J. Weber, P. Steinbach (eds.), *op. cit.* (note 15), p. 114.

<sup>317</sup> P. Steinbach, in J. Weber, P. Steinbach (eds.), *ibid.*, p. 39.

dignitaries from Jewish organizations and Israel.<sup>319</sup> The unabashed Jewish admission that the trials against Eichmann and Demjanjuk in Israel, where both cases were the only really interesting matter for all of Israel's media for many weeks, had been of the nature of show-trials, seems more honest than these German proceedings.<sup>320</sup>

Kröger points out the discrepancy between the will of the majority of the German people in the mid-1960s, which was to have an end to the NSG trials,<sup>321</sup> and the major print media's almost unanimous support of their perpetuation,<sup>322</sup> which ensured that the reading public was steered in this "pedagogically desired" direction.<sup>323</sup> He also points out that the criticism directed at the courts by these print media is proportionally more severe, the more lenient the verdicts turn out – in other words, greater severity is demanded.<sup>324</sup> Bonhoeffer thus notes correctly that the German press reports in great detail particularly about the spectacular mass trials, even though there was next to no public demand for such information until the 1970s.<sup>325</sup> Lichtenstein<sup>326</sup> and Steinbach<sup>327</sup> note that a growing trend towards the rejection of the NSG trials in the late 1970s and early 1980s was suddenly followed by a drastic change in public opinion, induced – according to Steinbach – not only by the pedagogically trained younger generation but primarily by the television miniseries *Holocaust*.<sup>328</sup> The mission entrusted to the media – public education and opinion-steering – has been stressed by various sources.<sup>329</sup> The newspaper *Neues Österreich* shed new light on the quality of this type of media reporting when it commented on witness testimony in an NSG trial in the following way, which unfortunately is typical for our media:

"Whatever the accused cannot disprove did obviously take place, as incredible as it may sound."<sup>330</sup>

In other words, the public consents to the practice that in NSG trials it is not the guilt of the accused that must be proven, but rather that the accused must prove his innocence of any and all conceivable accusations, in the tradition of the Inquisition of medieval times.

Abroad, the most remarkable reaction to the NSG trials was no doubt the international appeal of 1978, not to allow the National Socialist crimes to lapse under the statute of limitations,<sup>331</sup> this ap-

<sup>318</sup> I. Müller-Münch, *op. cit.* (note 226), pp. 181ff.; H. Langbein, *Menschen in Auschwitz*, *op. cit.* (note 155), p. 553; H. Langbein, *op. cit.* (note 154), v. 1, pp. 10, 49; B. Naumann, *op. cit.* (note 145), p. 367; H. Laternser, *op. cit.* (note 170), p. 20; H. Lichtenstein, *op. cit.* (note 157), pp. 106, 123, 129f.; H. Lichtenstein, *op. cit.* (note 88), pp. 159, 166, 205; H. Grabitz, *NS-Prozesse...*, *op. cit.* (note 194), pp. 55, 69.

<sup>319</sup> H. Lichtenstein, *op. cit.* (note 157), p. 37; G. Stübiger, *Der Schwammerbergerprozeß in Stuttgart*, Schriftenreihe zur Geschichte und Entwicklung des Rechts im politischen Bereich, no. 4, Verein Deutscher Rechtsschutzkreis e.V., Bochum May 1992.

<sup>320</sup> Regarding the Eichmann Trial and the trial of J. Demjanjuk in Jerusalem: A. Melzer, "Iwan der Schreckliche oder John Demjanjuk, Justizirrtum? Justizskandal!", *SemitTimes*, special issue March 1992.

<sup>321</sup> U. Kröger, *Die Ahndung von NS-Verbrechen vor westdeutschen Gerichten und ihre Rezeption in der deutschen Öffentlichkeit 1958 bis 1965*, diss., Univ. Hamburg, Hamburg 1973, pp. 267ff., 276.

<sup>322</sup> *Ibid.*, pp. 323f.

<sup>323</sup> *Ibid.*, p. 331.

<sup>324</sup> *Ibid.*, p. 322; B. Hey points out similar criticism by other groups such as churches and jurists, in J. Weber, P. Steinbach (eds.), *op. cit.* (note 15), pp. 65ff.; cf. *ibid.*, pp. 202ff.

<sup>325</sup> E. Bonhoeffer, *op. cit.* (note 216), p. 15.

<sup>326</sup> H. Lichtenstein, *op. cit.* (note 88), p. 212.

<sup>327</sup> P. Steinbach, in J. Weber, P. Steinbach (eds.), *op. cit.* (note 15), p. 29; also W. Scheffler, *ibid.*, pp. 114ff.; P. Reichel, *ibid.*, p. 158.

<sup>328</sup> Regarding the general shift in mood following the screening of *Holocaust*, cf. esp. T. Ernst, *Aus Politik und Zeitgeschichte* 31(34) (1981) pp. 3-22.

<sup>329</sup> E. Bonhoeffer, *op. cit.* (note 216); H. Lichtenstein, *op. cit.* (note 157), p. 117; H. Grabitz, *NS-Prozesse...*, *op. cit.* (note 194), pp. 58f.

<sup>330</sup> *Neues Österreich*, June 1, 1963, p. 12.

<sup>331</sup> A. Ruckerl, *op. cit.* (note 34), p. 205; cf. also the chapter by C. Jordan, this volume.

peal, which came after the Federal German statute of limitations for murder had already been extended twice,<sup>332</sup> was made for the sole purpose that the prosecution of alleged National Socialist crimes might continue ‘til the end of time. In this context, Lichtenstein notes that during the 1979 debate about this statute, Simon Wiesenthal had had postcards of protest printed in many different languages and distributed with the request to mail these to the Federal German government.<sup>333</sup> Steinbach is quite right when he describes the German *Bundestag* debates on this statute<sup>334</sup> as some of the most remarkable moments of German parliamentarianism.<sup>335</sup>

Thus, even in 1997, more than 50 years after the end of the war and more than half a century since commission of the supposed crimes, NSG trials continue to be decided solely on the basis of witness testimony. Especially in the new post-reunification German states, people are being prosecuted who have practically already been convicted but who to date were not within reach of the authorities. Langbein predicted this development as early as 1965:

“It is therefore to be expected that, once extensive researches are conducted, many SS-men will yet be found in the German Democratic Republic who, while already proven guilty [sic!!!], could not be arrested in the Federal Republic of Germany or in Austria.”<sup>336</sup>

This perpetual witch hunt is made possible by revisions of laws which act retroactively to exacerbate the trial situation of any accused – in other words, according to Henkys, the process is based on an *ex post facto* (retroactive) law that violates human rights.<sup>337</sup>

It is also significant that the supposed National Socialist criminals are not allowed to rest in peace even after their deaths. Ever since the war the press has routinely spread rumors claiming that Hitler is still alive, or that his body has finally been found and autopsied; these rumors supplement the many reports and accounts surrounding the fates and final resting places of supposed National Socialist murderers.<sup>338</sup>

### 3.3.2.7. Summary

Even though experts agree that witness testimony loses almost all of its evidential value in the course of only a few years, persons are continuing to be convicted even decades after the supposed fact, on the basis of witness testimony that is clearly unreliable in every respect. Exonerating evidence may be suppressed,<sup>339</sup> and the media, whose role properly ought to be that of monitor, not only join in this game, but even demand that it be stepped up.

In other words, in trials dealing with certain types of crimes the crime itself is regarded as unshakeable fact, and this usually goes for the perpetrators as well, since every German employed in a concentration camp may be considered a criminal or an accomplice. Some witnesses even said this quite frankly, and demanded that punishment should be meted out for the very fact that someone

<sup>332</sup> First extension *BGBI I* (1965) p. 315, second *BGBI I* (1969) pp. 1065f., final rescission *BGBI I* (1979) p. 1046; cf. M. Hirsch, in J. Weber, P. Steinbach (eds.), *op. cit.* (note 15), pp. 40ff.; W. Maihofer, *op. cit.* (note 150), pp. 3-14; P. Schneider, *ibid.*, p. 15-23.

<sup>333</sup> H. Lichtenstein, in J. Weber, P. Steinbach (eds.), *op. cit.* (note 15), p. 197.

<sup>334</sup> Deutscher Bundestag, Press- und Informationszentrum (ed.), *Zur Verjährung nationalsozialistischer Verbrechen*, Zur Sache vol. 3-5/80, Bonn 1980.

<sup>335</sup> P. Steinbach, in J. Weber, P. Steinbach (eds.), *ibid.*, p. 27.

<sup>336</sup> H. Langbein, *op. cit.* (note 154), v. 2, p. 1003.

<sup>337</sup> R. Henkys, *op. cit.* (note 9), p. 276; cf. the chapter by C. Jordan, this volume.

<sup>338</sup> E.g., the frequent reports about the alleged destiny of Hitler’s corpse, most recently in the German tabloid *Bild*, Jan. 26, 2000, p. 1, 2, 6; the downright repulsive exploitation of the death of Mengele; cf. G. L. Posner, J. Ware, *Mengele. Die Jagd auf den Todesengel*, Aufbau, Berlin 1993; cf. *Frankfurter Allgemeine Zeitung*, April 13, 1993, p. 3: “Nichts als Gerüchte um Bormanns Grab”; *Die Zeit*, Nov. 8, 1991, p. 87: “In ewiger Ruhe das Ungeheuerliche”, regarding Ch. Wirth.

<sup>339</sup> For a classic example of this, cf. the chapter by C. Jordan, this volume.

had worked in a concentration camp. Anyone involved in a trial under these conditions – regardless whether he was a witness or a defendant – could not possibly dispute the crime as such, since doing so would have meant a more severe sentence for a defendant or, for a witness, criminal charges for incitement, slander or the like, or at the very least enormous social reprisals ensuring professional ruin or worse.

Under such anti-law circumstances, the most that any defendant could do was to try to minimize his role in the ‘crime’ and to deflect at least some of the attack by incriminating others. The incrimination of third parties is a sure way to make friends of the prosecution and the Court, which latter is always willing to make concessions in return for confessions and cooperation in the discovery of further putative criminals – a court technique that will induce false confessions if the crime *per se* is not open to debate.

In many countries in Europe even neutral researchers are not in a position today to approach Holocaust studies with the hypothesis that certain events did not take place. They too are condemned without any examination of their arguments, on the grounds of self-evidence of the opposite of their theses, and with that they are deprived of their social existence. In 1992 the Provincial High Court and Court of Appeal in Düsseldorf, seconding a decision of the Federal Constitutional Court, did decide that self-evidence may be reversed if completely new evidence, or such that is superior to past evidence, is presented, requiring a retrial of the matter at hand.<sup>340</sup>

But even new and extensive scientific material evidence, advanced in order to reverse the decree of self-evidence, has been refused by the courts. In this context the Federal German Supreme Court decided in 1993 that even the refusal of motions to examine self-evidence, as one defense counsel proposed to do in an appeal document,<sup>341</sup> is proper legal procedure due to the self-evidence of the Holocaust.<sup>139</sup> The Holocaust, therefore, is a judicially safeguarded view of history which this decision renders completely untouchable. This represents an inquisition in its purest and highest degree, and a gross violation of the human rights to academic freedom and the freedom of expression and opinion.

Unfortunately, until recently there were no attorneys who recognized this vicious circle that is so catastrophic for a state supposedly governed by justice, and no attorneys who demanded that the crime, the murder weapon and the victims, *i.e.*, the evidence for these, as well as eyewitness testimony and documents, be examined with modern forensic methods before the question can be raised of who the murderer/s might have been. Such attorneys have stepped onto the scene only recently, but aside from slander and abuse, threats of prosecution and the aforementioned decision of the Federal Supreme Court – *i.e.*, an exacerbation of the judicial situation – they too have been unable to achieve any changes.

In 1966 R. M. W. Kempner, then the deputy chief prosecutor at the IMT, claimed that with respect to legal procedure the Nuremberg Trial did not differ from the trials held before a German jury court or another kind of court.<sup>342</sup> In many respects we agree with him.

---

<sup>340</sup> Düsseldorf Provincial High Court and Court of Appeal, Ref. 2 Ss 155/91 – 52/91 III; Federal Constitutional Court Ref. 2 BrR 367/92; cf. H. Kater, *DGG* 40(4) (1992) pp. 7-11 (online: [vho.org/D/DGG/Kater40\\_4.html](http://vho.org/D/DGG/Kater40_4.html)). The *Bundestag* seconded this, cf. the decision of the petitioning committee, Ref. Pet4-12-07-45-14934, letter to H. W. Woltersdorf, dated July 30, 1992.

<sup>341</sup> Appeal document, Hajo Herrmann, regarding the verdict of the Schweinfurt District Court, Ref. 1 KLS 8 Js 10453/92, submitted on Dec. 29, 1993, Ref. H-nw-02/93.

<sup>342</sup> R. M. W. Kempner in P. Schneider, H. J. Meyer, *op. cit.* (note 293), p. 8.

## 4. Parallels

There used to be a crime that was considered to be worse than any other; it was known as *crimen atrox* (atrocious crime). According to witness testimony this included the most horrific abuses and ways of murdering people and animals that the human mind can conceive of, and even included harm to and destruction of the environment. Not only was such a crime prosecuted directly by the public prosecutor as soon as it became known – the courts were even instructed not to observe the normal rules of procedure, since these were satanic crimes that could not be dealt with in the ordinary way. Even death could not keep the victims from being persecuted: their bodies were simply exhumed without much ado.

Whereas in the early days of the prosecution of such crimes the accused and sometimes even reluctant witnesses were subjected to brutish torture, such methods fell quite out of favor later on. Psychologically cunning methods of interrogation and protracted, trying imprisonment while awaiting trial replaced physical torture. And finally, the stories about these crimes, spread by all available media and already recorded in detail in official books and registers, ensured that everyone knew what the proceedings were all about. As a result witness statements regarding individual crimes often resembled each other so closely that outside observers could not but believe that the testimony of so many different persons who had nothing else in common simply *had* to be true somehow.

Many witnesses testified anonymously. Witnesses for the prosecution, who had to swear a holy oath to the Court regarding the veracity of their testimony, were usually highly rewarded for their services. As a rule their statements were never scrutinized, and the witnesses themselves were never cross-examined by the defense. Even if they were shown to have committed perjury, generally nothing happened to them. Even patently absurd and inconsistent, physically impossible claims were deemed credible.

Witnesses or defendants who denied the crime itself or their involvement in it were persecuted and punished all more severely for their stubborn lies, since obviously they were not willing to admit their satanic deeds, to repent and to renounce their satanic practices. In time, every accused realized that admitting guilt was his only hope for leniency from the Court, so that false confessions were made even in cases where torture was no longer practiced. The incrimination of third parties was a device commonly used in attempts to cooperate with the Court in order to obtain a more lenient sentence or even freedom.

Very rarely did the courts accept material evidence relating to the alleged crimes, and even in cases where it could be proven that the persons said to have been murdered were still alive, or had died of natural causes many years earlier, the courts were frequently unmoved. Later, even a clause providing for the self-evidence of the crime was introduced, which served to stonewall any counter-evidence from the start.

The defense attorney was not permitted to question the crimes themselves and had to accept the views of his time as his own if he did not wish to fall out of favor with the Court and the public. This could even result in his being accused of sympathizing with his client's deeds and belonging to the latter's criminal clique, which earned him a trial of his own. As well, the defendants were rarely granted access to the case files and could not speak with their clients in private.

This is an account of the conditions prevailing in the witch trials of medieval times, as researched and set out by Soldan in his classic *Geschichte der Hexenprozesse* (History of the Witch Trials).<sup>343</sup>

The similarities to the modern cases described herein are surely coincidental?

---

<sup>343</sup> M. Bauer (ed.), Soldan-Heppe, *Geschichte der Hexenprozesse*, esp. v. 1, Müller, Munich 1912, pp. 311ff.; cf. also W. Behringer, *Hexen und Hexenprozesse in Deutschland*, dtv, Munich 1988, p. 182.

## 5. Conclusions

Under the conditions of the NSG trials set out in the preceding, the eyewitness testimony and confessions made in these trials can be accorded next to no evidential value. From a scientific point of view, and in this case in particular, eyewitness testimony can never suffice to document historical events, much less to prove them in a court of law.

Confessions and statements have been extorted from supposed perpetrators and participants by means of torture, threats of criminal charges, more severe punishment and prison terms, detriments to personal welfare and professional advancement, as well as by the complete hopelessness and helplessness imposed by the show trials as described. Similar means were also employed to manipulate witnesses for the prosecution, who in turn engaged in manipulation of their own. In these cases it was a matter of threats of violence as well as deliberate manipulation by the media, governmental, judicial and private institutions. What is more, the absolute free rein that was granted these witnesses, and the tendency to portray them belatedly as heroes of anti-Fascist resistance and to reinforce their thirst for vengeance, have resulted in this testimony being taken *ad absurdum* in its inconsistency and exaggeration. Some of the most glaring examples of such statements are listed at the end of this article.

The decisive prerequisite for these conditions is the worldwide climate of persecution and defamation to which anyone and everyone is subjected who may possibly have been in any way connected with alleged National Socialist crimes or who is suspected of doubting the truth of these. The allegedly unprecedented nature of these crimes induces an unparalleled moral blindness in ‘Nazi-hunters’ and in the guardians of the fundamental anti-Fascist consensus that prevails in politics, in the media and even among the broad masses, which suspends the rules of common sense and justice guided by the rule of law, so that the corresponding court cases call the medieval witch trials vividly to mind.

One proof of this attitude held by the majority of our fellow men and women is the fact that to date books such as the present volume have not been favored with rational arguments, but rather are countered with hysterical cries for the public prosecutor, even if those shrieking the loudest have never read the book in anything approaching its entirety or have not bothered to confirm the correctness of its contents by checking the source material. There simply are things nowadays that *cannot* be true because they are not *allowed* to be true.

In view of all the facts one is probably correct in the assumption that where the Holocaust is concerned our society is in a state of permanent mass suggestion fostered by the Holocaust Survivor Syndrome,<sup>268</sup> by the downright hysterical prosecution mania of all sorts of social groups right up to the upper echelons of especially, but not exclusively, the German Federal justice system,<sup>344</sup> directed at anyone holding a dissenting opinion, and of course by the never-ending traumatizing of coping and mourning rituals conducted in schools, politics and the media. Bender comments:

*“Mass suggestion, frequently bordering on the hysterical, has an even stronger formative influence than the good example of so-called opinion leaders. Enhancing factors include: solemn rituals,<sup>345</sup> the inces-*

---

<sup>344</sup> In the last years efforts especially in the USA, Canada and Australia grow to expell or prosecute former members of former German military units, cf. *World Jewish Congress*, press release December 12, 1996; *AP*, January 1, 1997; *Dateline ABC*, January 31, 1997; *New York Times*, February 3, 1997; *Calgary Herald*, March 24, 1997; *Globe & Mail*, February 21, 1997; *Toronto Sun*, 13.5.1997; *New York Times*, June 21, 1997; *AP*, August 20, 1997; *AP*, September 2, 1997; *AFP*, August 30, 1997; *Reuter*, July 1, 1997; *ibid.*, July 15, 1997; *ibid.*, July 22 1997; *ibid.*, August 12, 1997; *ibid.*, August 31, 1997. Updates about this can be found in *VffG*, (online: [vho.org/VffG.html](http://vho.org/VffG.html)); cf. Efraim Zuroff, *Beruf: Nazijäger. Die Suche mit dem langen Atem*, Ahriman, Freiburg 1996; review: I. Schirmer-Vowinckel, *VffG*, 2(1) (1998), pp. 63-68 (online: [vho.org/VffG/1998/1/Buecher1.html#ISV1](http://vho.org/VffG/1998/1/Buecher1.html#ISV1)).

<sup>345</sup> In this case: the screening of Holocaust movies, commemorative speeches on special days (‘Reichskristallnacht’,

*sant repetition of the same catch phrases,<sup>346</sup> emotionally stimulating signals (music, flags etc.).<sup>347</sup> [...] What is more, mass suggestion lends itself more than almost any other phenomenon to the induction of downright extreme distortions of perception.”<sup>348</sup>*

Taking into consideration all the circumstances involved in how testimony regarding the Holocaust comes about, suspicions may arise that the accusations made are not only not provable, but that in fact the opposite of the claims advanced by the established Holocaust story may be true. This is the only thing that could explain why the establishment saw and continues to see itself forced to resort to such unjust, even unlawful measures.

Meanwhile even contemporary historiography has concluded, painfully enough, that the eyewitness testimony is not reliable.<sup>349</sup> But contemporary historians have fashioned themselves a crutch: Nolte, for example, explains that while statements on the Holocaust might be exaggerated, it would be impossible to invent the like outright.<sup>350</sup> He is thus in agreement with many expert psychiatrists and psychologists who, according to Oppitz,<sup>224</sup> have affirmed repeatedly that there can really be no doubt about the factuality of the core of all the Holocaust testimony, which after all does always make the same or at least similar claims.

But who decides, and on the basis of what rules, where the rotten shell of eyewitness testimony ends and where its sound core begins?

How do these experts explain away the fact that all the horror stories circulated by the Allies in the First World War were pure invention: nuns' breasts cut off, civilians nailed to barn doors, children's hands chopped off, fallen soldiers processed into soap,<sup>351</sup> mass gassing of Serbs in gas chambers, etc.?<sup>352</sup>

How do they explain away that the following horror scenarios of the Second World War were nothing more than atrocity lies invented by the Allies and their confederates: conveyor-belt executions, conveyor-belt electrocutions, cremations in blast furnaces, murders by means of exposure to vacuum and steam,<sup>353</sup> puddles of pooling fat at open-air cremations, the smoke-filled black air re-

---

Wannsee Conference, liberation of concentration camps) and at special places (memorial site Plötzensee, concentration camp Auschwitz, Babi Yar), pilgrimages of school and youth groups to concentration camps.

<sup>346</sup> In this case: the never-ending litany, in thousands of variations, of the unparalleled and unforgettable nature of German crimes, as well as their graphically detailed description.

<sup>347</sup> In this case: horror photos and movies, regardless whether they be genuine, falsified or “*creatively re-enacted*”, as well as the incessant, uncritical presentation of atrocity reports and testimony, combine to eliminate the public's critical faculties and result in indiscriminating, deeply emotional consternation and in hatred of everything and everyone who would differ. For example, H. Lichtenstein, *Aus Politik und Zeitgeschichte* 31(9-10) (1981) pp. 3-13, reports that prior to the Majdanek Trial young people wanted to have an end to the NS-trials of now-elderly men, but changed their minds after hearing the incredible atrocities alleged by witnesses for the prosecution and supported instead the perpetuation of criminal prosecution to eternity: p. 12; cf. also C. Schatzker's demand for traumatization, *op. cit.* (note 264).

<sup>348</sup> R. Bender, S. Röder, A. Nack, *op. cit.* (note 6), v. 1, pp. 44f.

<sup>349</sup> E.g., J.-C. Pressac, *Les Crématoires d'Auschwitz – la Machinerie du meurtre de masse*, CNRS, Paris 1993, p. 2; cf. also A. J. Mayer, *Why did the Heavens not darken?*, Pantheon Books, New York 1988, pp. 362-365; J. Baynac, *Le Nouveau Quotidien* (Geneva), September 2/3, 1996, pp. 16/14; cf. R. Faurisson “*Keine Beweise für Nazi-Gaskammern!*”, *VffG* 1(2) (1997) pp. 19ff. (online: [vho.org/VffG/1997/1/FauBay1.html](http://vho.org/VffG/1997/1/FauBay1.html)).

<sup>350</sup> E. Nolte, *op. cit.* (note 2), p. 310; similarly, J.-C. Pressac, *op. cit.* (note 17), pp. 126ff.

<sup>351</sup> Cf. A. Ponsonby, *Falsehood in Wartime: Propaganda Lies of the First World War*, Institute for Historical Review, Newport Beach, CA 1991.

<sup>352</sup> “*Atrocities in Serbia. 700,000 Victims*”, *The Daily Telegraph*, March 22, 1916, p. 7; cf. nearly the same article, now about Jews in Poland: “*Germans Murder 700,000 Jews in Poland*”, *The Daily Telegraph*, June 25, 1942, p. 5 (online: [vho.org/D/vuez/v6.html#v6\\_9](http://vho.org/D/vuez/v6.html#v6_9)).

<sup>353</sup> Cf. the examples listed in the following, as well as a summary by C. Mattogno, *Annales d'Histoire Révisionniste* 1 (1987) pp. 15-107, esp. pp. 91ff. (online: [abbc.com/aaargh/fran/archVT/AHR/AHR1/Mattogno/CMextern1.html](http://abbc.com/aaargh/fran/archVT/AHR/AHR1/Mattogno/CMextern1.html))



sulting therefrom, mass graves squirting geysers of blood, soap from human fat, lampshades from human skin, shrunken heads from the bodies of inmates, etc.<sup>354</sup>

Furthermore, it is a known fact today that the horror scenarios of mass gassings – allegedly carried out with Zyklon B or Diesel exhaust gas – in the concentration camps of the German Reich proper (e.g., Dachau, Sachsenhausen, Buchenwald, Bergen-Belsen) were nothing other than utter lies, invented or at least supported by Germany’s democratic western friends. What reasons can our historians come up with that would justify declaring as ‘uninventable’ sterling truth the identical or similar tales of mass gassings with Zyklon B or Diesel exhaust in the former Communist, dictatorial Eastern Bloc, which was certainly not very kindly disposed towards Germany?

And how, finally, do these experts explain away the inconsistencies which the present volume points out between the material evidence and eyewitness testimony in fundamental core aspects of the Holocaust?

It may be true that most witness statements contain a core of truth, but this core cannot be defined by assigning it in true democratic fashion to the weighted mean of overall testimony. The impossible remains impossible even if the vast majority of witnesses alleges the contrary.

## 6. Examples of Absurd Claims Regarding the Alleged National Socialist Genocide<sup>355</sup>

- child surviving six gassings in a gas chamber that never existed;<sup>356</sup>
- woman survived three gassings because Nazis kept running out of gas;<sup>357</sup>
- fairy tale of a bear and an eagle in a cage, eating one Jew per day;<sup>358</sup>
- mass graves expelling geysers of blood;<sup>359</sup>
- erupting and exploding mass graves;<sup>360</sup>
- soap production from human fat with imprint “*RIF*” – ‘Reine Juden Seife’ (pure Jewish soap), solemn burial of soap;<sup>361</sup>

<sup>354</sup> Aside from the list at the end of this chapter, cf. U. Walendy, *Historische Tatsachen*, Nos. 22 and 43, Verlag für Volkstum und Zeitgeschichtsforschung, Vlotho 1984 and 1990, also containing further references; A. L. Smith, *op. cit.* (note 42).

<sup>355</sup> Thanks to Jeff Roberts, Greg Raven, Orest Slepokura, Ted O’Keefe, Art Butz, Carlos Porter, Tom Moran, Jonnie A. Hargis and Joseph Bellinger for assisting me in completing this list; more can be found at [www.corax.org/revisionism/nonsense/nonsense.html](http://www.corax.org/revisionism/nonsense/nonsense.html) and [www.cwporter.co.uk/partone.htm](http://www.cwporter.co.uk/partone.htm).

<sup>356</sup> Moshe Peer, regarding Bergen-Belsen, in K. Seidman, “*Surviving the horror*”, *The Gazette* (Montreal, Canada), August 5, 1993. Facsimile reprint in *JHR*, 13(6) (1993), p. 24.

<sup>357</sup> *Montreal Gazette*, February 10, 2000.

<sup>358</sup> Morris Hubert about Buchenwald, acc. to Ari L. Goldman, “*Time ‘Too Painful’ to Remember*”, *New York Times*, November 10, 1988: “*In the camp there was a cage with a bear and an eagle,’ he said. ‘Every day, they would throw a Jew in there. The bear would tear him apart and the eagle would pick at his bones.’”*

<sup>359</sup> A. Rückerl, *op. cit.* (note 144), p. 273f.; E. Wiesel, *Paroles d’Etranger*, Edition du Seuil, Paris 1982, p. 86; Wiesel, *The Jews of Silence*, New American Library, New York 1972, p. 48; A. Eichmann, in H. Arendt, *op. cit.* (note 182), p. 184; B. Naumann, *op. cit.* (note 145), p. 214.

<sup>360</sup> Michael A. Musmanno, *The Eichmann Kommandos*, Peter Davies, London 1962, pp. 152f.

<sup>361</sup> This imprint really meant “*Reichsstelle für Industrielle Fettversorgung*” (Imperial Office for Industrial Fat Supplies), see S. Wiesenthal, *Der neue Weg* (Vienna), 15/16 & 17/18, 1946; Career affidavit of SS-Hauptsturmführer Dr. Konrad Morgen, National Archives, Record Group 28, No 5741, Office of Chief Counsel for War Crimes, December 19, 1947; Filip Friedman, *This Was Oswiecim. The Story of a Murder Camp*, United Jewish Relief Appeal, London 1946; the Soviets wanted to make this one of the charges at the IMT (exhibit USSR-393), but this plan failed due to the other Allies; *IMT*, *op. cit.* (note. 127), v. VII, pp. 597-600; cf. H. Härtle, *Freispruch für Deutschland*, Schütz, Göttingen 1965, pp. 126ff.; the Greenwood Cemetery in Atlanta (Georgia, USA) is not the only site to boast a Holocaust-memorial gravestone for 4 bars of “*Jewish soap*”. Cf. also the following corrections: R. Harwood, D. Felderer, *JHR* 1(2) (1980) pp. 131-139 (online: [vho.org/GB/Journals/JHR/1/2/HarwoodFelderer131-139.html](http://vho.org/GB/Journals/JHR/1/2/HarwoodFelderer131-139.html)) ; M. Weber, *JHR* 11(2)

- the SS made sausage in the crematoria out of human flesh (‘RIW’– ‘Reine Juden Wurst?’);<sup>362</sup>
- lampshades, book covers, driving gloves for SS officers, saddles, riding breeches, house slippers, and ladies handbags of human skin;<sup>363</sup>
- pornographic pictures on canvasses made of human skin;<sup>364</sup>
- mummified human thumbs were used as light switches in the house of Ilse Koch, wife of KL commander Koch (Buchenwald);<sup>365</sup>
- production of shrunken heads from bodies of inmates;<sup>366</sup>
- acid or boiling-water baths to produce human skeletons;<sup>367</sup>
- muscles cut from the legs of executed inmates contracted so strongly that they made the buckets jump about;<sup>368</sup>
- an SS-father potshooting babies thrown into the air while 9-year old SS-daughter applauds and shrieks: “*Papa, do it again; do it again, Papa!*”<sup>369</sup>
- Jewish children used by Hitler-Youth for target practice;<sup>370</sup>
- wagons disappearing on an incline into the underground crematoria in Auschwitz (such facilities never existed);<sup>371</sup>
- forcing prisoners to lick stairs clean, and collect garbage with their lips;<sup>372</sup>
- injections into the eyes of inmates to change their eye color;<sup>373</sup>
- first artificially fertilize women at Auschwitz, then gas them;<sup>374</sup>
- torturing people in specially mass-produced “*torture boxes*” made by Krupp;<sup>375</sup>
- torturing people by shooting at them with wooden bullets to make them talk;<sup>376</sup>
- smacking people with special spanking machines;<sup>377</sup>
- killing by drinking a glass of liquid hydrogen cyanide (which, scientifically considered, evaporates quickly and would endanger those who pouring it into said glass);<sup>378</sup>
- killing people with poisoned soft drinks;<sup>379</sup>

(1991) pp. 217-227 (online: [.../11/2/Weber217-227.html](http://11/2/Weber217-227.html)); R. Faurisson, “*Le savon Juif*”, *Annales d’histoire révisionniste*, 1 (1987), pp. 153-159 (online: [abbc.com/aaargh/fran/archFaur/1986-1990/RF8703xx3.html](http://abbc.com/aaargh/fran/archFaur/1986-1990/RF8703xx3.html)).

<sup>362</sup> David Olère, in J.-C. Pressac, *op. cit.* (note 17), p. 554, fourth column, lines 17-22.

<sup>363</sup> *IMT, op. cit.* (note. 127), v. XXXII, pp. 258, 259, 261, 263, 265, v. III, p. 515; v. XXX, pp. 352, 355; v. VI, p. 311; v. V, p. 171.

<sup>364</sup> *Ibid.*, v. XXX, p. 469.

<sup>365</sup> Kurt Glass, *New York Times*, April 10. 1995.

<sup>366</sup> H. Langbein, *Menschen in Auschwitz, op. cit.* (note 155), p. 381; *IMT, op. cit.* (note. 127), v. III, p. 516, v. XXXII, p. 267-271.

<sup>367</sup> F. Müller, in H. Langbein, *op. cit.* (note 154), v. 1, p. 87; witness Wells in the Eichmann Trial, in F. J. Scheidl, *op. cit.* (note 77), v. 4, p. 236; Lawrence L. Lange, “*Pre-empting the Holocaust*”, *The Atlantic Monthly*, November 1998, p. 107.

<sup>368</sup> F. Müller, *op. cit.* (note 395), p. 74.

<sup>369</sup> *IMT, op. cit.* (note. 127), v. VII, p. 451.

<sup>370</sup> *Ibid.*, p. 447f.

<sup>371</sup> SS-judge Konrad Morgen, acc. to Danuta Czech, *Auschwitz Chronicle, 1939-1945*, Henry Holt, New York, 1990, p. 818.

<sup>372</sup> *IMT, op. cit.* (note. 127), v. VII, p. 491.

<sup>373</sup> H. Langbein, *Menschen in Auschwitz, op. cit.* (note 155), pp. 383f.

<sup>374</sup> *IMT, op. cit.* (note. 127), v. V, p. 403.

<sup>375</sup> *Ibid.*, v. XVI, pp. 556f.; v. XVI, pp. 561, 546.

<sup>376</sup> World Jewish Congress *et al.* (eds.), *The Black Book: The Nazi Crime Against the Jewish People*, New York 1946, p. 269.

<sup>377</sup> *IMT, op. cit.* (note. 127), v. VI, p. 213.

<sup>378</sup> Verdict of the Hannover District Court, Ref. 2 Ks 1/60; cf. H. Lichtenstein, *op. cit.* (note 88), p. 83.

<sup>379</sup> *IMT, op. cit.* (note. 127), v. VII, p. 570.

- underground mass extermination in enormous rooms, by means of high voltage electricity;<sup>380</sup>
- blast 20,000 Jews into the twilight zone with atomic bombs;<sup>381</sup>
- killing in vacuum chamber, hot steam or chlorine gas;<sup>382</sup>
- mass murder in hot steam chamber;<sup>383</sup>
- mass murder by tree cutting: forcing people to climb trees, then cutting the trees down;<sup>384</sup>
- killing a boy by forcing him to eat sand;<sup>385</sup>
- gassing Soviet POWs in a quarry;<sup>386</sup>
- gas chambers on wheels in Treblinka, which dumped their victims directly into burning pits; delayed-action poison gas that allowed the victims to leave the gas chambers and walk to the mass graves by themselves;<sup>387</sup>
- rapid-construction portable gas chamber sheds;<sup>388</sup>
- beating people to death, then carrying out autopsies to see why they died;<sup>389</sup>
- introduction of Zyklon gas into the gas chambers of Auschwitz through shower heads or from steel bottles;<sup>390</sup>
- electrical conveyor-belt executions;<sup>391</sup>
- bashing people's brains in with a pedal-driven brain-bashing machine while listening to the radio;<sup>392</sup>
- cremation of bodies in blast furnaces;<sup>393</sup>
- cremation of human bodies using no fuel at all;<sup>394</sup>
- skimming off boiling human fat from open-air cremation fires;<sup>395</sup>

<sup>380</sup> Aside from C. Mattogno, *op. cit.* (note 353), cf. esp. S. Szende, *Der letzte Jude aus Polen*, Europa-Verlag, Zürich 1945; S. Wiesenthal, *Der neue Weg* (Vienna), 19/20, 1946; *IMT, op. cit.* (note. 127), v. VII, 576-577, 369, for Bergen-Belsen!; *The Black Book of Polish Jewry*, Roy Publishers, New York 1943, p. 313.

<sup>381</sup> *IMT, op. cit.* (note. 127), v. XVI, p. 529

<sup>382</sup> Aside from C. Mattogno, *op. cit.* (note 353), cf. esp. W. Grossmann, *Die Hölle von Treblinka*, Verlag für fremdsprachige Literatur, Moscow 1947; *The Black Book of Polish Jewry, op. cit.* (note 380).

<sup>383</sup> *IMT, op. cit.* (note. 127), v. XXXII, pp. 153-158; M. Weber, A. Allen, *JHR* 12(2) (1992) pp. 133-158, here 134-136 (online: [who.org/GB/Journals/JHR/12/2/WeberAllen133-158.html](http://who.org/GB/Journals/JHR/12/2/WeberAllen133-158.html)).

<sup>384</sup> *IMT, op. cit.* (note. 127), v. VII, p. 582; Eugen Kogon, *The Theory and Practice of Hell*, Berkley Medallion (NY) 1960, p. 99

<sup>385</sup> Rudolf Reder, *Belzec*, Kraków 1946, p. 16; found in Martin Gilbert, *The Holocaust*, Holt, Rinehart and Winston, New York 1985, p. 419.

<sup>386</sup> *IMT, op. cit.* (note. 127), v. VII, p. 388.

<sup>387</sup> Reports of the Polish underground movement, *Archiv der Polnischen Vereinigten Arbeiterpartei*, 202/III, v. 7, pp. 120f., quoted in P. Longerich, *op. cit.* (note 285), p. 438.

<sup>388</sup> R. Aschenauer (ed.), *Ich, Adolf Eichmann*, Druffel, Leoni 1980, pp. 179f.

<sup>389</sup> *IMT, op. cit.* (note. 127), v. V, p. 199.

<sup>390</sup> M. Scheckter and a report of June 4, 1945, written by an officer of the 2<sup>nd</sup> Armored Division, about Auschwitz; *Französisches Büro des Informationsdienstes über Kriegsverbrechen* (ed.), *op. cit.* (note 395), p. 184, Wolfgang Benz, (ed.), *Dimension des Völkermords*, Oldenbourg, Munich 1991, p. 462.

<sup>391</sup> *Pravda*, Feb. 2, 1945, cf. U. Walendy, *Historische Tatsachen* No. 31: "Die Befreiung von Auschwitz 1945", Verlag für Volkstum und Zeitgeschichtsforschung, Vlotho 1987, p. 4.

<sup>392</sup> *IMT, op. cit.* (note. 127), v. VII, pp. 376f.

<sup>393</sup> H. von Moltke, *Briefe an Freya 1939-1945*, Beck, Munich 1988, p. 420; cf. P. Longerich (ed.), *op. cit.* (note 285), p. 435; *Pravda*, Feb. 2, 1945.

<sup>394</sup> See Arnulf Neumaier's article in this handbook; *IMT, op. cit.* (note. 127), v. XX, p. 494.

<sup>395</sup> R. Höß, in M. Broszat (ed.), *op. cit.* (note 74), p. 130; H. Tauber, in J.-C. Pressac, *op. cit.* (note 17), pp. 489f.; F. Müller, *Sonderbehandlung*, Steinhausen, Munich 1979, pp. 207f., 217ff.; H. Langbein, *Menschen in Auschwitz, op. cit.* (note 155), p. 148; B. Naumann, *op. cit.* (note 145), pp. 10, 334f., 443; S. Steinberg, according to *Französisches Büro des Informationsdienstes über Kriegsverbrechen* (ed.), *Konzentrationslager Dokument 321*, Reprint 2001, Frankfurt/Main 1993, p. 206; and many more.

- mass graves containing hundreds of thousands of bodies, removed without a trace within a few weeks; a true miracle of improvisation on the part of the Germans;<sup>396</sup>
- killing 840,000 Russian POWs at Sachsenhausen, and burning the bodies in 4 portable ovens;<sup>397</sup>
- removal of corpses by means of blasting, *i.e.*, blowing them up;<sup>398</sup>
- SS bicycle races in the gas chamber of Birkenau;<sup>399</sup>
- out of pity for complete strangers – a Jewish mother and her child – an SS-man leaps into the gas chamber voluntarily at the last second in order to die with them;<sup>400</sup>
- blue haze after gassing with hydrogen cyanide (which is colorless);<sup>401</sup>
- singing of national anthems and the Communist International by the victims in the gas chamber; evidence of atrocity propaganda of Communist origin;<sup>402</sup>
- a twelve-year old boy giving an impressive and heroic speech in front of the other camp children before being ‘gassed’;<sup>403</sup>
- filling the mouths of victims with cement to prevent them from singing patriotic or communist songs.<sup>404</sup>

---

<sup>396</sup> Aside from note 382, cf. also W. Benz, *Dimension des Völkermords*, Oldenbourg, Munich 1991; pp. 320, 469, 479, 489, 537ff.

<sup>397</sup> *IMT*, *op. cit.* (note. 127), v. VII, p. 586

<sup>398</sup> R. Höß, in M. Broszat (ed.), *op. cit.* (note 74), pp. 161f.; A. Rückerl, *NS-Prozesse*, *op. cit.* (note 131), p. 78; H. Grabitz, *NS-Prozesse...*, *op. cit.* (note 194), p. 28.

<sup>399</sup> *Nürnberger Nachrichten*, Sept. 11, 1978, report about eyewitness testimony in the jury court trial in Aschaffenburg.

<sup>400</sup> E. Bonhoeffer, *op. cit.* (note 216), pp. 48f.

<sup>401</sup> R. Böck, Frankfurt Public Prosecutor’s Office, Ref. 4 Js 444/59, pp. 6881f.

<sup>402</sup> H. G. Adler, H. Langbein, E. Lingens-Reiner (eds.), *Auschwitz – Zeugnisse und Berichte*, Europäische Verlagsanstalt, Cologne 1984, p. 76.

<sup>403</sup> Filip Friedman, *This Was Oswiecim. The Story of a Murder Camp*, United Jewish Relief Appeal, London 1946, p. 72

<sup>404</sup> *IMT*, *op. cit.* (note. 127), v. VII, p. 475



# Witnesses to the Gas Chambers of Auschwitz\*

ROBERT FAURISSON

## 1. Summary

Eyewitness testimony must always be verified. There are two essential means of verifying such testimony in criminal cases: confronting the account with the material elements (in particular, with expertise as to the crime weapon), and the detailed cross-examination of the witness on what he/she purports to have seen. Thus, in the proceedings where it had been a question of the homicidal gas chambers of Auschwitz, no judge nor any attorney was able to claim any kind of expertise regarding the weapon of the crime; moreover, no lawyer ever cross-examined the witnesses by asking them to describe with precision even one of these chemical slaughter-houses. That is, up until 1985. When witnesses that year were finally cross-examined on these subjects during the first Zündel trial in Toronto, their rout was total. Because of this resounding set-back and by reason of other calamities previous to or following 1985, the defenders of the thesis of Jewish extermination have begun to abandon a history of Auschwitz primarily founded on testimonies and are obliging themselves, at the present time, to replace it with a scientific basis, or, at least, one which appears scientific, founded on factual research and proofs. The 'testimonial history' of Auschwitz in the manner of Elie Wiesel and Claude Lanzmann is discredited. Its time has passed. It remains for the exterminationists to attempt to work like the Revisionists on the facts and the evidence.

In the present study, 'gas chambers' are intended to mean homicidal gas chambers, or 'Nazi gas chambers.' By 'Auschwitz', it is necessary to understand this as Auschwitz I or Auschwitz Stammlager, as well as Auschwitz II or Birkenau. Finally, by 'gas chamber witnesses', I am indiscriminately designating those who claim to have participated in a homicidal gassing operation at these locations and those who are content to say they either saw or perceived a homicidal gas chamber there. In sum, by 'witnesses', I mean those whom one usually designates as such, whether it is a matter of judicial witnesses or media witnesses; the first have expressed themselves under oath in the docket of a legal proceeding, while the second have given testimony in books, magazine articles, films, on television or the radio. It so happens certain witnesses have alternately been of both the judicial and media types.

This study is devoid of any psychological or sociological consideration for the Auschwitz gas chamber testimonies, as well as any consideration along the lines of what is physical, chemical, topographical, architectural, documentary, and historical by which these testimonies are unacceptable. It aims above all to make evident a point which the Revisionists have so far not mentioned but which is nonetheless of prime importance: up until 1985, no judicial witness of these gas chambers had been cross-examined on the material nature of the facts reported. When, in Toronto, at the first Zündel trial in 1985, I was able to cause such witnesses to be cross-examined, they collapsed; since this date, there are no longer any gas chamber witnesses presented in court except perhaps at the trial of Demjanjuk in Israel where, there again, the witnesses revealed themselves as false.<sup>1</sup>

---

\* This chapter was translated from the French original by Daniel D. Desjardins.

<sup>1</sup> Cf. E. Loftus, K. Ketcham, *Witness for defense*, St. Martin's Press, New York 1991, as well as the contribution of A. Neumaier in this volume (editor's note).

To begin, I will digress upon the grievous causes by which, since 1983, Simone Veil<sup>2</sup> was led to recognize that there existed no witnesses of the gas chambers.

## 2. The Thesis of Simone Veil

After the end of the war, the illusion that there were innumerable witnesses to the Auschwitz gas chambers was gradually accepted. By the end of the 1970s, with the arrival of historical revisionism into the media arena, particularly in France, it began to occur to certain individuals that these witnesses were perhaps not as numerous as one had believed. It is thus that, during the preparations for a major trial in which Jewish organizations had intended against me during the early 1980s, their lawyers and in particular, Robert Badinter, the future Minister of Justice, experienced severe difficulties uncovering evidence and witnesses. With staff in hand in the manner of the pilgrim, they were obliged to go to Poland and to Israel so as to bring back, if possible, that which they could not find in France. All for naught!

My first trial took place in 1981, followed by the appeal in 1983. Not one single witness took the risk of appearing in court. On April 26, 1983, the Paris Court of Appeal rendered its verdict. Naturally, I was found guilty, as one might have expected, for “*harm to others*” which is in fact to say for harm caused to Jews for the exposition of my theses in the mainstream press. Yet the court coupled this verdict with remarks sufficient to cause my adversaries a fair degree of consternation. My work was judged to be serious and yet dangerous. It was dangerous because, in the opinion of the judges, it appeared I allowed other persons the possibility of exploiting my discoveries for reprehensible ends! All the while, this same work was serious in the sense that, in the opinion of the court, one could uncover neither negligence, frivolousness, willful ignorance, nor lies – and this contrary to what had been affirmed by the adversarial party, which had accused me of “*causing harm to others by falsification of history.*” (sic)

On the subject of testimonies, the court went so far as to pronounce:

*“The researches of Mr. Faurisson have dealt with the existence of the gas chambers which, to believe multiple testimonies, would have been used during the Second World War to systematically put to death a portion of those persons deported by the German authorities.”* (my emphasis)

The court perfectly summarized what it called my “*logical thread*” and my “*reasoning*” by specifying that, for me,

*“[...] the existence of the gas chambers, such as usually described since 1945, conflict with an absolute impossibility, which suffices by itself to invalidate all the existing testimonies or, at the least, to stamp them with suspicion.”* (my emphasis)

Finally, the court, drawing a practical conclusion from these considerations, decreed the right of every Frenchman not to believe in the evidence and witnesses of the gas chambers. It stated:

*“The value of the conclusions defended by Mr. Faurisson [as to the problem of the gas chambers] rests therefore upon the sole appreciation of the experts, the historians and the public.”*

Two weeks later, Simone Veil publicly reacted to this judicial decision – upsetting for her and her co-religionists – with a declaration of extreme importance. She admitted the absence of proofs, of traces and even witnesses of the gas chambers, but added this absence was easily explained because:

*“Everyone knows [she asserts] that the Nazis destroyed these gas chambers and systematically eradicated all the witnesses.”*

To begin with, “*everyone knows*” is not an argument worthy of a jurist. Furthermore, Simone Veil, believing perhaps to be getting out from behind the eight-ball, made her case only worse; in effect, in

---

<sup>2</sup> S. Veil, maiden name Jacob, former President of the European Parliament, was interned in the concentration camp of Auschwitz in WWII, especially in subcamp Bobzek.

order to uphold what she was claiming, it would have been necessary for her to prove not only that the gas chambers had existed but that the ‘Nazis’ had destroyed them and that they liquidated all the witnesses: a vast criminal undertaking about which one wonders on what order, when, with whom and by what means the Germans would have carried it out in greatest secrecy.

But what does it matter? We shall take note of this concession by S. Veil: *there is neither proof, nor traces, nor witnesses to the gas chambers*. It so happens that, in trying to reassure her circle, S. Veil clothed this surprising concession with conventional parlance. Here is, therefore, in her own words, what she confided in an interview-event for *France-Soir Magazine* (May 7, 1983, p. 47), of which the title was: “*Simone Veil’s warning in regard to Hitler’s diaries: ‘We risk banalizing genocide’*”:

“*What strikes me nowadays is the paradox of the situation: someone publishes a diary attributed to Hitler by sheer dint of publicity and a great deal of money without, it seems, taking very great precautions to assure himself of its authenticity, yet, at the same time, in the course of a trial brought against Faurisson for having denied the existence of the gas chambers, those lodging the complaint are obliged to apply a formal proof about the reality of the gas chambers. Yet everyone knows that the Nazis destroyed these gas chambers and systematically eradicated all the witnesses.*”

A choice so full of consequences as that of S. Veil is not to be explained solely by the disaster of April 26, 1983, but by an entire series of events which, for her, made 1982 a dark year in terms of the history of the gas chambers and the credibility of witnesses. I will recall here but three of these events:

1. On April 21, 1982, historians, politicians and former deportees founded an association in Paris having as its objective the research of evidence for the existence and operation of the gas chambers (ASSAG: Association pour l’étude des assassinats par gaz sous le régime national-socialist; Association for the study of killings by gas under the national-socialist regime); one year later, this association had still not discovered any proof [this is still the case today, since, envisioned according to its own statutes for a “*duration limited to the realization of its objective*”, this association has not disbanded];
2. In May, 1982, the Minister for Veterans’ Affairs launched a noteworthy “*Deportation Exposition, 1933-1945*” in Paris; this exposition was supposed to continue by touring throughout France; I immediately sent out a text in which I demonstrated the fallacious character of this exposition: no evidence – except fraudulent evidence – nor any precise testimony for the existence of ‘Nazi gas chambers’ was able to be shown to visitors; additionally, Ms. Jacobs, the person responsible for this initiative by the Ministry, took it upon herself to immediately cancel this would-be vagabond exposition;
3. From June 29 to July 2, 1982, an international symposium was held at the Sorbonne on “*Nazi Germany and the extermination of the Jews*”. This colloquium had been announced as a decisive reply to the revisionist offensive in France; while it was supposed to have concluded with a resounding press conference, in reality, it was totally different. The first day of the proceedings, we distributed in the Sorbonne’s entrance hall recent copies of my *Response to Pierre Vidal-Naquet* (not without risk to ourselves).<sup>3</sup> The colloquium was carried out behind closed doors and in a turbulent atmosphere. Finally, during the press conference, the two colloquium organizers, historians François Furet and Raymond Aron, weren’t even mentioning the words ‘gas chamber(s).’

I often say it’s on this date of July 2, 1982, that the myth of the ‘Nazi gas chambers’ and their associated witnesses died or entered their final death throes, at least on the level of historical research. At the very heart of the Sorbonne, one had thus disconcertingly discovered the absence of any solid proof and any witness worthy of trust. Notwithstanding, one had previously trumpeted that this colloquium

<sup>3</sup> R. Faurisson, *Réponse à Pierre Vidal-Naquet*, La Vieille Taupe, Paris 1982; Engl.: “*Response to a Paper Historian*”, *The Journal of Historical Review*, Spring 1986, pp. 21-72.



would put an end to “*the ineptitude of Faurisson*” by bringing forth a mass of evidence and testimonies. Such a silence after all that fanfare was truly eloquent.

### 3. The Written Testimony of Fajnzylberg-Jankowski

I said earlier that at my trial not a single witness took the risk of appearing before the court. At the last minute, my accusers had nonetheless provided the written testimony of a Jew who was living in Paris but whom they intentionally kept from appearing in the dock. This Jew was the famous Alter Szmul Fajnzylberg, born in Stockek, Poland, October 23, 1911. This former Polish waiter, an atheistic Jew and Communist political delegate for the international brigades serving in Spain, had been imprisoned during a period of three years at Auschwitz-Birkenau.

In his brief written testimony, he essentially stated that, working in the Auschwitz crematory (the Altes Krematorium, or Krematorium I), he had spent a good deal of his time locked up with his comrades in the coke-room, for, on each occasion that the SS gassed Jews in the adjoining room, the SS took the precaution of sequestering the Sonderkommando in the coke-room so that no Jew might visibly confirm the gassing operation! Once the gassing operation was completed, the Germans freed the Sonderkommando members and made them collect and incinerate the victims. Thus, the Germans would have concealed the crime and yet revealed its results!

This unseeing witness is equally known by the names Alter Feinsilber, Stanislaw Jankowski or Kaskowiak. One can read his testimony in another form in the *Auschwitz Diaries*.<sup>4</sup>

### 4. The Unraveling of the Witnesses at the First Zündel Trial (1985)

The important victory won by revisionism in France on April 26, 1983, would go on to confirm itself in 1985 with the first Zündel trial in Toronto. I would like to dwell a moment on this trial in order to underscore the impact on one’s point of view, and especially as far as the testimonies on the Auschwitz gas chambers are concerned: *for the first time since the war, Jewish witnesses were subjected to a regular cross-examination*. Moreover, without wanting to minimize the importance of the second Zündel trial (that of 1988), I should like it to be understood that the 1985 trial already contained the seeds for all that was attained in the 1988 trial, including the report by Leuchter and all the scientific reports which, in the aftermath, would proliferate in the wake of the *Leuchter Report*.

In 1985, as also afterwards in 1988, I served as advisor to Ernst Zündel and his lawyer, Douglas Christie. I accepted this heavy responsibility only under condition that all the Jewish witnesses would, for the first time, be *cross-examined on the material nature of the reported facts, bluntly and without discretion*. I had noted, in effect, that from 1945 to 1985, Jewish witnesses had been granted virtual immunity. Never had any defense lawyer thought or dared to ask them for material explanations about the gas chambers (exact location, physical appearance, dimensions, internal and external structure), or about the homicidal gassing (the operational procedure from beginning to end, the tools employed, the precautions taken by the executioners before, during and after execution).

On rare occasions, as at the trial of Tesch, Drosihn and Weinbacher,<sup>5</sup> lawyers formulated some unusual questions of a material nature, hardly troublesome for the witness, but these always found them-

---

<sup>4</sup> “*Handschriften von Mitgliedern des Sonderkommandos*”, in *Hefte von Auschwitz*, Sonderheft (I), Verlag Staatliches Auschwitz-Museum, Auschwitz 1972, pp. 32-71.

<sup>5</sup> On the cross-examination of the witness Dr. Charles Sigismund Bendel by attorney Dr. Zippel, see “*Excerpt from transcript of proceedings of a Military Court for the Trial of War Criminals held at the War Crimes Court, Curiohaus, Hamburg, on Saturday 2<sup>nd</sup> March, 1946, upon the trial of Bruno Tesch, Joachim Drosihn and Karl Weinbacher*”, transcript, pp. 30-31 (doc. NI-11953). Regarding this abominable trial, it is indispensable to read: Dr. William Lindsey, “*Zyklon B, Auschwitz, and the Trial of Bruno Tesch*”, *The Journal of Historical Review*, 4(3) (1983),

selves on the fringes of the more fundamental questions which should have been asked. No lawyer ever demanded clarifications on a weapon which, indeed, he had never seen and that no one had ever shown him. At the major Nuremberg Trial of 1945-46, the German lawyers had manifested total discretion on this point. At the proceedings against Eichmann in Jerusalem in 1961, the lawyer Dr. Robert Servatius had not wanted to raise the question; in a letter on this subject dated June 21, 1974, he wrote me: "*Eichmann hat selbst keine Gaskammer gesehen; die Frage wurde nicht diskutiert; er hat sich aber auch nicht gegen deren Existenz gewandt*" [Eichmann himself had not seen any gas chamber; the question was not discussed; but neither did he raise the issue of their existence].<sup>6</sup>

At the Frankfurt Trial of 1963-65, the lawyers showed themselves to be particularly timid. I should mention that the atmosphere was rather inhospitable for the defense and the accused. This show trial will remain as a blot on the honor of German justice as on the person of Hans Hofmeyer, initially Landgerichtsdirektor, then Senatspräsident. During more than 180 sessions, the judges and juries, the public prosecutors and the private parties, the accused and their attorneys, as well as the journalists who had come from around the world, accepted as a complete physical representation of the 'crime weapon' a mere map of the camp of Auschwitz and a map of the camp of Birkenau, whereupon five minuscule geometric figures were inscribed for the location of each of the alleged homicidal gas chambers, with the words, for Auschwitz: "*Altes Krematorium*", and for Birkenau: "*Krematorium II*", "*Krematorium III*", "*Krematorium IV*", and "*Krematorium V*"! These maps<sup>7</sup> were displayed in the courtroom.

The Revisionists have often compared the Frankfurt trial with the 1450-1650 trials against witchcraft. Nevertheless, at least during those trials, someone sometimes bothered to describe or depict the witches' sabbath. At the Frankfurt trial, even among the lawyers who made difficulties for a witness like Filip Müller, not one asked of a Jewish witness or a repentant German defendant to describe for him in greater detail what he was purported to have seen. Despite two judicial visits to the scene of the crime at Auschwitz, accompanied by some German lawyers, it seems not one of the latter insisted on any technical explanations or criminological expertise regarding the murder weapon. To the contrary, one of them, Anton Reiners, a Frankfurt lawyer, pushed complacency to the point of having himself photographed by the press while raising the chute cover by which the SS supposedly sprinkled Zyklon B granules into the alleged Auschwitz gas chamber.

And so at Toronto in 1985, I had fully decided to do away with these anomalies, to break the taboo and, for starters, pose, or rather have Douglas Christie pose, questions to the experts and Jewish witnesses as one normally poses in every trial where one is supposed to establish whether a crime has been committed and, if so, by whom, how and when.

---

pp. 261-303 (online: [vho.org/GB/Journals/JHR/4/3/Lindsey261-303.html](http://vho.org/GB/Journals/JHR/4/3/Lindsey261-303.html)). This study has been reproduced in part by Udo Walendy in *Historische Tatsachen*, Nr. 25 (1985), pp. 10-23.

<sup>6</sup> While waiting for his trial in Jerusalem, Eichmann, in his cell, was fed like a Christmas goose. He ended up no longer knowing what he had heard, what he had seen, what he had read. Here, for example, is a very important passage from his interrogation by the Israeli government commissioner regarding the 'gas chambers' directly from Transcripts, J1-MJ at 02-RM:

"The Commissioner: *Did you talk with Höß about the number of Jews who were exterminated at Auschwitz?*  
Eichmann: *No, never. He told me that he had built new buildings and that he could put to death ten thousand Jews each day. I do remember something like that. I do not know whether I am only imagining that today, but I do not believe I am imagining it. I cannot recall exactly when and how he told me that and the location where he told me. Perhaps I read it and perhaps I am now imagining what I had read I heard from him. That is also possible.*"

<sup>7</sup> For a representation of these two maps, see Hermann Langbein, *Der Auschwitz-Prozess, Eine Dokumentation*, 2 vol., Europäische Verlagsanstalt, Frankfurt 1965, 1027 p., pp. 930-933. For an authoritative study of the trial, see Dr. Wilhelm Stäglich, *Der Auschwitz-Prozess, Legende oder Wirklichkeit? Eine kritische Bestandsaufnahme*, Grabert Verlag, Tübingen 1979, XII-492 pp. (online: [vho.org/D/dam](http://vho.org/D/dam)).

Fortunately for me, Ernst Zündel accepted my conditions and Douglas Christie consented to adopt this course of action and to pose to the experts and witnesses the questions that I would prepare for him. I was convinced that, in this manner, all might change, and the veil woven by so many false testimonies could be torn away. While I was not counting on Ernst Zündel's acquittal and we were all resigned to paying the price for our audacity, I nevertheless had hope that with the aid of this far-sighted man of character, and thanks to his intrepid lawyer, history, if not justice, would at last carry him into historical prominence.

From the moment of the first cross-examination, a tremor of panic began to creep its way amid the ranks of the prosecution. Every evening and throughout most of the night, I would prepare the questions to ask. In the morning, I would turn over these questions, accompanied by the necessary documents, to lawyer Doug Christie who, for his part and with the aid of his female collaborator, conducted the essentially legal aspects of the effort. During the cross-examinations, I maintained a position close to the lawyer's podium and unremittingly furnished, on yellow notepads, supplementary and improvisational questions according to the experts' and witnesses' responses.

The expert cited by the prosecution was Dr. Raul Hilberg, author of *The Destruction of European Jews*. Day after day, he was subjected to such humiliation that, when solicited in 1988 by a new prosecutor for a new trial against Ernst Zündel, Prof. Hilberg refused to return to give witness; he explained the motive for his refusal in a confidential letter wherein he acknowledged his fear of having to once again confront the questions of Douglas Christie. From the cross-examination of Dr. Raul Hilberg, it was definitively brought out that no one possessed any proof for the existence either of an order, a plan, an instruction, or a budget for the presumed physical extermination of the Jews. Furthermore, no one possessed either an expertise of the murder weapon (whether gas chamber or gas van), or an autopsy report establishing the murder of a detainee by poison gas. However, in the absence of evidence regarding the weapon and victim, did there exist witnesses of the crime?

A testimony must always be verified. The usual first means of proceeding to this verification is to confront the assertions of the witness with the results of investigations or expert opinion regarding the material nature of the crime. In the case at hand, there were neither investigations, nor expertise relative to the alleged Auschwitz gas chambers. Here is what made any cross-examination difficult. Yet, this difficulty should not serve as an excuse, and one might even say that a cross-examination becomes ever more indispensable because, without it, there no longer remains any way of knowing whether the witness is telling the truth or not.

## 5. Jewish Witnesses Finally Cross-Examined: Arnold Friedman and Dr. Rudolf Vrba

For those persons interested in the technical and documentary means by which we were nevertheless in a position to severely cross-examine the two principal Jewish witnesses, Arnold Friedman and Dr. Rudolf Vrba, I can do no better than to recommend a reading of the trial transcript.<sup>8</sup> Pages 304-371 cover the questioning and cross-examination of Arnold Friedman; the latter breaks down on pages 445-446 when he ends by acknowledging that he in fact saw nothing, that he had spoken from hearsay because, according to him, he had met persons who were convincing; perhaps, he added, he would have adopted the position of Mr. Christie rather than that of these other persons if only Mr. Christie had been able to tell him back then what he was telling him now!

Dr. Vrba was a witness of exceptional importance. One might even say about this trial in Toronto that the prosecution had found the means of recruiting 'Holocaust' expert number one in the person of Dr. Raul Hilberg, and witness number one in the person of Dr. Rudolf Vrba. The testimony of this latter

---

<sup>8</sup> *Queen versus Zündel*, Toronto, Ontario, Canada, beginning January 7, 1985.

gentleman had been one of the principal sources of the famous *War Refugee Board Report on the German Extermination Camps – Auschwitz and Birkenau*, published in November 1944 by the Executive Office of President Roosevelt. Dr. R. Vrba was also the author of *I Cannot Forgive*,<sup>9</sup> written in collaboration with Alan Bestic who, in his preface, declares with regard to him:

*“Indeed I would like to pay tribute to him for the immense trouble he took over every detail; for the meticulous, almost fanatical respect he revealed for accuracy.”* (p.2).

Never perhaps, had a court of justice seen a witness express himself with more assurance on the Auschwitz gas chambers. Yet, by the end of the cross-examination, the situation had reversed itself to the point where Dr. R. Vrba was left with only one explanation for his errors and his lies: in his book he had, he confessed, resorted to “*poetic license*” or, as he was wont to say in Latin, to “*licentia poetarum*”!

In the end, a bit of drama unfolded: Mr. Griffiths, the prosecutor who had himself solicited the presence of this witness *numero uno* and yet now apparently exasperated by Dr. Vrba’s lies, fired off the following question:

*“You told Mr. Christie several times in discussing your book I Cannot Forgive that you used poetic license in writing that book. Have you used poetic license in your testimony?”* (p. 1636).

The false witness tried to parry the blow but prosecutor Griffiths hit him with a second question equally treacherous, this time concerning the number of gassing victims which Vrba had given; the witness responded with garrulous nonsense; Griffiths was getting ready to ask him a third and final question when suddenly, the matter was cut short and one heard the prosecutor say to the judge:

*“I have no further questions for Dr. Vrba”* (p. 1643).

Crestfallen, the witness left the dock. Dr. Vrba’s initial questioning, cross-examination and final questioning filled 400 pages of transcripts (pp. 1244-1643). These pages could readily be used in an encyclopedia of law under a chapter on the detection of false witnesses.

## 6. The Prosecution Gives up on Calling Witnesses

Three years later, in 1988, during the second trial against Ernst Zündel, the public prosecutor deemed it prudent to abandon any recourse to witnesses. Canadian justice had apparently understood the lesson of the first trial: there were no credible witnesses to the existence and operation of the ‘Nazi gas chambers’.

Little by little, every other country in the world has learned this same lesson. At the trial of Klaus Barbie in France, in 1987, there was talk about the gas chambers of Auschwitz but no one produced any witnesses who could properly speak about them.<sup>10</sup> The attorney Jacques Vergès, courageous yet not foolhardy, preferred to avoid the subject. This was a stroke of luck for the Jewish lawyers who feared nothing so much as to see me appearing at the side of Mr. Vergès. If this gentleman had accepted my offer to counsel him, we in France might have been able to strike a tremendous blow against the myth of the gas chambers.

All the while in France, during several revisionist trials, Jewish witnesses sometimes came to evoke the gas chambers but none of them testified before the court as to having seen one or having participated in a homicidal gassing by hauling bodies out of the ‘gas chambers’.

Today, gas chamber witnesses are making themselves extremely scarce and the Demjanjuk trial in Israel, which once again has revealed how much false testimony is involved in the matter, has contributed to the suppression. Several years ago, it happened that I was aggressively questioned at the rear of a

<sup>9</sup> Bantam Books, New York 1964.

<sup>10</sup> During the trial against Gottfried Weise in 1988 in Wuppertal (Germany), gas chambers were not mentioned, cf. the contribution of C. Jordan in this book (editor’s note).

law court by elderly Jews who presented themselves as “*living witnesses to the gas chambers of Auschwitz*”, showing me their tattoos. It was necessary for me only to ask them to look me in the eyes and to describe for me a gas chamber that inevitably they retorted:

“*How could I do this? If I had seen a gas chamber with my own eyes I would not be here today to speak with you; I myself would have been gassed also.*”

This brings us back, as one can see, to Simone Veil and her declaration of May 7, 1983, about which we already know what we should think.

## 7. The Media Witnesses

Aside from the judicial witnesses, there are media witnesses to the gas chambers, or homicidal gassing, at Auschwitz or Birkenau. Here one thinks of the names of Olga Lengyel, Gisela Perl, Fania Fénelon, Ota Kraus, Erich Kulka, Hermann Langbein, André Lettich, Samuel Pisar, Maurice Benroubi, André Rogerie, Robert Clary, ... My library is full of these accounts which duplicate themselves over and over. Paul Rassinier was the first to show us in what manner the falsehood of these testimonies might be demonstrated; he did this notably for Auschwitz in *Le Véritable Procès Eichmann ou les Vainqueurs incorrigibles (The True Eichmann Trial or, the Incurable Victors)*, where Appendix V is devoted to *Médecin à Auschwitz (Doctor at Auschwitz)* regarding Miklos Nyiszli.<sup>11</sup>

From the 1950s to the 1980s, the Revisionists found merit in undertaking studies critical of testimonies. Nowadays, it seems to me this exercise has become superfluous. Let us abstain from chasing after ambulances and instead leave the care of criticizing this sub-literature to the Exterminationists themselves, and in particular Jean-Claude Pressac, because – so far as one can determine at present – the most virulent anti-Revisionists end by putting themselves into the school of the Revisionists. The result is sometimes rife with pungency. In October 1991, the periodical *Le Déporté pour la liberté (Deportee for Liberty)*, an organ of l’Union nationale des associations de déportés, internés et familles de disparus (UNADIF; National Union of Associations of Deportees, Prisoners and Families of the Missing), announced on its cover-page:

“*In the inner pages of this issue, part one of the testimony of Henry Bily, one of the rare escapees from a Sonderkommando.*”

In his follow-up of November 1991, Mr. Bily continued the account of his Auschwitz experience under the title of “*Mon histoire extraordinaire*” (My Amazing Story).

However, in the following installment of *Déporté pour la liberté*, that of December 1991-January 1992, there appeared a “*Clarification regarding insertion of the text of Henry Bily in our columns.*” The review’s director and editor uncovered the falsehood: in the major portion of his testimony, Mr. Bily had proceeded to:

“*copy word for word without any citation of references, from passages (notably chapters 7 and 28) of the book by Dr. Myklos Nyiszli: Médecin à Auschwitz, written in 1946 and translated and published in 1961 by René Julliard publishing house. Unfortunately, the original errors committed by Dr. Nyiszli have also been repeated; finally, the most extensive borrowing has to do with the description of the Sonderkommando functions at Auschwitz-Birkenau, in which Henry Bily declares [deceivingly] to have worked... The result of this analysis is that it is in no way possible to consider Henry Bily’s text as an original and personal testimony.*”

To an attentive reader of this declaration, the sentence “*Unfortunately, the original errors committed by Dr. Nyiszli have also been repeated*” might allow one to perceive that, worst of all, Mr. Bily, a petty Jewish tradesman, had recopied a testimony which itself had already been false. As I have recently mentioned, Paul Rassinier had long ago proved that *Médecin à Auschwitz*, a work dear to Jean-Paul

---

<sup>11</sup> Les Sept Couleurs, Paris 1962.

Sartre who in 1951 published parts of it in *les Temps modernes*, could only be one of the greatest impostures. Many Revisionists, and in particular Carlo Mattogno,<sup>12</sup> have since confirmed this assessment. As for me, in my report regarding Jean-Claude Pressac's book *Auschwitz: Technique and Operation of the Gas Chambers*,<sup>13</sup> I have inserted a section entitled: "Pressac's Involuntary Comedy Apropos M. Nyiszli." I recommend the reading of this section to people interested in false testimonies on Auschwitz, false testimonies which pharmacist J.-C. Pressac tries to defend at any price by way of convolutions, laborious inventions and flighty speculations, thus unintentionally discrediting them once and for all.<sup>14</sup>

## 8. False Witnesses Elie Wiesel and Primo Levi

A few words force themselves to our attention in regard to Elie Wiesel and Primo Levi.

Regarding the former, I come back to my article "Un grand faux témoin: Elie Wiesel".<sup>15</sup> In *Night*,<sup>16</sup> a biographical account particularly regarding his internment at Auschwitz and Buchenwald, Mr. Wiesel does not even mention the gas chambers but it appears, by way of a sort of universal media convention, that he is considered as a witness par excellence on the 'Holocaust' and the gas chambers. According to him, if the Germans exterminated large numbers of Jews, it was by forcing them either into raging fires or ovens! The conclusion of his testimony includes an extremely curious episode (pp. 129-133) over which I have been waiting years for Elie Wiesel to furnish us an explanation: in January 1945 he tells us, the Germans gave him and his father the choice between staying behind in the camp to await the arrival of the Soviets, or leaving with the Germans; after agreeing between them, the father and son decided to depart for Germany with their executioners instead of staying in place to await their Soviet liberators...<sup>17</sup>

Curiously, for several years now, Primo Levi has been posthumously elevated by the media to the rank of first importance among witnesses of the Auschwitz gas chambers. He is the author of *Se questo è un uomo*.<sup>18</sup> The first part of the book is the longest and the most important; it comprises 180 pages

<sup>12</sup> 'Medico ad Auchwitz': *Anatomia di un falso*, Edizioni La Sfinge, Parma 1988.

<sup>13</sup> Beate Klarsfeld Foundation, New York 1989.

<sup>14</sup> R. Faurisson, "Auschwitz: Technique and Operation of the Gas Chambers, 1989, ou Bricolage et 'gazouillage' à Auschwitz et Birkenau selon Pressac" [...], or, Pottering and Sputtering at Auschwitz and Birkenau According to J.-C. Pressac], *Revue d'histoire révisionniste*, November 1990, pp. 126-130 (online: [www.lebensraum.org/french/rhr/pressac.pdf](http://www.lebensraum.org/french/rhr/pressac.pdf)); Engl.: "Auschwitz: Technique and Operation of the Gas Chambers or, Improvised Gas Chambers and Casual Gassings at Auschwitz and Birkenau According to J.-C. Pressac (1989)", *The Journal of Historical Review*, Part I, Spring 1991, pp. 25-66; Part II, Summer 1991, pp. 133-175.

<sup>15</sup> (A Prominent False Witness: Elie Wiesel) *Annales d'histoire révisionniste*, Spring 1988, pp. 163-168; see also "Un grand faux témoin: Elie Wiesel (suite)" (A Prominent False Witness: Elie Wiesel (Continued)), *Nouvelle Vision*, September 1993, pp. 19-24).

<sup>16</sup> *La Nuit*, Preface by François Mauriac, Les Editions de Minuit, Paris 1958.

<sup>17</sup> One point which cannot fail to be interesting is that in the German translation of this book (*Die Nacht zu begraben, Elisha*, with German translation by Kurt Meyer-Clason, Ullstein, Munich 1962, pp. 17-153), the crematory ovens of the original French version are done away with to be replaced by gas chambers (which also applies to Buchenwald). I owe this discovery to the Swiss Revisionist Jürgen Graf and I am indebted to A.W., a German Revisionist living in France, for a list of 15 instances where the German translator thought it good to use the word 'gas' where it was not used in the original text (see Annex). In December 1986, I made my way to Oslo to attend the awarding of the Nobel Peace Prize to Elie Wiesel. Assisted by friends, I distributed a tract previously titled "Elie Wiesel, A Prominent False Witness." Some months later, Pierre Vidal-Naquet, one of my most implacable adversaries, denounced Mr. Wiesel as a man "who talks any rubbish that comes into his head [...] It suffices to read certain of his descriptions in *Night* to know that certain of his accounts are not exact and that he ends by transforming himself into a Shoah peddler. He commits an injustice, an immense injustice to historical truth." (Interview by Michel Folco, *Zéro*, April 1987, page 57).

<sup>18</sup> French: *Si c'est un homme* (If This Be A Man), Julliard Press, pocket edition, Paris 1993.

(pp. 7-186) and was edited in 1947; the author says, starting on page 19, that it was after the war he learned about the gassing of the Jews at Birkenau; he himself was working at Buna-Monowitz and had never set foot in Birkenau; also, he only spoke in extremely vague terms and but six times about “*the*” gas chamber (pp. 19, 48, 51, 96, 135 and 138) and on one occasion about the gas chambers (page 159); he is satisfied to nearly always mention it in the singular and as a rumor about which “*everyone is talking*” (page 51). Suddenly, in his “*Appendix*” written in 1976, being some 30 years later, the gas chambers make a forceful entry: in the space of 26 pages (pp. 189-214), which, in view of their more compact typography, can be considered as 30 pages, the author mentions on 11 occasions (page 193, two times; page 198, three times; page 199, once; page 201, two times; pages 202, 209 and 210, once each); on two occasions, he speaks of “*gas*” and on nine occasions of “*gas chambers*” (always in the plural); he writes as if he had seen them:

“*The gas chambers were in effect camouflaged as shower rooms with plumbing, faucets, dressing rooms, clothes hooks, benches, etc.*” (page 198)

He does not even fear to write additionally:

“*The gas chambers and the crematory ovens had been deliberately conceived to destroy lives and human bodies by the millions; the horrible record for this is credited to Auschwitz, with 24,000 deaths in a single day during the month of August 1944.*” (pp. 201-202)

Elie Wiesel and Primo Levi are not the only ones to have thus ‘enriched’ their recollections.

Primo Levi was a chemical engineer. Regarding his crack-up or delirium from a scientific point of view in *If This Be A Man*, one should consult Pierre Marais’ *En lisant de près les écrivains chantres de la Shoah – Primo Levi, Georges Wellers, Jean-Claude Pressac* [A Close Reading of the Siren Writers of the Shoah – Primo Levi, Georges Wellers, Jean-Claude Pressac];<sup>19</sup> see in particular “*Le chimiste, la batterie de camion et... les chambres à gaz*” [The Chemist, the Truck Battery and... the Gas Chambers], the chapter which involves Primo Levi (pp. 7-21). The latter died on April 11, 1987, (a probable suicide, we are told). It was to his very nature of being a Jew that he owes not having been shot by the Fascist militia on December 13, 1943, at the age of 24:

“*The Fascists had captured him in the role of a partisan (he was still carrying a pistol), and he declared himself a Jew in order not to be immediately shot. And it is in the role of a Jew that he was delivered over to the Germans. The Germans sent him to Auschwitz [...]*”<sup>20</sup>

## 9. Conclusion

From 1945 to 1985, the presumed judicial witnesses of the Auschwitz gas chambers have benefited from an extraordinary privilege: they have always been spared the ordeal of cross-examination regarding the material nature of the purported facts they related. In 1985, at the first of two Zündel trials in Toronto, attorney Douglas Christie was fully agreeable, based on my suggestion and offer of assistance, to conduct the cross-examination according to standard procedure for these type of witnesses. The result was the unmasking of witnesses Arnold Friedman and Dr. Rudolf Vrba. This reversal was so serious that today, one can no longer find witnesses willing to take the risk of swearing before the dock of a court of law that they saw a homicidal gassing, whether at Auschwitz or any other concentration camp within the Third Reich.

The would-be media witnesses continue to proliferate, unchecked, in the world of radio, television and books, where they hardly run the risk of being put into difficulty by embarrassing questions. Yet even these witnesses are becoming more and more vague, making themselves liable to denunciation by representatives of the exterminationist thesis. These latter are in effect aligning themselves more and

---

<sup>19</sup> La Vieille Taupe, Paris 1991, 127 pages.

<sup>20</sup> Ferdinando Camon, “*Chimie/Levi, la mort*” (Chemistry/Levi, death), *Libération*, April 13, 1987, page 29)

more with the revisionist school because they realize that up until now they have stood by the lies of too many false witnesses, lies that end by costing their own cause too dearly.

As there are notoriously more and more risks now in presenting oneself as a witness of the gas chambers – as again did the Jew Filip Müller in 1979 – the solution which nowadays tends to prevail is the one which, since May 7, 1983, Simone Veil has had to adopt in the aftermath of the April 26 decision by the Paris Court of Appeal, a decision which recognized that my work on the problem of the gas chambers was serious insofar as I demonstrated that the accepted testimonies flew in the face of strong physical-chemical impossibilities. The solution, or more precisely, the evasion, advocated by Ms. Veil consisted in saying that, if there were in effect no proofs, no traces, and no witnesses of the crime, it was because the Germans had destroyed all the evidence, all the traces, and all the witnesses. Such a statement, besides being absurd, would in turn necessitate evidence which Ms. Veil has not provided. But this matters little. Let us take note of this statement and, like Ms. Veil and those who in practice seem to rally to her thesis, let us also put to good use the evidence long brought to light by the Revisionists: not only do there exist no proofs and no traces of ‘Nazi gas chambers’, but there are no witnesses for them either.

Today, at the close of 1993, the testimonies regarding the Auschwitz gas chambers are discredited, even among the Exterminationists. History as founded upon these testimonies is beginning to give way

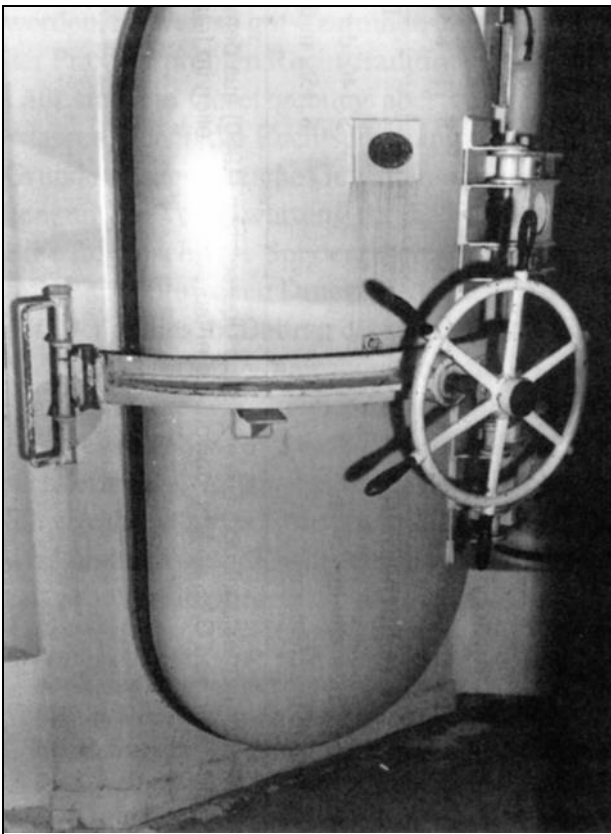

**Illustration 1:** Single door to an execution gas chamber for a single person per gassing procedure (Baltimore, USA, 1954, technology of the 30's). Inevitably, the execution of a single person with hydrogen cyanide is much more complicated and dangerous for the environment than the fumigation of clothes (even in a DEGESCH circulation chamber).



**Illustration 2:** One of the three doors of an alleged NS gas chamber for the execution of hundreds of persons at once with Zyklon B (hydrogen cyanide) (Krematorium I, Auschwitz, Poland, beginning of the 40's). This door is neither sturdily constructed, nor air-tight (e.g., the keyhole). It is partly glazed and opens inwards, i.e., into the room, where allegedly corpses were piling up.



to history founded either on facts or arguments of a scientific nature. It is this which I had advocated in my article of December 29, 1978, in *Le Monde* and in my letter to *Le Monde* of January 16, 1979. It was necessary to wait more than ten years to see our adversaries venture into the arena where I had invited them to join us in being evaluated: the field of science. Jean-Claude Pressac had been appointed, notably by Mr. and Mrs. Klarsfeld, to denounce ‘testimonial history’ and to replace it with a scientific basis or, at least, one with a scientific appearance.

Claude Lanzmann and the supporters of ‘testimonial history’ are upset,<sup>21</sup> to the satisfaction, by the way, of the Revisionists. A half-century of unsubstantiated testimonies must now be definitively succeeded by an inquiry for facts and proofs along a judicial, scientific and historical basis.

### Appendix: The Translation into German of Elie Wiesel’s Most Famous Book\*

French Original Version: <i>La Nuit</i> , éditions de Minuit, 1958, 178 p.	English Translation: <i>Night</i> , translated by Stella Rodway, Bantam Books, 1986 (25 <sup>th</sup> Anniversary Edition), pp. XIV-111	German Translation: <i>Die Nacht zu begraben, Elisha</i> , translated by Kurt Meyer-Clason, Ullstein**, 1962, pp. 17-153
<p><b>A. In Auschwitz</b></p> <p>1. p. 57: au crématoire 2. p. 57: au crématoire 3. p. 58: les fours crématoires 4. p. 61: aux crématoires 5. p. 62: le four crématoire 6. p. 67: Au crématoire 7. p. 67: le crématoire 8. p. 84: exterminés 9. p. 101: les fours crématoires 10. p. 108: six crématoires 11. p. 109: au crématoire 12. p. 112: le crématoire 13. p. 129: au crématoire</p> <p><b>B. In Buchenwald</b></p> <p>14. p. 163: du four crématoire 15. p. 174: au crématoire</p>	<p><b>A. In Auschwitz</b></p> <p>p. 30: to the crematory p. 30: to the crematory p. 30: these crematories p. 33: in the crematories p. 33: the crematory oven p. 36: the crematory p. 36: the crematory p. 48: exterminated p. 59: the crematory ovens p. 64: six crematories p. 64: the crematory p. 66: the crematory p. 77: to the crematory</p> <p><b>B. In Buchenwald</b></p> <p>p. 99: of the crematory oven p. 106: to the crematory</p>	<p><b>A. In Auschwitz</b></p> <p>p. 53: in die Gaskammer p. 53: ins Vernichtungslager*** p. 54: die Gaskammern p. 57: in den Gaskammern p. 57: die Gaskammer p. 62: die Gaskammer p. 62: Gaskammer p. 76: vergast p. 90: den Gaskammern p. 95: sechs Gaskammern p. 95: den Gaskammern p. 98: die Gaskammer p. 113: in die Gaskammer</p> <p><b>B. In Buchenwald</b></p> <p>p. 140: der Gaskammer p. 150: in die Gaskammer</p>
<p>* Thanks to a discovery by Jürgen Graf and the help of Ms. A.W. ** Ullstein, Thomas-Wimmer-Ring 11, D-80539 München; phone: (089) 235 00 80; fax: (089) 235 00 844. ***“<i>Vernichtungslager</i>” means ‘camp with homicidal gas chambers.’</p>		

**Conclusion:** The English translation (1960) of the French original (1958) is correct, whereas the German translation (1962) reads “gas” in 15 instances where, in fact, there was no mention of “gas” in the French original. This replacement was done so systematically that the translator even invented two gas chambers in the Buchenwald concentration camp.

<sup>21</sup> See notably the article by Robert Redeker which he published in C. Lanzmann’s review *Les Temps Modernes*, under the title: “*La Catastrophe du révisionnisme*” (The Revisionist Catastrophe), November 1993, pp. 1-6; here, Revisionism is presented as a catastrophic sign of a changing time: ‘Auschwitz’ was – and for the author, still is – a ‘mystique’, which is to say a belief enveloped by religious reverence; yet, he says in a deploring tone that ‘Auschwitz’ is becoming the subject of historical and technological considerations. This article was in printing when there appeared in *L’Express* a substantial write-up on the new book by Jean-Claude Pressac (September 23, 1993, pp. 76-80, 82-87). Claude Lanzmann virulently protested against this turn of events taken by ‘Holocaust’ history. He wrote: “*Even if it is in order to refute them, we thus legitimize the arguments of the Revisionists, which become the only criterion by which every text and every author is now judged. The Revisionists occupy the entire playing field*” (*Le Nouvel Observateur*, September 30, 1993, page 97).

# The German Justice System: A Case Study

CLAUS JORDAN

For a short time during the war, Gottfried Weise was a German guard in the Auschwitz concentration camp. Was he therefore automatically a subhuman not deserving to be heard? Gottfried Weise asserted that he did not do anything evil in these months, and ten former internees who could remember Weise confirmed this. However, two other ‘witnesses’ accused Weise of murder. Shouldn’t both sides be heard and their arguments weighed? That is the way it is meant to be in a state under the rule of law. But, as we shall see, reality is very different. In fact, the case of Gottfried Weise is an example of the hypocrisy of the entire German establishment, not just the legal system.

Totally convinced that they are in the sole possession of the absolute truth regarding the Holocaust, they simply refuse to even consider the possibility that they could be wrong, and that their actions could cause tremendous sufferings for innocent people. As soon as the ‘Holocaust’ is involved in any court case, prosecutors and judges, media and politicians, *en masse*, simply ignore all exonerating evidence!

In a very important book, Rüdiger Gerhard has documented how, during the first trial in 1991, the judges refused to hear or accept any evidence from the ten friendly witnesses presented by defense lawyers for Gottfried Weise.<sup>1</sup> These inmates did not witness the alleged crimes claimed by others, and thus could not contribute anything to clarification, so went the court’s reasoning. Since, in the eyes of German law courts, a crime is almost indisputably proved of having occurred as soon as a “*Holocaust survivor*” claims that it happened, German courts more or less do accept only incriminating evidence. Consequently, the ensuing criminal proceedings merely serve the purpose of establishing the dimension of the crime, naming the culprits and meting out the punishment they deserve.

The following article describes the Sisyphus-like struggle of the defense team in their attempt to exonerate Gottfried Weise and make those blinded by their arrogance and self-righteousness see the light of truth. They failed in the first; Gottfried Weise died without justice being done. His constant friend and defender Claus Jordan also passed away. May this article help to make the second goal come true.

*Germar Rudolf*

## 1. Preface

Germany’s justice system is based on the principle of a separation of powers. The administration of justice is supposed to be independent of politics. It does, however, have to conform to the law, and laws are passed by political bodies. So far, so good – at least as long as legislative practices in turn are committed to upholding the legal traditions that have evolved over time and have been tried and proven in practice.

But if legislative practice begins to be guided by political opportunism, and if special laws are passed to which jurisprudence must bow, then the administration of justice becomes a tool of politics.

The 1979 rescission of the statute of limitations for murder in Germany is an example of special legislation that has had grave consequences. The decision to revoke this statute was the result of political pressure. Concerns regarding potential miscarriages of justice were rationalized away. The

---

<sup>1</sup> R. Gerhard (ed.), *Der Fall Gottfried Weise*, 2<sup>nd</sup> ed., Tübingen, Berg 1991, pp. 31ff., 40, 43-47, 51ff., 60, 73. See M. Köhler’s article for a more general view.

case of Gottfried Weise, set out in this chapter, shows how very justified these concerns were and how thoughtlessly all cautions were swept under the table.

It is my hope that the discussion of this case will prompt the correction of the legislative error of 1979 and that the German justice system will return to its naturally evolved tradition, as it was predicted that same year:

*“[...] Perhaps there will in fact be a few new cases that are brought to trial as a sort of justification (eagerly seized upon) for the rescission of the statute of limitations. According to the experts, however, it is not likely. In light of the strict rules of evidence, which cannot be tampered with, it is doubtful that any verdicts can still be handed down. One day, around the year 2000, the stipulation that murder is not subject to a statute of limitations will be discovered amongst the nooks and crannies of our justice system, and people will wonder how this came about. The umpteenth revision to the Criminal Code will then casually correct the problem – unless by that time we will have a state which claims for itself that omnipotence that we [Germans] are yet free to call ‘hubris’.”<sup>2</sup>*

## 2. Rescission of the Statute of Limitations: Breach of Legal Tradition

On March 20, 1979, and July 3, 1979, the members of the *Bundestag*, the lower house of the then West German Parliament, debated on the rescission of the statute of limitations for murder. The corresponding bill was passed into law on July 3, 1979, with a very close margin of 255 to 222 votes.<sup>3</sup>

### 2.1. Influence From Abroad

Naturally, there was interest in this question abroad, but this interest was fostered by German circles as well. For example, in an article titled “*American Delegation on the Issue of Rescission: Today at Schmidt’s*” the newspaper *Frankfurter Allgemeine Zeitung* reported about a tour by the Los Angeles *Simon Wiesenthal Center for Holocaust Studies* that had been financially supported by the German Foreign Office in Bonn.<sup>4</sup> Members of the Israeli Parliament also sought to influence the decision-making process at the urging of German authorities. For example, Gideon Hausner, member of the Knesset and the Israeli Holocaust Center Yad Vashem, reports that German Federal Chancellor Helmut Schmidt urged him to impress upon the German legislators that National Socialist crimes must not be allowed to lapse under a statute of limitations – which he proceeded to do most insistently.<sup>5</sup>

### 2.2. Judicial Concerns

Reminders that Article 103 of the German Basic Law prohibits retroactive laws were brushed aside with reference to a 1969 decision of the Federal Constitutional Court. The opponents of the rescission of the statute of limitations raised further judicial concerns. Dr. Alois Mertes (CDU/CSU) pointed out the conflict between justice, and peace as required by the law. In European legal tradition, limitation means exclusively the “*protection of the state* [and certainly of the individual as well] *from miscarriages of justice.*” And:

*“In the countries belonging to the Anglo-American legal community, the state safeguards against the risk of injustice in other ways, namely through the principle of opportuneness and through especially strict rules of evidence. In German and European law, limitation is the necessary corrective to the principle of legality. [...] Incidentally, it is one of the great hypocrisies of our time that the punitive*

---

<sup>2</sup> F. K. Fromme, *Frankfurter Allgemeine Zeitung (FAZ)*, July 5, 1979: “*Was man sagt, und was man meint.*”

<sup>3</sup> Debate on the 18th revision of the Criminal Code; see Plenary Transcripts 8/145 and 8/166.

<sup>4</sup> *FAZ*, March 15, 1979: “*Den Vorhang nicht fallen lassen.*”

<sup>5</sup> *FAZ*, June 18, 1979, p. 11: “*Völkermord darf nicht als ‘normales’ Verbrechen gelten.*”

*purpose of expiatory justice is everywhere relegated to second place in favor of resocialization, while in the case of National Socialist crimes expiation is made the foremost and sole purpose of punishment even after 35 to 47 years of resocialization.*<sup>6</sup>

In his statement of position, Hans-Jochen Vogel, then Federal Minister of Justice, did not express any concern about miscarriages of justice, but responded merely to the suggestion that alleged National Socialist criminals could no longer be convicted anyway due to lack of evidence. He commented that modern techniques of criminal investigation were able to

*“secure evidence of crimes and perpetrators in a way that allows the conviction of the criminal even decades after the fact.”*<sup>7</sup>

But he made no mention of applying the techniques of modern criminology to ensure the prevention of miscarriages of justice.

Opponents of rescission who feared that convictions might result despite insufficient evidence cautioned against one-sided investigation.<sup>8</sup> Proponents, on the other hand, cited the principle of *in dubio pro reo* – i.e., ‘when in doubt, acquit’ – which practice they clearly considered a matter of course.<sup>9</sup>

This certainly was shown even more clearly by Friedrich Fromme, co-editor of the *Frankfurter Allgemeine Zeitung*, in his aforementioned newspaper article where he wrote of “*the strict rules of evidence, which cannot be tampered with*”, as of something self-evident and to be taken for granted. Apart from (pseudo-)morally suspecting each other, all discussions that flare up time and again about the rescission or prolongation of the statute of limitations in the *Bundestag* altogether concentrated on the question, how to punish the allegedly committed NS-injustice best, but never on the question, if a perpetuation of evidence after such a long period of time can possibly clear up the actual events of the past. Since everybody was convinced of the reality of all sorts of alleged crimes, a criminological hearings of evidence were deemed to be necessary only in order to assign alleged guilt and therewith the supposed need for penance.<sup>10</sup>

None of these “*self-evident*” matters were acknowledged in the case of Gottfried Weise: Weise was convicted with nary a thought given to the acquittal demanded by reasonable doubt. To the defendant’s detriment, the strict rules of evidence were tampered with most grossly. There was no sign of modern forensic or criminal investigation in his trial, least of all where such endeavors would have resulted in an exoneration of the accused. However: H.-J. Vogel had suggested such techniques for strictly one-sided purposes, namely to procure *incriminating* evidence.

### 2.3. The Fig-Leaf: An Expert Report

Originally the statute of limitations was to be rescinded only for cases of so-called NS-murders.<sup>11</sup> Members of Parliament Maihofer and Helmrich openly supported this plan. However, constitutional concerns were raised about such very obvious special legislation, so that in the end the rescission was applied to murder in general.

The question regarding the constitutionality of a general rescission of limitation for murder remained open. In his capacity as expert, Professor Böckenförde had stated that the rescission of limi-

<sup>6</sup> Plenary Transcripts 8/166, p. 13235. Emphasis in the transcript.

<sup>7</sup> Plenary Transcripts 8/145, p. 11612.

<sup>8</sup> Eg. Dr. Lenz (Bergstraße, CDU) in the Bundestag debate of March 29, 1979, Plenary Transcripts 8/145, p. 11609.

<sup>9</sup> Eg. Dr. Schwarz-Schilling (CDU), Plenary Transcripts 8/145, p. 11644.

<sup>10</sup> Cf. Deutscher Bundestag, Presse- und Informationszentrum (ed.), “*Zur Verjährung nationalsozialistischer Verbrechen*” in *Zur Sache. Themen parlamentarischer Beratung*, vol. 3-5/80, Bonn 1980.

<sup>11</sup> Cf. F. K. Fromme, *FAZ*, Feb. 14, 1979: “*Die Angst vor dem, was man will.*”

tation becomes unconstitutional if it means that normative regulations of trial procedure can no longer be uniformly applied. He wrote:

“[...] *This may happen, for example, if [...] the results obtained are random at best, i.e., due to the unstoppable deterioration of evidence, insurmountable investigative difficulties, lack of opportunity for effectively securing evidence, fundamental uncertainty or insufficient objectifiability of the crime.*

*It is beyond the scope of this report to ascertain whether a rescission of the statute of limitations for NS-murders or for murder in general would reverse into such impracticability. This requires a detailed practical understanding and assessment of actual conditions, particularly of the investigative and evidential problems involved [...].”<sup>12</sup>*

In other words, this report did not state that the rescission was constitutional. Rather, it stated that at the time (1979) no unconstitutionality was yet apparent, and that to determine this matter conclusively it would be necessary to examine the “*actual conditions*” of several cases.

## 2.4. Empty Promises

One empty promise was the assurance, given when an expert report was obtained, that the overall constitutionality of the matter would be ascertained. In fact, however, clearly no one in politics or science, no one amongst the guardians of democracy, and no one in the media really wants to know, else the supplementation and conclusion of the report would long have been commissioned by now, either from Professor Böckenförde or from another source.

In 1979, the embarrassing vulnerability of the core issues of *constitutionality* and *miscarriage of justice* were shielded with Böckenförde’s unfinished report as with a fig-leaf, garnished with sanctimonious aphorisms.

The case of Gottfried Weise reveals that these were but hollow phrases and empty promises.

## 3. The Case of Gottfried Weise: an Example of Reversal Into Impracticability

In 1988, pensioner Gottfried Weise was convicted in Wuppertal on five counts of murder. An examination of the Wuppertal trial reveals all the characteristics identified in 1979 by Professor Dr. Böckenförde as being signs of a reversal into impracticability:

- a) **Unstoppable Deterioration of Evidence:** It has been impossible to obtain the transfer papers which, together the two other documents on hand, would prove that Weise was not employed at the alleged site of the crime in Auschwitz until September 1944. (The alleged time of the crime being “*June/July 1944*”.)
- b) **Insurmountable Investigative Difficulties:** The Court was not even able to develop a realistic conception of the alleged site of the Freimark cases. (cf. Section 3.2.2.)
- c) **Lack of Opportunity for Effectively Securing Evidence:** Both the Public Prosecutor’s Office and the Court neglected to obtain a statement from former inmate Dr. Eisenschimmel in due time. His testimony would have gone a long way towards exonerating the accused. When the defense attempted to secure this testimony, Dr. Eisenschimmel was already so ill that he could no longer testify.
- d) **Lack of Objectifiability of the Crime:** Wherever concrete facts were concerned, the Court was always very vague in its ‘findings’. In the Freimark cases, for example, the alleged time of the crime was given as “*June/July 1944*”, and the names and sometimes even the sex of the alleged victims are not stated. This makes it much more difficult to locate concrete counter-evidence

---

<sup>12</sup> FAZ, June 30, 1979, no. 149, p. 6.

such as might have been possible, for example, by cross-reference to the Auschwitz Death Lists now available.

The Wuppertal Court ‘overcame’ the evidential problems only by deviating considerably from the “*strict rules of evidence*”.

Another point which must be mentioned is one that Böckenförde could not possibly have conceived of because he spoke from the perspective of naturally evolved legal tradition: What happened in the Wuppertal trial was practically a

e) **Reversal of the Burden of Proof:** The accused was in the desperate position of being unable to prove his innocence, *e.g.*, to prove that he could not have been at the alleged site of the crime at the stated time. The Court was satisfied with contradictory and vague eyewitness statements, of whose doubtful quality it glossed over with the claim that it was exactly these contradictions that showed that the witnesses had not coordinated their testimony beforehand. It was up to the accused to prove his innocence.

It was not until long after the trial that exonerating evidence was found which the prosecutors had unlawfully avoided and prevented from being obtained in time.

### 3.1. Overview of the Background, Course and Consequences of the Wuppertal Trial of Gottfried Weise

#### 3.1.1. Background of the Case of Gottfried Weise

Gottfried Weise was badly injured when a soldier, and lost an eye. He was certified unfit for front-line or guard duty, and after training as bookkeeper he was detailed to the concentration camp Auschwitz, where he was first employed in the *Häftlingsgeldverwaltung* [Bookkeeping for Prisoners’ Funds] outside the Camp and later in the *Personal Effects Warehouse II* in Birkenau, where the possessions of camp inmates were stored. There Weise had to supervise a group of Jewish women. After Auschwitz was dissolved he conducted this group safely to the Allies, via Ravensbrück. All of ‘his’ inmates had testified for him: how he had worked to make their lot easier in Auschwitz, that they had been glad to be reassigned to his command during the transport, that once he had even carried a disabled girl out from under Russian artillery fire. After minute scrutiny in the course of three years of imprisonment, Gottfried Weise was released. His conscience was clear, and so he proceeded to do something quite extraordinary: through the Red Cross and the World Jewish Congress he searched for his former protégés. In the verdict handed down by the Wuppertal District Court,<sup>13</sup> however, these efforts on the part of the accused are only mentioned disparagingly as signs of his great cunning.

#### 3.1.2. How Did the Indictment Come About?

In 1962, during the trial of Richard Baer in Vienna, one witness, Herbert Tischler, had told of an SS *Unterscharführer* or *Rottenführer* “Weiser” who, he claimed, had killed an inmate when he tried to shoot a tin can off his head. Thus “[William] *Tell of Auschwitz*” was born.

Yet, an official document identified Tischler as an unreliable witness, and it was a known fact that he was wanted by Interpol for all sorts of criminal acts. But as witness for the prosecution in an NS trial, Tischler was considered credible. His reference to the alleged “*Tell of Auschwitz*” entered the mills of criminal prosecution. The alleged “*Tell shooting*” was ascribed to former *Unterscharführer* Gottfried Weise. Inquiries were begun in 1980; questionnaires with details of the alleged crime and with photos of Gottfried Weise were sent to Poland, Israel, Hungary, and the United States.

<sup>13</sup> Verdict of the Wuppertal District Court, Jan. 28, 1988, pp. 104-107.

In other words, witnesses were sought – and found. With the example of the witness Freimark I will show how this search for witnesses and the ‘refreshing’ of their memories was done.

### 3.1.3. What Were the Charges?

On June 7, 1985, the Public Prosecutor’s Office of Cologne charged the pensioner Gottfried Weise, resident in Solingen, born in Waldenburg on March 11, 1921, with having committed murder in the concentration camp Auschwitz.

On January 28, 1988, Weise was found guilty of five counts of murder and sentenced to life imprisonment by the Wuppertal Jury Court headed by Wilfried Klein, now vice-president of the Wuppertal District Court.

According to the witness Józsefne Lazar, the accused committed **two murders** (the ‘Lazar cases’) in Personal Effects Warehouse II by means of the so-called “*tin can shooting*”, where the accused placed tin cans on the head and shoulders of his victims and then shot at the tins and then at the victims.

According to the witness Jacob Freimark, the accused also committed **three murders** (the ‘Freimark cases’) in “*June/July 1944*” in Personal Effects Warehouse I, namely:

- a) one murder in a hut (the ‘hut murder’), and
- b) approximately four weeks later, two murders in an area between the camp fence and a ramp some 30 ft. away (the ‘ramp murders’).

### 3.1.4. How Did the Trial Proceed?

The entire trial took place against the backdrop of a foregoing conviction of the accused in a scenario of hatred. The press and the Court complemented each other. For example, the press report quoted in the following repeated eyewitness testimony which, though proven to be false,<sup>14</sup> was glibly accepted at face value not only by the credulous public but also by the Court, which actually included even this so easily refutable atrocity tale in its written Reasons for Sentence:<sup>15</sup>

#### ***“Children Were Thrown Alive Into The Burning-Pit***

*[...] When a new transport of inmates arrived at the camp, the children were immediately separated from the rest of the group, and thrown alive into a blazing fire-pit, [...].*

*Suddenly, the intoxicated ‘Blind One’ arrived (that’s what the inmates called the accused, Weise), turned the light on and ordered Olga [...] to dance [...] It was horrible! Outside, the screams of the children. [...] The Blind One ordered the pregnant girl to stand still, and kicked her in the stomach with his boot. The young woman screamed and collapsed. [...]*<sup>16</sup>

This sort of atrocity tale served to brand the accused as the “*Beast of Auschwitz*” – not only in the eyes of the public, but also in those of the Court. While the accused was not convicted for the alleged live burnings, the assumption that they did take place and that the accused had displayed a great deal of callous hard-heartedness most certainly did influence the Court in reaching its verdict. This is proven clearly by the detailed way in which the Court repeats this atrocity tale in its Reasons for Sentence and then accuses the defendant of “*utterly callous hard-heartedness*”.

The biased attitude of the judges was also clearly apparent in the courtroom. For example, the VVN – the Organization of Persons Persecuted by the Nazi Regime, a group known at that time to be financed from East Germany and directed by the *Stasi*, the East German State Secret Service –

---

<sup>14</sup> There was no burning pit at the location mentioned, near Personal Effects Depot II; cf. the chapter by J. C. Ball, this volume.

<sup>15</sup> Reasons for the Wuppertal Auschwitz verdict of Jan. 28, 1988, p. 96.

<sup>16</sup> Wuppertal newspaper *General-Anzeiger*, June 10, 1987.

this VVN had handed out fliers in and outside the courtroom. The Presiding Judge offered a gentle reprimand for the distribution of the fliers in the courtroom – something like that, he said, should not be disseminated about the accused until after he had been convicted. But no stop was put to the continued distribution of the leaflets.

The constant taking of shorthand notes by representatives of the VVN and by ‘escorts’ of the witnesses for the prosecution was also not forbidden by the Court, which kindly overlooked it. (Incidentally, Ruth Kulling of the VVN always had a seat in the area reserved for members of the press.) In contrast, the defense counsel had urged the son of the accused to refrain from taking notes, as doing so was not permitted during the trial. – Several times it was also observed that the VVN members, after making their shorthand transcripts with impunity, proceeded to read their notes to the witnesses for the prosecution before these took the witness stand.

In any normal trial the defense could and should have intervened here, but in light of the scenario of hate that had been tolerated and even partly contributed to by the Court, the defense in the Wuppertal trial saw no purpose in doing so. In order to avoid providing even further material for all the advance preparation and choreographing of the witnesses for the prosecution (in flagrant violation of all rules of procedure, by the way), the defense counsel had advised the defendant to refrain from making any statements of his own. After the verdict had been handed down, the press twisted this accordingly:

*“The defendant’s silence, said Klein, showed that Weise had no facts with which to counter the accusations – ‘the past has caught up with him now and will not be hushed up’.”*<sup>17</sup>

No one seems to have noticed the monstrous implications of this statement: the defendant had no facts with which to counter the accusations! What this suggests is that the accusations advanced in the indictment and by the witnesses were facts in and of themselves, which the accused was unable to refute. But accusations, of course, are by no means facts.

But the reversal of the burden of proof, accepted so matter-of-factly by the press, is no mere slip of the judicial tongue. The closer one examines the trial documents, the more clear it becomes how much the Court allowed its own bias to guide it. In any ‘normal’ trial the accused is presumed innocent until proven guilty, and any uncertainty dictates the maxim ‘when in doubt, acquit’. In Wuppertal this was not so.

In the given situation of reversed burden of proof, it was of course an easy matter to turn all the many investigative problems, which are well to be expected in such a very late trial, against the accused – especially those set out in Sections 2a-c.

Nevertheless, the accused would have had a fighting chance to prove his innocence – if that’s the way it had to be – if the Court had not inexorably restricted or downright denied him every opportunity for doing so. One of the hobbles placed on his defense was that the Court relentlessly perpetuated the prosecution’s one-sided selection of witnesses: the prosecution had a wealth of information regarding potential witnesses at its disposal. It was the duty of the Public Prosecutor’s Office to sift through these for witnesses for the prosecution *as well as for the defense*, but this was not done. Even in the course of preliminary investigations the former inmates were only urged to testify if they claimed to have incriminating information, such as for example the witness Lazar in her testimony in Budapest on June 2, 1987, and June 16, 1987. The transcripts<sup>18</sup> show, among other things, how compassionately and urgently the Presiding Judge Klein – who had traveled all the way from Wuppertal for this purpose – strove to persuade the witness to consent to testify in Wuppertal. Po-

<sup>17</sup> Article by Ulla Dahmen-Oberbossel in the Wuppertal *General-Anzeiger* of Jan. 20, 1988.

<sup>18</sup> Copies of both transcripts were appended to the Motion for Appeal of Aug. 12, 1988.



tential witnesses for the defense were dealt with rather differently. When the defense suggested the questioning of an ill witness, Ms. Moische Korn, in Israel, this was rejected:

*“The motion to hear evidence does not indicate any reasons that the witness can be examined in the foreseeable future.”*<sup>19</sup>

The defense attempted to counteract this one-sided selection of witnesses by submitting numerous Motions to summon former inmates (more than twenty) and by further motions to hear evidence, but all were summarily rejected. These refusals were justified time and again by the comment that the best these witnesses could do would be to testify that they knew nothing of the alleged crimes committed by the accused. This sort of testimony was said to be irrelevant because, first of all, the inmates could not have known everything and, second, after 43 years they could not possibly remember exactly.

The Wuppertal Court consistently downgraded Motions to hear evidence, submitted by the defense, to the level of Motions to obtain evidence, only to reject them.<sup>20</sup> In the first Order for Exemption From Imprisonment, however, the Provincial High Court and Court of Appeal in Düsseldorf had stated that in its view all potential witnesses should be heard, since the difficulty involved in establishing the truth after such a long time warranted this.<sup>21</sup> This is most remarkable, as it is not the usual procedure for another court to attend to matters of ascertaining facts; on principle, this is the sole task of the Court responsible for the trial. The Provincial High Court and Court of Appeal in Düsseldorf reinforced its opinion by granting Weise renewed exemption from imprisonment after the Wuppertal verdict.

Another example of suppression of evidence is the testimony of Isaac Liver, given on October 18, 1985, at the headquarters of the National Police in Villejuif, France. The numbers in the following quoted excerpts refer to written questions to the witness:

*“No. 2: I worked in ‘Camp Canada’, first in Auschwitz in Canada No. 1, then in Canada No. 2, which was in Birkenau, approximately 4.3 miles from Auschwitz. In 1944 I was in Birkenau [...].*

*No. 4: The name Gottfried Weise and the nicknames ‘the Blind Man’ or ‘Sleepy’ are absolutely unfamiliar to me.*

*No. 5: I did not witness the crimes mentioned in this brief and never heard anyone talk about them. I believe that this story is untrue, as there is no doubt that all the prisoners in the camp and probably those in the other camps as well would have known of it.*

*Personally, I feel that this story is untenable; everything described in this brief [!] is completely new to me and if these things had really taken place in the camp the way they are described, I could not but have known about them.”*<sup>22</sup>

An unprejudiced court would naturally have examined precisely this witness in detail so as to avoid getting a one-sided account of the events, to avoid giving the public a one-sided story, and to ascertain the powers of recollection and the credibility of the various witnesses by comparing their testimony. But the Wuppertal Court ‘knew’ from the outset which witnesses were credible and which were not. And so the witness Isaac Liver was not heard. The transcript of his earlier examination, while available to the Court, was not read, thus remaining unknown to the public as well as to the jury. Other testimony that could have exonerated the accused and corrected the purely negative way he had been presented to the public was swept under the carpet the same way.

---

<sup>19</sup> Rejection of Motions to Take Evidence nos. 1-13, quoted here from p. 17 of the Motion for Appeal.

<sup>20</sup> Motion for Appeal, p. 6.

<sup>21</sup> *Ibid.*, p. 80.

<sup>22</sup> P. 1909f. of the Court files.

Not only did the Court refuse to call witnesses for the defense, it also thwarted the timely presentation of material evidence. This will be discussed in greater detail in Section 3.1.7.2.

### 3.1.5. Reasons for Sentence

On January 28, 1988, the First Division of the Wuppertal District Court's Jury Court decided that the accused was guilty of five counts of murder, the overall sentence being life imprisonment. The first eighteen pages of the Reasons for Sentence are devoted to a representation of the "*historical background*" based on "*generally known and historically established facts*" with

*"reference to, for example: Buchheim/Broszat/Jacobsen/Krausnick, Anatomie des SS-Staates, Walter-Verlag, volumes I and II; Hofer, 'Der Nationalsozialismus – Dokumente 1933-1945', Fischer-Verlag; Kogon, Der SS-Staat, Wilhelm-Heyne Verlag"*.

Auschwitz literature giving sound, verifiable and useful factual information is completely lacking in this list of works.

It is not surprising, therefore, that the descriptions of the camp, its organization and circumstances, which take up another 40 pages of the Reasons for Sentence, contain numerous patently and verifiably false claims and statements. For example, on pages 57-58 of the Reasons for Sentence it actually states, verbatim:

*"For many of the inmates their most valuable possession was a bowl that served equally for their calls of nature and for eating."*

And:

*"The purpose served by the concentration camp Auschwitz as mass extermination camp shall not be discussed in detail here, as the crimes which the defendant committed, i.e., is said to have committed are not connected with the orders given in the context of the 'Final Solution'."*<sup>23</sup>

But details mentioned further on in the Reasons for Sentence repeatedly refer to the well-known scenario. One example of this is to be found in the context of the Wuppertal Court's attempts to explain away particularly incredible claims contained in the witness Lazar's thoroughly imaginative testimony. In Budapest, Lazar had stated under oath that she had personally seen many murders taking place, for example:

*"3. I could move around freely in 'Camp Canada' and so I could observe how SS-men shot prisoners.*

*4. Executions happened almost everyday, almost hourly. I saw it with my own eyes."*<sup>24</sup>

Now this was in contradiction to the statements of most former inmates who had testified earlier. But the Court managed to come up with an explanation for this 'discrepancy'. It explained this gross exaggeration away by stating that the experiences associated with the mass dyings taking place at the nearby crematoria had *fused* with the personal memories of the witness.<sup>25</sup>

At numerous other points in the Reasons for Sentence as well, the judges made reference to the "*commonly known, historically established facts*" in which they believe so firmly. For example, the absolutely unbelievable claim that the accused could take wild potshots in the camp with impunity is simply rationalized with the comment that after all it is "*commonly known*" that the life of an inmate was of no value.

Even if one were to accept the "*commonly known*" nature of this idea, one ought at least to have asked how such mad pistol-popping could have been possible without also endangering the other guards. In a somewhat closer investigation one could have examined old guard books, which would

<sup>23</sup> Verdict, pp. 65, 66.

<sup>24</sup> Verdict, p. 151.

<sup>25</sup> Verdict, p. 116.

have revealed that every weapon, each and every bullet had to be accounted for. For example, I had no trouble obtaining a number of sample pages from concentration camp guard books from archives in Prague – pages which document precisely that the procedure of issuing weapons and ammunition, which every soldier is familiar with, was also observed no less strictly by the concentration camp guards. With a little less “*common knowledge*” and a little more objective investigation, the Court would not have fallen for that bit of nonsense about the mad beast taking potshots in the camp whenever he pleased, and getting away with it without so much as a reprimand.

Under German law, there is no appeal in matters of fact, which would permit the re-examination of the ‘findings’ which the Court arrived at in this way of “*common knowledge*”. In trials of severe crimes (as murder or denial<sup>26</sup>) there is no option for appeal, only for ‘revision’, which investigates technical errors of procedure but does not examine facts deemed to have been established as such.

### 3.1.6. Revision

The defense had concentrated on the ‘Lazar cases’, and on the branding of the accused as “*the Beast of Auschwitz*” which they involved. The defense considered the witness Freimark, who did not enter the picture until quite late, to be so utterly incredible that it felt that a conviction based on his accusations was impossible. This was a mistake on the part of the defense, which was not versed in the vagaries of Special Trials. Nothing was impossible in Wuppertal.

The attorney in charge of the revision also focused on the ‘Lazar cases’. He believed that evidence for even partial incorrectness would force a new trial. This was another mistake with tragic consequences for the accused. On March 31, 1989, the Federal Supreme Court quashed the verdict, but only with reference to these two alleged murders – while, surprisingly, upholding it for the remainder of the charges, *i.e.*, for the other three alleged murders, the ‘Freimark cases’.

### 3.1.7. The Final Verdict: The Freimark Cases

What was the nature of the “*very ‘personalized’ evidence*” (as the attorney for revision put it) in these Freimark cases that had not been affected by the revision process? On the basis of Freimark’s testimony, the Wuppertal Court had considered three murders in Personal Effects Warehouse I, the so-called *Old Camp Canada*, as being proved:

- a) Shooting of an unidentified male inmate on an unspecified day in June or July 1944. This crime was said to have been committed in a hut described by the Court as “*Bedding hut*”.
- b) Approximately four weeks later (but still in “*June or July 1944*”): shooting of two inmates from Grodno (sex unspecified). Another inmate is said to have been murdered by SS-man Graf on this occasion. (This branded Graf as murderer and discredited him as witness for the defense. A Viennese court had acquitted him, but the Wuppertal Court fought tooth and nail against having the Viennese records brought in for reference.) These crimes allegedly took place in an area between a fence and a ramp located on a rail line some 30 ft. from the fence. At the time of the crime, hundreds of inmates had been boarding “*thirty to forty*” wagons via the ramp, while floodlights turned night into day.

#### 3.1.7.1. Unconditional Faith in Freimark’s Statements

For the Wuppertal Court, the testimony of the only alleged eyewitness, Freimark, sufficed to warrant a conviction. The Court commented on Freimark:

“*The credibility of this witness is beyond question.*”<sup>27</sup>

---

<sup>26</sup> In this context, German law indeed ranks Holocaust denial as severe as theft, rape, robbery, and murder.

<sup>27</sup> Verdict, p. 180.

*His credible testimony is already enough to convince the Court of the factuality of the crimes of the accused as these are set out in 1a) and b).*<sup>28</sup>

It was very rash to condemn a person to life imprisonment on the sole basis of trust in the veracity and probity of one single witness. Despite all the difficulties ensuing from the advanced deterioration of evidence, it was possible to find new proof which reveals that the witness Freimark had not told the truth.

The Court's unconditional faith in its witness Freimark is incomprehensible. Many such contradictions had already become apparent during the trial; the Court chose to ignore them. For example, no one had bothered to take note that Freimark had claimed that, having been a Jewish political inmate in Auschwitz, he had had to wear a green identifying patch. Closer scrutiny would have shown that time and again Freimark has given different accounts of this aspect of his internment which, after all, must have been of paramount importance to him during his time in the concentration camp. When asked "*what sort of patch?*", he is now known to have answered in the past: red-yellow (1962), green (1966), green (1968), green and red-yellow (1988), green-yellow (1989).<sup>29</sup> These and many other inconsistencies were never investigated by the Wuppertal Court. When the defense drew attention to contradictions, these references were ignored.

The most important discrepancy is to be found in Freimark's statements regarding the time when he was ill with typhus. It is undisputed, for example, that Gottfried Weise was not detached to Auschwitz until late May 1944, and spent the first eight weeks with Bookkeeping for Prisoners' Funds, which office was located outside the camp. The defense was able to prove this on the basis of two documents. Further, the witness Freimark had stated earlier that he had contracted a severe case of stomach typhus in late May 1944.

According to the documents at hand, therefore, neither Freimark nor Weise could have been at the alleged site of the crime at the time claimed for the crime ("*June/July 1944*"). But the Court managed to iron out this minor 'wrinkle': Weise might very well have been assigned to guard duty every now and then (Weise had been certified unfit for guard duty), and Freimark (who was utterly infallible any other time) may have been mistaken in his earlier statements. Of course, Freimark confirmed most happily that, oh well, in that case he had simply not fallen ill until a little later. And the Court commented that the discrepancies in Freimark's claims regarding the time of his bout of typhus did not reflect on his credibility as witness because his testimony was supported by circumstantial evidence.<sup>30</sup> Freimark declared that his earlier 'mistake' was due to the fact that during his questioning in 1968, he had "*not paid any particular attention*" in giving the time of his illness.<sup>31</sup>

### 3.1.7.2. Mis-Timed Circumstantial Evidence

The defense had requested that documentary evidence be obtained to verify Freimark's illness. The Court received such papers the day before the verdict was handed down, and believed it had reason to rejoice. The documents that had been located – medical papers from concentration camp Auschwitz – proved, it said, that the witness, Freimark, had been examined in the Inmate's Infirmary in August and September 1944 for suspected typhus. It was felt that, aside from eyewitness testimony that needed to be artificially lauded to the skies, one had now finally found some material (even though presumptive) evidence that might serve as spur to the intent to convict: circumstantial

<sup>28</sup> Verdict, p. 190.

<sup>29</sup> Matthies/Jordan, Aug. 1993: *Der Fall Weise – Neue Beweise zur Klärung unrichtiger Angaben des Zeugen Freimark und unrichtiger Feststellungen im Urteil des Landgerichtes Wuppertal vom 28. Januar 1988*. Copies of this study are available in return for photoduplication costs.

<sup>30</sup> Verdict, p. 185.

<sup>31</sup> Verdict, pp. 75, 76.

evidence to indicate that Freimark's new claim as to the time of his illness was correct. What was smoothly overlooked was the fact that in his most recent testimony Freimark had claimed "*October 1944*" as the new date of the onset of his illness, not "*August or September 1944*". The Court was only able to maintain these erroneous claims by consistently refusing all of the Defense's Motions to bolster this circumstantial evidence with supplementary documentation.<sup>32</sup>

But even this prop, patched together as it was out of fragments of the existing presumptive evidence, had been mis-timed by the Court. It wrote:

*"In the documents of August 14, 1944, for example, it was noted under no. 9 of the list, regarding the examination of former inmate and witness Jakob Freimark: '87215... Freimark, Jakob... Clinical diagnosis: suspected typhus [Typhusverd.], while for other inmates the result given was 'typhus still suspected [noch Typhusverd.], merely 'Typhus', etc.'"*<sup>33</sup>

What this suggests is that Freimark's illness was nowhere near a complete recovery ("*noch Typhusverd.*" [typhus still suspected] nor even full-blown "*Typhus*"), but that there was merely a preliminary suspicion of typhus, in other words, that at most he had only just contracted the disease. It should be noted, however, that neither among the numerous infirmary documents that were turned up later, nor among the Court documents, is there any infirmary paper that states '**noch** Typhusverd.' [*i.e.*, typhus **still** suspected]. It is also strange that only two of a whole series of relevant documents, available at the Auschwitz Museum, were read by the Court, and at the last minute. And what is no less strange is the steadfast claim that there were no further infirmary papers regarding Freimark. The defense had no opportunity to take a closer look at the laboratory papers, which were not read to the Court until the day of the verdict. In this way the Court was able to sustain the fiction that Freimark's illness must have broken out some time after August 14, 1944, and that he had been fully recovered again by September 18, 1944. Further evidence has been found now which disproves this tale, which was thoroughly unbelievable from the start.

## 3.2. New Evidence, Motion for Retrial, Dismissal, Objection

A motion for retrial was filed in the case of Gottfried Weise in late 1992. On April 22, 1994, the District Court in Mönchengladbach dismissed this motion, which decision was communicated to the prisoner in late May. Weise's attorney objected to this dismissal. The new evidence on which the motion for retrial is based was, in part, ignored completely in the dismissal and, in part, rejected for technical or insufficient reasons.

### 3.2.1. 'The Wrong Time' – New Evidence for the Incorrect Time Alleged for the Onset of Freimark's Case of Typhus

#### 3.2.1.1. Infirmary Papers Discovered After the Fact

What baffles one is why a judicial scandal had not already erupted years ago, when it was shown how casually the Wuppertal Court had interfered with the obtaining of further evidence, because allegedly:

*"[...] there is nothing to indicate that the state-operated Auschwitz Museum in Poland has access to any documents beyond the aforementioned infirmary papers, which have been put at the disposal of the Red Cross International Tracing Service in photocopy form."*<sup>32</sup>

In fact, tens of thousand of infirmary papers are stocked in the polish Auschwitz Museum, which alone is circumstantial evidence for the enormous efforts that were made in Auschwitz to help the

---

<sup>32</sup> Verdict, pp. 76, 77.

<sup>33</sup> Verdict, p. 58.

A. U. K. - H. K. B. - B. T. F. - M. H.      8. IX. 1944.

Blut      = 8. 9. 1944

№.	Nr.	Name u. Vorname	Klinische Diagnose
1.	127813	Kwiatkowski Jozef	Paraty. B.
2.	181187	Smirnov Hariton	Typhus
3.	84215	Freimark Jakob	Typhusverd.

(1218/118)

**Illustration 1:** First “sterile” entry for Freimark, on lab report dated Sept. 8, 1944.

“Sterile” entries were also made for the other two patients.

sick inmates recovering, even though the established interpretation of history alleges that sick internees were selected for being unfit for labor and consequently gassed. As a matter of fact, seven infirmary papers pertaining to Freimark’s illness were found in the archives of the Auschwitz Museum:

1. Aug. 13/14, 1944 (Blood, Gruber-Widal und Weil-Felix<sup>34</sup>, results: not yet “sterile”),
2. Aug. 28, 1944 (Stool, results: still some pathogenic intestinal bacteria),
3. Aug. 28, 1944 (Blood, results: not yet “sterile”),
4. Sept. 5, 1944 (Stool, results: still some pathogenic intestinal bacteria),
5. Sept. 8, 1944 (Blood, results: “sterile” for the first time),
6. Sept. 11, 1944 (Stool, results: only normal coli bacteria, for the first time),
7. Sept. 18, 1944 (Blood, Gruber-Widal, results: still “sterile”).

The Court based its opinion – that “*in that case*” Freimark had simply not fallen ill until August – on the two aforementioned papers that were allegedly the only ones that could be found: on two of seven now known lab papers, specifically the first and last links (Nos. 1 and 7) of the chain of evidence.<sup>32</sup> If the defense had been granted an opportunity to examine the papers presented by the Court, then it could have determined even on the basis of only these two lab papers, nos. 1 and 7, that something was wrong with the Court’s interpretation: the results of no. 1 did not yet indicate ‘sterile’, while the results of no. 7 did. If nothing else, then this “sterile” result on no. 7 – had it been known to the defense – would have sufficed to make the defense suspicious. This was the first instance where the accused was denied a means to defend himself in this particular matter; his second means of defense, the obtaining of documents no. 2 through 6, was also denied him – and of course the Motion to obtain an expert medical opinion was refused as well.

The documents found after the fact now prove that Freimark’s case of typhus did not break out “*in August 1944*”, as the verdict claims. The sequence of documents shows clearly that Freimark could not have contracted his acute case of typhus between August 13 and September 18, 1944. However, his lengthy and severe bout of typhus is undisputed, and also established in the verdict. But the documents prove that it did not break out and become cured within the time span of August-September 1944. But when else should the illness have occurred: before or after August-September 1944? The specialists’ statements now available to the defense state unequivocally that the second entry of “sterile” (according to the Gruber-Widal test) at the end of the series of lab tests is typical for the conclusion of a final check-up in accordance with the regulations pertaining to epidemic control at

<sup>34</sup> Medical testing methods.

the time in question. This could already be proven by means of the bacteriological findings that have been available since 1990, but evidence regarding the severity and hence the duration of Freimark's preceding illness was as yet still lacking.

In January 1995 the defense, at long last, also obtained copies of the serological reports. (For an account of how this evidence was obtained in the face of strenuous official opposition, see Section 5.2. False Claims Made by the Wuppertal Court) These serological reports contain the following information pertaining to Freimark's blood tests:

*August 14, 1944: "Titer 1:800"*

*August 29, 1944: "Titer 1:800"*

*September 8, 1944: "Titer 1:200"*

"Titer" is the term used for the results of serological tests (degrees of dilution in agglutination tests). titers are first measurable a minimum of two weeks after the onset of illness, and often "*not until much later, approximately 30 days*" following onset. Values begin at 1:100. As the illness progresses, titers slowly increase to 1:400 or more.

*"The agglutinative potential persists for many months following recovery from the illness."*<sup>35</sup>

A titer of 1:800 on August 14, 1944, (sample of August 13, 1944) means that Freimark must have contracted typhus long before that date. All the medical experts consulted agree on this point. Further, the titer of only 1:200 (September 8) indicates that Freimark's convalescence was already well advanced at this time. Therefore, Freimark must have been severely ill with typhus prior to August 1944, in other words, in June/July 1944 as he had stated originally. To establish this as evidence relevant to the Court, Weise's attorney has requested the consultation of a Court-approved expert – but his requests, submitted repeatedly for several years now, have been in vain.

But even without an expert medical report, it can be proven that Freimark's illness cannot have begun after September 1944, since as Freimark himself testified, he had participated for at least a few weeks in the preparations leading up to the crematorium Uprising of October 7, 1944. The only remaining possibility, namely that he fell ill before August 1944, is confirmed by many other statements of Freimark's. His initial claim that he fell ill "*in late May 1944*" is supported in many ways by his further statements.

In its decision of revision, the District Court of Mönchengladbach again ignores the significance of the "*sterile*" entries, it again ignores the regulations for epidemic control that were in effect in those days, and it again rejects the consultation of an expert. Weise's attorney had requested "*an expert report, to be drawn up by an epidemiologist specializing in hygiene and bacteriology*". As the Wuppertal judges before them, their colleagues in Mönchengladbach now claim with universal expert knowledge that the lab reports give no indication of any "*final check-up*". But while the Wuppertal judges still maintain that Freimark's hotly contested bout of typhus took place sometime between August 14 and September 18, 1944, the District Court of Mönchengladbach does at least realize that Freimark was not acutely ill with typhus during this time. From the perspective of the Motion for Retrial the defense fully agrees with this. But what the District Court of Mönchengladbach would also like to sweep under the carpet is the question of when exactly Freimark should have undergone the acute stage of his severe case of typhus, if not in June/July 1944? Understandably enough, this question is a very uncomfortable one for the supporters of the verdict. In Freimark's statements, his resistance activities account so fully for the time from September 18, 1944, to the Crematorium Uprising (October 7, 1944) that no sufficient time remains. The time of his long and severe illness, which no one disputes, can thus have been only before August 1944, *i.e.*,

---

<sup>35</sup> According to Helmut Denning, *Lehrbuch der Inneren Medizin*, 6<sup>th</sup> ed., Thieme, Stuttgart 1964, pp. 86ff.

in June/July 1944. **And if one will concede this, one must also concede that the only supposed eyewitness could not possibly have been at the alleged site of the crime at the alleged time.**

### 3.2.1.2. Freimark's Testimony Regarding the 'Klehr Case'

Aside from the complete sequence of laboratory reports, other new evidence also supports Freimark's original statement that his illness began in late May 1944. This evidence comes in the form of statements made by Freimark before he knew where the emphasis would need to be placed in the Weise case. In 1968, for example, he stated that he had been admitted to the infirmary in May 1944, with typhus. He then recounts how he was able to observe Dr. Mengele and the medical orderly (*Sanitätsdienstgrad*) Josef Klehr at their experiments on inmates when he "*was already feeling better*".<sup>36</sup> By this time his severe illness (102, 104, 106.3°F fever<sup>37</sup>) had abated and he was up and walking around as convalescent. His severe illness must therefore have abated in July 1944 at the latest, for it was found in the Auschwitz Trial in Frankfurt that the orderly Klehr had been transferred to the satellite camp Gleiwitz in July 1944. According to the *Auschwitz Chronicle*,<sup>38</sup>

"[...] from July 1944 [Klehr was] director of the prisoners' infirmary in the auxiliary camp Gleiwitz I [...]."

In his 1968 testimony, Freimark reported in detail about many of Dr. Mengele's atrocious deeds, all of which he – Freimark – had seen with his own eyes. And:

"Klehr, the orderly, always accompanied Dr. Mengele."<sup>39</sup>

So Freimark did not see Klehr only once, he saw him a great many times. And, of course, he could not have seen everything he described in just a single day; he needed weeks of observation. This permits only one conclusion: to allow for his observation of Klehr and Mengele, Freimark's severe case of typhus must have been clearing up in early July 1944 at the latest.

In its decision of revision, the District Court of Mönchengladbach suggests that it might well have been the case that Freimark was in the infirmary on several occasions. After all, the witness had also stated that he had once been beaten by Dr. Senteler. In suggesting this, the District Court of Mönchengladbach ignores the precisely documented organization of the health care facilities in the Auschwitz concentration camp. The Court completely ignores the fact that inmates were admitted to the infirmary only after being examined by Chief Physician Dr. Zenkteller (not "*Senteler*"; cf. also Section 3.2.5); that they could not simply drop in to visit friends whenever they felt like it; that Freimark himself recounted his experiences with Dr. Zenkteller several times, relating to his bout of typhus; etc.

<sup>36</sup> Freimark's testimony in Tel Aviv, Nov. 20, 1968; doc/172. Regarding quoting method "*doc/nnn*" (here doc/172): a voluminous dossier has been compiled about the numerous claims and data by and about Freimark. Interested persons may obtain a copy in return for photoduplication costs. Aside from the transcripts of earlier witness testimony by Freimark, this collection also contains two longer reports or accounts by Freimark:

- 1) "*Einsam in der Schlacht*" [Lonely in Battle], Freimark's autobiographical account in the Suwalki book of 1989 (*Jewish Community Book Suwalki and Vicinity: Baklerove, Filipove, Krasnopole, Psheroshle, Punska, Ratzk, Vizhan, Yelineve*; The Yair – Abraham Stern – Publishing House, Tel Aviv 1989); texts are partly in English, partly in Hebrew; Freimark's story has been translated from the Hebrew.
- 2) Freimark's Yad Vashem report; recollections from 1959, records from 1962 and 1964. (Originally translated into German from the Yiddish [in Hebrew script].)

<sup>37</sup> Yad Vashem report, pp. 72, 82; doc/156, 162.

<sup>38</sup> D. Czech, *Auschwitz Chronicle, 1939-1945*, Henry Holt, New York 1989, p. 816.

<sup>39</sup> Freimark's eyewitness testimony in Tel Aviv, Nov. 20, 1968; doc/173.



### 3.2.1.3. Freimark's Statements on the Course of his Illness

Freimark's case of typhus must have been very severe indeed. In his Yad Vashem report, Freimark recounts – as mentioned before – that he had frequently run temperatures of 102 to 106.3°F.<sup>39</sup> Also, probably because he was confined to his sick-bed for so long, he had developed a painful abscess on his posterior.<sup>40</sup> While he was in bed suffering badly from this abscess, the following had allegedly been recorded on his card [hospital chart?]: “*Grober Vital 1/800.*”<sup>41</sup>

The question remains open whether this Gruber-Widal test is one of those known to us from the lab reports or whether a test of this kind was already performed during the acute stage of the illness. The latter cannot be ruled out in light of the evident severity and duration of the illness. In his testimony of 1966, Freimark also remarked that he was “*laid up*” with a case of stomach typhus.<sup>42</sup> In his testimony of 1968, already cited repeatedly, he reiterated that he had contracted typhus (in May 1944), then added that he made his observations of Mengele and Klehr “*when I was feeling better again.*” So he must have been rather poorly before. And he must have been very considerably improved over the time when he still suffered so severely from the dressed abscess on his posterior, since he could not have taken the excursions he described while being padded and bandaged as he was. The abscess, in turn, was the result of protracted confinement to bed combined with the uncontrolled voiding of urine and stool typical for stomach typhus. This too shows that the illness must have begun long before the time “*when I was feeling better again.*”

The acute manifestation of his illness, accompanied with collapse and fever up to 106.3°F, which he still stressed vigorously in 1962, rules out that the illness did not break out until August/September 1944. A lengthy series of lab tests intended to identify and confirm the disease would have been utter nonsense, given the intensity of the outbreak and the unmistakable symptoms.

All Freimark's pre-1988 statements regarding his bout of typhus indicate that he was severely ill, and for a correspondingly long period of time. A case of typhus that severe takes weeks from the time of outbreak to the time it abates. But as demonstrated in the foregoing, the illness must have begun to abate by early July 1944 at the latest, else Freimark could not have observed Klehr's misdeeds “*frequently*”. Freimark's severe bout of typhus, which lasted several weeks, must thus have begun in early June 1944 at the latest. This coincides with the time he specified in 1968, namely “*late May 1944*”. Hence his earlier statements support his testimony of 1968.

Aware though it is of this, the District Court of Mönchengladbach, in its decision of revision, has turned a blind eye to the fact that Freimark allegedly made his observations of Mengele and Klehr when he was recovering again – in other words, *after* his severe illness. The Court suggests instead that Freimark had no doubt been in the infirmary repeatedly. The Court thus ignores not only the fact that Freimark himself had recounted his observations of Klehr in express connection with his recovery from typhus. It also ignores the organization of the health care facilities, which are set out in particular detail in the documentation pertaining to Auschwitz. Without being admitted by the Chief of the Out-Patient Department, Freimark could not have gained access to the sickward, much less to the isolation ward for epidemic patients, which is where he claims to have made his observations. As lab documents prove, Freimark was assigned to Infirmary Compound BIIf. The admitting physician in the accompanying Out-Patient Department BIId was the Polish Dr. Zenkteller, whom Freimark recollects in a very emotionally charged manner, and again in close connection with his case of typhus (cf. also 3.2.5.).

---

<sup>40</sup> Yad Vashem report, pp. 79, 80; doc/160.

<sup>41</sup> Yad Vashem report, p. 80; doc/161.

<sup>42</sup> Freimark's statement in Tel Aviv, April 29, 1966; doc/168.

#### 3.2.1.4. Freimark's Testimony Regarding his Collaboration in the Preparations for the Crematorium Uprising

Freimark was not ill in August/September 1944. The complete series of lab reports from August 13 to September 18, 1944, proves this. Could Freimark have been so severely ill with typhus *after* September 18, 1944, (when he was healthy, as proven) and *before* October 24, 1944 (when he was also clearly healthy, and on his way to Sachsenhausen)?

An affirmative answer to this question is already practically ruled out, since the five weeks remaining between September 18 and October 24, 1944, would hardly have been enough to allow for the severe illness *per se*, much less for the mandatory subsequent quarantine that was necessary to establish freedom from infection prior to the transfer to another camp.

But Freimark himself provides us with another piece of evidence for the recovered state of his health after September 18, 1944. According to him, he participated in the preparations for the Crematorium Uprising in close co-operation with Salman Gradovski.<sup>43</sup> The Uprising took place on October 7, 1944. Freimark's involvement must have come after his illness. In Wuppertal, too, it was expressly noted that in his new testimony Freimark "*placed the subsequent Crematorium Uprising in close temporal proximity to this [i.e., the time of his illness].*"<sup>44</sup> This is correct, except that the entire illness cannot be slotted into August/September. That was only the time of convalescence and final check-up. The series of lab reports proves this beyond doubt. But the actual time of illness *per se* was in June and July, 1944.

In its decision of revision, the District Court of Mönchengladbach completely disregards the issue of how Freimark's severe illness (which is proven beyond doubt) is to be fitted into the time-table of the events in question.

#### 3.2.1.5. Freimark's Testimony Regarding His Recall to the 'Canada' Commando at the Beginning of the Hungarian Transports

*"When the Hungarian transports began, I was recalled to work in 'Canada'. That was where we realized why they wanted us to purge the camp of Jews. They arrived day and night, these transports from Hungary. We worked on the ramp, and it was very hard. One transport after the other arrived."*<sup>45</sup>

This statement of Freimark's in his report of 1959/1962 once more solidly corroborates his very definite testimony of 1968, that he rejoined the 'Canada' Commando in May 1944. According to the *Auschwitz Chronicle*, the Hungarian transports, whose start was the occasion of his recall, began in mid-May 1944.<sup>46</sup> Freimark's initial statement, that he fell ill shortly after this recall, fits in perfectly with the date he first gave for the start of his illness: late May 1944.

In its decision of revision, the District Court of Mönchengladbach ignores this completely.

#### 3.2.1.6. Freimark's Testimony Regarding His Further Convalescence During the Time of the Transports from Lodz

In his Yad Vashem report,<sup>47</sup> Freimark gives a detailed account of his stay in the infirmary while continuing to recover from his illness. According to Freimark, this rather lengthy stage of convalescence coincided with the time of the transports from Lodz – in other words, August/September 1944. This, in turn, coincides perfectly with his statement that he had fallen ill in late May 1944.

<sup>43</sup> Suwalki book and Yad Vashem report; doc/108, 109, 111, 139, 141, 142, 145, 152ff.

<sup>44</sup> Verdict, p. 75; doc/177.

<sup>45</sup> Yad Vashem report, p. 53; doc/146.

<sup>46</sup> D. Czech, *op. cit.* (note 38), p. 627.

<sup>47</sup> Yad Vashem report, p. 83-84; doc/162, 163.

In its decision of revision, the District Court of Mönchengladbach ignores this completely.

### 3.2.1.7. Summary of Section 2.2.1

Gottfried Weise's attorney has been pointing out for years that the lab reports do not disprove Freimark's illness in May 1944, but that rather they are powerful evidence for the correctness of this initial statement. Strangely enough, none of the authorities whose duty it is to ensure that justice is done has shown the slightest interest. Now, however, this evidence – which is already of great consequence by itself – is solidly supported by further new evidence. These further evidential pillars resulted from statements of Freimark's which were no less unknown to the Wuppertal Court than the complete sequence of lab reports, which therefore also constitute new evidence.

The new evidence supporting Freimark's 1968 statement ("*onset of illness in late May 1944*") include:

1. Lab reports Nos. 1 and 7, which had been misapplied by the Wuppertal Court, as well as the lab reports Nos. 2 through 6, discovered later – *i.e.*, the entire sequence of lab reports, Nos. 1 through 7. This documentary support of Freimark's 1968 testimony – very solid support indeed – is reinforced five-fold by the following new evidence contained in other statements of Freimark's:
2. Freimark was in the infirmary by June 1944 at the latest. Only in this way could he have observed Klehr at his misdeeds when his illness began to abate, *i.e.*, in July 1944 at the latest.
3. Freimark's illness was very severe, and lasted a proportionally long time. It cannot have begun after the "*sterile*" test results of September 9 and 18, 1944, because on October 24, 1944, he was already healthy and being transferred.
4. In late September/early October 1944 Freimark, then healthy, collaborated in the preparations for the Crematorium Uprising. Thus, he cannot have been ill at this time.
5. Freimark himself dates his transfer to 'Canada' as mid-May 1944. He recalls the time of the transfer: "*When the Hungarian transports began [...]*". The Hungarian transports began in mid-May 1944.
6. Freimark was still convalescing at the time the transports from Lodz arrived, *i.e.*, in August/September 1944.

With reference to the Court's statement that "*the credibility of this witness is beyond question*", only one conclusion is possible: Freimark himself proves that he cannot have been at the site of Weise's alleged crimes in June/July 1944. The statements he made which indicate that he fell ill in late May 1944 are considerably more plausible than his suspiciously sudden change of mind in Wuppertal, that "*in that case*" he had simply not fallen ill until August/September 1944.

In its decision of revision, the District Court of Mönchengladbach holds to the Wuppertal version.

### 3.2.2. 'The Wrong Place' – New Evidence For the Incorrect Account of the Place and Details of the Crime<sup>48</sup>

The murders which are imputed to Gottfried Weise by that part of the verdict that has become final were allegedly committed in, *i.e.*, near the old disinfestation facilities (Gas Disinfestation I) which the Court imprecisely and incorrectly termed Personal Effects Warehouse I (*Effektenlager I*).<sup>49</sup> This is where witness Jakob Freimark claims to have observed them:

---

<sup>48</sup> A more detailed study has been drawn up on this topic: Matthies/Jordan, *Der Fall Weise – Neue Beweise zur Klärung unrichtiger Ortsangaben und unrichtiger Tatvorwürfe im Urteil des Landgerichtes Wuppertal vom 28. Januar 1988*, March 1993, with supplement from May 1993. Copies of this study are available in return for photoduplication costs.

<sup>49</sup> Cf. Matthies/Jordan, *ibid.*, p. 4.

a) The convicted is said to have committed one murder in the “*Bedding hut*” on the grounds of Personal Effects Warehouse I. The witness claims to have seen this while standing amongst many other inmates in a square in the camp, from which point one could see the entrances to two identical-looking huts at the same time.

b) The convicted is said to have committed two further murders “*in the square between the loading ramp and the eastern entrance to Personal Effects Warehouse I*”. The track on

which the loading ramp was located ran along the fence, at a distance of “*approximately 30 ft.*”. Therefore, in the eyes of the Court, there was a “*square*” of about 1,080 sq. yards [33 ft. (distance between fence and track) × 295 ft. (length of the fence)] between the fence and the loading ramp.

In contrast to the alleged victims and the alleged time of the crime, the supposed sites of the crimes are described relatively precisely by the Court. This makes it possible to double-check the description of the site which the Court accepted in reaching its verdict. This layout of the site was incorrect.

In its decision of revision, the District Court of Mönchengladbach cannot dispute the incorrectness of the Wuppertal Court’s account of the site, but it deems the incorrect findings contained in the verdict to be irrelevant.

### 3.2.2.1. The Wuppertal Court’s Incorrect Layout of the Site of the Crime

Both the witness and the Court orientated their accounts of the alleged events on an incorrect layout of the site of the crime – a layout that agrees with an equally incorrect sketch that was incorporated in the verdict.

### 3.2.2.2. The Correct Layout as Shown by Documents

The following sketch, drawn to scale, shows the correct layout. This sketch is the result of careful analysis of several American air photos,<sup>50</sup> the description of Delousing Chamber I (the alleged site of the crime) as given by documents from the Auschwitz Archives,<sup>51</sup> and the book by Pressac<sup>52</sup> which is considered to be the definitive scientific work of Auschwitz literature.

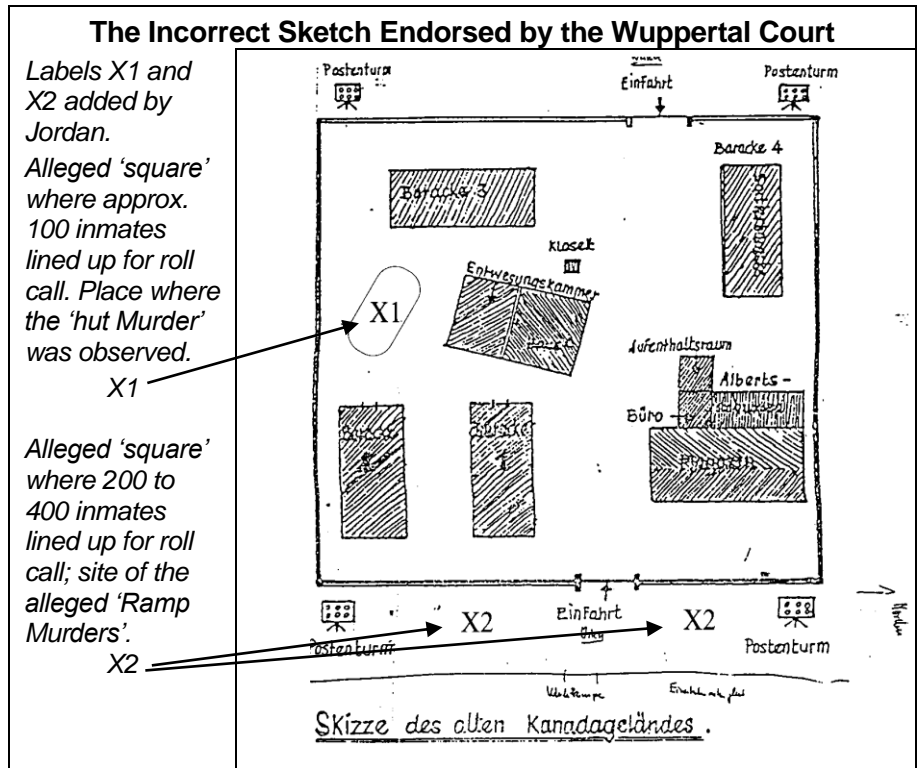

<sup>50</sup> Cf. J. C. Ball, *Air Photo Evidence*, Ball Resource Services, Delta, BC, 1993, p. 34 (online material is available at: [www.air-photo.com/](http://www.air-photo.com/)).

<sup>51</sup> Cf. *Archivum des Museums in Auschwitz. Ensemble der Erklärungen zum Raub des Opfergutes*, ch. 51, pp. 119-134,

In its decision of revision, the District Court of Mönchengladbach does not dispute that the sketch which the Wuppertal Court used to determine the location and nature of the alleged crimes is incorrect. It also has nothing with which to contest the correctness of the sketch drawn from the aerial photographs. Nevertheless, the Court states “*that the US air photo of August 25, 1944, by itself cannot reflect the conditions in the camp at the time of the crime, in June/July 1944 [...]*”. This claim is utterly incomprehensible, since the District Court of Mönchengladbach, according to its own account, has also seen the US air photos of April 4, 1944, May 31, 1944, and December 21, 1944, which – together with other evidence – served to verify the sketch.

### 3.2.3. ‘The Wrong Scenario’ – Correction of the Alleged Layout Shows: the Scenario Attested to Would Have Been Physically Impossible

The Wuppertal Court based its conception of the layout of the site in question not only on the incorrect sketch but also on witness testimony, particularly on the testimony of the witness Freimark. The Court had affirmed that this witness recollected the site in particularly precise detail. And indeed, he described almost a dozen incorrect details precisely as they appear, incorrectly, on the Court’s sketch. Witness Freimark obviously was not familiar with the alleged site of the crime from personal memory; he merely went by the faulty sketch.

First of all, two very essential details were wrong:

1. The alleged empty space (“square”) where Freimark claims to have stood among “many” inmates while witnessing a crime was in fact taken up by a hut (No. 5 in the previous sketch) of which Freimark obviously had no knowledge. Freimark and his fellow inmates could not have stood here. Also, there was no other place large enough to accommodate a greater number of inmates which would have met the requirements of the scenario described by Freimark (two huts doorways directly visible).

In its decision of revision, the District Court of Mönchengladbach suggests that perhaps it was not 100 inmates who were lined up. Freimark and the Wuppertal Court had only mentioned “many”. But the work commandos named by the Wuppertal Court, and the information provided by the *Auschwitz Chronicle* regarding their numerical strength, does indicate a num-

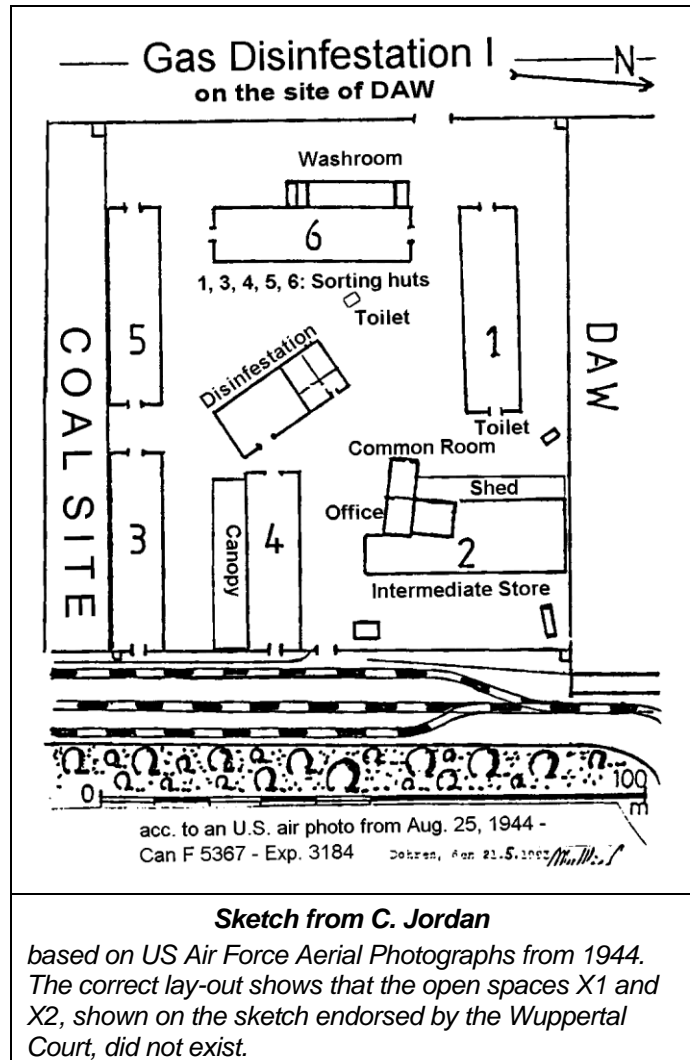

report of former inmate Josef Odi.

<sup>52</sup> J.-C. Pressac, *Auschwitz: Technique and Operation of the Gas Chambers*, Beate Klarsfeld Foundation, New York 1989.

ber of approximately 100 inmates, calculated as set out in the Motion. Happily, these calculations are facilitated by the many Auschwitz work detail lists still available which show the precise numerical strengths of the work details which, according to the Wuppertal Court, were present at the site of the crime. Once again, any factual resolution of this matter has been rejected. The District Court of Mönchengladbach has also completely ignored the second important matter: according to the Wuppertal/Freimark scenario, Freimark would have had to be able to see directly into the entranceways of two huts resembling each other in every detail. The correct sketch, however, shows that the huts were by no means that similar, and that there is no conceivable place from which both hut's entrances could be directly looked into at the same time. *The* District Court of Mönchengladbach ignores the fact that this proves Freimark's account of the crime to be false.

Especially where the two allegedly identical huts are concerned, Freimark's account of the crime is typical of the way in which 'truth was ascertained' in this case: originally – *i.e.*, at the time of his first questioning in Israel – Freimark knew of only one hut, where all the characters who played a part in the 'hut murder' got together. In the Wuppertal trial, Freimark then saw the (incorrect) sketch of the camp, where two identical huts are (falsely) drawn in. The sketch inspired Freimark, and he *revised* his initial testimony (the single-hut version) into a two-huts scenario. He now redistributed the participants in this drama between two huts, for a particularly theatrical account of the alleged events. As proof of his veracity, he concedes that he is no longer sure whether the "*Bedding hut*", the actual scene of the crime, was the right-hand or the left-hand one of the twin huts. The Court was so filled with enthusiasm by his nit-picking love of truth and his detailed knowledge of the scene that it completely overlooked the trap: the two-huts version works only on the fictional scene of the crime, on the incorrect camp sketch – not on the real scene. It does not fit the real layout; Freimark's account of the crime, and the 'findings' based thereon in the verdict, are false.

2. The scenario of the alleged crimes b), the 'ramp murders', is based on the following: hundreds of inmates, working day- and night-shifts, loading up a long freight train of "*thirty to forty*" freight cars, unloading it again, and re-loading it again. Hundreds of tons of freight must be passed in bundles along long queues of inmates. With utter disregard for blackout regulations, the large open space between the fence and the ramp is lit "*bright as day*" by the floodlights on the fence. Three inmates manage to set up a hiding place in one of the many freight cars, bring in a supply of food and water, and hide themselves there. Their absence is not noticed until shift change. After hours of counting and roll-call, the inmates must begin unloading all the freight cars again. In the presence of hundreds of other inmates, the fugitives are found, beaten, and murdered. The time is approximately midnight.

The facts, however, are as follows: the loading rail-line ran right along the fence. Thus, the ramp did not give access to a "*square*" 295 ft. long and 33 ft. wide, but rather only to a strip at most 3 ft. wide and at most 98 ft. long (approximately 33 sq. yards). There were also no floodlights on the fence and no night-time illumination "*bright as day*". As well, there were no "*thirty to forty*" freight cars. The entire loading track could have accommodated a maximum of six freight cars, and no more than three would have fit alongside the little ramp directly by the fence. (The former inmate Josef Odi, who – unlike Freimark – was familiar with the old Gas Delousing Chamber, and had described it correctly, had already considered it remarkable indeed that on some days as many as "*several*" freight cars could be loaded!)

In its decision of revision, the District Court of Mönchengladbach avoids commenting on the physical impossibility of the "*thirty to forty*" freight cars in a most unusual way: while quoting the verdict verbatim at all other times, in this instance the Court simply omits the claim of thirty to forty freight cars in its quotation from the verdict. Was this deliberately omitted, or done

so through sloppiness? The District Court of Mönchengladbach does not comment on the other errors in Freimark's account which prove his unfamiliarity with the site. Further, the District Court of Mönchengladbach attempts to gloss over the physical impossibility of setting up the work commandos (as specified by the Wuppertal Court) between the rail line and the fence by arguing rather weakly:

First, according to the Motion, there was a distance of 8.9 ft. between the rail line and the fence, and second, the work details surely did not number as many inmates as the Motion calculated on the basis of statements of the Wuppertal Court and of data from the Auschwitz Chronicle.

Regarding the first objection, the District Court of Mönchengladbach failed to take note of the information it had with respect to rail and loading facilities. Otherwise it would at least have noticed that freight cars protrude over the rail line, *i.e.*, that there were by no means all of 8.9 ft. of open space between the cars and the fence, but rather 5.6 ft. at most. The Court would have had to realize that it was not possible to walk or stand immediately next to the fence, that a usable strip approximately 3 ft. wide was all that remained, and that this strip as well was no longer than just barely 98 ft. (including space for guards at the sides). A closer look would have revealed to the District Court of Mönchengladbach that it was impossible for more than twenty persons to line up, much less to work here under guard. And there would have been absolutely no space left for the alleged beatings and murders to take place and – to quote Freimark – to be observed in detail by all the inmates present.

Regarding the second objection, it is rather amazing that the District Court of Mönchengladbach suddenly casts grave doubts on the data given in the *Auschwitz Chronicle*, that source which it otherwise deems so extremely reliable (namely, when the data it provides serves to incriminate), and it is all the more surprising that the Court does so without even having examined the documents cited therein (work detail lists). Well, never mind! Loading, unloading and reloading the thirty or forty freight cars, as was described and “*ascertained*” by the Court, would have required a great many workers, and the Wuppertal Court also stressed this repeatedly. But where should these have found enough room under the actual conditions? The District Court of Mönchengladbach leaves this vital question completely open.

Investigations pertaining to the alleged site of the crime reveal many other discrepancies, which confirm two things:<sup>53</sup>

- Freimark testified to many local details that exist only on the incorrect Court sketch, not in actual fact. He clearly had no personal memories of the site.
- Many of the incorrect details “*ascertained*” by the Court are integral parts of the scenario which is the basis for the account of the crime and the corresponding ‘findings’ of the Court.

These two points alone prove that the testimony of the witness Freimark, and the account of the alleged events subsequently set out in the verdict, are false.

### 3.2.4. ‘The Wrong Gottfried’

In the Wuppertal trial, witness Freimark repeatedly declared that the accused was “*indelibly impressed*” on his memory as “*Gottfried*”. This was rather surprising even then, for in his earlier testimony – those samples of it which were known at that time – Freimark had never mentioned Gottfried Weise, the man who was allegedly so indelibly impressed on his recollections.

---

<sup>53</sup> For details cf. Matthies/Jordan, *op. cit.* (note 48).

### 3.2.4.1. New Evidence: the Real Gottfried of Freimark's Recollections

In the meantime, lengthy reports and witness statements of Freimark's have come to light which were not yet known at the time of the Wuppertal trial. In 1959/1962, for example, Freimark wrote a very long report for the Yad Vashem, detailing everything he remembered about Auschwitz. Freimark clearly spent years intensively reviewing his Auschwitz memories for this purpose, and these accounts contain something quite astonishing: at that time, Freimark recollected a completely different Gottfried (and *only* this different one):

*"When Oskar [an inmate chief overseer] was sent home, he was replaced by another German, named Gottfried. He was from the Sudetenland. He was a terrible son-of-a-bitch. An assistant overseer served under him, a Belgian named Leon. The two of them were dreadful murderers."*<sup>54</sup>

So in 1962, Freimark clearly associated the name Gottfried with an inmate. Freimark had to endure his tyranny when he was "*skilled laborer in the weaving mill*". And if he *had* remembered more than one murderous son-of-a-bitch named Gottfried, is it really credible that he would at that time (1962) have mentioned exclusively the one of whom he only knew in very general terms that he was a "*terrible son-of-a-bitch*" and a murderer, and would have completely forgotten about the very memorable one-eyed Gottfried Weise even though – according to Freimark's testimony of 1985 – he had observed *this* Gottfried commit several very definite murders, at great peril to his own life?

### 3.2.4.2. The Wuppertal Theory of "Successive Reproduction"

The Wuppertal Court believes it has found a way to explain the workings of Freimark's memory. The Court explained that despite the great passage of time "*his 'simple' recollection... of the central event [showed] the high degree of accuracy of his recollections.*" Further, the Court exhibited psychologically motivated empathy for the way in which Freimark first did not, then did remember things.<sup>55</sup> The witness, the Court explained, successively reproduced his memories around emotionally charged focal points and had thus not been affected by external influences.<sup>56</sup>

To Freimark, the name "*Gottfried*" was no doubt a "*focal point*" for the reproduction of "*emotionally charged fragments of memories*". Does it not seem reasonable to suspect that Freimark "*successively reproduced*" the wrong Gottfried?

### 3.2.4.3. How was the Accused Identified?

In the trial of Gottfried Weise, the identification of the accused was carried out in a gross deviation from any serious recognition process.<sup>57</sup> As already mentioned in the context of Isaac Liver's statements, potential witnesses for the prosecution were given a questionnaire providing information regarding the suspect and the charges brought against him.<sup>58</sup> An accompanying series of photographs included several of the accused, which, however, is probably of lesser importance in this case, as the one-eyed Gottfried Weise is easily identified anyhow. It is thus no surprise that Freimark, who had several opportunities to study the photos, knew very well which of them showed the accused. And as though that had not been a bad enough travesty of the identification process, the Wuppertal Court even permitted the staging of this farce in the courtroom:

<sup>54</sup> Yad Vashem report, p. 63; doc/151.

<sup>55</sup> Verdict, p. 187; doc/180.

<sup>56</sup> Verdict, p. 188; doc/181.

<sup>57</sup> Cf. the works of Prof. Dr. Michael Stadler, Institute of Cognition Psychology, University of Bremen; cf. esp. Stadler/Fabian/Wetzels, "*Wiedererkennen des Täters oder Identifizieren des Beschuldigten?*", in *Bremer Beiträge zur Psychologie* 100(1) (1992).

<sup>58</sup> Regarding similar practices in medieval witch trials, see the chapter by M. Köhler, this volume.



“*Much as though a great weight had suddenly lifted from his shoulders, he [Freimark] said that he had immediately recognized ‘Slepak’, ‘Gottfried’, when he had entered the courtroom, and then, looking at the accused, he continued: ‘Yes, that’s him. Let him take off his glasses. He wasn’t wearing glasses back then. I’m inmate 87215. Do you recognize me?’ Flipping back and forth in the photo folder that he had been given, and getting more excited and upset by the second, he identified the accused after only a few moments: ‘I’m looking, and I think I’m in Auschwitz again. That’s him (photo 8). No doubt about it, that’s him (photo 14). I saw him like that (photo 2). That’s him too. There’s no doubt, these pictures show Slepak. That’s the man sitting here today.’*”<sup>59</sup>

#### 3.2.4.4. The Wrong Gottfried: Result of “*Successive Reproduction of Emotionally Charged Remnants of Memories*”

Freimark’s considerable prowess as an actor in the Wuppertal courtroom shows how thoroughly he was able to embrace a role that accrued to him from successive reproductions of his memory. How could the wrong “*Gottfried*” have evolved in his mind?

When he was first questioned about Gottfried Weise in 1985, the name “*Gottfried*” was still “*indelibly impressed*” on his memory, but any recollections of the actual person had already faded. He is then questioned quite pointedly about a presumed murderer named “*Gottfried*”. To Freimark this name is a focal point for emotionally charged remnants of memories. One of his emotionally charged remnants is the certain belief that all SS-men employed in Auschwitz “*participated in the machinery of murder.*”<sup>60</sup> Two emotionally charged remnants now combine in his mind to produce a new “*focal point for successive reproduction*” in a fictional construct that is growing ever more real to him. A photo album is placed before him, showing men wearing the hated uniforms of concentration camp guards. Unlike the others, one of them is portrayed several times. He has only one eye – that makes him stand out: “*Sleepy*”, or “*Slepak*”, whom they had specifically asked about! And his name is Gottfried! Goodness gracious! Freimark now feels certain that he has found his man. All that’s still lacking is the appropriate story. And Freimark proceeds to successively produce memories of other emotionally charged remnants, drawing on things experienced, read and heard: the story that inmates who had hidden in a freight car were shot. Of course...:

Hadn’t he, Freimark, actually seen that happen himself? – Let’s see, what was that all about again? – Right: an inmate from Grodno<sup>61</sup> – or was it two?, and Graf had shot him?<sup>62</sup> – Were there perhaps even more of them? – But of course: there were three, and two of them were shot by “*Gottfried*”. – Yeah, sure, he’d already been a “*dreadful murderer*” back in the weaving mill. – And where did he shoot the two of them? – Well, surely there were freight cars to be loaded, standing outside the “*Old Canada*” area, and the fellow in charge there used to shoot, too.

So was that “*Gottfried*”? – Of course, who else should it have been, if not that “*terrible son-of-a-bitch*”? Sure, he was the one! – Incidentally, his surname was Weise. – Oh really? Well, I still think of him by his first name.

What’s that? 1944, not 1943? Well, all right then!!! 1944!

---

<sup>59</sup> Verdict, p. 183; doc/179.

<sup>60</sup> Verdict, p. 182; doc/179. Again, there are parallels to the witch trials: every defendant is guilty!

<sup>61</sup> For Freimark, the name of the town Grodno seems to be another focal point for emotionally charged remnants of memories. In his imaginative account of how he participated in the murder of a fellow prisoner, his accomplices are again three inmates from Grodno, who were then executed; doc/67.

<sup>62</sup> Verdict, pp. 196-197; doc/182.

Freimark of 1985 grows ever more certain. And it is not long before he can recount his subjective truth with such “*astounding accuracy and realism*” that the witness-hunting public prosecutor is ecstatic and the Wuppertal judges are all the more so.<sup>63</sup>

In its decision of revision, the District Court of Mönchengladbach comments on all this:

*“The supposition advanced by the appellant, that the witness Freimark could have confused the appellant with a functionary inmate named ‘Gottfried’ is not a statement of fact commensurate with the requirements for admissibility. The appellant has not submitted any concrete evidence pointing to such a confusion. The witnesses he has proposed to call in order to establish the state of witness Freimark’s knowledge with respect to the appellant and the inmate Gottfried are not suitable as a source of evidence because they cannot contribute anything towards establishing what the witness Freimark knew at the time.”*

[Note: the testimony of 58 witnesses, all of whom were in the same area as Freimark, had been proposed as evidence to establish that the inmates did not know their guards by their first names.]

### 3.2.5. Other ‘Wrong Gottfrieds’ in Freimark’s Accounts

It is incredible to see how thoughtlessly a German Court applies the previously described theory of “*successive reproduction*”. To emphasize how great the danger of ‘wrong Gottfrieds’ is with story-tellers like Freimark, the following gives just one example of the many other instances where Freimark has mis-identified persons:

In his Yad Vashem report (1959/1962), Freimark describes how the infamous Dr. Mengele, assisted by Dr. Knott and Dr. Schor, took a quart of his blood.<sup>64</sup>

In his 1966 testimony regarding Sachsenhausen, Freimark then claimed that a Dr. Senteler (correctly: Zenkteller) had taken this quart of blood.<sup>65</sup>

In his Suwalki report of 1989 (“*Einsam in der Schlacht*” [Lonely in Battle]) he again names Dr. Mengele and Dr. Knott as having taken the blood, but this time without mentioning Dr. Schor.<sup>66</sup>

Freimark’s memories focus on a central event, namely the taking of the blood. His tendency to exaggerate turns the quantity into an entire quart. But nevertheless: the taking of the blood – the central event – very likely did indeed take place. The acting persons, on the other hand, are freely exchangeable in Freimark’s imagination. It is easy to see why Freimark named Dr. Zenkteller (1966) as being the one who had taken the blood: Freimark hated this physician and in 1966 accused him of, among other things, having carried out “*selections*”. The central experience was that this inmates’ physician had had to decide which patients were to be admitted to the infirmary for treatment. Freimark’s penchant for exaggeration turned this into “*Selections For The Gas Chambers*” – a charge which, as is well known, bodes ill for anyone accused thereof. Unlike Gottfried Weise, however, Dr. Zenkteller was lucky: he was Polish, was given a fair trial in Poland, and was acquitted.<sup>67</sup> Had he been German, the matter would no doubt have ended tragically for him too.

<sup>63</sup> According to the Court (Verdict p. 196; doc/182) two inmates were indeed shot by one *Unterscharführer* Wigleb in 1943 after attempting to hide in a wagon under some things that were to be shipped out. Because of the 1943 incident, former *Unterscharführer* Graf was charged in Vienna as accomplice, but was acquitted. According to Freimark, in 1944 he was again an accomplice in a precisely identical event, this time committed together with Weise. Clearly Freimark had heard about the event of 1943 and proceeded to impute it to Gottfried Weise. Incidentally, Freimark had originally stated 1943 as the date for this event as well, and it took the joint efforts of the Prosecuting Attorney and the judge to persuade him to revise the date to 1944.

<sup>64</sup> Yad Vashem report, p. 72; doc/160ff.

<sup>65</sup> doc/167, 168. In the transcript it was first typed, then crossed out with the same typewriter: “*also took a liter of my blood.*”

<sup>66</sup> doc/139.

<sup>67</sup> *Hefte von Auschwitz*, no. 15, p. 45, footnote 90.

In its decision of revision, the District Court of Mönchengladbach does not waste time on such considerations. It did not even take note that the name of the physician accused by Freimark was actually Dr. Zenkteller. Similarly, by failing to consider this Polish physician's duties, which are known in detail, it also neglected to ensure the proper evaluation of Freimark's statements.

## 4. The 'Freimark Case'

In Freimark's various accounts, there are many other examples of persons, places and incidents being mixed up. These have been discussed in greater detail in a separate analysis of claims and data by and about Freimark.<sup>68</sup> On the basis of the statements he made in the course of the 'Freimark Case' – statements which, due to the talkativeness of the witness, are amply available – the goal-oriented nature of his testimony can be well analyzed. The overriding goals which become apparent time and again are:

- a) the desire for revenge for his incarceration, and
- b) the desire for self-aggrandizement.

Freimark adapts these overriding objectives to his individual case-oriented goals. In 1966, for example, his desire for revenge was directed against Dr. Zenkteller. When he realized that, being Polish, Zenkteller – an able Polish army medical officer, by the way – was immune to false allegations, Freimark redirected his accusations at Dr. Mengele. Freimark also manages to adapt his overriding desire for self-portrayal to the conditions presented in each individual case. In his Yad Vashem report of 1959/1962, for example, he still wrote a great deal about his heroic work for the Resistance movement of the Camp Underground, and about his no less heroic participation in the preparations for the so-called Crematorium Uprising (October 7, 1944). At that time he still gave the time of the beginning of these preparations as "*August 1944*". That fit in well with the actual beginning of his illness, May 1944. In the Wuppertal Trial, however, it was necessary for him to postpone his illness, since otherwise he could not have incriminated the accused. To prevent any conflict with his alleged heroic feats in the Resistance movement, he now gives the time he fell ill as late October 1944. This in turn clashes with his transfer to Sachsenhausen, which can be precisely dated as October 23, 1944. In writing his heroic epic "*Einsam in der Schlacht*" [Lonely in Battle] for the Suwalki book in 1989, after the Wuppertal Trial, he therefore restricts himself to only very vague comments about his participation in the Uprising of October 7, 1944, and shifts the starting date of his illness to yet another time – December 1944.

Incidentally, some American friends of a young Israeli were sent translations of the Suwalki book. At first the Israeli was so moved by Freimark's account that he did not think he could go on reading. But then he did read on. He provided the translation free of charge, annotated with the comment: "*This man is a fucking liar!*"

In its decision of revision, the District Court of Mönchengladbach:

*"The credibility of the witness Freimark is in no way compromised by this comment."*

## 5. The 'Wuppertal Case'

### 5.1. The Bias of the Wuppertal Court

In Wuppertal they were happy about Freimark's so precisely tailor-made memory. Freimark was the Court's dream witness.

---

<sup>68</sup> Matthies/Jordan, Aug. 1993: *Der Fall Weise – Neue Beweise zur Klärung unrichtiger Angaben des Zeugen Freimark und unrichtiger Feststellungen im Urteil des Landgerichtes Wuppertal vom 28. Januar 1988*. Copies of this study are available in return for photoduplication costs.

Up until then, nobody had wanted Freimark as witness. Neither in the Sachsenhausen Trial nor in the Frankfurt Auschwitz Trial had he gotten the role he longed for, and even the clerk who took down Freimark's Yad Vashem report seems to have harbored a few doubts, as his skeptical questions would indicate. But in Wuppertal, Freimark was finally given stage center. The Presiding Judge's "common knowledge" and his desire to create a memorial for the victims of Fascism provided for the proper staging of his presentation. The judge himself expounded on the nature of his "common knowledge" in the verdict; his desire for a 'memorial' was initially known to the author of this article only through hearsay, and so I made inquiries. The result: in late 1985 the Wuppertal newspaper had reported about the many deaths that had occurred in the concentration camp *Kemna* that had existed near Wuppertal from mid- to late-1933. A curious Wuppertal inhabitant asked why the names of the murdered persons were not given on the new Kemna Memorial. It turned out that, happily, there had been no casualties in Kemna at all, and the allegation of "many dead" was thus wrong. The newspaper named the City Archives as its source. The City Archives named judge Klein as theirs. And judge Klein did not consider the polite inquiry, now addressed to him, to be deserving of a reply.<sup>69</sup>

The appropriate stage-set for the trial was provided courtesy of the Wuppertal 'Antifa', the anti-Fascist scene: the VVN's metastasis whose fellow-travelers and hired applauders happened to be particularly numerous in Wuppertal and included the local press. The trial which was then enacted in Wuppertal has already been reviewed in detail in the book *Der Fall Weise*:<sup>70</sup> the bias exhibited by the Wuppertal Court, the disparate treatment and valuation of the witnesses for the prosecution and the defense, the refusal of numerous motions to hear evidence, and the suppression of exonerating evidence. I have already mentioned a further example of the suppression of evidence practiced in Wuppertal (Section 3.2.1.1, lab reports). A separate report<sup>71</sup> discusses further aspects of the one-sided valuation of evidence in Wuppertal, and I will dispense here with a repetition of the details set out in the book and the report. Copies of the book were sent to all the members of the *Bundestag* [German parliament], and the report went to all those persons directly responsible: the Federal President, the Federal Chancellor, the Federal Minister of Justice, the Chief Minister in charge, and the regional Minister of Justice. The response: with a few exceptions, there was a general denial of responsibility, references to the separation of powers, and referrals to the Public Prosecutor's Office, which in turn states succinctly that it perceives "no need for action" without responding to so much as a single one of the arguments submitted.

This situation is not only unfortunate for the individual tragic case in question, but should be a cause of sleepless nights for anyone concerned about how far Germany is actually under the rule of law.

## 5.2. False Claims Made by the Wuppertal Court

The Wuppertal Court made several false claims. A number of them have been known for some time. For example, it has been proven ever since 1990 that the Court's claim that no further documentation was available regarding Freimark's illness was false (see Section 2.2, 'New Evidence').

<sup>69</sup> Copy of the unanswered letter, C. Jordan's files.

<sup>70</sup> Rüdiger Gerhard, *Der Fall Weise – Dokumentation zu einem Auschwitz-Birkenau-Prozeß: Ein "Lebenslänglicher" fordert Gerechtigkeit*, 2<sup>nd</sup> ed., Türmer, Berg am See 1991. For example, see pp. 31-33, statements of Dr. Hans Eisenschimmel (not read into evidence) and Henry Isaac Liver (ignored); p. 51, refusal to consider the 'Vienna File'; p. 60, witness Kierski (disparaged as "having insufficient perspective"); p. 73, witness Burger (exonerating evidence given by a witness for the prosecution is simply glossed over and explained away).

<sup>71</sup> Jordan, March 15, 1992: *Der Fall Weise – Fakten zum Wiederaufnahmebegehren*. Copies of this work are available in return for photoduplication costs.

Another false claim was that the medical records of convalescing patients were always marked “*typhus still suspected*” (see Section 3.1.7.2, ‘Mis-Timed Circumstantial Evidence’).

In early 1995, particularly weighty evidence came to light regarding further false claims made by the Wuppertal Court. On January 12, 1995, Charles Biedermann, Director of the International Tracing Service in Arolsen, sent the Federal Secretary of the Interior (Bonn) the lab papers, including the serological results, that had been held back for such a long time. In his accompanying letter, he wrote apologetically that it was not the ITS’s fault that these documents had been held back for so long. In 1988 the Presiding Judge Klein had merely said:

*“The issue of decisive importance in this trial [of Weise] is the question whether the witness Jakob FREIMARK was still interned in the concentration camp Auschwitz on September 18, 1944, as the ITS had confirmed earlier in a memo to the Bavarian Landesentschädigungsamt [State Compensation Office].”*<sup>72</sup>

And further:

*“Not until now [letter, Federal Department of the Interior, December 19, 1994] have you informed us that in fact every single lab test as well as its nature and results were of vital importance in the trial.”*

Contrary to this, judge Klein gave the impression both during the trial and in the verdict that he had in fact searched for such medical records and one might be sure that none existed.

The letter of the ITS reveals, as an aside, that judge Klein must have had access to Freimark’s Compensation File. *The defense is still denied even the slightest glimpse of this file.*

## 6. General Problems Entailed in Very Late Trials

In its every stage, the Weise Trial entailed problems which most likely did not arise only in this case, but in other, similar trials as well. What happened and continues to happen in the case of Gottfried Weise, therefore, is a general model of the legal problems created by the rescission of the statute of limitations.

Now these admittedly are problems lying within the province of jurists, a province where I really have no business interfering. But I would not presume to intervene in someone else’s province if I could see someone in responsibility doing his duty there.

### 6.1. The Generation Gap

The Baden-Württemberg Minister of Justice, Eyrich, noted as early as 1979 that a generation gap was to be expected in trials taking place so very long after the alleged crimes. The process of reaching a verdict, Eyrich said, could be compromised by the fact that the younger generation, to which the judges belong, “*cannot properly conceive of the conditions and framework of the crime which they themselves, after all, never experienced.*”<sup>73</sup>

No doubt Eyrich perceived the generation problem first and foremost with respect to the evaluation of events of the war – the absolute necessity to obey orders, etc. But even in the case of Gottfried Weise, who is charged with completely private murders committed on a whim, as it were, and by no means in compliance with any orders, – even in this case the younger judges were quite unable to “*properly conceive of*” many things.

A contemporaneous witness who remembers the difficulties encountered in the cremation of the Dresden bombing victims, for example, would surely not have fallen for the atrocity tale of children being burnt alive in open-air burning pits. Or another example: anyone who had ever been on guard duty himself would certainly have wondered where Weise might have gotten the ammunition he

---

<sup>72</sup> This date of Freimark’s presence in Auschwitz had never been questioned and was not an issue at all.

<sup>73</sup> FAZ, Feb. 9, 1979, p. 5.

wasted in shooting wildly about in the camp, why the Guard Register contained not a single entry about the shootings, etc. etc.

One example shall suffice to show how completely incapable the younger generation of judges in Mönchengladbach was of understanding and “*properly conceiving of*” the conditions and situations of those days:

One of Freimark’s many ‘mistakes’ was his claim, made in the Suwalki book of 1989, that he had been interned in a prisoner-of-war camp at Allenstein. “*The camp was called Stalag 10a.*”<sup>74</sup> According to Freimark, this was where the Polish Captain Kachacinski told him:

*“I invite you to join the underground organization that we will set up. You will be the contact to all the camps. You will be the contact between the camps. You will be given work that will enable you to move freely between the camps. As electrician you will test the electrical fences.”*<sup>75</sup>

In the Suwalki book, Freimark proceeds to fill several pages describing his underground activities as electrician.

In his Yad Vashem report, he tells of similar work done in Auschwitz and refers to the experience he had gained in “*Stalag 10a*”:

*“We went to work in the Polish underground. We went around the camp and made sure that the signs were hanging properly and that the small fence in front of the electrical fence was in order. I was the foreman in this work detail because I said I was already experienced as electrician. I had already done this kind of work in Stalag 10a.”*<sup>76</sup>

In its decision of revision, the District Court of Mönchengladbach:

*“This statement also does not suffice to compromise the credibility of the witness Freimark, because on page 70 the witness only states that he had **pretended** to be an electrician in order to be assigned to a special unit, which he indeed was; and that he had been made foreman there. Thus, the witness Freimark does not claim that his presence in the Prison Camp was a matter of fact.”*

The District Court of Mönchengladbach did not even pay attention to the abbreviation “*Stalag*”. As we know, this did not stand for “*Strafgefangenenlager*” [Prison Camp], as the District Court incorrectly claims, but for “*Stammlager*” [Main Camp], which was the term for regular prisoner-of-war camps – as opposed to “*Oflag*” = “*Offizierslager*” [Officers’ Camp]. In light of this, how should the judges at Mönchengladbach have thought to ask the questions that would have immediately occurred to any member of the war generation? For example: how did Freimark, who allegedly was 16 years old at that time, ever get into a prisoner-of-war camp at all? And why were there so many Polish officers there, who after all are known to have been quartered in separate Officers’ Camps? But this did not ‘ring a bell’ for these younger judges who, luckily for them, were born too late to be subject to doubts raised by experience. Instead, they come to the easily refutable false conclusion that it was possible for Freimark to simply “*pretend*” that in Auschwitz. Even the excerpt which the District Court of Mönchengladbach quotes from Freimark’s Yad Vashem report shows that he had not said anything about ‘pretending’ there. In the Suwalki book he even proceeds to build up a whole series of his heroic deeds around his work as electrician. If the District Court of Mönchengladbach considers this work to be ‘pretense’, then it must also relegate Freimark’s entire Suwalki report to the realm of fable. In other words, it must acknowledge Freimark to be utterly unreliable, as petitioned by the defense.

<sup>74</sup> Suwalki book, p. 314; doc/120.

<sup>75</sup> Suwalki book, p. 316; doc/124.

<sup>76</sup> Freimark’s Yad Vashem report, p. 70; doc/155.

## 6.2. Wilful Application of Standard Theorems of Forensic Psychology

While the Wuppertal Court did dutifully read the textbooks on the forensic application of psychology, it stretched the theorems it found therein to the breaking point. Something which holds true for normal trials cannot simply be extended ‘as is’ to the new kind of Special Trial we have here. For example:

The forgetting process over time, which the Court did take note of in some detail,<sup>77</sup> is illustrated by a bell curve in the book by Bender, Röder and Nack<sup>78</sup>. It is downright frivolous for the Wuppertal Court to attempt in pseudo-scientific manner to apply such ‘forgetting’ bell curves in unmodified form in cases where the events to be recalled are 41 years removed, such as in the case of Freimark’s first questioning. It ought to have been noted that the ‘forgetting’ bell-curves of textbook fame are based on forgetting times on the scale of months, of a few years at the very most – not of several decades.

## 6.3. Disregarded in Wuppertal: the Tendency of Very Late Testimony to be Goal-Orientated

Bender, Röder and Nack point out that testimony given in the course of a trial is frequently geared towards a desired goal (in other words, incrimination or exoneration of the accused). For this reason, remnants of memories are often deformed to make them ‘expedient’; untruths are ‘attached’ to true details. Further they state:

*“132. Whereas the comprehensiveness and reliability of recollections deteriorate with time as a matter of course, the subjective certainty of the informants – the conviction that their recollections are complete and reliable – frequently exhibits the opposite trend: they (allegedly) become all the more certain, the farther back the actual event lies in time.*

*133. This phenomenon is related to the increased probability that remote events are more frequently ‘retrieved’ from the depths of memory because the informants have thought about, have mentally occupied themselves with the events in question. But such a resurrection of earlier memories not only reinforces thought patterns, it also falsifies and expands them. Given this prerequisite, the farther back an event is, the more our informants have ultimately forgotten how little they had remembered of the event shortly after it happened.”<sup>79</sup>*

This classic textbook speaks of even 30 days as “*long-term*”. Freimark was first questioned about the case of Gottfried Weise after 41 years, *i.e.*, 15,000 days – an intervening period 500 times as long. During this period, additional things he repeatedly heard and read influenced his memories in an emotionally highly charged manner. The ever-changing content of his testimony at different points in time speaks for itself: fading memories are overlaid with things heard, read and imagined.

The problems in ascertaining truth, as already noted for regular trials by renowned authors specialized in this field, occur all the more with exponentially increased severity in political ‘special trials’ conducted decades after the alleged fact. In the Federal Republic of Germany, the problems that arise are made taboo for reasons of foreign affairs or ‘public education’. Academic research is not subject to such fetters in the U.S.A.

---

<sup>77</sup> Verdict, pp. 187, 188; doc/180, 181.

<sup>78</sup> R. Bender, S. Röder, A. Nack, *Tatsachenfeststellungen vor Gericht*, 2 vols., C. H. Beck, Munich 1981, v. 1 p. 46.

<sup>79</sup> R. Bender, S. Röder, A. Nack, *ibid.*, v. 1 p. 48.

#### 6.4. Ignored in Wuppertal: The “*Survivor Syndrome*”

The problem of the “*Holocaust Survivor Syndrome*” received international attention at the time of the Wuppertal trial. Medical sources told me that the Ukrainian-American psychiatrist Dr. O. Wolansky was one of the leading experts on this subject today, and I was referred to a seminar he had given on this subject on January 25, 1993, at a Congress held in the Polish Consulate in New York and attended by 150 Polish, White Russian and Ukrainian physicians. To quote an excerpt:

“Well-known Ukrainian-American psychiatrist Dr. O. Wolansky explained the persistent psychological and psychiatric damage caused to the mentation of the majority of the concentration camp survivors. He indicated that in regard to Holocaust survivors alone, over 1600 medical articles and books [have been] written on this subject in the past 50 years, which resulted in the term *Holocaust Survivor Syndrome*. He explained that the true horrors and the stress of the concentration camps were forgotten by survivors with the passing of the years, and were supplanted by group fantasies of martyrdom borrowed from heard or read materials or by delusions confabulated anew. He illustrates this phenomenon with the effusive and emotional testimony in *Jerusalem of the Jewish Treblinka survivors at the Demjanjuk trial* which subsequently turned out to be what in legal terms and before a more neutral tribunal could be called prejudice and/or fabrications.”<sup>80</sup>

It was revealed in the Wuppertal trial that Freimark had been under psychiatric care. The symptoms of “*Survivor Syndrome*” which Dr. O. Wolansky listed in his seminar –

- fantasies of martyrdom borrowed from heard or read materials,
- delusions confabulated anew, and
- effusive and emotional testimony –

may be found in Freimark’s accounts in great number, in the form of ‘attached untruths’ as set out by Bender, Röder and Nack.

### 7. *Cautio Criminalis*

In advocating the rescission of the statute of limitations, Herr Schwarz-Schilling soothingly pointed to the allegedly matter-of-course maxim of *in dubio pro reo* [when in doubt, acquit]. As though to reaffirm his confidence in this practice, he released a postage stamp in 1991 (in his erstwhile capacity as Postmaster General) which commemorated the four-hundredth anniversary of the birth of a man who had made outstanding contributions to the development of the western world’s legal traditions.

At a time when all the world (he himself included) still believed in witches, Jesuit priest Friedrich Spee von Langenfeld advanced his “*Judicial Considerations Regarding the Witch Trials*”. Of course the heinous crime of witchcraft must be combated, he said, but precisely *because* witchcraft was such an especially grave crime, the accused must be granted every possible avenue of defense.

One might wish that those in charge of our justice system today would read Spee’s book and take his advice to heart.<sup>81</sup> Of course no one still believes in witches who go flying off on their brooms at night to meet with the devil. But the belief in particularly heinous crimes as a matter of “*common knowledge*” is firmly entrenched. And of course physical torture is no longer used today, unlike in the witch trials of medieval times. Even in the post-war Special Trials it has not been the method of choice since the early 1950s. But defendants accused of crimes commonly known to have been particularly heinous are still denied the full range of avenues for defense demanded by Spee more than

<sup>80</sup> News release, Jan. 25, 1993, Polish Historical Society, PO Box 8024, Stamford, CT 06905, USA; cf. Paul Chodoff, “*Post-traumatic disorder and the Holocaust*”, *American Journal of Psychology – Academy Forum*, Spring 1990, p. 3.

<sup>81</sup> Friedrich Spee von Langenfeld, *Cautio Criminalis oder Rechtliches Bedenken wegen der Hexenprozesse*, dtv, Munich 1982.



360 years ago. How, for example, was Gottfried Weise to defend himself against being branded “*the Beast of Auschwitz*” if the flaming burning-pits, the burning of live children, the mass gassings going on all around him, the meters-high flames shooting out of the crematoria chimneys were so “*commonly known*”? It was only logical for the Wuppertal judges to allow the beast thus branded no ‘excuses’.

As a high-ranking jurist informed me, one of the elements ensuring the citizen’s firm understanding of their legal position is that verdicts which have become final are not open to nitpicking. I beg to differ. Even the judicial Demigods in Black may err. It is very important to keep them from becoming ideologically blinded and subject to preprogrammed ‘errors’. The uncertainty about one’s legal position which the rescission of the statute of limitations has caused must be remedied. Even those defendants who are charged with ‘special crimes’ must be able to defend themselves without restraint, and persons who speak up in their favor must not be defamed out of hand as “*Nazi*” and potential arsonist, as it happened in Solingen to Herrn Kissel for daring to put in a good word for his neighbor Weise.<sup>82</sup>

In 1979, journalist Fromme predicted that our naturally evolved German legal traditions would be silently restored “*in about the year 2000*”. Isn’t it high time that Böckenförde’s expert judicial report is finally concluded with the analysis of a concrete legal case?<sup>83</sup> No one seems to have the courage to grasp the nettle, neither in the matter of principle nor in the individual case of Gottfried Weise. In this case, a retrial had already been requested in late 1992. A few months later, Weise’s attorney attempted to find out from the District Court of Mönchengladbach how the processing of the application was proceeding. The application could not be processed, he was told initially, because the documents requested had not yet been provided by North Rhine-Westphalia.

Then a game ensued, not unlike what we as children used to call “*Schraps lost his hat*”. The Pardons Office had the documents. No,

not that office, a different one. No, not that one either. Finally, in late November 1993, the District Court sent a memo with a voluminous enclosure. The Public Prosecutor’s Office of Cologne – the same one that had achieved Weise’s conviction – had had the files since July 1993, and had drawn up a lengthy ‘decree’ in which it attempted, with a great many words and very little content, to substantiate that the application for retrial should be refused. In a further ‘decree’ of December 1993, the Public Prosecutor’s Office brought forth additional arguments for refusal. In January 1994 Weise’s attorney submitted the refutation of all these arguments to the District Court. In late May 1994 the application for retrial was refused, which the defense appealed. The Provincial Court of Appeal at Düsseldorf refused the appeal, without hearing and without comment. The Federal Constitutional Court did not admit the appeal, on the grounds that first the Provincial Court of Appeal at Düsseldorf would have to hear the appeal it had refused earlier. And since early 1995 the Düssel-



<sup>82</sup> Cf. the flier which Herr Kissel saw himself forced to distribute because the media denied him the right to publicly correct the vicious incendiary slander that had been directed at him; cf. reprint of this flier in U. Walendy, *Historische Tatsachen* no. 59, Verlag für Volkstum und Zeitgeschichtsforschung, Vlotho 1993, p. 38.

<sup>83</sup> In the meanwhile, Prof. Böckenförde has become a judge of the German Federal Constitutional Court himself.

dorf Court of Appeal is waiting for the documents and files to resurface from somewhere within Chief Minister Rau's jurisdiction.<sup>84</sup>

How long is this playing-for-time going to continue? After two previous strokes, Gottfried Weise has just undergone a massive operation for cancer, followed by pneumonia, and has suffered a third stroke. To some, a 'natural solution' might seem the easier way out.

For as long as those responsible continue to shirk their duties, all we have left to us is the prayer which I found inscribed on an Upper Bavarian house,<sup>85</sup> invoking Saint Michael, the "*champion of justice, to stand by us in evil times*".

## 8. Addendum by Michael Gärtner

Since the first German Edition of this book has appeared, the situation of the presented case has almost sensationally changed. Due to his meticulous, unremitting efforts, the severely disabled veteran Dr. Claus Jordan has discovered facts, which place the verdict of 1988 against Gottfried in an absurd light.

### 8.1. The Documents

#### 8.1.1. Scene of the Crime

Documents about the railway connection of the *Personal Effects Warehouse I* were found in a Moscow archive. This includes documents about a delousing facility that was operated therein. These documents are being complemented by air photos of the western Allies and of the German Luftwaffe. First researches on these documents are leading to the assumption that the Auschwitz main camp only had a simple rail line passing by rather than a ramp.

#### 8.1.2. Operation of the Delousing Facility of Kanada I

Furthermore, the documents of the Moscow archive show that the delousing facility of the *Personal Effects Warehouse I* directly attached to the Main Camp was out of operation at the alleged time of the crime as it was ascertained by the court. It has been removed into the Auschwitz Main Camp before. A highly modern microwave delousing facility with a huge capacity was installed at this place. For this we succeeded in finding an up to now unknown archive, which shows the capacity of this facility. More detailed results were published recently.<sup>86</sup>

#### 8.1.3. Time of the Crime

The International Tracing Service in Arolsen, Germany, has delivered documents via the German Federal Ministry of the Interior, which prove more facts:

##### 8.1.3.1. Documents Known at the Time of the Verdict

On January 28, 1988, one day before the verdict was announced, the Wuppertal Court received documents about the typhus illness of Freimark, the only witness for the prosecution, via the International Tracing Service. Instead of involving a medical expert in the assessment, the court judged itself in its absolute power because of the "*urgency of the case*".

<sup>84</sup> Date of this writing: May 1995.

<sup>85</sup> "*O'hl.Michael 'Kämpfer des Rechts' / steh uns bei / wenn uns droht was schlechts.*" AD 1993.

Unfortunately the beautiful color photograph of this house inscription cannot be reproduced here; it was confiscated by a certain lady Prosecuting Attorney.

<sup>86</sup> H.J. Nowak, "*Kurzwellen-Entlausungsanlagen in Auschwitz*", *VffG* 2(2) (1998), pp. 87-105 (online: [vho.org/VffG/1998/2/Nowak2.html](http://vho.org/VffG/1998/2/Nowak2.html)), see his contribution in this handbook.

Dr. Jordan must be thanked for his self-sacrificing efforts, that years after the verdict more documents were found in those delivered to the court, which give additional information about Freimark. According to a renowned judge, this alone should suffice for a retrial of the case.

### 8.1.3.2. New Documents about Freimark

In a letter of January 12, 1995,<sup>87</sup> the International Tracing Service of Arolsen reported about a complete series of laboratory reports concerning Freimark via the German Federal Ministry of the Interior (The International Tracing Service is not allowed to give direct information.) The Tracing Service received these results of the “*Hyg.-bakt. Untersuchungs-Stelle der Waffen-SS Südost*” [Hygienic-bacteriological Research Department of the Waffen-SS South East] regarding Freimark, starting at August 14, 1944, ending at September 18, 1944, and including the highest research number 79698, directly from the Auschwitz State Museum. According to the book *Inventararchivale Quellen des NS-Staates*,<sup>88</sup> these files of the *Hygieneinstitut* include 151 volumes for the years 1943-1945.

According to a first statement of a medical expert, as Dr. Jordan could establish, these laboratory reports prove that the witness Freimark was not ill at the time period in which the court placed his typhus illness. On the contrary, he was probably ill as he has described in his first statement (May/June 1944).

## 8.2. Omitted Hearing of Evidence by the Court

The above quoted letter of the International Tracing Service additionally proves that the Wuppertal judge Klein did not even try to search for more detailed documents about Freimark’s illness. Judge Klein has told the Tracing Service that the only question decisive for this trial would be *if* the witness Freimark was still interned in Auschwitz in September 18, 1944.<sup>89</sup>

But the supportive Motion to Take Evidence of the defense, dating January 18, 1987, said clearly:

*“Visual assessment of the original laboratory reports at the Auschwitz State Museum, Auschwitz/Poland”.*

## 8.3. Summary

The International Tracing Service wrote in January 12, 1995:

*“Only now [December 12, 1994] we were told by you [Ministry of the Interior], that instead of this all laboratory reports as well as their method and result were important for this trial.”*

SEVEN years after the verdict, the International Tracing Service Arolsen sends TWENTY enclosures to the Ministry of the Interior! The Tracing Service had received these very documents from the Auschwitz State Museum as micro film copies already in 1978.

Gottfried Weise is sitting in prison with a life sentence, because the German judge Klein didn’t consult the evidence.

Dr. Claus Jordan died in June 21, 1995, four days before his 70. birthday. He didn’t have the privilege to finish his efforts and to see Gottfried Weise, whom he always considered to be an innocent man, back in freedom. But at the very least, he joined the ranks of those being prosecuted for their contributions and work for justice: In March 1995, the Tübingen judge Stein started judicial

---

<sup>87</sup> Ref. T/D -288240.

<sup>88</sup> Heinz Boberach p.p. Institut für Zeitgeschichte. Subtitle: “*Die Überlieferung von Behörden und Einrichtungen des Reiches, der Länder und der NSdAP*”, K.G. Saur, Munich 1991.

<sup>89</sup> Thus the Int. Tracing Service quotes the judge in its letter, note 87.

inquiries against him, because this article allegedly incites the German people to hatred against the Jews.<sup>90</sup>

With this contribution, his work on behalf of Gottfried Weise's freedom and honor, Dr. Claus Jordan courageously fought for the truth, as he always did.

His friends continue his work.

Gottfried Weise was released from detention on a mercy plea in April 1997 because he was severely ill (cancer). He died in the spring of 2000.

---

<sup>90</sup> Amtsgericht Tübingen, Ref. 4 Ls 15 Js 1535/95.



# Holocaust Victims: A Statistical Analysis

## W. Benz and W. N. Sanning – A Comparison

GERMAR RUDOLF

### 1. Introduction

Polemic discussions about the Holocaust frequently come to a dead end when one party resorts to the argument that it is after all an indisputable fact that six million persons of Jewish faith were missing after the Second World War and that therefore it does not matter in the slightest *how* these people were killed. But is the number of victims really undisputed?

In this line of argument it is usually overlooked that for a long time the figure of ‘six million’ was based on nothing more than hearsay evidence given by two German SS-bureaucrats at the International Military Tribunal (IMT), specifically the written (never verbal) deposition of Wilhelm Höttl<sup>1</sup> and the verbal but never cross-examined testimony of Dieter Wisliceny.<sup>2</sup> These men claimed they had heard this figure from Eichmann<sup>3</sup> who, however, later disputed this.<sup>4</sup> On the basis of their testimony in Nuremberg both witnesses were transferred from the defendants’ dock to the witness quarters – usually a life-saving transfer. While Wisliceny and Eichmann were later convicted and hanged, W. Höttl was never prosecuted even though he was no less deeply involved in the deportation of the Jews. He had clearly been promised exemption from punishment in return for his services as witness and, unlike Wisliceny, was lucky enough to see that promise kept.

Höttl’s recent after-the-fact apologia for his testimony of that time<sup>5</sup> contradicts what he had stated earlier, and is thus not very credible.<sup>6</sup> For details of the ways and means with which the statements of such coerced witnesses were obtained during the Nuremberg Trials, see the chapter by Manfred Köhler in this volume.

Recently, British historian David Irving marveled that as early as June 1945, in other words immediately after the end of hostilities in Europe, some Zionist leaders were able to provide the precise number of Jewish victims – six million, of course – even though the chaos reigning in Europe at that time rendered any demographic studies impossible.<sup>7</sup> Not long ago the German historian Joachim Hoffmann pointed out that the chief Soviet atrocity propagandist, Ilya Ehrenburg, had publicized the six-million-figure in the Soviet foreign press as early as January 4, 1945, *i.e.*, fully four months before

---

<sup>1</sup> International Military Tribunal, *Trial of the Major War Criminals*, IMT, Nuremberg 1947, v. XXXI, pp. 85f., and v. XI, pp. 228ff., 256ff.

<sup>2</sup> *Ibid.*, v. IV, p. 371.

<sup>3</sup> Also claimed by W. Benz (ed.), *Dimension des Völkermords*, Oldenbourg, Munich 1991, pp. 1ff.

<sup>4</sup> R. Aschenauer, *Ich, Adolf Eichmann*, Druffel, Leoni 1980, pp. 460f., 473ff., 494; regarding this Eichmann biography’s value as historical source material, cf. D. Kluge, *Deutschland in Geschichte und Gegenwart (DGG)* 29(2) (1981) pp. 31-36. See also P. Rassinier, *Was ist Wahrheit?* Druffel, Leoni 1982, pp. 90, 134; R. Servatius, *Verteidigung Adolf Eichmann*, Bad Harrach, Kreuznach 1961, pp. 62ff.; U. Walendy, *Historische Tatsachen (HT)* no. 18, Verlag für Volkstum und Zeitgeschichte, Vlotho 1983; H. Arendt, *Eichmann in Jerusalem*, Reclam, Leipzig 1990, pp. 331ff.

<sup>5</sup> W. Höttl, *Einsatz für das Reich*, S. Bublies, Koblenz 1997, esp. pp. 77, 412f.

<sup>6</sup> Cf. G. Rudolf, “Wilhelm Höttl – ein zeitgeschichtlich dilettantischer Zeitzeuge”, *Vierteljahreshefte für freie Geschichtsforschung (VffG)*, 1(2) (1997) pp. 116f (online: [who.org/VffG/1997/2/Buecher2.html#Hoettl](http://who.org/VffG/1997/2/Buecher2.html#Hoettl)).

<sup>7</sup> D. Irving, *Nuremberg. The Last Battle*, Focal Point, London 1996, pp. 61f.

the war's end.<sup>8</sup> W. Höttl has found an article in *Readers's Digest* which in February 1943 already reported the murder of at least the half of the six million Jews threatened by Hitler.<sup>9</sup>

In 1936, Chaim Weizmann is reported to have said in front of the Peel Commission:<sup>10</sup>

“It is no exaggeration to say that six million Jews are sentenced to be imprisoned in this part of the world, where they are unwanted, and for whom the countries are divided into those, where they are unwanted, and those, where they are not admitted.”

But this ‘magic’ number probably dates back even further. A series of *propaganda articles* published shortly after the end of the First (!) World War already mentioned six million Jews who had perished in a Holocaust in eastern Europe,<sup>11</sup> and Benjamin Blech tells of an *ancient Jewish prophecy* that promises the Jews their return to the Promised Land *after a loss of six million* of their number,<sup>12</sup> which is certainly grounds for speculations.

The origin of the six-million figure, which has by now been acknowledged as “*symbolic figure*” even by historians of the establishment,<sup>13</sup> is thus more than questionable, and it is not surprising that even world-famous statisticians have long conceded that the issue of the numbers of victims is in no way settled.<sup>14</sup>

In introducing the discussion of Holocaust victims, revisionist scholars time and again cite a publication in the Swiss paper *Baseler Nachrichten* of June 12, 1946, which postulated a maximum number of 1.5 million Jewish victims of National Socialism, as well as the fact that the International Red Cross never made any mention in its post-war Activity Reports of a systematic extermination of the Jews in gas chambers.<sup>15</sup> Benz comments rightly that citing various undocumented newspaper sources and the IRC, which out of a lack of any comprehensive overview never compiled any statistics of its own about the numbers of victims, is a very dubious practice.<sup>16</sup> While there have been several attempts since the war's end to determine the number of victims,<sup>17</sup> any monograph commensurate with the importance of the topic was lacking until the early 1980s. It was not until 1983 that a book was

<sup>8</sup> J. Hoffmann, *Stalin's War of Extermination 1941 – 1945*, Theses & Dissertations Press, Capshaw, AL, 2001, p. 189f.

<sup>9</sup> W. Höttl, *op. cit.* (note 5), pp. 412, 515-519.

<sup>10</sup> Retranslated from the introduction of Walter A. Berendsohn to Thomas Mann, *Sieben Manifeste zur jüdischen Frage*, Jos. Melzer Verlag, Darmstadt 1966, p. 18. I am grateful to R.H. Countess for bringing this to my attention.

<sup>11</sup> Most prominently in *The American Hebrew*, v. 105, no. 22, Oct. 31, 1919, pp. 582f. *The New York Times* carried many ‘reports’ about millions of Jews suffering and dying in eastern Europe during and after WWI, see the analyses by Don Heddesheimer, *The Barnes Review*, 3(2) (1997), pp. 19-24 (online: [vho.org/VffG/1999/2/Heddesheimer153-158.html](http://vho.org/VffG/1999/2/Heddesheimer153-158.html))

<sup>12</sup> B. Blech, *The Secret of Hebrew Words*, Jason Aronson, Northvale, NJ, 1991, p. 214.

<sup>13</sup> Testimony of M. Broszat, expert witness for the Frankfurt Jury Court, May 3, 1979, Ref. Js 12 828/78 919 Ls.

<sup>14</sup> Cf. Prof. F. H. Hankins, temporary President of the American Association for Demography, quoted in *The Journal of Historical Review (JHR)*, 4(1) (1983) pp. 61-81 (online: [ihr.org/jhr/v04/v04p-61\\_Hankins.html](http://ihr.org/jhr/v04/v04p-61_Hankins.html)).

<sup>15</sup> R. Harwood, *Did Six Million Really Die? Historical Fact No. 1*, Samisdat Publishers, Toronto n.d., pp. 26ff. (online: [www.zundelsite.org/english/harwood/Didsix01.html](http://www.zundelsite.org/english/harwood/Didsix01.html)); cf. also J. Rothkranz, *Die kommende Diktatur der Humanität*, v. 2, Pro Fide Catholica, Durach 1990, pp. 91ff.

<sup>16</sup> W. Benz, *op. cit.* (note 3), pp. 9ff., based on H. Rothfels, *Vierteljahrshäfte für Zeitgeschichte (VfZ)* 14 (1966) p. 244.

<sup>17</sup> J. Leszcynsky, “*The Decline of European Jewry*”, *Congress Weekly*, New York, Sept. 24, 1951; L. Poliakov, *Breviaire de la haine*, Calmann-Lévy, Paris 1979; G. Reitlinger, *The Final Solution*, Mitchell, London 1953, Ger.: *Die Endlösung*, Colloquium, Berlin 1956; H. Krausnick, *Aus Politik und Zeitgeschichte* 4(32) (1954) p. 426; P. Rassinier, *Was nun, Odysseus?*, Priester, Wiesbaden 1960; A. Ehrhardt, special supplement to *Nation Europa* 12 (1961); H. Krausnick, in *Dokumentation zur Massenvergasung*, Bundeszentrale für Heimatdienst, Bonn 1962, pp. 16-22; P. Rassinier, *Deutsche Hochschullehrer-Zeitung (DHZ)* 1/2 (1963) p. 61; G. Wellers, *Aus Politik und Zeitgeschichte* 28(30) (1978) pp. 22-39; R. Hilberg, *The Destruction of the European Jews*, Holmes & Meier, New York 1985, ch. VIII section 3.

published in the United States – *The Dissolution of the Eastern European Jewry*, by W. N. Sanning<sup>18</sup> – which attempted, by drawing on statistical material from mostly Jewish sources, to ascertain the number of Jewish Holocaust victims in the Third Reich’s sphere of influence. Since Sanning concluded in his book that at the very most several hundreds of thousands of Jews perished of unknown causes in the Third Reich,<sup>19</sup> it was to be expected that the establishment would counter with a reply containing a wealth of statistical material intended to reconfirm the “symbolic figure” of six million Jewish victims. And indeed, in 1991 the official *Institut für Zeitgeschichte* published a 585-page study titled *Dimension des Völkermords*.

“The bottom line indicates a minimum of 5.29 and a maximum of just over 6 million [Jewish victims of the Holocaust].”<sup>20</sup>

This is how editor W. Benz summarizes the statistical investigations of his seventeen co-authors, each of whom focused on one nation that had been either occupied by or allied with the Third Reich. But it must be pointed out that

“Of course the purpose of this project also was not to prove any pre-set figure (‘six million’),”<sup>21</sup>

even if the final result does happen to coincide with the semiofficial number. In the following discussion of individual contributions to this book, we shall refer only to the editor W. Benz rather than to the various co-authors to avoid confusing the reader with a multitude of different names.

In the summary of his 239-page book, Sanning writes:

- At the beginning of World War Two there were fewer than 16 million Jews in the world [...]
- One million Jews died while fighting in the Red Army or in Siberian labor camps; [...]
- Approximately 14 million Jews survived the last war [...]

Further civilian and military losses must be deducted from the missing one million Jews, so that Sanning eventually arrives at only about 300,000 Jews who lost their lives in unexplained manner in the German sphere of influence during the Second World War.

In view of the fundamental contradiction between these two works, an interested and critical reader naturally wonders which of the two authors is right. Since the answer to this question is of great consequence, and since recent scientific and technical findings have rendered several aspects of the Holocaust extremely questionable, the following shall compare and contrast the approaches and findings of both works.<sup>22</sup>

<sup>18</sup> W. N. Sanning, *The Dissolution of the Eastern European Jewry*, Institute for Historical Review, Newport Beach, CA 1983; Ger.: *Die Auflösung des osteuropäischen Judentums*, Grabert, Tübingen 1983; cf. Sanning, *DGG* 28(1-4) (1980) pp. 12-15, 17-21, 17-21, 25-31 (online: [vho.org/D/DGG & .../D/da](http://vho.org/D/DGG&.../D/da)), as well as the discussions with representatives of the opposing side: W. D. Rubinstein, W. N. Sanning, A. R. Butz, *JHR* 5(2-4) (1984) pp. 367-373; D. Desjardins and J. S. Conway, *JHR* 7(3) (1986) pp. 375, 379 (online: [ihr.org/jhr/v07/v07p375\\_Desjardins.html](http://ihr.org/jhr/v07/v07p375_Desjardins.html) and [.../v07p379\\_Conway.html](http://ihr.org/jhr/v07/v07p379_Conway.html)).

<sup>19</sup> W. N. Sanning, *The Dissolution...*, *op. cit.* (note 18), p. 14.

<sup>20</sup> W. Benz, *op. cit.* (note 3), p. 17. Since each contribution to this book opens with a summary of the history of the Jews in the country under discussion, and gives a detailed account of all the anti-Jewish laws, measures and events that took place there, one must first dig one’s way through masses of extraneous material which has already been set out in many other books before one can isolate the statistically relevant data among all the alphabet soup. The size of Benz’s book is thus no indication of its statistically pertinent content.

<sup>21</sup> *Ibid.*, p. 20.

<sup>22</sup> Initial critiques of W. Benz’s work have already appeared in W. Hackert, *DGG* 40(2) (1992) pp. 19-24 (online: [vho.org/D/DGG/Hackert40\\_2.html](http://vho.org/D/DGG/Hackert40_2.html)), and: U. Walendy, *HT* 52, Verlag für Volkstum und Zeitgeschichtsforschung, Vlotho 1992, pp. 27-33.



## 2. Method

For this purpose, we will organize our analysis on the basis of the nations which, during World War Two, came under German rule either in whole or in part, and we will examine the fluctuations exhibited by the Jewish population statistics there. The sequence of the nations corresponds on the whole to that used in Benz's work, where only these countries are dealt with. In comparison, Sanning incorporates more extensive demographic observations, taking into account non-European nations as well, for which reason no strictly defined sequence of nations under German rule can be maintained in his work.

Between 1933 and 1945, the national boundaries of the countries studied often underwent considerable changes. In the work by Benz each country is discussed by a different author, and since the various authors clearly did not agree among themselves with respect to common boundaries, there are many cases of overlap which frequently result in the populations in question being counted twice.<sup>23</sup> We shall point this out as individual examples occur, and total these doublings at the end. Since Sanning, being the sole author of his book, did not have such trouble in allotting boundary areas, we will subsequently follow his choice of boundaries. Since the Benz book goes into great detail where such territories as were subject to changes in sovereignty are concerned, the appropriate corrections are generally quite easy to accommodate here.

For each nation or group of nations we shall first give a brief tabular overview of the Jewish population statistics as given in each work. Only where the data given in the two books are at considerable odds will reference to the soundness of the data and their calculation be made in order to determine which author's arguments are better. The reliability of the sources cited by the authors will also be touched on only in cases of dispute.

This will be followed by a comparison of the sum total of Jewish losses in German-occupied Europe, as calculated in each book, as well as by a summary critique which will also address the matter of where and how the victims Benz believes to have identified allegedly lost their lives; certain contradictions will become evident.

An overview of the numbers of Jewish emigrants from the European nations under former German occupation follows, as well as a survey of world Jewish population changes before and after the Second World War. Since these aspects are discussed *only* by Sanning, no comparison with the Benz book can be drawn – but since Benz's book appeared eight years after Sanning's, this certainly gives the impression that no factual counter-arguments were possible, at least where the matter of emigration was concerned.

And finally, Sanning's work is verified statistically; a similar test was already performed some time ago by a Swedish statistician.

To avoid a vast number of footnotes, sources will be indicated in the text by parenthetical references giving only the page number in question and identifying the book by the initial of its author/editor (S or B), and in tables by appropriate notation in the column "Ref." or in brackets. Only rarely will reference be made to the source quoted by the book itself.

## 3. The Nations Under German Influence

### 3.1. Germany and Austria

The low Jewish population in Germany as given for this time in the book by Benz is the same as that in Sanning's, since both are based on a monthly report of the Reich Association of Jews in

---

<sup>23</sup> This was also pointed out by E. Jäckel, Professor of Contemporary History in Stuttgart, in his review of Benz's book in the German weekly newspaper *Die Zeit* of June 28, 1991.

Germany to the *Reichssicherheitshauptamt* [Reich Security Main Office]. Since this Association was an extension of the National Socialist state, the figure given is quite reliable. Benz, however, proceeds on the assumption that this figure represented only “*full Jews*”, and adds approximately 43% for “*half-Jews*” and “*quarter-Jews*”, even though these Jews were only partly (half-Jews) or not at all (quarter-Jews) subjected to the measures performed by the German authorities.<sup>24</sup>

BENZ	JEWS 10/41	REF.	JEWS 1945	REF.			VICTIMS	REF.
Germany	164-235,000	34ff.	20,000	52/64			139-174,000	52/53
Austria	60,000	68	5,000	71			48,767	74
<b>TOTAL</b>	<b>224-295,000</b>		<b>25,000</b>				<b>188-223,000</b>	

SANNING	JEWS 10/41	REF.	JEWS 1945	REF.	DEATHS	REF.	MISSING	REF.
Germany	164,000	136	27,000	138	14,000	138	123,000	137
Austria	50,000	137	9,000	138	5,000	138	36,000	138
<b>TOTAL</b>	<b>214,000</b>		<b>36,000</b>		<b>19,000</b>		<b>159,000</b>	

Benz does not give any definite figures for the number of Jews in Austria, but believes that by the beginning of the war two-thirds of the Jews (as defined by the Nuremberg Race Laws) that had been present in Austria at the time of its unification with the Reich had fled (B68). This means that of 206,000 (B70), some 70,000 remained at the start of the war. Until October 1941, emigration – which amounted to approximately 15% in the Reich proper at this time (B35) – produced a further reduction of about 10,000.

For Germany, Sanning cites only those figures provided by the Reich Association. For Austria he refers to contemporaneous Jewish sources in Austria and the United States.

For the Jews to be found in post-war Germany Benz cites only estimates, and for those in Austria, nothing more than a number pertaining to ‘after the liberation’. However, due to the chaos reigning at that time, these statistics are very unreliable. Sanning cites data provided by the well-known Holocaust specialist Gerald Reitlinger, and his figures for Austria were not determined until October 1947, after the greatest of the population transfers in Europe had begun to subside.

While Benz ignores the increased mortality rate that characterized the Jewish population in the Reich between 1941 and 1945 due to the emigration of predominantly young people, which resulted in a disproportionate percentage of elderly Jews, Sanning does take this into account, which further reduces his tally of missing persons. This illustrates clearly the contrasting approaches of the two authors: Benz proceeds on the assumption that the difference between pre- and post-war Jewish population figures must be the result of the extermination program, which may make any calculation of natural mortality rates seem superfluous. Sanning, on the other hand, does not automatically consider the difference to be necessarily indicative of deaths – as yet, to him, these people are only missing. Further differences in the treatment of statistical questions will become apparent in the following, and will be summarized at the end.

I have reduced Benz’s numbers of victims by 21,000 for Germany and by 16,692 for Austria. These represent victims who fled to other European countries not then under German control, where, however, they later came under German rule and were allegedly exterminated (Germany: B64; Austria: B74). However, since these people are also counted as part of the Jewish population of their country of destination (particularly France and Czechoslovakia), it is necessary to deduct them once. For the moment we shall take note of **37,692 Jewish victims counted twice**, which must be deducted from Benz’s total.

<sup>24</sup> Cf. IMT Document PS-4055 (USA Exhibit 923), *IMT v. XX*, pp. 330ff., reprint with preceding comments in *VffG*, 1(2) (1997), pp. 60-68 (online: [vho.org/VffG/1997/2/Xanten2.html](http://vho.org/VffG/1997/2/Xanten2.html)).

### 3.2. France, Benelux, Denmark, Norway and Italy

The reason for the great differences between the opening figures for France and the Benelux nations is that, except for the Netherlands, only estimates are available for the numbers of Jews living there before the war, both because these were simply never recorded statistically and because immigrants from Germany and Poland were not always registered. While Sanning bases his figures on information provided by the *American Jewish Yearbook 1940* (New York) and by Reitlinger,<sup>25</sup> who cites barely half a million, Benz uses straight estimates for Belgium and France; among his sources for these estimates are reports from German authorities which, however, are likely to have inflated the numbers of Jews grossly for propaganda reasons.<sup>26</sup>

BENZ	JEWS 10/41	REF.	JEWS 1945	REF.	VICTIMS	REF.
Luxembourg	3,500-3,700	104	2,450	103	1,200	104
Belgium	52,000	109f.	?23,482	(? is calculated data from	28,518	130
France	300,000	109	?223,866	10/41 minus	76,134	127
Netherlands	161,000	144	?59,000	the number of	102,000	165
Denmark	6,000	175	?5,884	victims)	116	185
Norway	1,800	187	?1,042		758	196
Italy	34,000	201	?28,086		5,914	216
<b>TOTAL</b>	<b>558,400 ±100</b>		<b>?343,810</b>		<b>214,640</b>	
SANNING	JEWS 10/41	REF.	JEWS 1945	REF.	MISSING	REF.
Luxembourg			500	133		
Belgium	Total: 460,000	132	61,000	133	Total: 124,000	133
France			238,000	133		
Netherlands			36,500	133		
Denmark & Norway	Total: 8,000	133	Total: *7,000	133	Total: 1,000	133
Italy	48,000	132	39,000	133	9,000	133
<b>TOTAL</b>	<b>516,000</b>		<b>382,000</b>		<b>134,000</b>	
*fled						

For Benz, the number of victims is by no means derived from the difference between pre-war and post-war Jewish populations, but rather from the number of those who allegedly were proven to have survived the deportations (2,566 of 75,720), and he cites Serge Klarsfeld to this effect.<sup>27</sup> The official post-war return registration of the deportees in France, as well as the accidental discovery of the survival of such as did not officially return, are what constitutes proof of survival to Klarsfeld.

Swedish demographer Carl O. Nordling comments rightly that the survivors from among the approximately 52,000 non-French Jews who fled to France before the war and were later deported to Auschwitz would not be very likely to report back to France after the war.<sup>28</sup> Similarly, a not inconsiderable portion of the survivors from some 23,000 remaining French Jews, some of whom had not

<sup>25</sup> G. Reitlinger, *The Final Solution*, A. S. Barnes, New York 1961.

<sup>26</sup> W. N. Sanning gives several examples of such exaggerated data from German sources: Rumania, 1.5 to 2 million (in actual fact, approximately 700,000); France, 1.2 million (actually about 300,000) (S45).

<sup>27</sup> S. Klarsfeld, *Memorial to the Jews deported from France 1942-1944*, Beate Klarsfeld Foundation, New York 1983, p. xxvi.

<sup>28</sup> C. O. Nordling, "Was geschah den 75.000 aus Frankreich deportierten Juden?", *VffG* 1(4) (1997), pp. 248-251 (online: [vho.org/VffG/1997/4/NorFra4.html](http://vho.org/VffG/1997/4/NorFra4.html)); cf. also the analysis of the "Sterbebücher" of Auschwitz by E. Aynat which supports Nordling's thesis presented in his article: "Datos estadísticos sobre la mortalidad de los judíos deportados de Francia a Auschwitz en 1942", in J.-M. Boisdefeu, E. Aynat, *Estudios sobre Auschwitz*, publ. by E. Aynat, Valencia 1997; German: "Die Sterbebücher von Auschwitz", *VffG* 2(3) (1998), pp. 188-197; online: [vho.org/VffG/1998/3/Aynat3.html](http://vho.org/VffG/1998/3/Aynat3.html); cf. E. Aynat, "Consideraciones sobre la deportación de judíos de Francia y Bélgica al este de Europa en 1942", in E. Aynat, *Estudios sobre el 'Holocausto'*, Graficas Hurtado, Valencia 1994.

taken French citizenship until shortly before the war, will have emigrated without registration after the war, possibly assuming a different name in their new homeland,<sup>29</sup> thereby becoming very difficult to trace.

Thus, Klarsfeld's method for determining the number of victims, a method adopted by Benz, can hardly yield a correct result. The statements of former inmates claiming that their relatives had disappeared also fail to convince; to date there have been many cases of chance reunions of family members who each believed for decades that the other had been exterminated.<sup>30</sup> Since families were separated and scattered throughout Europe after being imprisoned, and since especially for Jews there was no way of searching for their kin amid the chaos of post-war Europe, the lack of proof of a family member's survival is also no proof of his or her extermination. Carl Nordling recently demonstrated the fallacy of these incorrect and rash conclusion on the basis of an investigation of the fate of the Jewish population of the Polish city Kaszony.<sup>31</sup>

A further example of faulty methodology on the part of Klarsfeld and Benz may be found in their approach to those inmates who were 'selected'<sup>32</sup> on their arrival in Auschwitz, *i.e.*, who were not officially admitted into the camp and therefore were not tattooed with an ID number. Klarsfeld and Benz lump all of these Jews together as victims of gassing because, being unfit for forced labor, they were allegedly deemed useless. Nordling<sup>28</sup> pointed out that the first transports, between March and July 1942, were almost completely admitted into Auschwitz, but that larger proportions of the transports were no longer registered in the camp later on.

If one assumes that non-registration meant death by gassing, then if the Third Reich had indeed been pursuing a policy of extermination one might expect to see the opposite trend, since in 1943 the labor shortage was considerably more severe in Germany than in 1942 and therefore Jewish workers ought to have been accorded greater value as the war progressed. The actual registration pattern, therefore, indicates instead that the Auschwitz camp was first filled with workers and that the surplus was later channeled to the more than 30 affiliated labor camps surrounding Auschwitz, as well as to other camps and camp groups.

This theory explains why men from one 1942 transport were not registered (*i.e.*, tattooed with prisoner ID numbers) in Auschwitz until April 1944.<sup>33</sup> Despite not being registered in 1942 they were obviously not killed, but rather employed outside Auschwitz in some other capacity for 1½ years. We do not know how Klarsfeld and his colleagues manage to be so certain that other inmates not registered in Auschwitz were not also put to work somewhere else, but were by necessity gassed.<sup>34</sup>

<sup>29</sup> Jewish immigrants to Israel were subjected to moral pressure to discard their usually German-sounding names in favor of Hebrew ones; cf. J. G. Burg, *Schuld und Schicksal*, Damm, Munich 1962.

<sup>30</sup> Various reports in *St. Petersburg Times*, Oct. 30, 1992: "Miracles still coming out of Holocaust"; *Chicago Tribune*, June 29, 1987: "Piecing a family back together"; *State-Times* (Baton Rouge), Nov. 24, 1979, p. 8; *Jewish Chronicle*, May 6, 1994: "Miracle meeting as 'dead' sister is discovered"; cf. *San Francisco Chronicle*, Nov. 25, 1978, p. 6; *Northern California Jewish Bulletin*, Oct. 16, 1992; cf. *JHR* 13(1) (1993) p. 45.

<sup>31</sup> C. O. Nordling, "Die Juden von Kaszony", *VffG* 1(4) (1997), p. 251-254 (online: [vho.org/VffG/1997/4/NorKas4.html](http://vho.org/VffG/1997/4/NorKas4.html)).

<sup>32</sup> The German word used at that time was "sortieren" [sort] and not "selektieren" [select], as used today.

<sup>33</sup> S. Klarsfeld, *op. cit.* (note 27), notes for Table III, p. xxvi.

<sup>34</sup> R. Faurisson has pointed out (S. Thion, *Vérité Historique ou vérité politique?*, La Vielle Taupe, Paris 1980, p. 328, online: [abbc.com/aaargh/fran/histo/SF1.html](http://abbc.com/aaargh/fran/histo/SF1.html); Engl.: [.../engl/SThtpt1.html](http://.../engl/SThtpt1.html)) that according to D. Czech (*Hefte von Auschwitz* 7 (1964), p. 88) none of the women in Transport No. 71 from France to Auschwitz were given registration numbers, in other words, **that all women were gassed on arrival**. This is disproven by S. Klarsfeld (*op. cit.* (note 27), p. XXVII) who states that 70 women from this transport had survived, among them Simone Jacob (*ibid.*, p. 519), who later became the first woman President of the European Parliament (as Simone Veil). The revised edition of D. Czech's *Auschwitz Chronicle, 1939-1945* (Henry Holt, New York 1989, p. 612) now states that 223 women from this transport did receive a number after all (78560-78782), and – as prevailing opinion would

*Thus it is clear that the statistical material on which Benz's book is based rests at least in part on an unsound speculative basis.*

Benz does not even attempt the other method of calculating casualties – namely, the comparison of pre-war and post-war Jewish populations. The post-war data given in the preceding table and identified with question marks are thus based simply on the subtraction of the supposed number of victims from the pre-war population.

Sanning again refers to Reitlinger for his post-war figures. In comparing the figures from Benz *et al.* and Reitlinger – both of them establishment Holocaust scholars – one sees that the estimation of the numbers of missing persons for these countries is very difficult due to the insufficient data available. For this reason Benz simply assumes that most of the Jews deported from France and the Benelux nations (213,813, B103; 127; 130; 165) were in fact murdered. Reitlinger's data are obviously not suited to this argument, since they prove this assumption to be false, even if only by the fact that his data suggests that only approximately 134,000 Jews were missing. The question of how many of these missing persons emigrated unregistered immediately after the war is not addressed by Benz and will be discussed here in a later section.

Here, too, Benz's number of victims was corrected because the Dodecanese Isles off the Turkish coast (Rhodes, Kos, and others) were counted for Italy as well as for Greece. The corresponding 1,641 victims were therefore subtracted from Italy's original figure of 7,555 (B213; 216). Together with Germany and Austria this makes for **39,333 victims counted twice**.

### 3.3. Albania

Benz assumes that Albania, with probably fewer than 1,000 Jews at the start of the war, lost a few hundred Jews, but he has only estimates to rely on for this (B236; 238). Sanning does not discuss this country at all, since neither statistics nor any relevant studies are available.

### 3.4. Greece and Yugoslavia

BENZ	JEWS 4/41	REF.	JEWS 1945	REF.	VICTIMS	REF.
Greece	70-71,500	272	12,726	272	58,885	272
Yugoslavia	80-82,000	312/3	16,000	329	60-65,000	330
<b>TOTAL</b>	<b>150-153,000</b>		<b>28,726</b>		<b>119-124,000</b>	
SANNING	JEWS 4/41	REF.	JEWS 1945	REF.	MISSING	REF.
Greece	65,000	134	12,000	135	53,000	136
Yugoslavia	68,000	136	12,000	136	56,000	136
<b>TOTAL</b>	<b>133,000</b>		<b>24,000</b>		<b>109,000</b>	

Where Greece is concerned, Benz has the better source material, since he had access to the Greek census data that was compiled just before the outbreak of the war (B247), whereas Sanning had to use one from 1931 (S134). Because of intensive emigration Sanning assumed a decrease in population and therefore mistakenly estimated the Jewish population at 65,000. Benz, on the other hand, arrives at a figure of at least 70,000 Jews in Greece, including the approximately 2,000 Jewish inhabitants of the Dodecanese Isles (primarily Rhodes and Kos).

With respect to Yugoslavia, both authors proceed from the last census data, collected in 1931 (approximately 68,000 Jews). Benz also estimates an increase of some 4,000 and an additional 5,000 or so foreign refugees, as well as another 3,000 – 5,000 *de facto* Jews who, while having renounced their faith, were nevertheless classed as Jews under the Nuremberg Race Laws. Sanning, on the oth-

---

have it – had thus been 'selected' as fit for forced labor. As far as we know it has not been determined whether the 70 surviving women mentioned by Klarsfeld were among these 223.

er hand, seconds Reitlinger in the assumption that immigration and emigration balanced out in Yugoslavia, a country that grew increasingly anti-Jewish in its outlook since 1939 (B312). Sanning does not address the matter of *de facto* Jews.

For Greece, the difference between the data of the two authors results from Sanning's deflated pre-war figure and from the 2,000 Dodecanese Jews which he may have missed.<sup>35</sup> For Yugoslavia, on the other hand, Benz appears to have estimated the pre-war figures a little too high. The actual number of missing persons, therefore, probably lies somewhere between the two figures, which do not deviate very much anyhow.

### 3.5. Hungary

First of all it is necessary to define which Hungary is at issue. Since Hungary had the same boundaries before the war as it did after, but briefly made tremendous territorial gains in between, we shall here confine our analysis to the area within the boundaries of today's Hungary (so-called Trianon Hungary). Since both authors give their Jewish statistics for the newly added and subsequently lost regions separately from those for Trianon Hungary, it should be possible to transfer this definition to the numbers of Hungarian Jews without any difficulty. There is one serious problem, however. Benz's distribution of the Jews among Trianon Hungary (some 401,000) and the territories gained (approximately 324,000) is based on a total of 725,000 Jews for Greater Hungary (B338), which is also Sanning's initial figure (S138). But Benz adds approximately 100,000 *de facto* Jews of non-Jewish denomination but coming under the Nuremberg Race Laws, as well as approximately 50,000 immigrants from Poland (B340). This increase of about 20% must be added accordingly to the figure for Trianon Hungary, resulting in 484,000 Jews. The subsequent statistics (casualties at the front in the Hungarian Military Labor Force, Soviet deportations, as well as the numbers of survivors and victims) follow from the number Benz cites for Greater Hungary if one considers that approximately 55% of all the Jews in Greater Hungary resided in Trianon Hungary, and if one assumes that all changes affected all Jews equally. In fact, however, one cannot realistically assume this, *since it is an undisputed fact that the Jews of Budapest – some 150,000 to 200,000 – remained completely unaffected by deportations into supposed extermination camps* (B348f.; S143).

BENZ	JEWS 1941 (340)	KILLED IN COMBAT, AND SOVIET DEPORTATION (351)	BIRTH DEFICIT (340)	FLIGHT (340)	JEWS 1945 (351)	VICTIMS (351)
Hungary	484,000	Total: 27,000	2,900	9,000	166,000	277,000*

\*Discrepancies in calculation are the result of revision; see text.

SANNING (144)	JEWS 1941	CONVERSIONS	KILLED IN COMBAT	SOVIET DEPORTATION	BIRTH DEFICIT	FLIGHT	JEWS 1945	MISSING
Hungary	400,000	10,000	27,500	65,500	20,000	6,000	200,000	71,000

Working with Greater Hungary rather than Trianon Hungary would avoid these problems, but we cannot do this, for the reason that all of Hungary's territorial gains have been incorporated into other sections of Benz's book. These regions are: the Bačka of Yugoslavia, northern Transylvania of Rumania, and southern Slovakia and the Carpatho-Ukraine of Czechoslovakia, with a total of approximately 324,000 denominational Jews, *i.e.*, 391,000 *de facto* Jews (+20%). In computing his overall total, Benz counted all these Jews twice, with the exception of the Jews in those territories gained from Czechoslovakia.<sup>36</sup> Since the 214,000 *de facto* Jews who were counted twice amount to

<sup>35</sup> Sanning does not mention whether he perhaps listed them under Italy. Since his figures for this country are greater than those of Benz (see above), this is a possibility.

<sup>36</sup> Regarding Bačka see B330, regarding Transylvania see B409.

about 24.5% of Greater Hungary's Jews, this corresponds to a duplicate counting of 122,500 Jewish victims out of an overall number of 500,000 Jews said to have been killed by the Germans (B351). If one considers that the proportion of victims in the border territories was greater than that in Trianon Hungary, since all of Budapest, for example, remained unaffected by the deportations, then a duplicate count of as many as 150,000 seems likely. This increases the **number of Jews counted twice to at least 161,833**.

Unfortunately not all of the co-authors contributing to Benz's book employed the same methods as in the case of Hungary, where simple estimates added 20% to the initial number of Jews; the result is that the territorial overlaps and duplicate counts get completely out of hand. We shall focus less on the actual numbers in each case than on the methodologies applied. Hungary is an especially appropriate subject for a closer scrutiny of methodology, since this particular case represents an exceptionally explosive chapter of the (hi)story of the Holocaust. Advocates of the Holocaust doctrine assume as a matter of course that the Germans deported 400,000 to 500,000 Hungarian Jews to Auschwitz, where the majority of them were killed. The basis for this assumption are IMT documents which, according to Benz, prove that in spring and early summer 1944 "444,152 Jews were deported from Hungary" (B344).

In his book Sanning quotes Arthur R. Butz who pointed out that the International Red Cross made no mention in its Report, published in 1948, of any deportations of Jews to Auschwitz, but only of the beginning of Jewish tribulations in October 1944.<sup>37</sup> Aside from violent excesses, this time did see some deportations, whose purpose and destination, however, was forced labor in the Reich, not Auschwitz (B348; S139f.). Therefore, Butz and Sanning assume that no adequate evidence exists to prove that Hungarian Jews were deported to Auschwitz at all.

There is no way around the fact, however, that there are still Jews living today who really were deported to Auschwitz in spring 1944 and who have repeatedly testified as witnesses in court.<sup>38</sup> Further, Pressac states that between  $\frac{1}{3}$  and  $\frac{2}{3}$  of the Hungarian Jews deported to Auschwitz, whose arrival and selection were photographed by the SS,<sup>39</sup> were considered fit for forced labor, *i.e.*, were not killed.<sup>40</sup> As well, it can be proven, he says, that in the spring some 50,000 of these Hungarian Jews were transported on to the Stutthof camp via Auschwitz.<sup>41</sup> In this respect, therefore, Sanning's theory rests on a shaky foundation<sup>42</sup> – but so does that of Benz, who contends that the Hungarian Jews were killed immediately and almost without exception.

There are other indications as well that the theory of mass destruction of the Hungarian Jews is incorrect: the witnesses to this destruction unanimously claim that during these alleged mass exterminations the limited capacity of the Birkenau crematoria necessitated the excavation of enormous

---

<sup>37</sup> A. R. Butz, *The Hoax of the Twentieth Century*, Institute for Historical Review, Newport Beach, CA 1992, p. 138.

<sup>38</sup> *E.g.*, the witnesses I. Lazar and L. Heuser in the trial of G. Weise, cf. R. Gerhard (ed.), *Der Fall Weise*, Türmer, Berg 1991, pp. 28, 33.

<sup>39</sup> S. Klarsfeld, *The Auschwitz-Album*, Beate Klarsfeld Foundation, New York 1980.

<sup>40</sup> As G. Holming has pointed out, this relation of  $\frac{1}{3}$  to  $\frac{2}{3}$  may be the one of inmates registered in Birkenau and those sent to other camps, and not of those killed, "Wieviele Gefangene wurden nach Auschwitz gebracht?", *VffG*, 1(4) (1997), pp. 255-258 (online: [vho.org/VffG/1997/4/HolWie4.html](http://vho.org/VffG/1997/4/HolWie4.html)).

<sup>41</sup> J. C. Pressac, *Les crématoires d'Auschwitz, la machinerie du meurtre de masse*, Édition du CNRS, Paris 1993, p. 147, cites the Yad Vashem without giving any further details; acc. to findings of J. Graf and C. Mattogno in the archives of the former camp of Stutthof, only 25,000 Jews were deported (cf. J. Graf, C. Mattogno, *Concentration Camp Stutthof and its Function in National Socialist Jewish Policy*, Theses & Dissertations Press, Chicago, IL, 2003; online: [vho.org/GB/Books/ccs](http://vho.org/GB/Books/ccs)). Perhaps the rest was sent to other labor camps. Cf. also the report about Hungarian Jews as forced laborers in the Volkswagenwerke in Wolfsburg: H. Mommsen, M. Grieger, *Das Volkswagenwerk und seine Arbeiter im Dritten Reich*, Econ, Düsseldorf 1996; P. Bölke, "Der Führer und sein Tüftler", *Der Spiegel* 45 (1996), p. 138f.

<sup>42</sup> W. N. Sanning has since reconsidered this theory; personal communication.

pits, in which the bodies were burned. Dark clouds of smoke, they claim, darkened the sky over Birkenau during this procedure. Fortunately (or unfortunately, depending on one's perspective) the aerial reconnaissance photographs taken by the Allies during this time prove that in the Birkenau camp, which was not obscured by clouds of smoke when the pictures were taken, there were neither open fires, nor giant pits, nor smoke activity on any scale large or small, nor piles of dead bodies, nor great supplies of firewood, nor anything else of the sort.<sup>43</sup> The Polish Historical Society concludes that in light of this evidence the number of victims in Auschwitz must be reduced by another 400,000 plus 74,000 (Polish Jews from the liquidated ghetto Lodz, who are also claimed to have been gassed around this time), leaving some 500,000 victims for Auschwitz.<sup>44</sup>

Even allegedly probative documents of the Nuremberg Tribunal cannot change this, since such documents are by no means always genuine, or true, and only ever provide evidence for deportations which are not disputed here in the first place – *they never document an extermination*. The reader is reminded of the example of Dachau, the concentration camp where the IMT alleged that hundreds of thousands were gassed, a claim which in the end turned out to be nothing more substantial than an atrocity propaganda lie.<sup>45</sup> We shall come across another case of dubious IMT documents in the discussion of the Soviet Union.

Benz's methodology proves to be very slipshod where other factors are concerned as well. He can only give vague estimates of the number of Jews who lost their lives due to Soviet deportation and in the Hungarian Military Labor Force (B339), whereas Sanning cites verifiable figures based on Jewish or at least pro-Jewish sources (S140; 142). Benz maintains the birth deficit at pre-war levels, whereas Sanning reasons that the Labor Force for Hungarian Jews as well as the overall poor conditions for Jews during the war would have caused the pre-war birth rate to drop further. Benz completely ignores the numbers of Jews who 'converted' to the Christian faith; in any case, Jews who converted to Christianity were no longer represented in any post-war statistics about Jews, and are thus considered by Benz and his co-authors to have been 'gassed'.

Now, what is interesting are the two authors' contrasting observations regarding the Jews said to be remaining in Hungary after the war. Whereas Benz suggests a total of 300,000 for Greater Hungary, Sanning cites that some 300,000 Jews were left after the war in Central (Trianon) Hungary alone. He bases his claim on, first, the US War Refugee Board's *Final Summary Report*, which states that more than 200,000 Jews from Budapest were exempted from deportations following negotiations with the SS (S143). Second, in its aforementioned report the International Red Cross stated that some 100,000 Jews poured into Budapest from the provinces.<sup>46</sup> Furthermore, 200,000 Jews had been counted in Trianon Hungary in 1946, while according to Reitlinger one can assume that by then a veritable mass exodus of Jews to the West had begun (S143). One must also consider, he says, that no doubt a great many foreign, mostly Polish Jews were included in this migration. Sanning thus cites 200,000 as the minimum number of Jews present in post-war Trianon Hungary. For Benz, the number of survivors derives almost exclusively from the number of Jews present before the war, minus the decreases estimated as above, minus the actual or supposed deportations to con-

<sup>43</sup> Cf. J. C. Ball, *Air Photo Evidence*, Ball Resource Services Ltd., Delta, BC, 1992; cf. his chapter in the present volume, as well as J. Konieczny, *The Soviets, but not the Western Allies, should have bombed the Auschwitz camp*, Polish Historical Society, PO Box 8024, Stamford, CT 06905, April 1993.

<sup>44</sup> J. Konieczny, *op. cit.* (note 43).

<sup>45</sup> Cf. correction, M. Broszat, Institut für Zeitgeschichte, *Die Zeit*, Aug. 19, 1960, as well as a letter on IfZ stationery to a Swedish addressee, dated July 17, 1961; also H. Wendig, *Richtigstellungen zur Zeitgeschichte*, issue 5, Grabert, Tübingen 1993, p. 50; E. Kern, *Meineid gegen Deutschland*, Schütz, Göttingen 1968, pp. 263ff.; extensive source material in F. A. Leuchter, *The Second Leuchter Report*, Samisdat, Toronto 1989 (online: [www.zundelsite.org/english/leuchter/report2/leucha.html](http://www.zundelsite.org/english/leuchter/report2/leucha.html)).

<sup>46</sup> A. R. Butz, *op. cit.* (note 37), p. 139.



centration camps, *i.e.*, (according to Nuremberg documents) to forced labor camps. Absolutely no other sources are used.

### 3.6. Czechoslovakia

BENZ (379)	JEWS 1939	EMIGRATION	JEWS 1945	VICTIMS
Czechoslovakia	251,745	33,000	40,000	164-168,000*

\*Discrepancies exist in the author's work itself.

SANNING (146)	JEWS 1939	EMIGRATION	KILLED IN COMBAT	BIRTH DEFICIT	JEWS 1945	MISSING
Czechoslovakia	254,288	52,300	3,000	5,000	82,000	112,000

We shall consider Czechoslovakia as defined by its post-war borders (up to 1992), in other words without the Carpathian Ukraine. Benz, while discussing Czechoslovakia as for its borders prior to its first collapse in 1938/39, does give a breakdown of the proportions for the individual regions.<sup>47</sup>

Benz assumes a migration balance of net 33,000 emigrants up to mid-1943, while no net emigration was allegedly apparent for Slovakia (B369). Regarding emigration from the Protectorate he cites official statistics of contemporaneous Jewish authorities which, however, did not incorporate illegal emigration (B358). Sanning totals more than 52,000 emigrants, substantiating this with a reference to the Anglo-American Committee, according to which the Jewish population had already decreased by 40,000 by late 1939 (S144). *Sanning is the only one to take into account the drop in birth rate and the casualties of the Hungarian Labor Force.*

Benz arrives at what he claims to be the approximate number of survivors in the Protectorate by totaling those Jews who officially reported back as survivors of the deportations, or who were otherwise found in Czechoslovakia after the war. Unfortunately such data were only ever gathered selectively, with respect to specific camps or cities, and never nationwide for any given point in time, so that the results are by necessity incomplete. For Slovakia, Benz derives his survivor statistics from the difference between those Jews who failed to return from deportations, and the population level prior to the deportations. Any westward migration is disregarded. Where the regions that were ceded to Hungary are concerned, Benz assumes that the Jews there suffered the same fate as the remaining Hungarian Jews. Aside from the Carpathian Ukraine, some 45,000 Jews were affected. The problems involved in the study of the Jews in the territory of Greater Hungary have already been mentioned.

Sanning refers to Reitlinger in pointing out that in 1946, in other words after the westward migration had already begun, some 32,000 Jewish survivors were found in the former Protectorate alone (S145). Also according to Reitlinger, 45,000 Jews – and according to other pro-Jewish sources, as many as 60,000 Jews – were found in Slovakia after the war (S146), which of course stands in clear contradiction to the estimates advanced by Benz, who claims 20,000 Jewish survivors for Slovakia and bases this assertion largely on Czech publications (B374).

### 3.7. Rumania

Rumania is considered as defined by its post-war boundaries, including northern Transylvania and excluding Bessarabia and northern Bukovina. The only disagreement between the two authors consists in the treatment of the Jews of northern Transylvania, who came under Hungarian rule in the Second World War (see above). According to Benz, the majority of these were 'gassed' in Ausch-

<sup>47</sup> Whereas the chapter about Czechoslovakia speaks of 102,542 Jews in the Carpathian Ukraine (B355), the chapter about Hungary mentions only 78,000 Jews there (B338). Once again: inaccuracies and contradictions in Benz's book.

witz, whereas according to Sanning, most of their losses were sustained in the Hungarian Military Labor Force. Since the number of survivors – up to 430,000, as Benz and Sanning document several times – rules out any great losses on the part of the North Transylvanian Jews, and since these findings do agree with the aforementioned results of recent investigations, one can assume that the Jews in the territory of post-war Rumania suffered next to no losses. Benz simply bases his calculation of the number of victims on the lowest documented number of survivors, in other words, *he ignores the 430,000 Jewish survivors in his estimates, even though he mentioned them himself.*

BENZ	JEWS 1941	JEWS 1945 (407)	VICTIMS		
Rumania (409)	466,418	356-430,000	107,295		
SANNING	JEWS 1941	EMIGRATION	KILLED IN COMBAT	JEWS 1945	MISSING
Rumania (153)	465,242	20,000	11,500	430,000	3,742

### 3.8. Bulgaria

BENZ	JEWS 1941	JEWS 1945	VICTIMS
Bulgaria (308)	50,000	50,000	0
SANNING	JEWS 1941	JEWS 1945	IMMIGRATION
Bulgaria (154)	48,400	56,000	7,600

Bulgaria is discussed here in its pre- and post-war boundaries, in other words, without Greek Thrace, without Yugoslav Macedonia, and without the southern Rumanian Dobruja with its quantitatively negligible Jewish population. Benz chose to base his analysis on the larger wartime territory, while failing to reduce the regions of Yugoslavia or of Greece accordingly. This results in duplicate counts of 4,200 victims for Greece (B272) and 7,160 for Yugoslavia (B298), increasing the **overall duplicate count to at least 173,193.**

On the whole, there is no doubt that the Jews on Bulgarian soil were not in any danger and suffered no losses.<sup>48</sup> Sanning even shows a post-war population greater than that of pre-war times, and explains that Bulgaria served as gateway to the Middle East for a vast number of legal as well as illegal immigrants. According to Sanning, it is likely that noticeable numbers of foreign Jews were still in Bulgaria immediately after the end of the war.

### 3.9. Poland

BENZ	JEWS 9/39	REF.	JEWS 1945	REF.	VICTIMS	REF.
Poland	2,000,000	443	200,000	492f.	1,800,000	495
SANNING	JEWS 1941	REF.	JEWS 1945	REF.	MISSING	REF.
Poland	757,000	44	240,489	45	516,511	45

Poland is discussed here in terms of its post-war boundaries, without the eastern German regions. While Benz claims to add to this merely the administrative districts of Bialystok and Galicia, he does eventually include the victims for the entire territory that was Polish in the time between World Wars One and Two, *i.e.*, parts of what was known during the Second World War as the Reich Commissionerships of Ukraine and Ostland. But since he deducts only the numbers of victims for Galicia and Bialystok from the total in his chapter about the Soviet Union, this results in duplicate counts which will be discussed in greater detail in the section regarding the Soviet Union.

<sup>48</sup> According to R.H. Countess, at the Stockholm International Forum on the Holocaust (26-28 January 2000), Bulgaria was specifically singled out for *protecting* its Jews. That means that Bulgaria will *not* have to pay any ‘reparations’ – unless certain discoveries are made.

### 3.9.1. Poland's Pre-War Population

The last pre-war Polish census indicated approximately 3.1 million Jews (B416; S20).

On the basis of detailed studies Sanning shows that even during the period between the two world wars, the Polish Jews exhibited an extremely low rate of population increase (S26f.). The *Institut für Zeitgeschichte* adds that since 1933 some 100,000 Polish Jews per year had turned their backs on radically anti-Semitic Poland and emigrated to western Europe or overseas (S32).<sup>49</sup> Since those leaving the country were predominantly young people, the number of Jews in Poland must have decreased sharply due not only to this migration but also due to the increasingly disproportionate percentage of old people. Sanning puts the number of emigrants between 1931 and 1939 at only 500,000 and even factors in a population growth rate of 0.2%. He thus arrives at a population of 2,664,000 Jews prior to the war (S32).

This issue, to which Sanning devotes roughly 20 pages of intensive and thoroughly documented analysis, is accorded all of two sentences by Benz (B417):

“[...] if we extrapolate the census figures [of 1931] taking into account natural increase and emigration, we arrive at a 1939 total population of 35,100,000 persons for the Polish nation as a whole, of which the Jewish component is estimated at 3,446,000. We repeat: these figures are not certain [...]”

So Benz assumes, first of all, that the numbers of Polish Jews increased like those of the remaining Poles. Since Sanning clearly disproved this assumption eight years before Benz's work was published, and yet Benz does not even mention Sanning's arguments, there can be only one explanation for why untruths are clearly being disseminated here: *the purpose is to maximize the initial population figure for Polish Jews.*

Secondly, Benz assumes that the rate of emigration was essentially negligible. But since his book is a publication of the *Institut für Zeitgeschichte* and since this same *Institut* has publicly announced that some 100,000 Polish Jews had left Poland annually since 1933, one wonders whether this is a case of the left hand not knowing (or not wanting to know?) what the right hand is doing.

Benz therefore bases his subsequent arguments on a starting figure of 3,350,000 Jews present in Poland at the beginning of the war (B417), of which 2.3 million are assigned to the western part which the Germans occupied in 1939 (B418). *In this way Benz has falsified the statistic by probably 700,000 Jews at the least.* Are we to believe that Benz is unaware of Sanning's analysis of population trends in pre-war Poland? This seems out of the question, since after all Benz's book is a response to Sanning's. As I see it, the fact that Benz spares this complex topic no more than one sentence and an apologetic comment (“*We repeat: these figures are not certain*”) explains everything: this is an example of statistics being stretched well past the breaking point!

### 3.9.2. Flight Migrations During the Polish Campaign

According to Benz, some 300,000 of the initial 2.3 million Jews of western Poland fled eastward from the German army during the Polish campaign, into the Soviet-occupied area; of these 300,000, approximately 250,000 were deported to Siberia by the Soviets. Benz states that these are estimates, since allegedly there are no reliable figures (B425f.; 443). Accordingly, Benz suggests that approximately 2 million Polish Jews came under German rule in western Poland (B443). To document these statistics, Benz refers first and foremost to data originating with German sources whose doubtful value has already been mentioned.<sup>26</sup> Sanning explains that these figures are estimates calculated by the German authorities by extrapolating the census data from 1931 on the basis of a 10% popula-

---

<sup>49</sup> H. Graml, *Die Auswanderung der Juden aus Deutschland zwischen 1933 und 1939*, in *Institut für Zeitgeschichte* (ed.), *Gutachten des Instituts für Zeitgeschichte*, v. 1, pub. by ed., Munich 1958, p. 80.

tion increase (S44f.). Even in those days there were no more reliable figures and analyses available, and contemporaneous statisticians made the same mistake that Benz repeats in his book.

Sanning quotes numerous Zionist, Jewish and pro-Jewish sources, all of which indicate that between 500,000 and 1 million Jews fled to the Soviet-occupied zone of Poland during the German-Polish war (S39-43). Again, the majority of these were deported to Siberia. Among the sources cited are Jewish relief organizations, which attended to 600,000 Polish Jews in Siberian labor camps. Since a considerable proportion of these deported Jews already died during the inhumane transports to these camps, Sanning postulates a total of 750,000 Jews who fled into the Soviet zone as well as a further 100,000 who had fled to Rumania (S44).<sup>50</sup> Thus, the number of Jews in western Poland had decreased from an initial 1,607,000 (S39) to 757,000 (S44), while the number remained unchanged in eastern Poland due to the deportation of predominantly western Polish refugees (approximately 1 million, also Benz, B443).

The fact that such migrations of fleeing persons were not unusual is demonstrated by the example of Belgium, where 1½ to 2 million persons fled from the German army at the start of the war, effectively obstructing any strategic movements of the Allied armies (S43).

Benz's and Sanning's figures regarding the number of Jews remaining *after* the war are not very different from each other. It should be added, however, that according to the United Press the British and American investigative committee for the European Jewish problem declared, at a press conference in February 1946, that there were still an estimated 800,000 Jews in post-war Poland, all of whom wished to emigrate.<sup>51</sup>

### 3.9.3. The Destruction of the Polish Jews

Whereas Sanning does not touch on the methodology of the alleged mass murder, Benz makes several observations on this topic, of which we shall quote some aspects, with comments where necessary.

First, Benz expounds repeatedly on the alleged exhaust gas murders in vans, which of course he considers irrefutably proven (Kalisz, B431, Chelmno, B447, 462, cf. Yugoslavia, B320). The reader is referred to the chapter by I. Weckert in the present volume.

Regarding the methods of killing in other camps, he reports the use of bottled Zyklon B gas in Belzec (B462). But Zyklon B gas, *i.e.*, hydrogen cyanide, is not and never was bottled. For industrial purposes hydrogen cyanide is transported in tanker trucks, but it is never bottled. Further, he recounts the use of Diesel engines for mass gassings (Belzec, B462, Treblinka, B463, cf. USSR, B540). Regarding gassing with Diesel exhaust fumes, cf. the chapter by F. P. Berg, and regarding Treblinka, cf. the study by A. Neumaier, both in this volume. Any further commentary would be superfluous at this point.

A noteworthy admission on Benz's part is the following:

*“Considering the fact that there are very few usable sources of documentation about the extermination camps, the number of Jews killed at these murder sites is especially difficult to ascertain, and depends primarily on estimates provided by witnesses, on the analysis of the regular transports and their numeric strengths, and on the population of those areas from which the respective killing centers were ‘supplied’ [...]”* (B463f.)

<sup>50</sup> Cf. also J. G. Burg, *op. cit.* (note 29), pp. 11ff.

<sup>51</sup> *Keesing's Archiv der Gegenwart*, 16th/17th year, Rheinisch-westfälisches Verlagskontor, Essen 1948, p. 651, Memo B of Feb. 15, 1946. After the War the Allied occupation authorities officially registered up to 5,000 Polish Jewish emigrants per week (!) in the western zones alone (no number of weeks given, though); W. Jacobmeyer, *VfZ 25* (1977) pp. 120-135, esp. p. 125. In addition, there were migrations via other countries, as well as the non-registered emigrants.

The unreliable nature of witness testimony is demonstrated repeatedly in the present volume. Furthermore, straight calculations based exclusively on pre- and post-war populations are possible only if no uncontrolled emigration took place and if the initial statistics are sure to be correct. It is quite amazing that Benz nevertheless has the gall to use this method.

Benz finally concedes that the availability of source material leaves a great deal to be desired, not only where the alleged extermination camps are concerned but also with respect to the entire organization of the alleged extermination network structure (B463, footnote), and that there is no written, *i.e.*, documented and thus provable order for the destruction of the Jews (B3; 458f.; 512).

### 3.10. Soviet Union

BENZ (560)	JEWS 6/41	JEWS 1945	VICTIMS			
Soviet Union	5,200,000	2,300,000	2,890,000			

SANNING (109)	JEWS 6/41	KILLED IN COMBAT	CASUALTIES OF DEPORTATION	GERMAN THEATER OF WAR	JEWS 1945	MISSING
Soviet Union	5,439,000	200,000	700,000	130,000	3.5-4.5 million	0-1 million

The Soviet Union is considered here as defined by its post-war boundaries until the early 90's. To determine the number of victims, Benz merely subtracts the number of Jewish citizens present after the war from the pre-war number. He then subtracts from the result the victims of Bessarabia and northern Bukovina, in other words, 100,000 victims which are included in his count for Rumania (B409), as well as the victims from Bialystok and Galicia (600,000, included in his count for Poland, B451). We do not need to correct this here, since we have discussed Rumania as well as Poland in their post-war boundaries. *But Benz commits two major errors in this context:* first, he forgets that after the war the Soviet Union annexed the Carpathian Ukraine, with a pre-war Jewish population of approximately 100,000. But since the victims from this area were included in the count for Hungary (B338, approximately 90,000 victims), this does not affect Benz's statistics. In our analysis, however, we considered Hungary and Czechoslovakia in their post-war boundaries and must therefore add the Carpathian Ukrainian Jews to the Soviet figures. This increases both the pre-war Jewish population and the number of victims accordingly. Of the approximately 101,000 Jews from the Carpathian Ukraine, Sanning considers 15,000 as missing and 86,000 as absorbed by the USSR (S156).

Secondly, Benz overlooks the fact that, contrary to his own claim, the former regions which made up the Reich Commissionerships of Ostland and the Ukraine are included in his discussion of Poland. Since Benz assumes approximately 1 million Jews in the Soviet-occupied area (B443), of which roughly 600,000 are properly accounted for in the adjustments he makes for Bialystok and Galicia (B457), this means that he counted some 360,000 Jewish victims twice (90% victims of the 400,000 Jews living there). **This brings the total of Jewish victims counted twice by Benz to 533,193.**

#### 3.10.1. The Soviet Deportations

Sanning's category "*German Theater of War*" in the above table includes Jewish losses suffered in the area under German military influence as the results of pogroms not carried out or initiated by German troops, of starvation and epidemics, as well as of the execution of partisans (*permitted by international law*) of which Jews are known to have comprised a very great percentage. This category, as well as "*Casualties of deportation*" and "*Killed in combat*" in the Red Army, are rather willfully dismissed by Benz:

“It [the number of victims] also includes the casualties among Jewish soldiers and civilians [partisans] as well as those who succumbed to the strain of flight and to starvation. This is justified. They too were victims of brutal National Socialist policies.” (B560)

Benz neither quantifies these categories, nor does he give reasons for this catch-all approach, for these are the closing words of his book. However, there certainly are clues to be found regarding the attitude embraced by the book’s collective authorial mind.

For example, Benz speaks of the “*attack on the Soviet Union*” (B499), and asserts that Stalin had done everything he could to “*give Hitler no pretext for anti-Soviet measures, least of all for war*” (B507). Further, he believes that the Soviet Union had practiced a “*policy of appeasement*” (B508). Today it is generally acknowledged even in Russia that the fairy-tale of Germany’s attack on the peace-loving Soviet Union really belongs in the junk room of Communist war-time propaganda.<sup>52</sup> In this respect, the losses resulting from the war are not due exclusively to Germany, and they certainly have no relevance whatsoever to any aspect of the Holocaust.

Benz suggests that there are no systematic accounts of the extent and scope of Soviet evacuations and deportations of material resources and human beings. He dismisses this very important aspect in merely two paragraphs, with the comment that Stalin did not wish to provoke Hitler with evacuation activities (no, it’s not a joke – he really does claim this!) and that there were therefore hardly any noteworthy deportations (B507). Sanning, on the other hand, devotes pages 53-109 exclusively to this issue and draws on a wide range of Allied, Jewish and Soviet statistics to offer sound data regarding the scope of Soviet evacuation and deportation measures at the start of the war. And with that, Benz’s claim that there are no systematic accounts of this topic is already disproved. Did Benz and his co-authors not even read Sanning’s book after all? But clearly they must have, for Benz does not deem Sanning’s explanations in general to be a systematic account:

“[...] *The author [Sanning] distinguishes himself through his methodologically unsound handling of the statistical material as well as through daring and demonstrably erroneous reasoning and conclusions.*” (B558, footnote 396.)

Unfortunately, Benz does not enlighten his readers as to what might be erroneous about Sanning’s arguments. While Benz assumes that approximately 3 to 3.2 million Soviet Jews came under the sphere of influence of German troops (B509), Sanning again shows, on the basis of unimpeachable sources, that the number must have been less than one million (S103). He documents the fact that in most Russian cities a large part of the population that was fit to work, and especially the intelligentsia, had already been evacuated by the time German troops moved in. It is beyond the scope of the present work to detail Sanning’s plethora of documentation and proof at this point, but one of his arguments shall be discussed in greater detail. It is generally accepted that some 600,000 Jews wore the Red Army uniform. If one considers that many Jews were deported to labor camps beyond the Ural Mountains, and that the normal recruiting level did not exceed 30% of the male population in any of the nations involved in World War Two (all of which has been documented), then according to Sanning at least 4 million Jews must have lived in the non-occupied parts of the Soviet Union.

Now it may well be that these 600,000 Jews were already conscripted before the war, since as we know the USSR was planning her own large-scale attack on Europe,<sup>52</sup> and for that the Soviets had

<sup>52</sup> Eg. cf. V. Suvorov, *Icebreaker: Who Started the Second World War?* Hamish Hamilton, London 1990; E. Topitsch, *Stalin’s War: A Radical New Theory of the Origins of the Second World War*, Fourth Estate, London 1987; W. Post, *Unternehmen Barbarossa*, Mittler, Hamburg 1995; F. Becker, *Stalins Blutspur durch Europa*, Arndt Verlag, Kiel 1996; Becker, *Im Kampf um Europa*, 2<sup>nd</sup> ed., Leopold Stocker Verlag, Graz/Stuttgart 1993; W. Maser, *Der Wortbruch. Hitler, Stalin und der Zweite Weltkrieg*, Olzog Verlag, Munich 1994; J. Hoffmann, “*Die Sowjetunion bis zum Vorabend des deutschen Angriffs*”, in Horst Boog et al., *Das Deutsche Reich und der Zweite Weltkrieg*, vol. 4: *Der Angriff auf die Sowjetunion*, 2<sup>nd</sup> ed., Deutsche Verlags-Anstalt, Stuttgart 1987; Hoffmann, “*Die Angriffsvorbereitungen der Sowjetunion*”, in B. Wegner (ed.), *Zwei Wege nach Moskau*, Piper, Munich 1991.

deported most of the male population fit for military service during the German advance. This would mean *for Benz* that only few men of an age for military service would have been left to fall into the hands of the Germans, so that in the occupied regions more than 90% of the female Jews would have been exterminated while the conscripted and deported men in the hinterland and in the army would have had a considerably better chance for survival. According to Benz, the mortality rate among the women would thus have been greater than or at least equal to that among the men. From this it follows that a demographic analysis of the Soviet Union today should reveal greater or equal numbers of men in the age group that was of military age at the time in question. However, this is clearly not the case. Rather, the sex distribution corresponds to that of the other Soviet peoples, in other words, there is a similar deficit of men. This means either that men and women were deported in roughly equal numbers and consequently relatively few Soviet Jews actually fell into German hands, or that Jewish women who fell into German hands were generally *not* killed.

Regarding the number of Jews to be found in the post-war Soviet Union, Benz cites Soviet census data only. He sets out that “*doubts about the reliability of Soviet censuses [...] are not justified*” because these data served as the basis and foundation of the Soviet national economy (B558).

But every child knows nowadays that all conceivable kinds of data have been falsified in the service of precisely this national economy so as to manifest Soviet superiority in economic competition with the capitalist western world. Domestically speaking, these falsifications served to close Russian eyes, ears and mouths to the inexorably approaching collapse. But where the number of Jews identified by the censuses is concerned, there is not even any need for falsification. After all, the radically atheistic Soviet Union was one of those nations that made it especially difficult for the Jews to profess their faith. Therefore, the numbers of Jews that voluntarily acknowledged their faith in 1959 and 1970 (2.2 and 2.1 million, respectively; B559; S117) says nothing at all about the number of survivors in the Soviet Union. Jewish estimates dating from the 1970s suggest 3 to 4 million Soviet Jews (S117ff.). More recent newspaper reports even speak of 5 million Jews and more, which, however, seems unlikely in light of the stagnating demographic trends.<sup>53</sup> Since Zionist circles are striving for the emigration of Jews from Russia to Israel after the collapse of the Soviet Union, it is possible that they tend to exaggerate the number of Jews in Russia, with the intent to dramatize their hard lot during 70 years of Stalinist oppression. The numbers of presumably present or missing Jews thus serve as politically strategic putty in other respects as well.

### 3.10.2. Mass Extermination in the Soviet Union

In terms of the mass murders of Jews on Soviet soil, Benz again cites mostly witness testimony as evidence.

Behind the frontlines of the German troops fighting in the Soviet Union, the so-called Special Units (*Sonderkommandos*) served, according to Benz, to combat partisan activity (B514f.; 518; 520; 528f.; 540). Aside from that, they allegedly were also chiefly responsible for the mass executions of Jewish civilians, whose numbers are very difficult to ascertain (B577). Benz suggests that the statistics circulated during the war in this respect by the Jewish Anti-Fascist Committee are much too low, so as to “[...] *show the Soviet endeavors to rescue the Jewish population in an (inappropriately) favorable light in the United States.*” (B557, footnote.) But since the United States never bothered about the Jewish victims, and in fact exaggerated the number of victims in their own propaganda after 1933, it is not clear just how and whom Jewish anti-Fascists could have impressed in the States with allegedly deflated statistics. Benz’s suggestion, that anti-Fascists should have trivialized the alleged Fascist atrocities for propaganda reasons, is something completely new; the opposite is

---

<sup>53</sup> *New York Post*, July 1, 1990.

surely more likely. One can only conclude from all this that these numbers of victims that Benz considers to have been deflated by the anti-Fascists are in fact already exaggerated.

Regarding the use of vans for mass gassings in the Soviet Union, Benz offers us a single, particularly suspect source: the Stalinist show trials of Char'kov and Krasnodar (B526f.; 540).<sup>54</sup> Such utterly uncritical, indiscriminate citing almost makes one wonder whether Benz and his co-authors perhaps might even share Stalinist sentiments. Ignorance is no excuse for qualified scholars.

The mass executions in the East are generally considered proven, *i.e.*, documented by the so-called “*USSR Event Reports*” which the Special Units allegedly sent to Berlin on a regular basis and which detail, among other things, the number of executions. All events, however, were not listed there, so that Benz considers them an insufficient basis for determining the number of victims (B542f.). One exception, it is claimed, is the typical case of Babi Yar (B530; 534; 542). But as it has been irrefutably proven by now that the alleged massacre of Babi Yar is an atrocity lie of no substance,<sup>55</sup> this admittedly throws the authenticity or at least the reliability of the entire IMT document series “*USSR Event Reports*” and all other documents into doubt, and hence the entire Special Units mass murder *per se*. Even Benz’s shameless assertion that “*the authenticity of these reports is beyond question*” (B541) cannot change that, since H.-H. Wilhelm, whom Benz quotes as proof of his claims, states as well, that the reliability of the figures given in these documents is doubtful.<sup>56</sup> How did H.-H. Wilhelm describe the behavior of Benz:<sup>57</sup>

“*Often, the consensus of research can only be explained by the researchers copying each other’s work uncritically.*”

Thus, Benz argumentation is typical of the reciprocal quoting that characterizes the “*standard literature*” of Holocaust apologetics, “*in which reciprocal citing produces the impression of a scientifically sound network of argumentation [...]*” (B8, footnote 24).

It should also be pointed out that Benz repeatedly stresses that the Germans destroyed all evidence of their mass exterminations, mostly through exhumation and complete incineration, for which reason no victims or mass graves remain in evidence (B320; 469; 479; 489; 537f.). Millions of victims allegedly disappeared without a trace. And in the case of Babi Yar, Benz implies, even in a manner invisible to methods of aerial reconnaissance.

Gigantic mass graves cannot be rendered undetectable by exhuming and burning the bodies they contain. Such large-scale disturbance of the soil and the concomitant disruption of soil layers, the settling of the fill etc. would be evident not only in the contemporaneous Allied and German air photos, but also today, if someone only cared to look. Since according to Benz “*this task was [carried out] inadequately in at least a few cases*”, there ought in fact to be much more evidence remaining: bodies or parts thereof that were not burned, millions of bones and teeth, as well as loads of ashes.<sup>58</sup>

If anything of the sort had ever been found, the Stalinist Communists – who were known for their efficient and effective propaganda system – would have made the most of this, naturally in the presence of international investigative committees. It would have been a welcome opportunity for revenge for the embarrassment the Germans had inflicted on the Soviets with respect to Katyn, which

<sup>54</sup> Cf. the chapters by F. P. Berg and I. Weckert, this volume.

<sup>55</sup> Cf. the chapters by H. Tiedemann and J. C. Ball, this volume.

<sup>56</sup> Cf. the remarks in the introducing chapter, note 142-144, p. 44.

<sup>57</sup> H.-H. Wilhelm, in U. Backes, E. Jesse, R. Zitlmann (eds.), *Die Schatten der Vergangenheit*, Propyläen, Berlin 1992, p. 403.

<sup>58</sup> Cf. C. Loos, *RHR* 5 (1991) pp. 136-142 (online: [www.lebensraum.org/french/rhr/Loos.pdf](http://www.lebensraum.org/french/rhr/Loos.pdf)), as well as the chapter by A. Neumaier, this volume.



was only then being revealed, with the assistance of international investigative bodies, as the Soviet mass murder of Polish officers.<sup>59</sup>

But no, the oh-so-peace-loving Soviet Union would never have thought of doing anything so mean... Even today, when the mass graves of hundreds of thousands of Stalin's victims are being discovered, often by accident and 50 or even 60 years after the fact, there are still no traces of any German mass graves or burning sites, and in fact any public speculation whether modern methods might not help to locate some is studiously avoided – after all, any such sites have vanished without a trace, thanks to the wondrous methods *only* the Germans knew about.

When the German army retreated, what *did* turn up instead of mass graves were tens of thousands of women, old men, and children. In his address of indictment to the IMT, General Roman A. Rudenko explained that hundreds of thousands of children, women and old men who were unfit for forced labor were left behind in concentration camps by the Germans during their retreat.<sup>60</sup> Counselor A. A. Smirnov submitted a document giving more details of these camps in White Russia.<sup>61</sup> Urgent field research is needed to find out whether these people unfit for work may possibly have been some of those who were 'selected' in the camps further west and who, according to Steffen Werner's theory, were in fact deported primarily to White Russia.<sup>62</sup>

## 4. Of Victims, and Persons Missing and Found

### 4.1. The Number of Victims, *i.e.*, Missing Persons

NATION	VICTIMS, BENZ	VICTIMS, BENZ – REDUCED BY DUPLICATE COUNTS	MISSING, SANNING
Germany	160,000	139,000	123,000
Austria	65,459	48,767	36,000
Luxembourg	1,200	1,200	Total: 124,500
Belgium	28,518	28,518	
France	76,134	76,134	
Netherlands	102,000	102,000	
Denmark	116	116	
Norway	758	758	Total: 1,000
Italy	8,564	5,914	9,000
Albania	?200	?200	0
Greece	58,885	58,885	53,000
Yugoslavia	60,000	60,000	56,000
<b>Hungary</b>	<b>550,000</b>	<b>277,000</b>	<b>71,000</b>
Czechoslovakia	143,000	164,000	112,000
Rumania	211,214	107,295	3,742
Bulgaria	11,393	0	-7,600
<b>Poland</b>	<b>2,700,000</b>	<b>1,800,000</b>	<b>516,511*</b>
<b>Soviet Union</b>	<b>2,100,000</b>	<b>2,890,000</b>	<b>15,000**</b>
<b>TOTAL</b>	<b>6,277,441</b>	<b>5,759,785</b>	<b>1,113,153</b>

\*excluding the victims of Polish repatriation; \*\*15,000 missing from the Carpathian Ukraine.

On pp. 15f. of his book Benz lists, for each country, the number of victims on which the co-authors of his book have agreed. In the preceding table, only the entries for Italy and Greece show

<sup>59</sup> F. Kadell, *Die Katyn-Lüge*, Herbig, Munich 1991.

<sup>60</sup> International Military Tribunal, *Trial of the Major War Criminals*, IMT, Nuremberg 1947, v. VII, p. 171, Feb. 8, 1946.

<sup>61</sup> *Ibid.*, v. VII, pp. 578ff., Feb. 19, 1946; cf. Document USSR-4, not included in the IMT Document Volumes.

<sup>62</sup> S. Werner, *Die 2. babylonische Gefangenschaft*, pub. by auth., Pfullingen 1990 (online: vho.org/D/d2bg/I\_II.html; English: vho.org/GB/Books/tsbc); Werner, *DGG* 41(4) (1993) pp. 13-17 (vho.org/D/DGG/Werner41\_4.html).

different numbers, specifically the numbers given by the respective authors themselves, since the figures contained in Benz's list differ slightly from these and do not appear in the chapters themselves (Italy 6,513, Greece 59,185).

The difference between Benz's total and the total reduced here by the number of victims counted twice amounts to 517,656, which due to statistical rounding diverges only insignificantly from the 533,193 duplicate counts traced in the preceding. **This proves fully half a million 'duplicates' in Benz's highly lauded 'definitive work', and corresponds to an approximate 10% inflation of the total.** This ought not to have happened if Benz had taken the trouble to coordinate the individual chapters of his book. In his introduction, however, Benz mentions a sum total of 5.3 to just over 6 million Holocaust victims.<sup>20</sup> It seems, therefore, as though Benz had already taken these duplicate counts into consideration, even if his results are not verifiable due to his failure to explain his line of reasoning.

The decisive difference between Benz and Sanning lies in their treatment of three countries: (Greater) Hungary, Poland, and the Soviet Union. On the basis of these examples we have shown here the (possibly deliberately) *erroneous* and *falsifying* methods of which Benz and his co-authors availed themselves in order to produce their statistics and to arrive at the desired result.

## 4.2. The Generally Accepted Distribution of Victims

In 1990, the number of victims for Auschwitz, which had been set at approximately 4 million by the Polish authorities ever since the time of the IMT trials, was officially reduced to one million.<sup>63</sup> In early 1993, the Polish Historical Society advised lowering the figure by another 400,000, since the air photos taken by Allied reconnaissance planes had shown that the extermination of the Hungarian Jews had never taken place.<sup>43</sup> The alleged mass extermination, they say, must therefore have been discontinued in May 1944 at the latest. In 1993, Pressac has begun to advocate the theory that the mass extermination did not start until 1942, half a year later than assumed to date, for which reason the number of victims, including the murdered Hungarian Jews, should be reduced to 630,000 gas chamber victims.<sup>41</sup> If one draws the obvious conclusions from these two publications – namely, the later beginning and earlier end of the killings – then the approximately 1 million victims must be reduced by 370,000 (according to Pressac) and by another 400,000 (according to the Polish Historical Society). We are thus left with only 230,000 alleged victims of the 'gas chambers'. In the German edition of his latest book, Pressac reduces the number of gas chamber victims to about 500,000.<sup>64</sup> As I stated here in the first edition of this book, it seemed to be only a matter of time until the next downward revision of this continuously shrinking figure<sup>65</sup> would be made, and in fact, this downward revision came in 2002: 'only' 510,000 total victims are now claimed, 356,000 of them alleged gassing victims.<sup>66</sup>

Professor Ernst Nolte, for example, has considered it justified criticism to point out that while the number of victims of this supposedly largest extermination camp is being steadily reduced, the overall number of victims alleged for the Holocaust remains the same.<sup>67</sup> But the matter takes a turn

<sup>63</sup> Cf. *Jüdische Allgemeine Wochenzeitung*, July 26, 1990; *Der Spiegel* 30/90, 111; *Süddeutsche Zeitung*, Sept. 21, 1990; *Die Tageszeitung*, July 18 and 19, 1990; cf. also F. Piper, *Die Zahl der Opfer von Auschwitz*, Verlag Staatliches Museum in Oswiecim, Auschwitz 1993.

<sup>64</sup> J.-C. Pressac, *Die Krematorien von Auschwitz. Die Technik des Massenmordes*, Piper, Munich 1994, p. 202.

<sup>65</sup> For a general critique of the alleged Auschwitz death toll, see Robert Faurisson, "How many deaths at Auschwitz?", *The Revisionist* 1(1) (2003), pp. 17-23 (online: [vho.org/tr/2003/1/Faurisson17-23.html](http://vho.org/tr/2003/1/Faurisson17-23.html)); Werner Rademacher, "Die Wandlungen der Totenzahl von Auschwitz", *ibid.*, pp. 256-267 (online: [vho.org/VffG/1999/3/Rademacher256-267.html](http://vho.org/VffG/1999/3/Rademacher256-267.html)).

<sup>66</sup> F. Meyer, "Die Zahl der Opfer von Auschwitz", *Osteuropa*, 52(5) (2002), pp. 631-641.

<sup>67</sup> E. Nolte, *Streitpunkte*, Propyläen, Berlin 1993, p. 312.

for the grotesque when the number of Auschwitz victims is reduced and at the very same time the Israeli memorial site Yad Vashem hastens to report that new research in Soviet archives has revealed that the number of Jewish victims of mass execution behind the front is actually higher by 250,000 than was assumed to date, so that one should, in fact, reckon 6.25 rather than 6 million<sup>68</sup> or even up to 7 million.<sup>69</sup> One can only wonder with which statistical data and by which methods these revised figures were obtained.

But if the body count for the individual camps continues to drop and the overall total remains the same or even increases, then one must ask where the victims may have died, if not in the alleged gas chambers? To solve this problem there are always endeavors, for example, to increase the number of victims for other camps. Case in point: for Treblinka, figures ranging from 700,000 to 900,000 have been the standard to date.<sup>70</sup> Benz now postulates between 1 and 1.2 million (B468), of which 974,000 are said to have been Polish Jews (B495). Thus, Treblinka with its more than one million victims is weighted more heavily in Benz's analysis than Auschwitz is – a completely new trend in Holocaust studies.

CAMP	VICTIMS ACCORDING TO THE IFZ	METHOD OF KILLING	VICTIMS, BENZ, P. 17
Chelmno:	150,000	gas vans (CO)	152,000
Belzec:	600,000	exhaust gases (CO)	600,000
Sobibor:	200,000	exhaust gases (CO)	250,000
Treblinka:	700,000	exhaust gases (CO)	900,000
Majdanek:	50,000	shooting, exhaust gases (CO), Zyklon B	60-80,000
Auschwitz-Birkenau:	more than 1,000,000	Zyklon B	1,000,000
Mauthausen:	4,000	Zyklon B, gas vans (CO)	
Neuengamme:	450	Zyklon B	
Natzweiler:	several thousands	Zyklon B	
Stutthof:	200	Zyklon B	
Ravensbrück:	more than 1,000	Zyklon B	
Dachau:	at least 2,300	Zyklon B	
	experimental gassings	Zyklon B	
<b>TOTAL, APPR.</b>	2,710,000		3,000,000
<b>TOTAL VICTIMS, APPR.</b>	6,000,000		6,000,000
<b>REMAINDER, APPR.</b>	3,290,000		3,000,000

Now that the victims of Auschwitz have decreased numerically to far below the 1 million mark, the remaining 5 to 6 million victims must be distributed among other killing centers. The preceding table represents the distribution of victims as the official *Institut für Zeitgeschichte* (IfZ) would have it until recently.<sup>71</sup> It is interesting, first of all, that the IfZ *revised* the statement of its former Head, Martin Broszat, who had said that there were no gassings in the concentration camps of the Reich proper.<sup>45</sup> The fact that the above list once again contains the facilities of Dachau, Sachsenhausen, Ravensbrück, etc.,<sup>72</sup> is no doubt due to the Institute's realization that one must never partially admit a lie because that means running the risk of being exposed totally. The figures listed in the last col-

<sup>68</sup> "Mehr Judenmorde als bisher bekannt" [More Jews murdered as known before], *Süddeutsche Zeitung*, Dec. 17, 1991, p. 7; similar reports were to be found throughout the other daily media.

<sup>69</sup> R. Breitman, "Holocaust Secrecy Now Abets More Genocide", *New York Times*, November 29, 1996; D. David, "British Documents: 7 million died in Holocaust", *Jerusalem Post*, May 20, 1997.

<sup>70</sup> Cf. the chapter by A. Neumaier, and Ingrid Weckert's remark about Yad Vashem (p. 239), this volume.

<sup>71</sup> Report of the Institut für Zeitgeschichte, May 1990.

<sup>72</sup> E. Kern, *op. cit.* (note 45); see also G. Schirmer, *Sachsenhausen – Workuta*, Grabert, Tübingen 1992, pp. 10, 49ff.

umn are those given in Benz's book and originate with a much older publication of the IfZ.<sup>73</sup> One wonders why Benz did not use more recent statistics provided by the same source.

It would also be interesting to see how historians might try to explain the 3-million-plus discrepancy between these approximately 2,700,000, *i.e.*, 3,000,000 victims, most of them 'victims of the gas chambers', and the overall total of roughly 6 (or even 7) million victims. If one continues to reduce the Auschwitz death toll in accordance with the new trends to this effect, and simultaneously increases the overall total, this means that there are 4 million victims that must be freshly redistributed. Benz's minor increase of the number of Treblinka victims, from 700,000 to 1.2 million (B468), is not enough to solve the problem, and contradicts the above statements of the selfsame *Institut für Zeitgeschichte*. The remaining 3 to 4 million Jews cannot possibly be explained away as victims of *Einsatzkommando* executions, starvation and disease, and the like. Such numbers of people – numbers of a similar magnitude as the total population of Berlin – do not simply vanish without a trace. It is thus not surprising that Benz does not attempt to explain in his book where the missing remainder might fit in.

### 4.3. The Exodus – the Return of Missing Persons

Benz does not spend so much as one single paragraph on the problem of Jewish post-war emigration from Europe. And what is more: he does not even *mention* that after the war there was a large-scale migration, especially of the European population of Jewish faith, which has become known as the modern Exodus. The first ten sections of his book are conspicuous in their lack of any mention of post-war emigration, while others (Greece and Yugoslavia) fashion a fig-leaf for themselves by admitting to a few hundreds or thousands who left the country after the war's end.

Since Benz usually calculates the numbers of victims from the difference between pre- and post-war populations, this cannot but result in a great margin of error. Sanning, on the other hand, presents a summary of Jewish immigration into non-European nations, which is reproduced in the above table (S173). These data has never been refuted, not even by Benz, so that one may assume that the figures are correct.

Sanning shows that in 1970 there were still some 860,000 Jews in formerly German-occupied Europe, excluding the Soviet Union (S174). Since the Jews of western Europe exhibited next to no population increase after the war, then in light of the post-war emigration (some 1.548 million, cf. above table) at least

2,408,000 Jews must have lived in the formerly German-occupied non-Soviet parts of Europe after the war. Sanning determines that immediately after the war only 1,443,000 Jews were statistically located in formerly German-occupied

<b>IMMIGRATION OF EUROPEAN JEWS BEFORE AND AFTER THE SECOND WORLD WAR</b>		
<b>DESTINATION</b>	<b>AFTER THE WAR</b>	<b>BEFORE THE WAR</b>
Palestine	73,000 ('45-'48)	293,000 ('32-'44)
Israel	585,000 ('48-'70)	
USA <sup>74</sup>	490,000	406,000 ('33-'43)
Latin America	150,000	180,000 ('30s)
Canada, Australia, England, South Africa	250,000	90,000 ('30s)
<b>TOTAL</b>	<b>1,548,000</b>	<b>969,000</b>

<sup>73</sup> I. Arndt, W. Scheffler, *VfZ* 24 (1976) p. 105.

<sup>74</sup> Since the United States does not register the religious denomination of immigrants, the official American statistics regarding the immigration of Jews are very unreliable; cf. Sanning, *The Dissolution...*, *op. cit.* (note 18), pp. 160-166. How very problematic the statistics for Jews living in the United States are becomes apparent from a report of the *National Observer* of July 2, 1962, according to which the number of Jews in the States was not 5 to 6 million, as officially reported, but rather 12 million – a most improbably high figure; cf. E. L. Ehrlich, *Aus Politik und Zeitgeschichte* 38(16) (1988) pp. 16-22; *DHZ* 4 (1962) pp. 31f.

non-Soviet Europe (S157), while 1.1 million were considered missing (cf. Table p. 200).

Benz arrives at 1.2 to 1.3 million statistically accounted-for Jews in formerly German-occupied, non-Soviet Europe immediately after the war. The difference between this and the 2.4 million Jews which Sanning can account for, a difference of 1 to 1.2 million Jews, therefore, emigrated after the war without registering. If one relates these unregistered emigrations to the 1.1 million Jews which Sanning identifies as missing from the formerly German-occupied parts of Europe, then in view of the great fluctuations in the data one cannot, according to Sanning, make any statistically reliable observations regarding whether or how many Jews died from unknown causes under the Third Reich. In this context, ‘statistically reliable’ means: since the fluctuations in the data range well over several hundreds of thousands, any losses on this order of magnitude cannot be demonstrated with any degree of certainty. In any case, however, it indicates that *the Jewish population* in formerly German-occupied non-Soviet Europe very likely *did not suffer any losses ranging into the millions during World War Two*.

#### 4.4. Corrections for Wolfgang Benz

STARTING FIGURE (BENZ)	MINUS	REASON
5.3 to 6 million	at least 1 million	unregistered post-war emigration
	at least 1.5 million	Jews not statistically registered in the Soviet Union
	at least 0.5 million	victims of war, partisan warfare and Soviet deportation
	0.7 million	statistically inflated no. of Jews in pre-war Poland
	at least 0.3 million	destruction of the Hungarian Jews disproved
<b>5.3 TO 6 MILLION MINUS AT LEAST 4 MILLION → A MAXIMUM OF 1.3 TO 2 MILLION MISSING PERSONS</b>		

If one deducts the approximately 1 million unregistered emigrants from the 5.3 to 6 million victims that Benz claims he found, this leaves him with 4.3 to 5 million victims. From this, one must further deduct the difference between the Soviet Jews who appeared in Soviet statistics and the real number (some 1.5 million), the number of Jews who died in the Soviet Union from other causes (deportation, war, partisan warfare, at least 500,000), the number of statistically fabricated additional Polish Jews (some 700,000) as well as the number of Hungarian Jews who probably did not succumb in their entirety (300,000), in other words, a total of roughly 4 million. This would leave Benz with a remainder of at most 1.3 to 2 million unsolved cases.

### 5. The Jewish World Population

Benz studiously avoids this ‘hot potato’ as well. Sanning, on the other hand, takes the trouble to trace the world-wide development of the Jewish population from before World War Two to today. He points out, among other things, that the official post-war statistics do appear to reflect losses from the Holocaust (S181). However, the Jewish world population outside the Soviet Union increased as rapidly in the first few decades after the war as is normally seen only in developing countries or in rural populations (S186ff.). Since nearly everywhere in the world the Jews are almost completely urbanized and belong mostly to the middle and even the upper classes, both of which factors would lead one to expect only a low rate of natural increase, this would indicate that something is very wrong here. From detailed demographic analyses Sanning draws those conclusions that were quoted here at the beginning, but which we will not discuss further since there appear to be no counter-arguments to them anyhow.

## 6. Statistical Checks

### 6.1. The Fate of Jewish Personalities

In the late 1980s the Swedish demographer Carl O. Nordling recreated the fate of Jewry during the Second World War by means of a statistical study<sup>75</sup> based on the Jewish personalities listed in the *Encyklopædia Judaica*.<sup>76</sup> He chose 722 Jews entered therein, drawn from 12 European countries<sup>77</sup> that had come under German rule or supremacy in the course of the war. His choice was based on the following criteria:

- born between 1860 and 1909;
- not emigrated by January 1, 1938;
- still living on January 1, 1939.

According to Nordling's study, 317 (44%) of these 722 Jews had emigrated by late 1941, 256 (35%) were spared internment of any kind. Altogether, 95 of these Jewish personalities died during this time (13%), of which 57 cases (8%) occurred in the eastern camps as well as in unknown places and under unknown circumstances. Aside from the casualties resulting from disease, transport and starvation, therefore, these 8% must also include the victims of any deliberate mass extermination.

For the Polish Jews, the matter stands as follows:<sup>78</sup>

Of 65 Jewish notables listed in the *Encyklopædia Judaica* on January 1, 1940, 13 (20%) emigrated, 14 (22%) survived, 38 (58%) died. Of these 38, however, 23 (60%) died, not in the eastern camps, but in freedom – in ghettos, on transports, as consequence of armed conflict or reprisals, as well as victims of starvation and disease in western camps (Dachau, Nordhausen). In only 15 cases, in other words in approximately 23% of the Polish Jewish notables, the place of death is either unknown or located in one of the eastern camps; and here it is again necessary to consider that some of them succumbed to starvation, disease and forced transports at the end of the war. Even among the Polish Jewish personalities, therefore, probably less than 15% could have been victims of a hypothetical mass extermination. Benz, on the other hand, assumes that approximately 80-90% of all Polish Jews present in Poland in 1940 – some 2 million, according to him – were murdered in the extermination gas chambers (B495).

In another study, Nordling compares his statistical findings with those of W. N. Sanning, a comparison which we will discuss at greater length here.<sup>79</sup>

The percentages determined are astonishingly similar in many respects, and this indicates that Sanning's findings do indeed reflect the fates of Jewish notables as these are set out in the *Encyklopædia Judaica*. It is also worth noting that the opportunities for emigration were fewer, or the desire to emigrate was lesser, for Jewish personalities than was the case for the average Jewish population.

<sup>75</sup> C. O. Nordling, *Revue d'Histoire révisionniste (RHR)* 2 (1990) pp. 50-64; Engl.: *JHR* 10(2) (1990) pp. 195-209 (online: [vho.org/GB/Journals/JHR/10/2/Nordling195-209.html](http://vho.org/GB/Journals/JHR/10/2/Nordling195-209.html)). I am grateful to R. Faurisson for bringing these papers to my attention.

<sup>76</sup> *Encyklopædia Judaica*, Jerusalem 1972.

<sup>77</sup> 170 French, 96 Poles, 93 Germans, 85 Austrians, 64 Hungarians, 63 Italians, 49 Dutch, 42 Czechs, 29 Rumanians, 13 Danes, 9 Yugoslavs, 9 Belgians.

<sup>78</sup> C. O. Nordling, *RHR* 4 (1991) pp. 95-100 (online: [www.lebensraum.org/french/rhr/Nordli4.pdf](http://www.lebensraum.org/french/rhr/Nordli4.pdf)), with corrections to update *op. cit.* (note 75); the data given here were updated by C. O. Nordling in accordance with his latest findings.

<sup>79</sup> C. O. Nordling, *RHR* 5 (1991) pp. 96-106 (online: [www.lebensraum.org/french/rhr/Nordli5.pdf](http://www.lebensraum.org/french/rhr/Nordli5.pdf)); Engl.: *JHR* 11(3) (1991) pp. 335-344 (online: [vho.org/GB/Journals/JHR/11/3/Nordling335-344.html](http://vho.org/GB/Journals/JHR/11/3/Nordling335-344.html)).

But before acknowledging Sanning's statistical findings to be correct, it is necessary to examine the fates of other Jewish population groups in the same way as that of the Jews represented in the *Encyklopædia Judaica* in order to eliminate the following potential distortions:

1. The decision of which Jewish notables to include in the 1972 edition of the *Encyklopædia Judaica* will have been influenced by the fates of the Jews in question during and after the war:
  - a) Some Jews may have been included only *because* they died as a result of German measures of persecution. Examples: Janusz Korczak (1879-1942) was included because he voluntarily went to Treblinka with a group of children; the nun Edith Stein (1891-1942) was included because she died a martyr. If these people had survived, they might not have been included in the encyclopedia.
  - b) Some Jews, on the other hand, were included only because they survived the war and could go on to become famous afterwards. For example: Pierre Mendès-France (born in 1907) was only a little-known Undersecretary of State before the war.
2. International connections or material advantages may have made emigration easier for Jewish notables than for the average Jewish citizen. However, this category of Jews had largely already emigrated by the start of the war.
3. Jewish VIPs cannot change their identity, go underground, flee, or emigrate illegally as can persons who are less well-known. Unlike for the average citizen, therefore, the life and suffering of Jewish personalities is usually easier to trace.
4. It is possible that due to their greater social and political involvement Jewish notables were subject, especially during the war, to more restrictive measures imposed by the German occupation powers.

### COMPARISON OF STATISTICAL ANALYSIS

of the Jews Living in the German Sphere of Influence

and the Corresponding Data for Identified Jewish Notables in the Same Region

Jewish Overall Population			Identified Personalities		
CATEGORY	'000	%	%	NO.	CATEGORY
Present 1939 <sup>18</sup>	5,044	177	148	629	Present in Jan. 1939 <sup>76</sup>
Emigration 1939-1941 <sup>18</sup>	-2,197	77	48	-206	Emigration 1939-1941 <sup>76</sup>
Present 1941	= 2,847	100	100	= 423	Present 1941
Jews registered in Auschwitz (assuming that 60% of all internees were Jews) <sup>76</sup>	244	8.6	8.5	35	Deported to Auschwitz <sup>76</sup>
Missing, May '45 <sup>76</sup>	-207	7.3	7.6	-32	Missing, May '45 <sup>76</sup>
Survivors of Auschwitz	= 37	1.3	0.9	= 4	Survivors of Auschwitz
Registered in Theresienstadt <sup>80</sup>	141	5.0	5.0	21	Deported to Theresienstadt <sup>76</sup>
Deported from Theresienstadt <sup>80</sup>	-88	3.1	1.2	-5	Deported from Theresienstadt <sup>76</sup>
Died in Theresienstadt <sup>80</sup>	-33.5	1.2	1.2	-5	Died in Theresienstadt <sup>76</sup>
Survivors of Theresienstadt	= 19.5	0.7	2.6	= 11	Survivors of Theresienstadt
			17.0	72	Disappeared in concentration camps after deportation <sup>76</sup>
Disappeared, due neither to emigration nor death by natural causes <sup>18</sup>	304	10.7	12.3	52	Disappeared, not due to death by natural causes
Survivors in all camps, April 1945 <sup>81</sup>	275	9.6	5.7	24	Survivors in all camps, May 1945

<sup>80</sup> H. G. Adler, *Theresienstadt 1941-1945*, Mohr, Tübingen 1955.

<sup>81</sup> N. Masur, *En jude talar med Himmler*, Stockholm 1945.

## 6.2. The Korherr Reports

Richard Korherr was the leading statistician of the Third Reich. In early 1943, on Himmler's instructions, he drew up a report on the trends which European Jewish population statistics had exhibited since the NS had come to power. Himmler wanted to submit this report to Hitler. After several discussions and some correspondence with Himmler, Korherr revised and shortened his first report.<sup>82</sup> These two reports as well as the correspondence that goes with them are counted among the allegedly central pieces of evidence proving the Holocaust, on whose basis G. Wellers, for example, believes he can set the number of victims of the Holocaust at approximately 2 million by late March 1943 alone.<sup>83</sup>

It needs to be said at the start that there is nothing whatsoever in the Korherr Reports and the accompanying correspondence, which was intended for Hitler's and Himmler's eyes only, which would indicate any intent to exterminate the Jews of Europe, or which would suggest that killings had already taken place – which is surprising enough, since it would hardly have been necessary to keep any such goings-on from Himmler's or Hitler's knowledge. The Report does reveal, however, that some 2½ million Jews were evacuated to the East. Korherr states:

*“Between 1937 and early 1943 the number of Jews in Europe had decreased by approximately 4 million, due partly to emigration, partly to the excess of deaths over births among the Jews of Central and western Europe, and partly to evacuations, particularly from the more densely populated eastern regions, which are counted here as part of the decrease.”*<sup>84</sup>

Why does Korherr mention that the evacuations are counted as part of the decrease? That would make sense only if they are not actually gone from Europe but are nevertheless counted statistically as having emigrated. So were they perhaps not dead? S. Challen was puzzled not only by this additional remark and by the absence of even the slightest allusion to the mass murder in these top secret papers intended for Himmler and Hitler only, but also by the fact that the reputedly best statistician in Germany covered up gross errors in his report so elegantly.<sup>85</sup>

In his conclusions, for example, Korherr wrote that the Jewish population losses in Europe from 1933 to 1943 (some 5 million) were caused approximately 50% by emigration to other continents, but his statistics cite only about 1.5 million emigrants. So roughly 1 million emigrants are missing. This begs the question: why would Germany's foremost statistician draw conclusions contradicting his own data, and in a secret report intended for Hitler, no less? Furthermore, if one adds Korherr's individual 1943 figures regarding the Jews scattered throughout the world, one arrives at a total that is only slightly less than the pre-war total; this already rules out any mass extermination. S. Challen therefore went to the trouble of examining Korherr's claims more closely. He ultimately concludes that Korherr, acting on Himmler's orders, reduced the emigration statistics by one million and increased the number of Jews evacuated to the East by that same million. And in one of his letters, Himmler writes that this report would serve well as a cover.<sup>86</sup> Challen arrives at the well-founded conclusion that Himmler wanted to keep Hitler from realizing that a large part of the Polish and Russian Jews in the East had gotten away by means of flight and Soviet evacuation measures. On

<sup>82</sup> IMT Documents NO-5193 to 5198.

<sup>83</sup> G. Wellers, *op. cit.* (note 17); cf. the critique of Wellers by C. Mattogno, “*Sonderbehandlung. Georges Wellers und der Korherr-Bericht*”, *VffG* 1(2) (1997) pp. 71-75 (online: [vho.org/VffG/1997/2/Mattogno2.html](http://vho.org/VffG/1997/2/Mattogno2.html)).

<sup>84</sup> IMT Documents NO-5193.

<sup>85</sup> S. Challen, *Richard Korherr and his Reports*, Cromwell Press, London 1993.

<sup>86</sup> IMT Documents NO-5197.



the basis of Korherr's data, Challen calculated that the Jews lost approximately 1.2 million of their number during World War Two, some 750,000 of them in Germany's sphere of influence.<sup>87</sup>

In 1977, Korherr himself confirmed that he did not know anything about an ongoing extermination of the Jews during the war and was not aware that the term "*Sonderbehandlung*" (special treatment) was used as a code word to allegedly cover up mass murder.<sup>88</sup>

In the end, therefore, the Korherr Reports confirm Sanning's statistics regarding the fate of the eastern European Jews, and are not even remotely suited to proving a hypothetical mass murder.

### 6.3. Compensation

A common question is whether the number of Jewish applications for compensation from Germany would not reveal how many Jews survived the Third Reich. In fact, any such attempt runs into insurmountable problems. The German Federal Ministry of Finance does provide detailed information about compensation payments made to persons persecuted in the Third Reich. On July 1, 1979, approximately 4.3 million individual applications for compensation had been filed; 13 years later the Ministry cites some 4.4 million individual applications.<sup>89</sup> For several reasons, however, this number is difficult to interpret. For one thing, the Ministry does not register the faith group of the applicants, so that there is no way of telling how many Jews are included in the total. Secondly, approximately half the applications have been turned down, but no reasons for the individual decisions are given; perhaps the applicant had never actually been in the German sphere of influence, or perhaps he had not suffered any losses despite his/her alleged Jewish faith. The refusals can thus also not be interpreted. Thirdly, the Ministry's statistics reflect the number of applications, not the number of applicants. Since each kind of compensation (damage to life, health, property, fortune, professional advancement, etc.) must be applied for separately, any one applicant may very well have applied several times. On the other hand, many applications were made collectively by groups of persons, so that the statistics reflect entire families or even larger groups with one single application. One must also consider that until recently the Jews in the Soviet Union could not collect any compensation and are thus not included in the figure.<sup>90</sup> And finally, an American newspaper has reported that only one in two Holocaust survivors receives compensation payments from Germany.<sup>91</sup> Thus, at the present time, the statistics available regarding applications for compensation do not lend themselves to answering demographic questions.

---

<sup>87</sup> See also Carlo Mattogno, "*Sonderbehandlung. Georges Wellers und der Korherr-Bericht*", *VffG* 1(2)(1997), pp. 71-75 (online: [vho.org/VffG/1997/2/Mattogno2.html](http://vho.org/VffG/1997/2/Mattogno2.html))

<sup>88</sup> Korherr's Letter to the Editor, *Der Spiegel*, no. 31 (1977). p. 12: "*The allegation that I stated that over a million Jews died as a result of special treatment in the camps of the Government General and the Warthegau is likewise untrue. I must protest against the word 'died' in this connection. It was precisely that word 'Sonderbehandlung' that led me to make a telephone inquiry to the RSHA asking what this word meant. I received the answer that it referred to Jews who were to be settled in the district of Lublin.*"

<sup>89</sup> J. Fisch, *Reparationen*, C. H. Beck, Munich 1992; E. Rumpf, *Wiedergutmachung*, Kultur- und Zeitgeschichte – Archiv der Zeit, Rosenheim n.d. [1992]; cf. M. Weber, *JHR* 8(2) (1988) pp. 243-250 (online: [vho.org/GB/Journals/JHR/8/2/Weber243-250.html](http://vho.org/GB/Journals/JHR/8/2/Weber243-250.html)); Ger.: *DGG* 37(1) (1989) pp. 10-13 (online: [vho.org/D/DGG/Weber37\\_1.html](http://vho.org/D/DGG/Weber37_1.html)).

<sup>90</sup> It lasted until mid of 1997 that this topic was raised between International Jewish Organizations and Germany; cf. The American Jewish Committee, "*Holocaust survivors in Eastern Europe deserve pensions from the German Government*", Open Letter to the German Government, signed by 83 Senators, *New York Times*, August 17, 1997; Erik Kirschbaum, "*Jewish leader urges Bonn to pay Holocaust claims*", *Reuter*, Bonn, August 19, 1997; "*Jewish group rejects offer to Holocaust survivors*", *Reuter*, Bonn, August 24, 1997; "*Jewish group to issue list of holocaust fund recipients*", *Reuter*, New York, September 17, 1997.

<sup>91</sup> *The Atlanta Journal and Constitution*, Georgia, March 31, 1985, pp. A14ff.

## 6.4. Holocaust Survivors

According to information from the Israel-based official organization *Amcha*, which devotes all its activities to taking care of Holocaust survivors, 834,000 to 960,000 Holocaust survivors were still alive in the summer of 1997. The same organization defines a *Holocaust survivor* as

“any Jew who lived in a country at the time when it was: – under Nazi regime; – under Nazi occupation, – under regime of Nazi collaborators as well as any Jew who fled due to the above regime or occupation.”<sup>92</sup>

According to a letter from the German section of this organization, roughly  $\frac{1}{3}$  of all Holocaust survivors are so-called “*child survivors*”,<sup>93</sup> and where “*child survivors*” means that the according Holocaust survivors were not older than 16 years at the end of the war.<sup>94</sup>

If the average life expectancy of all age groups of these survivors as well as the statistical distribution of the Jews over these age groups in 1945 were known, it would be possible to calculate approximately how many Holocaust survivors were still alive in 1945, *i.e.*, after the war ended. Unfortunately we do not have such data, but we can on the one hand estimate this age distribution by extrapolating it from the known statistical distribution of the Jews of the 1920s and 1930s,<sup>95</sup> corrected by *Amcha*’s statement about the  $\frac{1}{3}$  of “*child survivors*”. On the other hand we can draw on the life expectancy statistics of another people whose fate from 1945 onwards was at least similar to that of the surviving European Jews of that time.

Since the German people as a whole experienced terrible living conditions from 1941 to 1948, it seems appropriate to draw on their mortality statistics.<sup>96</sup> For our calculations we have assumed two different age distributions in 1945: the first as given in the Atlas quoted,<sup>95</sup> and the other based on the assumption that  $\frac{1}{3}$  of all survivors in 1997 must have been between 0 and 15 years of age.<sup>97</sup> The rest of the calculations simply draw on the German “*death tables*”.

Probably the results as shown in the following table may change if we get better data about the death rates of the Jewish survivors and about their age distribution then and today. But certainly our results are likely to at least approximate the truth. If one assumes a more severe fate for the average Holocaust survivor than for the average German – which most scientists tend to do – then this would result in an even higher number of survivors in 1945.

The number of Holocaust victims would be the difference between our calculated number of survivors, and the number of Jews who were alive in Europe prior to National Socialist persecution. The inflationary definition of ‘Holocaust survivor’ by *Amcha*, however, makes our task difficult. Given this definition, it is for example not clear how one should handle the hundreds of thousands

<sup>92</sup> Adina Mishkoff, Administrative Assistant *Amcha*, Jerusalem, E-mail <adina@amcha.org> from Wed, Aug. 13, 1997, 16:17:20 CDT, to Multiple recipients of list H-HOLOCAUST <H-HOLOCAUST@H-NET.MSU.EDU>; E. Spanic, H. Factor, V. Struminsky, “*Number of Living Holocaust Survivors*”, *Amcha* Press Release, PO Box 2930, I-91029 Jerusalem, July 27, 1997.

<sup>93</sup> *Amcha* Germany, letter from Aug. 22, 1996, to all Germany mayors in order to raise funds for *Amcha*; facsimile in *VffG*, 1(2), (1997), p. 70 (online: [vho.org/VffG/1997/2/RudWie2.html](http://vho.org/VffG/1997/2/RudWie2.html)).

<sup>94</sup> Letter of A. Mishkoff, *Amcha Israel*, Jerusalem, May 17, 1998, in which the  $\frac{1}{3}$ - $\frac{2}{3}$ -distribution is confirmed.

<sup>95</sup> E. Friesel, *Atlas of Modern Jewish History*, Oxford Univ. Press, Oxford 1990.

<sup>96</sup> Cf., *e.g.*, the ‘Death tables’ (*Sterbetafeln*) for Germans in Lexikon Institut Bertelsmann (ed.), *Ich sag dir alles*, Bertelsmann, Gütersloh 1968

<sup>97</sup> For more details on this see my second articles, note 93. Since we divided our age distribution list into 5 year steps, we could not calculate a ‘child’-age of 16 years. Thus, the real numbers will be a bit lower than those given in the table’s row for 0-15 years. We didn’t correct them since the base on which these figures were calculated are not very reliable anyway, as Prof. Alan Glicksman, responsible for compiling the data for the USA, stated in an e-mail message. This is just in order to give us a clue.

<b>Jewish Holocaust Survivors according to Amcha and drawing on German ‘death tables’</b>										
Age 1945	German surviving rates [%]			Age 1997	living Holocaust survivors 1945 <sup>99</sup>			distribution $\frac{1}{3}$ “child-survivors” 0-15 years		
	1945 from original sum [%]	1997 from original sum [%]	1997 from survivors 1945 [%] <sup>100</sup>		distribution according to Atlas... <sup>95</sup>		distribution $\frac{1}{3}$ “child-survivors” 0-15 years			
					[%]	(1997: 834,000)	(1997: 960,000)	[%]	(1997: 834,000)	(1997: 960,000)
0-4	89.5	72.0	80.4	52-56	5.0	217,231	250,050	2.4	83,003	95,543
5-9	88.5	66.5	75.1	57-61	5.9	256,332	295,059	3.4	117,588	135,353
10-14	87.5	58.0	66.3	62-66	5.9	256,332	295,059	5.5	190,216	218,954
15-19	86.0	45.5	52.9	67-71	5.7	247,643	285,057	11.0	380,432	437,907
20-24	83.0	30.5	36.7	72-76	6.3	273,711	315,063	15.0	518,771	597,146
25-29	78.0	15.5	19.9	77-81	4.3	186,818	215,043	16.7	577,565	664,823
30-34	73.0	5.5	7.5	82-86	6.7	291,089	335,067	15.0	518,771	597,146
35-39	66.0	1.0	1.5	87-91	7.7	334,535	385,077	12.0	415,017	477,717
40-44	61.0	0.2	0.2	92-96	8.3	360,603	415,083	8.0	276,678	318,478
45-49	54.0	0.0	0.0	97-101	8.8	382,326	440,087	5.0	172,924	199,049
50-54	47.5	0.0	0.0	102-106	8.1	351,914	405,081	3.0	103,754	119,429
55-59	40.5	0.0	0.0	107-111	7.5	325,846	375,075	2.0	69,169	79,619
60-64	33.0	0.0	0.0	112-116	6.6	286,745	330,066	0.5	17,292	19,905
65-69	24.5	0.0	0.0	117-121	6.1	265,021	305,061	0.5	17,292	19,905
70-74	15.0	0.0	0.0	122-126	3.8	165,095	190,038	0.0	0	0
>75	5.0	0.0	0.0	127-131	3.3	143,372	165,033	0.0	0	0
<b>Total:</b>					<b>100.0</b>	<b>4,344,614</b>	<b>5,000,994</b>	<b>100.0</b>	<b>3,458,472</b>	<b>3,980,975</b>

of Jews who were deported to Soviet slave labor camps by Stalin or who fled voluntarily with the Red Army to the East right at the beginning of the German-Russian war.<sup>98</sup>

According to Sanning, and corresponding to the findings of other statistical studies, in the late 1920s and early 1930s there were roughly 6.1 million Jews in those European countries, excluding the Soviet Union, which later came under the influence of National Socialism.<sup>101</sup> Undoubtedly some 3 million Jews lived in the pre-war Soviet Union, of which at least one million lived in areas that were never occupied by German troops. Thus, in the late 1920s and early 1930s some 8.1 million Jews lived in what was to become the German sphere of influence. According to our calculations, 3.46 to 5 million of them survived the ‘Holocaust’, and 3.1 to 4.64 million did not.

The word ‘Holocaust’ is placed in quotation marks here because this figure includes not only victims of arbitrary killings by the National Socialist regime (which is a more specific definition of the term ‘Holocaust victims’), but also many other categories, such as victims of Stalinist mass deportations, Stalinist slave labor camps, victims of regular combat (as soldier, labor force or air raid victims) as well as irregular combat (partisan), victims of non-German pogroms, natural excess of deaths over births, etc. All these reasons, which certainly did reduce the numbers of Jews compared to the time prior to National Socialist rule, may add up to more than one or even two million.<sup>98</sup> *Consequently, the number of possible real Holocaust victims – according to official data provided by Israel – is probably less than 3 or even 2 million Jews.* This admission is fair enough to start with.

<sup>98</sup> Cf. W.N. Sanning, *Die Auflösung...*, *op. cit.* (note 18), p. 53-136.

<sup>99</sup> Equation used:  $(\text{distribution}[\%]) / \Sigma((1997 \text{ from survivors } 1945) \cdot (\text{distribution}[\%])) \cdot \Sigma(\text{survivors } 1997)$ ; for 0-4 years in 1945, e.g.:  $\text{distribution}[\%] \text{ for Atlas} = 5.0\%$ ;  $\Sigma((1997 \text{ from survivors } 1945) \cdot (\text{distribution}[\%])) = 19,2$  (i.e.: 19,2% of all survivors of 1945 still alive in 1997);  $\Sigma(\text{survivors } 1997) = 834,000$ , result: 217,231 for age 0-4 in 1945; total survivors in 1945: 4,344,614.

<sup>100</sup> Surviving rates 1997 divided by those of 1945. Only one decimal digit given.

<sup>101</sup> *Ibid.*, p. 243; the value for Germany has to be increased to 539,000, and the Jews of the Baltics must be added to the value for the occupied Europe.

However, one should be aware that even the published number of Holocaust survivors is a figure likely to be manipulated due to its financial implications for Jewish organizations who are permanently claiming compensations (cf. Note 90). Thus, it was not very surprising that R. Bloch, Jewish head of the Swiss Holocaust fund, the task of which is the collection of money for Jewish Holocaust survivors, announced in early 1998 that there are more than 1,000,000 Holocaust survivors still alive at that time.<sup>102</sup> There appears to be a permanent Jewish resurrection nowadays...

## 7. Conclusions

In its analysis of the central and western European nations, W. N. Sanning's book rests on a somewhat shaky foundation. Benz has the better material in this instance. Neither of the two works addresses the problem of 'de facto Jews' in sufficient detail; while each of Benz's co-authors deals with the problem as far as he sees fit, Sanning touches on this matter only marginally.

But it is the analyses of the nations Poland, the Soviet Union and Hungary, as well as the issue of post-war emigration, that are of vital significance to a determination of the number of Holocaust victims. *In this respect, Benz's work fails miserably.* Graph 1 is a visual summary of the two books. The overall height of the bars represents the number of Jews prior to World War Two in the area that later came under German dominion. Roughly speaking, Benz determines his number of Holocaust victims by subtracting the number of registered emigrants during and after the war from the initial pre-war population. He blames on the Germans Jewish victims of Soviet deportation and imprisonment no less than the victims of pogroms that took place neither with the participation nor even with the tacit approval of German troops, as well as the victims of Allied bombings, the casualties of the Labor Force, the Jewish soldiers who fell in the ranks of the Soviet armies, and the casualties from regular partisan warfare. Since none of these victims lost their lives due to deliberate or culpably negligent measures or actions by the Germans, this method of maximizing the number of victims can only be called dishonest. Sanning rightly excludes these victims from his analysis, of course with the exception of the regular partisan victims, whose numbers are difficult to estimate and which must not be lumped together with any victims of potential irregular executions.

Benz also all but ignores actual or apparent losses through non-military means such as the natural excesses of deaths over births, religious conversions, unregistered emigration during and especially after the war, as well as Jews not statistically recorded as such today. In particular, Benz fails to make any mention of the partly uncontrolled and unregistered post-war mass emi-

	BENZ	SANNING
Victims of the Holocaust		Death due to Soviet deportation and imprisonment
		Death due to pogroms by non-Germans, without German collaboration or sanction
		Death due to effects of war (labor service, bombing victims)
		Death as soldier
		Death as partisan (battle or execution)
		Natural excess of deaths over births
		Religious conversions
		Unregistered emigration during and after the war
		Jews not statistically registered or identified as Jews today
		Unsolved cases, mostly death by 'natural' causes in ghettos and camps
as for Sanning		Registered emigration during and after the war
as for Sanning		Jews remaining today

**Graph 1:** Diagrammatic representation of W. Benz's and W. N. Sanning's approaches to determining the number of Holocaust victims. The size of the individual bars does not reflect the number of cases.

<sup>102</sup> *Handelszeitung* (Switzerland), February 4, 1998. Even the Israeli Prime Minister's office recently stated that there were still nearly one million living survivors, see Norman Finkelstein, "How the Arab Israeli War of 1967 gave birth to a memorial industry", *London Review of Books*, January 6, 2000. I owe this information to David Irving.

gration that has become known as the ‘modern Exodus’; of the fact, generally acknowledged today, that Soviet statistics reflect only a fraction of the Jews actually living in the Soviet Union; and of the fact that the Polish Jews also suffered great population decreases in the inter-war period due to emigration, the disproportionate percentage of old people, and the excess of deaths over births.

Benz emphasizes that where the Soviet evacuations, the Jewish population trends in Poland, and the Polish flight migrations are concerned, there are no definite figures, and one must rely on estimates alone. He arrives at his utterly incorrect estimates in the space of a very few sentences, without any sort of logical line of reasoning. Even though he admits that these issues are in dire need of further research, he avoids any such endeavor.

Instead, the book unleashes a prodigious verbal deluge in order to rehash early Jewish history and the history of each nation’s anti-Jewish measures, something which countless other authors have already done (some of them much better) and which contributes nothing to solving the authors’ self-appointed task.

Recent findings, such as the evidence which air photos can provide regarding the alleged extermination of the Hungarian Jews, are also studiously ignored. And what is worse: where the alleged methods of killing are concerned, Benz regurgitates the old, oft-refuted claims and ignores the fact that engineers and scientists are the sole experts in this field.

Also, Benz and his co-authors quote Stalinist and Communist sources with not so much as half a thought to critical assessment even when these sources clearly go back to show trials, and blithely adopt Stalinist terminology in their arguments, showing themselves in a dubious and unscientific light in the process.

And finally, fourteen of the supposedly best subject historians in the world<sup>103</sup> were clearly incapable of ensuring uniform treatment of national boundaries in the individual chapters. An eye to this would have avoided counting half a million victims twice in the overall total.

Thus the judgment they thought to pronounce on another scholar ultimately reflects on themselves:

*“[...] almost all other studies of the Holocaust give the impression that the number of victims could be [...] determined directly from the retrospective number of [counted] Jews.”* (B408)

*“[...] The author [in this case, Benz et al.] distinguishes himself through his methodologically unsound handling of the statistical material as well as through daring and demonstrably erroneous reasoning and conclusions.”* (B558, footnote 396.)

Like Benz, Sanning commits the error of placing too much faith in those statistics which are available. In actual fact, the fluctuations in the data preclude any definitive answer to the question of how many hundreds of thousands of Jews lost their lives in the German sphere of influence. These figures are lost in the fluctuations characterizing the statistical material. To date, only those figures provided by the International Committee of the Red Cross can be regarded as certain. The ICRC’s Special Office in Arolsen keeps track of all officially documented deaths in German concentration camps of the Third

DOCUMENTED DEATHS IN GERMAN CONCENTRATION CAMPS as of Jan. 1, 1993	
<b>Total</b>	<b>296,081</b>
Auschwitz	60,056
Bergen-Belsen	6,853
Buchenwald	20,687
Dachau	18,456
Flossenbürg	18,334
Groß-Rosen	10,951
Majdanek	8,831
Mauthausen	78,859
Mittelbau	7,468
Natzweiler	4,431
Neuengamme	5,785
Ravensbrück	3,639
Sachsenhausen	5,014
Stutthof	12,634
Theresienstadt	29,375
Other camps	4,704

<sup>103</sup> Aside from the contributors to his volume, Benz also thanks Professors Yisrael Gutman, Otto D. Kulka, Yehuda Bauer, Christopher Browning, Czeslaw Madajczyk, Helmut Krausnick, H. D. Looock, Randolph L. Braham and Wolfgang Scheffler, p. 20.

Reich. A summary from January 1, 1993, documents 296,081 deaths. The distribution of these deaths among the individual camps is shown in the accompanying table.

Jews probably constitute about half of the total. One must keep in mind, however, that these cases are not all. The camps Chelmno, Belzec, Sobibor and Treblinka are missing from the table, as are the victims in the ghettos. And finally, one must remember that according to the Death Books approximately 66,000 people died in Auschwitz by late 1943 alone,<sup>104</sup> and that the Americans mentioned 25,000 dead in the concentration camp Dachau during the war.<sup>105</sup> A realistic estimate of the actual number of victims, therefore, may be twice as high as the total of victims registered by name in the records at Arolsen. The number of victims registered by name is now said to be about 450,000.<sup>106</sup> Doubtless the greater part of these are Jews, but exact figures are as yet unknown.

Even from this perspective, death clearly took a heavy toll.

---

<sup>104</sup> Cf. Staatliches Museum Auschwitz-Birkenau (ed.), *Die Sterbebücher von Auschwitz*, Saur, Munich 1995; for the entire time of the camps' existence, Pressac estimates the total at a reasonable 130,000: *op. cit.* (note 41), pp. 144ff.

<sup>105</sup> Prosecution Exhibit no. 35, National Archives USA, May 13, 1945, ref. no. M-1174, roll 4, frame 54; cf. E. Gauss, *Vorlesungen über Zeitgeschichte*, Grabert, Tübingen 1993, p. 235 (online: [vho.org/D/vuez/v4.html](http://vho.org/D/vuez/v4.html)).

<sup>106</sup> Without specifying the exact source, W. Sofsky (*Die Ordnung des Terrors: Das Konzentrationslager*, Fischer, Frankfurt 1993, p. 331, footnote 37) quotes the Red Cross regarding 450,000 victims registered by name.



# The Gas Vans: A Critical Assessment of the Evidence

INGRID WECKERT

## 1. The Problem, and the State of Subject Research

Among the accusations that are brought against National Socialist Germany we also find the claim that in 1941 and 1942 so-called ‘gas vans’ were used for killing victims locked into them. This was allegedly done by channeling the exhaust gas into the hermetically sealed body of the vans. ‘Gas vans’, it is claimed, were used, on the one hand, in euthanasia institutions (homes for mental patients) and, on the other, by the *Einsatzkommandos* behind the Russian front, and particularly in the concentration camp Kulmhof.

‘Gas vans’ are mentioned in numerous publications among the subject literature, but their existence is never examined critically or even questioned. The state of subject research was outlined most recently by Mathias Beer.<sup>1</sup> We shall refer to this summary on occasion. Unfortunately, space limitations preclude an analysis of the general thesis; we must restrict ourselves to touching on those points which, in our view, require closer examination in the present context, which has as its purpose the critical assessment of the evidence in the issue of the ‘gas vans’.

There is no document to indicate that ‘gas vans’ had ever come up for discussion in the Third Reich. The term dates from post-war times. The documents advanced as evidence for the ‘gas vans’ mentioned “*Sonderwagen*”, “*Sonderfahrzeuge*”, “*Spezialwagen*” [uniformly, ‘Special Vehicles’; -trans.] or “*S-Wagen*”. It was the term ‘Special Vehicle’ which prompted contemporary historians to speculate that this must have been a special kind of vehicle, one whose nature was probably kept secret. Beer writes:

“*The connection with the code word Sonderbehandlung [special treatment], i.e., killing [...] is obvious.*”<sup>2</sup>

However, it is obvious only to those who conclude the existence of ‘gas vans’ solely on the basis of the belief that unpopular persons, especially Jews, were murdered *en masse* in the Third Reich. In this way, the fact that is supposed to be proven is already taken for granted beforehand, and presented as factual argument. In fact, the German Wehrmacht had one hundred different kinds of “*Sonder-Kraftfahrzeuge*” [Special Motor Vehicles], which were known as “*Sd. Kfz 1*” to “*Sd. Kfz 250*” and even higher.<sup>3</sup> Every vehicle that required specialized equipment for any purpose was a ‘Special Motor Vehicle’. These included, for example, the heavy goods vehicle type known as “*Maultier*” (vehicles whose rear wheels had been replaced with sprocket wheels), tractor vehicles for cannons and anti-aircraft guns, but also gas detecting and decontamination vehicles for units that were specialized on gas warfare but which, fortunately, were never needed since no gas grenades were used in the Second World War. Their production and outfitting was no more secret than that of other Wehrmacht vehicles. To automatically connect the term ‘Special Motor Vehicle’ with the murder of Jews reveals gross ignorance of the facts.

---

<sup>1</sup> M. Beer, “*Die Entwicklung der Gaswagen beim Mord an den Juden*”, *Vierteljahrshefte für Zeitgeschichte* 35(3) (1987) pp. 403-417.

<sup>2</sup> *Ibid.* p. 403, note 5.

<sup>3</sup> Cf. W. Oswald, *Kraftfahrzeuge und Panzer der Reichswehr, Wehrmacht und Bundeswehr*, Motorbuch, Stuttgart 1990, p. 435; W.J.L. Davies, *German Army Handbook*, Arco Publishing, New York 1973; cf. R. Frank, *Lastkraftwagen der Wehrmacht*, Podzun-Pallas, Friedberg 1992.



There was also the description “S-Wagen” [S-Vehicle]. Beer believes that the “S” was “*the abbreviation of spezial or sonder*” (i.e., special) (p. 403), but this is incorrect. The “S” stood for “Schell-Typ” and referred to the type of drive:

*“The standard vehicle types were known as S-types, whereas the A-types had all-wheel drive, while being identical in every other respect”*<sup>4</sup>

Therefore the ‘S’ is also no identifier of vehicles intended for killing their passengers.

Two documents from the time of the Third Reich are generally cited in support of the ‘gas van’ theory: one of them is a letter dated May 16, 1942, that was submitted as Document PS-501 at the Nuremberg Trial (International Military Tribunal, IMT), and the other is a file from the Federal Archives at Koblenz, numbered R 58/871 – a Note from the RSHA (*Reichssicherheitshauptamt*, the Reich Security Main Office) dated June 5, 1942.

Aside from these documents there are only statements of defendants and witnesses in trials due to National Socialist crimes who claim they saw or heard about the ‘gas vans’, as well as comments made in indictments and verdicts.

To quote Mathias Beer:

*“However, it is not acceptable for an historian to make use of court verdicts without examining them critically, since the justice system and the science of history are guided by different objectives. For an historian, eyewitness testimony is of foremost significance because it helps to fill gaps in other sources. But due to its special nature, eyewitness testimony can be accorded a status equal to that of documents, and can be profitably exploited in historical research, only if certain principles are observed. The fundamental prerequisite is to establish, whenever and wherever possible, the connection between testimony and documents which have been critically substantiated as to their source.”*<sup>5</sup>

In other words: witness statements ought to be corroborated by documents that have stood up to critical examination. This applies particularly to such eyewitness testimony whose content is already questionable because it contradicts other eyewitness testimony of equal value. And we shall see that what we are in fact dealing with in the case of the ‘gas vans’ are exclusively such questionable witness statements.

To date, no vehicle which clearly could have served as ‘gas van’ has ever been found. Allegations that the Polish town Konin near the former concentration camp Chelmno uses such a gas van as a memorial<sup>6</sup> were refuted by the town’s officials.<sup>7</sup> On the author’s inquiry regarding alleged photos of such vehicles, both the Yad Vashem Museum in Jerusalem and the Auschwitz Museum in Auschwitz, Poland, sent the author a copy of the same photograph of unknown origin, showing the front view of a damaged heavy-goods vehicle of the type Magirus-Deutz with no indication that it was modified and subsequently used for sinister purposes.<sup>8</sup> Aside from this, a Magirus-Deutz lorry was never claimed to have served as a homicidal gas van. Since the license plate was removed from the van, it is not even certain whether this vehicle was really used by German authorities. The Yad

---

<sup>4</sup> W. Oswald, *op. cit.* (note 3), p. 177; cf. W.J. Spielberger, *Spezial-Panzer-Fahrzeuge des deutschen Heeres*, Motorbuch, Stuttgart 1977, p. 153f.; *Die Halbkettenfahrzeuge des deutschen Heeres*, 2<sup>nd</sup> ed., *ibid.*, 1984, p. 170f. (explanation of abbreviations).

<sup>5</sup> M. Beer, *op. cit.* (note 1), p. 404.

<sup>6</sup> Letter of M. Beer to P. Marais, November 20, 1987, facsimile in P. Marais, *Les camions à gaz en question*, Polemiques, Paris 1994, pp. 294f.

<sup>7</sup> Letter of the municipal administration to P. Marais, May 24, 1988, facsimile in P. Marais, *ibid.*, p. 296.

<sup>8</sup> Reproduced in G. Fleming, *Hitler und die Endlösung*, Limes, Wiesbaden 1982, pictorial section.

Vashem Institute responded to an inquiry by stating that no other photo of a ‘gas van’ is known to exist and that if the author were aware of any other, the Institute would appreciate receiving it.<sup>9</sup>

## 2. Origins of the ‘Gas Van’ Reports

### 2.1. ‘Murder Vans’ in the Soviet Union

Beer advances the following theory:

“The term ‘gas vans’ refers to a special creation of the Third Reich, namely a heavy vehicle on whose chassis an airtight body had been mounted in which people were killed by means of the introduction of exhaust gas.”<sup>10</sup>

This claim is open to dispute. Gas vans, if they even existed, were not a “special creation of the Third Reich”. The Soviet dissident Pjotr Grigorenko speaks of ‘death vans’ in his memoirs. He recounts what a former friend, Vasili Ivanovich Tesslia, had told him. In the late 1930s, this Vasili Ivanovich had been an inmate in the prison of Omsk, and from his cell he observed how a Soviet prison transport, a so-called “Black Raven”, drove into the prison yard. A group of prisoners had to get in and the truck left, to return about a quarter of an hour later.

“The wardens opened the door: black clouds of smoke rushed out, and dead bodies toppled onto the ground one on top of the other.”<sup>11</sup>

The documentary value of this hearsay story may not be very great – even though Nolte rates it as ‘evidence’.<sup>12</sup> The claim itself, however, recently received some astonishing corroboration.<sup>13</sup> In spring 1993, a four-part television series dealing with the Soviet Union was broadcast in the United States. The title was “*Monster: A Portrait of Stalin in Blood*”. In the second part of this series, subtitled “*Stalin’s Secret Police*”, the former KGB officer Alexander Michailov was quoted as saying that gas vans, or trucks, had already been invented before the war, in Moscow, by one Isai Davidovich Berg, and had been used by the KGB. If this statement is true, then the ‘gas vans’ are a Soviet invention, not a German one. This fits in with the fact that the Soviets were the first to ever make any mention of ‘death vans’ or ‘murder vans’.

The first trial in which ‘murder vans’ were an issue took place during the war, on July 14-17, 1943, in Krasnodar, USSR. From July 15 to 19, the newspaper *Pravda* brought a trial report which was later published in English translation as *The Trial*. Eleven Ukrainians had been charged with treason for their activities assisting German troops. Eight of them were sentenced to death, three received twenty years each in a penal camp.

<sup>9</sup> The letters of Yad Vashem are reproduced as facsimiles in P. Marais, *op. cit.* (note 6), pp. 209f. The German magazine *Der Spiegel*, no. 27, March 27, 1967, published a rear view of a completely unsuspecting Red Cross lorry, claiming without proof that this was a “NS-gas vehicle”, cf. P. Marais, *ibid.*, p. 195.

<sup>10</sup> M. Beer, *op. cit.* (note 1), p. 403.

<sup>11</sup> P. Grigorenko, *Erinnerungen*, Bertelsmann, Munich 1981, pp. 275f.; cf. U. Walendy, “Das verbrecherische System”, *Historische Tatsachen* no. 48, Verlag für Volkstum und Zeitgeschichtsforschung, Vlotho 1991, pp. 35f.; this source also contains the complete quotation. Another interesting report about mass killings by means of gas by the Soviets prior to WWII was published by W. Bobrenjow, W. Rjasanzwe, *Das Geheimlabor des KGB*, edition q, Berlin 1993, pp. 43, 171; I owe thanks to Gerd Selbach for the latter information; W. Strauß recently reported (*Staatsbriefe*, 8(9) (1997), p. 19, online: [who.orgD/Staatsbriefe/Strauss8\\_9.html](http://who.orgD/Staatsbriefe/Strauss8_9.html)) about a Russian publication describing among other unbelievable cruelties soviet experimental gas chambers where prisoners of the GULag were killed: Dantschik Baldajewa, *GULag Zeichnungen*, Zweitausendeins, Frankfurt 1993.

<sup>12</sup> E. Nolte, *Streitpunkte*, Propyläen, Berlin 1993, p. 476, note 31.

<sup>13</sup> For the following information I wish to thank Fritz Berg, the American contributor to this volume. I also wish to take this opportunity to thank him for the provision of numerous documents which he tracked down for us or to which he, being American, had easier access than we Germans do.

As usual in those days in the Soviet Union, the accused confirmed everything that they were supposed to – among other things, that the *Sonderkommando* 10a of *Einsatzgruppe* D, led by SS-*Sturmbannführer* Kurt Christmann, had been killing Soviet prisoners with Diesel exhaust in ‘murder vans’ since the fall of 1942.<sup>14</sup> Soviet witnesses confirmed the use of ‘murder vans’ to eliminate the mentally ill (pp. 4ff). The claim at the heart of all the testimony was that the highly toxic Diesel exhaust gas had caused the death of those locked into the vans. Since this claim cannot be true (for the carbon monoxide content and hence the toxic, *i.e.*, nontoxic nature of Diesel exhaust, see the chapter by Fritz Berg, this volume), it is only reasonable to question the credibility of the rest of the witness statements as well.

One month later, on August 14, 1943, the Soviet Embassy in Washington published a paper “*On Crimes Committed by the German-Fascist Occupation Troops in the Stavropol Area*”.<sup>15</sup> The contents are crass anti-German atrocity propaganda. Among other things, the testimony of a German prisoner-of-war named Fenichel is quoted, confirming the evidence of ‘murder vans’ and describing the vehicles. The statement gives no information about Fenichel himself or about the circumstances under which his testimony was given. One can therefore accord these claims no factual value whatsoever. They were, however, presented at the Nuremberg Trials as incontrovertible evidence to prove that “[...] *the mass extermination of people in gas vans was ascertained without reasonable doubt*”.<sup>16</sup> In this instance, the name of the German prisoner-of-war was given as “*E. M. Fenchel*”.

Another trial took place in the Soviet Union, this time at Char’kov, from December 15 to 17, 1943. The accused were three German prisoners-of-war and one Ukrainian laborer who had served as driver with the *Sonderkommando* at Char’kov. All four of them were sentenced to death by hanging, and the sentence was carried out on December 18, 1943. The English trial report appeared in the volume *The People’s Verdict*. In this trial as well, the allegation came up that the German troops had used heavy Diesel vehicles to murder the Soviet population. And again, the accused confirmed all the crimes they were charged with.

In his book *Der Yogi und der Kommissar*, the Russian-Jewish author Arthur Koestler wrote:<sup>17</sup>

*“The method of gross oversimplification in Soviet domestic propaganda resulted in the tradition that an accused in a political trial had to admit his alleged crimes freely and voluntarily, and once this tradition had become established there was no going back. Hence the strange phenomenon in the 1943 Char’kov trial of German war criminals, where the accused German officers were made to behave like characters out of a story by Dostoyevsky. [...] To a foreign observer, the Char’kov Trial (which was filmed, and screened publicly in London) seemed as surreal as the show trials of Moscow, since the accused gave their statements in pompous phraseology they had obviously memorized, and sometimes digressed into the wrong role, that of prosecutor, before returning to their starting point.”*

Regarding the value and the practice of Soviet trials, Adalbert Ruckerl – then Chief Public Prosecutor of the Head Office of the Land [≅State] Administration of Justice at Ludwigsburg – commented, decades later:<sup>18</sup>

---

<sup>14</sup> *The Trial in the Case of the Atrocities Committed by the German Fascist Invaders and their Accomplices in Krasnodar and Krasnodar Territory, July 14 to 17, 1943*, Foreign Languages Publishing House, Moscow 1943, pp. 2f..

<sup>15</sup> *Soviet War Documents, Information Bulletin*, Embassy of the Union of Soviet Socialist Republics, Special Supplement, Washington DC, December 1943, p. 171.

<sup>16</sup> International Military Tribunal, *Trial of the Major War Criminals*, IMT, Nuremberg 1947, (further on as *IMT*), v. VIII, p. 572.

<sup>17</sup> A. Koestler, *Der Yogi und der Kommissar*, Bechtle, Esslingen 1950, pp. 259f.

<sup>18</sup> A. Ruckerl, (ed.), *NS-Verbrechen vor Gericht*, C.F. Müller, Heidelberg Heidelberg 1984, pp. 99f (the first edition of 1979 was titled *Die Strafverfolgung von NS-Verbrechen*).

*“No reliable information exists about the extent of the criminal trials conducted by Soviet courts against Germans. It may be assumed with certainty, however, that the number of convicted is many times greater than that of all the persons convicted by courts of the western occupation powers put together.*

*The first trial already took place during the war, on December 15-18, 1943, in Char’kov. In this show trial, a Captain of the German Army, an SS-Untersturmführer of the SD, a Private First Class of the Secret Field Police of the Army, and a Russian laborer working for the SD as driver, were sentenced to death by hanging, and were hung publicly one day later on Red Square in Char’kov.”*

With respect to the question of how the confessions were elicited in Soviet military trials, Rückerl proceeds to quote a February 26, 1965, report of the Minister of Justice to the President of the German *Bundestag*:

*“‘Confessions’ were extracted by means of starvation and sometimes also with torture, and these confessions became the basis of proceedings before the Soviet military courts [...].”*

That this assessment of Soviet military trials was correct is a well-known fact today, and has been corroborated by testimony given by Russian military officers, and by documents recently discovered in Moscow.<sup>19</sup> After the collapse of the Soviet Union, the Russian law courts consequently began mass rehabilitation of former German soldiers who were convicted for alleged war crimes between 1941 and 1945.<sup>20</sup> Thus it would run counter to any logic, to accept the statements made in the Soviet trials of 1943 as legitimate evidence for the existence of ‘gas vans’.

What might have been the reason why it was so important to the Soviets to blame such crimes on the Germans in 1943? In early 1943, German troops had discovered the mass graves in the forest of Katyn and had arranged for an international investigation, which clearly showed the Soviets to be the guilty party. A report about this was published in the summer of 1943,<sup>21</sup> but it was not made available to the public abroad. The Soviets, who had no way of knowing what the international reaction to their massacre of Polish officers would be, wanted to have an ace up their sleeve, ‘just in case’, in order to be in a position to counter-charge the Germans with atrocities of their own. And so the ‘gas vans’, which may perhaps actually have existed in the service of the NKVD, were imputed to the Germans and, to make the allegation seem more credible, were equipped with Diesel engines, a typical German feature. The inventors of this legend clearly did not realize that their crowning touch in fact defused their weapon, since the mere introduction of the exhaust gases generated by a Diesel engine has no lethal effect on the passengers. (See the chapter by Fritz Berg.)

## 2.2. ‘Gas Vans’ in the Nuremberg Trials

### 2.2.1. Soviet-Russian Accusations

In the course of the Nuremberg Trials, the public heard its first mention of ‘gas vans’ – albeit not of the Soviet vans but of the alleged German ones. The Soviets brought their charges (already known) against the German troops, and Chief Prosecutor R. A. Rudenko argued:<sup>22</sup>

*“[...] the mass extermination of people in gas vans was ascertained without reasonable doubt for the first time in the report of the Extraordinary State Commission on atrocities of the German occupiers in the Stavropol region.”*

<sup>19</sup> A.E. Epifanow, Hein Mayer, *Die Tragödie der deutschen Kriegsgefangenen in Stalingrad von 1942 bis 1956 nach russischen Archivunterlagen*, Biblio, Osnabrück 1996, pp. 71-77, 105-129; cf. “*Freisprüche für die Wehrmacht*”, *Focus* 49/1996, p. 25.

<sup>20</sup> *Ibid.*, p. 105.

<sup>21</sup> *Amtliches Material zum Massenmord von Katyn*, Comp. a<sup>nd</sup> ed. from documentary evidence, on commission by the Foreign Office, Eher Nachf., Berlin 1943.

<sup>22</sup> *IMT*, v. VII, p. 572.

He then quoted the alleged testimony of the “*prisoner-of-war E. M. Fenchel*”. Why him? Why not the statements made during the trials of Krasnodar and Char’kov? Could it be because, due to the published trial reports and the film records, these could have been critically evaluated, whereas the “*prisoner-of-war E. M. Fenchel*” conveniently offered no footholds for verification? Whatever the case may be – repetition of the charge does not make it more credible.

In the collection of materials that were published from the Nuremberg Trial, the trial transcript itself has been published in its entirety, but of the documents that go with it, only a selection has been released. It is reasonable to assume that many of the documents would not have stood up to critical examination by later historians. At any rate, this is the impression one gets when one finds, time and time again, that documents especially in need of examination are conspicuously absent from the collection of materials. Not even the archives in charge (Koblenz Federal Archives, Nuremberg City Archives, National Archives in Washington) can help in such cases. Evidently, anything that was not published in the IMT volumes has disappeared, or in any case is not accessible to the public. All the Russian papers which the Soviets submitted in Nuremberg as evidence for their ‘gas van’ claims also number among these ‘vanished’ documents. The IMT volumes contain no documentary evidence whatsoever for these Soviet allegations.

### 2.2.2. American Evidence

The Americans presented written evidence. The first is Document PS-501, a collection of papers – one letter and several notes or telexes – of which the letter only was later used as “*evidence for gas vans*”.<sup>23</sup>

Second, they submitted an ‘affidavit’ in which the recipient of the letter from Document PS-501 confirmed, on October 19, 1945, that he had received this letter three years previously.<sup>24</sup>

Third, they presented an ‘affidavit’ by Otto Ohlendorf, dated November 5, 1945, in which Ohlendorf wrote about the use of the ‘Death Vans’.<sup>25</sup>

And, fourth, there is an ‘affidavit’ by Hans Marsalek, dated April 8, 1946, about the May 22, 1945, testimony of Franz Ziereis, Commandant of the concentration camp Mauthausen.<sup>26</sup> In this ‘affidavit’, Marsalek ‘confirms’ that a “*specialty constructed vehicle*” ran between the concentration camps Mauthausen and Gusen, “*in which inmates were gassed to death during the trip.*” (p. 281) From a more recent publication by Hans Marsalek, one can conclude that this ‘affidavit’ was false. In the second edition of his book *Geschichte des Konzentrationslagers Mauthausen* he silently corrects his earlier statements. Regarding the death of Ziereis he writes:<sup>27</sup>

“*On May 23, 1945, Ziereis was apprehended in his hunting cabin on the Phyrn (upper Austria) by American soldiers, and was injured by two bullets when he attempted to flee. As a result of these injuries Ziereis died on May 25, 1945, in the 131st American Evacuation Hospital, Gusen.*”

He no longer knows anything of his (Marsalek’s) interrogation of Ziereis, which according to his ‘affidavit’ had taken place during the night of May 22-23, in other words, even before Ziereis was discovered by American soldiers. His statement in the preface to the second edition of his book may be considered a tacit correction of his affidavit of April 8, 1946:

“*Further, all statements that cannot be documented [...] have been deleted.*”

---

<sup>23</sup> *IMT*, v. XXVI, pp. 102-110.

<sup>24</sup> PS-2348, *IMT*, v. XXX, pp. 256-258.

<sup>25</sup> *IMT*, v. XXXI, pp. 39-41.

<sup>26</sup> PS-3870, *IMT*, v. XXXIII, pp. 279-286.

<sup>27</sup> H. Marsalek, *Die Geschichte des Konzentrationslagers Mauthausen*, Österreichische Lagergemeinschaft Mauthausen, Vienna 1980, p. 200, note 15.

This is an example of the audacity and unscrupulousness with which confessions of guilt were fabricated.

Regarding the problem of the evidence submitted in the Nuremberg Trial, we wish to remind the reader: in the course of this trial, the accused, the defense counsels and the witnesses found themselves faced with thousands of documents, on which they had to comment immediately. There were only a few cases where the persons in question refused to be intimidated by the Court. The trial judge constantly urged them to answer immediately, ‘yes or no’. The result was that many defendants and witnesses gave up and simply answered in whichever way was easiest, and that, as a rule, was to confirm the correctness of the document shown to them. They generally did not even get to see the evidence.<sup>28</sup>

The situation was not much different for the witnesses, who were interrogated even before the trial began. Without being expressly told each time, they knew very well that their only choice was between acting as a witness for the prosecution, or as defendant in their own right in a subsequent trial. For those witnesses who were likely to break down under cross-examination by the defense – and this category included most of them – the Allies invented the ‘affidavit’.

An affidavit was the result of an interrogation; it was drawn up by the interrogating officers and given to the witnesses to sign. It perforce contained only half the truth, since – as one defense counsel stressed:<sup>29</sup>

*“An affidavit [...] repeats only what was written down as answer. However, it is the unanswered questions in particular which very often allow for the necessary conclusions regarding the usability of a witness statement.”*

At this point we would add that witness statements which did not serve the purpose of the prosecution were not even included in the affidavit. The trial judge to whom the defense counsels had repeatedly pointed out the questionable nature of the affidavits explained succinctly that:<sup>30</sup>

*“The Tribunal is not bound by technical rules of evidence, but shall adopt and apply to the greatest possible extent expeditious and non-technical procedure, and shall admit any evidence which it deems to have probative value.”*

By now these facts are all well known. Therefore it can only be described as amateurish when historians still ascribe probative value to IMT documents whose content cannot be confirmed through other sources.

### 2.3. ‘Gas Vans’ in National Socialist Trials

While there is only little documentary evidence for the existence of ‘gas vans’, we do have numerous statements by defendants and by witnesses in NS trials, confirming that the ‘gas vans’ had indeed existed and that people were killed in them. Especially in the 1960s and 1970s trials took place which dealt with the use of ‘gas vans’, among other things. In the literature on this subject, therefore, arguments are based primarily on this testimony.

In Section 4 we shall take a closer look at the content of these witness statements, but first of all, let us consider the value which such testimony *per se* has as evidence.

The fundamental problem of testimony before a court and its relation to objective truth is nothing new. We have already quoted M. Beer in this respect. He is not alone in doubting that historical

<sup>28</sup> W. Maser, *Nürnberg, Tribunal der Sieger*, Droemer Knauer, Munich 1979, chapter “*Das Beweismaterial*”, pp. 106ff.

<sup>29</sup> *IMT*, v. II, p. 389 (German edition).

<sup>30</sup> *IMT*, v. II, p. 288 (German edition). Cf. Charter of the International Military Tribunal, Article 19.

truth is to be found in court transcripts. The question has repeatedly come up, at least since the Nuremberg trial: can historical insights be gained from court cases? Wilhelm Raimund Beyer writes:<sup>31</sup>

*“The ‘truth’ ascertained by the court must not be equated with historical truth. During the Nuremberg Trial of the major war criminals (IMT) and the following trials, and especially in connection with the Justice Case, heated discussions during conversations with defense counsels and especially with press reporters yielded the following maxim: trial truth is not historical truth. [...] An accused person will hardly wish to describe the actual, so-called objective events of the case at issue, even if he were in a position to do so.”*

The same, of course, also goes for the statements of witnesses, even if they were made under oath. In this context, Professor Dr. Martin Broszat, former Director of the Institute for Contemporary History in Munich, spoke of

*“[...] incorrect or exaggerating [...] statements of former inmates or witnesses.”*<sup>32</sup>

The American Holocaust expert Lucy Dawidowicz corroborates this.<sup>33</sup>

*“Many thousands of oral histories by survivors recounting their experiences exist in libraries and archives around the world. Their quality and usefulness vary significantly according to the informant’s memory, grasp of events, insights, and of course accuracy. [...] The transcribed testimonies I have examined have been full of errors in dates, names of participants, and places, **and there are evident misunderstandings of events themselves.**”(emphasis added.)*

One need not necessarily assume that the witnesses lied intentionally, or deliberately distorted facts. But what degree of objectivity can one expect where the matters in question are already years in the past and the events testified to took place in situations marked by distress and fear? Is it even reasonable to expect objective, truthful statements in such cases?

By its very nature, eyewitness testimony is based on subjective impressions. In addition to this, it often centers on unverified rumors. In many cases gaps in personal recollections were patched up later through accounts given by third persons or by the media (newspapers, books, radio and television), accounts that the witnesses accepted credulously without examining them critically for their truth.

The credibility of eyewitness testimony is a common and well-known problem in the justice system and does not apply only to National Socialist trials.

The observation we have already made at the start of this study thus holds true: eyewitness testimony and court verdicts must be analyzed and can be credited with probative value only if other evidence confirms their objective correctness.

### 3. Critical Assessment of Important Documents

#### 3.1. Nuremberg Document PS-501

The most important piece of evidence from Document File PS-501 is a letter dated May 16, 1942, from SS-*Untersturmführer* Dr. August Becker to SS-*Obersturmbannführer* Walther Rauff. Dr. Becker was an accredited chemist with the Forensic Institute of the RSHA [the Reich Security Main Office] in Berlin; Walther Rauff was Chief of Department II D in the RSHA.

The letter reads as follows [transcript of official Nuremberg translation]:

---

<sup>31</sup> W.R. Beyer (ed.), *Rückkehr unerwünscht*, dtv, Munich 1980, p. 180.

<sup>32</sup> M. Broszat, “Zur Kritik der Publizistik des antisemitischen Rechtsextremismus”, *Aus Politik und Zeitgeschichte*, B19 (1976), p. 5.

<sup>33</sup> L. Dawidowicz, *The Holocaust and the Historians*, Harvard UP, Cambridge, Mass., 1981, pp. 176-177.

*“Feldpostnummer 32704*

*B. Nr 40/42 SECRET*

*To  
SS Obersturmbannfuehrer R a u f f  
Prinz Albrecht Str. 8  
Berlin*

*The taking over of vehicles by Groups D and C<sup>34</sup> is finished. While the vans of the first group can be utilized in not too bad weather, the cars belonging to the second group (SAURER) are absolutely immobilized in rainy weather. For instance, often it has rained for half an hour, these vehicles cannot be used because of skidding. They can only be used in absolutely dry weather. The only question is whether these vehicles can be put into action only on the execution spot.*

*First, a vehicle must be brought to this place, what is only possible in good weather. The execution spot is generally stationed 10 to 15 kms from main roads and due to such location already of difficult access, but in wet weather absolutely impossible to reach. If those to be executed are driven or conducted to this place, they notice at once what is wrong and become frantic, which is most of all to be avoided. There is only one solution: to gather them on the same spot and then to drive off.*

*As for the vehicles of Group D, I had them camouflaged as cabin trailers by putting on them little windows, one on every side of the small vans and two on every side of the big ones, like windows which are seen on peasant houses. But the vehicles were so well known that not only the authorities, but also the civilian population, called them ‘Death Vans’. My opinion is that we shall not be able to keep this camouflage secret a very long time.*

*On the way up from Simferopol to Taganrog, I had brake troubles with the vehicle Saurer, which I was conveying over there. At the S.K. in Mariupol, it was found out that the brake sleeve [“Manchette”] of the combined Oil and Westinghouse brakes, was broken in several places. Through persuasion and bribery I obtained from the H.K.P. (Army Motor Pool) to have a pattern made, after which two brake sleeves have been cast. When I arrived some days later at Stalino and Gorlowka, the drivers of the vehicles there complained of the same trouble. After an interview with the commanding officer of the Commando, I returned to Mariupol to have another brake sleeve made for these vehicles. It has been agreed that two brake sleeves will be cast for these vans; six brake sleeves will stay in reserve in Mariupol for Group D; and six will be sent to SS Untersturmfuehrer E R N S T in Kiev for the vehicles of Group C. With regard to Groups B and A, the brake sleeves could be obtained through Berlin, as the transportation from Mariupol to the north seems to[o] hazardous and would take too long. Small repairs of vehicles will be handled by Commando technicians; that is to say, repairs will be made in their own workshops.*

---

<sup>34</sup> Mistranslation in Nuremberg translation; the original German document reads “*Die Überholung der Wagen bei der Gruppe D und C [...]*”, which means ‘the overhaul of the vehicles with [*i.e.*, at the location of] Groups D and C...’, not “*the taking over of the vehicles by Groups D and C [...]*”. This is only the first of numerous mistranslations and grammatical and spelling errors which riddle this Nuremberg translation; all peculiarities have been retained in this transcript. -trans.



*Due to the uneven terrain of the region and the very bad state of the roads, the joints and rivets become loose within a short time. I was asked if, in such cases, the vehicles must be taken to Berlin. Transportation to Berlin would be too expensive and would require too much gasoline. To save such expenses, I gave the order to solder the small leaky spots, and when this could not be done any more to inform Berlin at once: by radio that the vehicle Pol.Nº... was out of working order.*

*Furthermore, I ordered, during the gassing, to keep all the men as far away as possible, in order that they could not eventually be injured by gas fumes. On this occasion I wish to draw your attention to the fact that after the gassing several Kommandos let their own men unload the van. I have drawn the attention of the Commanding officers of the concerned S.K. to the atrocious spiritual and physical effect that this kind of work may have on the men, if not just now then in the future. The men complained to me that they got headaches after every van-unloading. Anyhow, this order is not observed, as it is feared that the prisoners chosen for this work will use the opportunity to try an escape. In order to prevent the men from being injured, I should be obliged if orders were given accordingly.*

*The gassing is not done in the right manner. In order to get over the work as quickly as possible, the driver gives full gas. Through those measures the people to be executed die from suffocation and not as foreseen by being put to sleep. My method has proved that by releasing pressure on the lever at the right time death comes more quickly and the prisoners slip peacefully away. Distorted faces and excretions, which have been previously seen, are not more to be observed.*

*I am leaving in the course of the day for Group B, where you can forward me further information.*

*Sgd: B E C K E R  
SS Untersturmfuehrer”*

This paper is problematic in several respects. First of all, this author was not able, despite numerous inquiries with the archives, to obtain a *copy of the original letter*. For this reason she had to rely on inadequate documents which, as it now turns out, gave her a false impression.

After the present volume had been published in German, a book by Pierre Marais was published.<sup>35</sup> Pages 210-213 show facsimile reprints of Becker’s letter to Rauff; these reprints would appear to have been made from photocopies of the original document.

### 3.1.1. Origin of Document PS-501

The author has in her possession two letters from the National Archives in Washington DC, USA, each of which attests to a different origin of the Nuremberg Prosecution Document PS-501.

An April 26, 1945, memo from the Headquarters of the 12th US Army states that a unit of the 12th Army had found the documents in the “*RSHA reserve depot in Bad Sulza*”. The originals, the memo states, were sent to the document center in Paris.

The docket, which usually accompanied the documents that were presented to the Nuremberg Tribunal, is dated September 7, 1945. This paper states that the place where the document was found, as well as its source, is unknown and that it had been received from the OCC London (the British Prosecution).

---

<sup>35</sup> P. Marais, *op. cit.* (note 6). This book also includes many other facsimiles of important documents.

In view of this it is not impossible that further references to yet another origin for this document may well turn up, whether from Washington, Moscow, or a different archive.

For the moment we can only say that the origin of document PS-501 is unknown and hence dubious. Given this situation, it ought never even to have been admitted as document for the prosecution. According to an affidavit of the Head of the Document Section in the US Chief Prosecutor's Office which was read into evidence at the start of the Nuremberg Trial,<sup>36</sup> all materials which could serve to prosecute Germany's leadership were registered accurately, with information as to the place and circumstances of how and where they had been found. A document without such identification, *i.e.*, with the note "*source and origin unknown*", lacks even slightest evidentiary value. If the defense had submitted an equally dubious paper the Court would have rejected it instantly.

### 3.1.2. External Characteristics of PS-501

#### 3.1.2.1. Rubber Stamps and Handwritten Notations

The letter bears the following markings on the first page:<sup>37</sup>

Two red *rubber stamps*:

1. "*Geheime Reichssache!*" [Top secret!], top right, below the place and date;
2. Bottom left, at the margin, the Received stamp of the archive, *i.e.*, the registry.

There are also the following *handwritten notes*:

1. Top right, beside the address field, in orange: "*R 29/5 erl. b/R.*"
2. Above that, in red pencil: "*pers. Pradel n.R.*"
3. In the left margin, in indelible pencil: "*Sukkel b. R p16/6.*"

These notes indicate that 'R' processed this on May 29 and initialed it with 'b/R'. The note was written in Latin script.

The meaning of the red entry, 'pers[onal?] Pradel n.R.', is not quite as clear. This note was also written in Latin script. Whether it is the same handwriting as that of the orange entry is not certain.

The note at the left margin, "*Sukkel b.R.*", is initialed "*p* [or "*P*"] *16.6.*" It was written in German cursive (Sütterlin) script. Is it supposed to mean that "*P*" confirmed on June 16 that Sukkel had come to see [*i.e.*, was "*b*"(ei?)] "*R*"?

None of the three notes are clear and unambiguous, because even for the first note it is not known what "*b/R*" is supposed to mean.

One may assume that the initials 'R' and 'P' are supposed to stand for 'Rauff' and 'Pradel', respectively. The RSHA also had a staff member by the name of 'Suckel', but his name was spelled with a 'ck', not with a 'kk' as shown on the document.

Rauff, however, consistently wrote German texts in German cursive (Sütterlin) script, not in Latin script. His initial 'R' had a characteristic appearance<sup>38</sup> which was not identical to that of the 'R' on the letter. He cannot have written these notes. What is more, all the handwritten entries are apparently 'adapted' from genuine notes written by Rauff and Pradel, as we shall see in a later chapter, so that it seems reasonable to suspect a deliberate forgery here.<sup>39</sup>

<sup>36</sup> PS-001a, *IMT*, v. XXV, pp. 2-7.

<sup>37</sup> The following information about the color of the stamps and the various color pencils are excerpted from the description of the original document as related in International *IMT*, v. XXVI, p. 102.

<sup>38</sup> See Rauff's confirmation on PS-2348; cf. P. Marais, *op. cit.*(note 6), pp. 211, and his many confirming initials on the corresponding affidavit, or the other correspondence of RS 58/871; cf. P. Marais, *op. cit.* (note 6), pp. 134, 140, 151.

<sup>39</sup> For example, cf. back page of letter from Gaubschat to the RSHA, May 14, 1942 (R 58/871, fol. 13).

### 3.1.2.2. Three Different Copies But No Original

By now the author has in her possession three different ‘copies’ of the letter from Becker to Rauff, but a copy of the original letter is still not to be had. Evidently no such ‘original copy’ exists.

The three ‘copies’ differ as follows:

#### Specimen A:<sup>40</sup>

Photocopy of a photo negative (black paper, white text). Three pages. On the upper edge (but clearly visible only on pages 1 and 2) there are two holes made by a hole puncher, obviously for filing – but they are at a location that is unusual for filing holes in German office practice, and they are also an unusual distance apart. On the copy in my possession, only page 3 is numbered at the top: – 3 –

Each page has an archival number stamped at the bottom: A092586-88.

In the left margin of page 1, diagonally: “*Diesen Brief habe ich im Mai 1942 empfangen. 18. October 1945. Rauff*“ [I received this letter in May 1942. October 18, 1945. Rauff]

The first line of text is missing at the top of page 2.

According to a memo in the IMT volumes (XXX, p. 258) this is a *photocopy of the original letter* from Becker to Rauff, which had been given to Rauff in Ancona, Italy on October 18, 1945, to authenticate.

#### Specimen B1:<sup>41</sup>

Photocopy of the carbon copy of what was probably the original letter. Three pages. The consistency of the paper is clearly apparent and permits the definite conclusion that it was not a solid piece of paper such as is usually used for original letters and photocopies, but rather a piece of thin carbon copy paper (photocopy machines can’t process thin carbon copy paper).

On the left edge there are two holes made by a hole puncher, for filing in a binder. They are located at the place where Specimen A shows Rauff’s confirmation of receipt. The left margin is torn, or creased, and the punching is reinforced. On the *photograph* (Specimen B2) the reinforcement strip is clearly visible through the thin paper.

Along the upper edge there is a handwritten note: “*Copy of [...]*” (the rest is illegible).

At the bottom are archival numbers: p. 1: A090025; p. 2: A090027; p. 3: A090028. Strangely enough, A090026 is missing – in other words, pages 2f. of the document were numbered incorrectly. This is all the more strange because these numbering machines advance automatically after each depression. Therefore, a different document must have been given the number A090026.

#### Specimen B2:<sup>42</sup>

Photograph of page 1 of Specimen B1. The consistency of the paper (thin copy paper) is even more clearly apparent here.

#### Specimen C:<sup>43</sup>

A copy written for the IMT, peppered with spelling and typing mistakes – obviously written by an English-speaking person. To this day the staff at the American National Archives in Washington claim that this is a “*copy of the original*”. This copy bears handwritten notes which are very similar to those on specimen A, B1 and B2. Apparently the person who rewrote this letter tried to imitate these notes as well. A closer comparison of these notes reveals that there is a small difference between these documents: Whereas document A bears not angle shaped paragraph marks, document B

---

<sup>40</sup> National Archives, rec. no. 238; PS-2348; cf. P. Marais, *op. cit.* (note 6), pp. 211-213.

<sup>41</sup> National Archives, rec. no. 238; PS-501.

<sup>42</sup> As showed in a showcase of the National Archive in Washington; cf. P. Marais, *op. cit.* (note 6), p. 210.

<sup>43</sup> National Archives, Washington, PS-501; cf. P. Marais, *op. cit.* (note 6), pp. 208f.

and C have two ‘|\_’-shaped marks at the start of the first and at the end of the second paragraph, but only document B has three ‘>’-shaped paragraph mark (end of paragraph 1, and start and end of paragraph 2). Since the writer of document C tried to match the document he was copying as good as possible – especially the handwritten notes and marks –, this proves that the document he was copying showed only the ‘|\_’-shaped marks, *i.e.*, that he must have copied a different document than document A or B.

### 3.1.2.3. Congruencies Between Specimens A and B

Astonishingly enough, the stamps as well as the handwritten comments on A and B match – precisely at the same places of the paper, except for the above mentioned paragraph marks which probably were added later.

As already mentioned, A is allegedly a photocopy of the original letter. In this sense it is only to be expected that the copy corresponds precisely to the original, on which these notes were written. It is odd, however, in the case of Specimen B, which was described as ‘copy’ and is clearly a carbon copy of the original letter. It is odd in the sense that the notes give the impression that they were added by the recipient, whereas carbon copies of letters are usually retained by the sender. Moreover, even if the copy should actually be in the recipient’s possession, such notes would be written on only one of the two specimens, not on both. And what is entirely impossible is that these notes, which must have been written by at least two different persons on two separate days (May 29 and June 16), could be on the exact same place on both papers, identical to the millimeter.

It is also very unusual that the carbon copy bears the same signature as the original letter. It used to be customary in German offices to sign copies with one’s initials at the most, and usually not at all, since after all these copies were only intended for the files.

The congruence of the handwritten notes on the photocopy of the original letter and on the carbon copy suggests that these notes were added photo-mechanically or in some other way. If this is correct, it would be another proof of forgery.

### 3.1.3. Content of Document PS-501

It is almost superfluous to comment on the contents of the letter, which are extremely strange and quite hard for common sense to accept. We shall mention only a few points.

First at issue are heavy vehicles from the firm of ‘Saurer’ which can allegedly drive only under ideal weather conditions and on absolutely dry ground. It is both surprising and hard to believe that the Army Motor Pool would send vehicles to the Russian front if they were not at all suitable for the road conditions there. Moreover, even the lighter vehicles from ‘Saurer’ generally had dual wheels in the rear, and the heavier ones were two-axled. Thus one might assume that they could have handled even poor road conditions.

The writer complains that the “*brake sleeves* [“*Manchette*”] *of the combined Oil and Westinghouse brakes was broken in several places.*” According to an information provided by the company Steyr-Daimler-Puch, successor of Saurer Company, the mentioned brake sleeves were rubber-made cup packings of the vacuum power-steering device which broke frequently. The described pattern was not used to cast the sleeves but to vulcanize them.<sup>44</sup> Consequently, Becker would not have been able to produce his own sleeves, since casting air tight, vacuum proof rubber sleeves in patterns behind the Russian front is nearly impossible, but had to order them in an unvulcanized form from the manufacturer in order to vulcanize them in his self-made patterns (if this was possible at all, has not

---

<sup>44</sup> Letter from Steyr-Daimler-Puch Aktiengesellschaft to P. Marais, January 1, 1987, facsimile in P. Marais, *op. cit.* (note 6), p. 310.

yet been checked). Thus, the statement of Becker that “[w]ith regard to Groups B and A, the brake sleeves could be obtained through Berlin” doesn’t make sense, since he had to order them from Berlin or elsewhere in the Reich as well.

Additionally Becker remedied this problem by resorting to ‘bribery’. Even though everyone knows that there are occasionally things that can be obtained only by ignoring regulations, *i.e.*, illegally, and that certain compensation is involved in such transactions, one will certainly not call this ‘bribery’. And most of all, no minor SS-*Untersturmführer* would literally brag about such activities to a higher-ranking officer and his superior.

What the writer claims with regard to the problems encountered during ‘gassing’ must be read in conjunction with Friedrich Berg’s chapter in this volume. For as long as there is no proof that the RSHA’s Saurer vehicles were *not* equipped with Diesel engines, as was normally the case, the gassing tales cannot be given any credence. But apart from this, Beckers description of the alleged influence of the lever position on the *way* the victims die is utter nonsense. Only the dying process can be accelerated by giving full gas, but not the way people die.

### 3.1.4. Summary

We have found that the origin of the letter from Becker to Rauff which was submitted to the Nuremberg Tribunal as Prosecution Document PS-501 is uncertain, and hence dubious.

The handwritten notes on the first page of the letter appear to be nonsensical and certainly were not written by the persons (Rauff and Pradel) whom the initials ‘R’ and ‘P’ are supposed to suggest. This would indicate a forgery.

The carbon copy bears the same notes at precisely the same places as the original letter. This is not only unusual, but also an impossible feat of handwriting. At least on the carbon copy, the notes can only have been added photo-mechanically. This too would indicate a forgery.

The contents of the letter are not credible, especially in their nature as letter from a subordinate to his superior.

All in all, these points are cause for grave doubts as to the authenticity of the document.

## 3.2. Affidavits

Regarding the general problem posed by the Nuremberg affidavits, see Section 2.2.2.

### 3.2.1. Nuremberg Document PS-2348, the Affidavit Rauff

When the German front in Italy collapsed, Walther Rauff was taken into American captivity, and was held in Ascona where, on October 18, 1945, he was presented with a photocopy of a letter which Becker had allegedly sent him on May 16, 1942. He was told to confirm its authenticity. Rauff wrote the requested statement diagonally across the left margin of the letter.

The next day, October 19, 1945, he also swore an affidavit in which he again affirmed that the letter was genuine.<sup>45</sup> The affidavit was recorded in the manner already described: the American interrogator asked questions and wrote down the answers. The interrogation was conducted in English, and the answers were also given in English since Rauff was familiar with that language. Consequently the documentary volumes of the Nuremberg Trial contain only the original English version.

The affidavit contains numerous factual errors. While Rauff did make some corrections, he let other mistakes stand, for example the spelling ‘Pradl’ instead of ‘Pradel’ and the assumption that the ‘Saurer Works’ were located in Berlin, whereas they were actually in Vienna. Very obviously he

---

<sup>45</sup> PS-2348, *IMT*, v. XXX, pp. 256-258.

provided the affidavit under pressure. Possibly he meant the errors contained in it to hint at his condition.

He did, however, take care to stress that he had no particular connection with the ‘death vans’ and their operation – the usual conduct of all accused who knew that it would have been hopeless to dispute the basic charge (‘genocide’, ‘mass murder’) as a whole and could only speak for themselves.

The affidavit states, “*In so far as I can state these vans were probably operating in 1941.*” According to Kogon,<sup>46</sup> the plan to construct such ‘gas vans’ was not formulated until autumn 1941, and construction did not begin until 1942. Rauff’s statement thus contradicts this theory.

Further, Rauff claimed that he had referred Becker’s letter to Pradel and that he believed he had instructed Pradel “*to have the technical matters complained of in the letter remedied.*” However, the Becker letter makes no mention of any technical matters that needed to be remedied. Becker did not request any technical measures to be taken; on the contrary, he had everything admirably under control. He had already changed what needed changing, and *that* was not even a technical defect, but rather the “*incorrect*” use of the accelerator pedal – whatever that may mean. (Regarding the absurdity of the claim that the CO content of Diesel exhaust could be regulated by the adjustment of control levers, cf. the chapter by Friedrich Berg, this volume.)

Moreover, Rauff says:

*“I was chief of this technical section [at the RSHA, Group II D] from February 1940 to March 1940. From May 1940 to May 1941 I was in the German Navy. September 41 to May 1942 I was in Prague. I then became chief of the section again from May 1942 to June 1942.”*

In other words, during his entire time of service at the RSHA he was chief of the technical section twice, each time for only one or two months: from February to March 1940 and from May to June 1942. Therefore he cannot possibly have played the role attributed to him in supplying the ‘gas vans’. According to the literature supporting the Holocaust, Rauff had worked to supply the ‘gas vans’ as of autumn 1941, in other words at a time when he was not even in Berlin.<sup>47</sup>

Regarding the personnel structure of the RSHA, Rauff claims:

*“I wish to state that my immediate superior was an individual of ministerial grade by the name of Standarten Führer Siegert. He was chief of Amt II RSHA [...] The immediate superior of Stnd Führer Siegert was Obergruppen Führer Reinhardt Heydrich chief of S.D.”*

These claims as well are not in accord with the facts. Like Rauff, Siegert was a *Gruppenführer* in the RSHA and, as such, Rauff’s colleague. As is well known, the chief of the RSHA was Heydrich.

The Americans obviously tried to confirm the authenticity of the letter, because as we have already seen, the document was identified as “*source and origin unknown*”. Rauff simply authenticated what he had been given to authenticate. In any case he did not take care to bring the affidavit into accord with the facts. Shortly afterwards he emigrated to Chile, where he remained until his death on May 14, 1984.

<sup>46</sup> E. Kogon, H. Langbein, A. Rückerl (eds.), *NS-Massentötungen mit Giftgas*, Fischer, Frankfurt/Main 1983, p. 82.

<sup>47</sup> Cf. the detailed account in E. Kogon *et al.*, *ibid.*, pp. 82f., which completely disregards the facts claimed by Rauff. His personnel file (copies in the author’s possession) shows that his initial profession was “*marine officer*”. He left the navy in late 1937 for personal reasons and transferred to the RSHA. In May 1940, however, he returned to the navy and left it one year later as lieutenant commander. From autumn 1941 to May 1942 he was stationed in Prague, just as he claims. As of June 1942 he was on SD duty in north Africa, and later in Italy, at least until May 1944, when the Italian front collapsed. Thus, it is not clear how he could have been involved in design and construction of these vans, the purpose of which is still hidden to us.

The numerous, demonstrable inaccuracies in this affidavit render it devoid of any probative value. This in turn makes Rauff's confirmation of the authenticity of Document PS-501, which is the purpose of the affidavit, no less dubious than the content of that document itself.

### 3.2.2. Nuremberg Document PS-2620, the Affidavit Ohlendorf

The second affidavit which the American prosecution presented in Nuremberg was that of Otto Ohlendorf, Chief of the SD and leader of *Einsatzgruppe D*. This affidavit as well had obviously been recorded by one of the American interrogators and given to Ohlendorf to sign. In it he confirmed that his *Einsatzgruppe* had been sent 'death vans' from Berlin and that women and children were killed in them by 'turning on' the gas. The affidavit was dated November 5, 1945.<sup>48</sup>

On being questioned as witness during the trial he stated that as of spring 1942 his *Einsatzgruppe* had been assigned a Special Unit led by Dr. Becker, which used 'gas vans' to kill Jewish women and children and Soviet political commissars. Death took ten to fifteen minutes, he said. He claimed not to know any technical details regarding these 'gas vans'.<sup>49</sup>

Ohlendorf was also shown the letter from Becker to Rauff (PS-501) and he supposed it might be "correct" since it "approximated his [Ohlendorf's] experiences."

Two things contradict this account.

1. In the letter the writer (Becker) gives the impression that he was on an inspection tour to the various *Einsatzgruppen*, specifically from the south (Group D) moving northwards (on his way to Group B). But this activity does not agree with that specified by Ohlendorf, according to whom Becker was the Chief of a Special Unit which had been assigned specifically to *Einsatzgruppe D*.
2. In the letter the writer specifically mentions vehicles of the Saurer type, which were equipped exclusively with Diesel engines and for this reason were not suitable for exhaust-gas murders. However, the writer does not find any fault with this – he only criticizes that they were "absolutely immobilized in rainy weather". How such vehicles, which were as unsuitable as could be for killing human beings, could nevertheless be used to murder Jewish women and children, remains a mystery.

Ohlendorf's affidavit and witness testimony contradict the facts in several decisive respects and cannot in any way be considered evidence for actions which are technically impossible.

### 3.3. The Koblenz Document R 58/871

Similar to the Nuremberg Document PS-501, the file R 58/871 consists of several papers. There are eight documents altogether, which we have grouped into three categories for the sake of clarity:

1. Letter from the RSHA to the Forensic Institute, Berlin, dated March 26, 1942, (R 58/871 fol. 7);
2. Correspondence between the RSHA and the firm of *Gaubschat Fahrzeugwerke GmbH*, Berlin, of April 27, 1942, to September 24, 1942, including Notes and Memos (R 58/871 fol. 4-6, 8-14);
3. Memo of the RSHA (re.: technical modifications) of June 5, 1942 (R 58/871 fol. 1-3).

The letter mentioned in point 1. stands on its own and does not require consideration in our current context.

The correspondence between the RSHA and the firm of Gaubschat, grouped under 2., includes six letters and deals with vehicles whose chassis the firm of Saurer, Vienna, supplied to Gaubschat, Berlin, and which Gaubschat was to equip with a body for the RSHA.

The Memo identified in 3. is considered evidence for the existence of 'gas vans'.

---

<sup>48</sup> PS-2620, with notes, *IMT*, v. XXXI, p. 41.

<sup>49</sup> *IMT*, v. IV, pp. 311-355. esp. pp. 322ff., 331f.

### 3.3.1. Correspondence Between the RSHA and Gaubschat

The following course of events can be reconstructed from the RSHA-Gaubschat correspondence detailed under 2.:

In April 1942, the RSHA considered having ‘special vehicles’, which are not described in any greater detail, equipped with a quick-unloading mechanism. The chassis for these vehicles was supplied by the firm of Saurer, Vienna, to the firm of Gaubschat, where the vehicle body was added. As a rule, the heavy goods vehicles built by Saurer had Diesel engines. The correspondence makes no mention of a possible special model with gasoline engines, so that one must assume that these ‘special vehicles’ also had Diesel engines.

Various consultations took place between the members of the RSHA and the firm of Gaubschat regarding specifics of the quick-unloading mechanism and other construction requests. The results of these consultations were recorded in a letter sent by the RSHA to Gaubschat on June 23, 1942. Specifically, the following work was commissioned:

1. shortening the cube body by 80 cm (31.5");
2. extension of the front and rear wheel casings, so that a continuous base is created for the grating on both interior side walls;
3. shortening the individual gratings to 70 cm (27.5");
4. casing of the door posts, with resultant narrowing of the box interior at the door;
5. open slits in the back wall above the door, instead of the door openings that had been there previously;
6. modification of a drain opening in the floor;
7. reinforced interior light guards.

Gaubschat confirmed the order with two further letters of September 18 and 24, 1942.

This correspondence, running from April 27 to September 24, 1942, forms a logical sequence. All letters from the RSHA bear the same reference number: II D 3 a (9) Nr. 668/42-121. The RSHA letters are written on plain white paper without a printed letterhead, and without any special markings, for example pertaining to secrecy or classification. In each case the text is written on the front and back of a sheet, but only the sheets were paginated, not the pages. Gaubschat used their letterhead paper.

### 3.3.2. RSHA ‘Note’ of June 5, 1942

This correspondence, which is really of no interest in and of itself, provides the background for the RSHA ‘Note’ of June 5, 1942, which we have listed under point 3 of the contents of file R 58/871. This ‘Note’ is the second document (next to Nuremberg Document PS-501) which is cited as proof of the ‘gas vans’ theory. There are no further Third Reich documents on this matter.

The vehicles at issue in the correspondence between the RSHA and Gaubschat are those allegedly used as ‘gas vans’. However, this interpretation does not follow from the correspondence mentioned. On the contrary, said correspondence shows that whatever the load to be transported by these special vehicles may have been, it was not human beings. We shall return to this point later. The fact that Saurer vehicles always had Diesel engines also contradicts the claim that they were used as ‘gas vans’.

The ‘Note’, however, clearly and unequivocally speaks of ‘gassing’, and for this reason this document has been used to this day as uncontested evidence in support of the ‘gas vans’ theory.



## 3.3.2.1. Discrepancies in External Form

The ‘Note’ gives the impression that it is part of the sequence of correspondence between the RSHA and Gaubschat. It is dated June 5, 1942, *i.e.*, prior to the RSHA letter of June 23 which itemizes the construction modifications.

However, there are some notable discrepancies:

1. The reference number on the ‘Note’ is II D 3 a (9) Nr. 214/42 g.Rs. – but that on the other letters was II D 3 a (9) Nr. 668/42-121.
2. The ‘Note’ is rubber-stamped “*Geheime Reichssache*” (Top Secret). None of the other documents were classified as secret.
3. Beneath the date is the remark: “*Einzigste Ausfertigung*” (intended to mean ‘only’ or ‘sole specimen’). It is important to note that the superlative form *einzigste* does not exist in the German language (even though it is, by mistake, more and more used in modern German); ‘*einzig*’ remains ‘*einzig*’ and cannot be rendered comparative or superlative.
4. Interestingly enough, however, this letter, which is allegedly the only, sole specimen in existence, actually exists in at least three different ‘original’ forms, which differ from each other in text underlining and in handwritten additions: one ‘original’ is in the Koblenz Federal Archives.<sup>50</sup> In this the registration number, the remark “*Einzigste Ausfertigung*” and the word “*eine*” on the last page are underlined. The last page additionally bears vertical marks on the left edge with a signature of “*Ju*” besides it as well as signatures of “*R 10/6*”, “*i.A. Just*” and “*Lu 4/6*”. Furthermore, on top of page one a handwritten note reading “*b – 12 – 14*” is added above the date, perhaps written by an Anglo-Saxon writer, since Germans always write ‘1’ instead of ‘l’ for the digit one.

Another ‘original’ was used by the editors of the book *NS-Massentötungen durch Giftgas* for their facsimile reprint.<sup>51</sup> In this also the date is underlined as well as the first sentence of the letter text itself, the last sentence of page 4/first of page 5 and the Rank and Name of Rauff on the last page. Surprisingly, the vertical marks at the edge of the last page are missing, and the signature of Rauff as well (“*R 10/6*”), to whose attention, according to the letter itself, this document had to be brought.

A third ‘original’ was reprinted in facsimile by Rückerl.<sup>52</sup> Regarding the underlining it is the same as the one from the Bundesarchiv, but here, too, the vertical marks and the signature of Rauff on the last page are missing. Additionally, a different handwritten note on top of page one, written by a different person on a different location, can be found, reading “*b – 2 – 14*”.

This author’s correspondence with the Federal Archives also failed to shed light on the matter, as the archives insist that theirs is the only original in existence. The official in charge at the archives was much amazed when this author pointed out the differences to him.

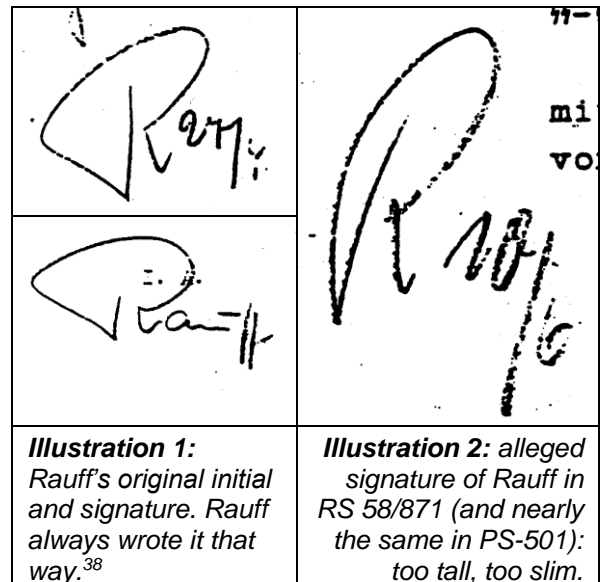

<sup>50</sup> Cf. P. Marais, *op. cit.* (note 6), pp. 156-160.

<sup>51</sup> *Op. cit.* (note 46), pp. 333-337; cf. P. Marais, *op. cit.* (note 6), pp. 232-236.

<sup>52</sup> A. Rückerl (ed.), *NS-Prozesse*, C.F. Müller, Karlsruhe 1972, pp. 209-213; cf. P. Marais, *op. cit.* (note 6), pp. 237-241.

5. The RSHA's letters and notes were consistently written on the front and back of the sheets of paper, but only the sheets were paginated, not each page. The Note of June 5, 1942, was also written on both front and back, but every page was individually paginated. At the very least this indicates a different typist.
6. Rauff's initial on the alleged original document from the Bundesarchiv is very similar to that on PS-501, but decisively different to Rauff's signature and initial on other documents.<sup>38</sup> Apparently both documents were signed by the same person, which was *not* Rauff. Is this the reason that Rauff's initial was deleted from the versions published in facsimile in widespread German literature?<sup>46,52</sup>

### 3.3.2.2. Contents of the 'Note', and Comparison With the RSHA Letter of June 23, 1942

The 're.:'-line states: "*Technical modifications to the Special Vehicles ["Spezialwagen"] used in the operations and to those currently in manufacture.*" This 're.:'-line already distinguishes the Note from the other letters in this matter. The other correspondence makes no mention of any modifications to be made by Gaubschat on vehicles already in service. Also, the term meaning 'special vehicles' which RSHA used to describe the vehicles was not '*Spezialwagen*', but rather '*Sonderfahrzeuge*', which was the usual term.

Linguistically speaking, the opening text of this Note is downright ridiculous. It begins:

*"Since December 1941, for example, 97,000 were processed with the use of 3 vehicles, without any defects in the vehicles becoming apparent."*

It makes no sense to begin a letter with 'for example'. The term 'for example' has meaning only when something was described or claimed in the foregoing, for which an example then follows. In this particular case, 'for example' cannot even refer to the 're.:'-line; the 're.:'-line speaks of technical modifications which are necessary, but the text immediately states that no defects have occurred in the vehicles. And that is not exactly an example to demonstrate the necessity for technical modifications!

The text does not indicate what the "97,000" that were "*processed*" might be.

A closer examination of the Note of June 5 and a comparison with the RSHA letter of June 23, 1942, shows that the Note is a sort of plagiarism of the letter of June 23. Both items are subdivided into 7 points pertaining to the RSHA's requested changes. The Note interprets these requests in a way that would point to exhaust-gas murders of human beings.

We submit that the 'Note' of June 5 is a fabrication. Its authors wrote it after the letter of June 23 was written, and predated it. The various points were rewritten, and supplemented with additional remarks in such a way that murderous intentions are made apparent. One proof for this fabrication is the fact that the 'Note' of June 5, in point 2, refers to a consultation between the RSHA and Gaubschat which the letter of June 23 shows not to have taken place until June 16, fully 11 days after (!) the alleged writing of the 'Note' of June 5!

To further substantiate our claim, we have compared and contrasted the corresponding points from the letter of June 23 and the Note of June 5 in the following table. All those remarks in the Note which indicate 'gassing', *i.e.*, the loading of the vehicles with humans, and which do not occur in the letter of June 23, are indicated by this author with bold print.

The letter of June 23 contained seven points. The Note of June 5 is also organized into seven points, but not all of them correspond even partly to the content of one of the points of the letter. Evidently some of the RSHA's June 23 requests for modification did not lend themselves well to the gassing theory and so they were left out. Instead, two supplements were added.

For example, point 3 in the Note of June 5 reads:

LETTER OF JUNE 23, 1942	'NOTE' OF JUNE 5, 1942
<p>“1. The cube body is to be reduced in length by 800 mm [31.5"]. [...] We herewith acknowledge the objections raised, that such a shortening would cause a disadvantageous distribution of weight. [The preceding text shows that this objection was raised by Gaubschat on the occasion of a verbal discussion on June 16, 1942.] Any disadvantages resulting herefrom will not be complained of to the firm of Gaubschat.”</p>	<p>“2. It would seem necessary to decrease the load area. This will be achieved by shortening the body by approximately 1 m [39"]. The above problem cannot be solved, as has been attempted, by reducing the number of objects per load. <b>This is because a reduction in the number necessitates a longer operation time, since the empty space also must be filled with CO.</b> [...] In a discussion with the manufacturer it was pointed out by the latter that a shortening of the cube body would result in a disadvantageous weight displacement. <b>In fact, however, an involuntary balancing in weight distribution occurs because during operation the load strives towards the back door and always largely ends up there.</b>”</p>
<p>“5. The slide-covered openings in the rear doors are to be omitted, and replaced with open slits of 100 × 10 mm [4" × 0.4"] in the upper back wall (not door). They are to be covered on the outside with easily movable, hinged metal flaps.”</p>	<p>“1. <b>To allow for the rapid inflow of the CO while preventing excessive pressure, two open slits of 10 × 1 cm [4" × 0.4"] are to be located in the upper back wall. These are to be covered on the outside with easily movable, hinged metal flaps to allow for self-regulation of any potential excess pressure.</b>”</p>
<p>“6. The closeable drain opening in the right front part of the cube floor is to be omitted. Instead, a drain opening of about 200 mm [9"] in diameter is to be cut into the cube floor. This opening is to have a strong, tight-fitting, hinged lid that can be closed and safely opened from outside.”</p>	<p>“4. To allow for easy cleaning of the vehicle [this expression builds on the implied allegation that the gassed people were covered with excrement and filth and had dirtied the vehicle accordingly], a tightly closeable drain opening is to be located in the center of the floor. The drain cover, about 200 to 300 mm [8" to 12"] in diameter, is to be equipped with a U-trap so that thin fluid can also drain out during operation.” [This too is a reference to excretions from the dying people.]</p>
<p>“7. The interior lights are to be protected with a domed wire guard that is stronger than that used to date.”</p>	<p>“6. The lighting appliances are to be more strongly protected from destruction than they have been so far. The iron grid guard over the lamps is to be domed enough to render damage to the lamp glass no longer possible. From practical experience it was suggested that the lamps should be omitted altogether, since allegedly they are never needed. <b>It was found, however, that when the back door is closed, i.e., when the interior becomes dark, the load urgently strives towards the door. This is because, at the onset of darkness, the load strives towards the light.</b> [Utter nonsense. Once the door was closed, it would have been no lighter there than in the rest of the cube body.] <b>Further, it was found that a commotion, probably due to the eerie nature of darkness, always breaks out at the point where the doors are closed. For this reason it would be expedient to turn the lights on before and during the first minutes of operation.</b>”</p>
<p>“The connecting hoses between the exhaust and the vehicle frequently rust through because they are corroded on the inside by fluids. To prevent this, the filler pipe is henceforth to be mounted in such a way that input proceeds from above downward. This will prevent fluids from entering.”</p>	

Connecting hoses for exhaust gas are added to the text here, whereas there was no mention of such a thing in the original letter.

Another supplementation is to be found in point 7 of the Note, where the need for a removable grate is mentioned. The text states that since

“[...] *the firm commissioned with this work [...] considers this design [...] to be impracticable at this time*”,

the design should be submitted “*to a different firm*”. This is entirely new to anyone familiar with these matters, and contradicts the urgency of the commission which is repeatedly expressed in other letters. Besides, internal notes jotted by members of the RSHA onto the back of Gaubschat’s letter of May 14, 1942, confirm that the RSHA decided to dispense with the removable grate and agreed to “*production as to date*”. There is no mention of a different firm to be consulted.

### 3.3.2.3. ‘Special Vehicles’ for Passenger Transports?

The correspondence does not allow for any inference of what the RSHA intended to use these ‘special vehicles’ for. On the other hand, it is possible to say with complete certainty what these vehicles could *not* be used for, namely for any kind of transports of human beings.

From the correspondence and the related memos of the RSHA some conclusions can be drawn regarding the nature of the cube body of these ‘special vehicles’.

The RSHA memo of April 27, 1942, investigates the various options for a quick-unloading mechanism: a) a tipping mechanism for the cube body; b) making the floor grate tippable; c) a removable and re-insertable grate.

The interior height of the cube body is given as 170 cm (67"). The planned elevation of the grate onto the wheel casings reduces this height by 7.5 cm (3"), leaving only 162.5 cm (64"). This is entirely inadequate for transports of standing people.

Under b), making the floor grate tippable, the hoped-for result is specified as a sort of “*smooth sliding*” of the load, which required an angling of the floor by 30 to 35 degrees. However, it is stated, the load required at least *one meter (3' 4") of clearance* between the floor and the ceiling because otherwise it would be crushed. This clearance requirement allowed for only a 10° angle of gradient, which did not suffice for “*smooth sliding*” of the load. This too shows that the ‘load’ could not have been people, since in such a case one meter’s clearance would not have sufficed.

“*So that the load does not fall over the last grate towards the back of the driver’s cabin*”, an “*angled gridwork*” of 30 to 40 cm (approximately 12 to 16") in height was to be affixed to the grate. Such a grid would not have been nearly high enough to keep people, standing closely crowded together, from falling against the back of the driver’s cabin.

The RSHA’s construction suggestions are concerned with the speedy unloading of the ‘special vehicles’. But – according to Kogon *et al.*, *NS-Massentötungen durch Giftgas* – this was no problem at all for the ‘gas van’ murderers. A few quotations from that work shall demonstrate this point.

For example, it is claimed that 50 to 80 persons were crowded into the ‘gas vans’ (pp. 84, 89, 91, 96, 104 and 196).

“*The victims were packed into the vehicle*” (p. 105).

“*We shoved them forcibly into the gassing vehicles [...], which... were entirely filled with people*” (p. 91).

The vehicles were always

“*[...] fully loaded, so that when the door was opened the bodies would fall out right away*” (p. 90).

Regarding the number of 50 to 80 people it ought to be borne in mind that, for a maximum payload of 4.5 tons, no more than 60 people could have been loaded at a time.

“*Then the van was opened. Some dead bodies fell out, the others were unloaded by the prisoners*” (p. 84).

*“The doors were opened and the bodies thrown into the pit”* (p. 105).

*“The back door of the van was opened and the bodies [...] brought out by other Jews, if they had not already tumbled out when the door was opened”* (p. 93).

*“When the doors were opened, dense smoke came out first, followed by a tangle of cramped-up people”* (p. 93).

But evidently there also already were ‘gas vans’ with tipping mechanisms:

*“Then the gas van backed up to the edge of the mass grave, the back door was opened, and the van body was tipped up and back. Thus the victims fell into the grave”* (p. 106).

One thing becomes perfectly clear from these witness statements: the ‘gas vans’ cannot be the same contraptions as the RSHA’s ‘special vehicles’. The latter would have lent themselves neither to passenger transports (their load room was not high enough) nor to murdering the occupants with exhaust gas (they had Diesel engines).

#### 3.3.2.4. A Few Remarks about Handwritten Notes on the Documents of RS 58/871

The back side of the documents R 58/871 fol. 13, a letter from Gaubschat dated May 16, 1942, a completely unsuspecting document, bears a lot of handwritten remarks by Rauff and others. Regarding their content, these notes are similar to those which can be found on document PS-501. It seems to have been usual that handwritten notes were written on the backside of received documents. Anyway, the handwritings here are remarkably different from those that can be found on Becker’s letter dated May 16, 1942, *i.e.*, the central document of the PS-501 folder.

## 4. Eyewitness Testimony

The critical assessment of the two main incriminating documents in support of the ‘gas vans’ has turned up very little in the line of substantiating their credibility. All we have left now are the statements of eyewitnesses; perhaps an examination of these may yet provide some convincing information.

We shall dispense with a repetition of the general reservations that must be kept in mind where eyewitness testimony is concerned, and refer the reader instead to the cautions set out in Section 2.3. But in our particular case there is an additional serious problem. As a rule, eyewitness testimony is part of trial or pretrial proceedings, and in Germany transcripts of these are not made available for free historical research. Therefore the statements are not accessible to us in their original form, *i.e.*, in the context of the witnesses’ overall testimony. We have access only to those short excerpts that have been quoted elsewhere. It is obvious that this can lead to misinterpretations. Every author is interested only in the topic that s/he is working on at the time, and will select sources accordingly. Therefore we can only quote eyewitness testimony that has already been selected by other authors, and we have no way of determining the contexts. For this reason we shall restrict ourselves largely to descriptions of factual matters.

The large number of eyewitness statements dealing with ‘gas vans’ could potentially, in and of itself, be taken as evidence for the actual existence of these vans, and prompts us to examine all such statements especially carefully.

## 4.1. Russian ‘Murder Vans’

The Russian ‘murder vans’ came to our attention through the conformist testimony in the trials of Krasnodar and Char’kov.<sup>53</sup>

The defendants and the witnesses described the ‘murder vans’ almost identically, as follows:

- dark gray, box-shaped heavy-goods vehicle
- a large, two-axled heavy-goods vehicle
- 5 or 7 tons
- Diesel engine
- six-cylinder engine
- interior lined with galvanized iron
- at the back, double doors that sealed hermetically
- rubber lining on the doors
- on the floor, a (wooden) grate
- underneath, one or more tube/s connected to the exhaust pipe
- looked like a normal prison or delivery van
- vehicle holds about 60 – 70 people
- it was called ‘murder van’, ‘death van’, ‘Black Raven’

The almost identical nature of the descriptions, which in one respect could be taken as an indication of the correctness of the statements, may in this case actually be the result of Soviet interrogation methods, and thus of no evidential value. This, in any case, is indicated by the Diesel engines, which were emphatically confirmed by all witnesses and which render the alleged murder method impossible.

It is virtually impossible to check the witnesses’ claims. Nevertheless, some of these accounts have even been factored into German court verdicts!

## 4.2. ‘Gas Vans’ in Trials of National Socialist Crimes

### 4.2.1. Various Types of ‘Gas Vans’

According to the account contained on pages 81ff. of the documentary volume *NS-Massentötungen mit Giftgas*,<sup>46</sup> the vehicles used as ‘gas vans’ were those special vehicles of the RSHA which the firm of Gaubschat was supposed to equip with specially modified bodies. We have already shown that this claim is untenable.

Witnesses, however, do not speak only of Saurer ‘gas vans’, and even with respect to these they mention not only a single model, but other ‘gas van’ types as well.

Regardless of the fact that the Saurer ‘gas van’ is consistently described as a 5-ton vehicle, it must have existed in two different sizes – one size with a capacity of 50 persons,<sup>54</sup> and another with a capacity of 80.<sup>55</sup> In fact, the Saurer heavy goods vehicles had a maximum capacity of 4.5 tons and, as we have already seen in Section 3.3.2.3., could not have held more than 60 people.

<sup>53</sup> *The People’s Verdict*, Hutchinson & Co., London 1944, pp. 8f., 49, 50, 65, 69, 77f., 85, 89f.; cf. also note 11, and the report in the *Moscow News* no. 7, July 1990, quoted in U. Walendy, *op. cit.* (note 11), p. 21; also J.C. Ball, *Air Photo Evidence. Auschwitz, Treblinka, Majdanek, Sobibor, Bergen Belsen, Belzec, Babi Yar, Katyn Forest. World War II photos of alleged mass murder camps*, Ball Resource Services Ltd., Delta/BC, Canada, 1992, pp. 9 and 13, who mentions the “*Black Ravens*” used by the Soviets in Katyn.

<sup>54</sup> E. Kogon *et al.* (eds.), *op. cit.* (note 46), p. 84.

<sup>55</sup> *Ibid.*, p. 98.

Another ‘gas van’ type is said to have been an American truck manufactured by the firm of Diamond – a 3-ton model which also occurred in two different sizes: one with a capacity of 25 to 30 people<sup>56</sup> and one large enough for 50 people.<sup>57</sup>

Other vehicle types that were identified as ‘gas vans’ were: a “*Renault of medium weight*”;<sup>58</sup> a Magirus-Deutz;<sup>59</sup> and an Opel-Blitz.<sup>60</sup> One witness claims she saw a “*gigantic car*” with standing room for 100 persons.<sup>61</sup>

And then there was also a “*sort of moving van*” bearing the logo “*Kaisers Kaffee-Geschäft*” on either side.<sup>62</sup> However, two other witnesses who claim they saw the same vehicle did not notice this logo.<sup>63</sup> The appearance of these special vehicles is also described differently from case to case. Once it was a “*large, metal-plated, windowless vehicle with a large iron door at the back. [...] A container was attached underneath the vehicle, and pipes led from it into the interior*”.<sup>64</sup> A different witness, on the other hand, claims that it was an “*institutional tractor with a large, hermetically sealed steel trailer*”.<sup>65</sup>

#### 4.2.2. Description of the ‘Gas Vans’

As if the differing descriptions of the van types and sizes were not enough, the details given regarding their outfitting and appearance are even more grossly contradictory. Kogon’s book in particular presents a wild conglomeration of conflicting claims:

The van bodies were “*windowless*”;<sup>66</sup> they had a “*peephole or pane*” through which the persons outside could look in;<sup>67</sup> they had a window or peephole from which one “*could look from the cab into the van*”;<sup>68</sup> or they had “*painted-on, fake windows*”.<sup>69</sup>

Regarding the door/s of the ‘gas vans’ there are the following witness statements: There was a large door at the back of the vans;<sup>70</sup> there were two doors or a double door.<sup>71</sup> This door “*could be hermetically sealed*”;<sup>72</sup> it was “*latched shut*”;<sup>73</sup> “*bolting*”;<sup>74</sup> locked with a padlock, the key to which hung in the driver’s cab;<sup>75</sup> it was screwed shut with “*three screws, at the top, in the middle and at the bottom*”.<sup>76</sup>

Considering that the ‘gas van’ bodies were supposed to be a standard model, these widely divergent features are astonishing. What is more, the contradictory claims often refer to one and the same specific vehicle which different witnesses claim to have seen.

---

<sup>56</sup> *Ibid.*, p. 84.

<sup>57</sup> *Ibid.*, p. 98.

<sup>58</sup> *Ibid.*, p. 114.

<sup>59</sup> G. Fleming, *op. cit.* (note 8), pictorial section.

<sup>60</sup> M. Beer, *op. cit.* (note 1), p. 414.

<sup>61</sup> E. Kogon *et al.* (eds.), *op. cit.* (note 46), p. 108.

<sup>62</sup> *Ibid.*, p. 63.

<sup>63</sup> E. Klee, “*Euthanasie*” im NS-Staat, Fischer, Frankfurt/Main 1983, p. 107.

<sup>64</sup> E. Kogon *et al.* (eds.), *op. cit.* (note 46), p. 64.

<sup>65</sup> E. Klee, *op. cit.* (note 63), p. 107.

<sup>66</sup> E. Kogon *et al.* (eds.), *op. cit.* (note 46), pp. 64, 96.

<sup>67</sup> *Ibid.*, p. 84.

<sup>68</sup> *Ibid.*, p. 115.

<sup>69</sup> *Ibid.*, p. 102.

<sup>70</sup> *Ibid.*, pp. 64, 85, 95, 96, 104.

<sup>71</sup> *Ibid.*, pp. 88, 91, 93, 99, 102, 105, 114, 125, 126.

<sup>72</sup> *Ibid.*, pp. 63, 88, 91, 105.

<sup>73</sup> *Ibid.*, p. 85.

<sup>74</sup> *Ibid.*, p. 95.

<sup>75</sup> *Ibid.*, pp. 126, 127.

<sup>76</sup> E. Klee, *op. cit.* (note 63), p. 107.

One thing, however, has gone entirely unmentioned by almost all witnesses: the device or set-up by means of which the inmates were to have been gassed. This typical feature of the ‘gas vans’ – the crux of the matter we are concerned with – is entirely absent from the witnesses’ testimony.

One special sub-aspect of this topic are the claims that the ‘gas vans’ were also used to kill the mentally ill (euthanasia), as well as in the camp of Kulmhof/Chelmno. There is no written, documentary evidence for these accusations – only eyewitness testimony. It is beyond the scope of this work to discuss these claims here, and it shall suffice to say that they are no more credible than the others we have examined.

So, in the end, we know no more than at the start. The witness statements have also failed to provide conclusive proof of the existence and use of ‘gas vans’ for the purpose of murdering their passengers.

### 4.3. The Real Problem is the Eyewitness Testimony

Several years ago this author visited the Yad Vashem Institute in Jerusalem to learn details about the extermination camp Treblinka. To her surprise, the Israeli official in charge there told her, on July 10/11, 1985:

*“We have known for a long time that there was never any such thing as an ‘extermination camp Treblinka’. Israeli scientists, historians and geologists have repeatedly examined the sites described by the witnesses, and their detailed investigations have not turned up a single shred of evidence for the existence of an extermination camp. Such a camp, and the events there, would have to have left traces behind, which could be found. But there are no such traces. The real problem with Treblinka is the eyewitness testimony.”*

This assessment also applies to the ‘gas vans’. However, it would be unrealistic to assume that all those people who claim to have seen ‘gas vans’ deliberately and knowingly lied, *i.e.*, perjured themselves. They must have seen vans or trucks of some sort which, for whatever reasons, struck them as unusual or dangerous.

The most simple explanation may be that people were taken by truck or van from one place to another. The witnesses saw people getting into a vehicle and not returning. The idea to connect that fact with ‘gas vans’ may not even have occurred to them until after the war.

As we have already seen, the term ‘gas vans’ – as a description of murder vans – did not exist in the Third Reich. But there *were* various special vehicles which were called ‘gas vans’, ‘gassing vans’, or ‘gas generator vans’. F. P. Berg has discussed these latter vehicles in detail in his chapter (this volume).

We believe that what so agitated the imagination of the witnesses was first and foremost a different kind of ‘special vehicle’. Particularly in Polish and Russian areas behind the front, the German troops saw themselves faced with the problem of typhus. This same problem also existed in the concentration camps and ghettos. Combating this danger was one of their most pressing tasks. The extensive contemporaneous literature shows this clearly.<sup>77</sup> Gassing vans, also called gas vans for

<sup>77</sup> Cf. *e.g.*: L. Gassner, “Verkehrshygiene und Schädlingsbekämpfung”, *Gesundheits-Ingenieur* 66(15) (1943) pp. 174ff.; H. Kayser, “Ärztliche Erfahrungen bei der Planung, dem Bau und Betrieb von Durchgangslagern für ausländische Arbeitskräfte”, *Arbeitseinsatz und Arbeitslosenhilfe* 24(21) (1943) pp. 127ff.; F. Konrich, “Über die Sanierungsanstalten der deutschen Kriegsgefangenenlager”, *Gesundheits-Ingenieur* 64(29) (1941) pp. 399-404; J. Mrugowsky, “Die Seuchenlage im europäischen Teil der UdSSR”, *Zeitschrift für Seuchenabwehr, Wohnungshygiene und Schädlingsbekämpfung* 34(12) (1942) p. 115; E. Pappenheim, “Fehler beim Bau von Entlausungsanstalten”, *Gesundheits-Ingenieur* 66(16) (1943) pp. 183f.; G. Peters, *Die hochwirksamen Gase und Dämpfe in der Schädlingsbekämpfung*, F. Enke, Stuttgart 1942; G. Peters, W. Rasch, “Die Blausäure als Entlausungsmittel in Begasungskammern”, *Der praktische Desinfektor* 33(9) (1941) pp. 93-96; F. Puntigam, “Hygienische Gesichtspunkte bei der Auswahl des Platzes für ein zu errichtendes Durchgangslager mit Entlausungseinrichtungen für ausländische Ar-



short, were often used as mobile decontamination stations. The term ‘gassing vans’ was a result of the procedure used: the lice, which were the main carrier of the typhus pathogene, were destroyed (gassed) with hydrogen cyanide. There were other decontamination procedures as well, but fumigation with HCN was recommended as the most expedient. The decontamination stations for the clothing were supplemented with disinfection stations for the people. As a stopgap, makeshift measure, moving vans were sometimes renovated and used for this purpose,<sup>78</sup> and some of the witnesses do after all claim to have seen these, and considered them to be ‘gas vans’.

In this context it is interesting to note that some of the witnesses spoke of “*painted-on fake windows*”. This is reminiscent of the “*windows*” mentioned in Nuremberg Document PS-501. In fact, there were ‘window shutters’ on the “*Bekleidungs-Entgiftungs-Kraftwagen*” [Clothing Detoxification Vans], Sd. Kfz. 93,<sup>79</sup> which were normally at the disposal of the *Nebeltruppen* (operators of fog throwers to produce smoke screens as an air defense measure). These detoxification vans also were not a device for ‘gassing’ humans, but rather for neutralizing clothing that had been contaminated with chemicals spread by chemical weapons or used by the fog throwers.<sup>80</sup>

It is also not impossible that the RSHA’s special vehicles were used for disinfection purposes. In any case, an SS-*Obergruppenführer* confirmed in April 1942 that the RSHA had supplied him with a ‘delousing van’.<sup>81</sup>

Together with rumors (which are well known to run rampant in closed-off areas such as ghettos and camps), such vehicles may very well have been the foundation for speculations. The post-war stories which filled in the gaps in the witnesses’ knowledge with uncontrolled reports and tales probably did the rest.

We are no more able to offer a solution to the problem of the eyewitness testimony than was the official in charge at the Yad Vashem Institute. To bring light into this darkness would be the responsibility of free and unfettered historical research.

---

*beitskräfte*”, *Arbeitseinsatz und Arbeitslosenhilfe* 6(3) (1942) pp. 27f.; F. Puntigam, H. Breymesser, E. Bernfus, *Blausäuregaskammern zur Fleckfieberabwehr*, Sonderveröffentlichung des Reichsarbeitsblattes, Berlin 1943; F. Puntigam, H. Pichler, “*Raumlösungen von Entlausungsanstalten*”, *Gesundheits-Ingenieur* 67(6) (1944) pp. 139-145; J. Rupper, “*Die Seucheninsel Polen*”, in Jost Walbaum (ed.), *Kampf den Seuchen! Deutscher Ärzte-Einsatz im Osten*, Deutscher Osten, Krakow 1941; H. Weidner, “*Die Organisation der Läusebekämpfung im Hauptkommissariat Baranowitsch, Weißruthenien*”, *Der praktische Desinfektor* 34(4) (1942) p. 35; R. Wohlrab, “*Flecktyphusbekämpfung im Generalgouvernement*”, *Münchener Medizinische Wochenschrift* 89 (1942) pp. 483-488; E. Wüstinger, “*Vermehrter Einsatz von Blausäure-Entlausungsgaskammern*”, *Gesundheits-Ingenieur* 67(7) (1944) pp. 179f.

<sup>78</sup> G. Peters, W. Rasch, *op. cit.* (note 77), p. 94: “*We note the attempt to use moving vans for delousing purposes in places where it was necessary to come up with makeshift fumigation facilities on short order.*”

<sup>79</sup> W. Oswald, *op. cit.* (note 3), p. 210; cf. John Milsom, *German Military Transport of World War Two*, Arms & Armour Press, London/Hippocrene Books, New York 1975, p. 145, Ill. 261: “*Henschel 33G 1, clothing decontamination truck, Kfz 93.*”; R. Frank, *op. cit.* (note 3), p. 93.

<sup>80</sup> The fog throwers were machines that could turn concentrated sulfuric acid (called ‘oleum’ due to its high viscosity) or sulfuric acid anhydride (SO<sub>3</sub>) into an extremely fine spray and blow it straight up into the air. These hazardous substances combine with the moisture in the air, and real fog is formed as a result. The extremely aggressive sulfuric acid used was also a danger to the personnel; for this reason, Special Vehicles 93 always had to be on stand-by, so that the operators of the fog throwers could promptly clean themselves up with the warm water and neutralizing solutions (such as sodium hydrogen carbonate, NaHCO<sub>3</sub>) that were kept at the ready there. Since the Allies soon learned to drop bombs accurately even despite such fogging, the procedure was abandoned in the course of the war. I owe this information to O.W. Grussendorf. Besides that, another task of these Special vehicles clearly was the defense against attacks with chemical weapons, cf. Oberkommando des Heeres (ed.), *Die Nebeltruppe*, Waffenhefte des Heeres, Deutscher Volksverlag, Munich 1941, p. 24; Adolf Röpnack, *Die Geschichte der Raketartillerie von den Chinesen bis zu den Deutschen über ignis volans bis zur V-2*, pub. by author, Bad Aibling 1960, p. 129.

<sup>81</sup> E. Kogon *et al.* (eds.), *op. cit.* (note 46), p. 107.

## 5. Conclusion

Our critical assessment of the evidence in the case of the ‘gas vans’ has determined the following:

According to Soviet officers, ‘murder vans’ in which the passengers were poisoned with the exhaust gas already turned up in the Soviet Union in the 1930s. In 1943 the Soviets claimed that German troops had used such ‘murder vans’ to kill thousands of innocent Soviet citizens. The vehicles mentioned in these allegations were exclusively heavy-goods vehicles which had Diesel engines, whose exhaust gas demonstrably does not contain enough carbon monoxide to have a lethal effect. On the basis of these accusations, Ukrainians as well as German prisoners-of-war were unlawfully executed.

In the Nuremberg Trials, the Soviets repeated their accusations, in which they were supported by the American prosecutors, who presented written documents: affidavits, and Document PS-501 – one of two documents on which the ‘gas vans’ theory rests to this day. We have shown that neither the affidavits nor PS-501 are probative documents. In the 1970s another document, R 58/871, suddenly surfaced from the Koblenz Federal Archives, to also allegedly substantiate the existence of ‘gas vans’. We have clearly shown this item to be a fabrication.

The 1960s and 1970s saw many NS-trials, in the course of which the ‘gas vans’ theory was supposed to be corroborated – by internally inconsistent and at times nonsensical eyewitness testimony. In this context we have demonstrated the problem of the eyewitness testimony by means of neutral assessments, and have come to the conclusion that in order to be credible, eyewitness testimony must be authenticated by provable facts or by documents that have stood up to close critical examination. In the case of the ‘gas vans’ this has not been possible in so much as one single instance.

On the whole, the evidence submitted for the ‘gas vans’ cannot be accorded any evidential value, and the claim that Germans had murdered thousands of human beings in ‘gas vans’ must be regarded strictly as rumor.



# Do Photographs Prove the NS Extermination of the Jews?

UDO WALENDY

## 1. Introduction

Photographs played a central role in the arsenal with which Allied war propaganda slandered the enemy in World War One, as Ferdinand Avenarius has shown with numerous examples.<sup>1</sup> Retouching techniques were admittedly quite crude in those days, and the falsifications were thus easy for a critical examiner to detect. However, such highly skilled souls were few and far between and, more importantly, not at all welcome in the agitated atmosphere of the First World War. Today people shake their heads in astonishment that even drawings and caricatures of contemporaries, crudely drawn and easily recognizable as such, were accepted as sterling truth. But do we really have any cause for such a condescending attitude?

Alain Jaubert has shown that dictatorships in particular have a strong inclination for manipulating photos or producing posed and even completely faked photographs.<sup>2</sup> Jaubert deals primarily with the self-portrayal of rulers by means of altered and ‘improved’ photographs and, unfortunately, all but dispenses with the interesting aspect of wartime propaganda – as well as the propaganda engaged in by democratic nations, which rarely exhibit any greater scruples in this matter than dictatorships. Great Britain no doubt leads this crowd.

One of Jaubert’s examples warrants a closer look here. On page 78 of his book he reproduces a photograph that shows the abuse of English prisoners-of-war in France by French civilians at the time of German occupation during the Second World War. Jaubert interprets this as a photo made up by the German occupation troops. However, he provides no evidence to support his claim. Since the Allies also launched massive air raids on French cities, resulting in heavy losses of life among the civilian population,<sup>3</sup> it certainly is not inconceivable that the French might have vented some anger on Allied prisoners-of-war, especially in light of the fact that a considerable part of the French population collaborated with the Germans, partly out of opportunism, partly out of conviction. But the Allied bombing of French targets as well as the war-time collaboration with the Germans are taboos in today’s French society. Therefore – is the photograph Jaubert shows really posed, or is his interpretation incorrect because in his opinion that which *must not be cannot be*?

## 2. Techniques of Falsifying Photographs, and Their Detection

We distinguish between three kinds of forgery, as follows:

1. *Genuine and unretouched photographs are given false captions.* This is not actually a falsification of the photos *per se*, but rather a false account of what is shown. However, this has ever been one of the most effective methods of deception, since after all the photo itself is genuine and the misleading caption can often be exposed only if what the picture actually does show can be proved

---

<sup>1</sup> F. Avenarius, *Das Bild als Verleumder*, Callwey, Munich 1916; F. Avenarius, *Das Bild als Narr*, *ibid.*, 1918; cf. U. Walendy, *Historische Tatsachen* No. 22: “Alliierte Kriegspropaganda 1914-1919”, Verlag für Volkstum und Zeitgeschichtsforschung, Vlotho 1984, cited in the following as *HT*.

<sup>2</sup> A. Jaubert, *Fotos, die lügen*, Athenäum, Frankfurt/Main 1989.

<sup>3</sup> Cf. the introduction to A. Grosser, *Ermordung der Menschheit*, Hanser, Munich 1990, p. 9; a detailed survey about Allied air raids against non-German cities cf. M. Czesany, *Europa im Bombenkrieg 1939-1945*, Leopold Stocker, Vienna 1998.

by means of reliable sources. In some cases, though, details in a photograph can suffice to prove that the alleged content is false – for example, when the location, persons or objects appearing in the photo cannot be reconciled with what the caption claims.

2. *Genuine photos are altered as to their details.* This entails, first, targeting only specific sections of a photo in order to remove such parts as would refute the false, alleged message the photo is to convey. A second variation involves the addition or insertion of a genuine – changed or unchanged – portion of a photo into another photo, which in turn may also be genuine or faked, resulting in an alteration of the overall message the photo conveys. Alteration of the genuine portion is then usually confined to a change in the faces shown, or to making undesired parts of the photo unrecognizable. Up until the late 1970s and early 1980s this was done by hand, by artistically changing or supplementing enlargements of the photo. Falsifications of this type are usually easy for the practiced eye to detect, since shadows, perspective, and realistic depictions are rarely rendered perfectly. There are cases, however, where such changes are made with brilliant precision, and cases where those changes are deliberately made difficult to prove by out-of-focus photographing of the altered copy.

Today, advanced computer technology allows for the almost limitless manipulation of photo documents, and changes are no longer provable. Modern computer systems can perform perfect manipulations of shadows and distortions of perspective as well as of natural colors and shapes on existing photographs that are scanned into a computer. For this reason, any picture relating to controversial historical topics and published for the first time nowadays must be strictly rejected as evidence. Only proof that the physical material of the corresponding original negative or transparency dates from pre-computer days restores a photo to its status as historical document.

3. *Complete forgery.* If an alleged documentary photograph consists of a photographed drawing, or if it has been assembled from parts of other photos, this represents a complete forgery. The dividing line between altered photos and complete forgeries is by its very nature a fluid one. Like retouched photographs, such forgeries may be exposed through the detection of inconsistencies in the way shadows are cast, in perspective, shape and color, line direction, as well as by a proof of the impossibility of certain combinations of persons, objects and locations shown.

Thanks to modern computer technology, the considerations set out in 2. also apply to the evidential value of recent documentary photographs.

### 3. Photographs Regarding the Persecution of the Jews in the Third Reich

In light of the dubious circumstances under which witness testimony, confessions and affidavits, but also documents of all kinds attesting to the National Socialist persecution of the Jews came and continue to come about and which the present volume points out time and again, can one really assume without any critical second thoughts that all the photographs about the National Socialist persecution of the Jews which have been shown to us in recent years are genuine? Or would it not be more prudent to proceed with caution, and to subject each of these photos to critical examination?

In fact there has been only one monograph to date which deals with the actual or alleged documentary photographs of the National Socialist persecution of the Jews.<sup>4</sup> A. Jaubert<sup>2</sup> does not discuss

---

<sup>4</sup> U. Walendy, *Bild- "Dokumente" für die Geschichtsschreibung?*, Verlag für Volkstum und Zeitgeschichtsforschung, Vlotho 1973; cf. also U. Walendy, *Europa in Flammen*, v. II, *ibid.*, 1967, documentary appendix, and U. Walendy, *The Journal of Historical Review (JHR)* 1(1) (1980) pp. 59-67 (online: [vho.org/GB/Journals/JHR/1/1/Walendy59-67.html](http://vho.org/GB/Journals/JHR/1/1/Walendy59-67.html)); regarding manipulated photographs and films see also U. Walendy, "Immer neue Bildfälschungen", part 1 & 2, *HT* 63 & 64, Verlag für Volkstum und Zeitgeschichtsforschung, Vlotho 1994/1995; S. Egel, "Verordnete Einheitsmeinung" part 1 & 2; *Vrij Historisch Onderzoek*, Berchem 1997.

this subject, perhaps because he does not consider it politically opportune to do so. G. Frey<sup>5</sup> touches on this topic, but in my opinion he does not give it as much attention as it deserves. Aside from these examples, any discussion by the establishment's historians of the authenticity of such documentary photographs has been confined to polemics and to criminal charges against doubters and critics until recently, but has changed in 1996/97, as we shall see.

This was indeed an alarming state of affairs, since in this age of illustrated magazines and television, photographs have a powerful pedagogic influence on the people, and faked photos therefore have a propagandistic and even incendiary effect that can hardly be overestimated. This is particularly so in the context of the National Socialist persecution of the Jews, as this is a topic for which the vast majority of the people have by now acquired a sort of Pavlovian response, a ritualistic consternation that renders any critical assessment of the evidence presented virtually impossible.

In the following, some pictures that are offered over and over again as proof of actual or presumed events of the National Socialist persecution of the Jews will be discussed and critically analyzed. Due to the limited space available, this discussion cannot be anything near comprehensive, neither with respect to the number of photos requiring analysis nor in terms of the scope of each analysis. A comprehensive critique of the well-known photographs on this topic, which would go beyond my previous work,<sup>6</sup> needs yet to be compiled.

### 3.1. Mis-Captioned Photographs

It is often difficult to prove that a photograph shows what the caption claims it shows. One generally has only eyewitness testimony as corroboration, namely that of the photographer on the one hand and, on the other, that of people who witnessed the event and perhaps appear in the photo. The location depicted on the photo helps to determine the place and sometimes the time that a picture was taken. The presence, in the photo, of well-known personalities whose participation in the event is verifiable can go a long way towards facilitating identification. If, however, a photo shows only people whose identity cannot be ascertained, and if the background of the photo shows nothing unique or characteristic that would permit the picture to be spatially and perhaps also temporally fixed, then one is truly at the mercy of the photographer and his statements. If even the photographer is unknown, and all the evidence one has depends on witnesses and hearsay, then such photographs are all but worthless as historical documents, since anyone is free to make any unverifiable claims he wants to as regards the alleged content.

In fact, both the persons shown as well as the originators of the photos are completely unknown for all the pictures reproduced in the following. This is a condition that applies to almost all so-called photographs pertaining to the murder of the Jews. Actually this in itself ought to be reason enough to dispense with 'photo documents' altogether, except where all or most data about the photo (taken by whom and when) and the items shown (persons, locations) can be verified by external evidence. But let us take a look at some examples anyhow.

Our *first photo* (next page) shows two shrunk heads which the American troops allegedly found on liberating the camp Buchenwald. These and other medical specimens are said to be parts of the bodies of deceased inmates. Lampshades, book bindings and bookmarks of tattooed human skin, as well as two shrunken heads, caused a particular sensation. Aside from the general Nuremberg indictment, these served as the primary evidence in the trials of Ilse Koch, the wife of the former

<sup>5</sup> G. Frey (ed.), *Vorsicht Fälschung*, FZ-Verlag, Munich 1991, pp. 246-267.

<sup>6</sup> Aside from the works cited previously (note 4), reference is also made in this context to the many individual examples which have been published time and again in the various issues of *Historische Tatsachen*, Verlag für Volkstum und Zeitgeschichtsforschung, Vlotho 1975-1997.

Commandant of Buchenwald. She was said to select living inmates on the basis of their tattoos, and to have them killed in order to have various commodities manufactured from their skins.

According to a statement of the American General Clay, the alleged lampshades from human skin were in fact made of goat hide.<sup>7</sup> In his detailed study of the matter, A. L. Smith found that the objects which the U.S. Commission had identified as consisting of human skin disappeared without a trace after being sent to the International Military Tribunal (IMT) in Nuremberg.<sup>8</sup> All the objects discovered later were either of imitation leather or animal hide, fabric or pasteboard. In 1973, the U.S.

National Archives discovered two books which allegedly were bound in human skin. In 1982, a forensic analysis of this suede leads to the conclusion that it was the skin of a big animal.<sup>9</sup>

The charges brought against Ilse Koch later, before a German court, were based solely on the untrustworthy testimony of the professional witnesses from Dachau trials, which Manfred Köhler has already discussed in the present volume. Amid the atmosphere of hysteria, “*propaganda and mass suggestion*”<sup>10</sup> prevailing at the time, Ilse Koch – who had previously been sentenced to life imprisonment by the Americans in Dachau, but had eventually been pardoned – was again sentenced to life imprisonment by a German court, and later committed suicide. The two shrunken heads that were submitted in evidence turned out to be of South American origin, and bore the inventory control number of a German anthropological museum.<sup>11</sup> They, too, have disappeared without leaving any traces.

Arthur L. Smith suggests that there had been a medical student from the University of Jena in the concentration camp Buchenwald, who had written his dissertation on the relationship between skin tattoos and crime. In this context, use may possibly have been made of tattooed skin, albeit taken from inmates who had already died.<sup>12</sup> Since the taking of organs or tissue from deceased persons is neither unusual nor reprehensible when done for medical and educational purposes and with the consent of the deceased or their relatives, the question is whether and in what context the skin was taken. In any case, mis-captioned photographs and lies are attributed to the objects in the Buchenwald case and elsewhere.



**Illustration 1:** *Shrunken heads, from R. Neumann, Hitler – Aufstieg und Untergang des Dritten Reichs, Munich: Oldenbourg, 1961, p. 183.*

<sup>7</sup> A. L. Smith, *Die "Hexe von Buchenwald"*, Böhlau, Cologne 1983, p. 227.

<sup>8</sup> *Ibid.*, pp. 103, 138, 153, 164; U. Walendy, *HT* No. 43, 1990, pp. 15ff.; G. Frey, *op. cit.* (note 5), pp. 200ff., 211; A. Mohler, *Der Nasenring*, Heitz & Höffkes, Essen 1989, pp. 133ff.

<sup>9</sup> Cf. David Irving, “*Menschenhäute*”, *Vierteljahreshefte für freie Geschichtsforschung*, 3(2) (1999), pp. 214ff. (online: [vho.org/VffG/1999/2/Irving214-216.html](http://vho.org/VffG/1999/2/Irving214-216.html)); English: online at [fpp.co.uk/Auschwitz/documents/controversies/humanskin](http://fpp.co.uk/Auschwitz/documents/controversies/humanskin).

<sup>10</sup> A. L. Smith, *op. cit.* (note 7), p. 138.

<sup>11</sup> Perhaps they belonged to the *Naturkundliches Museum* in Weimar near Buchenwald, which does no longer exist. Its exhibits now belong at least partly to the *Naturkundemuseum* in Gotha. Personal communication of Peter Lange. Helmut Rehm remembers from the media coverage of those years that it turned out that these heads had an inventory number of the *Anthropologisches Museum* of Berlin Dahlem, personal communication. It certainly is worth exploring the Koch files to find out where these heads really came from – and where they are now.

<sup>12</sup> A. L. Smith, *op. cit.* (note 7), pp. 127f.

According to Bergschicker, *illustration 2* shows the victims butchered by the Ukrainian nationalist battalion *Nachtigall*, whose political officer allegedly was Theodor Oberländer.<sup>13</sup> In his book *Der rote Rufmord*, Kurt Ziesel proved that this campaign against the then Federal Minister was based on a false caption.<sup>14</sup> The photo in fact shows victims of the Soviet NKVD, which liquidated enemies of the regime *en masse* before the Red Army retreated in 1941. This case is not an isolated one. It is common practice to blame heaps of dead bodies on some putative culprit, and since the Germans have been conditioned to be credulous and ever



**Illustration 2:** Allegedly these are victims of a massacre perpetrated by the battalion *Nachtigall*. From H. Bergschicker, *Der zweite Weltkrieg*, Berlin: Deutscher Militärverlag, 1968.

ready to make overhasty declarations of guilt, they are the favored target. *Illustration 3* shows a similar example, which was reprinted in the May 21, 1945, issue of the American magazine *Life*, among others. The photo allegedly shows dead slave laborers from the concentration camp Nordhausen. In its commentary the magazine suggested that these inmates died of starvation, overwork, and beatings. In fact, however, M. Broszat and others have determined that these dead concentration camp inmates were victims of an Allied air raid against the Nordhausen camp.<sup>15</sup>

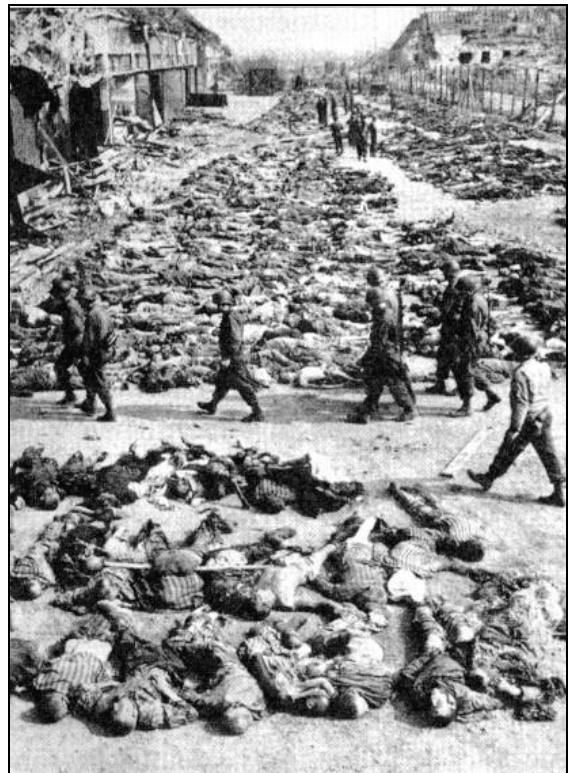

**Illustration 3:** The photo reproduced in the American magazine *Life* of May 21, 1945, showing the “bodies of almost 3,000 slave laborers in Nordhausen”.

*Illustration 4* (next page) allegedly shows victims of mass murder in Auschwitz.<sup>16</sup> The bodies are actually those of inmates who had succumbed to typhus in the concentration camp Bergen-Belsen. To date no similar photos have been found of Auschwitz or other sites of alleged mass exterminations. The deliberate misrepresentation of victims of starvation, typhus, supply shortages of all kinds, and unhygienic conditions in the camps of the Third Reich towards the end of the war is thus probably done out of sheer necessity, due to the painful lack of other, real pictures.

It was no doubt the case that the hellish conditions prevailing in the western camps gave the uninformed western Allied observers the impression that mass killings had been carried out deliberately in these

<sup>13</sup> H. Bergschicker, *Der Zweite Weltkrieg*, Deutscher Militärverlag, Berlin (East) 1964, p. 150.

<sup>14</sup> K. Ziesel, *Der rote Rufmord*, Schlichtenmayer, Tübingen 1961, pp. 78ff.; cf. U. Walendy, *Bild-“Dokumente”* ..., *op. cit.* (note 4), pp. 3ff.

<sup>15</sup> M. Broszat, *Studien zur Geschichte der Konzentrationslager*, Schriftenreihe der Vierteljahrshefte für Zeitgeschichte, No. 21, Stuttgart 1970, pp. 194f.; cf. U. Walendy, *HT* No. 34, 1988, p. 37.

<sup>16</sup> From a 1979 issue of *Quick*, cited as per G. Frey, *op. cit.* (note 5), p. 259, who does not give a precise date.



camps, so that the corresponding initial Allied reports may be understandable enough. In truth, however, these conditions were the result of external circumstances such as, for example, the evacuation of camps near the Front, whose inmates were (foolishly enough) transferred into the national interior at this time on Himmler's orders;<sup>17</sup> the total overcrowding resulting from this measure for the remaining camps, as well as the break-down of sanitary, medical and food supply lines to the camps due to the collapse of the infrastructure of the Third Reich which was being bombed to death at this time, combined to give rise to the horrific conditions in the camps.



Norbert Frei comments on the reaction of the western Allies when they arrived in the concentration camps:<sup>18</sup>

*"The shock at what they discovered infrequently led to factually incorrect conclusions, some of which were to prove rather persistent. Paradoxically enough, they could also give rise to politically and historically correct conclusions."*

By "*historically correct conclusions*" he probably means those allegations of mass extermination that have been disproved for the western camps but are said to be correct for the alleged extermination camps in the East. As for the "*politically [...] correct conclusions*", these probably relate to the desirable effects that mis-captioning such photos has in terms of 'public education'.<sup>19</sup>

The fact that the conditions for example in the concentration camp Dachau were actually not too bad prior to the winter of 1944 can be seen from the published diary of a former internee who was imprisoned in Dachau from November 1942 to June 1945.<sup>20</sup> In contrast to this, and according to the published diary of a former German soldier, the conditions under which German soldiers were imprisoned by the US Army in Dachau after the war were much more severe,<sup>21</sup> and this time deliberately so, in order to harm as many Germans as possible.<sup>22</sup>

<sup>17</sup> Cf. A. Rückerl, *NS-Prozesse*, C. F. Müller, Karlsruhe 1972, pp. 122ff.

<sup>18</sup> Cf. N. Frei, *Vierteljahrshäfte für Zeitgeschichte (VfZ)* 35 (1987) pp. 385-401, here p. 400.

<sup>19</sup> Two further examples of incorrect captions: M. Weber, "The Warsaw Ghetto Boy", *JHR* 14(2) (1994) pp. 6f.; "Inaccurate Time Magazine Photo Caption Defames Ukrainians", *JHR* 14(2) (1994) p. 8.

<sup>20</sup> A. Haulot, "Lagertagebuch. Januar 1943 – Juni 1945", in *Dachauer Hefte*, 1(1) (1985), pp. 129-203.

<sup>21</sup> G. Naumann, *Besiegt und "befreit". Ein Tagebuch hinter Stacheldraht in Deutschland 1945-1947*, Druffel, Leoni am Starnberger See 1984. A comparison of both books was compiled by I. Weckert, "Zweimal Dachau", *Sleipnir* 3(2) (1997), pp. 14-27 (online: [vho.org/D/Sleipnir/RauWe3\\_2.html](http://vho.org/D/Sleipnir/RauWe3_2.html)). Because of this article that issue of *Sleipnir* was confiscated and the publisher prosecuted, cf. *VffG* 2(1) (1998), pp. 22-36 (online: [vho.org/VffG/1998/1/Toepfer1.html](http://vho.org/VffG/1998/1/Toepfer1.html)).

<sup>22</sup> Cf. J. Bacque, *Other Losses*, Stoddart, Toronto 1989; J. Bacque, *Crimes and Mercies*, Little, Brown & Co., Toronto 1996.

### 3.2. Doctored Photos

*Photo 5a* has been repeatedly presented as proof of inhumane deportations of Jews into ghettos and extermination camps,<sup>23</sup> and has also been broadcast as such on German television.<sup>24</sup> The photo archives of the Federal Railway Administration in Hamburg, however, reveal what this picture really shows. It is a freight train crowded with German refugees bound for the Ruhr region, standing in the Hamburg train station in 1946. The unretouched original photo, *illustration 5b*, hangs in the Hamburg Main Station.<sup>25</sup> This photo shows, on the left, double-decker passenger carriages on their way to Lübeck, and on the right, parts of the Main Station buildings. Both of these elements would have allowed for the photo location to be identified as the Hamburg Main Station, and both were retouched or cut out in the doctored version. This is by no means to say that there were no deportations of Jews into ghettos or concentration camps, and it is also not meant to suggest that these transports took place only in comfortable passenger trains, although this certainly was the case particularly in the early stage of the deportations and especially as

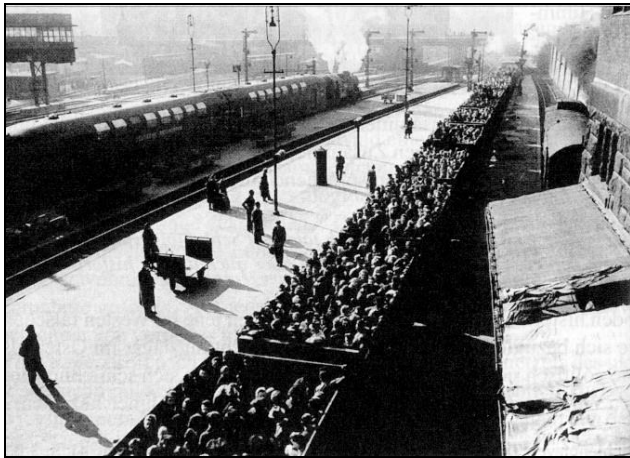

**Illustration 5b:** The original photo of the Federal Railway Administration. Its caption: "Freight trains full of refugees, 1946. Crowded freight train bound for the Ruhr region. Background, double-decker train to Lübeck."

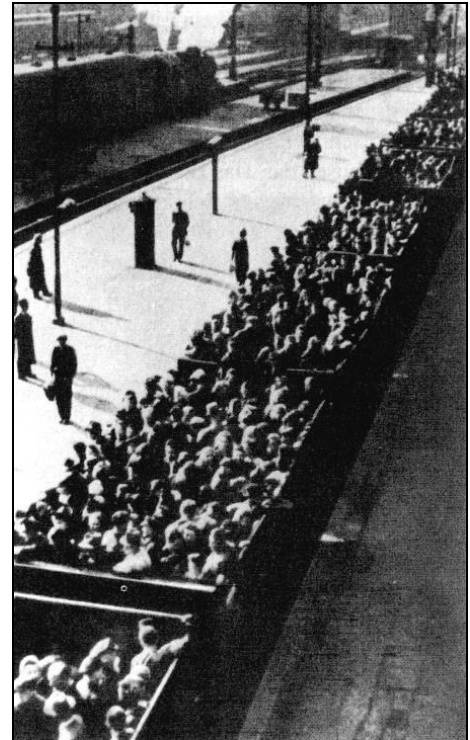

**Illustration 5a:** Retouched photograph, captioned "transports into ghettos and extermination camps", in H. Eschwege, *Kennzeichen J*, Berlin: Deutscher Verlag der Wissenschaften, 1981.

transports from western Europe are concerned.<sup>26</sup> The exposure of this forgery is only meant to urge a more skeptical approach to alleged documentary photographs.

*Illustration 6* (next page) allegedly shows a pyre with Jews killed by the Germans in the Estonia camp Klooga.<sup>27</sup> What is remarkable here, for one, is that some of the bodies stacked between the wooden beams are wearing their hats (top left). This would be possible only if the 'Nazi thugs' had glued the caps onto the heads of these corpses – or if the people lying there were not dead at all, and had put their caps on

<sup>23</sup> H. Eschwege (ed.), *Kennzeichen "J"*, Deutscher Verlag der Wissenschaften, Berlin (East) 1981, p. 185; cf. p. 173.

<sup>24</sup> *Der Tod ist ein Meister aus Deutschland*, part 3, May 2, 1990; cf. E. Gauss, *Vorlesungen über Zeitgeschichte*, Grabert, Tübingen 1993, pp. 144f. (online: [vho.org/D/vuez/v2.html](http://vho.org/D/vuez/v2.html)).

<sup>25</sup> Published as such in *Hamburger Abendblatt*, Oct. 21, 1981, p. 4; cf. G. Frey, *op. cit.* (note 5), p. 258; U. Walendy, *HT* No. 13, 1982, p. 16.

<sup>26</sup> Some of the best known eyewitness accounts regarding these comfortable passenger trains for deported Jews on their way to eastern camps can be seen in C. Lanzmann's documentation film *Shoah*.

<sup>27</sup> Downloaded from: [www.nizkor.org/ftp.cgi/orgs/german/einsatzgruppen/images/eg-06.jpg](http://www.nizkor.org/ftp.cgi/orgs/german/einsatzgruppen/images/eg-06.jpg); source given: George St. George, *The Road To Baby-Yar*, Spearman, London 1967, pp. 64f.

by themselves after getting into the position shown. The latter possibility is supported by the fact that the people depicted in this photo show not even the slightest sign of rigor mortis: their limbs are perfectly adjusted to their new position on the pyre; see for example the arms of the man at bottom left, or the arm of the man at top right. In fact, what we have here is not only a mis-captioned photo, but one that probably has also been



**Illustration 6:** Allegedly corpses of murdered Jews to be burned on a pyre.<sup>27</sup>

cropped. Off towards the side, a photo of the same scenery, but a different perspective, shows people in Soviet uniforms, and their smug grins at this posed scene are clearly visible. There exist at least seven different photos of this scene, all off them showing men with hats, but without any sign of rigor mortis, as J. Kuras has shown.<sup>28</sup>

*Illustration group 7* really needs no further comment.<sup>29</sup> Depending on which version one looks at, it is alleged to show the Munich Jew Dr. S(p)iegel (or, alternatively, A. Schwartz) who asked the police for protection in 1933 but was instead supplied with a poster, deprived of shoes, socks and trousers, and paraded through the city center. Other sources claim that this is a scene from the so-called Reichskristallnacht, *i.e.*, from the night of November 9, 1938 (since when is there broad daylight at night?). Since violent assaults against Jews hardly ever occurred before the so-called Reichskristallnacht, – even if Allied propaganda suggested this<sup>30</sup> – the allegations about an origin of this picture prior to this date seems rather unlikely.

Despite intensive research it has not yet been possible to learn the true identity of this man. It was determined that in 1979 a Jew known as Dr. Michael Siegel, holder of the *Bundesverdienstkreuz* (the Order of the Federal Republic of Germany), passed away at his home in Peru, but no one has yet been able to provide the public with a photo of him.<sup>31</sup>



**Illustration Group 7:** three examples of a broad variation.

<sup>28</sup> J. Kuras, “*Gestellte sowjetische Scheiterhaufen-Bilder*”, *VffG* 3(3) (1999) (online: [vho.org/VffG/1999/3/Kuras3.html](http://vho.org/VffG/1999/3/Kuras3.html)).

<sup>29</sup> For even more versions of this photo and the many individual sources, cf. U. Walendy, *Bild-“Dokumente”* ..., *op. cit.* (note 4), p. 68; U. Walendy, *HT* No. 34, 1988, pp. 38ff.; U. Walendy, *HT* No. 38, 1989, pp. 31ff.

<sup>30</sup> The German historian A. Schickel published a fine article about the hysteria and false propaganda by western media in the early years of the NS-Government in Germany: “*Notizen zur Zeit*”, in *Freiheitliche Akademie der FPÖ* (ed.), *Freiheit und Verantwortung*, Jahrbuch, publ. by ed., Vienna 1995; cf. “*The Jews under the Nazis: Public Perception and Reality*”, in Anglo-Hebrew Publishing (ed.), *Holocaust Denial: New Nazi Lie or New Inquisition?*, InfoText, 93c Venner Road, Sydenham, London SE26 5HU, n.d., pp. 17-22.

<sup>31</sup> U. Walendy, *HT* No. 38, pp. 31ff.

The photos on which the picture is based have obviously been greatly retouched, which is revealed not only by the ever-changing text on the poster but also by the surreal and out-of-focus lower half of Mr. S(p)iegel/Schwartz.

*Illustration 8* is an interesting caricature that looks astonishingly like *illustration group 7*; it had already been published in 1935, but it was not claimed to be based on a real photograph.<sup>32</sup> The photos shown in *illustration group 7*, on the other hand, were published one by one after the war. This begs the interesting question: what came first, the cartoon or the photo? Could it possibly be a complete fake? Grounds enough for speculation.

According to the news magazine *Spiegel*, *illustrations 9a and b* show a concentration camp guard with his victims in Buchenwald. The inmates are said to have their hands tied and be hanged from trees.<sup>33</sup> Whereas *illustration 9a* looks like a photo at the first glance, the intensive contrast and the patchy and flat nature of many parts of *illustration 9b* makes it probable that this is a drawing. Look for example at the belt and pistol of the SS man, his collar and boots, or the shades of the jacket of the prisoner lying on the earth, and note especially the edge of the remarkably shapeless face of the SS man: it has a black line which must have been drawn in.

I can only urge everyone to try this for himself: go to a gym, suspend yourself from wall bars with your arms up and back, and try to keep your knees bent. I compliment you on your well-toned stomach muscles if you can hold this pose for more than a minute. Incidentally, the string with which the supposed inmates are tied to the trees appears to be amazingly strong. It cannot be rope, as ropes would be thick enough to be visible on a photo. Thus, this would seem to be a photomontage, if not a complete fake, *i.e.*, a painting. Eventually an official German authority admitted in



**Illustration 8:** caricature from the French work *Israël souviens-toi! Think of it, Israel, Israel, denke daran*, ed. by E. Varlin and published in Paris in 1935.



**Illustration 9 (a,b):** The photo at left was published in the news magazine *Spiegel* (42/1966) with the caption, "Perfect slave system in the SS-state"; at right we see a variation on this theme, captioned "SS-sadists 'prescribe' 'tree-hanging'", reproduced in H. Eschwege, *op. cit.* (Note 23), p. 266.

<sup>32</sup> E. Varlin, *Israël souviens toi! Think of it, Israel! Israel denke daran!*, E. Varlin Edition, Paris 1935; cf. U. Walendy, *HT* No. 34, 1988, p. 38.

<sup>33</sup> *Der Spiegel* No. 40, Oct. 10, 1966, p. 101; cf. H. Eschwege, *op. cit.* (note 23), p. 266.

1996 that these pictures were made by a former east German, *i.e.*, communist film producer *DEFA* in 1958.<sup>34</sup>

In early 1994, *illustrations 10 (a, b, c)* took on modern-day significance in Germany when a girl in Halle drew a swastika on herself and proceeded to lead the media, the public prosecutors and the entire left-wing German-guilt clique by the nose, in the process giving rise to massive demonstrations protesting against ‘the right-wing radicals’.<sup>35</sup>

Her idea of blaming right-wingers for (invented) criminal drawings was nothing new, as one can see from the ever-changing Stars of David on the heads and forehead of the three anonymous Jews anonymously photographed here before a completely neutral background.<sup>36</sup> Photomontage or painting?



**Illustration 10 (a):** Captioned “SS-men cut stars into Jews’ skin”, this picture appeared in *Faschismus, Getto, Massenmord*, pub. in Frankfurt/Main by the Jewish Historical Institute of Warsaw, 1960, p. 42.



**Illustration 10 (b,c):** left: detail, published in R. Neumann, *Hitler – Aufstieg und Untergang des Dritten Reichs* (op. cit. Note 36); note that the ‘stars’ have moved; right: the same picture as shown in T. Kotarbinski, *Meczenstwo walka...*, op. cit. (Note 36).

<sup>34</sup> W. Ayaß, D. Krause-Vilmar, “Mit Argumente gegen die Holocaust-Leugung”, in *Polis*, Schriftenreihe der Hessischen Landeszentrale für politische Bildung, Wiesbaden 1996, p. 22f.; referring to H. Obenaus, “Das Foto vom Baumhängen – ein Bild geht um die Welt”, in Stiftung Topographie des Terrors Berlin (ed.), *Gedenkstätten-Rundbrief* no. 68, Berlin, October 1995, pp. 3-8.

<sup>35</sup> Cf. *Welt am Sonntag*, Jan. 16, 1994, p. 1.

<sup>36</sup> Ill. a): R. Neumann, *Hitler – Aufstieg und Untergang des Dritten Reichs*, Desch, Munich 1961, p. 151; Ill. b): Jüdisches Historisches Institut Warsaw [Jewish Historical Institute of Warsaw], *Faschismus, Getto, Massenmord*, Röderberg, Frankfurt/Main 1960, p. 42; R. Neumann, H. Koppel, *The Pictorial History of the Third Reich*, Bantam Books, New York 1962, p. 148; Ill. c): T. Kotarbinski, *Meczenstwo walka, zaglada zydow W Polsce 1939-1945*, Warsaw 1960, Picture No. 38; cf. U. Walendy, *Bild-“Dokumente”* ..., op. cit. (note 4), pp. 28f.



**Illustration 11:** from R. Schnabel, *Macht ohne Moral*.



**Illustration 12:** from V. Berdych, *Mauthausen*.

According to R. Schnabel, *illustration 11* shows living inmates sitting near dead ones in concentration camp Mauthausen.<sup>37</sup> *illustration 12* is a genuine photo, a portion of which is very similar to part of *illustration 11*. It shows ill inmates sunning themselves in the Russian area of concentration camp Mauthausen.<sup>38</sup> The inmates shown correspond almost perfectly. What is noteworthy about *illustration 11* is, first of all, its lack of focus compared with the original, which makes any falsification difficult to detect. Also, it is clear that the barracks in the background at left have been completely redrawn, just as the entire right-hand portion of the picture was added. The barracks at right have a crooked window, and their shadow extends in the wrong direction.

*Illustration 13* allegedly shows the open-air cremation of victims of mass gassing in crematorium V in Birkenau, as photographed from a window of crematorium V.<sup>39</sup> And in fact the fence in the background and the forest beyond do approximate the site as it was at that time. One of the air pho-



**Illustration 13:** Shown as Document 57 by Pressac, also in the German edition *Die Krematorien von Auschwitz*, Munich: Piper, 1994.

<sup>37</sup> R. Schnabel, *Macht ohne Moral*, Röderberg, Frankfurt/Main 1957, p. 332.

<sup>38</sup> V. Berdych, *Mauthausen*, Nase Vojsko, Prague 1959, Photo Appendix No. 50; cf. U. Walendy, *Bild-„Dokumente“*..., *op. cit.* (note 4), pp. 36f.

<sup>39</sup> Internationale Föderation der Widerstandskämpfer (ed.), *Die SS-Henker und ihre Opfer*, self-pub., Vienna 1965, p. 17; J.-C. Pressac, *Auschwitz: Technique and Operation of the Gas Chambers*, Beate Klarsfeld Foundation, New York 1989, pp. 422, 424; J.-C. Pressac, *Les Crématoires d'Auschwitz, la Machinerie du meurtre de masse*, Éditions de CNRS, Paris 1993, Doc. 57; G. Schoenberner, *Der gelbe Stern*, Rütten und Loening, Hamburg 1960, p. 162.

tos available today also shows some traces of smoke at the location in question.<sup>40</sup> It is thus possible that this picture is based on a genuine photo. Some details of *illustration 13*, however, give grounds for suspicion. There is, for example, the figure standing in the left background, appearing as little more than an outline and leaning on a stick. Since all the other figures in this picture are brightly illuminated by the sun, this inexplicably dark and shapeless figure does not fit in. The shapes of the alleged corpses are also strange, especially those enlarged in *illustration 14*. Presumably, therefore, the desired ‘truth’ was given a boost here by adding bodies and workers to turn a real fire into a cremation scene. But even if the picture were genuine: what does it show? Are the bodies shown those of victims of gassing or of a typhus epidemic? Anyway, the fact that the smoke wallows along ground level shows that there is no height to a pyre and air photos show no pits.<sup>41</sup> Thus it might be that this photo simply shows the burning of lice infested clothes of inmates who died of typhus.

*Illustration Group 15 (a, b, c; next page)* is said to document the execution of Polish Jews at the edge of an open grave.<sup>42</sup> Sometimes the shooting soldier is wearing glasses, sometimes he is not; sometimes his collar patch has white edges, sometimes not. Especially in *illustration 15c* he looks as though he was cut out and pasted in. There are white outlines around his uniform, and he lacks a shadow. The men at the transition into the background also look cut-and-pasted. Try to match their legs to their bodies! This is possibly a photomontage at best, but definitely, at least, a forgery with drawn-in sections. Again, this does not prove that the Germans did not shoot people, especially partisans, after they were condemned to death, and buried them in mass graves. This certainly happened and has been documented by the Germans themselves, since this was neither illegal nor unusual during time of war.



**Illustration 14:** An enlargement of illustration 13, in G. Schoenberner, *op. cit.* (Note 39), p. 162. The left arm of the man stepping over the supposed bodies is far too long and seems to have two elbows. What is more, the bodies lying on the ground are not only in very poor focus but also anatomically impossible.

<sup>40</sup> Photo of May 31, 1944, Ref. No. RG 373 Can D 1508, exp. 3055.

<sup>41</sup> Cf. the contribution of J.C. Ball in this volume.

<sup>42</sup> Ill. a): R. Schnabel, *op. cit.* (note 37), p. 397; Ill. b): H.-A. Jacobsen and H. Dollinger (eds.), *Der Zweite Weltkrieg in Bildern und Dokumenten*, v. I, Desch, Munich 1952, p. 100; *Der Spiegel* No. 51/1966, p. 86; Ill. c): M. Dor, R. Federmann, *Das Gesicht unseres Jahrhunderts*, Econ, Düsseldorf 1960, p. 168; cf. U. Walendy, *Bild-“Dokumente”...*, *op. cit.* (note 4), pp. 40ff.



**Illustration Group 15:** Presumably showing the execution of a polish Jew at open mass grave.



**Illustration 16a:** From *history1900s.about.com/education/history1900s/library/holocaust/bleinsatz6.htm*.

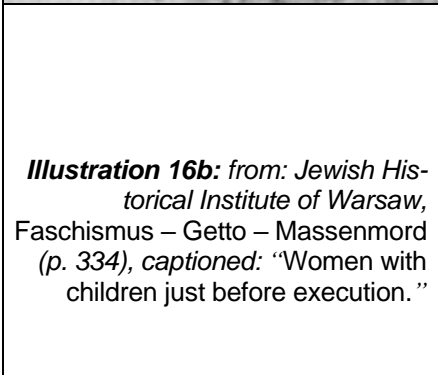

**Illustration 16b:** from: *Jewish Historical Institute of Warsaw, Faschismus – Getto – Massenmord (p. 334)*, captioned: “Women with children just before execution.”



**Illustration 16c:** from: *S. Einstein, Eichmann – Chefbuchhalter des Todes, Frankfurt/Main, 1961, p. 202*.





**Illustration Group 17:** left, from G. Schoenberner, *Der gelbe Stern*, captioned “Mass execution in Lijepaja”; right, from S. Einstein, *Eichmann – Chefbuchhalter des Todes*.

### 3.3. Total Fabrications

*Illustration Group 16* (previous page) allegedly shows naked inmates lined up outside the gas chambers of Treblinka.<sup>43</sup> From *illustration 16a* to *c* the quality sinks dramatically due to increased retouching, provided that these pictures are based on a photo. Neither the photographer nor the location is documented, and it remains a mystery how one can possibly claim that this is an execution. It could as well be that *illustration 16c* is the original picture, ie., a drawing or montage, and that the others were adopted from it by refining this painting.

The same goes for *Group 17*, purported to show naked inmates prior to mass execution in Latvia. It speaks for itself that several versions of these pictures exist.<sup>44</sup> The left one especially cannot be called a photo. At the best, it is a painting based on a photo. Compare the two women in the background who appear to have been drawn in.

*Illustration Group 18* (next page) is said to show mountains of shoes collected from inmates murdered in Auschwitz – or in Majdanek, depending on whose version one chooses.<sup>45</sup> The fuzzy background and the unrealistic, drawing-like appearance of the shoes in these pictures (especially the right version), which are alike as to the shoes shown but very different in every other respect, again suggest that this is nothing more than a drawing.

The public is often shown heaps of shoes, eyeglasses, shaving brushes, wedding rings or similar artifacts as proof of the extermination of the Jews. From a logical point of view, this evidence is just about as conclusive as the claim that the great piles of used clothing which are collected in Germany each year, for example by the Red Cross, prove that the Red Cross exterminates the German people while collecting the clothing. In fact it seems to have been largely forgotten today that due to the chronic shortage of raw materials, virtually everything was collected and recycled under the Third Reich, especially during the war. What is it to say, therefore, that the occasional genuine photo may

<sup>43</sup> Ill. a): taken from the internet: [history1900s.about.com/education/history1900s/library/holocaust/bleinsatz6.htm](http://history1900s.about.com/education/history1900s/library/holocaust/bleinsatz6.htm). G. Schoenberner reproduces it in slightly worse quality, *op. cit.* (note 39), p. 163, with the caption: “*The photographer of these women entering the gas chamber with their children in their arms is unknown.*”; Ill. b): Jüdisches Historisches Institut Warsaw (ed.), *op. cit.* (note 36), p. 334; Ill. c): S. Einstein, *Eichmann – Chefbuchhalter des Todes*, Röderberg, Frankfurt/Main 1961, p. 202; A. Donat (ed.), *The Death Camp Treblinka*, Holocaust Library, New York 1979, pp. 260f.; cf. U. Walendy, *Bild-“Dokumente”*..., *op. cit.* (note 4), pp. 14ff.

<sup>44</sup> Ill. a): S. Einstein, *op. cit.* (note 43), p. 200; Ill. b): *Der Spiegel* No. 53/1966, p. 48; G. Schoenberner, *op. cit.* (note 39), p. 97; cf. U. Walendy, *Bild-“Dokumente”*..., *op. cit.* (note 4), pp. 18ff.

<sup>45</sup> Ill. a): R. Schnabel, *op. cit.* (note 37), p. 244; Ill. b): C. Simonov, *The Lublin Extermination Camp*, Foreign Languages Publication House, Moscow 1944, p. 12; cf. U. Walendy, *Bild-“Dokumente”*..., *op. cit.* (note 4), pp. 70f.

not simply show the results of such collection drives?<sup>46</sup> It is not even out of the question that such items were collected by the Allies for purposes of precisely this sort of propaganda photo.<sup>47</sup>

This kind of ‘evidence’, which in any case is utterly unsuited to prove claims of mass murder, has a particularly tragic aspect, in that for some strange reason such collections of objects impress the average viewer as especially convincing, and ensure a fundamental feeling of consternation, as was revealed by the movie *Todesmühlen*, which was shown to the German people after the war and which contained scenes of this sort.<sup>48</sup>



**Illustration Group 18:** left, from R. Schnabel, *Macht ohne Moral*, captioned: “Thousands of shoes from murdered inmates in Auschwitz”; right, from C. Simonov, *The Lublin Extermination Camp*.

### 3.4. Movies

Shortly after the end of the war, the Americans showed this movie (*Todesmühlen*) to the German civilian population as well as to the many hundreds of thousands of German prisoners-of-war. It allegedly showed the atrocities committed in the concentration camps, and was meant to initiate the reeducation of the German people. The authenticity of the movie by no means went uncontested. For example, B. S. Chamberlin reports occasional disturbances during the screenings, but the protests were nipped in the bud, at times violently, by the deeply affected remainder of the audience.<sup>48</sup> According to contemporaneous reports, what prompted the criticism was that the (probably authentic) photos and film clips of the conditions prevailing in the German concentration camps at the end of the war were supplemented with scenes showing the mountains of dead Germans from bombed German cities, and emaciated German internees in the camps of “*automatic arrest*” – which, however, were passed off by the victors as victims of German concentration camps.<sup>49</sup>

<sup>46</sup> Cf. U. Walendy, *HT* No. 31, 1987, p. 33.

<sup>47</sup> E. Gauss, *op. cit.* (note 24), p. 21, postulates that the shoes displayed in the Auschwitz Museum had not belonged to inmates, but to the people living in the vicinity, who turned them in there after the War.

<sup>48</sup> B. S. Chamberlin, “*Todesmühlen. Ein Versuch zur Massen-‘Umerziehung’ im besetzten Deutschland 1945-1946*”, *VfZ* 29 (1981) pp. 420-436, here p. 432.

<sup>49</sup> Egon F.C. Harder, a German war veteran, told Germar Rudolf about that. Unfortunately, no written witness account about this has come to our attention yet. *Die Unabhängigen Nachrichten* No. 11 (1986), p. 11, reports that the Allies had incorporated German photos of the great heaps of dead bodies resulting from the Allied terror-bombing of Dresden into their film *Todesmühlen*, presenting these pictures as evidence for the mass murder in the concentration camps.

Since Chamberlin reports that the Occupation Authorities had trouble finding enough material to put the movie together,<sup>50</sup> it is by no means inconceivable that this was the last resort. Unfortunately these charges were never recorded in writing and documented, so that it is perforce difficult to investigate the matter today, particularly as the only generation of witnesses is gradually dying out.

A complete forgery of a film that has meanwhile been proven as such was shown by the Americans during the IMT trials. It was the cinematic record of the alleged discovery of gold teeth from murdered Jews in the Reichsbank in Frankfurt.<sup>51</sup> During the trial and in the course of the later investigations, however, it turned out that the Americans had staged this scene from beginning to end.<sup>52</sup> Where the alleged gold fillings came from and where they went is no less a mystery than is the fate of the human skins allegedly discovered in the concentration camp Buchenwald.

A more complicated matter, on the other hand, is that of the film which the Americans also showed during the IMT trials and which, like *Todesmühlen*, was also claimed to show the alleged atrocities in the concentration camps. Aside from presenting the false claim that inmates were gassed in the showers of Dachau, this movie also showed the infamous shrunken heads and the supposed artifacts made from human skins, as well as many inmates who had died of malnutrition and typhus; the movie commentary, however, was misleading.

The film that the Soviets made of the liberation of the Auschwitz camp but did not release until the mid-1980s is also liberally sprinkled with fake scenes. For example, the film shows the head of an inmate whose torso was allegedly burned on a pyre, while the head stares into the camera, eyes full of horror. If the torso had really been consumed by the fire, the head would not possibly have retained its full shock of hair, and the eyes would at least have clouded, if not burst, from the heat.

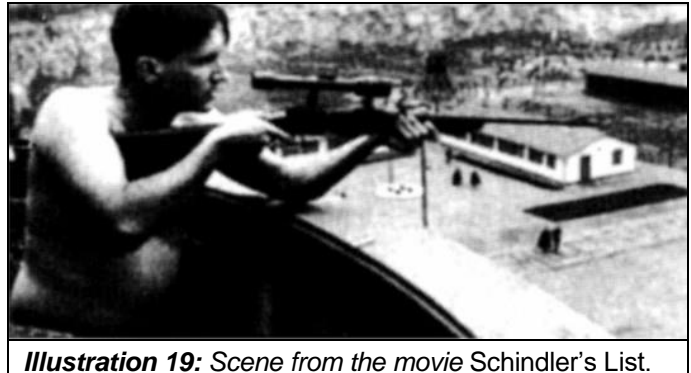

**Illustration 19:** Scene from the movie *Schindler's List*.

What strikes me as odd in this context is that no Soviet film of alleged atrocities committed by the Americans in Korea or Vietnam would ever be accepted as the truth by the western nations without a prior, thorough critical analysis, yet this film and others like it that incriminate the Third Reich are used without any second thoughts as educational material in western schools.

Feature films such as *Holocaust*, *Shoah* and *Schindler's List* are in a completely different category. They naturally have no evidential value whatsoever, but their psychological impact on the masses is immense and powerful.<sup>53</sup> Even though the establishment historians' assessment of the movie *Holocaust* – namely, that it is factually untenable – applies equally to the other movies as well, they are nevertheless gladly received for the welcome effect they have on “public education and opinion steering”!<sup>54</sup>

<sup>50</sup> B. S. Chamberlin, *op. cit.* (note 48), pp. 425f.

<sup>51</sup> International Military Tribunal, *Trial of the Major War Criminals*, IMT, Nuremberg 1947, v. XIII, pp. 169ff.

<sup>52</sup> Cf. H. Springer, *Das Schwert auf der Waage*, Vowinkel, Heidelberg 1953, pp. 178f.; P. Kleist, *Aufbruch und Sturz des Dritten Reiches*, Schütz, Göttingen 1968, p. 346; U. Walendy, *HT* No. 43, 1990, pp. 12ff.

<sup>53</sup> Regarding “*Holocaust*” cf. T. Ernst, *Aus Politik und Zeitgeschichte* 31(34) (1981) pp. 3-22, and P. Malina, *Zeitgeschichte* (ZG) (Vienna) 7 (1979/80) pp. 169-191; regarding “*Shoah*” cf. G. Botz, *ZG* 14 (1986/87) pp. 259-265; R. Faurisson, *JHR* 8(1) (1988) pp. 85-92 (online: [vho.org/GB/Journals/JHR/8/1/Faurisson85-92.html](http://vho.org/GB/Journals/JHR/8/1/Faurisson85-92.html)).

<sup>54</sup> Cf. M. Broszat, *VfZ* 27 (1979) pp. 285-298; P. Dusek, *ZG* 6 (1978/79) pp. 266-273.

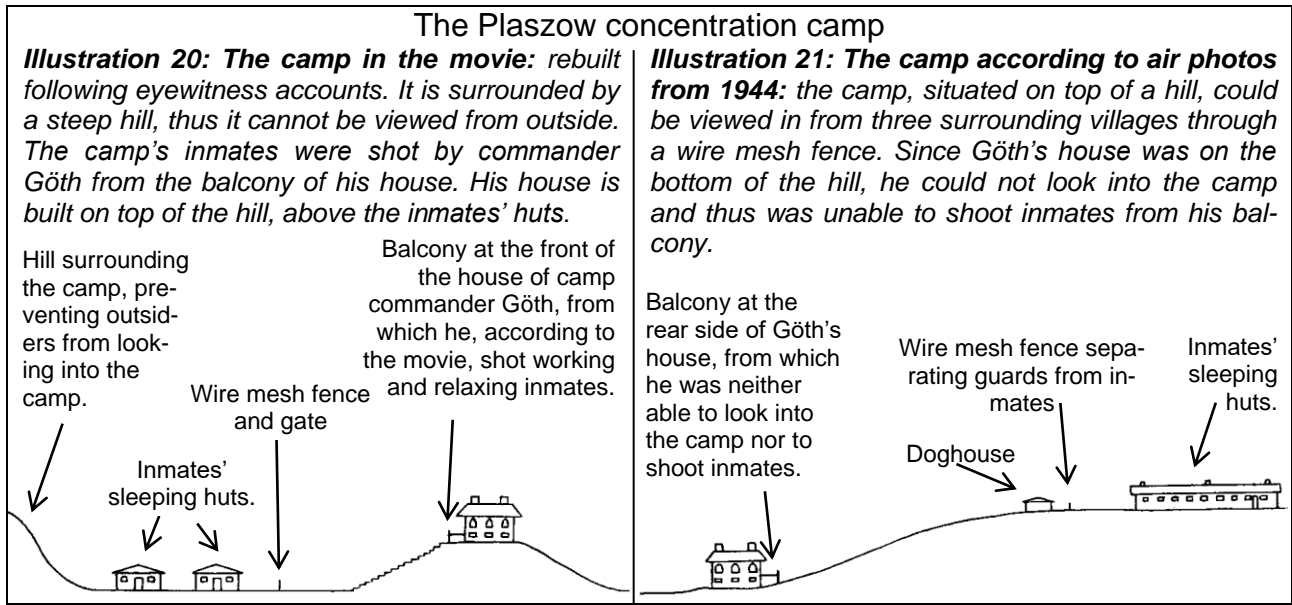

One example shall suffice to demonstrate the historically unacceptable nature of such movies. *Illustration 19* shows a scene from *Schindler's List* where Camp Commandant Göth, standing on the balcony of his house, takes random potshots at the inmates of the Plaszow Camp. Air photos from that time, however, reveal that the Commandant's house was located at the foot of a hill, while the camp itself was on top of that hill (*illustration 21*).<sup>55</sup> The scene shown in the movie, which would have required a configuration of house and camp such as shown in *illustration 20*, was thus impossible, if only for geographical reasons. And this is certainly not Steven Spielberg's sole forgery.

*Schindler's List*, which is based on a novel going back to historical events,<sup>56</sup> was deliberately filmed in black-and-white and with unsteady camera work in order to convey to the audience the false im-

<sup>55</sup> From air photos, National Archives, Washington DC, nos.: DT RL 751, Krakow, May 3, 1944; TuGx 895 A SK, exp. 382f., October 1944; J. C. Ball, *Schindler's List – Exposed as Lies and Hate*, Samisdat Publishers, Toronto 1994.

<sup>56</sup> T. Keneally, *Schindler's Ark*, Hodder & Stoughton, London 1982; simultaneously: *Schindler's List*, Simon & Schuster, New York 1982. Keneally states that he has spent two years with research on surviving Jews worldwide. Interesting regarding the first printing of the second edition, published 1993, is a passage on the copyright page: "This book is work of fiction. Names, places, and incidents are either products of the author's imagination or are used fictitiously. Any resemblance to actual events or locales or persons, living or dead, is entirely coincidental." The Library of Congress Cataloging-in-Publication Data registered this book as "fiction" (print codes 7 9 10 8 6 and 5 7 9 10 8 6). Whereas in later reprints of this second edition this passage disappears (print code 9 10 8 only whitened, later on even these empty lines were deleted: code 13 15 17 19 20 18 16 14 12), it obviously took somewhat longer, until even the cataloging information ("fiction") are removed from the book (code 15 17 19 20 18 16). In view of the fuss about Steven Spielberg's movie, it apparently was no longer opportune to categorize Keneally's book as a fiction, basing only marginally on true facts. But one should keep in mind that this above quoted passage may just have been a juridical maneuver of security in order to block approaching claims.

At the beginning of Thomas Keneally's novel entitled *Towards Asmara*, we can read: "Thomas Keneally began writing in 1964. His novels include [...] SCHINDLER'S ARK (which won the 1982 Booker Prize and has sold more copies than any other Booker prize-winner before or since)." The book was first issued in 1989 but copyrighted in 1988. This was written in 1990 on the Coronet edition (Hodder & Stoughton) of *Towards Asmara*, long before the 1982 novel was turned into a movie by Spielberg, renamed *Schindler's List*, and presented to the world audience (by the Ford Company, among others) as non-fiction, which it is not. Keneally has developed a technique of borrowing from facts to create fiction. In this book on the Erythrean guerillas, written after the author actually went to Erythrea and Sudan, he insists on disclaiming the reality of his portraits. He says: "They merely stand as the authors poor simulacra for those folk." (p. 11) The expression is good and could be extended far out beyond Keneally's figures, POOR SIMULACRA... (The last paragraph was copied from: *Le temps irréparable*, abbc.com/aaargh/fran/revu/TI97/TI971001.html)

pression that the film is a documentary; contributors to the movie have freely admitted this.<sup>57</sup> This clearly shows the intentions of the film-makers and of those who take school classes and even entire schools to see this movie, and not only in Germany and Austria. What is particularly perfidious about this film is that whenever German soldiers or SS-men give orders, yell and scream and engage in any kind of violence, this is not shown in English or in whichever other language the film is dubbed, but in German. In this way the entire world is made to feel that German is the language of cruel subhumans. And the German viewing public is the only one not to notice this, because in Germany, *Schindler's List* is dubbed entirely in German. In this way, underhanded psychological tricks incite the peoples of the world against the Germans, their language and their culture, and the Germans themselves never even notice what is going on.

Besides of this, Spielberg is hiding the fact that the commander from Plaszow concentration camp was prosecuted by the SS:<sup>58</sup>

*“Individual criminal acts – in these cases having broad implications – included: the assumption of a license to kill by commandants and subordinates concealed through falsification of medical death certificates.*

*Arbitrary conduct, chicanery, unlawful corporal punishments, acts of brutality and sadism, liquidation of no-longer-convenient accomplices, theft and black-market profiteering.*

*All of these offenses were committed both alone by prisoners as well as by personnel of the SS, most however in conspiracy between SS personnel with Kapos (Jewish concentration camp guards).*

*The intervention of SS jurisdiction in the concentration camps commenced with the initiation of my investigations in July 1943 and lasted until the conclusion of the war. It could not have started sooner, because there were no suspicions in this regard.*

*Arrested were the commandants of Buchenwald, Lublin, Warschau, Herzogenbosch, Krakau-Plaszow.”*

Spielberg certainly wished to conceal these investigations and punishment of perpetrators from his gullible movie audience since he was and is *not* interested in an historically accurate film, but rather in molding public opinion to accept the establishment Holocaust ideology. Audiences may be gullible and dumb, but Spielberg is a deceiver and denier of historical reality.

#### 4. Propaganda With Pictures: The Anti-Wehrmacht Exhibition

Since 1995 a traveling exhibition has been moving through Germany and Austria professing to show the crimes of the Wehrmacht, primarily by means of pictures.<sup>59</sup> This exhibition was sponsored by the multimillionaire Jan Philipp Reemtsma, who ever since the late 1960s has been a major source of funding for the leftist extremist and anarchist scene in Germany. The exhibition was put together by Johannes Heer, a former Communist who even today makes no bones about his sympathies for the leftist extremist scene. Essentially, the exhibition as a whole came into being through the contributions and support of people who have distinguished themselves by their leftist ideological blindness ever since the radical leftist student revolts of the late 1960s – as journalist Rüdiger Proske (once himself a member of these circles) pointed out.<sup>60</sup>

---

<sup>57</sup> *Film & TV Kameramann* No. 2/1994, pp. 24ff., esp. the statement of chief cameraman J. Kaminski, p. 27.

<sup>58</sup> Affidavit SS-65 by SS Judge Konrad Morgen, *IMT*, vol. 42, p. 556.

<sup>59</sup> Hamburger Institut für Sozialforschung (ed.), *Vernichtungskrieg. Verbrechen der Wehrmacht 1941 bis 1944*, (War of Extermination. The Crimes of the Wehrmacht, 1941 to 1945) Hamburger Edition, Hamburg 1996; English: Hamburg Institute for Social Research (ed.), *The German Army and Genocide: Crimes Against War Prisoners, Jews, and Other Civilians, 1939-1944*, The New Press, New York 1999.

<sup>60</sup> Rüdiger Proske, *Wider den Mißbrauch der Geschichte deutscher Soldaten zu politischen Zwecken*, Von Hase & Köhler, Mainz 1996; Proske, *Vom Marsch durch die Institutionen zum Krieg gegen die Wehrmacht*, *ibid.*, 1997.

On the whole, therefore, this exhibition represents a continuation of Communist and left-wing extremist disinformation whose goal it is to destroy the historical roots of the German identity while strengthening the political and cultural hegemony of its perpetrators. By forcing the political moderates to repeatedly affirm their own opposition to the “Nazi” crimes – because one would automatically make oneself suspect of Fascist leanings by doing otherwise – these leftist extremists circles attain a degree of opinion leadership and moral authority which they were unable to achieve in past decades due to the massive human rights violations committed by the left-wing extremist regimes of the Eastern Bloc.

As political scientist Professor Knütter pointed out, the goal behind this concept is to break up the former values system and thus to create an ideological vacuum, in which Socialist, anarchist and Communist teachings of salvation will ultimately find fertile ground. This process, he states, is augmented by the parallel process of replacing the German people with a multicultural mixture, devoid of any identity but full of revolutionary potential due to the inevitable conflicts and the concomitant social and economic problems.<sup>61</sup>

Now this political background must certainly not be used as an excuse to dismiss the photos shown by the exhibitors as pure propaganda. Several academic investigations of the question of how this exhibition was put together by von Reemtsma and Heer have shown that most (218 of a total of 314) of the pictures, which originated primarily in archives in Moscow and Minsk, are devoid of any information as to their source.<sup>62</sup> In other words, there is no clue as to who took the pictures when and where, and what exactly they show. It is interesting to note, by the way, that the pictures presented as evidence for National Socialist crimes were generally taken from books or archives of the nations belonging to the then-Communist Eastern Bloc, which always had a massive vested interest in the exaggeration and exploitation of (actual or merely alleged) National Socialist crimes.<sup>63</sup> W. Strauß has shown that the originator of many known photos was Yevgeny Ananievich Khaldei, the

“[...] most highly decorated army photographer of the news agency TASS [...], working, as of June 1941, not directly at the front but in the hinterland or the re-captured areas; a celebrated star reporter of the personality cult who after 1945 was rewarded for bravery and skill by being commissioned to portray those in power in the Soviet Union, including Stalin.

*Khaldei's brilliant touch consisted of introducing altered photos into the Soviet and international public as original snapshots, and of collecting rubles and Stalin Prizes for it.*”<sup>64</sup>

It is a telling point that such pictures devoid of any information as to their source are uncritically displayed by the exhibitors, and that these exhibitors have not shown themselves willing to change their methods even after massive public criticism of this shortcoming.

Germany's second-largest weekly magazine, *Focus*, repeatedly attacked the exhibition for mis-captioning the pictures displayed, and charged those responsible with falsifications and lies, since after all they had alleged that one picture actually showing Jews getting undressed for a bath was

<sup>61</sup> Hans-Helmuth Knütter, *Die Faschismus-Keule*, Ullstein, Frankfurt/Main 1993.

<sup>62</sup> Wolf Stoecker, “Fälschung und Agitation. Kritische Bemerkungen zur Ausstellung ‘Vernichtungskrieg, Verbrechen der Wehrmacht 1941 bis 1944.’”, in Joachim F. Weber (ed.), *Armee im Kreuzfeuer*, Universitas, Munich 1997 (online: [vho.org/D/aik/aik.html](http://vho.org/D/aik/aik.html)).

<sup>63</sup> Cf. also the authors quoted in this chapter: Bergschicker, *East Berlin*; Eschwege, *East Berlin*; Jüd. Hist. Museum, Warsaw; Kotarbinski, Warsaw; Simonov, Moscow; many of the books quoted in this chapter – many of them by decidedly leftist-radical authors, and published by far-leftist or even communist publishers – come from these sources: Neumann, Desch; Schnabel, Röderberg; Schoenberger; Rütten & Löning; Jacobsen & Dollinger, Desch; Dor & Federmann, Forum (Vienna); Einstein, Röderberg.

<sup>64</sup> W. Strauß, “*Es war einmal ein Fotograf*”, *Staatsbriefe* 8(11-12) (1997), pp. 6f. (online: [vho.org/D/Staatsbriefe/Strauss2\\_8\\_11\\_12.html](http://vho.org/D/Staatsbriefe/Strauss2_8_11_12.html))

the “*scene of a mass execution*”, had touted another picture whose contents were unclear as a “*Wehrmacht crime*”, and had refused to correct these misrepresentations even after their error had been proved.<sup>65</sup> The interesting thing about the first case is that the exhibitors had taken the false caption from a book<sup>66</sup> whose co-editor is Willy Dreßen, today the Head of the Central Office of the Provincial Judicial Administrations in Ludwigsburg, a man who is also in charge of the prosecution of alleged National Socialist crimes. Even though Dreßen, who had already been working in the Central Office at the time of the book’s publication, should have been aware of the actual events, he supported the mis-captioning. Admittedly this comes as no surprise to those ‘in the know’, since after all the ideological ties between the professional ‘Nazi hunters’ in the Central Office and the radical left-wing, professional anti-Fascists have always been close.

Let us examine only one picture in more detail which is publicly paraded time and again as proof of the crimes of the Wehrmacht. *Illustration 22* shows the execution of partisans in front of the cemetery wall of the Serbian village Pančewo. This picture is also displayed as part of the anti-Wehrmacht exhibition. This execution was even filmed by a German war reporter. The film was shown on German television in April 1997 as proof of the crimes committed by the Wehrmacht.<sup>68</sup> Now it is already unlikely that the military officials in charge would have allowed a reporter to document a war crime openly and in such detail (and the same, of course, goes for all such documents). What the anti-Wehrmacht exhibition as well as the television broadcast hushed up, however, is the fact that the picture actually shows the enforcement of a verdict passed by a regular German court-martial against partisans who had been sentenced to death for murderous attacks on German soldiers. Therefore, under the martial law in effect both in those days *and today*, this execution is not a crime, but rather a permissible judicial means of war. The event is admittedly cruel, but after all that is the central characteristic of any war. Hence, the crime is not to be sought in the execution, but in the reasons that led to that war.

In Germany the debate about the anti-Wehrmacht exhibition, clearly conducted with left-wing extremist aims, has resulted not only in exposing the network of leftist ideologists in Germany who have virtually monopolized the historiography of the Third Reich for themselves.<sup>60</sup> Another consequence has been that contemporary historians are prepared, for the first time in over 50 years, to critically analyze and question the authenticity of documents that purport to prove alleged National Socialist crimes. In this context, special mention must go to Professor Dr. Dr. Klaus Sojka who has subjected the pictures of Reemtsma’s exhibit to a detailed and devastating critique by supplementing these pictures with many others and analyzing them comprehensively from the perspective of document criticism.<sup>69</sup> Prof. Franz W. Seidler has set a sort of counterpoint to this entire debate by publishing the only recently rediscovered files of



**Illustration 22:** Execution of partisans in Pančewo (Serbia), falsely portrayed as a crime.<sup>67</sup>

<sup>65</sup> *Focus*, No. 16 & 17/1997, 6/1998.

<sup>66</sup> E. Klee, W. Dreßen, V. Rieß (ed.), “*Schöne Zeiten*”, *Judenmord aus der Sicht der Täter und Gaffer*, S. Fischer, Frankfurt/Main 1988, p. 77.

<sup>67</sup> Hamburger Institut für Sozialforschung (ed.), *op. cit.* (note 59), p. 30.

<sup>68</sup> *Focus-TV*, Pro7, 13.4.1997; cf. *Abendzeitung* (Munich), 4.4.1997.

<sup>69</sup> Klaus Sojka (ed.), *Die Wahrheit über die Wehrmacht. Reemtsmas Fälschungen widerlegt*, FZ-Verlag, Munich 1998, pp. 90f. To date this book is the scientific high point in the debate over alleged photo documentation of German crimes, and is therefore a must for anyone interested in the topic.

the Wehrmacht War Crimes Bureau<sup>70</sup> which documented, with great care and in detail, the crimes that were committed against German soldiers during the eastern campaign:

*“This book is a response to the exhibition ‘War of Extermination. The Crimes of the Wehrmacht, 1941 to 1945’ [...].*

*Unlike the anti-Wehrmacht exhibition, this documentation of Soviet wartime atrocities leaves no room for fabrications, misleading text and arbitrary allegations. – All events are documented. – Information regarding places and dates is unequivocal. – The pictures are not private photos, but legal and medical evidence. – The text documents have not been altered. – Most documents are supported by further evidence which researchers can examine. – The wording of the text documents can be verified in the Federal Archives / Military Archives in Freiburg under shelf mark RW 2/v.147-v.152.”<sup>71</sup>*



**Illustration 23:** Russian cannibalism of captured German soldiers in autumn 1941: “Disemboweled corpses in Camp 2 of Stalag 305”. Photo document re. Case 304, F. W. Seidler, *op. cit.*, p. 363.

Indeed some of the crimes described are enough to make a reader’s blood run cold; for example, the many photos documenting cases of Russian cannibalism of German soldiers, cf. *illustration 23*. It takes such documentation to really drive home the point what a dirty war the barbaric attitude of Stalin and his comrades forced the Germans to fight.<sup>72</sup>

A particularly interesting reply was made by the young historian Walter Post, whose account reveals revisionist tendencies in many respects, and concludes in a sort of bottom-line:

*“In an essay in the book accompanying the exhibition ‘War of Extermination. The Crimes of the Wehrmacht’, Alfred Streim [Public Prosecutor with the Central Office of Provincial Justice Administrations in Ludwigsburg] stated that ever since the Central Office was established in 1958, some 3,000 preliminary proceedings have been instituted in the Federal Republic of Germany against members of the Wehrmacht – in other words, 3,000 Wehrmacht soldiers were suspected of having participated in National Socialist or war crimes.*

*If one considers that approximately 18 million men and women belonged to the Wehrmacht, then 3,000 accused constitute 0.017% of the entire personnel. Even if one assumes, absolutely hypothetically, that there was a very high 90% rate of unreported or undetected cases, and thus a total of 30,000 potential suspects, this still amounts to only 0.17%. Incidentally, of the 3,000 preliminary proceedings in the Federal Republic of Germany, only two(!) have resulted in a conviction. In the former German Democratic Republic there has been a total of eight convictions of former members of the Wehrmacht.*

*Thus, quantitative studies also show that the legend of the ‘decent Wehrmacht’ is not necessarily a legend.”<sup>73</sup>*

<sup>70</sup> Cf. A.M. de Zayas, *Die Wehrmachtsuntersuchungsstelle*, 4<sup>th</sup> ed., Ullstein, Frankfurt/Main/Berlin 1984.

<sup>71</sup> Franz W. Seidler, *Verbrechen an der Wehrmacht*, Pour le Mérite, Selent 1998, pp. 5f.

<sup>72</sup> Cf. also J. Hoffmann, *Stalin’s War of Extermination 1941 – 1945*, Theses & Dissertations Press, Capshaw, AL, 2001.

<sup>73</sup> W. Post, “Die Wehrmacht im Zweiten Weltkrieg. Armee zwischen Regime und totem Krieg”, in Joachim F. Weber (ed.), *op.cit.* (note 62) (online: [vho.org/D/aik/Post.html](http://vho.org/D/aik/Post.html))



Finally, in late 1999, shortly before this exhibition was to go to America, it was temporarily canceled, after three scholars proved in detailed studies that most of the pictures were mis-captioned, only 10% of them (allegedly) showing crimes. Some of the exhibits actually show victims of mass murder committed by the Soviet NKVD.<sup>74</sup> Consequently, Johannes Heer lost his position as head of this exhibition, and some of the most renowned German historians recommended phasing it out without replacement.<sup>75</sup> In a thorough study, Walter Post demonstrated recently that this exhibition is not just trying to substantiate the ‘right’ hypothesis (“*War of Extermination. The Crimes of the Wehrmacht*”) with some wrong photos, as some historians assert, but rather that the hypothesis itself is massively flawed.<sup>76</sup>

These writings seem to have broken a spell that has paralyzed German historiography for more than 50 years and prevented historians from fulfilling their foremost duty, namely to subject their sources to critical analysis. All in all, therefore, and speaking not only from an academic perspective, Reemtsma’s exhibition has turned out to be a disaster that would be hard to surpass.

## 5. Addendum

Time and again, some major newspapers or other media reveal forgeries, for example the photomontage of the allegedly burning synagogue in Berlin-Oranienburger Straße. This photo is one of the most widely spread pictures regarding the 1938 November pogroms in Germany against the Jews. There is no doubt that arson against several synagogues in Germany did occur at that time, but since obviously no really good photo could be presented for this, it was decided by unknown people short time after the war to manipulate a photo, taken in 1948, of the well known synagogue in Berlin-Oranienburger Straße. Already in 1990, the author Heinz Knobloch claimed to have proved this fabrication,<sup>77</sup> but he could not tell who the culprit was. It remained so until 1998 when a certain Kurt Wernicke revealed the culprit. According to information he obtained from a former exhibition expert, the original photo was probably manipulated by Klaus Wittkugel, a former expert for photomontages (*illustration 24*).<sup>78</sup>

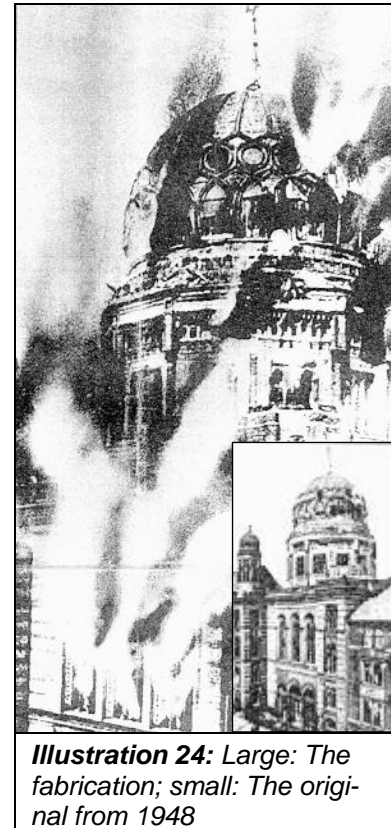

**Illustration 24:** Large: The fabrication; small: The original from 1948

<sup>74</sup> Bogdan Musial, “*Bilder einer Ausstellung. Kritische Anmerkungen zur Wanderausstellung ‘Vernichtungskrieg. Verbrechen der Wehrmacht 1941-1944’*”, *Vierteljahrshefte für Zeitgeschichte*, 47(4) (1999), pp. 563-591; cf. Bogdan Musial, “*Konterrevolutionäre Elemente sind zu erschießen*”, *Frankfurter Allgemeine Zeitung*, Oct. 30, 1999, p. 11; Krisztián Ungváry, “*Echte Bilder - problematische Aussagen*”, *Geschichte in Wissenschaft und Unterricht*, 50(10), (1999), pp. 584-595; cf. Krisztián Ungváry, “*Reemtsmas Legenden*”, *Frankfurter Allgemeine Zeitung*, Nov. 5, 1999, p. 41; Dieter Schmidt-Neuhaus, “*Die Tarnopol-Stellwand der Wanderausstellung ‘Vernichtungskrieg – Verbrechen der Wehrmacht 1941 bis 1944’*”, *ibid.*, pp. 596-603.

<sup>75</sup> E.g., Klaus Hildebrandt, Hans-Peter Schwarz, Lothar Gall, cf. “*Kritiker fordern engültige Schließung*”, *Frankfurter Allgemeine Zeitung*, Nov. 6, 1999, p. 4; Ralf Georg Reuth, “*Endgültiges Aus für Reemtsma-Schau?*”, *Welt am Sonntag*, Nov. 7, 1999, p. 14.

<sup>76</sup> Walter Post, *Die verleumdete Armee*, Pour le Mérite, Selent 1999.

<sup>77</sup> Heinz Knobloch, *Der beherrzte Reviervorsteher. Ungewöhnliche Zivilcourage am Hackeschen Markt*, Morgenbuch-Verlag, Berlin 1990.

<sup>78</sup> *Berliner Morgenpost*, Oct. 10, 1998, p. 9.

In 1999, the Simon Wiesenthal Center published *illustration 25b*. on their website with the following caption:<sup>79</sup>

»As these prisoners were being processed for slave labor, many of their friends and families were being gassed and burned in the ovens in the crematoria. The smoke can be seen in the background.«

No smoke can be seen on the original photo, which was taken in Birkenau concentration camp in spring 1944 (*illustration 25a*).<sup>80</sup> Apparently, Holocaust propagandists, second generation, can accomplish with current computer software technology what their



**Illustration 25a and b:** Left the original, right the forgery of the Simon Wiesenthal Center: Smoke coming out of a fence post.

predecessors could only imagine. With a little ‘photoshop’ help, any document can be made to confirm to whatever an ‘eyewitness’ wants it to. In this case, the smoking chimneys. (Un)Fortunately they chose a fence post instead of a chimney as a source for the drawn-in ‘smoke’.

No thorough research is being done regarding the question: Are these photographs allegedly proving the National Socialist persecution of the Jews authentic? After 55 years, this question goes unanswered and will continue to remain so in light of the fact that scholars who are doing such research are being persecuted. Nevertheless some fabrications are revealed more or less incidentally: is that not reason enough to be more than a skeptic regarding the authenticity of these photos all together?

## 6. Instead of a Conclusion: Some Lesser Known but Genuine Photos

Finally, it should be noted that it is well documented and widely accepted that US soldiers made souvenirs from bones of killed Japanese soldiers (*illustration 26*, next page), a crime they apparently were proud of and a crime that was never proven to have been committed by German soldiers.<sup>81</sup>

*Illustration Group 27* (page 267) shows victims of the Holocaust of German civilians in the residential sections of German cities that were deliberately bombed by the Allies.<sup>82</sup> Altogether, some one million innocent Germans, mostly children, women and elderly people, died like this as a result of Allied terror-bombing in Germany.<sup>83</sup> There is a world of difference between these photos and those of emaciated victims of starvation and typhus in German concentration camps.

<sup>79</sup> <http://motlc.wiesenthal.com/gallery/pg22/pg0/pg22035.html>; cf. *VffG* 3(2) (1999), p. 240. We have saved the entire page at [vho.org/News/D/SWCForgery.html](http://vho.org/News/D/SWCForgery.html), should the SWC remove it.

<sup>80</sup> S. Klarsfeld, *The Auschwitz Album*, Beate Klarsfeld Foundation, New York 1978, no. 165.

<sup>81</sup> John W. Dower, *War without Mercy*, Pantheon Books, New York 1986; cf. E.L. Jones, *The Atlantic Monthly*, Februar 1946, pp. 48-53, here pp. 49f.; cf. U. Walendy, *Historische Tatsachen*, no. 68: “US-Amerikanische Kriegsverbrechen” (US-American War Crimes), Verlag für Volkstum und Zeitgeschichtsforschung, Vlotho 1995) and more recently: *Alliierte Kriegsverbrechen und Verbrechen gegen die Menschlichkeit* (Allied War Crimes and Crimes Against Humanity), 2<sup>nd</sup> ed., Arndt, Kiel 1997.

<sup>82</sup> Morale Division, U. S. Strategic Bombing Survey, Medical Branch Report, *The Effect of Bombing on Health and Medical Care in Germany*, War Department, Washington, D.C., 1945, pp. 17, 21, 23. We are grateful to F. P. Berg for providing this reference.

<sup>83</sup> Cf. D. Irving, *Und Deutschlands Städte starben nicht*, Weltbild Verlag, Augsburg 1989, p. 373; cf. M. Czesany, *Europa im Bombenkrieg 1939-1945*, Leopold Stocker, Vienna 1998.

As Prof. Robert Faurisson put it in 1992,<sup>84</sup> the main difference between the victims of German POW and concentration camps and the German victims of Allied air raids and the post-war atrocities committed by Allied forces and authorities of the liberated nations is that the prisoners in German camps *died mainly because of the collapse of the German infrastructure due to the war*, whereas the Germans were *killed en masse* by the Allied and the ‘liberated’ nations, *i.e.*, the Serbs, the Czechs, and the Poles. Thus, the real Holocaust happened in German cities during the war and all over Germany after the war.



Arizona war worker writes her Navy boyfriend a thank-you note for the Jap skull he sent her

**Illustration 26:** Life magazine, May 22, 1944, p. 34f.: “Picture of the week. When he said good bye two years ago to Natalie Nickerison, 20, a war worker of Phoenix, Ariz., a big, handsome Navy lieutenant promised her a Jap. Last week Natalie received a human skull, autographed by her lieutenant and 13 friends, and inscribed: ‘This is a good Jap – a dead one picked up on the New Guinea beach.’ Natalie, surprised at the gift, named it Tojo. The armed forces disapprove strongly of this sort of thing”.

*Disapprove? Punishing Americans for war crimes would have been more appropriate!*

<sup>84</sup> R. Faurisson, “La leçon des photographie”, *Révue d'Histoire Révisionniste*, no. 6. May 1992, p. 62-68.

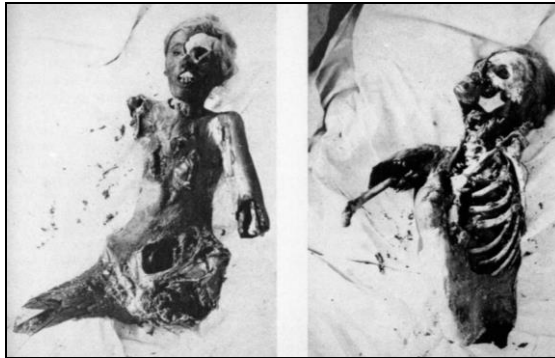

**Illustration Group 27:** German civilian victims of Allied bombing attacks. Payload dropped: 2,767,000 tons. Only a few cases of roughly one million German Holocaust victims. One tends to forget that the fate of the normal Germans, soldiers and civilians, was sometimes even worse than that of the hundreds of thousands of inmates in POW and concentration camps.

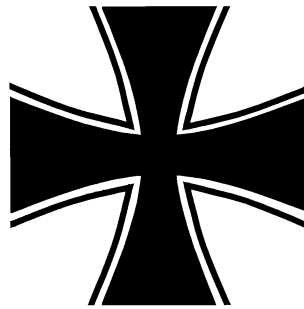

1939 – 1945





# Air Photo Evidence

JOHN CLIVE BALL

## 1. Introduction

During the 1930s German scientists and engineers pioneered aerial photography and developed it to high technological standards which the Allies did not attain until World War Two. During the Second World War German reconnaissance fliers took millions of photos of the contested areas as well as of areas in enemy territory. After the war these photos fell into American hands, and have been stored in the National Archives Air Photo Library in Alexandria, Virginia, ever since. The Soviets, British and Americans also took air photos of Germany and the German-occupied territories as of late 1943. This chapter shall examine a few of these photos to see what they can reveal about the events alleged to have taken place at certain sites in connection with the 'Final Solution' of the 'Jewish Question'.

## 2. Technique of Air Photo Interpretation

The correct interpretation of an air photo depends not only on the expertise of the interpreter, but also on the resolution of the photo and on the sharpness of its focus, in other words, on the quality of the cameras, films and the photographing technique (*e.g.*, compensation for the motion of the airplane). The technique of stereoscopy in particular has effected great improvements in air photo interpretation. In this technique, two photos of the same area are taken in rapid succession. Due to the motion of the airplane, the angle at which the photos are taken will have changed somewhat in this brief time. If these two slightly different photos are then viewed through a stereoscope, one picture with each eye, the result is a three-dimensional effect that allows for the easy differentiation between raised and flat objects on the ground.<sup>1</sup>

## 3. Air Photo Archeology

Air photo archeology was used as early as 1938 to locate the sites of medieval, ancient or even Stone Age settlements.<sup>2</sup> An element of vital importance to the discovery of ancient, extinct settlements is the fact that the remnants of these settlements – remnants which are generally sub-surface, *i.e.*, underground today – are indicated by slight changes in topography, or even in the vegetation on the earth's surface. These minute differences can be made very clearly visible from great elevations. If, on the other hand, larger-scale disruptions of the soil involving disturbances of the vegetation and the nature of the soil date back only a few months, these changes are very easy to discern on air photos even if these disturbances have been covered up so as to prevent detection on ground level.

---

<sup>1</sup> Due to the photomechanical reproduction process, some of the pictures shown in this chapter are unfortunately of considerably poorer quality than the originals, so that they no longer show all the details which are clearly visible on the original exposures. Online documents are available at: [www.air-photo.com/](http://www.air-photo.com/).

<sup>2</sup> Cf. O. G. S. Crawford, "Luftbildaufnahmen von archäologischen Bodendenkmälern in England", in *Luftbild und Luftbildmessung* No. 16, Hansa Luftbild, Berlin 1938, pp. 9-18; cf. also J. Dassié, *Manuel d'archéologie aérienne*, Editions Technique, Paris 1978; L. Deuel, *Flug ins Gestern – Das Abenteuer der Luftbildarchäologie*, C. H. Beck, Munich 1977.

## 4. Mass Graves

### 4.1. Hamburg, Katyn, and Bergen-Belsen<sup>3</sup>

The Allied bombing of Hamburg in late July 1943 – “*Operation Gomorrah*”, as the British called it – claimed more than 100,000 lives. Some 40,000 of these victims were buried in the Ohlsdorf cemetery, in four mass graves of 10,000 bodies each.<sup>4</sup> Each of the graves is some 130 m long, 16 m wide and approximately 3.5 m deep (426ft. × 52ft. × 12 ft.).

In spring of 1940 the Soviets shot about 25,000 Polish officers and intellectuals in a forest near Katyn and at other locations in eastern Poland, and buried them in a number of mass graves.<sup>5</sup> In 1943 some of them were discovered by the Germans, and investigated by an international delegation. The graves found, containing more than 4,100 bodies, covered a total area of 96 m × 6 m and were roughly 3.5 m deep (315ft. × 20ft. × 12 ft.).

In early 1945 the British established four mass graves near the former concentration camp Bergen-Belsen, to accommodate the countless typhus victims from that camp which had been dreadfully overcrowded near the war’s end.<sup>6</sup> These graves measured about 20 m × 7 m × 3.5 m (66 ft. × 23 ft. × 12 ft.) each and contained some 1,000 bodies each.

As we can see, these graves mentioned above held approximately 1 to 2.5 bodies per cubic meter (1 to 2.5 per approximately 35 cu.ft.). Under realistic conditions, the maximum possible density would be roughly 8 bodies per cubic meter (10 per 44 cu.ft.), where the top vertical 1 m (3 ft.) of the grave consists only of a covering soil layer – meaning that, for a grave 3.5 m (12 ft.) deep, the greatest possible gross density is about 6 bodies per m<sup>3</sup> (6 per approximately 35 cu.ft.). Thus, the mass graves of Katyn, Hamburg and Bergen-Belsen were not even filled to their maximum capacity.

In estimating the surface area required for mass graves, it must be kept in mind that the soil excavated takes up a greater volume than the graves themselves do, due to the loosening of the soil. What is more, the material excavated can be piled up only so steeply. Postulating, for example, rectangular graves of 15 m (50 ft.) width, and allowing 15 m (50 ft.) of space beside each grave to accommodate the excavated material – *i.e.*, 15 m + 15 m, or 50 + 50 ft. breadth per grave (in fact a much too conservative estimate) – then for an excavation depth of 3.5 m (about 12 ft.) and a gross density of 6 bodies per m<sup>3</sup> (roughly 6 per 35 cu.ft.) the minimum surface area required for mass graves for a given number of bodies is indicated in Table 1.

Table 1: Surface Area Requirements for Mass Graves

# BODIES	SURFACE AREA NEEDED	
1,000	10 m × (5+5) m	= 100 m <sup>2</sup> (≅ 1,080 sq.ft.)
10,000	50 m × (10+10) m	= 1,000 m <sup>2</sup> (≅ 10,800 sq.ft.)
25,000	83 m × (15+15) m	= 2,500 m <sup>2</sup> (≅ 26,900 sq.ft.)
100,000	4 × 83 m × (15+15) m	= 10,000 m <sup>2</sup> (≅ 108,000 sq.ft.)
1,000,000	16 × 210 m × (15+15) m	= 100,000 m <sup>2</sup> = 0.1 km <sup>2</sup> (≅ 1,080,000 sq.ft. ≅ 25 acres)

<sup>3</sup> For the air photos the reader is referred to my report: J. C. Ball, *Air Photo Evidence*, Ball Resource Services Ltd., Suite 160-7231, 120th St., Delta, BC, Canada, V4C 6P5, 1992.

<sup>4</sup> M. Caidin, *The Night Hamburg Died*, Ballantine Books, New York 1960; M. Middlebrook, *The Battle of Hamburg*, McMillan, London 1980; D. Irving, *Und Deutschlands Städte starben nicht*, Schweizer Verlagshaus, Zürich 1967; regarding some photos of the victims of this Holocaust against the Germans see the contribution of Udo Walendy in this volume.

<sup>5</sup> F. Kadell, *Die Katyn-Lüge*, Herbig, Munich 1991; J. Lauck, *Katyn Killings: In the Record*, Kingston Press, Clifton, NJ, 1974; 2<sup>nd</sup> ed.: *ibid.* 1988; A. Paul, *Katyn, The Untold Story of Stalin’s Polish Massacre*, Charles Scribner’s Sons, New York 1989; 2<sup>nd</sup> ed., 1991; W. Anders, *The Crimes of Katyn, Facts and Documents*, Polish Cultural Foundation, London 1965.

<sup>6</sup> S. Bloch, *Holocaust and Rebirth: Surviving Bergen Belsen*, Holocaust Library, New York 1972.



*Illustration 2: Air photo of concentration camp Treblinka B of November 1944.*



*Illustration 1: Air photo of concentration camp Treblinka B of May 15, 1944.*



## 4.2. Mass Graves in So-Called Extermination Camps

### 4.2.1. Treblinka

*Illustration 1* shows an air photo of the Treblinka B camp, taken on May 15, 1944.<sup>7</sup> This is the place where, according to the standard literature, 700,000 to 1.2 million people were killed, buried in the southeastern corner of the camp, later dug up again and burned – all between mid-1942 and autumn of 1943.<sup>8</sup> The camp was demolished in late 1943.<sup>9</sup>

This and other photos<sup>3</sup> reveal the following:

- the surrounding land was cultivated right up to the edge of the camp;
- by virtue of the flat, treeless landscape it was possible to see right into the camp from the fields, as well as from the road running northeastward and from the town of Wolka Okraglik, only half a mile away;
- the place in the southeast area of the camp which the witnesses describe as the location of the mass graves is less than 10,000 m<sup>2</sup> (108,000 sq.ft.) in area. Therefore no more than 100,000 bodies could have been buried there. Mass graves for about 1,000,000 bodies would have required an area roughly equal to that of the entire camp (about 25 acres);

*Illustration 2* shows an air photo from November 1944.<sup>10</sup> Here the area is overgrown fairly uniformly with vegetation (grass, weeds). We can see that:

- except in the northernmost areas, there are no signs of any remnants of building foundations. Even if these had been removed, the vegetation would not grow as well over these areas. The massive concrete gas chamber buildings attested to by witnesses were not present here; at most, there may have been temporary barracks without stone or concrete foundations;
- large-scale movements of the soil and mass cremations in the southeastern part of the camp would have resulted in poorer growth of vegetation there than elsewhere in the camp, due to the destruction of the topsoil, *i.e.*, its mixing with deeper soil layers. Since this is not the case, disturbances of the soil as well as cremations can be ruled out for this area of the camp. The same goes for the surrounding agricultural areas;
- contrary to witness accounts, no trees or bushes were planted on the camp grounds for camouflage purposes.

### 4.2.2. Belzec, Sobibor, Majdanek<sup>11</sup>

Much like Treblinka, the Belzec camp could easily be looked into from the nearby rail line and road. The town of Belzec was located about 1 mile north of the camp, which had been built on a hillside, into the forest. Air photos from 1944,<sup>12</sup> in other words from after the camp was dismantled, show that the area of the camp where witnesses claim mass graves containing some 600,000 bodies

---

<sup>7</sup> Ref. No. GX 120 F 932 SK, exp. 125.

<sup>8</sup> Cf. the chapter by A. Neumaier, this volume. Also U. Walendy, “*Der Fall Treblinka*”, *Historische Tatsachen* No. 44, Verlag für Volkstum und Zeitgeschichtsforschung, Vlotho 1990.

<sup>9</sup> According to S. Werner the reason for that was the retreat of the German army in Russia, making any camps used for the transit of Jews to the East obsolete, see *Die 2. babylonische Gefangenschaft*, 2<sup>nd</sup> ed., Grabert, Tübingen 1991 (online: [vho.org/D/d2bg/I\\_II.html](http://vho.org/D/d2bg/I_II.html); English: [vho.org/GB/Books/tsbc](http://vho.org/GB/Books/tsbc))

<sup>10</sup> Exact date unknown, Ref. No. GX 12225 SG, exp. 259.

<sup>11</sup> For these camps, cf. Y. Arad, *Belzec, Sobibor, Treblinka: The Operation Reinhard Death Camps*, University Press, Indiana 1987; E. Kogon, H. Langbein, A. Rückerl et.al. (eds.), *Nationalsozialistische Massentötungen durch Giftgas*, Fischer, Frankfurt/Main 1983; E. Jäckel, P. Longerich, J. H. Schoeps (eds.), *Enzyklopädie des Holocaust*, Aragon, Berlin 1993. Due to space limitations these three camps were only briefly mentioned here. For details cf. J. C. Ball, *op. cit.* (note 3).

<sup>12</sup> Ref. No. GX 8095 33 SK, exp. 155.

as well as their later cremation sites were located, had an area of approximately 7,000 m<sup>2</sup> (75,300 sq.ft.). No more than 70,000 bodies could thus have been buried there – provided that the rocky soil would even have allowed for the excavation of 12-ft.-deep graves in the first place. There is no evidence of any foundations left over from former buildings, nor of any large-scale movements of the soil or of mass cremations. There are no signs of any such activity anywhere in the surrounding area either.

It is claimed that in Sobibor 100,000 of the total 150,000 victims were buried before being exhumed later and being cremated along with the rest of the victims. The air photo from 1944,<sup>13</sup> also taken after the camp was dismantled, shows this camp as having covered an area of roughly 50,000 m<sup>2</sup> (12.4 acres). Some 10,000 m<sup>2</sup> (107,600 sq.ft.) – fully ± of the total camp area – would have been needed to bury the victims. However, the air photo shows that the ground in the camp area was not disturbed. There are no signs of former building foundations, large-scale movements of earth, or cremation sites.

The Majdanek camp is located at the outskirts of the city of Lublin. Just as for Treblinka, the surrounding fields were cultivated right up to the camp boundary. The alleged gas chambers and the crematorium were outside the camp proper, openly visible and accessible to thousands of people living in the suburbs of Lublin.

### 4.3. Babi Yar

It is said that after the city of Kyiv was occupied by German troops the Jews of this city were taken to Babi Yar, a ravine at the northwestern edge of the city, near the Jewish cemetery. According to eyewitness accounts, they were shot there, thrown into the ravine, and buried – according to some witness statements, the ravine was also blasted and the bodies buried under the rubble.

In late summer of 1943, when the Front retreated again, the bodies were allegedly exhumed and cremated on gigantic funeral pyres or in pits. These activities allegedly ended on September 28, 1943, when the Kyiv area was already part of the main battle zone.<sup>14</sup>

*Illustration 3* shows the ravine of Babi Yar in an air photo taken by the Luftwaffe on September 26, 1943.<sup>15</sup> The part of the ravine (near the Jewish cemetery) where the massacre allegedly took place is shown as enlargement in *illustration 4*. What we see is in fact a placid and peaceful valley. Neither the topography nor the vegetation has been disrupted by human intervention. There are no access roads for the transport of humans or fuel, no fuel depots, no excavations, no burning sites, and no smoke.

We may conclude with certainty that no part of the Babi Yar ravine was subjected to topographical changes of any magnitude during the war years right up to the Soviet reoccupation of the area. The vegetation in this valley was also not disturbed.<sup>16</sup> Hence, there can have been no mass graves in these locations, and the mass cremations attested to can also not have taken place at this time.

<sup>13</sup> Ref. No. GX 191 F 910 SK, exp. 122.

<sup>14</sup> Cf. the chapter by H. Tiedemann, this volume.

<sup>15</sup> Ref. No. GX 3938 SG, exp. 104 and 105.

<sup>16</sup> This statement can be documented with further air photos showing the valley prior to the war and again after Soviet reoccupation: the vegetation in the valley has grown, but nothing else has changed (May 17, 1939: GX 988 – exp. 48, 49; April 18, 1944: GX 4793 SK – exp. 39, 40). Due to space limitations we have dispensed with showing these pictures here, and chosen one instead that shows the location during the time of the attested-to mass exhumation and mass cremation.



**Illustration 3:** Luftwaffe air photo of the Babi Yar ravine, taken on Sept. 26, 1943.



**Illustration 4:** Enlargement of a portion of the Luftwaffe air photo taken of the Babi Yar ravine on Sept. 26, 1943. This portion shows the part of the valley near the Jewish cemetery.

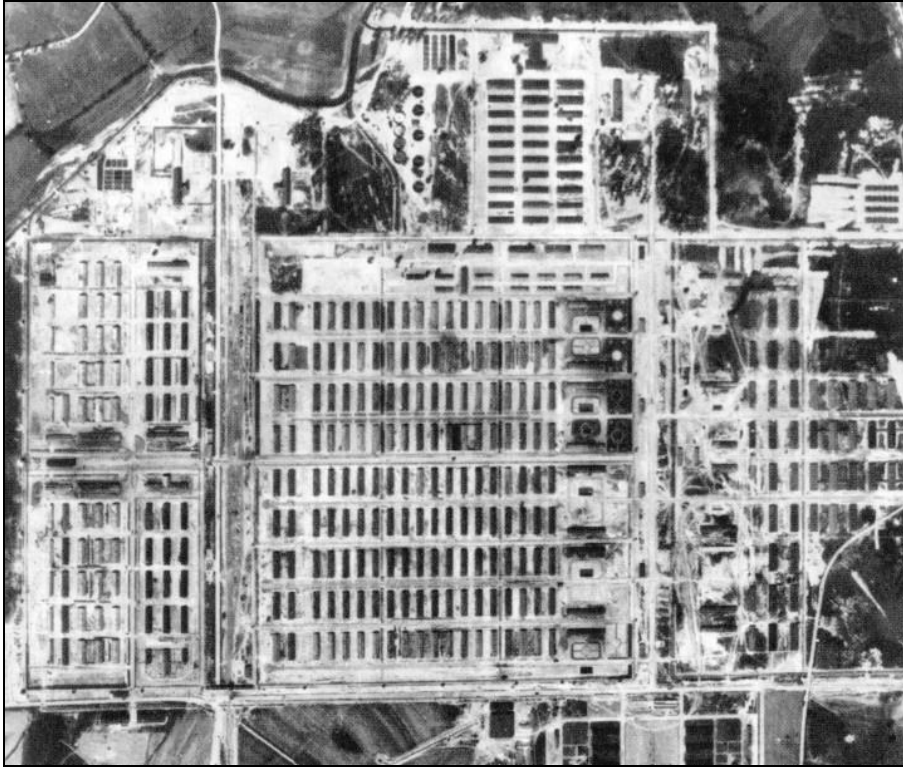

**Illustration 5:** Concentration camp Auschwitz-Birkenau. This American air photo was taken on May 31, 1944. Ref. No. R G 373 Can D 1508, exp. 3055.

## 5. Mass Extermination in Auschwitz-Birkenau

### 5.1. Alterations on Air Photos of Auschwitz-Birkenau

Contrary to the photos of the camps in eastern Poland, the photos of Auschwitz (*illustrations 5 and following*) were taken by the Americans. It took the Allied landing in Italy in autumn of 1943 before the Americans were able to bomb the industrial area of Upper Silesia; Allied reconnaissance flights over this area therefore did not begin until the winter of 1943/44.<sup>17</sup> However, the corresponding air photos were not submitted to the National Archives by the CIA, and thus made accessible to the public, until the late 1970s. It was also the CIA which published the first photos of Auschwitz-Birkenau in 1979, authored by D. Brugnioni, R. Poirer.<sup>18</sup>

The Americans took many series of photographs of the Upper Silesian industrial area, and some of them are of excellent quality. Unfortunately, the Auschwitz-Birkenau camp group is shown on only about half a dozen photos, all of which are of mediocre or poor quality. One qualitatively excellent sequence of photos from June 26, 1944, breaks off just before Auschwitz. While it is possible that the cameras were turned off immediately after the plane flew over the main point of interest, namely the synthetic rubber plant in Monowitz, it seems more probable that these photos of excellent quality and resolution were in fact removed before the public could view them. We shall see the grounds for this supposition in the following.

<sup>17</sup> However, bombing the Auschwitz camp itself would have made no sense (what ever was happening there), as James H. Kitchens has shown, “*The Bombing of Auschwitz Re-examined*”, *Journal of Military History*, April 1944, pp. 233-266.

<sup>18</sup> D. Brugnioni, R. Poirer, *The Holocaust Revisited: A Retrospective Analysis of the Auschwitz-Birkenau Extermination Complex*, Central Intelligence Agency, Washington 1979; cf. review by W. Stäglich, *Deutschland in Geschichte und Gegenwart* 27(3) (1979) pp. 10-14 (online: [vho.org/D/DGG/Staeglich27\\_3.html](http://vho.org/D/DGG/Staeglich27_3.html)).

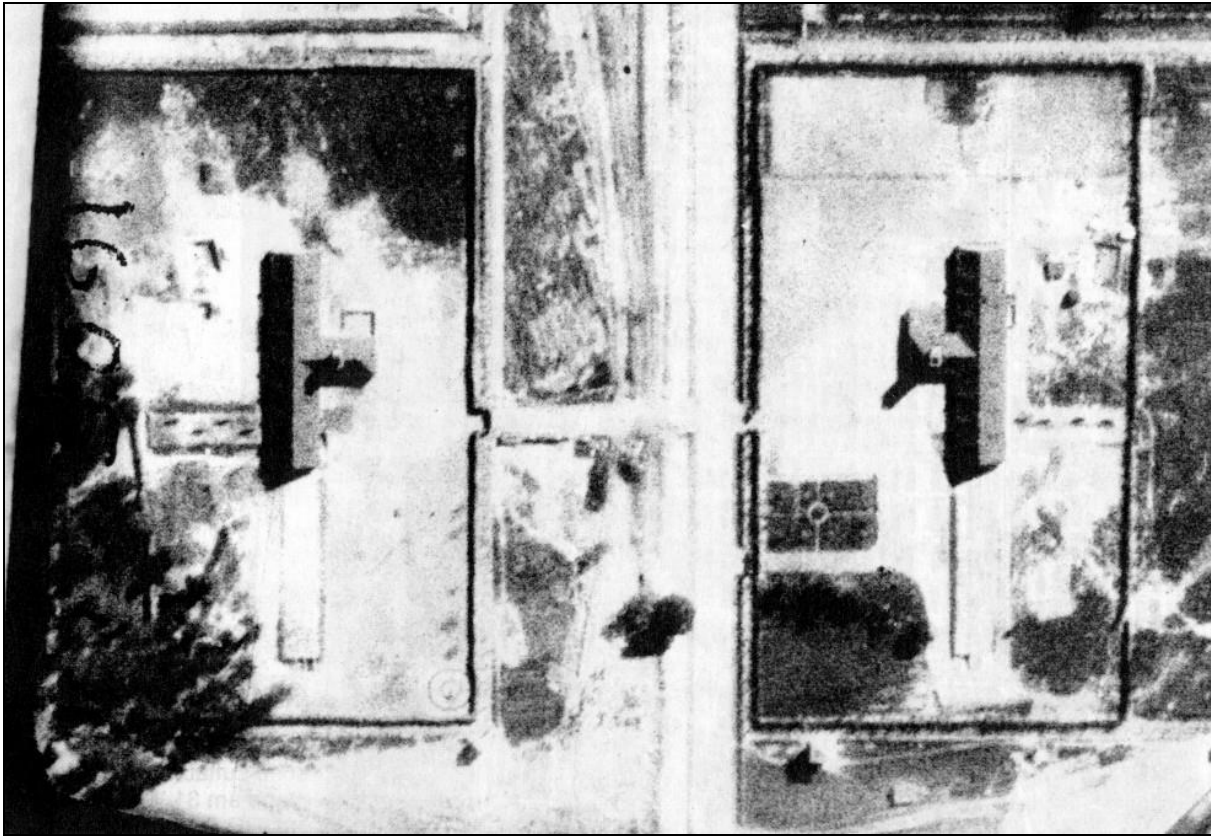

**Illustration 6 :** Detail enlargement of RG 373 Can F 5367, exp. 3185, Aug. 25, 1944, crematoria II and III.

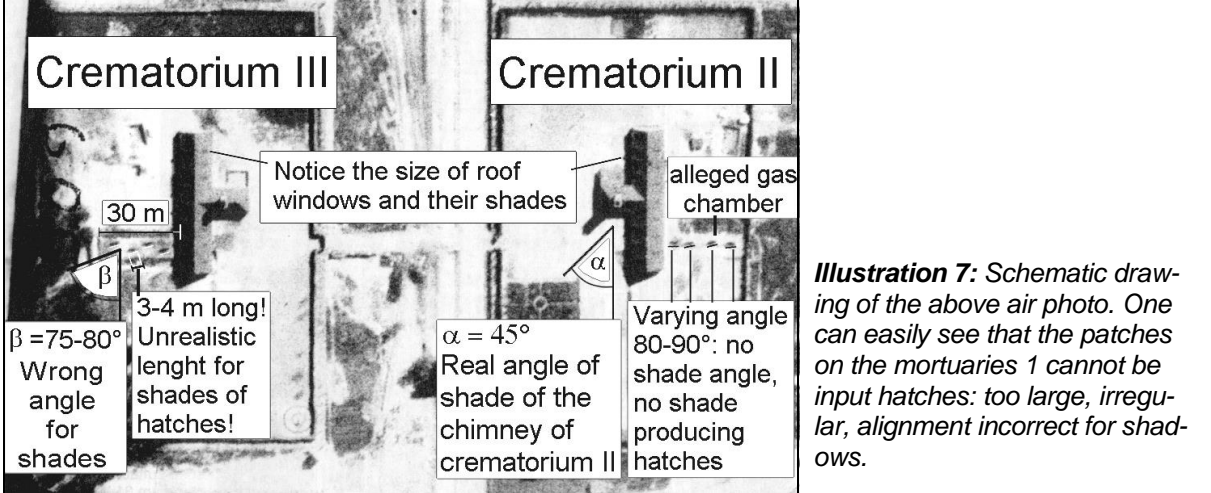

**Illustration 7:** Schematic drawing of the above air photo. One can easily see that the patches on the mortuaries 1 cannot be input hatches: too large, irregular, alignment incorrect for shadows.

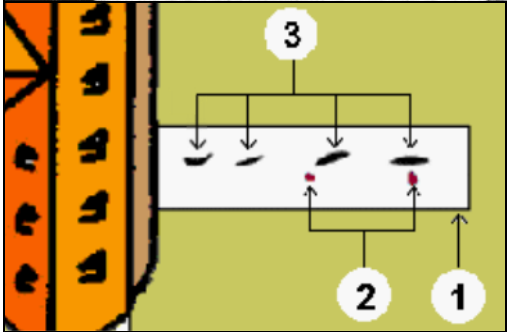

**Illustration 8:** Schematic drawing of the position and size of the patches (3) on the roof of mortuary 1 (the 'gas chamber', 1) of crematorium II and the location (2) of the only two holes to be found.

First it is interesting to note that in Birkenau as well, the surrounding land was cultivated right up to the edge of the camp, which would have rendered it impossible to keep anything secret that happened inside the camp. I would like to focus attention on two pictures of the Birkenau camp made on August 25, 1944.<sup>23</sup> The second picture was shot just 3,5 seconds after the first. This enables us to make a three-dimensional analysis with the help of a stereo viewer. But first we shall analyze only the first of these two pictures. Illustration 6 is an enlargement of the section around the crematoria II and III. Illustration 7 is a schematic drawing of this picture. The patches visible on the roof of the morgues 1 of both crematoria were identified as Zyklon B input hatches and their shadows by the CIA.<sup>18</sup> However, even without the help of a 3D viewer, it is obvious that these patches cannot be input hatches:

- The alignment of the patches does not agree with the direction of the shadow cast by the crematorium chimney;
- on a photo from September 13, 1944, the patches on crematorium III retain their direction and shape even though the position of the sun has changed;<sup>19</sup>
- on that same photo the patches on mortuary 1 of crematorium II are missing;
- the length of the shadows corresponds to input hatches 4.5 ft. wide and rising 10 to 13 ft. above the roof – in other words, large chimneys, not the approximately 20-inch-high hatches attested to by witnesses;
- these jagged, irregular patches cannot be shadows cast by perpendicular, straight input hatches.

On Sept. 24, 1996, Brugnioni claimed in a private letter<sup>20</sup> that he views

*“the marks as including the shadows of the vents, but also including roof discoloration marks perhaps from people walking around the area of the vents, causing discoloration of the roof, which showed up as the marks visible in the photos of the roof of the gas chamber”*

As shown, these discolorations have nothing to do with shadows, and any discolorations from people walking around any objects, *e.g.*, by destroying the grass growing on the two feet thick layer of earth on these roofs, would have a circular pattern around these objects, a linear pattern between them, and, as can be seen from other parts of the pictures, areas without proper plants growth cause a lighter color than those with proper plant coverage, and not darker, as they are in this picture.

*Illustration 8*, an enlarged section of the schematic drawing of *illustration 7*, reveals the discrepancy between the holes actually present in the roof of mortuary 1 of crematorium II and the patches added to the photo by the forgers. The location and size of the real holes, marked with a circle, do not correspond to the patches added.

According to the CIA, the dark line surrounding both crematoria II and III was a wall or hedge intended to guard against prying eyes and to prevent attempted escapes. From a vast number of original, ground-based photos of the camp, however, we know that the crematoria were separated from the rest of the camp merely by a wire mesh fence, which would not show up on an air photo.<sup>21</sup> On a photo of May 31, 1944, these dark lines around crematoria II and III were only incompletely drawn in.<sup>22</sup> The same goes for the lines drawn around crematoria IV and V only on the photo of September 13, 1944.

<sup>19</sup> Ref. No. RG 373 Can B 8413, exp. 6V2, J. C. Ball, *op. cit.* (note 3), p. 65.

<sup>20</sup> Charles D. Provan, “No Holes? No Holocaust?: A Study of the Holes in the Roof of Leichenkeller I of Krematorium 2 at Birkenau” ([www.revisingrevisionism.com](http://www.revisingrevisionism.com)).

<sup>21</sup> Cf. J. C. Ball, *ibid.*, pp. 45, 63; S. Klarsfeld, *The Auschwitz Album*, Beate Klarsfeld Foundation, New York 1980; the fence has partially survived to this day: J.-C. Pressac, *Auschwitz: Technique and Operation of the Gas Chambers*, Beate Klarsfeld Foundation, New York 1989.

<sup>22</sup> Ref. No. RG 373 Can D 1508, exp. 3055, J. C. Ball, *op. cit.* (note 3), pp. 52, 64.

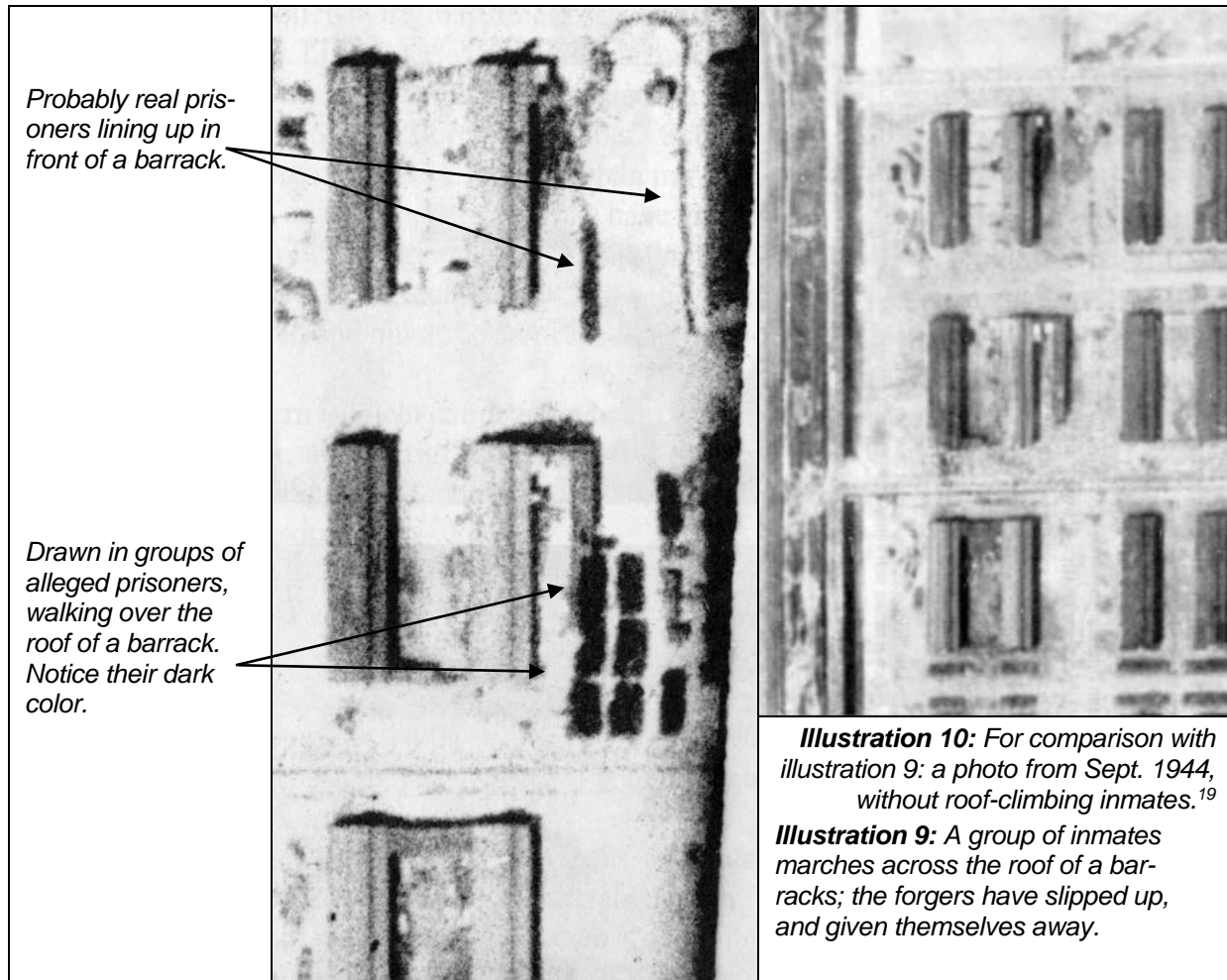

Viewing these pictures in 3-D, one realizes that neither the alleged wall nor the patches on the mortuaries have any elevation. What is more, the overly dark color of such narrow objects proves that what we have here is an instance of photo retouching.

*Illustration 9* is another enlargement from the photo used for *illustration 6*. In this picture patches were added which, according to the CIA, represent groups of inmates. In this context one must consider that a group of inmates is not a massive block structure that could cast darker shadows than, for example, the barracks beside them. More than likely, therefore, the picture was ‘helped along a little’ here. This assumption is proven by the fact that some of these ‘groups of inmates’ are evidently marching across the roof of a barracks – a physical impossibility. This is shown clearly by the photo of September 13, *illustration 10*, where the barracks is also clearly visible, but this time without inmates marching across it.

*Illustrations 11* and *12* (next page) show enlargements of details of the two photos taken in rapid succession on August 25, 1944.<sup>23</sup> According to the CIA’s interpretation this shows a group of inmates on their way to the gas chambers. What is most interesting is the manner in which this group of inmates moves (*illustration 13*): it moves in a zigzag – in a line added by a clumsy retoucher?

After realizing these facts of the matter, I went to the National Archives and requested to see the originals, since the photos given to me as originals had clearly been altered. And in fact I was then given air photos which I was assured were the originals. These were indeed of better quality than the negatives I had been given first: due to the better focus, the work of the forgers was considera-

<sup>23</sup> Ref. No. RG 373 Can F 5367, exp. 3185 & 3186.

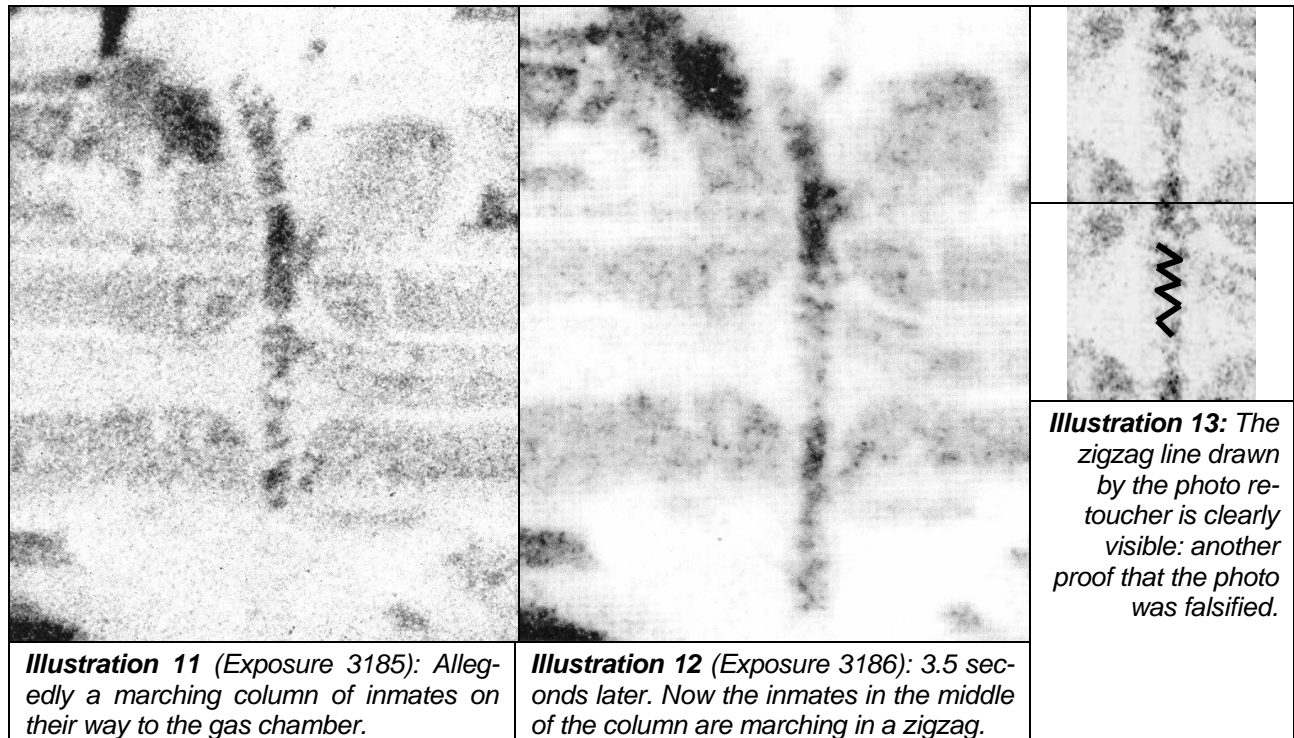

bly more clearly apparent at the same places on the photos. When I pointed this out to the Archives staff, I was told that these were the negatives which the National Archives had received from the CIA in 1979, and that they had always believed that they were in the precise state in which they had been taken from the reconnaissance planes in 1944. I was told that I was the first member of the public ever to have seen these negatives. Now they would be returned to the archives forever, to be handed out only at the request of government agencies such as the CIA.

In light of the poor quality of the forgeries on these air photos, it is not likely that the alterations were added by a government agency or by the CIA itself. These authorities have highly qualified staff and advanced technology at their disposal and would have produced forgeries that were perfect, or at least very difficult to expose. However, it is remarkable that in 1999, Dino Brugnioni, the same author from the CIA who in 1979 published the air photos of Auschwitz,<sup>18</sup> published a book about “*photographic deception and manipulation*”, exposing himself as an expert on making and/or recognizing faked pictures.<sup>24</sup> Mysteriously, he discusses the photo criticized here in his chapter on how to detect faked photos – of course without claiming that it was altered. Is that really a coincidence?

## 5.2. Mass Graves and Mass Cremation

To the immediate north of the Birkenau camp, near the presumed location of the so-called Bunker I, the air photos reveal rectangular patches which may perhaps stem from old, filled-in mass graves (*illustration 15*, right, page 281).<sup>25</sup> Their surface area totals approximately 3,600 m<sup>2</sup> (38,700 sq.ft.). West of the camp, more rectangles are visible, standing out from their surroundings due to their lighter coloring (totaling about 450 m<sup>2</sup>, or 4,800 sq.ft., see *illustration 15*, top).

<sup>24</sup> D. Brugnioni, *Photo Fakery: The History and Techniques of Photographic Deception and Manipulation*, Brassey’s, Washington, D.C., 1999.

<sup>25</sup> Details from air photo, *op. cit.* (note 22).



If one assumes that the patches north of the camp are mass graves, that these were 3 m (about 10 ft.) deep with a 1 m (3 ft.) covering soil layer, and that mass graves have a capacity of at most 8 bodies per m<sup>3</sup> (10 per 44 cu.ft.),<sup>26</sup> this indicates a maximum of about 55,000 bodies that could have been contained therein.

Until early 1943, the Auschwitz-Birkenau camp group had only the old crematorium in the Auschwitz Main Camp at its disposal, so that during this time probably not all the dead could be cremated, but had to be buried in mass graves instead. D. Czech reports that as of approximately mid-September 1942 the mass graves in Birkenau were opened and emptied so as to prevent contamination of the ground water supply.<sup>27</sup> From November 1941 to September 1942 some 45,000 inmates died in Birkenau, mostly of typhus.<sup>28</sup> On the basis of the coke fuel deliveries, for which documentation exists, it can be determined that the Main Camp crematorium, having only 349.1 metric tons of coke delivered during this period, could have cremated a maximum of 11,400 bodies,<sup>29</sup> not all of which came from Birkenau, of course, but also from within the Main Camp itself. Thus one may expect that roughly 40,000 bodies were buried in Birkenau in mass graves between November 1941 and September 1942. This figure corresponds quite well with our calculations regarding the maximum capacity of the presumed former mass graves whose outlines we can detect on the air photos.<sup>30</sup>

If Czech's statements regarding the opening of mass graves in September 1942 are correct, it seems quite plausible that from this time on until the new crematoria were put into operation in spring/summer 1943, there were indeed open-air funeral-pyre cremations of old, partially decomposed corpses. This work, which was likely performed by inmates, might represent the factual basis of greatly exaggerated and highly embellished eyewitness statements about perpetual, gigantic mass cremations on pyres and in deep pits. These witness statements generally place the open-air cremations in pits located behind crematorium V and west of the camp on a meadow near Bunker II,<sup>31</sup> a former farmhouse allegedly renovated to serve as gas chamber. In the process, it is claimed, the great quantities of smoke emanating from the burning sites swathed the camp in dark clouds.<sup>32</sup> Particularly from May to August 1944, during the time of the alleged destruction of the Hungarian Jews and the Jews from the Lodz ghetto, fires are said to have been burning in the fire pits day and night.<sup>33</sup> But the air photo of May 31, 1944, is the only one to show even relatively small drifts of smoke rising behind crematorium V.<sup>34</sup> Nothing even remotely similar is to be found at any other place, nor on any other photo. There are no considerable quantities of smoke issuing from the chim-

<sup>26</sup> Cf. the chapter by A. Neumaier, this volume.

<sup>27</sup> D. Czech, *Auschwitz Chronicle, 1939-1945*, Henry Holt, New York 1989, pp. 108, 242, 275.

<sup>28</sup> Cf. J.-C. Pressac, *Les Crématoires d'Auschwitz, la Machinerie du meurtre de masse*, CNRS, Paris 1993, pp. 144ff.

<sup>29</sup> Cf. the chapter by C. Mattogno and F. Deana, this volume.

<sup>30</sup> Some time ago the Polish firm Hydrokop carried out drillings in Birkenau at the sites where, according to witnesses, mass graves and/or burning pits had been located. A few parts of the report based on these drillings have been published by U. Walendy in *Historische Tatsachen* No. 60, Verlag für Volkstum und Zeitgeschichtsforschung, Vlotho 1993. According to this report, charred wood as well as bones and hair were found at some points. A correct interpretation, however, would require access to the entire report. Also, the fragments of the report which are available fail to specify the exact location of the drill sites.

<sup>31</sup> It is claimed that there was another farm house (Bunker I), but its exact location is unknown. It is not visible on any air photos, and so it will not enter into this discussion. It is alleged to have been located at the place where the aforementioned traces of possible mass graves are detected.

<sup>32</sup> Aside from E. Jäckel et.al. and E. Kogon et.al., *op. cit.* (note 11), cf. also D. Czech, *op. cit.* (note 27), *passim*.

<sup>33</sup> Cf. J. S. Conway, "Der Holocaust in Ungarn. Neue Kontroversen und Überlegungen", *Vierteljahrshefte für Zeitgeschichte* 32 (1984) pp. 179-212; J. Wulf, "Lodz. Das letzte Ghetto auf polnischem Boden", *Aus Politik und Zeitgeschichte* 10(42) (1960) pp. 675-694; cf. also F. Piper, *Die Zahl der Opfer von Auschwitz*, Verlag Staatliches Museum Oswiecim, Auschwitz 1993, pp. 52, 69, 119ff.

<sup>34</sup> May 31, 1944, *op. cit.* (note 22).

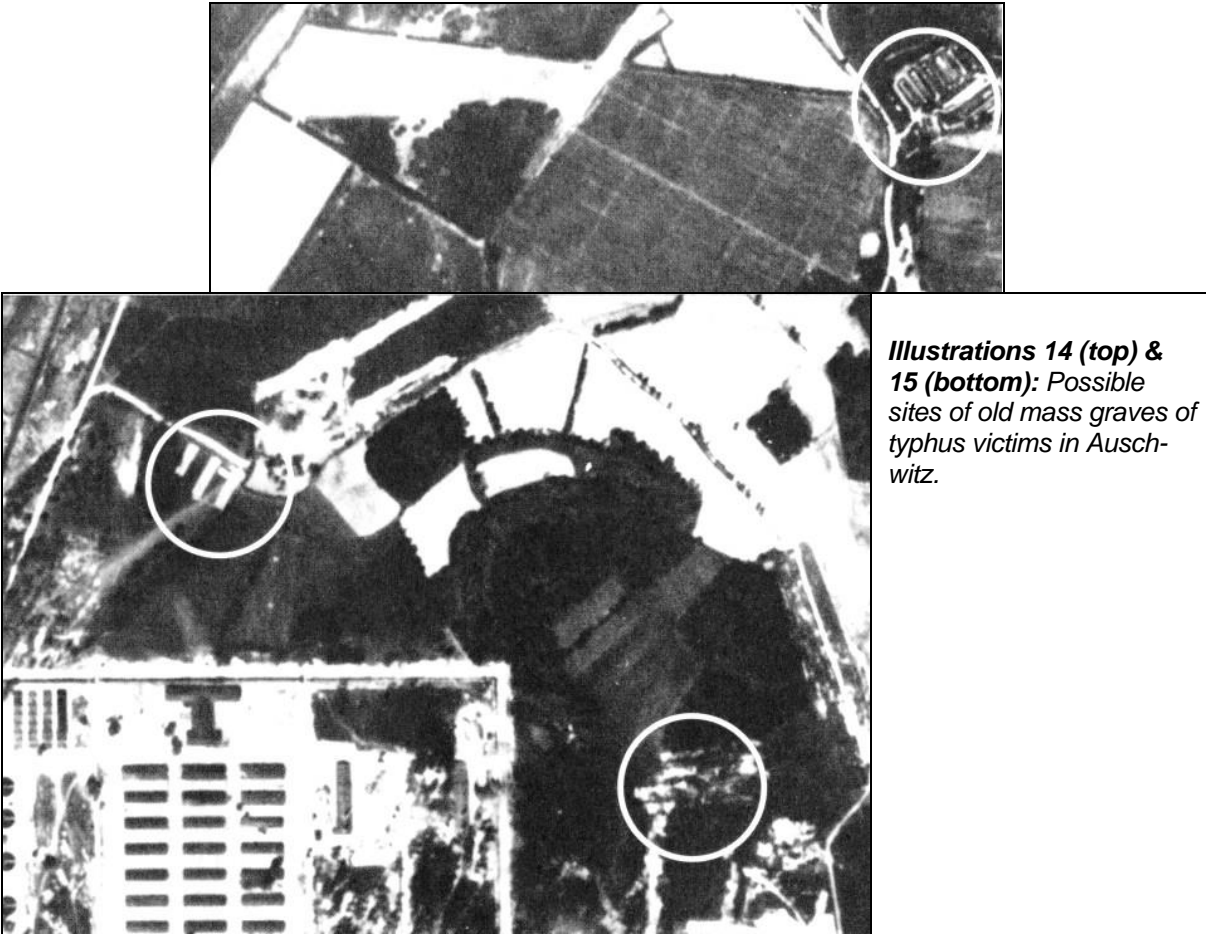

neys, none in the vicinity of Bunker II, none anywhere else. The photo from September 13, 1944, is the only one to show any large smoke clouds at all, and these have drifted in from the surrounding industrial establishments which the Allies had just bombed. Establishment Professor G. Jagschitz's theory, proposing that perhaps the Allies had used filters that resolved the smoke on the photos,<sup>35</sup> is not even close. Smoke cannot be resolved by optical filters; at best, one could use film that is sensitive to a specific range of the electromagnetic spectrum which the smoke does not absorb. This, however, would have required a homogeneous and known composition of the smoke, as well as highly advanced technology at the Allies' disposal at the time. Neither factor is given. The Allied air photos were taken with perfectly normal, simple black-and-white film. If there are no smoke clouds visible on the photos, then there were no incinerations to cause them. Further, in light of the absence of any pits, pyres, fuel depots and heaps of corpses it is downright irrelevant whether the smoke might have been visible or invisible, since there was nothing that could have caused it in the first place. Filters to render fuel depots, burning pits, heaps of corpses etc. invisible have yet to be invented, even today.

<sup>35</sup> Transcript of the report of Prof. G. Jagschitz, 3rd-5th day of the trial of G. Honsik, April 29 and 30, May 4, 1992, Ref. 20e Vr 14184 and Hv 5720/90, District Court Vienna, p. 478 of the transcript.

## 6. Conclusions

<p><i>Hamburg, Katyn, Bergen-Belsen</i></p> <p>The mass graves of Hamburg, Katyn and Bergen-Belsen demonstrate how great the area requirements are for mass graves. Due to the area required for the excavated material, which in realistic terms is much greater than the theoretical minimum areas calculated in Table 1, 10,000 bodies need at least 4,000 m<sup>2</sup> (43,000 sq.ft.).</p>	<p><i>Treblinka</i></p> <p>Mass graves for the alleged 700,000 to 1.2 million victims of this camp would have required 40 times as much space as the witnesses state was available. The ground in the camp area shows no traces of former building foundations, large mass graves or burning pits.</p>
<p><i>Sobibor, Belzec, Majdanek</i></p> <p>As in the case of Treblinka, it would have been impossible in Majdanek or Belzec to keep any mass murder secret; the close proximity of settlements and roads, and the cultivation of surrounding farm land right up to the camp fences, saw to that. In no case is there any evidence for mass graves or burning pits.</p>	<p><i>Babi Yar</i></p> <p>The ravine of Babi Yar underwent no noticeable changes in topography or vegetation up to the end of the war. There are no signs of human intervention during the time of German occupation. There was no human activity there at the time of the mass cremations attested to by the witnesses.</p>
<p><i>Auschwitz-Birkenau</i></p> <p>The few air photos of Auschwitz-Birkenau known to date from the period of December 1943 to February 1945 show no signs of fuel depots, smoke from chimneys or open fires, burning pits or pyres. The photos were altered: Zyklon B input hatches, groups of inmates, and walls around crematoria were retouched onto the photo negatives. Insofar as they still exist, photos of good quality are being kept from the public. One must assume that any actual mass murder activities would not have escaped the notice of the air photo interpreters. This would have resulted in the bombing of the camp – which, however, was carefully refrained from.<sup>36</sup></p>	
<p><i>The Bottom Line</i></p> <p>To this day there is no air photo evidence to support the alleged mass murder of the Jews at any location in Europe occupied by the Germans during World War Two. Further, air photo analysis refutes the claim that the ‘Nazis’ had intended, at whatever time, to keep events in the alleged extermination camps secret. In many cases the air photos provide clear proof that some of the events attested to by witnesses, such as the destruction of the Hungarian Jews or the mass executions at Babi Yar, did not in fact take place. We may hope that the release of Soviet air photos dating from the time the camps were in operation will shed further light on these issues. The fact that these photos have not been published to date may already speak for itself. That the photos in western hands were altered in order to incriminate Germany, and were first published by the CIA, is also very significant indeed.</p>	

<sup>36</sup> Cf. also J. Konieczny, *The Soviets, but not the Western Allies, should have bombed the Auschwitz Camp*, Polish Historical Society, PO Box 8024, Stamford, CT 06905, 1993.

# National Socialist Concentration Camps: Legend and Reality

JÜRGEN GRAF

## 1. Starting Position

On April 11, 1945, American troops entered Buchenwald concentration camp. Four days later, British troops reached Bergen-Belsen concentration camp. In the weeks that followed, the Anglo-Americans liberated other camps, including Dachau (April 29) and Mauthausen (May 5). To the victorious soldiers, all these concentration camps represented scenes of horror. The Jewish historian Walter Laqueur reports in this regard:<sup>1</sup>

*“On April 15, units of a British regiment entered Bergen-Belsen concentration camp following a ceasefire negotiated with the local German commander. Colonel Taylor, who commanded the regiment, wrote following an initial investigation of the camp in the laconic language of an official report:*

*‘As we walked along the main street of the camp, we were greeted with jubilation by prisoners and saw the condition of the inmates for the first time. Many were little more than living skeletons. Men and women lay in rows on both sides of the street. Others crawled slowly and aimlessly around with emaciated, expressionless faces.’*

*Tens of thousands of corpses, many in advanced stages of decomposition, lay piled on top of each other.”*



*Mass Grave in Bergen-Belsen camp, filled mainly with inmates who had succumbed to a typhus epidemic shortly before the end of World War II or thereafter. Photo taken after the liberation of the camp by British forces.*

Following the soldiers came a swarm of photographers and journalists; the world was immediately filled with horrifying images of piles of bodies and walking skeletons. Now, at long last, the Allies had the long-sought proof that the Americans had been fighting the embodiment of Evil, a diabolical enemy against whom any and all methods of warfare had been permitted, including the barbaric terror bombings of German cities.

From the very outset, to be sure, a few sober observers recognized that the mass deaths in the recently liberated National Socialist concentration camps were not the result of an extermination poli-

---

I am indebted to my friend Carlo Mattogno of Italy for supplying me with important source references. J. Graf.

<sup>1</sup> Walter Laqueur, *Was niemand wissen wollte. Die Unterdrückung der Nachrichten über Hitlers “Endlösung”*, Ullstein Verlag, Frankfurt a.M./Berlin/Vienna 1981, p. 1ff.

cy on the part of the Germans, but were due to mass epidemics. The Chicago-based *Journal of the American Medical Association*, for example, reported on May 19, 1945:<sup>2</sup>

*“By negotiations between British and German officers, British troops took over from the SS and the Wehrmacht the task of guarding the vast concentration camp at Belsen, a few miles northwest of Celle, which contains 60,000 prisoners, many of them political. This has been done because typhus is rampant in the camp and it is vital that no prisoners be released until the infection is checked.”*

But the voices of reason were drowned out in the maelstrom of atrocity propaganda unleashed by the media. In the following months, the anti-German atrocity machine went into high gear, the newspapers dishing up fantastic figures of the numbers of people allegedly exterminated in National Socialist concentration camps.

A Swiss newspaper, for example, screamed in August 1945:<sup>3</sup>

*“Hitler-Germany Heads the World. Twenty Six Million People Murdered in German Concentration Camps!”*

The prosecutors at Nuremberg did not go as far as this in terms of numbers, but they did their best. The Soviets claimed at Nuremberg 4 million deaths at Auschwitz<sup>4</sup> and 1.5 million at Majdanek,<sup>5</sup> while 840,000 Russian prisoners of war were said to have been murdered at Sachsenhausen and their bodies cremated in *four mobile crematoria!*<sup>6</sup>

Sir Hartley Shawcross, British head prosecutor at the Nuremberg Trial, summarized the accusations raised against vanquished Germany in the following words:<sup>7</sup>

*“The murders were carried on like any other mass production industry, in which gas chambers and ovens of Auschwitz, Dachau, Treblinka, of Buchenwald, Mauthausen, Majdanek and Oranienburg.”*

Revisionist author Wilhelm Stäglich hit the nail on the head in this regard when he wrote:<sup>8</sup>

*“Whenever [in the immediate post-war period] there was any talk of the ‘Final Solution of the Jewish Question’ in the sense of an alleged physical extermination of the Jews ordered by the leadership of the Third Reich, no distinction was made between the individual concentration camps. All were supposed to have been used in this monstrous murder program, since – as was explained – every concentration camps was alleged to have possessed one or more gas chambers, in which Jews were said to have been killed using Zyklon B or carbon monoxide.”*

For a large proportion of the public – in Stäglich’s words – “no distinction is made between the individual concentration camps”, even today. The average citizen presumably still believes that Jews and other inmates were gassed in Dachau, Bergen-Belsen and Buchenwald. The principal reason for this situation, in particular, is that photos of victims of epidemic disease (both Jewish and non-Jewish) are regularly shown on television and reproduced in the press as ‘proof’ of an alleged “systematic extermination of the Jews”; on the other hand, the media, half a century after the end of the war, continue unashamedly to speak of gassings in western concentration camps. For example, a

---

<sup>2</sup> Quoted according to M. Weber, “‘Extermination’ Camp Propaganda Myths”, in: E. Gauss (ed.), *Dissecting the Holocaust*, Theses & Dissertations Press, Capshaw, AL, 2000, p. 305 (online: [vho.org/GB/Books/dth/fndWeber.html](http://vho.org/GB/Books/dth/fndWeber.html)).

<sup>3</sup> *Berner Tagwacht*, August 26, 1945. No historian with any claim to a minimum of seriousness has ever cited such figures of victims. Nevertheless, 47 years after the end of the war, a madman was permitted to claim, in the highly respected *Frankfurter Allgemeine Zeitung*, without any contradiction by the editors, that 26 million people were murdered in German concentration camps (*FAZ*, Sept. 21, 1992, p. 13).

<sup>4</sup> URSS-008.

<sup>5</sup> *IMG*, vol. VII, p. 648, German edition.

<sup>6</sup> *IMG*, vol. VII, p. 644, German edition.

<sup>7</sup> *IMG*, vol. XIX, p. 483, German edition.

<sup>8</sup> Wilhelm Stäglich, *Der Auschwitz-Mythos*, Grabert Verlag, Tübingen 1979, p. 6 (online: [vho.org/D/dam/index.html](http://vho.org/D/dam/index.html)).

Canadian newspaper in 1993 featured the story of one Moshe Peer, who claimed to have survived no less than six gassing actions as a boy in Bergen-Belsen:<sup>9</sup>

*“Each time he survived, watching with horror as many of the women and children gassed with him collapsed and died. To this day, Peer does not know how he was able to survive.”*

Another ‘Holocaust survivor,’ Elisa Springer, claimed in her memoirs, which appeared 42 years after the war(!), that “*the gas chambers and ovens*”<sup>10</sup> had started to operate in Bergen-Belsen after Josef Kramer had become camp commandant.<sup>11</sup>

The media may occasionally peddle this type of horror story, even today. Historical writers with any claim to seriousness, however, realized that the legend about the purpose of the western camps – to carry out a program of deliberate mass extermination – could not stand scrutiny for long, because it was in overly crass contradiction to the obvious facts. Walter Laqueur states in the appendix to the excerpt about Bergen-Belsen quoted at the beginning:<sup>12</sup>

*“The Belsen case was unbelievable for more than one reason. Three years had passed since the world first heard of the existence of the extermination camps for the first time. There were detailed individual reports on the names of these camps, their locations, on the millions of human beings who were killed there – even the names of the camp commandants were known. [...] Thus Belsen set off a wave of the most violent indignation although paradoxically it was in no way an extermination camp [...].”*

In fact, the orthodox historians, *i.e.*, those who defend the allegation that a physical extermination of the Jews took place, abandoned the claim of any mass exterminations in Bergen-Belsen or other western concentration camps soon after the end of the war. While a part of these historians until today are of the opinion that unsystematic gassing actions took place on a small scale in these camps, others no longer speak of gasings in the western camps at all (see section 5).

This does not, of course, mean that the accusation that millions of people – mostly Jews – were murdered in German concentration camps has in any way been dropped. To mark the defeated enemy with an indelible mark of Cain, for a “*crime unique in world history*”, to break German morale and self-respect for all time, the victorious powers – with their German vassals – continued their campaign of anti-German atrocity stories, but shifted the scene of the mass killings to a few locations east of the Iron Curtain, inaccessible to western observers. The result was the gradual crystallization of the version of the ‘Holocaust’ familiar to most people today. According to this version, National Socialist concentration camps fell into three categories:

‘Normal’ concentration camps, *i.e.*, work camps, where executions – and, according to a few authorities, gasings on a small scale – are alleged to have taken place, but where most of the victims are said to have died ‘natural’ deaths, *i.e.*, in particular, from disease and exhaustion.

Auschwitz and Majdanek. The claim is made that these two camps were used as both work camps and extermination camps. Jews unable to work are said to have been exploited for slave labor, while those unable to work were purportedly killed.

Finally, the “*pure extermination camps*” of Treblinka, Sobibor, Belzec, and Chelmno, are alleged to have been founded exclusively for the purpose of carrying out a mass extermination of Jews. Apart from a few “*working Jews*” required to operate the camps, every Jew in these camps was allegedly gassed, regardless of age or state of health, without being registered.

<sup>9</sup> *The Gazette*, Montreal, 5. August 1993.

<sup>10</sup> There was only *one* oven in Bergen-Belsen, which had started to operate long before Kramer became camp commandant.

<sup>11</sup> Elisa Springer, *Il silenzio dei vivi. All’ombra di Auschwitz, un racconto di morte e di risurrezione*, Marsilio Editore, Venedig 1997, p. 88.

<sup>12</sup> W. Laqueur, *op. cit.* (note 1), p. 8.

That the above classification of National Socialist concentration camps is found in the entire body of orthodox literature on ‘Holocaust’ itself, even today, should in no way be allowed to conceal the fact that the classification is entirely arbitrary and is based upon no documentary evidence whatsoever. All the German wartime documents relating to Auschwitz and Majdanek (Lublin) refer to them simply as “*concentration camps*” in exactly the same manner as, for example, Dachau, Buchenwald, and Sachsenhausen. As we shall soon see, Auschwitz and Majdanek were governed by the same German regulations as the other camps, and the reasons for the high mortality rates were essentially the same.

The situation with regards to the so-called “*pure extermination camps*” is a different one; the present article restricts itself to a few comments only in this regard. First, Treblinka, Sobibor, Belzec, and Chelmno were not concentration camps. There are very few surviving documents relating to these four camps, and there is no material evidence at all. There is not the slightest proof that any program of mass extermination was carried out in these camps at all: all the allegations made in this regard are based solely on unreliable ‘eyewitness’ testimony. On the basis of the few available documents and a great deal of other evidence, it may be deduced that Treblinka and Sobibor were transit camps, via which some Jews were sent east – into the occupied Soviet zones – while others were sent, in transit, via these camps, to a variety of work camps.<sup>13</sup> It is highly probable that Belzec was a transit camp as well.<sup>14</sup> Of Chelmno, we know next to nothing. These four camps are not the topic of the present paper, and we shall not, therefore, discuss them in any further detail below.

With regards to the other camps, we have taken the trouble to compare the many myths about National Socialist concentration camps against the documented facts. Inevitably, many long-cherished preconceptions will be abandoned along the way.

## 2. Development and function of the National Socialist camp system

### 2.1. Historical Precedents and Parallels

That concentration camp systems were not invented by Germans has become fairly well known as a result of Alexander Solzhenitzyn’s *Gulag Archipelago*. But they were not invented by the totalitarian Soviet system either: many democracies have also interned prisoners of war, allegedly disloyal civilians, and unpopular minorities in similar camps. The following are a few major examples only:

During the American Civil War, both the North and South maintained concentration camps for prisoners of war and civilian enemy sympathizers; a considerable percentage of these inmates died, mostly from epidemics. In the Northern prison camps of Camp Douglas and Rock Island, the mortality rates ranged from 2 to 4%. At the Southern prison camp of Andersonville, there were 13,000 deaths out of a total of 52,000 Union prisoners, *i.e.*, a death rate of 25%.<sup>15</sup> As we shall see, the mortality rate at Andersonville was entirely comparable, in terms of percentages, with many National Socialist concentration camps.

---

<sup>13</sup> See, in this regard, Carlo Mattogno, Jürgen Graf, *Treblinka: Vernichtungslager oder Durchgangslager?*, Castle Hill Publishers, Hastings 2002 (online: [vho.org/D/Treblinka](http://vho.org/D/Treblinka); soon also available in English from *Theses & Dissertations Press*, Chicago; online: [vho.org/GB/Books/t](http://vho.org/GB/Books/t)). On Sobibor, please see Chapter 9 of the same book.

<sup>14</sup> On March 17, 1942, Fritz Reuter, an official in Lublin, following a conversation with SS-Hauptsturmführer Hans Höfle, informed the Official Responsible for Jewish Resettlement in the District of Lublin that he was receiving four to five transports per day, filled with Jews intended for Belzec. These Jews were transported across the border and were never re-transported to the Generalgouvernement. (Józef Kermisz, *Dokumenty i materiały do dziejów okupacji niemieckiej w Polsce*. Vol. II: *Akce’ i ‘wysiedlenia’*, Warsaw/Lodz/Krakow 1946, pp. 32 ff.)

<sup>15</sup> Arthur Butz, *The Hoax of the Twentieth Century*, Historical Review Press, Brighton 1977, p. 127f.

During the Second Boer War (1900-1902), the British built approximately 40 camps in Boer territory, interning a total of 115,000 Boer civilians, of whom 26,251 women and children died, a mortality rate of 25%.<sup>16</sup>

During the Second World War, the United States government ordered the interment in concentration camps of many Americans of German descent<sup>17</sup> and virtually all persons of Japanese ancestry resident in the United States, including American citizens,<sup>18</sup> regardless of the fact that there had never been a single case of subversion or sabotage by Japanese-Americans. During the same war, the National Socialists interned large numbers of Jews. Though this cannot be legally justified, they had at least a reason for it, since – understandably so – Jews constituted a disproportionately large proportion of resistance members and partisans in all German-occupied territories.<sup>19</sup>

## 2.2. National Socialist Concentration Camps During the pre-War Period

The interment camps erected soon after Hitler's assumption of power on 30 January 1933 – including the well-known “*Moor camps*” such as Papenburg and Esterwegen – were used to neutralize the militant political opposition: most of the inmates were Communists. The first regular concentration camp was opened at Dachau, near Munich, in 1933. In addition, by the beginning of the war, five additional camps were also opened (Sachsenhausen, Buchenwald, Mauthausen, Flossenbürg, and Ravensbrück).

While the number of internees in the camps still amounted to 27,000 in October of 1933, their numbers fell to 7,000 by February 1934 as a result of the rapidly relaxing political situation<sup>20</sup> and then remained quite stable, although in addition to political prisoners hardened criminals (“*Berufsverbrecher*”) and “*Asocials*” (tramps, beggars etc.) were interned too. The Jewish historian Arno Mayer gives the number of concentration camp inmates for the summer of 1937 as 7,500.<sup>21</sup> Another Jewish historian, Joseph Billig, emphasizes that the number of deaths in camps was very low throughout this period:<sup>22</sup>

*“In the early years of the regime, the death of inmates caused problems for the Nazi leaders. An avalanche of deaths was unacceptable for their policies which had to take account of public opinion. The stability [of the number of camp inmates] was therefore chiefly attributable to the number of released inmates, as well as the arrival of new inmates, which maintained the stability of the total camp population.”*

In August 1938, the Swiss divisional commander J.-C. Favez, Delegate of the International Red Cross, visited Dachau concentration camp. In his final report, he wrote:<sup>23</sup>

*“There are over 6,000 prisoners in the camp. [...] Conditions of interment: Solidly built, well-illuminated and well-ventilated barracks. [...] Every barracks contained a modern and quite clean water closet, in addition to wash basins. [...] Work in the summer from 7 to 11 A.M., and from 1 to 6 P.M.,*

<sup>16</sup> Claus Nordbruch, *Die europäischen Freiwilligen im Burenkrieg*, Contact, Pretoria 1999.

<sup>17</sup> Arnold Krammer, *Undue Process: The Untold Story of America's German Alien Internees*, Rowman and Littlefield, Lanham, MD, 1997.

<sup>18</sup> Udo Walendy, *US-amerikanische Konzentrationslager*, *Historische Tatsachen* No. 41, Vlotho/Weser 1990.

<sup>19</sup> The Jewish publicist Arno Lustiger, himself a former member of the Résistance, has pointed out that the Jewish population of France made up approximately 15% of all Résistance military operatives (despite the fact that Jews made up less than 1% of the total population of France). *Der Spiegel*, 7/1993, p. 54.

<sup>20</sup> Joseph Billig, *Les camps de concentration dans l'économie du Reich hitlérien*, Presses Universitaires de France, Paris 1973, p. 20.

<sup>21</sup> Arno J. Mayer, *Der Krieg als Kreuzzug*, Rowohlt, Reinbek 1989, p. 245.

<sup>22</sup> Joseph Billig, *op. cit.* (note 20), p. 20.

<sup>23</sup> Jean-Claude Favez, *Das IKRK und das Dritte Reich. War der Holocaust aufzuhalten?*, Verlag Neue Zürcher Zeitung, Zürich 1989, p. 538 ff.



*in the winter from 8 to 11 A.M. and from 1 to 5 P.M. No work on Saturday afternoon and Sunday. [...] Rations: The meals were prepared in roomy, very clean kitchens. It is simple, but different every day of the week, plentiful and of sufficient quality. [...] Every inmate is permitted to receive 15 Marks per week from his relatives, to improve his care. [...] The tone of the officers is correct. The inmates are permitted to write to their families, and are permitted to send, of course alternatively, one letter and one card per week. [...] The discipline is however very strict. The guards and soldiers do not hesitate to use their weapons in the event of attempted escape. [...] Solitary confinement takes place in roomy, well-illuminated cells. [...] The bastinado can also be inflicted as an extraordinary punishment. This punishment is supposed to be used in the most extremely unusual cases only. [...] It is apparently quite painful and is much feared. [...] When a soldier-guard strikes an inmate, he is severely punished, and expelled from the SS. [...] The treatment of the prisoners is of course very strict, but cannot not be characterized as inhumane. The sick in particular are treated with kindness, understanding, and proper professionalism.”*

Until 1938, Jews were only interned in the camps if they were political enemies of the National Socialist regime (or criminals); after the murder of a German diplomat in Paris and the so-called “*Crystal Night*” in November 1938, approximately 30,000 Jews were interned, but the overwhelming majority were soon released.

In the last years before the war, the number of inmates as well as the number of fatalities rose continually. In Buchenwald 48 inmates died in 1937; in 1938, the number of deaths rose to 771, and in 1939 to 1,235.<sup>24</sup> In Sachsenhausen, there were 6 deaths in 1936, 38 in 1937, and 229 in 1938.<sup>25</sup>

### 2.3. The Function of Concentration Camps During the War

After the beginning of the war, a number of new concentration camps were rapidly established, from Natzweiler in Alsace to Majdanek near the Polish city of Lublin; the number of inmates rose dramatically. The number of prisoners increased to 110,000 by September 1942, 225,000 by August 1943, and 524,000 by August 1944.<sup>26</sup> The peak number of inmates was reached in early 1945, with a total of 635,586 prisoners in all concentration camps combined.<sup>27</sup> All concentration camps had a network of auxiliary camps (up to approximately 100). In the *Generalgouvernement*, i.e., occupied Poland, a dense system of labor camps, in which the inmates, mostly Jews, performed compulsory labor, was created parallel to the official concentration camp system.<sup>28</sup>

One reason for this rapid development of the concentration camp system was the spread of active resistance movements, particularly in German-occupied territories. A Polish source remarks in this regard:<sup>29</sup>

*“From the beginning of 1942, a partisan movement also began to develop, reaching approximately 20,000 armed soldiers fighting in several dozen different underground formations by 1944. [...] Although the occupying power took the most drastic steps in the struggle against the resistance movements (reprisals, burning villages, executions, deportations, etc.), it was unable to bring the situation under control. We will merely state at this point that, according to German documents, between July 1942 and December 1943, on the territory of the District [of Lublin], no fewer than 27,250 attacks were carried*

<sup>24</sup> Eugen Kogon, *Der SS-Staat. Das System der deutschen Konzentrationslager*, Karl Alber, München 1946, p. 120.

<sup>25</sup> Winfried Meyer, “*Britischer oder sowjetischer Sachsenhausen-Prozeß?*”, *Zeitschrift für Geschichtswissenschaft*, Nr. 45 (1997), p. 987.

<sup>26</sup> 1469-PS.

<sup>27</sup> Survey of the SS-Wirtschaftsverwaltungshauptamtes, “*Situation of SS Guard Personnel and Inmates in all Concentration Camps, 1 and 15 January 1945.*” Reproduced in Hans Marsalek, *Die Geschichte des Konzentrationslagers Mauthausen, Eine Dokumentation*. Österreichische Lagergemeinschaft Mauthausen, Vienna 1980, p. 130.

<sup>28</sup> A complete table of these camps is found in Główna Komisja Badania Zbrodni Hitlerowskich w Polsce (ed.), *Obozy hitlerowskie na ziemiach polskich 1939-1945*, Państwowe Wydawnictwo Naukowe, Warsaw 1979.

<sup>29</sup> Tadeusz Mencil (ed.), *Majdanek 1941-1944*, Wydawnictwo Lubelskie, Lublin 1991, p. 35.

*out and several large partisan battles fought [...]; that, during the first months of 1944 alone, 254 trains were derailed or blown up, 116 railway stations and railway installations attacked, and 19 transports held up or shot at.”*

No occupation authority can tolerate such a situation. Terror tactics of the partisan movement led, inevitably, to increasingly severe reprisals on the part of the Germans. The camps formed a chief instrument of this repression.

An even more important reason for the constant expansion of the concentration camp system was the lack of manpower. At a time when almost every German fit for service was on the front, the concentration camp system acquired an increasingly greater economic significance, particularly with regards to the war effort. Many German documents attest to this fact; the following are a few particularly important examples only.

On January 25, 1942, five days after the Wannsee Conference, where – according to a stubborn historical myth<sup>30</sup> – the decision was allegedly made to order a physical extermination of the Jews, SS-*Reichsführer* Heinrich Himmler wrote a letter to Concentration Camp Inspector Richard Glücks:<sup>31</sup>

*“Be prepared to accept 100,000 male and up to 50,000 female Jews in the concentration camps over the next few weeks. Great economic tasks will arise for the concentration camps in the next few weeks.”*

On April 30, 1942, Oswald Pohl, Leader of SS-WVHA,<sup>32</sup> stated in a report to Himmler:<sup>33</sup>

*“The war has brought about a visible change in the structure of the concentration camps and their tasks with regards to the utilization of inmates. The increase in the number of inmates on the grounds of security, educational, or preventive measures alone is no longer one of the primary purposes. The chief emphasis has shifted to the economic aspect. The mobilization of inmate labor first for military purposes (increased armaments) and later for peaceful tasks is increasingly shifting to the foreground. Based on recognition of this fact necessary measures result which demand a gradual transfer of the concentration camps from their early one-sided political form into an organization reflecting their economic tasks.”*

On August 21, 1942, Martin Luther, a Foreign Ministry Official, stated in a memorandum that the number of Jews transported to the east was insufficient to cover the requirements for manpower.<sup>34</sup>

The extremely high mortality rates in the camps, due chiefly to diseases, but also to poor nourishment and clothing (see section 4), naturally influenced the economic efficiency of the camps in a highly negative way. On December 28, 1942, Concentration Camp Inspector Richard Glücks sent the following instructions in a circular letter to the commandants of 19 concentration camps:<sup>35</sup>

*“The first camp doctors must strive with all means available to them to ensure that the mortality figures in the individual camps are to be considerably reduced. [...] The camp doctors must supervise the nourishment of the inmates more than in the past, and submit suggestions for improvement in conformity with the administrations. Such measures must exist, not merely on paper, but must rather be regularly controlled by the camp doctors. [...] The Reichsführer SS has ordered that the mortality must be reduced at all costs.”*

<sup>30</sup> According to the *Canadian Jewish News* of January 30, 1942, the leading Israeli ‘Holocaust’ expert Yehuda Bauer called the allegation that the Wannsee Conference had decided upon the extermination of the Jews a “*silly story*”.

<sup>31</sup> NO-500.

<sup>32</sup> Wirtschaftsverwaltungshauptamt (Economic Administration Main Office)

<sup>33</sup> R-129.

<sup>34</sup> NG-2586.

<sup>35</sup> NO-1523. More exactly, 15 concentration camps (Natzweiler, Dachau, Sachsenhausen, Buchenwald, Flossenbürg, Groß-Rosen, Mauthausen, Ravensbrück, Neuengamme, Niederhagen, Auschwitz, Gusen, Stutthof, Herzogenbusch and Lublin), two “*Special Camps*” (SS Special Camp Hinzert, SS Special Camp Moringen) and two penal institutions (Straubing Prison, Danzig/Matzkau Prison Camp).

These instructions had concrete results: within eight months the mortality in the concentration camps fell by almost 80%.<sup>36</sup>

On October 26, 1943, SS-Obergruppenführer and Leader of the of the SS-WVHA Oswald Pohl sent all concentration camp commandants a circular letter in which he remarked:<sup>37</sup>

*“Within the framework of the armaments production the concentration camps have become [...] a factor of decisive military significance. We have created incomparable armaments factories where nothing existed before.*

*In earlier years, within the framework of the then applicable educational tasks it could be a matter of indifference whether an inmate performed useful work or not. Now, however, the working power of the inmates is of significance and all measures of the commander, leaders of the V Service and doctors must apply themselves to the maintaining the health and efficiency of the inmates. Not from reasons of sentimentality, but rather because we need them, with their arms and legs, because they must contribute to the achievement of a great victory by the German people, therefore we must be attentive to the well-being of the inmates.*

*I set the following objective: No more than a maximum of 10% of all inmates may be unable to work as a result of disease. This objective must be reached in a common task of all responsible officials. The following are necessary for this purpose:*

- 1. Correct and adequate food.*
- 2. Correct and adequate clothing.*
- 3. The utilization of all natural remedies.*
- 4. Avoidance of all effort not immediately necessary for the performance of needed work.*
- 5. Premiums for efficiency. [...]*

*I will bear personal responsibility for the supervision of the measures repeatedly described in the present letter.”*

The following are a few concrete examples of the significance of inmate labor to the war effort.

In Auschwitz, the largest camp, a considerable proportion of the inmates were assigned to work in I.G. Farbenindustrie factories for the manufacture of Buna – synthetic rubber – used for the production of tires and therefore a very important product. In his standard work on the ‘Holocaust,’ Raul Hilberg reports:<sup>38</sup>

*“On 19 March and 24 April 1941, the TEA [Technische Ausschuss der I.G. Farbenindustrie AG; Technical Committee] decided upon the details of production in Auschwitz. Two factories were to be created, one for synthetic rubber (Buna IV) and one for acetic acid. [...] Investment in Auschwitz initially amounted to over 500,000,000 Reichsmarks, but, in the end, to over 700,000,000 Reichsmarks. Approximately 170 sub-contractors were assigned to the work. The factory was erected; streets were built; barracks for the inmates were constructed; barbed wire was used for ‘factory fencing’; when the city of Auschwitz was finally completely filled with I.G. personnel, two company towns were built. To ensure that I.G. Auschwitz received all the needed materials, [I.G. official] Krauch ordered ‘Emergency Classification I’ for all materials required for the manufacture of Buna. In the meantime, and in addition, I.G. Auschwitz assured itself of its own coal supplies, from the Fürsten mine and Janina mine. Both mines were operated using Jews.”*

In the Dora-Mittelbau camp, especially feared for its hard working conditions and administered as an auxiliary camp of Buchenwald until 1944, but then promoted to the rank of a concentration camp in its own right, inmates in underground factories manufactured the rockets by means of which Germany still hoped to bring about a turning point in the war.

---

<sup>36</sup> PS-1469.

<sup>37</sup> Archiwum Muzeum Stutthof, 1-1b-8, S. 53 ff.

<sup>38</sup> Raul Hilberg, *Die Vernichtung der europäischen Juden*. 3 vols., Fischer Taschenbuch Verlag, Frankfurt 1997, p. 992.

On 11 May 1944, Hitler personally ordered the employment of 200,000 Jews within the framework of the fighter-plane construction program.<sup>39</sup>

On 15 August 1944, the SS-WVHA announced the immediately forthcoming delivery of 612,000 inmates to the concentration camp.<sup>40</sup> However, this number was never even remotely reached in actual fact.

### 3. Conditions in the Camps

#### 3.1. Various Inmate Categories

After the beginning of the war, new inmates categories were added to the political prisoners (known as “Reds” in camp jargon due to the red identifying triangles sewn on their uniforms), the “Greens” and “Asocials” (or “Blacks”). Prisoners of war – particularly Soviets – were interned in several camps; another group consisted of Jehova’s Witnesses, who were punished for refusal to do military service.<sup>41</sup>

From 1942 onwards, the mass deportation of Jews to concentration camps occurred from all German-occupied territories. The percentage of deported Jews varied greatly from country to country; thus, 75,721 Jews, a quarter of the total Jewish population of that country were deported from France, predominantly those with foreign passports.<sup>42</sup> The country with the highest percentage of deportees (over three quarters of all Jewish residents) was Holland.

In addition to the Jews, there were two further inmate categories who are repeatedly alleged to have been the target of a systematic program of extermination, *i.e.*, gypsies and homosexuals. A brief correction of fact is called for at this point.

##### 3.1.1. Gypsies

Political leaders speaking on behalf of German gypsies (or “Sinti and Roma”) claim that members of this racial group were murdered by the hundreds of thousands in the National Socialist concentration camps. The figure of 500,000 purportedly exterminated gypsies is regularly seen in the relevant literature and repeated in the media.<sup>43</sup> That this figure is purely a figment of the imagination and there is no evidence of a mass murder of gypsies under the Third Reich was proven by Udo Walendy, as early as 1985, in his periodical *Historische Tatsachen*.<sup>44</sup> A body of supplementary evidence against the claim was produced by Otward Müller in 1999.<sup>45</sup> – Representatives of the official

<sup>39</sup> NO-5689.

<sup>40</sup> NO-1990.

<sup>41</sup> Their refusal to do military service caused the Jehova’s Witnesses to be imprisoned in many countries. In Switzerland, widely considered a highly democratic country, Jehova’s Witnesses were regularly imprisoned until the 1990s. The repression of Jehova’s Witnesses in the Third Reich was thus no act of religious persecution.

<sup>42</sup> Serge Klarsfeld, *Le Mémorial de la Déportation des Juifs de France*, Paris 1978.

<sup>43</sup> The *New Yorker State Newspaper* of August 7, 1999, carried a report (on page 6) that the Central Council of the German Sinti und Roma had demanded the construction of a monument to the “500,000 Holocaust Sinti and Roma Victims”. Roman Herzog, ex-Chancellor of the German Federal Republic, expressly recognized the figure of 500,000 murdered gypsies as “historical fact” in 1997: *Bulletin des Presse- und Informationsamt der Bundesregierung*, March 19, 1997, no. 234, p. 259.

<sup>44</sup> “Zigeuner bewältigen ½ Million”, in: *Historische Tatsachen* No. 23, Verlag für Volkstum und Zeitgeschichtsforschung, Vlotho 1985.

<sup>45</sup> Otward Müller, “Sinti und Roma – Geschichte, Legenden und Tatsachen”, in: *Vierteljahreshefte für freie Geschichtsforschung* 3(4) (1999), pp. 437-442 (online: [vho.org/VffG/1999/4/Mueller437-442.html](http://vho.org/VffG/1999/4/Mueller437-442.html)).

historiography have also drastically reduced the number of one half million murdered gypsies: in 1997, German historians were talking about 50,000 ‘murdered’ “*Sinti und Romas*.”<sup>46</sup>

It is a fact that Heinrich Himmler order the internment of “*Gypsies of mixed race, Roman Gypsies and Gypsies from the Balkans*” on 16 December 1942. At the same time, however, he excepted a number of other categories of gypsies, those classed as “*socially adjusted*” gypsies, from internment. According to the *Auschwitz Death Books*, containing a record of every instance of mortality in Auschwitz, 11,843 Gypsies died of what amounted to natural causes, *i.e.*, mostly as a result of disease.<sup>47</sup> That the gassing of more than 2,000 gypsy women in Auschwitz on 2 August 1944 claimed by the official historiography is another myth lacking all basis in fact, has been unimpeachably shown by Carlo Mattogno.<sup>48</sup>

### 3.1.2. Homosexuals

The growing acceptance of homosexuality in western society, and the increasing influence of gay organizations, have led to intensified efforts to attribute to homosexuals the ‘martyr status’ of a minority “*systematically exterminated*” during the Third Reich. The number of homosexuals alleged to have died in National Socialist concentration camps is stated by special interest groups to amount to as many as 500,000 – or even more.<sup>49</sup> What is indisputable is that homosexuality in National Socialist Germany – and in a great many other countries at the same time, for example, Great Britain and the USSR – was a criminal offence. Between 50,000 and 60,000 homosexual males were sentenced by German courts between 1933 and 1944. A minority of these – presumably 10,000 to 15,000 – were sent to concentration camps after finishing their prison sentences in ordinary prisons; these were mostly repeat offenders, male prostitutes, transvestites and seducers of minors.<sup>50</sup>

### 3.2. Food

There is no doubt that poor food contributed to the high mortality rates of the early war years, and it is in no way our intent to whitewash the camp administration in this regard. But it should be noted that serious efforts were taken to improve conditions. In the circular letter to all concentration camp commandants quoted above, referring to the necessity for “*correct and adequate food*”, SS Obergruppenführer O. Pohl gave precise instructions as to how the food was to be prepared and served, stating, among other things:<sup>51</sup>

*“Vegetables should be served at mealtimes, both raw, in the form of salad, or unprocessed (carrots, sauerkraut). [...] The quantity of food served at midday meals must amount to 1.25 – 1.5 l. No thin soups, but heavy, nourishing dishes. [...] The receipt of additional food is to be encouraged. [...] If sick*

---

<sup>46</sup> Under the headline “*Korrekturen an Goldhagen: Vorträge über den Holocaust an der Universität Freiburg*,” the *Frankfurter Rundschau* reported on February 13, 1997: “*Assiduous study of the documentation permits the conclusion that the figure of the murdered Sinti und Roma is far lower than the figure commonly cited in the media: 50,000 instead of 500,000 [...]*”

<sup>47</sup> *Memorial Book. The Gypsies at Auschwitz-Birkenau*. K.G. Sauer, München-London-New York-Paris 1993, volume II, p. 1476.

<sup>48</sup> Carlo Mattogno, “*Die ‘Vergasung’ der Zigeuner in Auschwitz am 2. August 1944*”, in: *Vierteljahreshefte für freie Geschichtsforschung*, 7(1) (2003), pp. 28f. (online: : [vho.org/VffG/2003/1/Mattogno28f.html](http://vho.org/VffG/2003/1/Mattogno28f.html))

<sup>49</sup> For example, Franc Rector, in his book *The Nazi Extermination of Homosexuals*, Stern and Day, New York 1981, speaks of “*at least 500,000*” homosexual victims of National Socialism.

<sup>50</sup> Jack Wickoff, “*Der Mythos von der Vernichtung Homosexueller im Dritten Reich*”, *Vierteljahreshefte für freie Geschichtsforschung* 2(2) (1998), pp. 135-139 (online: [vho.org/VffG/1998/2/Wikoff2.html](http://vho.org/VffG/1998/2/Wikoff2.html)), a translation of “*The Myth of a Nazi Extermination of Homosexuals*”, *Remarks*, no. 22, April 20, 1997.

<sup>51</sup> *Archiwum Muzeum Stutthof, I-Ib-8*, p. 53 ff.

*persons are to recover more rapidly as a result of special diets, then such special diets must be served, but in hospitals only.*”

Tadeusz Iwaszko, former head of the Auschwitz Memorial, in an article on inmate food at Auschwitz, writes as follows:<sup>52</sup>

*“At midday meal, ‘meat soup’ was served four times a week, and ‘vegetable soup’ three times a week, the latter consisting of vegetables including potatoes and beets or carrots [Rüben].”*

According to Iwaszko, the soup possessed a nutritional value of 350-400 calories. At midday meal, the inmates were served approximately 300 grams of bread, approximately 25 grams of sausage or margarine as well as a spoonful of marmalade or cheese with a nourishment value of 900 to 1000 calories. Could German front line soldiers be assured of receiving similar rations every day of the week?

The Polish resistance movement, which certainly had no vested interest in whitewashing the conditions in the camp, had the following to say on the food in Majdanek concentration camp in early 1943:<sup>53</sup>

*“The food was rather meager at first, but has recently improved and is of higher quality than in the prisoner of war camps in 1940, for example. In the morning, the inmates receive approximately half a liter of broth at 6:00 A.M. (two days a week herbal tea with a peppermint taste). At midday meal, 1:00 P.M., half a liter of quite nourishing soup is served, even enriched with fat or meal. Evening meal was served at 5:00 P.M., and consists of 200 grams of bread with spread (marmalade, cheese or margarine, twice a week 300 grams of sausage) as well as half a liter of broth or soup from the meal of unpeeled potatoes.”*

### 3.3. Medical Care

In a strongly anti-National Socialist monograph on Groß-Rosen concentration camp, the author, Isabell Sprenger, writes as follows:<sup>54</sup>

*“A continual collection of disease reports from the years 1943-1945 with very detailed daily tasks on the treatment of individual patients shows that at least in some cases time and effort could be expended on healing the inmates.”*

The objection that Groß-Rosen was an “ordinary concentration camp” and not an “extermination camp” collapses immediately when it is seen that a great quantity of documents relating to the medical care of inmates have survived even for Auschwitz, the best-known of the alleged extermination camps. For example, a report on the medical treatment of 3,138 Hungarian Jewish internees was drawn up on June 28, 1944, – when the ‘gas chambers’ were allegedly being operated at full capacity – establishes precisely the illnesses for which the persons concerned are to be treated:<sup>55</sup>

<i>“Surgical cases</i>	<i>1426</i>
<i>Diarrhea</i>	<i>327</i>
<i>Constipation</i>	<i>253</i>
<i>Angina</i>	<i>79</i>
<i>Diabetes mell.</i>	<i>4</i>
<i>Weak heart</i>	<i>25</i>

<sup>52</sup> T. Iwaszko, “*Le condizioni di vita dei prigionieri*”, in: *Auschwitz. Il campo nazista della morte*, State Museum Auschwitz-Birkenau, 1997, p. 70f.

<sup>53</sup> Krystyna Marczevska, Władysław Ważniewski, “*Obóz koncentracyjny na Majdanku w świetle akt Delegatury rządu na Kraj*”, in: *Zeszyty Majdanka*, VII, 1973, p. 222f.

<sup>54</sup> Isabell Sprenger, *Groß-Rosen. Ein Konzentrationslager in Schlesien*, Böhlau Verlag, Köln/Weimar/Wien 1996, p. 151.

<sup>55</sup> Gosudarstvenny Arkhiv Rossiskoi Federatsii (GARF), Moscow, 7021-108-32, p. 76; see illustration on next page.

<i>Scabies</i>	62
<i>Pneumonia</i>	75
<i>Flu</i>	136
<i>Intertrig.</i> [sore spots]	59,268
<i>Other</i>	449
<i>Infectious diseases:</i>	
<i>Scarlet fever</i>	5
<i>Mumps</i>	16
<i>Measles</i>	5
<i>Erysipel</i>	5"

In another “*extermination camp*”, Majdanek, there was a hospital for wounded Soviet prisoners of war, the construction of which was personally ordered by Himmler on 6 January 1943.<sup>56</sup>

Krankenbehandlung : In der Berichtszeit 3158 Märtl. in der An-			
bulanz behandelt. Davon :			
chirurg. Fälle	1426,	Skabies	62
Durchfall	327	Pneumonie	75
Obstipation	253	Grippe	136
Angina	79	Intertrig.	268
Diabet. mell.	4	divers.	
Herzschwäche	25	Sonstige	449
		Infektionskrankheiten :	
		Scharlach	5
		Mumps	16
		Masern	5
		Erysipel	5

- Inusoträger wurden 64 ermittelte. Die Intertrig. Beson. gutturalen d-  
 Bestäubung mit Petrol. nach Rasieren in der Sauna. Es wurden in-  
 nur die Männern und nicht die schup. erfaßt.  
 Verlegt nach BII o bzw. anderes Lager waren 52 Märtl.

Medical treatment of inmates at Auschwitz-Birkenau<sup>55</sup>

### 3.4. Punishments and Mistreatment

The widespread idea that limitless arbitrary cruelty prevailed in the National Socialist concentration camps and that sadistic mistreatment was a common occurrence is simply not confirmed by surviving German wartime documentation. We are aware that regulations may exist only on paper, and we do not doubt that acts of cruelty often occurred in the camps. But that such acts in no way reflected official policy is clearly obvious from the regulations for the camp administration. In Auschwitz, every SS man had to sign a declaration reading word for word as follows:<sup>57</sup>

*“I am aware that only the Führer possesses life and death decision-making powers over enemies of the State. I am not permitted to injure or kill any enemy of the State (inmate). Any killing of an inmate in a concentration camp requires the personal approval of the Reichsführer SS. I am aware that I will be severely called to account for any violation of this regulation.”*

Kazimierz Smoleń, former Director of the Auschwitz-Museum, wrote an article on the punishment system at Auschwitz based on German documents, in which the various punishments provided for by the regulation are listed in order of severity:<sup>58</sup>

- Warning with threat of punishment
- Additional work
- Temporary transfer to a punishment company

<sup>56</sup> T. Mencil (ed.), *op. cit.*, p. 88ff.

<sup>57</sup> GARF, 7021-107-11, p. 130.

<sup>58</sup> Kazimierz Smoleń, “*Système de punition infligées par la SS dans le camp de concentration d’Auschwitz*”, in: *Contribution à l’histoire du KL-Auschwitz*, Edition du Musée d’Etat à Oswiecim, w/o year, p. 67f.

- Arrest
- Severe arrest with withdrawal of food
- Arrest in solitary confinement
- Beating (25 blows).

Prior to execution of the beating punishment an examination by a physician was required. Death sentences required approval by the RSHA prior to execution.<sup>59</sup>

Severe steps were occasionally taken against SS men guilty of committing crimes against inmates: two camp commandants – Karl Koch of Buchenwald and Hermann Florstedt of Majdanek – were executed by the National Socialists themselves.

### 3.5. Terror by Criminals and Communists

The mixing of political and criminal inmates could have frightful consequences for the politicals, since the criminal inmates were often the dregs of the underworld, creating a veritable reign of terror in many camps. Whether the camp administration recruited the “*Kapos*” (trustees) from the “*Reds*” or “*Greens*” was a matter of life or death to many inmates. Austrian Jewish Socialist Benedikt Kautsky, who spent the years between 1938 and 1945 in a number of different concentration camps (Dachau, Buchenwald, Auschwitz and, once again, Buchenwald), wrote the following in relation to terror by criminal inmates:<sup>60</sup>

*“Whether the criminals or political prisoners ruled a camp was a matter of life and death for ordinary inmates. In Buchenwald or Dachau camps, the responsibility incumbent upon the camp officials [recruited from] the ranks of the politicals was allocated as skillfully as possible; many SS - attacks were nipped in the bud, sabotaged or robbed of their effectiveness by passive resistance. Other camps under the leadership of criminals, such as Auschwitz and Mauthausen were hotbeds of corruption, where the inmates were cheated out of their rightful allocations of rations in food, clothing, etc. and furthermore mistreated in the grossest manner by their fellow inmates.”*

Other former concentration camp inmates have painted a darker picture of the camp officials recruited from the ranks of the political prisoners. Paul Rassinier, French resistance fighter and founder of Holocaust revisionism, described the terror of Communist inmates in Buchenwald in his book *Le Mensonge d’Ulysse*, written in 1950. Those inmates tyrannized other, non-Communist inmates and robbed them of their food packages, which was equivalent to a death sentence for many of them.<sup>61</sup> In a U.S. Army report drawn up following the liberation of Buchenwald states that the Communists gradually took power away from the criminal *Kapos* and – to some extent in collaboration with the SS – killed many inmates. They were said to have been responsible for a large proportion of the brutalities in the camp and were said to have controlled the distribution of food packages.<sup>62</sup> That the camp administration failed to take sufficiently energetic steps to put an end to the actions of the criminals and Communists must be considered a serious act of negligence.

<sup>59</sup> Franciszek Piper, “*I metodi di assassinio diretto dei prigionieri*”, in: *Auschwitz. Il campo nazista della morte*, Edizioni del Museo Statale di Auschwitz-Birkenau, 1997, p. 137.

<sup>60</sup> Benedikt Kautsky, *Teufel und Verdammte*, Büchergilde Gutenberg, Zürich 1946, p. 9.

<sup>61</sup> Paul Rassinier, *Le Mensonge d’Ulysse*, La Vielle Taupe, Paris 1979, p. 162 ff. (online: [aaargh.vho.org/fran/archRassi/prmu/prmu.html](http://aaargh.vho.org/fran/archRassi/prmu/prmu.html)); cf. Engl.: Rassinier, *The Holocaust Story and the Lies of Ulysses*, 2<sup>nd</sup> ed., Institute for Historical Review, New Port Beach 1990.

<sup>62</sup> Egon W. Fleck and Edward A. Tenenbaum, *Buchenwald: A Preliminary Report*, U.S. Army, 12th Army Group, 24 April 1945. National Archives, Record Group 331, SHAEF, G-5, 17.11, Jacket 10, Box 151 (8929/163-8929/180), quoted according to M. Weber, *op. cit.* (note 2), p. 293f.



Kommandantur  
Arbeitserziehungslager Birkenau

Birkenau, den 21. Juli 1944. 116

### Entlassungsschein

Die Anna Zwierzynska, geb. am 13.7.1897  
in Litzmannstadt, war in der Zeit  
vom 14.4.1944 bis 21.7.1944 in einem Arbeitserziehungslager  
untergebracht.  
Die Entlassung erfolgte am 21.7.1944.

**Auflage:**  
Sie haben sich sofort bei der  
Geheimen Staatspolizei in  
zu melden.



Der Lagerkommandant:  
i. A.  
  
Schurz  
Untersturmführer

51. 06/1. 44. 10/00

*Handwritten: 21.7.1944*

Release document of an inmate from Auschwitz-Birkenau camp dated July 21, 1944<sup>63</sup>

### 3.6. Releases

Large numbers of inmates were released, even after the beginning of the war. According to Polish sources, 5,000 inmates were released from Stutthof concentration camp,<sup>64</sup> while the incredible number of 20,000 inmates were released from the alleged “extermination camp” of Majdanek<sup>65</sup>. The total number of inmates released from Auschwitz is unknown, but must have been considerably high. Danuta Czech, in her *Kalendarium*, for the period between February 1942 and February 1945 indicates a total of 1,100 released inmates;<sup>66</sup> the very fragmentary release records which have survived, however – records found by C. Mattogno and myself and covering the period between June and December 1943 alone – show almost 300 releases; suggesting that the actual number of total releases must have been far higher. Most of the releases involved educational inmates transferred to Birkenau “work education camp” for 56 days in punishment for violation of their labor contracts (this practice resulted from a Himmler order dated 28 May 1942<sup>67</sup>). Many of these short-term inmates were released in the summer of 1944, at the same time as the alleged mass extermination of the Hungarian Jews. We are therefore supposed to believe that the National Socialists continually released witnesses to their own mass extermination program, so that the witnesses, in turn, could in-

<sup>63</sup> Rossiski Gosudarstvenni Vojenny Arkhiv, Moscow (RGVA), 502-1-438, p. 116.

<sup>64</sup> *Stutthof. Das Konzentrationslager*, Wydawnictwo Marpress, Danzig 1996, p. 120.

<sup>65</sup> Anna Wiśniewska, Czesław Rajca, *Majdanek Lubelski obóz koncentracyjny*, Państwowe Muzeum na Majdanku, Lublin 1996, p. 32.

<sup>66</sup> D. Czech, *Kalendarium der Ereignisse im Konzentrationslager Auschwitz-Birkenau 1939-1945*, Rowohlt Verlag, Reinbek 1989, p. 165-178.

<sup>67</sup> RGVA, 1323-2-140, p. 4.

form the world about German atrocities at Auschwitz! Prior to the evacuation of the camp, the German authorities at Birkenau left 4,299 inmates behind to await the arrival of the Soviets.<sup>68</sup>

### 3.7. Comparisons

Some of the German concentration camps continued operation after the war, this time with allied personnel and German prisoners who were considered a threat to allied security or who were opposed to occupational policies. Especially infamous in this regard is the Sachsenhausen camp under Soviet control,<sup>69</sup> but even the American operated Dachau camp served as a concentration camp after the war. One of the prisoners held captive by the Americans in Dachau published a diary,<sup>70</sup> which is interesting reading especially when compared with the diary of a prisoner who was in the same camp under German rule, *i.e.*, during the war.<sup>71</sup> In an analysis, Ingrid Weckert has juxtaposed both diaries and by so doing, was able to show that conditions in the Dachau camp were considerably better under German rule than they were under U.S. military rule – except for the very last months of the war, when the German infrastructure had broken down and the inmates, like everybody in Germany, suffered terribly due to lack of all supplies.<sup>72</sup>

## 4. Mortality Rates in Concentration Camps and their Causes

### 4.1. Number of Victims of the Camps

How many people died in the National Socialist concentration camps? Quite precise, and, in some cases, highly precise, statistics are available for seven different concentration camps, based on documentation of the individual camp authorities for these camps, which were, in turn, practically equivalent to the seven largest camps. In addition to the number of the inmates who died in the concentration camps, we also know the number of total arrivals, which, with the exception of Majdanek, are also known with complete or almost perfect precision. In addition, it should be noted that many inmates were often interned in several different camps, being frequently transferred from one camp to another (it should be recalled, in this regard that B. Kautsky, for example, spent the years between 1938 and 1945 in Dachau, Buchenwald, Auschwitz and, once again, Buchenwald). This means that the total number of inmates interned in the camps was much less than a mere addition of the figures for individual camps would tend to indicate. It also means that one must take care to avoid drawing the false conclusion that an inmate who survived one camp, must necessarily have survived the war: of the approximately 365,000 inmates registered at Auschwitz and subsequently transferred to other camps, to cite merely one example, a considerable proportion died in another camp.

The statistics for the seven camps are as follows:

<sup>68</sup> Andrzej Strzelecki, “Wyzwolenie KL Auschwitz”, in: *Zeszyty Oświęcimskie*, special issue, 1974, p. 57.

<sup>69</sup> Günter Agde, *Sachsenhausen bei Berlin. Speziallager Nr. 7, 1945 – 1950*; Aufbau-Taschenbuch-Verl., Berlin 1994; Barbara Kühle, Wolfgang Titz, *Speziallager Nr. 7 Sachsenhausen : 1945 – 1950*, Brandenburgisches Verl.-Haus, Berlin 1990.

<sup>70</sup> Gert Naumann, *Besiegt und “befreit”. Ein Tagebuch hinter Stacheldraht in Deutschland 1945-1947*, Druffel, Leoni 1984.

<sup>71</sup> “Arthur Haulot, *Lagertagebuch. Januar 1943 - Juni 1945*,” *Dachauer Hefte. Studien und Dokumente zur Geschichte der nationalsozialistischen Konzentrationslager*, 1(1) (1985), pp. 129-203.

<sup>72</sup> Ingrid Weckert, “Zweimal Dachau,” *Vierteljahreshefte für freie Geschichtsforschung* 2(1) 1998, pp. 22-34 (online: [vho.org/D/Sleipnir/RauWe3\\_2.html](http://vho.org/D/Sleipnir/RauWe3_2.html)). An earlier version of this essay, published in the Berlin periodical *Sleipnir*, 3(2) (1997), pp. 14-27, was confiscated by the German authorities because of this comparing article (County Court Berlin-Tiergarten, ref. 271 Ds 155/96).

**AUSCHWITZ:**<sup>73</sup>

1940/1941: ca. 19,500

1942: ca. 48,500

1943: ca. 37,000

1944: ca. 30,000

1945:<sup>74</sup> ca. 500**Total: ca.135,500 of ca. 500,100 registered inmates.**<sup>75</sup>**DACHAU:**<sup>76</sup>

1940: 1,515

1941: 2,576

1942: 2,470

1943: 1,100

1944: 4,794

1945: 15,384

**Total: 27,839 of ca. 168,000 inmates.**<sup>77</sup>**BUCHENWALD:**<sup>78</sup>

1937: 48

1938: 771

1939: 1,235

1940: 1,772

1941: 1,522

1942: 2,898

1943: 3,516

1944: 8,644

1945: 13,056

**Total: 33,462 of 238,979 inmates.****MAJDANEK:**<sup>79</sup>

1941: ca. 700

1942: ca.17,244

1943: ca.22,339

1944: ca. 1,900

**Total: ca.42,200 of an unknown amount of registered inmates.**<sup>80</sup>

<sup>73</sup> Carlo Mattogno, "Franciszek Piper und 'die Zahl der Opfer von Auschwitz'", *Vierteljahreshefte für freie Geschichtsforschung*, 7(1) (2003), pp. 21-27 ([vho.org/VffG/2003/1/Mattogno21-27.html](http://vho.org/VffG/2003/1/Mattogno21-27.html)). Among orthodox historians, *i.e.*, those who believe in the existence of the gas chambers and the extermination of the Jews, the number of estimated victims for Auschwitz have ranged from 9 million down to 514,000. F. Piper, Head of the Historical Division of the Auschwitz-Museums, indicates 1,077,000 as the number of victims (F. Piper, *Die Zahl der Opfer von Auschwitz*, State Museum Auschwitz, 1993). The manner in which Piper arrives at these fantastic figures is described by C. Mattogno in the article cited above.

<sup>74</sup> Auschwitz was liberated by the Red Army on 27 January 1945. Most of the inmates were evacuated beforehand.

<sup>75</sup> In Auschwitz approximately 401,500 inmates were registered in the camp inventory in a regular manner, *i.e.*, after allocation of a registration number. Approximately another 98,600 were lodged in the transit camp of Birkenau for a certain length of time, whence they were subsequently transferred to other camps. For details, see C. Mattogno, "Franciszek Piper und 'die Zahl der Opfer von Auschwitz'", *op. cit.* (note 73).

<sup>76</sup> Johann Neuhäusler, *Wie war das im KZ Dachau? Ein Versuch, der Wahrheit näher zu kommen*. Kuratorium für Sühnemal KZ Dachau, Dachau 1981, p. 27.

<sup>77</sup> Paul Berben, *Dachau. The Official History*, The Norfolk Press, 1975, p. 186.

<sup>78</sup> Eugen Kogon, *op. cit.* (note 24), p. 120.

<sup>79</sup> Jürgen Graf, Carlo Mattogno, *Concentration Camp Majdanek. A Historical and Technical Study*, Theses & Dissertations Press Castle, Chicago, IL, 2003, Chapter 4 ([online: vho.org/GB/Books/ccm](http://vho.org/GB/Books/ccm)). The Polish historiography postulates 360,000 as the number of victims from 1948 until 1992. The official camp historian, J. Marszałek, gives this figure in his book *Majdanek. The Concentration Camp in Lublin*, Interpress, Warsaw 1986, p. 142. In 1992, the number of victims at Majdanek was reduced by the official Polish historiography to approximately 235,000 (C. Rajca, "Problem liczby ofiar w obozie na Majdanku", in: *Zeszyty Majdanka*, XIV, 1992, p. 127). The book by Graf and Mattogno quoted above shows the manipulations with which the two Polish historians arrive at their figures.

<sup>80</sup> The number of inmates arriving at Majdanek is unknown. In the Polish standard work on Majdanek the number is given by Zofia Leszyńska as "over 275,000" (in: Tadeusz Mencel (ed.), *Majdanek 1941-1944*, Wydawnictwo Lubelskie, Lublin 1991, p. 93), but this figure is certainly exaggerated (in this regard, see J. Graf, C. Mattogno, *Majdanek, op. cit.* (note 79), Chapter 3).

**MAUTHAUSEN:<sup>81</sup>**

1938:	36
1939:	445
1940:	3,846
1941:	8,114
1942:	14,293
1943:	8,481
1944:	14,766
1945:	36,214

**Total: 86,195 of ca. 230,000 inmates.**

**SACHSENHAUSEN:<sup>82</sup>**

1940:	3,788
1941:	1,187
1942:	4,175
1943:	3,563
1944:	2,366
1945:	4,821
Liquidated and executed: <sup>83</sup>	675

**Total: 20,575 of 132,196 inmates.**

If one adds the numbers of victims for these seven camps, one arrives at a total figure of approximately 372,000 victims. For the other concentration camps, we must refer to the statistics of the Special Registry Office for Marriages, Births, and Deaths at Arolsen (Sonderstandesamt Arolsen, Germany), which are, however, incomplete, partly because some of the documentation is missing for certain camps, and partly because certain deaths registered at other municipal registries of births, marriages, and deaths have not been certified at Arolsen. In 1990, the situation was as follows:<sup>86</sup>

**STUTTHOF:<sup>84</sup>**

1939:	47
1940:	ca. 860
1941:	268
1942:	2,276
1943:	3,980
1944:	ca. 7,500
1945:	ca. 11,200

**Total: ca. 26,100 of 105,302 inmates.<sup>85</sup>**

Flossenbürg:	18,334 deaths	Neuengamme:	5,780 deaths
Groß-Rosen:	10,950 deaths	Natzweiler:	4,431 deaths
Dora-Mittelbau:	7,467 deaths	Ravensbrück:	3,640 deaths
Bergen-Belsen:	6,853 deaths	<b>Total:</b>	<b>53,445 deaths</b>

How incomplete are these statistics? For each of the previously listed seven camps, the mortality figures are more or less well known. However, for these camps Arolsen gave only the following numbers of certified deaths in 1990:<sup>86</sup>

<sup>81</sup> Hans Marsalek, *Die Geschichte des Konzentrationslagers Mauthausen. Dokumentation*. Österreichische Lagergemeinschaft Mauthausen, Vienna 1980, p. 156-158.

<sup>82</sup> Carlo Mattogno, "KL Sachsenhausen: Stärkemeldungen und 'Vernichtungsaktionen' 1940 bis 1945", in: *Vierteljahresshefte für freie Geschichtsforschung*, 7(2) (2003) (online: vho.org/VffG/2003/2). The figures indicated by Mattogno are from the original documentation of the Sachsenhausen camp administration in the State Archive of the Russian Federation in Moscow (GARF, Dossier 7021-104-4, p. 39ff.).

<sup>83</sup> The figures for liquidations and executions at Sachsenhausen were separated from those relating to inmates having died natural deaths. See C. Mattogno, *ibid.*

<sup>84</sup> Jürgen Graf, Carlo Mattogno, *Concentration Camp Stutthof and its Function in National Socialist Jewish Policy*, Theses & Dissertations Press, Chicago, IL, 2003, pp. 79-85 (online: vho.org/GB/Books/ccs).

<sup>85</sup> Elżbeta Grot, *Rejs Śmierci*, Muzeum Stutthof w Sztutowie, Danzig 1993, p. 13.

<sup>86</sup> Source: The brochure sent to the author by the Sonderstandesamt Arolsen in 1991; G. Rudolf has listed the updated figures published by the same authority in 1993, that is, two years later. The numbers hardly changed; see his contribution "Holocaust Victims: A Statistical Analysis" in this book. Since the mid 1990s, Arolsen does no longer publish such figures, since they do not like the way they are used by independent historians.

Mauthausen:	78,851 deaths	Dachau:	18,455 deaths
Auschwitz:	57,353 deaths	Stutthof:	12,628 deaths
Majdanek:	8,826 deaths	Sachsenhausen:	5,013 deaths
Buchenwald:	20,686 deaths	<b>Total:</b>	<b>201,812 deaths</b>

This figure reflects approximately 55% of the actual figures of approximately 372,000 victims. This suggests that the number of 53,445 victims for the seven other camps registered at Arolsen should be doubled; in this case one arrives at approximately  $(372,000 + 107,000 =) 479,000$  victims for the fourteen concentration camps.

The mortality figures for inmates having died in the work camps – mostly located in Polish territory – must be added to the above, but no reliable statistics are available to us in this regard. Raul Hilberg estimates the number of Jews having died in these work camps at 100,000, but fails to back up the estimate with any source references.<sup>87</sup> If we accept Hilberg’s figure, at least as a working hypothesis, and if we assume an equally high mortality figure for non-Jews having died in these same camps as well, we arrive at approximately  $(479,000 + 200,000 =) 679,000$  or almost 700,000 human beings having perished in National Socialist concentration camps and work camps. In our view, this would have to be the maximum figure; it is probable that the actual figure was lower. The number of Jews among the victims cannot be determined exactly under present circumstances, but was presumably no lower than 50%.

## 4.2. Reasons for High Mortality Rates

The worst mortality figures for Auschwitz occur during the second half of 1942, when a typhus epidemic was raging, killing a large percentage of the total camp population. The epidemic peaked between the 7<sup>th</sup> and 11<sup>th</sup> of September 1942, with an average death rate of 375 inmates per day.<sup>88</sup> In Majdanek, the mortality rate peaked in August 1943, a month in which 6.84% of all camp inmates died.<sup>89</sup> The principal cause of the mass mortality rate lay in the bad hygienic conditions caused by the absence of any connection to the sewer system of the city of Lublin, a failing which was catastrophic for the camp, encouraging the spread of epidemics.<sup>90</sup>

The situation in the western camps was different. For example, as we have seen, over 15,000 people died in Dachau between January and April 1945, more than in all the previous war years put together. Statistics for the other western camps are usually similar. The extremely high mortality rate was the immediate result of the German collapse, for which the Allies themselves were partially responsible. In his autobiography, the famous American aviator, Chuck Yeager, recalls that his squadron was ordered to machine gun “*everything that moved*” over a 50-square mile area:<sup>91</sup>

*“Germany cannot be so easily divided into innocent civilians and military personnel The farmer on his potato patch was, after all, feeding German troops.”*

The Allied terror bombings destroyed the German infrastructure, with the result that concentration camp inmates could no longer be supplied during the closing phase of the war. The main reason for the mass deaths in 1945, however, was not starvation, but epidemics, caused by the evacuation of the eastern camps, which in turn spread epidemic diseases to the overcrowded western concentration camps and could not be brought under control as a result of wartime conditions.

---

<sup>87</sup> Raul Hilberg, *op. cit.* (note 38), p. 1299.

<sup>88</sup> Jean-Claude Pressac, *Die Krematorien von Auschwitz. Die Technik des Massenmordes*, Piper Verlag, München/Zürich 1994, p. 193.

<sup>89</sup> PS-1469, p. 4.

<sup>90</sup> See J. Graf, C. Mattogno, *op. cit.* (note 79).

<sup>91</sup> Chuck Yeager, *Yeager. An Autobiography*, Bantam Books, New York 1985, p. 79.

The British physician Dr. Russell Barton spent a month in Bergen-Belsen as a young medical student and drew up a report on the conditions in the camp, in which he remarked:<sup>92</sup>

*“Most people attributed the conditions of the inmates to deliberate intention on the part of the Germans. [...] Inmates were eager to cite examples of brutality and neglect, and visiting journalists from different countries interpreted the situation according to the needs of propaganda at home. [...] German medical officers told me that it had been increasingly difficult to transport food to the camp for some months. Anything that moved on the autobahns was likely to be bombed. [...] I was surprised to find records, going back for two or three years, of large quantities of food cooked daily for distribution. At that time I became convinced, contrary to popular opinion, that there had never been a policy of deliberate starvation. This was confirmed by the large number of well-fed inmates. [...] The major reasons for the state at Belsen were disease, gross overcrowding by central authority, lack of law and order in the huts, and inadequate supplies of food, water and drugs.”*

The Allied propagandists of 1945 were naturally uninterested in such facts, and the media of the western world are equally uninterested in these same facts today. In the distorted picture of the diabolical SS men who supposedly allowed the inmates to starve to death, Bergen-Belsen Camp Commandant Josef Kramer – who was executed after a judicial farce,<sup>93</sup> although he did everything in his power to bring about an improvement in desperate camp conditions – went down in history as the “*Beast of Belsen*”, a history written by the victors, as is always the case.

## 5. ‘Gas Chambers’

### 5.1. Gas Chamber Stories Relating to Western Camps

All allegations of ‘gas chambers’ – by which we mean gas chambers intended for the killing of human beings – in National Socialist camps are based on ‘eyewitness’ testimonies and are not supported by German wartime documents (which survived the war by the thousands of tons). The ‘gas chambers’ of the “*extermination camps*” at Auschwitz and Majdanek are discussed by Germar Rudolf and Carlo Mattogno in the present book. The same authors prove that the structures in question, by reason of their architectural features, were unsuited for the killing of human beings with poison gas and, as a result, could never have been used for that purpose. The following comments are restricted to the claims of the ‘gas chambers’ in the western camps only.

There were numerous ‘eyewitness’ testimonies relating to these ‘gas chambers’ as well. At the Nuremberg Trial, a former camp doctor at Dachau, a Czech named Dr. Franz Blaha, testified as follows:<sup>94</sup>

*“The gas chamber was finished in 1944, and I was summoned by Dr. Rascher to examine the first victims. Of the 8-9 persons in the gas chamber, three were still alive, and the others appeared to be dead. Their eyes were red, and their faces were puffed”*

A fantastic description of the ‘gas chamber’ at Buchenwald was provided by a Frenchman named Georges Hénocque in 1947:<sup>95</sup>

<sup>92</sup> Quoted according to Robert Lenski, *The Holocaust on Trial: The Case of Ernst Zündel*, Reporter Press, Decatur 1990, p. 157f.

<sup>93</sup> At the Bergen-Belsen Trial, British defence council spoke very disparagingly about the prosecution witnesses and came to the conclusion that their testimony relating to the atrocities at Bergen-Belsen were lies. Raymond Phillips (ed.), *Trial of Josef Kramer and 44 Others (The Belsen-Trial)*, William Hodge and Company, London/Edinburg/Glasgow 1949, p. 76, 82, 89, 141, 244, 518, 524, 535, 544.

<sup>94</sup> *IMT*, vol. V, p. 198.

<sup>95</sup> G. Hénocque, *Les Antres de la bête*, G. Duraisie, Paris 1947, quoted according to Robert Faurisson, *Mémoire en défense*, La Vieille Taupe, Paris 1980, p. 192ff.

*“The room was perhaps five square meter wide and three to three and a half meters high. On the ceiling at irregular intervals were seventeen air-tight, sealed shower heads. They looked like ordinary shower heads. The deportees assigned to the crematorium had warned me of the manner in which the victims, to mock them, were all given a towel and a small bar of soap before entering the shower. The unfortunates were thus brought to believe that they were entering a shower.*

*The heavy iron door shut behind them – a door sealed by a half centimeter thick insulation strip of rubber, so that no air could get in. Inside, the walls were smooth, without cracks and looked as if they were lacquered. On the outside, next to the door frame, one could see four buttons, each one of which lay beneath the others: one red, one yellow, one green, and one white.*

*But one detail disturbed me: I didn’t understand how the gas could descend from the shower heads. Next to the room in which I was standing, was a passageway. I entered it and saw a gigantic pipe, so big that I could not reach all the way around it with my arms, a pipe that was covered with a rubber lining approximately one centimeter thick.*

*Next to the pipe was a crank, which turned from left to right, to cause the gas to enter the room. The pressure was so strong that the gas descended to the floor, so that none of the victims could escape what the Germans called the ‘slow and sweet death’.*

*Beneath the spot where the pipe entered the gas chamber were the same buttons as on the exterior door: one red, one green, one yellow, and one white. They were obviously used to measure the sinking of the gas. Everything was organized on a strictly scientific basis. The Devil himself could not have planned it better.”*

Many revisionists are of the view that orthodox historians have finally banished the ‘gas chambers’ of the western camps to the rubbish dump of history, but that is an inaccurate oversimplification.<sup>96</sup> In justification of this argument, they cite a letter to the editor written in 1960 by Martin Broszat, at that time an employee and later the head of Institut für Zeitgeschichte in Munich, in which he stated:<sup>97</sup>

*“No Jews or other inmates were gassed in Dachau or Bergen-Belsen or Buchenwald. [...] The mass extermination of the Jews by gassing began in 1941/1942 and took place exclusively in a few locations selected for this purpose and equipped with technical installations, particularly in occupied Polish territory (but nowhere in the Old Reich): in Auschwitz-Birkenau, in Sobibor am Bug, in Treblinka, Chelmno und Belzec.”*

Anyone who reads Broszat’s letter attentively recognizes that Broszat only expressly disputes any and all gassings for three camps (Dachau, Bergen-Belsen and Buchenwald). In relation to all other camps, he rules out “mass gassings” only, thus leaving open the possibility of gassing actions on a smaller scale. Such small-scale gassing actions are alleged in the well-known anthology *Nationalsozialistische Massentötungen durch Giftgas* (National Socialist Mass Killings with Poison Gas) edited by Kogon, Langbein, Rückerl, and others.<sup>98</sup> According to the same source, such gassings occurred in the camps of Ravensbrück, Sachsenhausen, Neuengamme, Mauthausen, Natzweiler, and Stutthof. In relation to Dachau, the editors are uncertain; no gassings are reported for Buchenwald and Bergen-Belsen, although numerous eyewitness testimonies confirming such gassings are available for precisely these camps. All such ‘eyewitness’ testimony, therefore, in the view of the editors, is false. Why the ‘eyewitness’ testimonies on gassings in Ravensbrück, Natzweiler, or any other camp should be any more credible, remains a mystery.

---

<sup>96</sup> In this regard, see the comments by Reinhold Schwertfeger, “*Gab es Gaskammern im Altreich?*”, *Vierteljahreshefte für freie Geschichtsforschung* 5(4) (2001), pp. 446-449 (online: [vho.org/VffG/2001/4/Schwertfeger446-449.html](http://vho.org/VffG/2001/4/Schwertfeger446-449.html)).

<sup>97</sup> *Die Zeit*, August 19, 1960.

<sup>98</sup> Eugen Kogon, Hermann Langbein, A. Rückerl, *et al.* (ed.), Fischer Taschenbuch Verlag, Frankfurt a.M. 1983; Engl.: *Nazi Mass Murder*, Yale University Press, New Haven 1993.

The intellectual level of the anthology is indicated, among other things, by the quoted description of the “*gas chamber*” (singular) at Mauthausen. As proof of their existence a sentence of a U.S. court is quoted, according to which the “*gas cells*” (plural) were pre-heated with a hot brick and then the gas was introduced “*on paper strips*”!<sup>99</sup>

In addition to eyewitness reports by former concentration camp inmates, numerous “*perpetrator confessions*” are also quoted. All these confessions were given under duress and are not worth the paper they are printed on. That members of the SS imprisoned in the western camps could be compelled to make any kind of ‘confession’ one wanted, is proven quite obviously by the deathbed ‘confession’ of Mauthausen commandant Franz Ziereis, who – dying from three bullet wounds in the stomach – stated the following on the ‘gas chamber’ at Hartheim castle near Linz:<sup>100</sup>

“*SS-Gruppenführer Glücks has given the order to declare weak inmates as insane and to kill them in a large installation with gas. Approximately 1 to 1.5 million were killed there. This place is known as Hartheim and lies 10 kilometers from Linz in the direction of Passau. These inmates were reported as having died of natural causes in the camp [Mauthausen].*”

Kogon, Langbein, Rückerl, and company are naturally not stupid enough to quote this passage from the Ziereis confession in their book. But if the Mauthausen commandant had spoken of a few thousand instead of “*1 to 1.5 million*” gassing victims at Hartheim, this part of the confession would certainly have been included as ‘irrefutable proof’ of the murders at Hartheim.

The number of gassing victims in all western camps, if we add up all the figures quoted in the above mentioned anthology, amount to some thousands only, and therefore, numerically speaking, are not necessary for the ‘Holocaust’, *i.e.*, the alleged systematic gassing of several million Jews. That the editors stubbornly insist upon these killings by means of poison gas can perhaps be explained by a desire to prove that National Socialist concentration camps, by their very nature, were fundamentally different from Russian, Chinese, French, and American concentration camps, etc., and were therefore simply diabolical. The diabolical nature of the camps is lent to them by the ‘gas chambers’ and, therefore, as many National Socialist concentration camps as possible must necessarily have possessed such installations.

On the other hand, mainstream historiography knows pretty well that abandoning any ‘gas chamber’ in any camp could be disastrous for other ‘gas chamber’ claims as well. After all, why should one believe any ‘eyewitness’ and any mainstream historian that there were ‘gas chambers’ in camps A and B, if it is a proven and acknowledged fact that all the ‘eyewitness’ testimonies and other evidence for camps C and D are fraudulent? Raul Hilberg, on the other hand, who never mentions any gassings in western camps in his 1,300-page work on the ‘Holocaust’,<sup>38</sup> is more pragmatic than the editors of the above mentioned anthology.

The most detailed documentation on the eyewitness testimonies on the gassings in the western camps so far is the *Second Leuchter Report*,<sup>101</sup> prepared under the leadership of Robert Faurisson. This booklet is an indispensable source of information for anyone interested in this matter.

## 5.2. A Revealing Example: The ‘Gas Chamber’ of Sachsenhausen

In his excellent study on Sachsenhausen,<sup>102</sup> Carlo Mattogno describes the origins of the legend of the homicidal ‘gas chamber’ in that camp. According to *Nationalsozialistische Massentötungen*

<sup>99</sup> *Ibid.*, p. 247.

<sup>100</sup> Simon Wiesenthal, *KZ Mauthausen*, Ibis-Verlag, 1946, p. 7f.

<sup>101</sup> Frederick A. Leuchter, *The Second Leuchter Report*, Samisdat, Toronto 1989 (online: [www.zundelsite.org/english/leuchter/report2/leucha.html](http://www.zundelsite.org/english/leuchter/report2/leucha.html)).

<sup>102</sup> C. Mattogno, *op. cit.*, (note 82).



*durch Giftgas*, Sachsenhausen commandant Anton Kaindl was assigned by Concentration Camp Inspector Richard Glücks to the construction of a gas chamber for the liquidation of inmates. The editors of the anthology quote a ‘confession’ to this effect by Kaindl, made in Soviet imprisonment, and continue:<sup>103</sup>

*“During the trial both Kaindl and former inmate Sakowski, who worked as executioner in the crematorium complex and was present during the gassings, described the gas chamber, which had an installation for the mechanical opening of the gas containers, a so-called ‘pressure ventilator’. He stood next to the outside wall of the gas chamber. The gas container was mechanically opened and the ventilator propelled the gas through a system of pipes, which could be heated, into the gas chamber.”*

A report drawn up by a group of Soviet experts in June 1945 contains a detailed description of the functions of this chamber.<sup>104</sup> As shown by Mattogno, every detail of the description corresponds to the features of an adapted Degesch circulation delousing installation using Zyklon B: the Soviet propagandists therefore turned a disinfestation installation intended for the destruction of vermin into a homicidal gas chamber! The dimensions of the chamber are indicated in the report as  $2.75 \times 3$  m<sup>2</sup>, reducing to an absurdity any notion that the chamber could have been used for the killing of large numbers of people. And if the SS had wanted to kill individual inmates, they could have simply shot them, instead of killing them in a highly complicated manner using a dangerous poison gas.

After the war, the Soviets used Sachsenhausen as a concentration camp for themselves. Gerhart Schirmer was a former German soldier who ended up in that camp right at the end of the war until he was transferred to a forced labor camp in Siberia in 1950. In his memoirs, Schirmer described briefly how he and other prisoners were forced by the Soviets to build a ‘gas chamber’ in Sachsenhausen half a year after World War II had ended:<sup>105</sup>

*“There exists a notarized, sworn affidavit about the construction of a gas chamber and a shooting facility during October/November 1945 by eight prisoners, of whom I was one (appendix 4). Briefly described, this ‘gas chamber’ was a shower room with 25 showerheads in the ceiling. This was supposed to give the impression that the gassing was conducted in it. Attached to this, we erected a separate chamber with an opening, in front of which the executee would sit facing the opposite side in order to receive a shot in his neck. At least this was what the guide had to tell [to Soviet visitors]. This [guide] was our Fritz Dörrbeck, a translator who had to play this theater because – born in Russia – he spoke perfect Russian.”*

This preposterous ‘gas chamber’ was obviously something of a headache to the Soviets and their puppets in the Communist, former German Democratic Republic, since the building in which it was allegedly located was torn down in 1952, thus destroying all incriminating and exonerating evidence.

### 5.3. Origins of the Gas Chamber Lie

The book *Le Mensonge d’Ulysse* by Paul Rassinier, later to become the founder of Holocaust revisionism, by means of an impressive example, shows the manner in which even the most improbable rumors were believed in the panic-stricken, hatred-impregnated atmosphere of the concentration camps. Over the entrance gate to Buchenwald camp, there was an inscription reading “*Jedem das Seine,*” a principle of ancient Roman law meaning: the principle of justice is to give each person

---

<sup>103</sup> E. Kogon *et al.*, *op. cit.* (note 98), p. 255.

<sup>104</sup> GARF, 7021-104-3, p. 2-4.

<sup>105</sup> Gerhart Schirmer, *Sachsenhausen – Workuta. Zehn Jahre in den Fängen der Sowjets*, Grabert, Tübingen 1992, p. 9, similar p. 36. Because of these passages, Schirmer’s memoirs were confiscated and destroyed by the German authorities in 2002 (tis brochure will soon be posted online at [vho.org/D/sw](http://vho.org/D/sw)).

that to which he is rightfully entitled.<sup>106</sup> Rassiniér, who knew German, understood the inscription. But among the other French inmates, a rumor quickly spread that the inscription in fact meant “*Abandon hope, all ye that enter here.*”<sup>107</sup>

Benedikt Kautsky, who experienced three concentration camps, described the witch’s brew of camp rumor-mongering as follows:<sup>108</sup>

*“The frivolity in the camp was incredibly great. Rumors, called ‘parolen’ by the Aryans and ‘bonkes’ by the Jews, swarmed around constantly and found willing listeners, no matter how nonsensical they might be. No matter how much the rumor-mongering ridiculed the camp (a common joke was ‘Will trade two old whoppers for one new one’), most people fell for the so-called ‘good old whoppers’ every time.”*

Dionys Lenard, former Majdanek inmate, had the following to say about rumor-mongering at Majdanek.<sup>109</sup>

*“I remember how I learned in the newspapers that the British had landed at Bologna. Great hope was placed in this occurrence. Everyone expected a collapse. But the hope refused to become reality. Most of the time, we didn’t believe the rumors. It was impossible to test all these unreal reports. [...] Once, somebody told me that the Russians were already in Lvov. It was said that artillery fire could already be heard. Another time, they told me that the German front in the north had collapsed and the Russians were already in Königsberg. They also told me that the Hungarians had laid down their arms and that the Italians had joined them. The Czechs and Serbs were fashionable for a certain time. They were said to have begun resistance on such a scale that the Germans had had to bring up 40 divisions against them. The Japanese on the other hand, were said to have concluded a peace treaty with the United States and Great Britain.”*

Very often, rumors like this did not arise spontaneously, but were the result of false reports deliberately spread throughout the camps by the resistance movement. That the reports on deliberate mass exterminations in the camps lack any real basis is obvious from the mere fact that the versions spread during the war often failed to accord with the post-war versions in any way. The following is an example.

In Auschwitz concentration camp, the resistance movement, beginning in 1941, fabricated an endless stream of horror stories and reports of mass killings of inmates. But the pesticide Zyklon B was never even mentioned; instead, in a constantly changing manner, the killings were said to be committed by means of “*electrical baths*”, combat gases and a “*pneumatic hammer.*”<sup>110</sup> Even after the liberation of the camp by the Red Army, the Soviet-Jewish war correspondent Boris Polevoi published a report on an “*electric conveyor belt*” upon which inmates were killed with “*electrical current.*”<sup>111</sup> The version in which Zyklon B became the murder weapon only became current during the following months.

The German-Jewish Communist Bruno Baum, in 1935 sentenced to ten years imprisonment for anti-government activity together with Erich Honecker, later president of Communist East Germa-

<sup>106</sup> It also was the national motto of Prussia.

<sup>107</sup> Paul Rassiniér, *op. cit.* (note 61), p. 26. The sentence “*Abandon hope, all ye that enter here*” appears over the gate to hell in Dante’s *Inferno*.

<sup>108</sup> B. Kautsky, *op. cit.* (note 60), p. 182f.

<sup>109</sup> Tomasz Kranz (ed.), *Unser Schicksal – eine Mahnung für Euch. Berichte und Erinnerungen der Häftlinge von Majdanek*. Państwowe Muzeum na Majdanku, Lublin 1994, p. 65.

<sup>110</sup> The text of the reports spread by the resistance movement relating to mass killings in Auschwitz have been reproduced by Enrique Aynat, *Estudios sobre el ‘Holocausto’*, Graficas Hurtado, Valencia 1994.

<sup>111</sup> *Pravda*, February 2, 1945.

ny, and transferred to Auschwitz from Brandenburg prison in 1943,<sup>112</sup> was, by his own admission, one of the most active fabricators of camp propaganda. After the end of the war, Baum wrote his memoirs,<sup>113</sup> which appeared in three different editions (published in 1949, 1957, 1961). The first edition, published in 1949, states as follows on page 34:

*“It is no exaggeration when I say that the majority of all Auschwitz propaganda, which was spread at that time all over the world, was written by ourselves in the camp.”*

One page later, Baum raises the ante:

*“We carried out this propaganda in [for] the world public until our very last day of presence in Auschwitz.”*

Baum thus generously admits that the reports were resistance movement “propaganda”. In the next edition, published in 1957, however, he states:

*“It is no exaggeration when I say that the greatest part of the publications on Auschwitz spread all over the world originated from ourselves [...] We informed the world in this manner until the very last day of our stay in Auschwitz.”* (p. 89)

Thus, “propaganda” became “publications,” by means of which the world was “informed”! Baum was transferred from Auschwitz to Mauthausen, where he assiduously continued his propaganda activity in the local camp resistance movement.

Just how industriously Germany’s military enemies propagated their atrocity stories becomes obvious from the following report by the Norwegian Erling Bauck, who was transferred from Sachsenhausen to Majdanek together with 13 other Norwegian inmates, where they were liberated:<sup>114</sup>

*“In the early fall of 1944, it was possible to read in the American newspapers and illegal Norwegian newspapers, that fourteen Norwegians had been executed in Lublin on orders from Berlin. That we were supposed to be the fourteen executed Norwegians proves that the order must have been issued at least four months earlier, when there were still fourteen of us.<sup>115</sup> We were all mentioned by name and inmate serial number. In November, the priest from Notodden received a letter signed by Ilya Ehrenburg in which the priest was requested to inform the father of the Brattli brothers that his sons were among the fourteen executed men. Papers found in the camp by the Russians stated that we were killed with Zyklon gas and then laid in an acid bath so that no mortal remains could be found.”*

Immediately after the liberation of Majdanek by the Red Army (on July 23, 1944) the Soviet-Jewish reporter Constantin Simonov wrote a report describing, among other things, the murder of former French Prime Minister Léon Blum in the same camp in the spring of 1943. In writing his report, Simonov relied on two eyewitnesses, P. Mikhailovic and C. Elinski, who described Blum’s last moments “in great detail”.<sup>116</sup> Radio Moscow gave solemn credence to this story. The French Communist newspaper *Fraternité* reported in August 1944:<sup>117</sup>

*“Radio Moscow reported the death of former Prime Minister Léon Blum, seventy years of age, who fell a victim to racist barbarism like so many of his fellow faithful.”*

<sup>112</sup> I am grateful to Knud Bäcker’s article, “Ein Kommentar ist an dieser Stelle überflüssig”, *Vierteljahreshefte für freie Geschichtsforschung* 2(2) (1998), notes 26, 29, for the information on Bruno Baum (online: [vho.org/VffG/1998/2/Baecker2.html](http://vho.org/VffG/1998/2/Baecker2.html)).

<sup>113</sup> *Widerstand in Auschwitz*, East Berlin.

<sup>114</sup> T. Kranz, *op. cit.* (note 109), p. 197.

<sup>115</sup> One of the Norwegians had died in the meantime, one was sent to the hospital and another was sent back to Sachsenhausen.

<sup>116</sup> K. Simonov, *Il campo dello sterminio*, Edizioni in lingue estere, Moscow 1944, p. 7.

<sup>117</sup> Stéphan Courtois, *Qui savait quoi? L’extermination des juifs 1941-1944*, Editions la Découverte, Paris 1987, p. 225.

The report of Léon Blum's murder in Majdanek was a total fabrication. In reality, Blum was deported to Buchenwald in 1943 and then transferred to Dachau, where he was liberated on May 4, 1945.<sup>118</sup>

The inmates took atrocity propaganda about the 'gas chambers' very seriously. The Polish historian Zofia Murawska writes as follows about Majdanek:<sup>119</sup>

*"In the fall of 1943 (September or October) trucks entered Field V, into which the SS men began to load the children; they tore them out of the hands of their unsuspecting mothers. Although the SS assured the mothers that their children would be cared for in homes under the protection of the Polish Red Cross, the mothers became desperately frightened, claiming that the destination of the journey was the gas chambers. In reality, the young inmates were placed in the children's camp in Lodz."*

In the judgment of the Majdanek Trial, the District Court of Düsseldorf stated as follows:<sup>120</sup>

*"The mass selection of human beings for killing by gassings was generally known in Majdanek concentration camp by the beginning of 1943 at the latest. The result of this was that a large number of inmates considered selections under similar circumstances – but in reality for other purposes, chiefly for transfer to other camps – to be selections for gassings."*

Carlo Mattogno comments in this regard:<sup>121</sup>

*"In fact, matters were the reverse of what the court assumed: since the selected inmates who were transferred elsewhere did actually disappear from the camp, those who remained behind became convinced that their departed comrades had been murdered. This conviction was strengthened by the fact that before leaving the camp, the selected inmates went through the showers and delousing, i.e., through Barracks 41 and 42 where delousing gas chambers were known to exist. This procedure left the remaining inmates with one powerful impression: their fellow prisoners had been sent to where the gas chambers were; they had not returned; consequently, they had been gassed."*

There is, therefore, no doubt that many former concentration camp inmates believed in the reality of the homicidal gassings in good faith. Let us quote B. Kautsky, who states the following in regards to the 'gas chambers' of Auschwitz:<sup>122</sup>

*"At this point I would like to give a short description of the gas chambers, which I never saw myself, but which were described to me so credibly by so many people that I cannot help but repeat their description here."*

Kautsky then proceeds to describe the 'gas chambers' which he never saw. This is not without irony, since he himself describes the camp rumor-mongering, hitting the nail right on the head:

*"No matter how much the camp ridiculed the rumor-mongering [...], most people fell for the so-called 'good old whoppers'."*

To the end of his life, Kautsky probably never imagined that he had himself fallen for the biggest of the "good old whoppers" in mentioning the 'gas chambers' and even described them!

## 6. Summary

### 6.1. Fiasco of Official Historiography

In view of these obvious facts, orthodox historians were unable to continue to uphold the claim of the extermination character of all National Socialist concentration camps. They were compelled to shift the scene of the alleged mass killings away from nearby locations, such as Dachau, Bergen-

<sup>118</sup> E. Jäckel, P. Longerich, J. H. Schoeps (eds.), *Enzyklopädie des Holocaust*, Argon, Berlin 1993, vol. I, p. 223.

<sup>119</sup> Z. Murawka, "Dzieci w obozie koncentracyjnym na Majdanku", in: *Zeszyty Majdanka*, X, 1980, p. 243.

<sup>120</sup> Landgericht Düsseldorf, vol. I, *Urteil Hackmann u.a.*, XVII 1/75, p. 88.

<sup>121</sup> J. Graf, C. Mattogno, *op. cit.* (note 79), p. 184.

<sup>122</sup> B. Kautsky, *op. cit.*, p. 272f.

Belsen and Buchenwald, to more remote alleged extermination camps located in the east, which was then in the Soviet sphere of influence and thus inaccessible to critical observers. In addition to the four so-called “*pure extermination camps*” of Treblinka, Sobibor, Belzec, and Chelmno, in regards to which there is almost no surviving documentary or physical evidence, Auschwitz-Birkenau and Majdanek were alleged to have been “*combined extermination and work camps*” in which Jews were killed in gas chambers in huge numbers. These claims are in direct contradiction to many verifiable facts destined to bring about the utter defeat of the orthodox historians:

As in the western camps, most of the deaths in Auschwitz and Majdanek were due to epidemics, with the difference that the death rate in both of the last two camps peaked in 1942 or 1943, while, in the western camps, the death rate peaked shortly before the end of the war, as a result of the German collapse.

Like the camp administrations of Dachau, Buchenwald, etc., the camp administrations of Auschwitz and Majdanek received repeated instructions to reduce the mortality rate at all costs and to improve inmate living conditions.

Large numbers of surviving documents from Auschwitz – the “*death camp*” par excellence – describe the medical care provided to keep the Jews alive who were allegedly destined for death.

In ‘proof’ of the exterminations in the eastern camps, the orthodox historians can produce only ‘eyewitness’ testimonies and ‘confessions.’ which are qualitatively no better than the corresponding, but discredited, testimonies and ‘confessions’ from the western camps. There is no discernible reason why the ‘confession’ of Auschwitz commandant Rudolf Höß relating to the gassing of 2.5 million people by November 1943 in Auschwitz alone<sup>123</sup> should be any more credible than that of Mauthausen commandant Franz Ziereis relating to the gassing of one to one and a half million people at Schloß Hartheim.

The orthodox historians are unable to explain why Jewish inmates who were allegedly destined for extermination were, in many cases, nevertheless transferred from one camp to another, without succumbing to extermination; or why Benedikt Kautsky, who, as a left-wing Socialist and Jew was doubly marked for extermination, survived Dachau, Buchenwald, Auschwitz, and, once again, Buchenwald; or why Israel Gutman, later co-editor of the *Encyclopadia of the Holocaust*, survived not only the “*extermination camps*” of Majdanek and Auschwitz but the “*ordinary concentration camps*” of Mauthausen and Gunskirchen as well;<sup>124</sup> or why the Polish Jew Samuel Zylbersztain survived to write a report entitled *Memoirs of an Inmate of Ten Camps*, describing his experiences in Majdanek, Auschwitz, and eight (!) other concentration camps.<sup>125</sup>

The orthodox historians must be deeply embarrassed by the release of 20,000 inmates from Majdanek “*extermination camp*,” each one of which must have been a witness to the cruelty of the “*mass exterminations*,” if any such exterminations ever took place there; or by the fact that the National Socialists released large numbers of inmates in the summer of 1944, in the midst of the alleged extermination of the Hungarian Jews. They cannot explain either why the Germans, during their withdrawal from Auschwitz-Birkenau, left 4,299 inmates behind, almost all of them Jewish, each of whom would have been an accuser of the Third Reich if the official version of Auschwitz squared with the historical facts.

In short: the orthodox history of the National Socialist concentration camps has reached the point of collapse.

---

<sup>123</sup> NO 3868-PS.

<sup>124</sup> *Nordwestzeitung*, Oldenburg, April 13, 1994.

<sup>125</sup> Samuel Zylbersztain, “Pamiętnik więźnia dziesięciu obozów”, in: *Biuletyn Żydowskiego Instytutu Historycznego w Polsce*, no. 68 (1968), pp. 53-56.

## 6.2. Breakdown in Civilization?

The orthodox historians and journalists never tire of yammering about an alleged “*breakdown in civilization*” represented by National Socialist concentration camps generally, and Auschwitz in particular. The alleged “*breakdown in civilization*” was also mentioned by *Spiegel* editor Fritjof Meyer in his now famous article on the number of Auschwitz victims.<sup>126</sup> In his reply to Meyer, Gernar Rudolf raised the question of whether or not the existence, at Auschwitz, of choir groups, orchestras, kindergartens, a dental clinic, a large kitchen, a microwave delousing installation, a swimming pool, and football field, truly represents a “*breakdown in civilization.*”<sup>127</sup>

After the war, the Jewish professor of medicine Marc Klein had the following to say, among other things, about his imprisonment at Auschwitz:<sup>128</sup>

*“To the loud applause of the viewers, football, basketball and water ball games were held on Sunday afternoon: men need very little to distract them from the threat of danger! The SS administration allowed the prisoners regular pleasures, even on weekdays. The prisoners were shown Nazi newsreels and sentimental films in a cinema, in addition to which a saucy cabaret put on shows which were often viewed by SS men. Finally, there was a very respectable orchestra initially composed exclusively of Polish musicians, but replaced, over time, by a team of first-class musicians of all nationalities, mostly Jews.”*

A “*breakdown in civilization*”? Anyone who reads James Bacque’s documentation *Other Losses*,<sup>129</sup> in which he describes the manner in which Eisenhower’s soldiers allowed German soldiers to die miserably by the hundreds of thousands, after the war, in camps without any infrastructures of any kind, without barracks, without medical care, totally exposed to rain and cold weather, dying of starvation because they were deliberately deprived of food – food which was available in large quantities – must wonder whether the “*breakdown in civilization*” was, in actual fact, a German phenomenon, or whether, on the contrary, it occurred as the result of the actions of quite different people.

<sup>126</sup> F. Meyer, “*Die Zahl der Opfer von Auschwitz – neue Erkenntnisse durch neue Archivfunde*”, in: *Osteuropa*, 52(5) (2002), pp. 631-641 (online: [vho.org/D/Beitraege/FritjofMeyerOsteuropa.html](http://vho.org/D/Beitraege/FritjofMeyerOsteuropa.html)).

<sup>127</sup> G. Rudolf, “*Cautious Mainstream Revisionism*”, in: *The Revisionist* 1(1) (2003), pp. 23-30 (online: [vho.org/tr/2003/1/Rudolf23-30.html](http://vho.org/tr/2003/1/Rudolf23-30.html)).

<sup>128</sup> M. Klein, *Observations et Réflexions sur les camps de concentration nazis. Extrait de la revue “Etudes Germaniques”*, Caen 1948, p. 31.

<sup>129</sup> James Bacque, *Other Losses*, Stoddart, Toronto 1989.



# Some Details of the Central Construction Office of Auschwitz

HANS JÜRGEN NOWAK AND WERNER RADEMACHER

## 1. Introduction

In 1992 the Moscow Central Archives made its holdings publicly accessible.<sup>1</sup> These include the – evidently not entirely complete – correspondence of the Central Construction Office of the Waffen-SS and Police of Auschwitz – some 83,000 documents.<sup>2</sup> This Construction Office was in charge of all matters relating to construction in the concentration and prisoner-of-war camps in the environs of Auschwitz. Auschwitz-Birkenau, the infamous camp belonging to this complex and generally described today as “*concentration and extermination camp*”, was designed and built by this Central Construction Office as a “*prisoner-of-war camp*”. Construction began in late 1941. Work proceeded as per a blueprint of the Special Construction Office of Auschwitz, dated October 7, 1941.<sup>3</sup> Construction Section BA Ia was completed in March 1942, and housed prisoners-of-war until August 1942. The designation of the camp was retained. A renaming does not become apparent until mid-April 1944, as of when the term “*KL-Auschwitz, Lager II*” (Concentration Camp Auschwitz, Camp II) was also used.

Up to early 1998, only a tiny fraction of the holdings of this archive had been tapped by three researchers, and a non-objective choice of documents on their part is obvious.<sup>4</sup> Since early 1998, a series of well-researched articles on a range of construction problems of the Auschwitz camp appears regularly in a German journal,<sup>5</sup> and a comprehensive monograph about the activities of the Central

---

<sup>1</sup> This archive underwent several name changes since 1991. It is now called *Rossiski Gosudarstvenni Vojenni Archiv (RGVA)*, Viborskaja ul't 3, Moskau.

<sup>2</sup> Index of this Archive: Heinz Boberach, *Inventar archivalischer Quellen des NS-Staates. Die Überlieferung von Behörden und Einrichtungen des Reichs, der Länder und der NSDAP*, 2 vols, ed. by IfZ, K.G. Saur, Munich 1991 and 1995.

<sup>3</sup> J.-C. Pressac, *Die Krematorien von Auschwitz. Die Technik des Massenmordes*, R. Piper GmbH & Co. KG, Munich 1994, p. 185

<sup>4</sup> Gerald Fleming, “*Engineers of Death*”, in *The New York Times*, July 18, 1993, p. E19; cf. F. Toben, “*Ein KGB-Novellist: Gerald Fleming*“, *Vierteljahreshefte für freie Geschichtsforschung (VffG)* 2(1) (1997) p. 87-91 (online: [vho.org/VffG/1997/2/Toben2.html](http://vho.org/VffG/1997/2/Toben2.html)), Jean-Claude Pressac, *op. cit.* (Note 3); Robert van Pelt, Deborah Dwork, *Auschwitz: 1270 to the Present*, Yale, University Press 1996; cf. review by Carlo Mattogno, “*Architektonische Stümpereien zweier Plagiatoren*”, *VffG*, 4(1) (2000), pp. 25-33 (online: [vho.org/VffG/2000/1/Mattogno25-33.html](http://vho.org/VffG/2000/1/Mattogno25-33.html)); English: “*Auschwitz 1270 to the Present*”, [www.russgranata.com/irving.html](http://www.russgranata.com/irving.html)); Robert van Pelt, *The Pelt Report, Irving vs. Lipstadt* (Queen’s Bench Division, Royal Courts of Justice, Strand, London, David John Cawdell Irving vs. (1) Penguin Books Limited, (2) Deborah E. Lipstadt, Ref. 1996 I. No. 113; for a detailed critique of van Pelt’s flawed *The Pelt Report* see Germar Rudolf, “*Gutachter- und Urteilsschelte*”, *VffG* 4(1) (2000), pp. 33-50 (online: [vho.org/VffG/2000/1/Rudolf33-55.html](http://vho.org/VffG/2000/1/Rudolf33-55.html)); Engl.: [vho.org/GB/Contributions/RudolfOnVanPelt.html](http://vho.org/GB/Contributions/RudolfOnVanPelt.html) and [.../CritiqueGray.html](http://vho.org/CritiqueGray.html)).

<sup>5</sup> M. Gärtner, W. Rademacher, “*Grundwasser im Gelände des KGL Birkenau*”, *VffG* 2(1)(1998), pp. 2-12 (online: [vho.org/VffG/1998/1/GaeRad1.html](http://vho.org/VffG/1998/1/GaeRad1.html)); H.J. Nowak, “*Kurzwellen-Entlausungsanlagen in Auschwitz*”, *VffG* 2(2) (1998), pp. 87-105 (online: [.../1998/2/Nowak2.html](http://vho.org/VffG/1998/2/Nowak2.html)); H. Lamker, “*Die Kurzwellen-Entlausungsanlagen in Auschwitz, Teil 2*”, *VffG* 2(4) (1998), pp. 261-272 (online: [.../1998/4/Lamker4.html](http://vho.org/VffG/1998/4/Lamker4.html)); W. Rademacher, “*Sauna ein ‘Verbrechen’?*”, *VffG* 1(4)(1997), pp. 245ff. (online: [.../1997/4/Rademacher4.html](http://vho.org/VffG/1997/4/Rademacher4.html)); M. Gerner, “*‘Schlüsseldokument’ ist Fälschung*”, *VffG* 2(3) (1998), pp. 166-174 (online: [.../1998/3/Gerner3.html](http://vho.org/VffG/1998/3/Gerner3.html)); Carlo Mattogno, “*‘Schlüsseldokument’ – eine alternative Interpretation*”, *VffG* 4(1) (2000), pp. 50-56 (online: [.../2000/1/Mattogno50-56.html](http://vho.org/VffG/2000/1/Mattogno50-56.html)); Engl: “*The Auschwitz Central Construction Headquarters Letter Dated 28 June 1943: An Alternative Interpretation*”, [www.russgranata.com/lalett.html](http://www.russgranata.com/lalett.html)); H.J. Nowak, W. Rademacher, “*‘Gasdichte’ Türen in Auschwitz*” *VffG* 2(4) (1998), pp. 248-260 (online: [.../1998/4/NowRad4.html](http://vho.org/VffG/1998/4/NowRad4.html)).



Construction Office was presented by Carlo Mattogno in the summer of 1998.<sup>6</sup> Two especially interesting findings resulting from a study of the Moscow archives will be summarized in the following.

## 2. Shortwave Delousing Facilities in Auschwitz

### 2.1. Introduction

A new discovery of immense significance is one about which Jean-Claude Pressac reports in his second book: the VHF delousing facilities.<sup>3</sup>

These facilities were actually used with phenomenal success, and not only in Auschwitz and Birkenau. It is only astonishing that to date – in other words, for 53 years – neither the deloused nor the delousing inmates nor any of the supervisory personnel have reported about these facilities that were present in both Auschwitz camps, as well as in other camps!

The high-frequency technique used here for the first time was far superior to all other delousing methods known at that time. Not only did it kill the lice and their nits, it also destroyed the bacteria that caused spotted fever – as small-scale tests performed by the manufacturer showed. The facilities were developed by the firm Siemens-Schuckertwerke in Berlin; preliminary tests were conducted in 1939.

In rather oversimplified terms, the microwave appliances used in almost every household today are the next generation. Only recently, on November 2, 1996, the press<sup>7</sup> reported that the Göttingen Institute for Agricultural Technology had developed a procedure for sterilizing foods that “*utilizes microwave energy and steam*” – exactly the procedure described in the documents at hand, but 55 years later.

The significance of this discovery is heightened when we consider that 55 years lie between the development of these facilities and our first knowledge of their use in those days – for this is how long the documents we speak of have been held under lock and key. This discovery confirms with great emphasis that research about Auschwitz is yet in its beginning stages.

Before we discuss the significance of the shortwave technology,<sup>8</sup> we shall give an overview of disinfestation and disinfection as a whole, with special attention paid to Auschwitz. We have at our disposal archival documents that permit a complete analysis. This goes equally for the technical, the medical and the organizational aspects.

### 2.2. Danger of Epidemics

We postulate as a given that in wars throughout history, for example in the American Civil War, epidemics caused more deaths among the soldiers and the civilians alike than did the use of weapons. It took the atomic bomb, deployed in ruthless and criminal manner by the United States against unarmed people, in contravention of international laws, to change this aspect of war.

The epidemic most feared at the eastern front in World War I was typhus or spotted fever.<sup>9</sup> Since that war – in which this epidemic claimed uncounted thousands of lives among the German soldiers at the Russian front and could be prevented from spreading into German territory after the end of the war only by the most rigorous of measures – the danger of epidemics has been firmly entrenched in the awareness of all medical and military offices and personnel.

---

<sup>6</sup> C. Mattogno, *La “Zentralbauleitung der Waffen-SS und Polizei Auschwitz”*, Editione di Ar, Padova 1998.

<sup>7</sup> (dpa) “*Lebensmittel in 3 Minuten keimfrei*”, *Münchener Merkur* no. 253, Nov. 2, 1996.

<sup>8</sup> Regarding technical development and method of operation of the facilities, cf. the two original studies, op.cit. (Note 5).

<sup>9</sup> Although caused by different bacteria, typhus and spotted fever (sometimes called typhoid fever) are frequently confused because they cause similar symptoms.

For example, the encyclopedia *Der große Brockhaus*, vol. 6 of the 1930 Leipzig edition, contains a comprehensive article on typhus fever and states that this acute infectious disease is spread only by the body louse:

*“The disease is caused by Rickettsia prowazeki (discovered in 1910 by Ricketts and in 1913 by Prowazek), a micro-organism found in the intestines and salivary glands of infected lice. [...]*

*Epidemic typhus occurs chiefly where unfavorable social and sanitary conditions prevail, in dark overcrowded living quarters, hospitals, prisons, emigration ships, caused by crop failures and price increases, thus also known as starvation, hospital, prison, ship or war typhus. Typhus is endemic in Russia, the Balkans, northern Africa, Asia Minor, and Mexico. According to Tarrassevich, 25-30 million people suffered from typhus in Russia in 1918-1921, which amounts to 20-23% of the population. [...]*

*Successful control and prevention of typhus consists of enforcing all measures available to destroy the body louse.”<sup>10</sup>*

Countless publications elaborated the topic further. Practical experiments were also conducted to increase man’s understanding of means for the successful control of the cause. For example, Dr. G. Peters reports in his work *“Blausäure zur Schädlingsbekämpfung”*<sup>11</sup> about the fumigation of ships with hydrogen cyanide, done in the United States as early as 1910, and about tunnel facilities which entire railway trains could drive into to be disinfested. Thus it is no surprise that Peters also mentions the quantity of hydrogen cyanide that is lethal when absorbed by humans, and therefore, Pressac’s claim<sup>12</sup> that the lethal dose was not known is completely false. It was also already a known fact in those days that HCN could be absorbed via the skin.

Professor Dr. F. Konrich was completely justified in stating, in his publication *“Über die Sanierungsanstalten der deutschen Kriegsgefangenenlager”*<sup>13</sup>, that epidemics such as that in question *“[...] had long been extinct here [in Germany].”* However, it also becomes quite understandable why all offices and institutions involved **over-reacted** totally when spotted fever was introduced to the concentration camp Auschwitz for the first time in early July 1942, brought in from outside by civilian laborers.<sup>14</sup> The spreading of the epidemic to the camp’s environs, *i.e.*, to the civilian population, had to be prevented.

## 2.3. Epidemic Control

### 2.3.1. Terminology Used

We shall use the technical terms established in the 1939 Army Regulations (Heeresdienstvorschrift 194),<sup>15</sup> since these determined how the personnel, *i.e.*, the physicians and those who disinfested the camps, were to proceed:

#### **“Disinfection**

*Disinfection means [...]: destroying the disease-(epidemic-)causing agents on objects, in rooms, in excretions and on the bodies of infectious persons.*

<sup>10</sup> The *Brockhaus* encyclopedia refers to the article by A. Schittenhelm, “Flecktyphus” in *Handbuch der Inneren Medizin*, 2nd ed., 1925.

<sup>11</sup> Gerhard Peters, *Blausäure zur Schädlingsbekämpfung*, Ferdinand Enke Verlag, Stuttgart 1933.

<sup>12</sup> Jean-Claude Pressac, *Auschwitz: Technique and Operation of the Gas Chambers*, Beate Klarsfeld Foundation, New York 1989, p. 148.

<sup>13</sup> Friedrich Konrich, “Über die Sanierungsanstalten der deutschen Kriegsgefangenenlager”, *Gesundheits-Ingenieur*, July 19, 1941, pp. 399-404.

<sup>14</sup> Cf. W. Stromberger, “Was war die ‘Sonderbehandlung’ in Auschwitz?”, *Deutschland in Geschichte und Gegenwart*, 44(2) (1996), pp. 24-25.

<sup>15</sup> H.Dv. 194. *Entseuchungs- und Entwesungsvorschrift für die Wehrmacht*, (Ents. V.) Verlag der Reichsdruckerei, Berlin 1939.

### ***Disinfestation***

*Disinfestation means: ridding rooms, objects and people of vermin (small life forms) that can transmit pathogens, cause economic damage or annoy man."*

The regulation quoted lists all physical and chemical means of disinfection and disinfestation that were known. Similarly, a “work guideline” was released in 1943 by the Sanitation Institute of the Waffen-SS: “*Entkeimung, Entseuchung und Entwesung*”<sup>16</sup> (Sterilization, Disinfection and Disinfestation).

The authority in charge of sanitation in the Waffen-SS as well as in the concentration camps was the “*Hygieneinstitut der Waffen-SS*”<sup>17</sup> (Sanitation Institute of the Waffen-SS), established in 1942 in Berlin, which set up a branch office in Rajsko near Auschwitz, with its “*Hygienisch-bakteriologischen Untersuchungsstelle Südost d. W-SS*” (Sanitary and Bacteriological Testing Station Southeast of Waffen-SS). The files<sup>18</sup> from this testing station have survived (151 volumes dating from 1943 to 1945).<sup>19</sup> To date we know of approximately 110,000 laboratory tests. Many informative documentary facsimiles are reproduced in the *Hefte von Auschwitz*.<sup>20</sup> It is unfortunate that research generally underestimates the historical value for Holocaust studies of these books.

The garrison physician (army medical officer) and the medical personnel were in charge of implementing all sanitary measures. This physician – and this was the case in Auschwitz as well – was to be consulted as subject expert in all relevant matters of construction planning. Where hydrogen cyanide and T-gas were to be used, requirements even called for specially trained expert personnel. In Auschwitz, this role was filled by the “*disinfectors*”.

On September 9, 1942, Dr. E. Wirths was stationed here as garrison physician for the time period at issue. From the records we can say that he fulfilled his duties correctly, and in this context we refer particularly to his massive criticism, directed to the highest echelons.

### 2.3.2. Procedures Used

We shall confine our analysis to procedures used in Auschwitz primarily before the outbreak of the first spotted fever epidemic, since the latter outbreak resulted in considerable changes in the camps. We draw our data from the listing dated January 9(?), 1943: “*Hygienische Einrichtungen im KL und KGL Auschwitz*”<sup>21</sup> (Sanitary Facilities in the POW and Concentration Camp Auschwitz) directed to the Amtsgruppenchef C (Berlin), and a “*Aufstellung über die im KL und KGL. Auschwitz eingebauten Entwesungsanlagen Bäder und Desinfektionsapparate*.”<sup>22</sup> (List of Disinfestation Facilities, Baths and Disinfection Apparatus Installed in the POW and Concentration Camp Auschwitz), dated July 30, 1943. All the facilities listed therein were subject to modifications. The number of sanitary facilities increased with the number of inmates, as the two aforementioned documents already show. In his first book, on p. 550, Pressac mentions 25 chambers operated with Zyklon B. However there is no verifiable listing provided.

---

<sup>16</sup> Walter Dötzer, *Entkeimung, Entseuchung und Entwesung*, in J. Mrugowsky (ed.), *Arbeitsanweisungen für Klinik und Laboratorium des Hygiene-Instituts der Waffen-SS*, 2nd., unchanged ed.. Urban & Schwarzenberg, Berlin and Wien 1943.

<sup>17</sup> RGVA 502-1-26-117.

<sup>18</sup> Heinz Boberach *et al.*, *op. cit.* (Note 2), vol. 3/2, K. G. Saur, Munich 1995.

<sup>19</sup> *Ibid.*, vol. 3/1, 1991.

<sup>20</sup> *Hefte von Auschwitz* 1 to 19, special issues, Verlag staatliches Auschwitz-Museum, as of 1959.

<sup>21</sup> RGVA 502-1-332-46/46a. Since the document is in poor condition and barely legible, we shall dispense with a reproduction of it here.

<sup>22</sup> RGVA 502-1-332-9/10. This document is also in poor condition; the efficiency data are transcribed in our original work, *op. cit.* (Note 5).

### 2.3.3. Results

Results could be reliably assessed only if the total number of people disinfested in these facilities is known. We have chosen for this analysis a document that is beyond all doubt, from an 18-page report about a September 25, 1942, visit of SS-Obergruppenführer and General of the Waffen-SS Pohl to Auschwitz.<sup>23</sup> The report is the typical work of an aide-de-camp. The “*overview of total labor expenditure*”, contained therein, including “*persons unable to work, and persons concert for duty*”, ends on Sept. 25, 1942, with a total of 28,207 persons. The calculated capacity of the various parts of the camp is given as follows:<sup>24</sup> “*preventive detention camp [concentration camp; auth.], 15,000*” and “*camp Birkenau [POW camp; auth.], 12,000 men and 18,000 women.*” Thus, a total of 45,000 persons.

It is not yet possible to say for certain whether the delousing facilities that were available at that time were consistently adequate for the number of persons stated. In his second book,<sup>25</sup> Pressac sets the height of the first epidemic at “*from September 7 to 11*”, with “*375 deaths per day*”.

### 2.3.4. Policy Decisions

Two policy decisions made by the *SS-Hauptamt Haushalt und Bauten* in the Reich Administration of the SS and its successor no doubt also influenced the measures taken in the camp. The first decision of June 5, 1940,<sup>26</sup> stated that HCN would no longer be used, and replaced instead with a hot-air method. The second, issued on March 11, 1942,<sup>27</sup> 21 months later, instead called for the “[...] *conversion of all delousing facilities to operation with HCN.*” A further letter from the Office C VI of February 11, 1943,<sup>28</sup> to the Commandant then again expressly states, probably with reference to the letter of June 5, 1940: “[...] *as per the prohibition against the use of HCN for disinfestation [...]*”.

Now, if one puts oneself into the shoes of those in charge of the camps, one gains some idea of the situation that resulted from these decisions. It may have been what prompted the renovation of “*Bunkers 1 and 2*”. To clarify this, it is necessary to know how and where and when buildings were in fact constructed in Birkenau at this time. We do have some documents that indicate an “*extant building*” in Sector BA III which housed appropriate facilities, but as yet we doubt that this evidence is conclusive.

Men in positions of authority who are used to making decisions, who are faced with a dangerous epidemic that could also spread to the civilian population with incalculable consequences, find a way out of this situation, and act on it! Hydrogen cyanide (= Zyklon B) was the most reliable disinfestation agent at that time. (For details the reader is referred to “*Blausäure als Entlausungsmittel in Begasungskammern*”,<sup>29</sup> or “*Entlausung mit Zyklon-Blausäure in Kreislauf-Begasungskammern*”.<sup>30</sup>) The only choice was that of a safe location for such facilities. We have not yet finalized the further logical consequences to be drawn from the policy decisions and the relevant documents, but perhaps they are logically inevitable: namely, to use buildings far from the camp barracks.

---

<sup>23</sup> RGVA 502-1-19-86/103.

<sup>24</sup> RGVA 502-1-19-86.

<sup>25</sup> J.-C. Pressac, *op. cit.* (Note 3), p. 157.

<sup>26</sup> RGVA 502-1-333-145.

<sup>27</sup> RGVA 502-1-336-94.

<sup>28</sup> RGVA 502-1-332-37.

<sup>29</sup> Gerhard Peters und W. Rasch, “*Die Blausäure als Entlausungsmittel in Begasungskammern*”, *Der praktische Desinfektor*, September 1941, pp. 93-96.

<sup>30</sup> Gerhard Peters, E. Wüstinger, “*Entlausung mit Zyklon-Blausäure in Kreislauf-Begasungskammern. Sach-Entlausung in Blausäure-Kammern*”, *Zeitschrift für hygienische Zoologie und Schädlingsbekämpfung*, issue 10/11 (1940), special reprint. RGVA 502-1-332-86/90. Received by the Construction Office of Auschwitz on July 3, 1941.

### 2.3.5. The Army Medical Officer

The situation did not end with the number of inmates given, nor at only one epidemic. Therefore, we shall briefly summarize by means of examples which conclusions this physician came to and what steps he took.

On December 4, 1942, Dr. Wirths reported to headquarters about a discussion held in the administrative council of Bielitz District.<sup>31</sup> The subject was spotted fever. A considerable number and range of persons had participated in the discussion, from the medical officer to the Wehrmacht to representatives of the government. This shows how seriously the epidemic was taken to be:

*“He reports that at present three large disinfection, shower and sauna facilities could be put into operation, specifically two facilities for the inmates and one for the members of the SS troops. The capacity of these facilities is some 3,000 to 4,000 persons per 24 hours. Zyklon B disinfection has been discontinued entirely, since it has been found that success is not 100% certain with this procedure.”*

Buildings BW5a and 5b were intended for the inmates. The capacity of these disinfection facilities was probably adequate for the number of inmates at this time. One must consider, however, that at this same time the structural shell for another 19 DEGESCH circulation fumigation chambers (normal gas chambers = serial type; cf. the publication *Die kleine Testafibel über Normal-Gaskammern* by Tesch and Stabenow<sup>32</sup>) was being completed in Building BW160 of the Main Camp (Admissions building). Pressac has called the above term for the gas chamber an “*incredible error*” on the part of Jährling, a civilian employee and the Central Construction Office’s official in charge of heating questions.<sup>33</sup> In actual fact, however, it has been shown that it was instead a typical error in judgment on the part of Mr. Pressac. The publication explaining these gas chambers<sup>30</sup> bears the Auschwitz Construction Office’s date-of-receipt stamp from July 3, 1941. We shall return to this point later.

Another paragraph of the above letter states that the garrison physician of Kattowitz had provided the loan of two mobile boiler installations. On April 18, 1943, Wirths reports to the Commandant, with warning reference to the sewer system in Birkenau, and concludes that “[...] *great danger of epidemics is inevitable.*”<sup>34</sup>

On May 7, 1943, in a discussion with the chief of Amtsgruppe C, SS Brigadier General and Major General of the Waffen-SS engineer Dr. Kammler, and others, the garrison physician set out in section “*II. Bauten in Zuständigkeit des Standortarztes*” (II. Buildings Under the Charge of the Garrison Physician):<sup>35</sup>

*“[...] that the continued health of the inmates for the major tasks is not guaranteed, due to the poor toilet conditions, an inadequate sewer system, the lack of hospital barracks and separate latrines for the sick, and the lack of washing, bathing and disinfection facilities.”*

Dr. Wirths clearly pointed out the inadequacies, and also how to rectify them.

At this point we must warn the reader, who may perhaps not be sufficiently aware of the historical context, not to jump to false conclusions. The reader may well lack an understanding of all the problems that were involved in obtaining materials as well as all the other necessities required to build these facilities in wartime. For every brick – figuratively speaking – it was necessary to obtain permission for purchase. We must also point out that a sewer system of any kind at all was already ex-

---

<sup>31</sup> RGVA 502-1-332-117/119.

<sup>32</sup> As quoted by W. Dötzer, *op. cit.* (Note 16).

<sup>33</sup> J.-C. Pressac, *op. cit.* (Note 3), p. 114; cf. Mattogno, “*Auschwitz: Das Ende einer Legende*”, in H. Verbeke (ed.), *Auschwitz: Nackte Fakten*, Vrij Historisch Onderzoek, Berchem 1995, pp. 101-162 (online: [vho.org/D/anf/Mattogno.html](http://vho.org/D/anf/Mattogno.html); Engl.: [vho.org/GB/Books/anf/Mattogno.html](http://vho.org/GB/Books/anf/Mattogno.html)).

<sup>34</sup> RGVA 502-1-332-219.

<sup>35</sup> RGVA 502-1-233-33/38.

emplary in those days, and this goes all the more for sewage treatment facilities, which were built for both camps with a great investment of resources and in a technically outstanding fashion.

The document last quoted continues:

*“The Brigadier General acknowledges the foremost urgency of these matters and promises to do everything possible to ensure rectification of the shortcomings. He is somewhat surprised, however, that on the one hand, the medical side presents him with reports giving a very favorable account of the sanitary and hygienic conditions, and on the other he is then immediately confronted with reports to the exact opposite effect. The Chief of the Central Construction Office is hereby instructed to present suggestions for rectification by May 15, 1943.”* (Emphasis added.)

Given the widespread disinformation, we consider it appropriate to also speak of the physicians of Auschwitz themselves, that is, of their tasks and activities, based on the files in our possession. The relevant files reposing in the Auschwitz Archive would of course be better suited to this, but to date we have not been able to review them. From a physician who spent a brief time on a cursory review, we are aware of the bulk of these holdings. In his words: “A *gigantic amount*.” For example, the infirmary records have been preserved in their entirety up to 1943. The garrison physician of Auschwitz took care of everything that was his job, and much more. We shall thus mention only a few particulars that relate to our present topic. It began with the toilet facilities; here he enforced changes which he considered necessary. For example: lids on the toilets, because otherwise “[...] a great danger of epidemics is inevitable.”<sup>36</sup> These lids were ordered by the Amtschef C of the WVHA (Economic Administrative Main Office) on May 10, 1943.<sup>37</sup> It ended with roofing matters related to the gypsy kindergarten:

*“For the damaged roofs of kindergarten blocks 29 and 31 in the Gypsy Camp I request 100 rolls of roofing felt (very urgent).”*<sup>38</sup>

In between, on May 28, 1943,<sup>39</sup> he selected six circulating air delousing facilities which – as was noted down by hand – were ordered on May 29, 1943, by the Construction Office’s expert on heating matters, Jährling. Then there is an account of a water quality test on June 1, 1943,<sup>40</sup> etc. This extensive correspondence resulted in separate subject files in the filing system of the Central Construction Office, such as “*Sanitary Conditions*”.<sup>41</sup>

The physician’s field of work was great and varied indeed. Even ensuring that the inmates’ kitchen personnel be frequently examined – including laboratory tests of their stool, etc. – was part of his job. Dr. Wirths truly saw to absolutely everything! This is evident from the documents.

One comment made by Pressac<sup>42</sup> strikes us as highly important; he concludes from “[...] *Dr. Wirths’ blunt report of April [...]*” that “*the terms ‘Sondermaßnahme’ and ‘Sonderbaumaßnahme’ [special measures and special construction measures] [...] are not used in a criminal context [...].*” Evidently Pressac has realized by now that the German prefix ‘Sonder-’ [special] has no negative connotations whatsoever – rather the opposite. The garrison physician’s reminders and admonitions even increased over time. We shall return to this later.

On balance one must conclude that, just as today, while there were “*opportunists*” and “*careerists*” in those days, there were also – as our example shows – SS-men with backbone and a sense of duty, professional ethics and the courage to stand up for their beliefs.

<sup>36</sup> RGVA 502-1-322-219.

<sup>37</sup> RGVA 502-1-322-31.

<sup>38</sup> From a letter dated March 23, 1944, to the Central Construction Office, RGVA 502-1-332-175.

<sup>39</sup> RGVA 502-1-332-28.

<sup>40</sup> RGVA 502-1-332-212.

<sup>41</sup> RGVA 502-1-149-135.

<sup>42</sup> J.-C. Pressac, *op. cit.* (Note 3), p. 105, Note 256.

At the end of the comments section of the Memorandum of May 9, 1943, we find:

*“As stop-gap measure until that time, the Brigadier General provides the loan of a new shortwave delousing train.”* (Emphasis added.)

## 2.4. Shortwave Delousing Facilities

### 2.4.1. History of the Shortwave Facilities

Together with the Siemens-Reiniger Werke AG, which developed medical instruments, the Siemens-Schuckertwerke GmbH (henceforth called SSW) developed the shortwave facilities after the outbreak of the war brought with it the problem of pest extermination. At that time, the German eastern border was also the border for lice and fleas and other vermin. This new means of combating pests was directed first and foremost at lice as the carriers of spotted fever. The aim was, on the one hand, to improve upon the long exposure times necessary for hot-air or gas methods, and on the other hand, to find a means that would also kill off the spotted fever microorganisms, as well as to improve efficiency.

Together with the Reich Biology Institute in Dahlem, led by Professor Dr. Hase, SSW conducted successful tests in the high-frequency field of a shortwave transmitter. In operating the transmitter that had broadcast the 1936 Olympic Games it had already been found that shortwave frequencies had previously unknown effects on insects. These tests were then demonstrated to civilian and military authorities. Soon the advantages of these new facilities over the ones used previously became apparent. Once considerable difficulties were overcome, they achieved not only a great throughput in a very short treatment time, but also absolute certainty in the killing of lice and nits. The pests were dead only 1 to 2 seconds after the shortwave field was activated. What was more, the typhus bacteria could also be killed in the process. The suitability of these facilities for large camps aroused the interest of the Reichsführung-SS.

Many different kinds of camps grew up in the course of the war. Today, particularly maps in Polish books<sup>43</sup> show the large number (5,877) of these camps in what used to be the “*General Government*”. These were not all concentration camps. There were considerably more labor camps and others. Next to almost every larger factory there was a “*guest or foreign workers’ camp*”. However, here is not the place to go into greater detail on this topic. Large sectors of German industry, for example, were transferred into areas which, for the time, were not accessible to the bomber planes of Germany’s enemies. Industries essential to the war effort were not moved underground until later. We refer the reader to the immensely informative book *Siemens 1918-1945*.<sup>44</sup> A detailed, information-packed and relevant reference section is included. On page 168, for example, we read:

*“On May 31, 1944, 7.126 million foreign workers were employed on the territory of the Reich; by fall the number had risen to about 7.7 million.”*

In *Heft von Auschwitz* issue 14,<sup>45</sup> other camps are also named:

*“In 1943 there were more than a dozen secondary camps in Gliwice [Gleiwitz; auth.], and in Upper Silesia there were more than 225 camps for inmates, prisoners-of-war and forced laborers.”*

It took personnel and materials support from the SS-Reichsführung to continue developing the high frequency facilities. Interest grew when these developments were demonstrated. The Wehrmacht (Army) ordered a first installation for its own use which, however, was never completed.

---

<sup>43</sup> *Obozy hitlerowskie na ziemiach polskich 1939-1945*, Państwowe Wydawnictwo Naukowe, Warschau 1979 (Encyclopedia).

<sup>44</sup> Wilfried Feldenkirchen, *Siemens 1918-1945*, R. Piper GmbH & Co. KG, Munich 1995.

<sup>45</sup> *Hefte von Auschwitz*, no. 14, Verlag staatliches Auschwitz Museum, 1973.

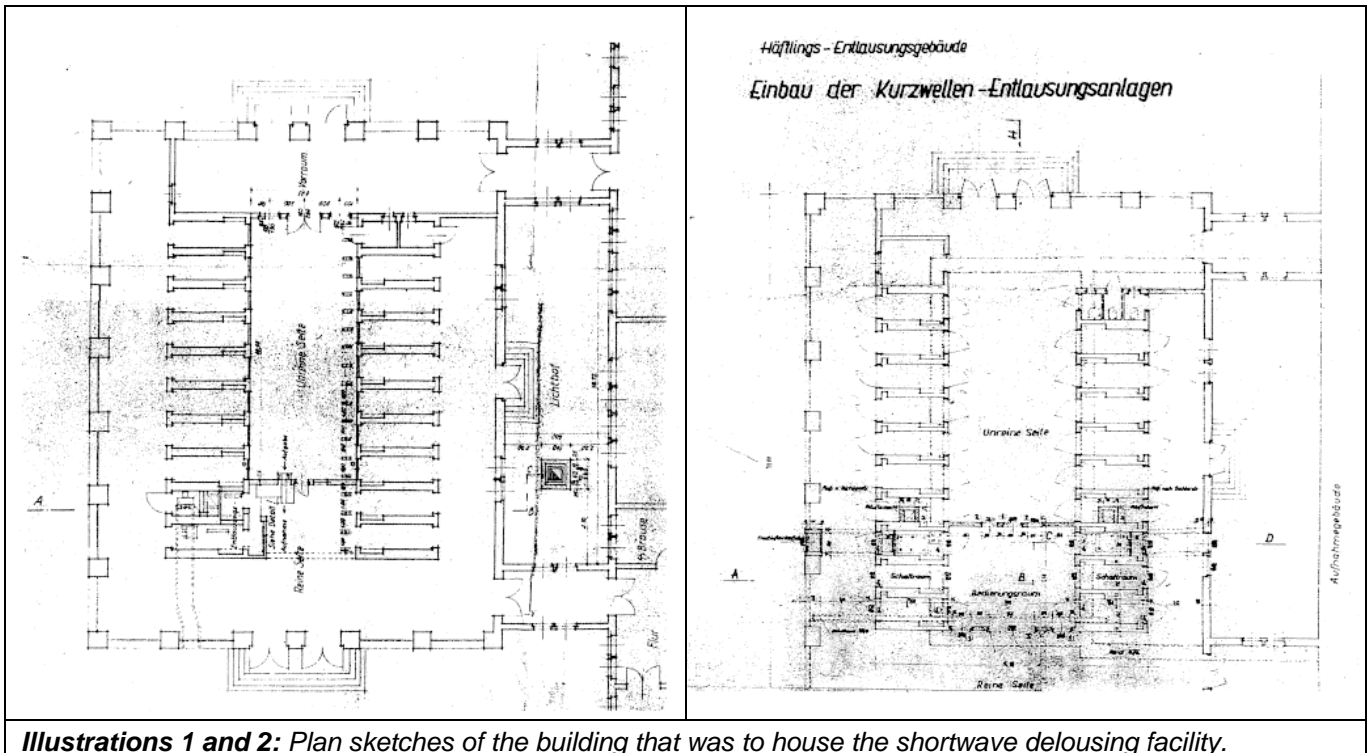

**Illustrations 1 and 2:** Plan sketches of the building that was to house the shortwave delousing facility.

### 2.4.2. Orders

Not so the SS; they ordered five facilities to begin with, and after the first mobile one (“*Osten II*”) proved effective in Lublin in 1943 they ordered another five stationary facilities. The aforementioned mobile installation fit onto the trailer of a truck manufactured by Dromos-Werke of Leipzig. Operating the installation merely required a 380-volt mains connection or a portable electrical generator. There is a privately-owned film about this facility which was probably filmed in Lublin; unfortunately it is not very instructive, as it does not show the interior of the truck trailer. The main part of the process is the introduction of the parcels of clothing sideways into the vehicle on the conveyor belt. To date the owner of the film is reluctant to publish it because he fears the persecution that might result from such an action.

### 2.4.3. Commission

Initially these facilities were supposed to be constructed for the front-line troops; thus, they were to be mobile (on wheels) and capable of delousing the gear of 400 men per hour. As developments progressed, the stationary model was given preference. These were to be set up at troop reassignment centers. The facilities were to be accessible within a few hours or at most a day.

### 2.4.4. Development

The first mobile installation “*Osten II*” was developed further into the stationary facility “*Osten III*” for the Auschwitz Main Camp. Eventually it was installed in the building intended for it, BW160 in the Main Camp, which was under construction at that time. Initially 19 Zyklon B delousing chambers were supposed to be built in this facility, but this never happened – perhaps as a result of the development of the ultra-shortwave facilities. Instead, while retaining the function of the rest of the building, the shortwave facility was planned for installation in four of the chambers (*illustra-*



tion 1, previous page).<sup>46</sup> Only a short time later the plans were expanded, that is, modified to be expandable over eight chambers<sup>47</sup> (illustration 2, previous page). We even have a photo of the shortwave facility that was in service (illustration 3),<sup>48</sup> as well as the installation plan for the facility itself. We also have the further planning documents, including mass calculations and detail plans. Fifteen inmates were put to work operating the disinfection facility. A temporary heating system also had to be built in order to operate the showers installation.

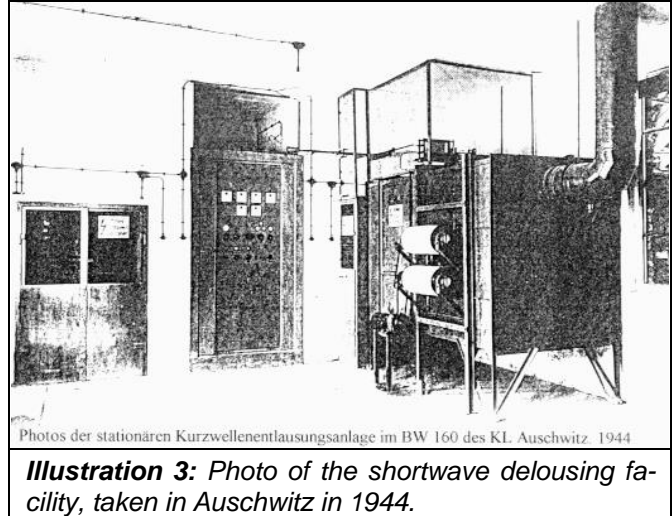

#### 2.4.5. Method of Operation of the Shortwave Facilities

The louse-infested clothing was dampened slightly with a spray-gun. A photo shows this process as it was performed in Auschwitz.<sup>48</sup> Then the bagged clothing was piled into bundles of 12 × 40 cm in cross-section and placed on transport belts, which carried it through the high-frequency generator's capacitor field. Efficiency was 400 kilograms clothing per hour.

#### 2.4.6. Installation of the Shortwave Delousing Facilities

Delivery of the first facility was promised for May 15, 1943.<sup>49</sup> This probably led to many a planning debacle, for example that other, expensive delousing facilities could not be built or completed because a quick delivery of the shortwave facility was expected. Reasons for the delays that occurred may have included SSW's underestimation of the development work that was yet necessary, or the increasing difficulty in obtaining materials, and of course also the destruction of parts of the manufacturing plant in bombing attacks. Only on June 18, 1943, Amt C of the WVHA stated additionally that the shortwave facilities had been assigned top priority.<sup>50</sup>

In a discussion on June 30, 1943, Dr. Willing of Amt C/3 stated<sup>51</sup> that

*"[...] after a pass through the ultra-shortwave field, which takes 11 to 12 seconds, all vermin as well as bacteria, germs, brood and nits are killed, and given non-stop operation, 13,000 to 15,000 pieces of clothing can be sterilized in one day."*

The installation of the mobile unit was carried out between July 16, 1943, (commission) and October 21, 1943 (last requisition of materials). The operation is documented right down to virtually the last screw.<sup>52</sup> The relevant files show not only that the parties involved in Auschwitz made all necessary preparations as quickly as possible, but also – and this is an important point to consider in an overall assessment – that they relied fully on the promises made them.

<sup>46</sup> RGVA 502-2-146.

<sup>47</sup> RGVA 502-2-149.

<sup>48</sup> Siemens archives, Munich. We thank an observant reader of *VffG* (yet to be kept anonymous) for discovering these valuable documents.

<sup>49</sup> RGVA 502-1-333-103.

<sup>50</sup> RGVA 502-1-333-34.

<sup>51</sup> RGVA 502-1-333-103/104.

<sup>52</sup> RGVA 502-1-316-356/367.

**KURZWELLEN-ENTWESUNGS-ANLAGE**

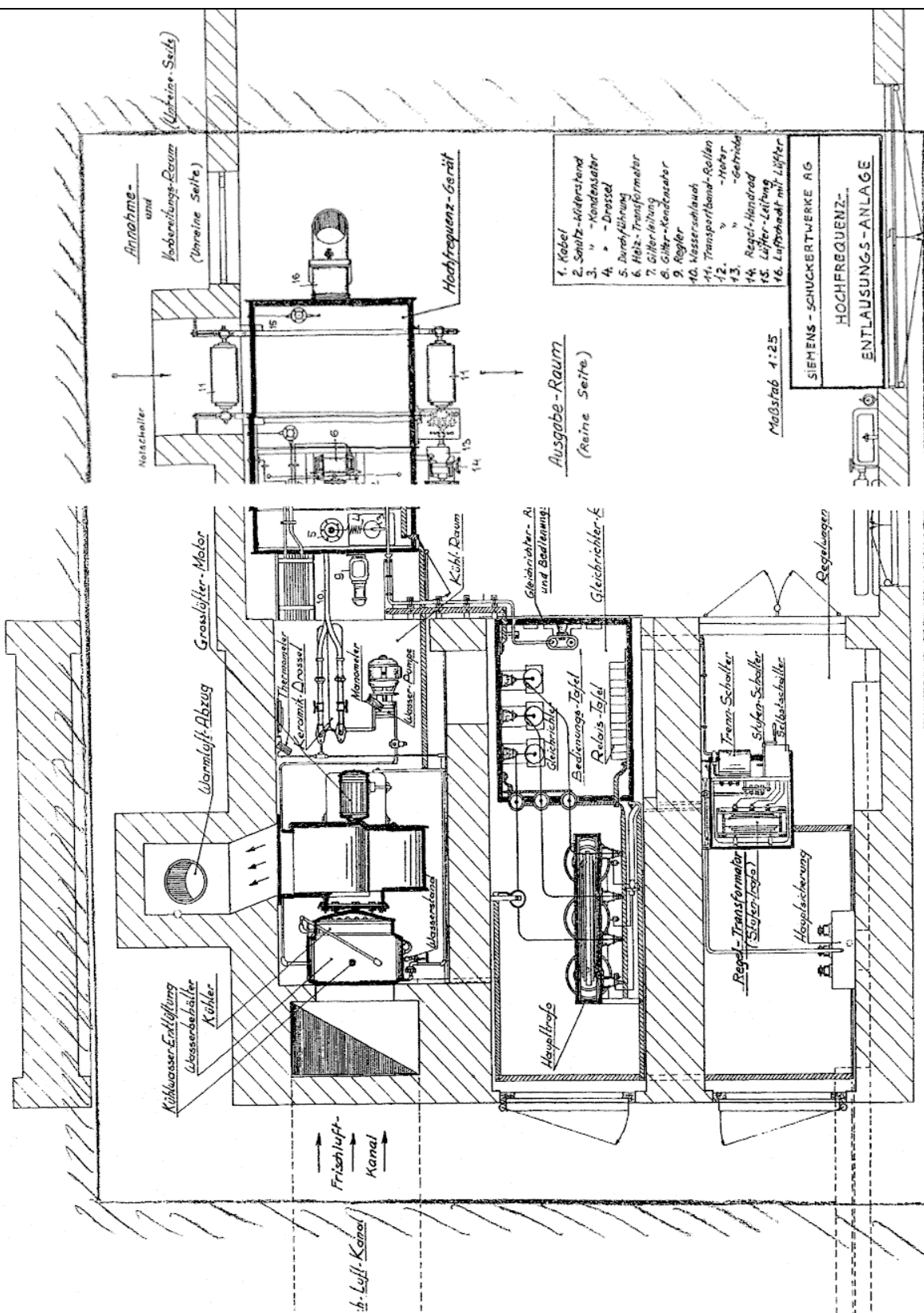

**Illustration 4:** Construction sketch of the shortwave delousing facility by Siemens-Schuckert, from the Second World War. (A section is missing in the middle. Source: Siemens archives, Munich.)

On July 15, 1943, the garrison physician confirmed<sup>53</sup> that it had been stated in the discussion of July 1, 1943, that

“[...] *the stationary shortwave delousing facility will be ready to begin operation in an estimated eight weeks, but that the mobile one will have arrived in the concentration camp Auschwitz in three weeks at the latest.*”

These deadlines were not met. In the listing of July 30, 1943,<sup>54</sup> delivery of both units is announced for “*early October*”. Further, the hourly capacity of each unit is given as “= 625 men = 15,000 men” per 24 hours. Thus, the total capacity of both shortwave facilities amounted to the clothing of 30,000 persons per day. On August 27, 1943, the construction costs of the stationary facility are given as RM 98,000,<sup>54</sup> which translates into approximately DM 1,568,000 today (ca. \$870,000). A notice of December 11, 1943,<sup>55</sup> stated that the materials and apparatus had already been received. The installation date for SSW is given as January 16, 1944, at the earliest. Work actually began on February 16, 1944.

A second stationary shortwave delousing facility for the Birkenau camp is first mentioned in March 1944.<sup>56</sup> In a telex of May 25, 1944, the Chief of Amt C III ordered that

“[...] *the shortwave delousing train be started on the road from Breslau to Auschwitz immediately.*”<sup>57</sup>

The stationary shortwave facility went into operation on June 30, 1944.<sup>58</sup> On the initiative of the garrison physician a test of the facility’s bacteria-killing effect was performed on July 29, 1944, by Dr. Weber, the Chief of the Waffen-SS Sanitation Institute; the results of this test may perhaps re-appear in Auschwitz in the files held there.

On Aug. 10, 1944,<sup>59</sup> the garrison physician reported to the Chief of Amtsgruppe C of the SS WVHA (Economic Administrative Main Office) “[...] *on the effectiveness of the stationary shortwave delousing facility*”.<sup>60</sup> At this point it must be remembered that the second mobile unit is not taken into consideration in the above efficiency data and it is probably safe to assume that this deficiency was considerably greater. On Nov. 7, 1944, the Central Construction Office stated<sup>61</sup> that

“[...] *at that time there was a stationary shortwave delousing facility in concentration camp I [Auschwitz] and a mobile one in concentration camp II [Birkenau].*”

According to a detailed report, further developments and modifications were made to the remaining facilities that had been ordered.

## 2.5. Comparisons

The advantages of the shortwave delousing facilities become apparent in a comparison with the other types of procedures. Using the Zyklon B method,<sup>30</sup> treatment of the clothing to be disinfested required 70 to 75 minutes. The Topf delousing ovens in BW32 took 60 to 80 minutes.<sup>62</sup> For the au-

---

<sup>53</sup> RGVA 502-1-333-99.

<sup>54</sup> RGVA 502-1-337-23.

<sup>55</sup> RGVA 502-1-333-72.

<sup>56</sup> RGVA 502-1-333-61R.

<sup>57</sup> RGVA 502-1-333-45.

<sup>58</sup> RGVA 502-1-333-7.

<sup>59</sup> RGVA 502-1-333-7/8.

<sup>60</sup> For the exact wording, cf. our original work, *op. cit.* (Note 5).

<sup>61</sup> RGVA 502-1-332-1.

<sup>62</sup> RGVA 502-2-149-7.

toclaves the time requirement was similar.<sup>63</sup> In the shortwave facilities, on the other hand, 11 to 12 seconds sufficed even to kill the bacteria.<sup>64</sup>

Installation of all the disinfestation facilities in BW32 cost RM 153,000.<sup>65</sup> The shortwave facilities in BW160, on the other hand, cost RM 75,000.<sup>66</sup>

Thus, the planning goals of the developer companies Siemens had been fully realized. Aside from that, construction costs for new buildings dropped as well, since the shortwave facilities required less space. The same goes also for installation in existing buildings, of course.

## 2.6. Summary

Evidence that has been missing for almost 50 years – the files about the shortwave delousing facilities of Auschwitz – has been rediscovered in the shape of plans and documents, even in photos and a film. They are not only proof that serious efforts were made to rid the camp of epidemics, and thus to keep the inmates alive. Their far greater significance is that they show that the inmates were so important to the Third Reich that they were given preference and priority status with regard to these new and better disinfestation facilities. The German front-line soldiers and the German civilians never enjoyed this life-saving technology – a fact that cannot possibly be overestimated. This fact is of a similar importance as the order of Dr. Mrugowsky, head of the *Hygiene-Institut der Waffen-SS*, from August 8, 1943, to all SS departments and to the committee for disinfestation and epidemic control within the Reichsminister for arming and ammunition:<sup>67</sup>

*“In future times, hydrogen cyanide may only be provided in cases of a severe danger of typhus epidemics. According to previous experiences, this is only the case in concentration camps. Thus, in future times, hydrogen cyanide may only be applied for the gassing of huts in concentration camps.”*

Furthermore, the 83,000 documents in the Moscow Archives contain not so much as one proof of the “self-evidentness” of the alleged mass murder, and as far as we know, no publication to the contrary has appeared in the meantime either. This leads to one central question: given the acute shortage of labor in the armaments industry, who could have benefited from the deliberate murder of even a single inmate? Does anyone seriously believe that this would have been tolerated? Any such murderers would have been hauled into court for “undermining military efficiency” or for “sabotage”. Pressac has neglected to this date to address this question. No historian has yet answered it either.

Similarly, another central question is also still open: why was a construction proposal submitted, on Sept. 30, 1943, to the tune of RM 32,200,000 for Birkenau alone, if the intent was to kill the inmates?<sup>68</sup> In today’s currency (1 RM had approximate purchasing power parity with 10 US-Dollar today) the estimated construction costs amount to \$322,000,000 – that is more than a third billion US-Dollar. Construction and the attendant spending proceeded as planned – the documents prove this. An analysis of the implementation of the construction project is presently in preparation for publication. We wish to state at this time that we have in our possession the complete and detailed construction proposal, that is, the calculations as well as the plans and sketches.

We are painfully aware that the entire shortwave delousing topic points to some of the SS plans and actions as being pregnantly humane, thus opening us to the legal charge in Germany of *Verharmlosung* (minimization) of the SS – a wholly evil organization according to the Nuremberg

<sup>63</sup> RGVA 502-1-335-11/12.

<sup>64</sup> RGVA 502-1-333-103.

<sup>65</sup> RGVA 502-2-149-32.

<sup>66</sup> RGVA 502-1-333-84.

<sup>67</sup> Hessisches Hauptstaatsarchiv Wiesbaden, 36342-5.

<sup>68</sup> RGVA 502-1-238-10.

show trials. But a scientific accounting of history about Auschwitz compels our work – rather than politically correct acceptance in the Berlin salon *Kaffeeklatsch*.

### 3. “*Gas-Tight*” Doors in Auschwitz

#### 3.1. The Cause for This Investigation

The word *gas* alone takes on a sinister undertone as soon as it is used in the context of *Auschwitz*. This *psychology of horror* is precisely what is often used to escalate harmless terms, which appear in the correspondence of the Central Construction Office of the concentration camp Auschwitz, into purported evidence for the mass murder. The ordering and installation of actually or even only allegedly *gas-tight* doors in buildings of the camp Auschwitz-Birkenau plays a central role in this. From the fact that the term “*gas-tight door*” appears in various documents from the Central Construction Office of Auschwitz, the subject literature has drawn the – untenable – conclusion (frequently without bringing any further proofs) that these occurrences are evidence for the construction of execution gas chambers. In fact, however, the documents in question not only supply no indication whatsoever for the existence of such chambers, as shall be shown in the following. They also usually indicate that these doors were used, or were to be used, for a completely different purpose, namely to seal delousing gas chambers. To date there has also been no examination of whether the doors used in Auschwitz were in fact *gas-tight* doors in the technical sense, *i.e.*, doors suited to hermetical sealing for purposes of absolutely locking poisonous gases in or out. In the following this omission shall be rectified.

#### 3.2. The Task

Let us say at the outset that there were indisputably gas chambers in Auschwitz which were used for the eradication of vermin and in which Zyklon B was used. These rooms were also called “*gas chambers*” on the building plans, for example the extensions of Buildings (BW) 5a and 5b in Building Section (BA) 1.

What is disputed, however, is that there were such rooms for the gassing, *i.e.*, killing of human beings. To this day there is no material evidence for this claim. Pressac believed that he had discovered “*criminal traces*”, which he tried to promote as circumstantial evidence – an attempt which, however, failed and must perforce continue to fail, simply because he has no proof. We shall return to this.

A discussion of the statements of witnesses is beyond the scope of our present investigation since they do not affect our topic. Furthermore, they differ too much from each other and contain no irrefutable evidence or indisputable documents. It is thus logically consistent to question the truth of their contents. Therefore, since there is no evidence, we accept these “*execution gas chambers*” as no more than alleged until and unless the evidential situation changes.

Before the Second World War, there were practically no problems with lice or fleas among the civilian population of the German Reich proper. But the situation was very different beyond the eastern border of the Reich, for example in Poland, where as we know the German Wehrmacht advanced in late summer 1939. Interested persons should ask soldiers about this who were there in 1939.

It no doubt makes sense that vermin were to be found wherever many people lived in camps or in poor sanitary conditions. “*Polish conditions*” was a catch phrase in those days! We mention this here only to clarify how first-hand experience influenced people’s thinking. Very many persons were still living in those days who had relevant experience from World War I in combating vermin.

Physicians and administrations had at their disposal extensive first-hand reports about the sanitary conditions in eastern Europe.

### 3.3. Development of the Delousing Facilities

The following brief summary shall also clarify where, how many, and when gas-tight doors were necessary. After the arrival of the first 30 inmates in the concentration camp Auschwitz (Main Camp) on May 20, 1940, there were evidently no major problems as regards delousing.<sup>69</sup> In the following we list the delousing facilities that existed at that time.

One hot-air delousing facility (manufactured by Topf and Sons) was installed in Building BW 1 L in the fall of 1940.<sup>70</sup> It remained in service until it was damaged by fire on Nov. 5, 1942.<sup>71</sup> According to a listing of July 30, 1943, it was restored (manufacturer Klein) and equipped as before.<sup>72</sup> The facility conformed to a June 5, 1940, order of the Reichsführer-SS:<sup>73</sup>

*“[...] henceforth no HCN, but rather hot-air delousing facilities are to be built. (Chief of Army Weapons and Commander of the Reserves.) These facilities are to be installed in extant buildings.”*

In Crematorium I the first double-muffle oven was completed on July 25, 1940, the second on Feb. 22, 1941, and the third on May 30, 1942. Once the facilities were wholly finished, and given the maximum possible duration of operation (20 hours a day), the daily crematoria capacity was 120 corpses – as shown by the double-checked, correct calculations performed by Mattogno.<sup>74</sup> The chimney sustained damage due to overheating, since it was probably not designed to serve 3 crematories.<sup>75</sup>

On July 3, 1941, the Construction Office received documents regarding the delousing of material objects with hydrogen cyanide and circulation fumigation chambers (serial format), relating to the planning of BW160, the admissions building with delousing and laundry facilities for the concentration camp.<sup>76</sup>

In a circular of March 11, 1942, the WVHA changed its position on hydrogen cyanide.<sup>77</sup> It maintained its position that hot-air facilities were to be used everywhere where the use of hydrogen cyanide was too dangerous. The statement of principle, however, follows:

*“The goal is the conversion of all delousing facilities to operation with HCN.”*

We shall show later, with reference to BW32 and BW160, how strict a standard was applied here. Two further hot-air delousing facilities were ordered by the garrison physician on May 19, 1942. The order, to the manufacturer Hochheim, was confirmed on June 29, 1942.<sup>78</sup> This exchange proves one more time that matters relating to delousing were part of the garrison physician’s duties.<sup>79</sup>

<sup>69</sup> Cf. RGVA 502-1-336-101; July 22, 1943.

<sup>70</sup> RGVA 502-1-332-46; Jan. 09, 1943.

<sup>71</sup> RGVA 502-1-332-54; Nov. 05, 1942.

<sup>72</sup> RGVA 502-1-332-9; July 30, 1943.

<sup>73</sup> RGVA 502-1-333-145; June 05, 1940.

<sup>74</sup> Carlo Mattogno, *Auschwitz: The End of a Legend*, Granata Publishing, Palos Verdes, CA, 1994 (online: [vho.org/GB/Books/anf/Mattogno.html](http://vho.org/GB/Books/anf/Mattogno.html)); Mattogno, “*Auschwitz. Das Ende einer Legende*”, in Herbert Verbeke (ed.), *Auschwitz: Nackte Fakten*, Vrij Historisch Onderzoek, Berchem 1995, table 3, p. 24 (online: [vho.org/D/anf/Mattogno.html](http://vho.org/D/anf/Mattogno.html); Engl.: [vho.org/GB/Books/anf/Mattogno.html](http://vho.org/GB/Books/anf/Mattogno.html)).

<sup>75</sup> RGVA 502-2-54-36; June 01, 1942.

<sup>76</sup> RGVA 502-1-332-86; July 01, 1941.

<sup>77</sup> RGVA 502-1-336-94; Mar. 11, 1942.

<sup>78</sup> RGVA 502-1-332-97; June 29, 1942.

<sup>79</sup> Cf. Carlo Mattogno, “*Die ‘Gasprüfer’ von Auschwitz*”, *VffG* 2(1) (1998), pp. 13-22 (online: [vho.org/VffG/1998/1/Mattogno1.html](http://vho.org/VffG/1998/1/Mattogno1.html)); cf. As well *VffG* 2(2) (1998), p. 160 (online: [.../2/Leser2.html](http://vho.org/VffG/1998/2/Leser2.html)).

In the summer of 1942 the first “*chamber for hydrogen cyanide gassings*”, BW28, came into service in an old building of Personal Effects Depot Kanada 1.<sup>80</sup> One advantage of these chambers was that heat-sensitive objects that had to be deloused were treated with care.

On July 1, 1942, a sergeant from the gendarmerie of Auschwitz arrived and closed off the construction firms’ civilian laborers’ camp due to spotted fever.<sup>80</sup> As the voluminous correspondence in our archives confirms, this event threw all involved offices and authorities from the state, the Wehrmacht and the SS into an uproar. It was deemed possible that the epidemic could spread to the camp and the civilian population, with immeasurable consequences for, among other things, the numerous armaments factories in Silesia. The files at hand from the RGVA prove in all clarity that the subsequent re-designing of the Birkenau camp and most of all the elaboration of the crematoria was a consequence of this spotted fever epidemic.

And just at that critical time, the chimney of Crematorium I was broken off (on June 12) and repairs were not finished until Aug. 8, 1942.<sup>81</sup> Thus, cremation of victims of the epidemic was not possible during that time.

As a result, a newly revised construction program was immediately drawn up for the POW camp Birkenau. The file containing the outline of October 28, 1942, and plans was found in the War Archives in Prague, with the additional description “*Durchführung der Sonderbehandlung*” (Implementation of Special Treatment).<sup>82</sup>

On the plans contained within this file, however, only one building is marked with the express and special note “*Sonderbehandlung*” (Special Treatment), namely the disinfestation facility BW32.<sup>14</sup> To date no one has produced any evidence for the common, though much-disputed claim that in this case “*Special Treatment*” amounted to killing. Building BW32 was first put into operation in the POW camp Birkenau on January 29, 1944. It housed hot-air delousing facilities pure and simple,<sup>83</sup> and thus proves the exact opposite of the alleged killing of inmates, namely that “*Special Treatment*” referred strictly to delousing measures.

Almost at the same time as Building 32, another delousing facility, Building 32a, was built in Section BA IIe, also called the Gypsy Camp. It went into service on February 17, 1944, as hot-air disinfestation facility, but it was heated with electricity.<sup>84</sup>

On July 9, 1942, an offer was received from the company Berninghaus, regarding gas-tight doors; a construction diagram was included.<sup>85</sup> A detailed description and the diagram at hand reveal a type of door construction that differed radically from that of the doors that were otherwise manufactured mostly by inmates at the DAW (Deutsche Ausrüstungswerke), a company operating near the camp. The doors were offered for use with the HCN-operated circulation fumigation chambers manufactured by DEGESCH which were to be installed in the delousing facility in BW160. We shall return to this matter.

---

<sup>80</sup> RGVA 502-332-151; 01.07.1942.

<sup>81</sup> Jean-Claude Pressac, *op. cit.* (Note 3), Note 131.

<sup>82</sup> Historický ústav Armády České republiky. “*Bauvorhaben Kriegsgefangenenlager Auschwitz, Kostenüberschläge 28.10.1942*”, 43 pages with plans. This archive contains enormous numbers of German files, including for example the war archives of the Waffen-SS, which were inaccessible, even completely unknown until 1992, and are supposed to return to such oblivion, cf. G. Rudolf, “*Wer zu spät kommt, den bestraft das Leben*”, *VffG* 2(3) (1998), p. 165 ([vho.org/VffG/1998/3/Rudolf1\\_3.html](http://vho.org/VffG/1998/3/Rudolf1_3.html)).

<sup>83</sup> We have in our possession documents showing even the smallest details, including the diagrams and instructions for operation that go with them; readers may request copies from the publishers of this work.

<sup>84</sup> Cf. also Michael Gärtner, “*Volksverhetzung? Volksverhetzung!*”, *VffG* 1(4) (1997), pp. 244f. (online: [vho.org/VffG/1997/4/Gaertner4.html](http://vho.org/VffG/1997/4/Gaertner4.html)).

<sup>85</sup> RGVA 502-1-354-8; July 09, 1942.

At this point at the latest, the Central Construction Office could see how inadequate the doors were that had been manufactured by the DAW as “*gas-tight doors*”. They lacked all the characteristics of a truly gas-tight door.

On July 23, 1942, the entire camp area was closed off due to the spotted fever epidemic that had been introduced by the civilian laborers.<sup>86</sup> Another hot-air delousing facility from the company Klein was installed in BW 20 L of the Main Camp and came into service in the fall of 1942.<sup>70</sup>

However, it took facilities in the Birkenau camp, which was at that time under construction, to bring a noticeable relief of the situation. In Birkenau, Section a of BA 1 was finished in March 1942 and Section b in August 1942. These sections each contained a large delousing facility, each with one hot-air installation from the firm of Hochheim, one disinfection apparatus by the firm of Werner, and one sauna facility.<sup>70</sup> A chamber to be used for HCN fumigation was attached to both. The buildings with the official designation BW 5a and 5b came into service in November and December 1942 respectively. Further, a facility with a hot-air apparatus from Hochheim and a disinfection apparatus from the firm of Goedicker was put into operation in January 1943 to service the civilian laborers.<sup>70</sup>

### 3.4. Undisputed, Alleged Gas-Tight Doors

Since air-tight and heat-retaining doors were also needed for the hot-air facilities, we assume that the doors were of more or less the same construction. We shall summarize for which facilities gas-tight doors were required (as per the documents from January 9, 1943,<sup>70</sup> to July 30, 1943:<sup>72</sup>

#### 3.4.1. Concentration Camp Auschwitz

- a) Block 3, upper story: (probably) 2 inside doors
- b) Personal Effects Depot Kanada 1: (probably) 1 inside door 1 outside door

#### 3.4.2. POW Camp Birkenau

- a) BW 5a: 4 inside doors, double-leaf as per diagrams
  - b) BW 5b: 4 inside doors, double-leaf as per diagrams
- Total, 12 doors.

### 3.5. Disputed, Alleged Gas-Tight Doors

We do not intend to discuss here why we question that there were rooms for the alleged gassing of human beings in the buildings described in the following. For this reason we will also just mention briefly that we also have a different, documented opinion regarding the unnamed rooms in Crematoria IV and V. We shall go into detail about this in a separate publication.

The fact is that to this date, Pressac and others have not offered any verifiable material evidence for the alleged existence of execution gas chambers. On the contrary, Pressac even refutes some of the eyewitness testimony he himself has presented. As for the rest, the published eyewitness statements which Pressac relies on heavily are so unbelievable and abstruse that even persons with no special subject knowledge can easily recognize that they are false. In many cases, all it takes are simple calculations based on logical deductions.

Some allegations have been refuted by subject publications. Other such publications are in preparation. As in previous publications, we have weighty arguments, which yet need to be thoroughly

---

<sup>86</sup> RGVA 502-1-332-143; July 23, 1942.



supplemented and reworked into final form. Not least of all, the documentary situation, which is improving constantly, is producing many new insights and changes which must be factored in.

These preparations give rise to the sweeping question whether there really was even *one single* truly gas-tight door in Auschwitz that could have fulfilled the necessary criteria. This is the only question which we shall examine in the following.

Let us look first at the controversial claims which Jean-Claude Pressac makes with regard to gas-tight doors:<sup>87</sup>

### 3.5.1. Concentration Camp Auschwitz

- a) BW 160 Admissions Building: 38 inside doors, as per diagram.

### 3.5.2. POW Camp Birkenau

- a) BW 30 Crematorium II: 1 inside door, possibly double-leaf
- b) BW 30a Crematorium III: 1 inside door, possibly double-leaf
- c) BW 30b Crematorium IV: 3 inside doors
  - " 2 outside doors
  - " 7 windows
- d) BW 30c Crematorium V: 3 inside doors
  - " 2 outside doors
  - " 7 windows

## 3.6. Alleged Evidence for Gas-Tight Doors and Windows

Aside from verbal statements which are of no value as evidence since they are clearly based on wishful thinking, the pharmacist J.-C. Pressac – and other authors as well – offer the following documentation:

### 3.6.1. Photos of Construction Parts

In his first book, Pressac repeatedly shows photos of doors and windows that have been removed from their original locations but are allegedly supposed to correspond with those we have listed in the previous.<sup>87</sup> We shall come back to this with regard to specifically quoted illustrations.

### 3.6.2. Construction diagrams allegedly showing merely the location of construction parts

Since Pressac presents a jumble of diagrams which in part are also repetitions or preliminary stages of the final diagrams, we shall proceed similarly in this case.

### 3.6.3. Documents containing the word “gas” in some form or another

This includes particularly those documents which Pressac described as “*39 criminal traces*” in his chapter 8. Again, we shall go into detail here only where these “*traces*” are specifically mentioned.

## 3.7. General Comments on the Alleged Evidence

First we shall remark on the overall concept in question, before giving detailed reasons for our position where required. Another section will then give specifics regarding buildings and construction parts.

---

<sup>87</sup> Jean-Claude Pressac, *op. cit.* (Note 12), pp. 161-171.

We must mention that only one of our working group has any on-site knowledge of Auschwitz. However, considering that most of the buildings no longer exist and that only few doors remain in situ, this fact matters little, since a detailed examination of the door (which would only be possible by taking it apart) would certainly not be permitted anyhow. Yet this is the only way to obtain the information required. Construction parts held in storage cannot provide any information regarding where they were installed more than 50 years ago, unless they had special characteristics that made them distinctive and unmistakable.

Of particular interest to us in this context are the “38 gas-tight doors”, allegedly kept in storage. On page 31 of his first book,<sup>12</sup> Pressac tries to give the impression that the 19 HCN circulation gas chambers in BW 160 had been finished. His brief commentary at this point reveals that he knew neither how these were built nor how they were operated. While he writes:

*“The present state of the premises makes it impossible to reconstruct the techniques employed”,*

he obviously proceeds on the assumption that there was a “*technique*”. Since in 1989 he knew nothing of the ultra-shortwave delousing facilities, Pressac probably assumed that the HCN gas chambers had been finished. That, at least, is indicated by his phrase:

*“[...] making it possible to recover 38 gas-tight doors.”*

It is typical for Pressac’s style of writing that he constantly tries to infer proof even when there is not the slightest grounds for doing so. He feigns knowledge where he doesn’t have a clue. As it has turned out, uninformed readers are not the only ones who fall for this.

The fact is that these “*Degesch chambers*” were never finished. We shall prove this further on with some documents which also show that not one of the 38 gas-tight doors for the chambers in fact existed.

### 3.7.1. Comments on Photos in General

No expert is able to judge from photographs whether a construction part such as a door, where the proper construction of those parts that are not visible is also important, is “*gas-tight*”. In the case of doors this goes, for example, for every screw that was screwed through the door panel. It is commonly known that under conditions of varying humidity and temperature, wooden construction parts warp, due primarily to the ever-changing moisture levels in the wood. It would thus be necessary to know for certain whether, when and how the individual parts were given a waterproof coating, for example. This can be decisive for the wood’s tendency to absorb moisture. However, there is no data about this. It is an even more important factor for outside doors that were or are installed on the south side of buildings, for example. Where there are considerable temperature differences between the inside and the outside, such doors warp considerably. Since none of the doors shown had more than two anchors with which they could be affixed to their frames, this was a significant shortcoming.

Ultimately, the photos in question show only one thing: namely, that either a window or a door was installed – no more. Not even the date of the photo can be determined. In the best case there are also some indications of where a component was installed. If any additional information is possible, it will be mentioned.

How great the danger of falsification is in the matter of photo captions is shown by the article “*Volksverhetzung? Volksverhetzung!*”<sup>84</sup> (Incitement of the masses).

### 3.7.2. Comments on Construction Diagrams in General

An expert cannot assess, on the basis of construction diagrams, buildings which at the time of assessment have not existed for 50 years, since there is no means for comparison. There are no photos

that permit assessment with certainty. Further, the recorded eyewitness statements diverge from each other so extremely that they are useless as evidence. There are even diagrams that supposedly show technical and architectural conditions as they existed at a given time, but which provably do not represent such conditions as they are known to have existed.

One exception is the delousing facility of BW 160. In his second book<sup>81</sup> Pressac reports about new findings regarding ultra-shortwave delousing facilities. Based on his references we were able to considerably expand our own files on the subject (cf. previous).

### 3.7.3. Comments on Other Documents in General

From the fact that someone labels or has labeled a construction part as “*gas-tight*” one cannot automatically conclude that it really is or was gas-tight. The word merely means that the object was supposed to have this property. A photo showing sufficient detail can give indications for an assessment; the same goes for text documents. However, if there is no description or specification and/or no diagram of a construction part, then there is already no foundation for such an assessment.

The documents pertaining to the aforementioned stationary ultra-shortwave delousing facility enable one to draw concrete conclusions, to follow.

## 3.8. Photos Offered As Evidence

### 3.8.1. Observations on Photos Shown

All photos cited are from J.-C. Pressac<sup>12</sup> and show exclusively construction parts made of wood. Our comments, of course, also go equally for other publications, insofar as the photos they show exhibit the same characteristics or stem from the same source.

On pp. 28 and 29, photos 14 through 19 show the outside door of a hot-air delousing facility in Block 1 of the concentration camp Auschwitz. These are the only ones that can be verifiably assigned to a specific building. Whether they are still the original doors cannot be determined. However, they are not part of our topic, unless the assumption could be proven that the construction type corresponds to that of the gas-tight doors. The captions of the photos do not correspond to the undoubtedly genuine documents.<sup>70,72</sup> One more proof that Pressac should be read with great caution. We do not wish to suggest that he deliberately sought to increase the number of delousing facilities operated with Zyklon B, merely that he did not have access to the files presently available.

Photos 13 through 18, 21, 22, 23, 25, 26 and 29/30 on pp. 41 to 52, regarding BW 28 in Kanada 1, would seem to indicate that the assumption that the doors were of the same construction type is correct (cf. *illustration 5*).

Proceeding from this, the photos show the mountings of such doors. These are: a handle of round iron, two steel straps the width of the door (and bolted through the panel!) and on the hinge side supported by blocks lagscrewed into the door frame (this is the construction method for heavy door panels). At the swing side these straps are fitted with latchbolts that turn into catches made of band



**Illustration 5:** Door of a Delousing Chamber in Auschwitz. (J.-C. Pressac<sup>12</sup>, p. 49.)

steel. The catches have threaded boreholes for securing the threaded latchbolts. At the same time these latchbolts were supposed to press the panel down gas-tight.

Felt was used as gasket material, as shown by some photos as well as by documents, *e.g.* the materials inventory of February 24, 1943 (Pressac,<sup>12</sup> p. 444). For this purpose, strips of felt of low elasticity, 7 mm thick and of varying width, were nailed into the panel and door frame seams. This is documented by a photo on page 61, and others. There are many other minor details of evidence with which we shall not bore our readers, but one more essential point is that not every photo shows whether the necessary 5-cm-high threshold was present on the floor in every case; no door can be sealed gas-tight along the floor without one.

This manner of door construction originated with the war-time provisional air raid shelter construction programs.<sup>88</sup> It is no doubt clear that construction parts not produced to industrial standards would have resulted in inaccuracies.

The alleged windows/doors of Crematoria IV and V were of a special type. They were window-sized but not glazed, and thus were actually more like doors at window level. The aforementioned details apply by analogy. There is no need to go into specifics.

### 3.8.2. Comments on Photos Shown

We shall be brief here because detailed descriptions of doors and excerpts of the diagram for Auschwitz, which substantiate the correctness of the following, will be presented later.

The most important criteria for a truly gas-tight door are readily to be found in the contemporaneous subject literature on air raid and HCN delousing facilities. As examples for both, we refer the reader to *Schutzraumabschlüsse*<sup>89</sup> and, respectively, to *Blausäuregaskammern zur Fleckfieberabwehr*,<sup>90</sup> since this publication already took into account the experiences gained in the first years of the war. The main criteria are:

1. Due to the highly penetrative property of HCN, absolute gas-tightness of all construction parts.
2. The door panel must fit against all parts of the door frame in a parallel and uniformly tight manner. This requires a rubber gasket. To this, people often object that there was no rubber in Germany during the war. This is true only to a degree; we had a substance that was in some respects even better than natural rubber, namely buna (this is why motorcyclists' buna overcoats dating from 1937 are still in perfect condition today, whereas such made from natural rubber are not!).
3. A 5-cm-high threshold was required.
4. The door hinges required a free axis so that the door panel could pass on the band side when being closed. *Illustration 8* shows this important point. To allow the panel to be pressed tightly to the frame but also to let it pass freely, the end of the steel strap on the pin of the lagscrewed block is not round and close-fitting in shape, but oval. This allows the panel to move. This is a necessary prerequisite for a gas-tight door, since if it cannot be pressed tightly to the frame it cannot be made gas-tight. This goes even more for felt than for buna hose gaskets.
5. As locking mechanisms, even steel doors – as we shall show – required at least 8 wedge locks, three on either side and one each at the top and bottom. The wedges made it possible to press

<sup>88</sup> Cf. Samuel Crowell, "Technik und Arbeitsweise deutscher Gasschutzbunker im Zweiten Weltkrieg", *Vierteljahrehefte für freie Geschichtsforschung (VffG)* 1(4) (1997), pp. 226-244 (online: [vho.org/VffG/1997/4/Crowell4.html](http://vho.org/VffG/1997/4/Crowell4.html); Engl.: [codoh.com/incon/inconpressac.html](http://codoh.com/incon/inconpressac.html)).

<sup>89</sup> R. Scholle, "Schutzraumabschlüsse", *Baulicher Luftschutz* issue 3, W. Ernst & Sohn, Berlin 1939.

<sup>90</sup> Franz Puntigam, H. Breymesser, E. Bernfus, *Blausäuregaskammern zur Fleckfieberabwehr*, Sonderveröffentlichung des Reichsarbeitsblattes, Berlin 1943.

the door panels uniformly to their frames. If this was necessary for steel doors, this goes all the more for wooden doors (cf. *illustration 7*, page 334).

None of the doors pictured met even these five criteria:

1. The doors were uniformly fastened with screws etc.
2. The doors had only two fixed points, and two bolts of limited adjustability.
3. Felt is not gas-tight.
4. The steel door straps had no adjustable axes.
5. The wooden door panels could warp. (Anyone who wishes to seriously examine this issue should at least have *read* the aforementioned study about gas chambers operated with hydrogen cyanide.)

Two photos<sup>91</sup> exist of the annex to building BW 160, belonging to the shortwave delousing facility. They prove that construction of the remaining facilities was not finished.

### 3.9. Construction Diagrams Offered As Evidence

#### 3.9.1. Observations on the Construction Diagrams Shown

We will of course restrict ourselves to points relevant to this topic. Regarding the diagrams of Crematoria II and III, therefore, it must be pointed out that the entrance door to Mortuary 1 is depicted in several different ways. There are doors which open into a room, but also such that open outwards. Further, both single and double doors are shown. The most credible diagrams are probably the status diagrams made of the completed structural shell. These diagrams are by the company HUTA of Series 109; as reproduced by Pressac,<sup>12</sup> pp. 327 and 329, they clearly show a suitable double door.

In the diagrams of Crematoria IV and V we shall only point out the depiction of the small windows/doors. The wall anchors sketched in here reveal an unusual form. They are configured in such a way that it appears that they were intended to open outwards; cf. p. 399.<sup>12</sup> Wall anchors are not generally sketched on the inside wall. How they were in fact really constructed is unknown. In the context of related documents some unusual features appear, but these are not relevant to our present topic. We have already announced a separate study on this matter.

#### 3.9.2. Comments on the Construction Diagrams Shown

As we have already stated, no indisputable findings can be based on the diagrams. However, if the doors were fashioned as double doors, then it is certain that if they were made of wood, they could not possibly have been gas-tight. The seam between the two movable panels of a double door cannot be gasketed to gas-tightness with felt. Added to this was the fact that given the shortage of skilled labor during the war, parts which were manually manufactured on-site could not have been as precisely made as industrially produced parts. This goes for the doors themselves but even more for the felt gaskets. The same goes for the windows/doors, but these are to be considered as above since in this context it is irrelevant whether they opened inwards or outwards. Most at risk is the construction shown in photos 32 and 33, p. 427, given large temperature differences between inside and outside. Aside from that, the construction shown in photos 29 and 30 is more reminiscent of a door to an ice box, of which it is known that there were some in the camps. As part of its tender of July 9, 1942, the firm of Berninghaus supplied a diagram of its door, “*Delousing Chamber Door St. 3596*”, dated March 20, 1942. Where the buildings in Auschwitz are concerned, this tender for gas-tight doors is highly significant in terms of its timing, since it had already been obtained before any

---

<sup>91</sup> From the Siemens archives, Munich, for one of them see *Illustration 3*. The other was reproduced in H. Lamker, *op. cit.* (Note 5).

of the crematoria and Birkenau were being built. If, as is alleged, ‘execution gas chambers’ had been planned for these crematoria, then such doors would also have been ordered early on, but this was not done. On the other hand, such doors manufactured by the same firm were verifiably installed in the concentration camp Buchenwald, for example (note: there were *no* ‘execution gas chambers’ in Buchenwald!).

From the diagram supplied by the firm Berninghaus we present some detailed excerpts which show how great the difference was between these doors and those made by the Auschwitz-based DAW (Deutsche Ausrüstungs-Werke), which produced the allegedly gas-tight doors for the camp, largely with unskilled labor. These prove that the criteria set out in 8.2 were known:

1. Stiffer, more precise construction with the aid of steel profiles: *illustration 6* (next page)
2. More and better locking hardware: *illustration 7* (next page)
3. Free axes and wedge locks: *illustrations 8 & 9* (next page)

### 3.10. Other Documents Offered As Evidence

#### 3.10.1. Observations on the Documents Shown

Given the overall situation, we can dispense with minor points. We have already mentioned that documents are now available of which Pressac is or was not aware.

#### 3.10.2. Comments on the Documents Shown

The files contain a tender for gas tight doors for the delousing facility in BW160. It is a typical “*circulation fumigation chamber by the firm Degesch*”, about whose particular structuring and construction Pressac probably did not inform himself. For this reason he made many errors and misinterpretations here. The detailed tender and drawing, which we have in our files, was received by the Central Construction Office on July 13, 1942.<sup>85</sup> The salient point among the extensive correspondence is that these doors were not ordered until May 5, 1944.<sup>92</sup> Due to the shortwave delousing facility which had been implemented in the meantime, their number was reduced to 22.

Another important element is the May 12, 1944, letter<sup>93</sup> from the firm of Berninghaus in which they state:

“[...] *that today we no longer supply gas chamber doors of anything other than double-walled all-steel construction, since it has turned out that the doors of a construction type that economizes on steel do not meet the necessary requirements.*”

This letter was supplemented with a new offer dated May 12, 1944, including a detailed description.<sup>94</sup> The doors were ordered via registered letter of June 20, 1944.<sup>95</sup> Finally, in a letter dated November 21, 1944, the Berninghaus company asks if the ordered doors should still be delivered.<sup>96</sup> We may assume that they were not delivered.

If even the door construction types that had already been much improved in 1942 were not gas-tight, then this is an additional corroboration of our concluding position. A subject expert could not wish for better counter-evidence. A manufacturer of a much-improved but nonetheless temporary ‘gas-tight door’ who, even in times of severe steel shortage, declares only all-steel doors to be truly gas-tight and offers to supply them, can hardly be surpassed as evidence.

<sup>92</sup> RGVA 502-1-354-7; May, 5, 1944.

<sup>93</sup> RGVA 502-1-354-3; May 12, 1944.

<sup>94</sup> RGVA 502-1-354-4; 12.5.1944.

<sup>95</sup> RGVA 502-1-354-5; 20.6.1944.

<sup>96</sup> RGVA 502-1-333-2; 22.11.1944.

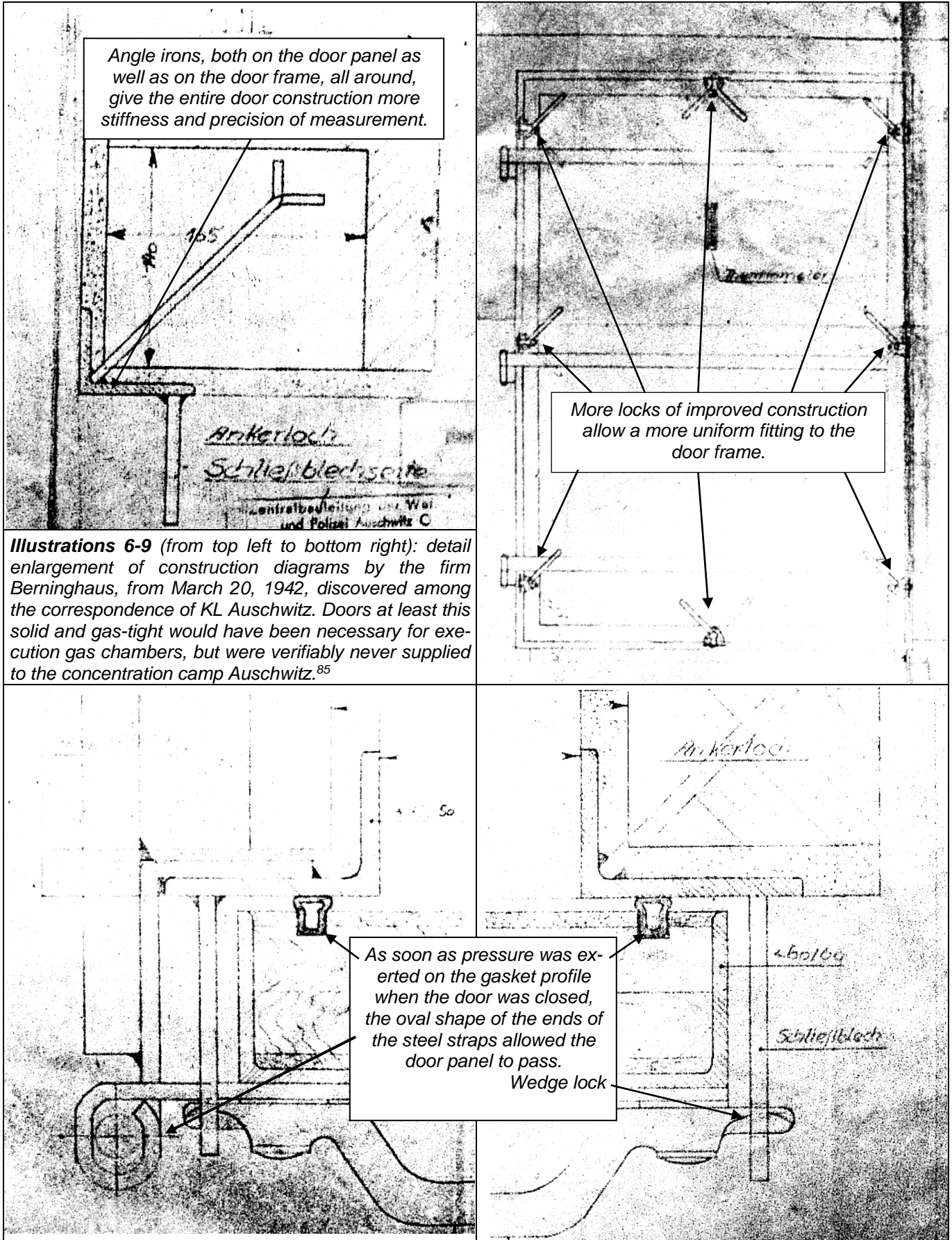

**Illustrations 6-9** (from top left to bottom right): detail enlargement of construction diagrams by the firm Berninghaus, from March 20, 1942, discovered among the correspondence of KL Auschwitz. Doors at least this solid and gas-tight would have been necessary for execution gas chambers, but were verifiably never supplied to the concentration camp Auschwitz.<sup>85</sup>

### 3.11. J.-C. Pressac's "39 Criminal Traces"

#### 3.11.1. Observations on "39 Criminal Traces"

Completeness requires that this part of Pressac's book<sup>12</sup> also be examined. However, only those who have read and worked through this book from start to finish know what they would be getting into. To refute every nonsensical and illogical sentence and, even more so, every technically or physically incorrect statement made in this book on the subject of the gas-tight doors and windows – and unfortunately there are a great many such statements – would take an entire book.<sup>97</sup> Within the scope of the study at hand, it is impossible to provide a complete analysis of Pressac's section of 29 oversized text pages. For this reason we shall choose just one example:

1. On p. 429 Pressac writes:

*"Proposition A: A gas-tight door can be intended only for a gas chamber."*

As we shall see, this is a thoughtless and untenable claim. His further conclusions can only be correct if this statement is correct. But anyone who lived through the time in question must then conclude from Pressac's claim that Germany was full of gas chambers – for prior to the war there were legal regulations that required the construction of air raid shelters as part of new buildings, and one of the requirements was that the air locks of such shelters had to be gas-tight.<sup>88</sup> So, Pressac's proposition is false!

He claims "39 criminal traces" but offers evidence for only 34. Moreover, his 'line of reasoning' is characterized more by wishful thinking than by documented facts. Evidently he put himself (or was put?) under pressure to produce the desired evidence. There is no other way to comprehend that he turns the one point in his exposition, "gas-tight door", into 17 separate points, such as for example:

*"23. [...] 210 anchors for gas-tight door"*

We could have given him suggestions for some more, such as for example, '35 nuts for bolts in gas-tight door.' The seriousness of the topic prevents us.

#### 3.11.2. Comments on "39 Criminal Traces"

We have proved clearly and compellingly the cardinal error of not only Pressac's entire book, but 'serious' studies at large: rather than the pharmacist J.-C. Pressac, subject experts should deal with all matters that require special, *i.e.*, subject-related knowledge. A pharmacist is not the proper person to determine the presence of "gas-tight doors", just as a construction engineer would not be tolerated in a pharmacy, and rightly so.

The same, of course, also goes for the disciplines of history and law. In these cases laws even require the consultation of suitable subject experts, which are available in all fields of study. As subject expert, one must thus ask oneself: why do precisely these two disciplines continually refuse, even in violation of legal precepts, to avail themselves of such subject experts?

The section in question does not provide any evidence that other, truly gas-tight doors or windows existed. Pressac's attempt to bring evidence 'indirectly' also fails, as we shall show in a future study. The sentence which he aims at others on his p. 421 applies very much to Pressac himself:

*"There is none so blind as he that will not see."*

---

<sup>97</sup> Cf. also the chapter by W. Rademacher, this volume.



### 3.12. Summary

After careful examination of all photos, descriptions and documents available for analysis, we all concur in the conclusion that the ‘infamous’ gas-tight doors of Auschwitz were, in fact, not gas-tight. In particular, they lacked the following characteristics:

1. The felt used as gasketing material is not sufficiently elastic to compensate for warping of the door panel. This goes all the more for the strapped side of the door panel because here it is not possible to compensate by pressing on, since
2. there are no free axes.
3. The number of bolts is too small to fix the door panel uniformly, and there are no parts that would allow for uniform sealing pressure on the one hand and prevent distortions on the other.

The doors could not have kept gas from escaping into the buildings and the surrounding areas. Claims to the contrary of these facts are false.

However, as the correspondence from the firm of Berninghaus proves, the Central Construction Office of Auschwitz would have been able at any time to obtain solid, gas-tight steel doors, such as were manufactured by the umpteen thousands for Germany’s air raid shelters. The fact that this was not done can only be because they simply were not really needed in Auschwitz. For delousing facilities, where the aim is not to keep great numbers of people mechanically completely isolated from poison gas (as in air raid shelters) or locked into a concentration of poison gas (as in the alleged execution gas chambers), wooden doors with makeshift gaskets will do.

**There was no gas-tight door in the two camps comprising Auschwitz.**

### Abbreviations

- BA: Bauabschnitt = Building Section
- BW: Bauwerk = building
- Exterminationist: a person convinced of the theory of the extermination of concentration camp inmates
- WVHA: Wirtschafts- und Verwaltungs-Hauptamt = Economic Administrative Main Office
- RGVA: Rossiski Gosudarstvenni Vojenni Archiv, Moscow (the former *Tsentr Chranjenija Istoriko-domumental'nich Kollektzii*, Center for the Custody of Historical Document Collections, TCIDK)

# Some Technical and Chemical Considerations about the ‘Gas Chambers’ of Auschwitz and Birkenau

GERMAR RUDOLF

## 1. Introduction

Prior to the *Leuchter Report*<sup>1</sup> no scientific studies of any significance had ever been conducted about the homicidal ‘gas chambers’<sup>2</sup> of Auschwitz and Majdanek, which is astonishing in view of the importance of the topic. Even in the great Auschwitz Trial in Frankfurt in the mid-1960s, the expert reports that were commissioned had an exclusively historical focus, and not even the defense thought to request a report on the alleged murder weapons, which have partly survived to this day. In its verdict the Court stated that it lacked “almost all the means of evidence available in a normal murder trial”, including “the bodies of the victims, autopsy reports, expert reports on the cause and time of death, [...] evidence as to the criminals, murder weapons, etc.”,<sup>3</sup> and after a detailed analysis of the course of the trial one cannot help but note that this Court, just like all those which dealt with the topic before and since, never made even the slightest effort to locate any such evidence or to commission any subject experts. The same goes no less for the great Majdanek Trial in Düsseldorf in the late 1970s.<sup>4</sup>

It was not until 1988, 45 years after the alleged crime, that Ernst Zündel, a German-Canadian charged by a Canadian court with knowingly disseminating false news about the Holocaust,<sup>5</sup> commissioned the American gas chamber expert Leuchter to draw up a report about the evidence for the supposed murder weapon. The idea for such a report had been suggested to Zündel by Robert Faurisson, who already as early as 1978 published his thesis of the radical impossibility of human gassings in the

---

<sup>1</sup> F. A. Leuchter, *An Engineering Report on the Alleged Execution Gas Chambers at Auschwitz, Birkenau and Majdanek, Poland*, Samisdat Publishers, Toronto 1988, 195 pp. (online: [www.zundel.org/english/leuchter/report1/leuchter.toc.html](http://www.zundel.org/english/leuchter/report1/leuchter.toc.html)); German ed.: *Der erste Leuchter-Report*, *ibid.*, 1988; British ed.: *The Leuchter Report*, Focal Point Publications, London 1989, 67 pp.

<sup>2</sup> I intentionally put ‘gas chambers’ in quotation marks for the following reason: In the wartime German technical literature as well as in many blueprints of German architectural maps, this term was exclusively used to describe delousing facilities, but never in the context of homicide. Nevertheless, I do understand that whenever this term is used today, a homicidal ‘gas chamber’ is normally meant and/or understood. But since this is a corruption of the original term, I put it in quotation marks to distinguish it from the original term referring to delousing gas chambers, see note 32.

<sup>3</sup> Verdict of the Frankfurt Auschwitz Trial, Ref. 50/4 Ks 2/63; cf. I. Sagel-Grande, H. H. Fuchs, C. F. Rüter (eds.), *Justiz und NS-Verbrechen*, v. XXI, University Press, Amsterdam 1979, p. 434.

<sup>4</sup> District Court Düsseldorf, Ref. 8 Ks 1/75.

<sup>5</sup> Regarding the trials cf. B. Kulaszka, *Did Six Million Really Die? Report of the Evidence in the Canadian ‘False News’ Trial of Ernst Zündel – 1988*, Samisdat Publishers, Toronto 1992 (online: [www.zundel.org/english/dsmrd/dsmrdtoc.html](http://www.zundel.org/english/dsmrd/dsmrdtoc.html)); R. Faurisson, *Journal of Historical Review (JHR)* 8(4) (1988), pp. 417-431 (online: [vho.org/GB/Journals/JHR/8/4/Faurisson417-431.html](http://vho.org/GB/Journals/JHR/8/4/Faurisson417-431.html)). The law under which E. Zündel was charged was quashed by the Supreme Court of Canada in spring 1993 as being in violation of human rights. The reason: no one other than the accused himself could possibly know whether the accused had knowingly told untruths (in other words, had lied or denied). Everyone must be granted the right to be wrong. This antediluvian law required the Court to be able to read minds, and was an elastic, ambiguous paragraph posing a dire threat to the free expression of opinion. The Court rejected subsequent motions to re-charge Zündel under other paragraphs. Zündel was thus acquitted of all charges.

alleged ‘gas chambers’ of Auschwitz.<sup>6</sup> In the resultant, hastily drawn up report, Leuchter concluded that the “*alleged gas chambers*” of the facilities he examined could not have been used as such for several technical reasons. Additionally, analyses of brick samples from the alleged ‘gas chambers’ showed that these contain negligible traces of hydrogen cyanide poison from Zyklon B, whereas the walls of the delousing chambers where the inmates’ clothing was deloused with Zyklon B contain great quantities of such residue.

It is not surprising that this report caused considerable uproar, which resulted in a number of publications.<sup>7-29</sup> On the suggestion of the Leuchter Report, the Rudolf Report – drawn up in spring 1992,<sup>19</sup>

- <sup>6</sup> R. Faurisson, “*Es gab keine Gaskammern*”, Deutscher Arbeitskreis Witten, Witten 1978; R. Faurisson, “*Le camere a gas non sono mai esistite*”, *Storia illustrata*, 261 (1979), pp. 15-35 (Engl. online: [vho.org/GB/Journals/JHR/2/4/Faurisson319-373.html](http://vho.org/GB/Journals/JHR/2/4/Faurisson319-373.html)); cf. R. Faurisson, “*The mechanics of gassing*”, *JHR*, 1(1) (1980) (online: [abbc.com/aaargh/engl/FaurisArch/RF80spring.html](http://abbc.com/aaargh/engl/FaurisArch/RF80spring.html)), p. 23ff.; R. Faurisson, “*The gas chambers of Auschwitz appear to be physically inconceivable*”, *ibid.*, 2(4) (1981) pp. 313-317 (online: [vho.org/GB/Journals/JHR/2/4/Faurisson312-317.html](http://vho.org/GB/Journals/JHR/2/4/Faurisson312-317.html)).
- <sup>7</sup> F. Finke, *Deutschland in Geschichte und Gegenwart (DGG)* 37(3) (1989), pp. 1-4.
- <sup>8</sup> J.-C. Pressac, *Jour Juif*, December 12, 1988, pp. 1-X; also in S. Z. Shapiro (ed.), *Truth Prevails: Demolishing Holocaust Denial: The End of the Leuchter Report*, Beate Klarsfeld Foundation, New York 1990.
- <sup>9</sup> J.-C. Pressac, *Auschwitz: Technique and Operation of the Gas Chambers*, Beate Klarsfeld Foundation, New York 1989.
- <sup>10</sup> H. Auerbach, Institut für Zeitgeschichte, letter to the *Bundesprüfstelle*, Munich, Oct. 30, 1989; H. Auerbach, November 1989, published resp. in U. Walendy, *Historische Tatsachen (HT)* No. 42, Verlag für Volkstum und Zeitgeschichtsforschung, Vlotho 1990, pp. 32 and 34.
- <sup>11</sup> J. Markiewicz, W. Gubala, J. Labeledz, B. Trzcinska, published without knowledge of the authors and without the sampling protocol as “*An official Polish report on the Auschwitz ‘gas chambers’*” in *The Journal of Historical Review*, Summer, 11(2) (1991), pp. 207-216. (online: [vho.org/GB/Journals/JHR/11/2/IHR207-216.html](http://vho.org/GB/Journals/JHR/11/2/IHR207-216.html)); their own publication appeared three years later: J. Markiewicz, W. Gubala, J. Labeledz, *Z Zagadnien Nauk Sadowych, Z. XXX* (1994), pp. 17-27 (online: [www2.ca.nizkor.org/ftp.cgi/orgs/polish/institute-for-forensic-research/post-leuchter.report](http://www2.ca.nizkor.org/ftp.cgi/orgs/polish/institute-for-forensic-research/post-leuchter.report)).
- <sup>12</sup> Regarding critique of the report of J. Markiewicz *et al.* (note 11): G. Rudolf, *DGG* 43(1) (1995), pp. 22-26 (online: [vho.org/D/Kardinal/Leuchter.html](http://vho.org/D/Kardinal/Leuchter.html)); English: [vho.org/GB/Books/cq/leuchter.html](http://vho.org/GB/Books/cq/leuchter.html)); J. Markiewicz, W. Gubala, J. Labeledz, G. Rudolf, correspondence, in *Sleipnir* (Verlag der Freunde, Postfach 35 02 64, D-10211 Berlin) 1(3) (1995), pp. 29-33; reprint in Herbert Verbeke (ed.), *Kardinalfragen zur Zeitgeschichte*, V.H.O., Postbus 60, B-2600 Berchem 1996 (online *ibid.*).
- <sup>13</sup> W. Wegner, in U. Backes, E. Jesse, R. Zitelmann (eds.), *Die Schatten der Vergangenheit*, Propyläen, Frankfurt/Main 1990, pp. 450ff. (online, including critiques by G. Rudolf: [vho.org/D/dsdv/Wegner.html](http://vho.org/D/dsdv/Wegner.html)).
- <sup>14</sup> Regarding critiques of Jean-Claude Pressac, *op. cit.* (note 9): M. Weber, *JHR* 10(2) (1990), pp. 231-237 (online: [vho.org/Journals/JHR/10/2/Weber231-237.html](http://vho.org/Journals/JHR/10/2/Weber231-237.html)); C. Mattogno, *JHR* 10(4) (1990), pp. 461-485 (online: [.../4/Mattogno461-486.html](http://.../4/Mattogno461-486.html)); R. Faurisson, *Revue d’Histoire Révisionniste* 3 (1990), pp. 65-154 (online: [www.lebensraum.org/french/rhr/pressac.pdf](http://www.lebensraum.org/french/rhr/pressac.pdf)); Eng.: *JHR* 11(1) (1991), pp. 25-66; *JHR* 11(2) (1991), pp. 133-175; E. Aynat, *JHR* 11(2) (1991), pp. 177-206 (online: [vho.org/Journals/JHR/11/2/Aynat177-206.html](http://vho.org/Journals/JHR/11/2/Aynat177-206.html)); A. R. Butz, *JHR* 13(3) (1993), pp. 23-37; W. Häberle, *DGG* 39(2) (1991), pp. 9-13 (online: [vho.org/D/DGG/Haerberle39\\_2.html](http://vho.org/D/DGG/Haerberle39_2.html)); W. Schuster, *ibid.*, pp. 13-17 (online: [vho.org/D/DGG/Schuster39\\_2.html](http://vho.org/D/DGG/Schuster39_2.html)); U. Walendy, *HT* No. 50, Verlag für Volkstum und Zeitgeschichtsforschung, Vlotho 1991; Walendy, *HT* No. 52, *ibid.*, 1992; Walendy, *HT* No. 60, *ibid.*, 1993.
- <sup>15</sup> J. Bailer, in Dokumentationszentrum des österreichischen Widerstandes, Bundesministerium für Unterricht und Kultur (ed.), *Amoklauf gegen die Wirklichkeit*, Vienna 1991, pp. 47-52.
- <sup>16</sup> G. Wellers, *Dachauer Hefte* 7(7) (1991), pp. 230.
- <sup>17</sup> M. Weber, *JHR* 12(4) (1992-93), pp. 421ff. (online: [ihr.org/jhr/v12/v12p421\\_Weber.html](http://ihr.org/jhr/v12/v12p421_Weber.html)); P. Grubach, *ibid.*, pp. 445ff. (online: [.../v12p445\\_Grubach.html](http://.../v12p445_Grubach.html)).
- <sup>18</sup> E. Gauss, *DGG* 41(2) (1993), pp. 16 (Online: [vho.org/D/DGG/Gauss41\\_2.html](http://vho.org/D/DGG/Gauss41_2.html)); E. Gauss, *Vorlesungen über Zeitgeschichte*, Grabert, Tübingen 1993 (online: [vho.org/D/vuez/v1.html](http://vho.org/D/vuez/v1.html)).
- <sup>19</sup> R. Kammerer, A. Solms, *Das Rudolf Gutachten*, Cromwell, London 1993 (an updated version is available online: [vho.org/D/rga](http://vho.org/D/rga)).
- <sup>20</sup> Aside from S. Z. Shapiro (ed.), *op. cit.* (note 8), other mostly polemical accounts of revisionist arguments have been published by the establishment: D.E. Lipstadt, *Denying the Holocaust: The Growing Assault on Truth and Memory*,

and expanded and revised several times<sup>27</sup> – focused on engineering and chemical aspects of the alleged ‘gas chambers’ in Auschwitz, and shall be summarized and supplemented in the following. The alleged ‘gas chambers’ of the concentration camp Majdanek, which were also a subject of the Leuchter Report, were briefly discussed in the German version of this contribution, but were replaced here by a far better contribution recently written by Carlo Mattogno (see next chapter). We shall dispense with an account of the ongoing debate about the interpretation of the documents found to date with respect to the issue of ‘gas chambers’ in Auschwitz, and, at least as interesting, with many other topics of this and related camps; serious readers are referred to the relevant literature.<sup>27-31</sup>

- 
- Free Press, New York 1993; K. S. Stern, *Holocaust Denial*, American Jewish Committee, New York 1993; A. M. Schwartz, *Hitler’s Apologists: The Antisemitic Propaganda of Holocaust “Revisionism”*, The Anti-Defamation-League, New York 1993; regarding the latter three titles, cf. T. J. O’Keefe, *JHR* 13(6) (1993), pp. 28-36.
- <sup>21</sup> J.-C. Pressac, *Les Crématoires d’Auschwitz, la Machinerie du meurtre de masse*, CNRS, Paris 1993; German: *Die Krematorien von Auschwitz: Die Technik des Massenmordes*, Piper, Munich 1994.
- <sup>22</sup> Critiques of Pressac, *op. cit.* (note 21); A.N.E.C., R. Faurisson, S. Thion, P. Costa, *Nouvelle Vision* 31 (1993), pp. 11-79; cf. R. Faurisson, *JHR* 14(1) (1994), pp. 23f.; R. Faurisson, “Réponse à Jean-Claude Pressac”, *R.H.R.*, Boîte Postale 122, 92704 Colombes Cedex 1994; H. Verbeke (ed.), *Auschwitz: Nackte Fakten*, Vrij Historisch Onderzoek, Berchem 1995 (vho.org/D/anf).
- <sup>23</sup> Dr. J. Bailer, in B. Bailer-Galanda, W. Benz, W. Neugebauer (eds.), *Wahrheit und Auschwitzlüge*, Deuticke, Vienna 1995, pp. 111-118.
- <sup>24</sup> Regarding critiques of J. Bailer, *op. cit.* (note 23), cf. G. Rudolf, “Zur Kritik an ‘Wahrheit und Auschwitzlüge’” in Herbert Verbeke (ed.), *op. cit.* (note 12) (online: vho.org/D/Kardinal/Wahrheit.html; English: vho.org/GB/Books/cq/critique.html).
- <sup>25</sup> B. Clair, “Revisionistische Gutachten”, *Vierteljahreshefte für freie Geschichtsforschung (VffG)* 1(2) (1997), pp. 102f (online: vho.org/VffG/1997/2/Clair2.html); critiques of this: G. Rudolf, “Das Rudolf Gutachten in der Kritik”, *ibid.*, pp. 104-108 (online: .../RudGut2.html).
- <sup>26</sup> Richard J. Green, “Leuchter, Rudolf and the Iron Blues”, April 25, 1998, and more thoroughly: “The Chemistry of Auschwitz”, May 10, 1998, The Holocaust History Project, www.holocaust-history.org/auschwitz/chemistry; regarding refutation cf. Germar Rudolf, “Das Rudolf Gutachten in der Kritik, Teil 2”, *VffG* 3(1) (1999), pp. 77-82, (online: .../1999/1/RudDas1.html); Engl.: “Some considerations about the ‘Gas Chambers’ of Auschwitz and Birkenau”, paper presented at the 1998 Revisionist Adelaide Conference (online: vho.org/GB/Contributions/Green.html; Greens reply: www.holocaust-history.org/auschwitz/chemistry/not-the-science/; my response to that: vho.org/GB/Contributions/CharacterAssassins.html).
- <sup>27</sup> Latest issue: G. Rudolf, *Das Rudolf Gutachten*, 2<sup>nd</sup> ed., Castle Hill Publishers, Hastings 2001; online, also for updates, see vho.org/D/rga2; English: *The Rudolf Report*, Theses & Dissertations Press, Chicago, IL, 2003 (online: vho.org/GB/Books/trr).
- <sup>28</sup> Robert Jan van Pelt, *The Pelt Report*, Irving vs. Lipstadt (Queen’s Bench Division, Royal Courts of Justice, Strand, London, David John Cawdell Irving vs. (1) Penguin Books Limited, (2) Deborah E. Lipstadt, Ref. 1996 I. No. 113.
- <sup>29</sup> For a detailed critique of van Pelt’s flawed *The Pelt Report* see Germar Rudolf, “Gutachter- und Urteilsschelte”, *VffG* 4(1) (2000), pp. 33-50 (online: vho.org/VffG/2000/1/Rudolf33-55.html; Engl.: vho.org/GB/Contributions/RudolfOnVanPelt.html and .../CritiqueGray.html).
- <sup>30</sup> Apart from my report cf. J.-C. Pressac, *op. cit.* (notes 9 & 21), R. Faurisson (note 14), H. Verbeke (ed.) (note 22), as well as the chapter by C. Mattogno and F. Deana, this volume. See also M. Gärtner, “Vor 25 Jahren: Ein anderer Auschwitzprozess”, *VffG* 1(1)(1997), pp. 24f. (online: vho.org/VffG/1997/1/Gaertner1.html); Gärtner, “Volksverhetzung? Volksverhetzung!”, *VffG* 1(4)(1997), pp. 244f. (online: vho.org/VffG/1997/4/Gaertner4.html); Gärtner, A. Niepel, W. Rademacher, “Aus der Forschung”, *VffG* 1(4)(1997), pp. 265ff. (online: vho.org/VffG/1997/4/Niepel4.html); Gärtner, W. Rademacher, “Grundwasser im Gelände des KGL Birkenau”, *VffG* 2(1)(1998), pp. 2-12 (online: vho.org/VffG/1998/1/GaeRad1.html); Gärtner, A. Niepel, W. Rademacher, W. Meier und F. Schumacher “Aus der Forschung”, *VffG* 2(1)(1998), pp. 54ff. (online: vho.org/VffG/1998/1/Forsch1.html); J. Graf, C. Mattogno, *Concentration Camp Majdanek. A Historical and Technical Study*, Theses & Dissertations Press, Chicago, IL, 2003 (online: vho.org/GB/Books/ccm); H.J. Nowak, “Kurzwellen-Entlausungsanlagen in Auschwitz”, *VffG* 2(2) (1998), pp. 87-105 (online: vho.org/VffG/1998/2/Nowak2.html; see his contribution in this handbook); W. Rademacher, “Sauna ein ‘Verbrechen’?”, *VffG* 1(4)(1997), pp. 245ff. (online: vho.org/VffG/1997/4/Rademacher4.html); M. Gerner, “‘Schlüsseldokument’ ist Fälschung”, *VffG* 2(3) (1997), pp. 166-174 (online: vho.org/VffG/1998/3/Gerner3.html), Carlo Mattogno, “Morgue Cellars of Birkenau: Gas Shelters

## 2. Design of the Fumigation Facilities in Auschwitz

### 2.1. The Camp Complex of Auschwitz

According to Pressac<sup>9</sup> the facilities of Auschwitz I/Main Camp were originally part of a barracks under the Dual Monarchy (later Poland) and were converted into a concentration camp after the war against Poland. After the start of the Russian Campaign, Auschwitz II/Birkenau was rebuilt as a prisoner-of-war camp of the Waffen-SS, to accommodate Russian prisoners-of-war. Later it increasingly used to house Jews, who were deported there from all German-occupied parts of Europe. The arrival of great numbers of people made for severe health-related problems in all camps. For this reason all the camps had extensive disinfection and delousing facilities. Since the end of the First World War, the general fumigant of choice for pest control (lice, bedbugs, fleas, beetles etc.) had been the product Zyklon B (hydrogen cyanide adsorbed onto diatomaceous earth or gypsum). In Compounds 1a/b of Birkenau, Buildings 5a and 5b each had a wing where one room was reserved for the delousing of material objects with hydrogen cyanide. These buildings are completely intact still today.

On the whole, historians today assume that the large cremation facilities in the camps did not serve only the purpose they had originally been intended for, namely the removal of victims of epidemics, which did occur quite frequently despite intensive efforts at disinfection. Later, they claim, these facilities were used instead or additionally for mass extermination, including that of the Jews. For this purpose, some rooms of the respective cremation facilities were allegedly slightly altered; people were then killed ('gassed') there with Zyklon B.

According to eyewitness testimony, there was at that time a homicidal 'gas chamber' in crematorium I of the Main Camp, Auschwitz I. In Birkenau (Auschwitz II), approximately 1.5 miles away, there are said to have been 4 more homicidal 'gas chambers' in crematoria II through V, as well as two farm houses, located outside the camp itself and altered for gassing purposes.

The individual facilities are discussed in the following.

### 2.2. Delousing Chambers for Material Objects

Rooms where material objects were deloused with Zyklon B still exist intact today in the West and East wings of Buildings 5a and 5b of Compounds B1a and b respectively. The original German building plans identify these rooms as "*Gaskammer*" (gas chamber),<sup>32</sup> the term commonly used in those days for disinfestation facilities.<sup>33</sup> These delousing rooms, equipped with airlocks, had two round openings approximately 20 inches in diameter in their ceiling gables, fitted with an air intake and an exhaust ventilator. The roof had three ventilation chimneys; three furnaces were installed in these rooms during the time they were in use.<sup>34</sup> This set-up, with heating and ventilation, must have been

---

or *Disinfesting Chambers?*" ([www.russgranata.com/leichen.html](http://www.russgranata.com/leichen.html)), "*The Auschwitz Central Construction Headquarters Letter Dated 28 June 1943: An Alternative Interpretation*" ([www.russgranata.com/lalett.html](http://www.russgranata.com/lalett.html)); "*'Sonderbehandlung' and Crematory II*" ([www.russgranata.com/sonder.html](http://www.russgranata.com/sonder.html)), to name only a few.

<sup>31</sup> S. Crowell, "*Technik und Arbeitsweise deutscher Gasschutzbunker im Zweiten Weltkrieg*", *VffG* 1(4) (1997), pp. 226-244 (online: [vho.org/VffG/1997/4/Crowell4.html](http://vho.org/VffG/1997/4/Crowell4.html)); for a list of English articles on that cf. the entry "Crowell, Samuel" at [vho.org/i/a/C.html](http://vho.org/i/a/C.html).

<sup>32</sup> Blueprints of Buildings 5a/b: J.-C. Pressac, *op. cit.* (note 9), pp. 55-8; photos of the exterior, pp. 59f.; in 1943 Building 5a was altered to serve as hot-air delousing facility; cf. G. Rudolf, *The Rudolf Report*, *op. cit.* (note 27), pp. 73-78.

<sup>33</sup> See, e.g., the title of a well know and widespread book of these times: F. Puntigam, H. Breymesser, E. Bernfus, *Blausäuregaskammern [sic!] zur Fleckfieberabwehr*, Sonderveröffentlichung des Reichsarbeitsblattes, Berlin 1943. Emphasis added by the author; J. Graf and C. Mattogno, *CC Majdanek*, *op. cit.* (note 30), and H.J. Nowak, *op. cit.* (note 30) have found more examples for the use of the term "*Gaskammer*".

<sup>34</sup> J.-C. Pressac, *op. cit.* (note 9), p. 53.

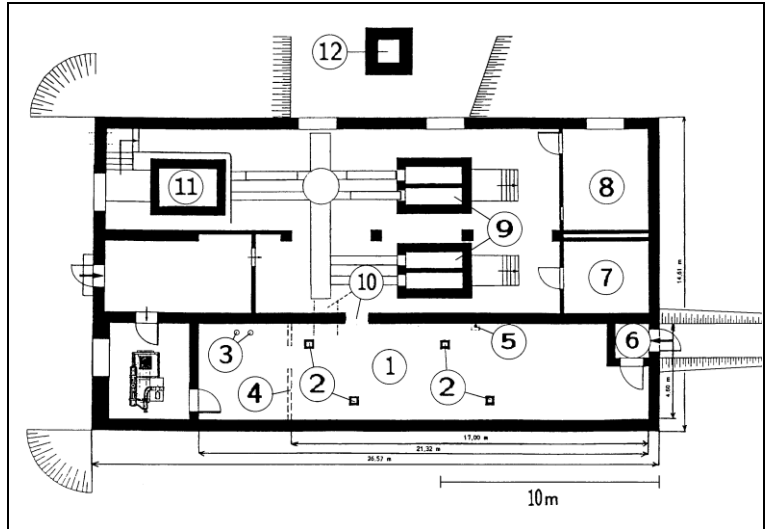

Illustration 2 shows the floor plan of the crematorium as it exists today.<sup>43</sup> After the war, it is claimed the roof was recovered with roofing felt, which concealed the Zyklon B hatches of this ‘gas chamber’. The input hatches visible today were installed after the war by the Polish Auschwitz Museum – not, according to Pressac, at their original location, but rather in a way that was considered more effective for tourist viewing purposes.<sup>44</sup> This alteration and many others carried out by the communist post-war administration of the camp, which we can discuss here only briefly, are generally acknowledged as “*falsifications*” today.<sup>45</sup>

However, the ceiling, outside walls and pillars as well as the building foundation are in their original state. If openings for input hatches and ventilation facilities had existed in the reinforced concrete roof, damage to the concrete structure would have to be visible at the appropriate spots on the unplastered inside ceiling, since such structures cannot be removed without leaving visible traces.

At one location the ceiling clearly shows signs of disintegration caused by water seeping in. Attempts have been made – in vain – to check the decay by plastering over the area affected. There are two other places where the ceiling is plastered over, in the middle of the room and towards the outside wall. Whether these patches cover up former holes or whether they are also the result of repairs is something that yet needs to be investigated. In any case they are not input openings distributed evenly throughout the room. Other than those that were added after the war, there are no such breaches in the ceiling.

Might the Auschwitz Museum have been mistaken, and used the old openings as the locations of the newly installed ones after all? The former Director of the Museum recently commented to this effect.<sup>46</sup> We shall take a closer look at his revised opinion.



**Illustration 2:** Floor plan of crematorium I in Auschwitz I (Main Camp) today, after the post-war alterations:

1: ‘gas chamber’; 2: fake Zyklon-B input hatches; 3: toilet plumbing; 4: former dividing wall between mortuary (‘gas chamber’) and wash-room, now removed; 5: bomb shelter ventilation chimney; 6: bomb shelter airlock, today wrongly called ‘entrance for the victims’; 7: urns; 8: coke fuel; 9: improperly reconstructed ovens; 10: new doorway to furnace room; dashed lines indicate location of original doorway; 11: ruins of old furnace; 12: fake chimney without connection to the building.

<sup>43</sup> J.-C. Pressac, *op. cit.* (note 9), p. 159.

<sup>44</sup> *Ibid.*, p. 133; J.-C. Pressac, *op. cit.* (note 21), p. 34.

<sup>45</sup> Cf. the French Jew Eric Conan, scholar at the famous French National Center of scientific research (CNRS): “*Autre sujet délicat: que faire des falsifications légués par la gestion communiste? [...] Tout y est faux*” [Another delicate subject: what to do with the falsifications left behind by the communist administration? ... Everything there [at crematorium I] is false.], “*Auschwitz: La Mémoire du Mal*”, *L’Express*, 19./25.1.1995; Robert van Pelt, Deborah Dwork, *Auschwitz: 1270 to the Present*, Yale University Press, New Haven and London 1996, pp. 363f.; cf also Carlo Mattogno’s review “*Architektonische Stümpereien zweier Plagiatoren*”, *VffG*, 4(1) (2000), pp. 25-33 (online: [vho.org/VffG/2000/1/Mattogno25-33.html](http://vho.org/VffG/2000/1/Mattogno25-33.html); English: “*Auschwitz 1270 to the Present*”, [www.russgranata.com/irving.html](http://www.russgranata.com/irving.html)).

<sup>46</sup> F. Piper, in an interview with D. Cole, B. Smith, Visalia, CA, 1992; cf. *JHR* 14(2) (1993), pp. 11ff.

The breaches visible in the concrete today are not plastered, nor have the remnants of the severed iron reinforcement bars been properly removed. The holes are fitted with a makeshift wooden frame, and sealed with tar. Such sloppy work does not reflect the care required in handling poison gas, nor is it typical of German workmanship. If the SS had indeed cut these holes through the concrete, one might expect not only a proper removal of the reinforcing bars, but also a uniform arrangement of the 4 hatches over the ceiling of the *original* mortuary to allow for the even distribution of Zyklon B in the room. The hatches present today, however, are spread evenly over the ceiling only if one regards the washroom, which was not added to this room until *after* the war, as being part of the mortuary (alleged homicidal ‘gas chamber’); see *illustration 2*. The configuration of the input hatches, therefore, makes sense only if they were added specifically for the facilities as they exist today as “*falsifications*” of incorrect dimensions, *i.e.*, if they were added *after* the war.

In his new book Pressac states that temporary ventilation facilities were installed in the mortuary of crematorium I in March 1941, that these were never replaced with permanent fixtures, and that it is not known how they worked.<sup>47</sup> To support this claim Pressac cites Pery Broad,<sup>48</sup> whose statements Pressac had dismissed as implausible in his first book<sup>49</sup> and which, furthermore, tell of a ventilator installed in a concrete chimney. But just as the Zyklon B input hatches, this ventilator would have had to leave detectable traces in the ceiling. It is also possible, however, that the ventilation pipe was laid through breaches in the walls, into the oven room and on from there, for example to the chimney. But since the dividing wall between the oven room and the mortuary were extensively rebuilt when the facilities were altered to serve as air-raid shelter, no traces remain to be found today.

One can conclude from all this that in all likelihood there were no hatches for the input of Zyklon B to allow these facilities to be used as homicidal ‘gas chamber’ at the time of their alleged use as such. Or, as French Professor Robert Faurisson put it: “*No holes, no ‘Holocaust’.*”

Additionally, there was no direct entrance door from outside through which the alleged victims could have entered the homicidal ‘gas chamber’. Therefore all eyewitness accounts stating that the victims were led into the ‘gas chamber’ through such a door, are dubious. Or, as French Professor Robert Faurisson put it: “*No door, no ‘destruction’.*”

## 2.4. The ‘Gas Chambers’ of Birkenau

### 2.4.1. Crematoria II and III

In terms of size, fittings and construction, these crematoria are comparable with other civilian cremation facilities built in the Reich at that time, as well as with modern ones.<sup>50</sup> Details of the construction of mortuary 1, allegedly used as homicidal ‘gas chamber’, have already been discussed elsewhere.<sup>9,18f.,21f.,27,31f.,51</sup> We shall again focus on the Zyklon B input hatches, *i.e.*, holes in this basement room, which was equipped with ventilation but no heating facilities.

*Illustration 3* (next page) shows the floor plan of mortuary 1 (the ‘gas chamber’) of crematorium II and also represents the mirror image of mortuary 1 of crematorium III; *illustration 4* shows the cross-

<sup>47</sup> J.-C. Pressac, *op. cit.* (note 21), pp. 18, 60f.

<sup>48</sup> *Ibid.*, p. 18; for Broad’s report cf. B. Naumann, *op. cit.* (note 40), pp. 200ff; regarding critiques of Broad’s statement: J. Graf, *Auschwitz. Tätergeständnisse und Augenzeugen des Holocaust*, Neue Visionen Verlag, Postfach, CH-8116 Würenlos 1994, pp. 168-176.

<sup>49</sup> J.-C. Pressac, *op. cit.* (note 9), pp. 126ff.

<sup>50</sup> For a comparison, consider the construction of modern crematoria: H.-K. Boehlke, *Friedhofsbauten*, Callwey Verlag, Munich 1974, p. 117; E. Neufert, *Bauentwurfslehre*, Ullstein Fachverlag, Frankfurt 1962, pp. 423f.

<sup>51</sup> Cf. also Lüftl’s critique of the Jagschitz Report in the chapter by W. Rademacher, this volume.



section.<sup>52</sup> According to eyewitnesses, there were also three or four hatches in the ceiling here, through which the Zyklon B was introduced.<sup>53</sup>

Regarding the evidence provided by Allied air photos, the reader is referred to the chapter by J.C. Ball in the present volume. Clearly this information suggests that either there were no input hatches on the roofs, or that these were so small that they did not show up on the air photos, so that probably someone deemed it necessary to resort to photo retouching in order to falsify the air photos accordingly.

Today the roofs of mortuaries 1 (the 'gas chambers') of both crematoria are broken and collapsed. There are no signs of shell impacts. It is assumed that these rooms were blasted.<sup>54</sup> The ceiling of mortuary 1 ('gas chamber') of crematorium II is still more or less intact and still rests partially on the concrete supporting pillars. Large parts of the walls and concrete ceiling still accessible in the interior of the cellar remain in their original state, protected from weathering. There are no visible signs of any erosion or corrosion.

In his book Pressac shows pictures of ventilation pipe openings in the roof of mortuary 2 of crematorium II as well as in the concrete ceiling of the oven room of crematorium III.<sup>55</sup> *Illustration 5* shows one of the five openings into the oven room. In contrast to these cleanly cut holes, the only two holes to be found in the roof of mortuary 1 ('gas chamber') of crematorium II, which Pressac claims to allegedly have been Zyklon B input hatches, are clearly openings that were broken through the reinforced-concrete roof later (see *illustrations 6 and 7*). Pressac and van Pelt concede that these are the only holes visible today.<sup>56</sup>

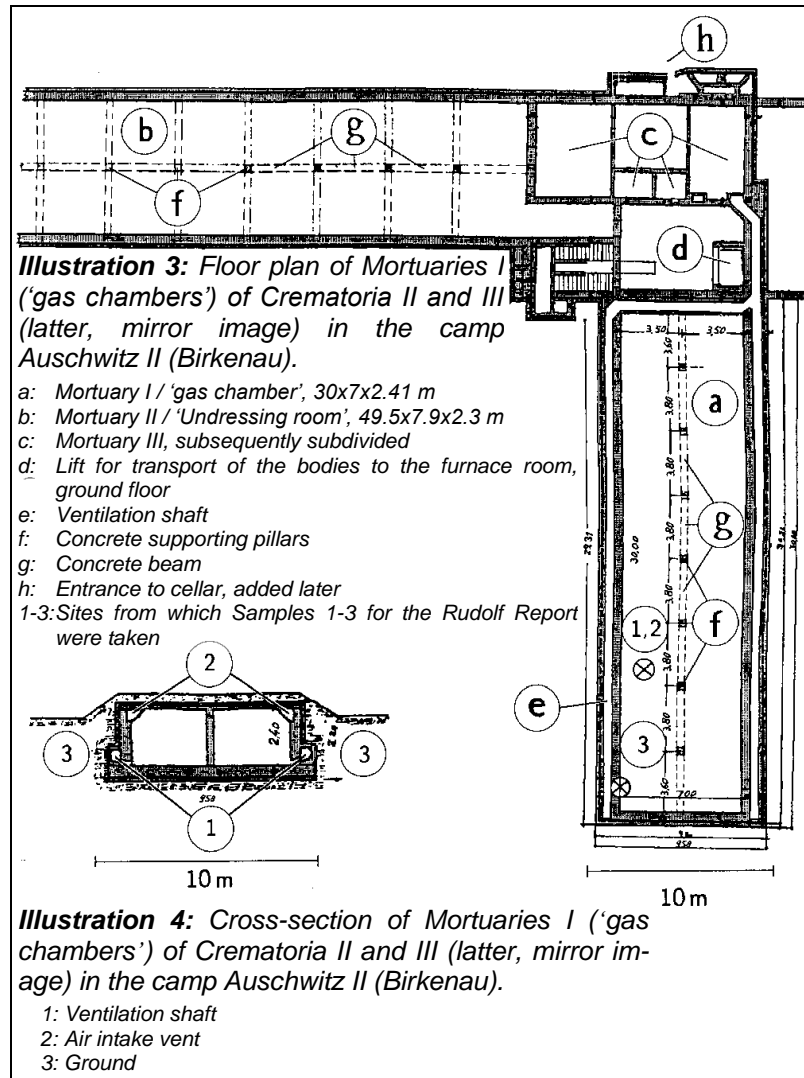

<sup>52</sup> J.-C. Pressac, *op. cit.* (note 9), pp. 319-329. Building plans for crematoria II and III.

<sup>53</sup> For the most graphic description, cf. the testimony of Schultze, engineer with the firm Topf & Söhne, in a KGB interrogation; cf. G. Fleming in *The New York Times*, July 18, 1993, p. E19; *Der Spiegel* 40/1993, p. 154.

<sup>54</sup> Oddly enough, in the basement of crematorium II, in the vestibule leading to the mortuaries, one finds a good number of gardening tools (shovels, spades etc.) partly covered by rubble. One would expect that in an orderly evacuation and subsequent demolition of the building the Germans would have taken these tools with them.

<sup>55</sup> J.-C. Pressac, *op. cit.* (note 9), pp. 365f.

<sup>56</sup> *Ibid.*, p. 354. It is significant that in his new book, *op. cit.* (note 21), Pressac simply ignores the problem of the Zyklon B input hatches and the indispensable, but missing, holes in the concrete ceiling. Van Pelt, *op. cit.* (note 28), p. 295.



**Illustration 5:** Cleanly cut ventilation hole in the ceiling of the furnace room, opening into upper story. Note the damage caused by blasting.



**Illustration 6:** Alleged Zyklon B input hatch in the roof of mortuary 1 (‘gas chamber’) of crematorium II; entrance to part of the cellar still accessible today.



**Illustration 7:** Alleged Zyklon B input hatch in the ceiling of mortuary 1 (‘gas chamber’) of crematorium II. It is clearly visible that the reinforcing bars in the reinforced concrete were not even removed; they were merely bent back.



**Illustration 8:** Notch (fatigue) effect resulting in inserted openings from the application of force. The only crack running through the wall proceeds, naturally enough, from the corner of the window.<sup>57</sup>

Without exception the openings visible today in the roofs of mortuaries 1 (‘gas chambers’) of crematoria II and III are holes that were broken through the concrete after completion of the roofs. If any of these holes had served as Zyklon B input hatches, then they would have to have been added after the roofs were completed. Since the roofs of these facilities were poured in the winter of 1942/43,<sup>58</sup> any additional openings could have been added to the roofs of both crematoria in spring 1943 at the earliest. But the mass extermination in the facilities of crematorium II is said to have been in full swing by then. This would imply an inconceivably stupid error in planning.

Also, given such an opening broken through the roof of one of the mortuaries 1 (‘gas chambers’) after construction, *i.e.*, causing damage to the concrete and the iron reinforcement structure, it would have been inevitable for the ceiling breaks and cracks resulting from a subsequent blasting of the building to run primarily through these holes. The reason for this is that blasting represents an abnormal force, that material tension reaches very high peak levels around the corners of inserted openings (notch or fatigue effect), and that cracks proceed preferentially from weak points. Therefore, particu-

<sup>57</sup> *Kurier*, August 30, 1992, p. 20: “*Wenn Felsen fallen*” (When rocks are falling).

<sup>58</sup> J.-C. Pressac, *op. cit.* (note 9), pp. 338f. In his new book, *op. cit.* (note 21), Pressac reproduces a large photo showing an outside view of the ceiling of mortuary 1 of crematorium II, taken in winter 1943 (Document 27) – without any trace of an input hole!

larly such openings whose belated addition has already damaged the structure of the surrounding concrete represent points where cracks and breaks are not only likely, but inevitable. This is demonstrated by *illustrations 5* and *8* (previous page). Even though, in *illustration 5*, the explosion pressure in the ground-level oven room was able to escape in every direction and the ceiling connecting to the upper floor remained almost fully intact, three of the five oven room air vent holes, which had been neatly cast into the concrete ceiling and reinforced, were completely destroyed. Clearly visible cracks formed at the corners of two other holes, shown in the photos reproduced by Pressac.<sup>55</sup> *Illustration 8* shows the consequences of a rockfall on a house wall with a window. The only crack in the wall proceeds from the window.

In the mortuaries of crematoria II and III the pressure from the explosion could only escape upward, which is why their ceilings were much more severely damaged than the ceiling of the oven room or the wall of the house hit by a rockfall. The alleged Zyklon B input hatches in the roof of mortuary 1 ('gas chamber') of crematorium II, however, are conspicuous for their relatively undamaged condition; none of the many cracks and breaks in the ceiling run through the hole shown in *illustration 7*. An on-site examination reveals the random arrangement of openings in places where the mortuary ceiling is actually undamaged! As John C. Ball shows in this volume, in terms of size or location these holes also do not correspond at all with the patches apparent on the air photos – something which even Pressac has realized.<sup>59</sup>

What is more, at the opening shown in *illustration 7* the reinforcement bars were only cut through once and then bent back. They are still full length. It would be quite possible to bend them back down and weld them to the protruding stubs at left (covered in snow), although we advise no one to try it in order to avoid any damage to these extremely important pieces of evidence.<sup>60</sup> Remnants of the reinforcement bars are also still visible at the edge of the hole in *illustration 6*. No devices for the introduction of gas could ever have been securely installed, much less sealed to the outside, in such crudely cut and unfinished holes from which not even the reinforcement bars had been removed. Any attempt to do so would have endangered the entire vicinity, including the alleged perpetrators, with the poison gas that would have escaped in enormous quantities. What is more, only brute force could have stopped the supposed victims from escaping through these holes or even throwing the poison gas carrier out, since after all these holes could never have served as input hatches – they were never finished.

One can therefore conclude with absolute certainty that the alleged input hatches were not added until after the buildings had been blown up, *i.e.*, after the German retreat.<sup>61</sup> So, here as well the saying of Prof. Robert Faurisson goes: "*No holes, no 'Holocaust'*".

Thus, the alleged hatches shown in pictures as published by Pressac<sup>62</sup> and Czech<sup>63</sup> (cf. *illustration 9*, enlarged in *illustration 10*, next page), must be interpreted differently. If these objects were indeed Zyklon B hatches, as Pressac assumes, they should be of equal size and equidistant, *i.e.*, evenly distributed on the roof of morgue 1. But as shown in *illustration 10*, the objects have different sizes. According to their shades, they probably have a rectangle shape, but not the same orientation.

---

<sup>59</sup> J.-C. Pressac, *op. cit.* (note 9), p. 436.

<sup>60</sup> The Australian revisionist Fredrick Toben broke one of the bars off by trying to bend it back in May 1997; cf. the new image of this hole as taken by Toben after his destructive action on the internet: [www.air-photo.com](http://www.air-photo.com).

<sup>61</sup> Currently funds are being raised for intended conservation work to be performed on the buildings of the concentration camp Auschwitz: "*Neue Inschrift im KZ Auschwitz, 60 Millionen für die Erhaltung*", *Allgemeine Jüdische Wochenzeitung*, June 6, 1992, p. 1. If this project should really be carried out, it would represent a destruction of evidence before any extensive international forensic investigations of the site have ever been carried out.

<sup>62</sup> J.-C. Pressac, *op. cit.* (note 9), p. 340, dated roughly Feb. 9-11, 1943.

<sup>63</sup> D. Czech, *Kalendarium der Ereignisse im Konzentrationslager Auschwitz-Birkenau 1939 - 1945*, Rowohlt, Reinbek 1989, p. 454.

When evaluating their possible position on the roof by means of a perspective drawing, *illustration 11*, it turns out that they are standing closely together and are most likely situated all together on one and the same half of the roof. If there were holes under these objects going through the roof, then they should still be there today, but there are no traces of such holes. This is proof that these objects cannot have been Zyklon B hatches. Maybe they are just some sort of building material placed on the roof, since this crematorium was still under construction in February 1943.

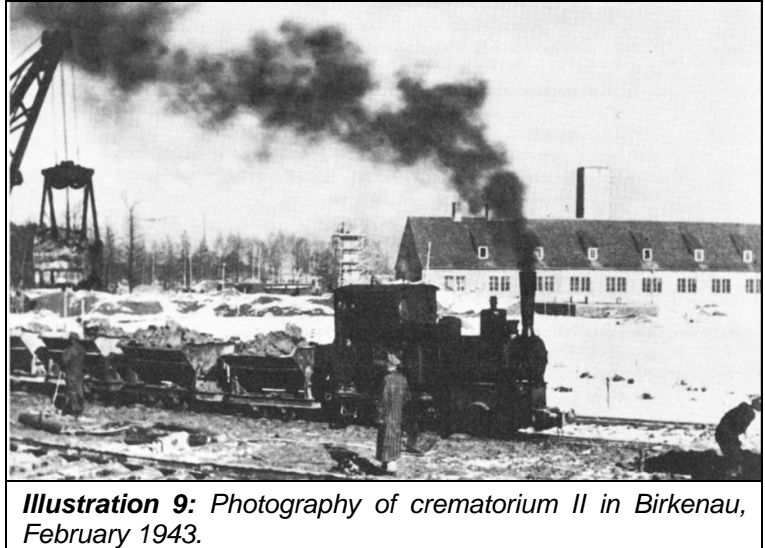

**Illustration 9:** Photography of crematorium II in Birkenau, February 1943.

Besides this, it should be noted that these objects are not visible on similar ground level photos from Jan. 20, 1943,<sup>64</sup> and summer 1943.<sup>65</sup>

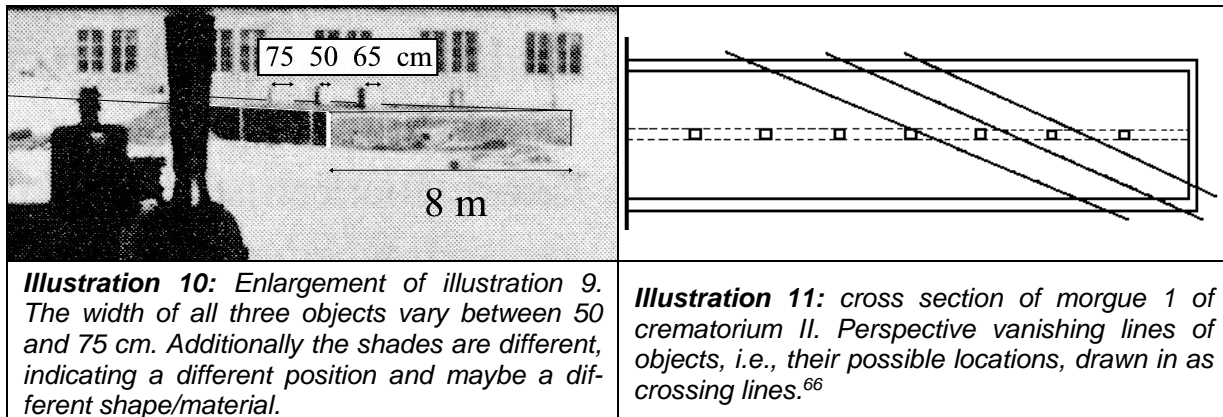

**Illustration 10:** Enlargement of illustration 9. The width of all three objects vary between 50 and 75 cm. Additionally the shades are different, indicating a different position and maybe a different shape/material.

**Illustration 11:** cross section of morgue 1 of crematorium II. Perspective vanishing lines of objects, i.e., their possible locations, drawn in as crossing lines.<sup>66</sup>

#### 2.4.2. Crematoria IV and V

All that exists for these facilities<sup>67</sup> are a few documents and contradictory, partly unbelievable eyewitness statements.<sup>68</sup> According to Pressac, the two western, heated, unidentified rooms, as well as their anterooms, served as ‘gas chambers’. There is no evidence for any ventilation facility for these rooms prior to May 1944. For this reason Pressac suggests that up to that date ventilation was achieved by means of natural draft. In crematorium IV, but not in crematorium V, a ventilation facility is said to have been installed in May 1944, when the extermination of the Hungarian Jews allegedly began.<sup>69</sup> Pressac shows a blueprint for this, but fails to cite a source for it. According to his blueprint, the ventilation shaft would have opened into an additional chimney of crematorium IV. However,

<sup>64</sup> D. Czech, *op. cit.* (note 63), p. 398, and J.-C. Pressac, *op. cit.* (note 9), p. 335.

<sup>65</sup> J.-C. Pressac, *op. cit.* (note 9), p. 341, even if Pressac states here that they are visible. He must have been drunken when writing this, as he frequently was, see his confession, *ibid.*, p. 537.

<sup>66</sup> Taken from Jean-Marie Boisdefeu, *La controvers sur L’extermination des Juifs par les Allemands*, vol. 1, V.H.O., Berchem 1994, p. 168.

<sup>67</sup> For blueprints of these facilities, see G. Rudolf, *The Rudolf Report*, *op. cit.* (note 27) p. 135.

<sup>68</sup> J.-C. Pressac, *op. cit.* (note 9), pp. 379ff., section about crematoria IV and V.

<sup>69</sup> J.-C. Pressac, *op. cit.* (note 21), pp. 89f.

such a chimney is not visible on the air photos of May, June and September 1944.<sup>70</sup> As well, and strangely enough, the rooms described as ‘gas chambers’, beside the coke fuel and the physician’s rooms, lack any ventilation chimneys – unlike all the other rooms in the two crematoria. Pressac himself points out that the lack of ventilation of the chambers would have resulted in the gas spreading through the entire rest of the building, so that all work would have had to cease for many hours.<sup>71</sup> He adds further that due to the technical inadequacies, the gassings in these rooms must have been a ludicrous procedure resembling a circus act.<sup>72</sup>

Unfortunately one must deal with such witness stories and try to keep a straight face in the process.

### 2.4.3. Farm Houses (‘Bunkers’) I and II

The location and design of the redesigned farm houses (‘Bunkers’) and undressing barracks, allegedly situated west to northwest of the Birkenau camp, are not precisely known.<sup>73</sup> Pressac describes the eyewitness testimony in this respect as contradictory.<sup>74</sup> The building called Farm House (or Bunker) II is sometimes visible on air photos,<sup>75</sup> whereas there is never any trace of Farm House I.<sup>76</sup> Since the gassings attested to for these facilities resemble those for crematoria IV and V (input chutes at the side, no ventilation, but no heating either), our remarks in Section 2.4.2. apply all the more strongly in this case. In his new book Pressac even goes one better. He shows<sup>77</sup> that, due to a paper authored by G. Peters,<sup>78</sup> the Camp Administration had been aware of the advanced *delousing* technique using Zyklon B since 1941. Without documenting his reasoning, he interprets the Camp Administration’s interest in this paper to the effect that this new technique of killing *human beings* was to have been implemented in Bunker II, which was due for alteration. In the end, however, according to Pressac’s unfounded allegations, they refrained from doing so because the suppliers allegedly had difficulties in keeping up with the demand, and so Bunker II, like Bunker I, was operated without heating or ventilation.

A nugget of absurdity truly worth savoring: the Camp Administration, while being fully aware of the advanced methods available for Zyklon B *delousing* facilities, allegedly resorted to sledgehammer methods to gas people not only in Bunkers I and II, but later on in all other crematoria as well, while at the same time there were no noteworthy production delays to interfere with the construction of hundreds of advanced delousing chambers throughout German occupied Europe, and even in the new central sauna of Auschwitz-Birkenau! The Germans even developed the nowadays well-known microwave technology – *to kill lice!* They installed those extraordinarily expensive facilities exclusively in Auschwitz to *save* the lives of the inmates!<sup>79</sup> And we are to believe that the Germans

---

<sup>70</sup> J. C. Ball, *Air Photo Evidence*, Ball Resource Services Ltd., Delta, B.C., Canada, 1992, pp. 69ff.

<sup>71</sup> J.-C. Pressac, *op. cit.* (note 21), pp. 67, 89.

<sup>72</sup> J.-C. Pressac, *op. cit.* (note 9), p. 386.

<sup>73</sup> Alleged ruins of the foundations of Farm House II are the only traces remaining today, J.-C. Pressac, *op. cit.* (note 9), p. 176.

<sup>74</sup> *Ibid.*, pp. 161ff.

<sup>75</sup> See the chapter by J. C. Ball, this volume.

<sup>76</sup> However, according to personal communication from Michael Gärtner, there does exist a document from the SS Camp Administration ordering the installation of a *delousing* facility in an existing farm house in Birkenau, which would indicate that there might be a true core to the gassing rumors: Obviously, this facility served as a delousing chamber. An article about that is in preparation and should appear in *VffG* soon.

<sup>77</sup> J.-C. Pressac, *op. cit.* (note 21), pp. 41f.

<sup>78</sup> G. Peters, E. Wüstinger, “*Entlausung mit Zyklon Blausäure in Kreislauf-Begasungsanlagen*”, *Zeitschrift für hygienische Zoologie und Schädlingsbekämpfung* 10/11 (1941).

<sup>79</sup> See H.J. Nowak, *op. cit.* (note 30), and his contribution in this handbook; a more recent synopsis about the general efforts of the German authorities to save the inmates’ lives was published by M. Weber, “*High Frequency Delousing*

couldn't get hold of the material required to install proper Zyklon B delousing technology in their homicidal ‘gas chambers’?

## 2.5. Engineering Conclusions

Since every room can be deloused with Zyklon B, every room could be considered as serving as a delousing facility in principle. But even the most primitive delousing facilities which were used more than just occasionally – whether in the early days of Auschwitz, or elsewhere – would have been equipped with an exhaust ventilator and frequently even with a heating system, of which the latter is helpful but not absolutely necessary (for details see Section 4.1.). No room, however, which lacked a ventilation system need be seriously considered as a facility for killing human beings with poisonous gas. For execution ‘gas chambers’, there must be a way to introduce the poison gas substance from outside, which is not absolutely necessary, but also helpful, in the case of delousing chambers for material objects. The salient point, therefore, is that a room that had either no means for introducing the poison gas from outside, or no ventilation facilities, cannot be seriously considered as execution ‘gas chamber’. An overview of the rooms discussed here is reflected in Table 1.

**Table 1: Facilities and Suitability of Fumigation Chambers**

Location \ Property	Poison Gas Input	Heating	Ventilation	Suitable as Delousing Chamber	Suitable as Execution Chamber
Delousing Chambers	○	●	●	yes	if equipped with input
Crematorium I	×	×	○	hardly/perhaps	no
Crematoria II & III	×	×	●	perhaps	no
Crematoria IV & V	●	●	×	hardly	hardly
Farm Houses I & II	○	× / ○	× / ○	hardly/perhaps	no

● = present; ○ = possibly present; × = not present

This does not even consider, among other things, that a hypothetical execution ‘gas chamber’ would need to be proof against victims attempting to break out (*e.g.*, a massive iron gas-tight door opening outward), and that the ventilation system would have to be powerful enough for its task.

Even though the literature largely agrees on the outfitting of the rooms of crematoria IV and V as well as of the Farm Houses, the matter is nevertheless somewhat speculative due to a lack of documentation and material evidence. Pressac's recent discovery regarding crematorium IV's alleged ventilation system of unknown properties pertains only to the time after May 1944 and strikes us as no less speculative.<sup>80</sup>

Fortunately, precisely that so-called ‘gas chamber’ in which the most people were allegedly killed with poison gas during the Third Reich has survived to the present in an almost perfectly intact state: mortuary 1 of crematorium II. It is an engineering certainty that, contrary to all eyewitness testimony, these facilities had no Zyklon B input openings in their ceiling during the time of their alleged operation.<sup>81</sup> And if this is so, then this room cannot have been used as site for mass murder with poison gas.

*Facilities at Auschwitz*”, *The Journal of Historical Review*, 18(3) (1999), pp. 4-13 (online: ihr.org/jhr/v18/v18n3p-4\_Weber.html).

<sup>80</sup> In *VffG* some new findings about these facilities will be published shortly.

<sup>81</sup> A more detailed review of the state of knowledge about the ceiling of mortuary 1 of crematorium II and its missing holes, including an analysis of several ground and air photos, is to appear in *VffG* shortly.

Until and unless the question of how the poison gas substance should have been introduced into this putative ‘gas chamber’ is answered, all further speculations as to the nature of the killings and the possible chemical evidence for them are merely academic exercises without substance. *Therefore the discussion of Auschwitz could well end right here.* The following, however, discusses some of the questions of a chemical nature that have been raised by Leuchter.

### 3. Zyklon B and Its Effects

#### 3.1. The Poison Gas Hydrogen Cyanide (HCN)

Hydrogen cyanide (HCN) blocks the oxygen supply to the cells, preventing the oxidation processes vital for cell life.<sup>82</sup> Due to the brain’s great sensitivity to lack of oxygen, a person who has inhaled high concentrations of HCN suffers less (but still intensively) than a person who has swallowed cyanide salts (*e.g.*, KCN), which results in heavy and extremely painful muscle cramps. This is the reason why this method of HCN execution is used in some states in the USA. A dose of 1 mg HCN per kg body weight is generally considered fatal, whereas non-lethal doses of HCN are quickly eliminated by the body without further consequences. The bright red color of the blood and of the cadaveric lividities are typical post-mortem findings in HCN-related deaths.<sup>83</sup>

It is generally advisable to avoid perspiring when dealing with HCN, since damp skin absorbs HCN most readily. In cases of poisoning via the skin, concentrations of 0.6%/vol. are hazardous, and a few minutes’ exposure to 1%/vol. may be fatal.<sup>84</sup>

Table 2 shows which concentration of HCN in air can be rapidly fatal to humans. Naturally these values are not the results of experiments on humans, but projections based, for safety reasons, on the lower safety limit. To demonstrate: a stout person weighing 100 kg (roughly 220 lbs.) must absorb approximately 100 mg HCN for this to be fatal. The respiration rate of a person at rest is about 15 liters of air per minute.<sup>85</sup> Given a HCN concentration of 0.02%/vol. (approximately 0.24 mg/liter), the victim must breathe in about 416 liters of air before he has absorbed the fatal dose of HCN. At 15 liters per minute, this would take just under half an hour. If he has a robust constitution, he may survive even this exposure time. If, however, one postulates a sensitive person of only 50 kg body weight (approximately 110 lbs.), whose respiration rate has increased to 40 liters per minute due to hard work or excitement, then the fatal 208 liters of air will have been breathed in by this person within 5 minutes. These mathematical examples show that safety guidelines are always set in such a way as to protect even the smaller and weaker persons from harm under a kind of worst case scenario. Also, the specifications given in the literature, “*immediately*” and “*rapidly fatal*”, are so indefinite as to be unsatisfactory.

The limiting values look very different when the requirement is that even the most robust among the hypothetical victims must *be dead* after a few minutes.<sup>86</sup> Naturally the concentration required for this greatly exceeds the values cited in Table 2. It could be determined accurately only by mass

---

<sup>82</sup> More specifically: the cyanide. To avoid confusing the reader with specialized terminology we shall use the term ‘hydrogen cyanide’ wherever possible in the following, and ask the experts to kindly pardon the generalization.

<sup>83</sup> W. Wirth, C. Gloxhuber, *Toxikologie*, Georg Thieme Verlag, Stuttgart 1985, pp. 159f.; W. Forth, D. Henschler, W. Rummel, *Allgemeine und spezielle Pharmakologie und Toxikologie*, Wissenschaftsverlag, 5<sup>th</sup> ed., Mannheim 1987, pp. 751f.; S. Moeschlin, *Klinik und Therapie der Vergiftung*, Georg Thieme Verlag, Stuttgart 1986, p. 300; H.-H. Wellhöner, *Allgemeine und systematische Pharmakologie und Toxikologie*, Springer Verlag, Berlin 1988, pp. 445f.

<sup>84</sup> F. Flury, F. Zernik, *Schädliche Gase, Dämpfe, Nebel, Rauch- und Staubarten*, Springer, Berlin 1931, p. 405.

<sup>85</sup> Robert F. Schmidt, *Biommaschine Mensch*, Piper, Munich 1979, p. 124.

<sup>86</sup> Comparable to what is known among toxicologists as the lethal dose for 100% of the victims, LD<sub>100</sub>. In fact, it would even be more than that, since the LD<sub>100</sub> value determines the amount necessary to be lethal in general, i.e. regardless of how long it takes for the victim to actually die, whereas in our case the dose required must actually lead to death in just a few minutes, as we will see.

**Table 2: Rapidly Fatal Concentrations of Hydrogen cyanide in Air<sup>89</sup>**

Source	Concentration	Effect
DuPont, <i>Hydrogen Cyanide</i> <sup>90</sup>	0.03%/vol.	rapidly fatal
F. Flury, F. Zernik, <i>Schädliche Gase</i> <sup>91</sup>	0.02%/vol.	fatal after 5-10 mins. inhalation
	0.027%/vol.	immediately fatal

screening, which of course is not an option. The only data available here are those that have been collected in the course of executions with HCN that have been performed in the United States. A review of the conditions, based on several publications in the USA about that subject concluded that it takes at least 10 minutes to kill a victim, if it is immediately subjected to the full concentration of around 0.5 %/vol.<sup>87</sup> In other words, concentrations more than ten times greater than that cited as “*immediately fatal*” in Table 2 are necessary to *safely* kill *all* executees in the United States. From cases of accidental poisoning we also know that even victims who were exposed to great overdoses die only after a surprisingly long period of unconsciousness and subsequent respiratory arrest.<sup>88</sup>

### 3.2. The Fumigant Zyklon B

Insects and especially their eggs are considerably less sensitive to HCN. For the most part it is necessary to expose them for several hours to rather high concentrations (0.3 to 2%/vol.) before their death is certain. Right until the end of World War Two, *Zyklon B*, a substance produced and licensed by the company DEGESCH of Frankfurt/Main, was of paramount importance in combating insects and rodents in food storerooms, large-capacity transports (trains, ships), public buildings, barracks, prisoner-of-war camps, concentration camps, and of course for hygiene and for disease control in general in many countries around the world.<sup>92</sup> The *Zyklon B* allegedly used for gassing

<sup>87</sup> Conrad Grieb, “*Der selbstassistierte Holocaust-Schwindel*”, *VffG* 1(1) (1997), pp. 6-8 (online: [vho.org/VffG/1997/1/Grieb1.html](http://vho.org/VffG/1997/1/Grieb1.html); English: “*The Self-assisted Holocaust Hoax*”, [codoh.com/gcgv/gcgvself.html](http://codoh.com/gcgv/gcgvself.html)).

<sup>88</sup> M. Dauderer, *op. cit.* (note 89), p. 15.

<sup>89</sup> Cf. also M. Dauderer, *Klinische Toxikologie*, 30th supplement, 10/87, ecomed, Landsberg 1987, pp. 4ff.

<sup>90</sup> DuPont, *Hydrogen Cyanide*, Wilmington, Delaware 7/83, pp. 5f.

<sup>91</sup> F. Flury, F. Zernik, *op. cit.* (note 84), pp. 453f.

<sup>92</sup> For a comprehensive history of *Zyklon B*, including mass gassing claims, but hardly offering more physical data of the product, cf. Jürgen Kalthoff, Martin Werner, *Die Händler des Zyklon B*, VSA-Verlag, Hamburg 1998; aside from Peters *et al.*, *op. cit.* (note 78), and F. Puntigam *et al.*, *op. cit.* (note 33), pp. 35ff.; cf. also O. Hecht, “*Blausäuredurchgasungen zur Schädlingsbekämpfung*”, *Die Naturwissenschaften* 16(2) (1928), pp. 17-23; G. Peters, *Blausäure zur Schädlingsbekämpfung*, Ferdinand Enke Verlag, Stuttgart 1933; G. Peters, W. Ganter, “*Zur Frage der Abtötung des Kornkäfers mit Blausäure*”, *Zeitschrift für angewandte Entomologie* 21(4) (1935), pp. 547-559; F. E. Haag, *Lagerhygiene, Taschenbuch des Truppenarztes*, v. VI, F. Lehmanns Verlag, Munich 1943; W. Dötzer, “*Entkeimung, Entwesung und Entseuchung*”, in J. Mrugowsky (ed.), *Arbeitsanweisungen für Klinik und Laboratorium des Hygiene-Instituts der Waffen-SS*, issue 3, Urban & Schwarzenberg, Berlin 1944; F. Puntigam, “*Die Durchgangslager der Arbeitseinsatzverwaltung als Einrichtungen der Gesundheitsvorsorge*”, *Gesundheitsingenieur* 67(2) (1944), pp. 47-56; O. von Schjerning, *Handbuch der ärztlichen Erfahrungen im Weltkrieg 1914/1918*, v. VII, *Hygiene*, J. A. Barth, Leipzig 1922, esp. pp. 266ff: “*Sanierungsanstalten an der Reichsgrenze*”; R. Wohrlab, “*Flecktyphusbekämpfung im Generalgouvernement*”, *Münchener Medizinische Wochenschrift* 89(22) (1942), pp. 483-488; W. Hagen, “*Krieg, Hunger und Pestilenz in Warsaw 1939-1943*”, *Gesundheitswesen und Desinfektion* 65(8) (1973), pp. 115-127; *ibid.*, 65(9) (1973), pp. 129-143; G. Peters, *Die hochwirksamen Gase und Dämpfe in der Schädlingsbekämpfung*, F. Enke Verlag, Stuttgart 1942; DEGESCH, *Acht Vorträge aus dem Arbeitsgebiet der DEGESCH*, 1942, p. 47; Document NI-9098, Nuremberg Trial, a table of properties of the gaseous insecticides / biocides used by the DEGESCH; H. Kruse, *Leitfaden für die Ausbildung in der Desinfektion und Schädlingsbekämpfung*, 4<sup>th</sup> ed., Muster-Schmidt, Göttingen 1948; H. Kliewe, *Leitfaden der Entseuchung und Entwesung*, F. Enke Verlag, Stuttgart 1951; more recent discussions of the topic: F. P. Berg, “*Zyklon B and the German Delousing Chambers*”, *JHR* 7(1) (1986), pp. 73-94 (online: [codoh.com/gcgv/gcgvtyph.html](http://codoh.com/gcgv/gcgvtyph.html)); F. P. Berg, “*Typhus and the Jews*”, *JHR* 8(4) (1988), pp.



human beings consisted of lumps of gypsum mixed with starch  $\frac{1}{4}$ " to  $\frac{1}{2}$ " in diameter and soaked with hydrogen cyanide.<sup>93</sup> The evaporation of the poison gas from its carrier proceeds rather slowly. The characteristics of HCN evaporating from the carrier substance were documented in 1942 by an employee of DEGESCH.<sup>94</sup> On dry air of 15°C (59°F), HCN evaporated from the carrier as indicated in Graph 1, *i.e.*, it took 1.5 to 2 hours until 90% of the HCN had been released.

At lower temperatures this process slows down at a rate proportional to the decreasing vapor pressure of the HCN. It is worth noting that according to Irmischer the evaporation rate decreases remarkably if the surrounding air has a high relative humidity, as it must be expected in unheated underground rooms, filled with many human beings. The reason for this is that the Zyklon B carrier cools down while HCN evaporates. Subsequently water from the surrounding damp air condenses on the carrier. Since HCN is extremely soluble in water, a wet carrier would release the remaining HCN only very slowly.

For future reference, we shall point out the probability that at a temperature of 15°C (59°F), in a highly humid environment, a maximum of not more than 10% of the HCN will be released by the carrier substance during the first five, probably even ten minutes.

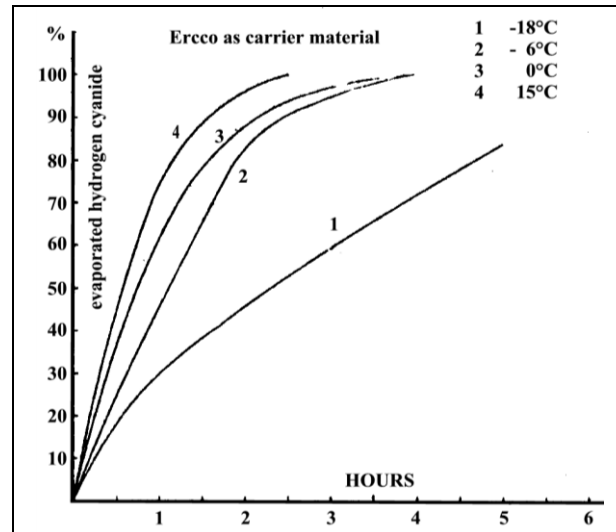

**Graph 1:** Speed of vaporization of HCN from the carrier substance of Zyklon B (gypsum carrier) at various temperatures and finely dispersed, according to R. Irmischer/DEGESCH.<sup>94</sup>

### 3.3. Hydrogen Cyanide Residue

#### 3.3.1. Formation

If the hydrogen cyanide from the Zyklon B had bonded with the brickwork only through the process of adsorption, then due to the volatility of hydrogen cyanide (boiling point: 25.7°C/78.3°F) it would no longer be possible today to detect any hydrogen cyanide residues in the remaining walls. But even a brief glance into the clothing disinfestation chambers of Buildings 5a and 5b of Birkenau (see cover illustrations) immediately shows a chemist that what he is in fact dealing with is a very

433-481 (online: [vho.org/GB/Journals/JHR/8/4/Berg433-481.html](http://vho.org/GB/Journals/JHR/8/4/Berg433-481.html)); R. Clarence Lang, "Zur Frage der Fleckfieberepidemien im Zweiten Weltkrieg", *DGG* 36 (2,3) (1988), pp. 7-10, 8-13.

<sup>93</sup> Appart from Jürgen Kalthoff, Martin Werner, *op. cit.* (note 92), see the illustrations in J.-C. Pressac, *op. cit.* (note 9), p. 17, and F. A. Leuchter, *op. cit.* (note 1), p. 148, each taken from product information issued by DEGESCH (Deutsche Gesellschaft für Schädlingsbekämpfung), as well as A. Moog, W. Kapp, letter from Detia Freyberg GmbH to the author (Laudenbach, Sept. 11, 1991.); for a more recent article about the history and some physical properties of Zyklon B cf. W. Lambrecht, "Zyklon B – eine Ergänzung", *VffG* 1(1) (1997), pp. 2-5 (online: [vho.org/VffG/1997/1/Lambrecht1.html](http://vho.org/VffG/1997/1/Lambrecht1.html)).

<sup>94</sup> R. Irmischer, *Zeitschrift für hygienische Zoologie und Schädlingsbekämpfung*, 34 (1942), p. 36, cf. W. Lambrecht, *op. cit.* (note 93). These data were confirmed by a study conducted by a Soviet commission immediately after the war: *Gosudarstvjennyj Archiv Rossiskoj Federatsii*, Moscow, RF, 7021-107-9, pp. 229-243. Two cans of Zyklon B were opened and their content was exposed for two hours to 23-28°C. After this 94% respectively 90% of the original HCN content was evaporated. I owe this information to C. Mattogno; cf. Mattogno, "Die Gaskammern von Majdanek", *VffG* 2(2) (1998), pp. 118, footnote 5 (online: [vho.org/VffG/1998/2/Mattogno2.html](http://vho.org/VffG/1998/2/Mattogno2.html)).

common substance: iron blue,<sup>95</sup> an extremely stable compound formed by the interaction of hydrogen cyanide with iron (ferrous cyanide<sup>96</sup>).

Iron is an element almost ubiquitous in nature, occurring most commonly as ferric oxide (‘rust’). The sand used for concrete and mortar, for example, contains up to 4% iron, while Portland cement contains between 2 to 5% iron.<sup>97</sup> In general, the iron – in the form of rust – is the reason why building and similar materials (concrete, mortar, plaster, but loam and clay as well) are frequently ochre or red.

So how does the iron blue pigment form? First the hydrogen cyanide must accumulate in the brickwork. A cool and therefore damp wall is conducive to this process, since hydrogen cyanide is most readily soluble in water. Accordingly, cool (10°C/50°F) basement walls with a moisture content some ten times greater<sup>97</sup> than that of warm, dry rooms (20°C/68°F) also have an approximately ten times greater tendency to become enriched with hydrogen cyanide.<sup>98</sup> A damp environment (*i.e.*, wall) is also of prime importance for the further steps involved in the chemical conversion into iron blue. Additionally, an alkaline environment is more suitable to accumulate HCN than an acid one, since under alkaline conditions HCN is rapidly converted into simple (non-complex and not very stable) cyanide salts.<sup>99</sup> The conversion from HCN to cyanide salts is a necessary step for the formation of stable iron-cyanide-complexes, since only the cyanide ion in the salts (CN<sup>-</sup>) is able to react with iron, which includes both a simple linking process (formation of complex salts) and a partial reduction of the oxidation state of Iron from III (as normally found in nature) to II, which is supported by an alkaline medium.<sup>100</sup> In fact, regarding the formation of iron blue apart from humidity and alkalinity all other factors are secondary.<sup>101</sup> The exact influence of each factor is still unknown, though. The German expert literature has occasionally reported a case of developing iron blue after a single Zyklon B fumigation in a building of high dampness and alkaline plasters which caused severe damages, since the only way to get rid of this pigment was to knock off the entire plasterwork.<sup>102</sup> From this case it must be concluded that already a single gassing can suffice if the

<sup>95</sup> Iron blue pigment is the international standard name (ISO 2495) for ferrous cyanide blue pigments of various compositions which are also known as Berlin Blue, Turnbull’s Blue, Prussian Blue, Vossen Blue®, Milori Blue, Parisian Blue, French Blue, China Blue, Bronze Blue, Steel Blue, Ink Blue, etc.

<sup>96</sup> Cyanides (CN<sup>-</sup>-compounds) are hydrogen cyanide (hydrogen cyanide, HCN) salts. In this case, specifically ferro(III)-ferri(II)-cyanide, but one can expect to find all sorts of iron cyanide compounds in mortar of facilities exposed to HCN.

<sup>97</sup> Cf., *e.g.*, K. Wesche, *Baustoffe für tragende Bauteile*, 2 vols., Bauverlag, Wiesbaden 1977, esp. v. 1, p. 37, v. 2, pp. 51f.

<sup>98</sup> L. Schwarz, W. Deckert, *Zeitschrift für Hygiene und Infektionskrankheiten* 107 (1927), pp. 798-813; *ibid.*, 109 (1929), pp. 201-212.

<sup>99</sup> In fact, the strongly alkaline character of freshly plastered walls would have increased the formation process enormously. The influence of the pH-value of the walls is being ignored by Richard J. Green in his later added online-article “*More on Prussian Blue*” on [www.holocaust-history.org/](http://www.holocaust-history.org/).

<sup>100</sup> This point causes some irritation even among chemists since it is obviously not known that cyanide itself is a reducing agent, and, on the other hand, Fe(CN<sub>6</sub>)<sup>3-</sup> is a strong oxidizing agent especially in alkaline medium, cf. M.A. Alich, D.T. Haworth, M.F. Johnson, *J. Inorg. Nucl. Chem.* 29 (1967), pp. 1637-1642; J.C. Bailar, *Comprehensive Inorganic Chemistry*, vol. 3, Pergamon Press, Oxford 1973, p. 1047; R.M. Izatt, G.D. Watt, C.H. Bartholomew, J.J. Christensen, *Inorg. Chem.* 9 (1970) p. 2019ff.; J.F. de Wet, R. Rolle, *Z. Anorg. Allgem. Chem.*, 336 (1965), p. 96; H. M. Powell, *Proc. Chem. Soc.*, (1959), p. 73. I owe the latter two sources to R.J. Green, *The Chemistry...*, *op. cit.* (note 26).

<sup>101</sup> We shall spare the reader a discussion of the minor effects of other properties of the brick on cyanide accumulation and the speed of chemical conversion, and refer instead to Rudolf, *The Rudolf Report*, *op. cit.* (note 27), pp. 151-189.

<sup>102</sup> G. Zimmermann (ed.), *Bauschäden Sammlung*, Band 4, Forum-Verlag, Stuttgart 1981, pp. 120f. (translation in Appendix 1 at the end of this volume); E. Emmerling, in M. Petzet (ed.), *Holzschädlingsbekämpfung durch Begasung*, Arbeitshefte des Bayerischen Landesamtes für Denkmalpflege, Bd. 75, Lipp-Verlag, Munich 1995, p. 43-56, mentions another case, but it is not clear if it is just referring to the same case.

walls of the premise are wet, porous and alkaline. But the formation of iron blue compounds in a room of a building in concentration camp Majdanek, which was converted to a Zyklon B delousing chamber after having been used for other purposes for quite a while, shows, that even old, non-alkaline plaster is able to form huge amounts of iron blue.<sup>103</sup>

### 3.3.2. Stability

The relevant literature consistently describes iron blue as an extremely stable pigment. It is insoluble in water,<sup>104</sup> resistant to acid rain<sup>105</sup> and also surprisingly resistant to sunlight.<sup>106</sup> When exposed to weathering, other compounds of hydrogen cyanide will even convert preferentially into iron blue.

Three examples will demonstrate the environmentally resistant nature of iron blue. First, the outside walls of the Birkenau delousing building, which are stained blue by iron blue, have lost none of their color despite 50 years of exposure to the adverse environmental conditions of the industrial region of Upper Silesia (see cover illustrations). One might now object that the soluble compounds of hydrogen cyanide in the interior of the walls gradually migrate to the surface, thereby making up for any loss caused by surface erosion and thus only ‘simulating’ long-term stability. However, a long-term test begun in the 1950s to ascertain the environmental resistance of paints has clarified this matter. In this test, many pigments including iron blue and iron oxide (*i.e.*, rust) were tested by applying them only superficially and without protective coating onto a piece of aluminum. After more than 20 years’ exposure to the air of a western industrial suburb of London, two pigments exhibited the least (barely noticeable) changes: iron blue and iron oxide.<sup>107</sup> Even scattered on the ground, iron blue remains stable and fixed for decades, as tests in gas works shut down decades ago have shown. In this case the iron blue obtained in the city’s gas works was used as a herbicide, and is still present today in virtually undiminished quantities.<sup>108</sup> Therefore, if iron blue has formed on and *in* a wall, one may expect to find a long-term stability similar to that of the iron oxide from which it formed.

Thus, once noticeable quantities of hydrogen cyanide salts have accumulated in brickwork, and once damp conditions have allowed these to convert into iron blue, then no appreciable reduction in hydrogen cyanide content is to be expected after 50 years.

A typical example of the way the media deal with these facts is the report that was issued by the German press agency *dpa* and carried on March 29, 1993, in almost all major German daily newspapers and even in some radio news broadcasts, in which it was claimed that, according to unnamed expert, the hydrogen cyanide salts at issue here have a life of only a few months.<sup>109</sup> Inquiries at the Stuttgart *dpa* office responsible for this press release revealed that the editor in charge, Albert

---

<sup>103</sup> Cf. J. Graf, C. Mattogno, *op. cit.* (note 30), pp. 149-152. See C. Mattogno’s contribution about the concentrations camp Majdanek in this volume.

<sup>104</sup> The literature frequently gives only the rather unsatisfactory term ‘insoluble’. For more details see the *The Rudolf Report*, *op. cit.* (note 27), pp. 171-175.

<sup>105</sup> Iron blue is considered an acid-resistant pigment; cf., *e.g.*, B. J. A. Sistino, in T. C. Patton (ed.), *Pigment Handbook*, v. 1, Wiley, New York 1973, pp. 401-407; no appreciable decomposition occurs until the pH drops below 1. The pH of iron blue suspensions, for ex., is around 4-5; H. Ferch, H. Schäfer, *Schriftenreihe Pigmente*, 77, Degussa AG, Frankfurt 1990.

<sup>106</sup> *Ullmanns Encyklopädie der technischen Chemie*, v. 13, Urban & Schwarzenberg, Munich 1962, p. 794; *ibid.*, v. 18, Verlag Chemie, Weinheim 1979, pp. 623ff.; L. Müller-Focken, *Farbe und Lack* 84 (1987), pp. 489-492.

<sup>107</sup> J. M. Kape, E. C. Mills, *Transactions of the Institute of Metal Finishing* 35 (1958), pp. 353-384; *ibid.*, 59 (1981), pp. 35-39.

<sup>108</sup> D. Maier, K. Czurda, G. Gudehus, *Das Gas- und Wasserfach, Gas · Erdgas* 130 (1989), pp. 474-484.

<sup>109</sup> Cf. *Süddeutsche Zeitung*, *Die Welt*, *Stuttgarter Zeitung*, and *Südwest Presse*, all of March 29, 1994. This fabricated press release was since quoted frequently by several German officials, especially in German Landes- and Bundesverfassungsschutzberichten (Report of State and Federal Agencies for the Protection of the Constitution).

Meinecke, had invented this 'expert opinion' out of thin air. Evidently even the *dpa* press agency does not shy back from issuing false reports.<sup>110</sup>

## 4. Fumigation

### 4.1. Disinfestation of Material Objects<sup>92</sup>

Initially, ordinary rooms were turned into disinfestation facilities for material objects by means of makeshift alterations intended to render the windows and doors as gas-proof as possible and to provide adequate heating and ventilation systems for the rooms. Workers wearing protective masks distributed the Zyklon B evenly on the floor of the room, which had been previously stocked with the items to be fumigated. This procedure was similar to that used at the time for the fumigation of ordinary rooms for purposes of disinfestation.

Later, special facilities were constructed, and outfitted with heating, ventilation and air turnover (circulation system) facilities. These facilities had a relatively small volume to avoid any dead space, *i.e.*, to conserve the rather costly insecticide.

Depending on the facilities and on the kind of vermin to be exterminated, the concentrations of hydrogen cyanide varied from 0.5 to 2%/vol., while the duration of use ranged from less than 2 hours to 10 hours and more.

The delousing chambers of Buildings 5a and 5b in Birkenau had been constructed especially for delousing purposes (with ventilation facilities, heating, aeration chimneys), but their size made them very expensive to operate. They had an area of approximately 130 m<sup>2</sup> and a volume of at least 400 m<sup>3</sup>. Using the entire room as delousing chamber would require quantities of Zyklon B containing at least 4 to 5 kg (10g/m<sup>3</sup>) hydrogen cyanide.<sup>111</sup> Assuming one fumigation cycle per day, these facilities alone used up 3.6 tons of Zyklon B a year, which corresponds to almost 50% of the entire quantity of Zyklon B delivered to Auschwitz in 1942, where the total amount delivered was 7.5 tons.<sup>112</sup>

If one considers that Birkenau also had other hydrogen cyanide delousing facilities of various size<sup>113</sup> and that inmates' barracks were also fumigated with this insecticide on occasion,<sup>114</sup> then it becomes apparent that the quantities of Zyklon B supplied to Auschwitz can be explained by the normal disinfestation operations, which is in fact generally accepted. Pressac, for example, suggests that 95 to 98% of all the Zyklon B supplied to the camp was used for its original purpose, namely to delouse clothing and facilities,<sup>115</sup> and he cites findings of the Nuremberg Tribunal in support of this.<sup>116</sup> And in fact, relative to the numbers of people in the Auschwitz camp, the quantities of Zyklon B supplied to this camp did not exceed the quantities supplied to other concentration camps where it is known that no exterminations took place. Clearly, the annual quantity supplied to

<sup>110</sup> Cf. W. Schlesiger, *Der Fall Rudolf*, Cromwell, 20 Madeira Place, Brighton/Sussex BN2 1TN, England, 1994, pp. 21-24 (online: [vho.org/D/dfr/Fall.html](http://vho.org/D/dfr/Fall.html)); G. Rudolf, *DGG* 42(2) (1994), pp. 25f. (online: [vho.org/D/DGG/Rudolf42\\_2.html](http://vho.org/D/DGG/Rudolf42_2.html)).

<sup>111</sup> The mass declarations on Zyklon B tins always referred to the net HCN content, which was about 30-40% of the entire mass of the content, *i.e.*, 60-70% of the mass were due to the carrier.

<sup>112</sup> Office of Chief of Counsel for War Crimes, affidavit of A. Zaun, Hamburg, Oct. 24, 1945, Document No. NI-11,396, quoted according to U. Walendy, *Auschwitz im IG-Farben-Prozeß*, Verlag für Volkstum und Zeitgeschichtsforschung, Vlotho 1981, p. 62.

<sup>113</sup> According to J.-C. Pressac, *op. cit.* (note 9), p. 550, there were a total of 25 chambers in the camp in which material objects were deloused with Zyklon B, but no doubt not already in 1942.

<sup>114</sup> The documentary and witness accounts of such fumigations are numerous, *e.g.*, the order issued on Aug. 12, 1942, by Camp Commandant Höß regarding accidents during the fumigation of barracks; J.-C. Pressac, *ibid.*, p. 201.

<sup>115</sup> *Ibid.*, pp. 15, 188.

<sup>116</sup> Office of Chief of Counsel for War Crimes, British Military Court, trial of B. Tesch et al., Hamburg, March 1-8, 1946, Document No. NI-12,207, quoted according to U. Walendy, *op. cit.* (note 112), p. 83.

Auschwitz was not even enough, since the spotted fever epidemics could never be entirely prevented. These considerations show that the disinfestation chambers of Buildings 5a and 5b could not have been used more than once a day.

## 4.2. The Gassing of Human Beings

### 4.2.1. Eyewitness Testimony

Where the trustworthiness and credibility of eyewitness testimony are concerned, Pressac himself judges them at times quite harshly.<sup>117</sup> He attempts to explain the untruths, impossibilities and exaggerations, and in many cases he corrects them. For example, Pressac estimates the numbers of victims per gassing as considerably less than do the eyewitnesses, who frequently tell of several thousand victims per cycle.<sup>118</sup> Since the number of victims in Auschwitz has been officially reduced from 4 million to approximately 1 million<sup>119</sup> since spring 1990, Pressac, drawing primarily on a work by D. Czech,<sup>120</sup> has manipulated the claims of the witnesses to reflect these new figures. The following describes the procedures of the alleged homicidal gasings for the individual facilities, as Pressac believes he can reconstruct them following his correction of the eyewitness testimony [my comments in brackets]:

#### *Crematorium I:*

500 to 700 victims undress out of doors; the ‘gas chamber’ (mortuary) is entered via the furnace room [passing heaps of corpses from the last batch which are awaiting their cremation. This scenario appears to be unbelievable, since it requires that the victims passing these heaps would have stayed calm.]; Zyklon B is introduced through [non existent] input shafts; after the victims have died (some 5 minutes later [which is impossible]) the ventilators are turned on; after 15 to 20 minutes of ventilation, the door to the furnace room is opened, the chamber is cleared – sometimes without the use of gas masks on the part of the workers [which would have been very dangerous, if not fatal] – and the victims are cremated.<sup>121</sup> According to Pressac only a few gasings took place here, with a total of less than 10,000 victims.<sup>122</sup>

#### *Crematoria II & III:*

800 to 1,200 victims undress in mortuary 2; they enter mortuary 1 (the ‘gas chamber’); Zyklon B is introduced via [non existent] input shafts; after the victims have died (5 minutes [which is impossible]) the ventilators are turned on; after approximately 20 minutes the doors are opened; the bodies, covered with blood, vomit and feces, are hosed off; the bodies are removed, usually without the use of gas masks on the part of the workers [which again would have been very dangerous, if not fatal]; cremation takes place on the ground floor.<sup>123</sup> According to Pressac the total number of victims

---

<sup>117</sup> J.-C. Pressac, *op. cit.* (note 9), pp. 124f., 162, 174, 177, 181, 229, 239, 379f., 459-502; more succinctly in J.-C. Pressac, *op. cit.* (note 21); cf. the critiques by H. Verbeke, *op. cit.* (note 22) and A.N.E.C., *op. cit.* (note 22).

<sup>118</sup> 2,000 according to C. S. Bendel, 3,000 according to M. Nyiszli, cf. J.-C. Pressac, *op. cit.* (note 9), pp. 469ff.

<sup>119</sup> Cf., e.g., *Jüdische Allgemeine Wochenzeitung*, July 26, 1990; *Hamburger Abendblatt*, July 25, 1990; *Hannoversche Allgemeine Zeitung*, July 18, 1990; *Der Spiegel* 30/91, p. 111; *Süddeutsche Zeitung*, Sept. 21, 1990; *Die Tageszeitung*, July 18 and 19, 1990; *Vorarlberger Nachrichten*, Aug. 22 and 29, 1990.

<sup>120</sup> D. Czech, *Auschwitz Chronicle, 1939-1945*, Henry Holt, New York 1989.

<sup>121</sup> J.-C. Pressac, *op. cit.* (note 9), p. 125.

<sup>122</sup> *Ibid.*, pp. 131f.; J.-C. Pressac, *op. cit.* (note 18), pp. 34f.

<sup>123</sup> J.-C. Pressac, *op. cit.* (note 9), p. 253.

for crematorium II was some 400,000 (one gassing per day on average), 350,000 for crematorium III.<sup>124</sup>

#### *Crematoria IV & V:*

Several hundred victims undress out of doors when the weather permitted, otherwise in the mortuary; victims walk to the ‘gas chamber’ [passing heaps of corpses from the last batch which are awaiting their cremation...]. Zyklon B is thrown in through input hatches, from a ladder; after 15 to 20 minutes the doors are opened; bodies are removed to the mortuary or outside to the burning pits behind crematorium V, while the workers sometimes do and sometimes do not wear gas masks [which would be fatal, since no ventilation system reduces the HCN concentration]. According to Pressac, the number of victims is difficult to estimate, presumably approximately 100,000 each.<sup>125</sup> The same goes for Bunkers I and II.

Pressac repeatedly mentions concentrations of 12g hydrogen cyanide per m<sup>3</sup>, or 1% by volume. To support this claim he cites many eyewitness accounts which allege that four to six 1-kg-tins<sup>111</sup> of Zyklon B were emptied into the ‘gas chambers’ (mortuaries) of crematoria II and III, which indeed corresponds to a concentration of 1% by volume.<sup>126</sup>

Another indirect and surely the most conclusive source to determine the quantities of hydrogen cyanide used are the gassing times attested to by the witnesses. These times are consistently a matter of minutes,<sup>127</sup> and it is no doubt justified to wonder how the witnesses could possibly know this, since according to the conventional accounts the ‘gas chamber’ doors had at most one peephole, which SS physicians allegedly availed themselves of to supervise the proceedings.<sup>128</sup> Such witnesses would thus be the only ones not reporting from hearsay. In his 1992 report Professor G. Jagschitz

<sup>124</sup> *Ibid.*, p. 183. Since in his latest work he assumes some 500,000 victims of the gas chambers (*op. cit.*, note 21, German ed. p. 202), the corresponding figures for the individual facilities ought to be reduced further, and following F. Meyer, “*Die Zahl der Opfer von Auschwitz*”, *Osteuropa*, 52(5) (2002), pp. 631-641, even more.

<sup>125</sup> J.-C. Pressac, *op. cit.* (note 9), pp. 384-390.

<sup>126</sup> *Ibid.*, pp. 16, 18, 253; J.-C. Pressac, *op. cit.* (note 21), p. 71; cf. also J. Buszko (ed.), *Auschwitz, Nazi Extermination Camp*, Interpress Pub., Warsaw 1985, p. 118, who mentions 6 to 12 kg.

<sup>127</sup> Regarding witness statements on this point cf. Schwurgericht Hagen, verdict from Jul. 24, 1970, Ref. 11 Ks 1/70, p. 97 (5 mins.); Final Trial Brief of the Prosecution, acc. To U. Walendy, *op. cit.* (note 112), pp. 47-50 (3 up to maximally 15 mins.); E. Kogon, H. Langbein, A. Rückerl *et al.* (ed.), *Nationalsozialistische Massentötungen durch Giftgas*, S. Fischer Verlag, Frankfurt 1983, passim. (immediately to 10 mins., more rarely to 20 mins.); J. Buszko (ed.), *Auschwitz, Nazi Extermination Camp*, Interpress Publishers, Warsaw, 2<sup>nd</sup> ed. 1985, in cooperation with State Museum of Auschwitz, pp. 114 + 118 (a few mins.); H.G. Adler, H. Langbein, E. Lingens-Reiner (ed.), *Auschwitz*, Europäische Verlagsanstalt, Cologne, 3<sup>rd</sup> ed. 1984, pp. 66, 80 + 200 (a few to 10 mins.); Hamburger Institut für Sozialforschung (ed.), *Die Auschwitz-Hefte*, v. 1, Beltz Verlag, Weinheim 1987, pp. 261ff. +294 (immediately to 10 mins.); C. Vaillant-Couturier, *Trial of the Major War Criminals (IMT)*, v. VI, p. 216 (5-7 mins.); M. Nyszli, in G. Schoenberner (ed.), *Wir haben es gesehen*, Fourier, Wiesbaden 1981, p. 250 (5 mins.); C. S. Bendel in H. Langbein, *Menschen in Auschwitz*, Europaverlag, Vienna 1987, p. 221 (victims stopped screaming after 2 mins.); P. Broad in B. Naumann, *op. cit.* (note 40), p. 217 (4 mins.); doors being opened after 10-15 mins.: A. Rückerl, *NS-Verbrechen vor Gericht*, C. F. Müller, Heidelberg 1984, pp. 58f.; K. Höltinger in H. Langbein, *Der Auschwitz-Prozeß*, Europäische Verlagsanstalt, Frankfurt/Main 1965, p. 73 (1 min.); R. Böck, *ibid.*, p. 74 (victims screamed for 10 mins. after door was closed, door was then opened); H. Stark, *ibid.*, p. 439 (victims screamed for 10-15 mins.); F. Müller, *ibid.*, p. 463 (8-10 mins.); E. Pyš, *ibid.*, p. 748 (ventilator was turned on after a few mins.); K. Lill, *ibid.*, p. 750 (a few seconds after Zyklon B was thrown in there was a scream, a few minutes later smoke billowed from the chimney); H. Aumeier, *op. cit.* (note 40, 1/2 to 1 min.).

<sup>128</sup> Regarding this G. Rudolf, “*Auschwitz-Kronzeuge Dr. Hans Münch im Gespräch*”, *VffG*, 3(1) (1997), pp. 139-190 (online: [vho.org/VffG/1997/3/RudMue3.html](http://vho.org/VffG/1997/3/RudMue3.html)); Münch is claiming that it took 3 minutes in summertime and 5 in wintertime to kill all victims, pp. 154, 162f, 165.

quotes one such ‘qualified’ witness.<sup>129</sup> The Auschwitz camp physician he quotes – Dr. Horst Fischer, who claims to have frequently supervised ‘gas chamber’ executions himself – reports of gassing times of two to three minutes, which agrees with the claims of the vast majority of all other witnesses, including the SS man Hans Münch in an interview conducted by this author.<sup>128</sup> The former Camp Commandant R. Höß also spoke of 3 to, in exceptional cases, 15 minutes.<sup>130</sup> Such a relatively quick execution would require the use of correspondingly large quantities of Zyklon B. The approximate quantity shall be determined in the following.

#### 4.2.2. Criticism of Eyewitness Testimony

We shall not deal with thorough criticism of eyewitness testimonies here, which has been done already elsewhere,<sup>131</sup> but will focus on only two physical problems, and we shall ignore the fact that there were no Zyklon B input hatches in the roofs of the crematoria I-III (which is a bit grotesque, but otherwise one would have to stop any further analysis). In order to assess the degree to which official eyewitness testimony and other accounts of the alleged gassing procedures approximate reality, one must consider the following factors:

1. Is the gassing procedure attested to physically possible, and if so, under what conditions?
2. What time would have been required to ventilate the facilities crowded with bodies? or: were the clean-up operations attested to in the chambers possible?<sup>132</sup>

##### 4.2.2.1. Poisoning or Suffocation?

If one assumes an execution time roughly commensurate to that in American gas chambers (10 minutes, with approximately 0.3% hydrogen cyanide per m<sup>3</sup>), then the concentration of 0.3% by volume (3.6 g/m<sup>3</sup>) must have prevailed in even the hindmost corner of the ‘gas chamber’ by the end of the execution process at the latest, *i.e.*, after 10 minutes. Given a free air volume of 430 m<sup>3</sup> in the mortuaries 1 of crematoria II and III,<sup>133</sup> this corresponds to approximately 1.5 kg of evenly distributed hydrogen cyanide (3.3 lbs). Since after 5 to 10 minutes the carrier substance has released only 10% of its hydrogen cyanide, then an execution that takes only a few minutes would require the use of 10 times this quantity, *i.e.*, at least 15 kg Zyklon B (33 lbs). Of course this would work only on the condition that the hydrogen cyanide that is released would reach the victims right away, which one cannot expect in large and overcrowded rooms. We note, therefore that for the gassing procedures attested to, at least 20 kg of Zyklon B would have had to be used per gassing (44 lbs). The quantities actually attested to by witnesses – 5 to 12 kg (11 – 26 lbs) – thus correspond at best to the absolute minimum required.

On the basis of detailed calculations, it was demonstrated that the victims could not possibly have breathed the available air volume of the chamber (400 m<sup>3</sup>) more than once within the 5 to 10 minutes for which the people locked into the ‘gas chamber’ allegedly still lived following the intro-

---

<sup>129</sup> Transcript of the report by Prof. Dr. G. Jagschitz, days 3-5 of the trial of Honsik, April 29, April 30, May 4, 1992, Ref. 20e Vr 14184 and Hv 5720/90, District Court Vienna; regarding the credibility of this testimony, cf. the chapter by W. Rademacher, this volume.

<sup>130</sup> Document 3868-PS, *IMT v. XXXIII* pp. 277ff., quoted according to L. Rosenthal, “*Endlösung der Judenfrage*”, *Massenmord oder “Gaskammerlüge”?*, Verlag Darmstädter Blätter, Darmstadt 1979; in his later testimony in Krakow he wrote about up to 20, but normally 5 to 10 mins, cf. J. Graf, *op. cit.* (note 48), pp. 61-82, here p. 72.

<sup>131</sup> Aside from the many fundamental studies of other authors in the present volume (cf. esp. note 17 of M. Köhler’s contribution), cf. especially J. Graf, *op. cit.* (note 48).

<sup>132</sup> The following calculations base on probable assumption and should be considered as extrapolations only, but this suffice to get an idea about some physical prerequisites to make the attested scenarios at least nearly possible.

<sup>133</sup> 504 m<sup>3</sup> of the morgue minus 1,000 × 0.075 m<sup>3</sup> (vol. of victims).

duction of the poison gas.<sup>134</sup> This shows that the respiration of the victims could not have reduced the poison gas content of the air significantly below 50% of its hypothetical maximum initial concentration. But since the Zyklon B still contains 90% of its original content after the first 5 to 10 minutes following its distribution, *i.e.*, after the death of the victims, the poison gas content of the air will continue to rise. This shows that under the conditions attested to by the witnesses, the victims could have breathed in (i.e. filtered away) only a small fraction of the poison used.

The theory occasionally advanced, that the victims had absorbed all of the poison gas,<sup>135</sup> would require that only very small quantities of poison gas were used, so that the people could have acted as living filters for the entire duration of evaporation, *i.e.*, the time for which the Zyklon B released the poison (at least 2 hours). This means that the doses of poison were too small to kill them, *i.e.*, the concentrations were below 0.01% by volume – meaning that less than 500 g of Zyklon B was used.

However, it can be shown that the victims in the airtight chamber would probably have suffocated after only one hour and without any poison gas,<sup>134</sup> so that even under these conditions the victims’ complete absorption of the hydrogen cyanide would have failed due to the slow rate of evaporation of hydrogen cyanide from the Zyklon B carrier material. Thus, this theory not only contradicts the eyewitness statements with respect to quantities of Zyklon B and speed of execution, but is also technically utterly nonsensical, since if the victims had been killed by suffocation there would have been no need to expend the costly Zyklon B, which was in short enough supply even without being wasted.

#### 4.2.2.2. Speed of Ventilation of the ‘Gas Chambers’

The following shall help explain a somewhat complex mathematical concept. Imagine, if you will, that someone is given a bucket containing 100 blue balls. Each time he reaches into the bucket, he puts in one red ball, briefly mixes the contents and, without looking, takes out one randomly selected ball. How often will he have to do this until only 50 blue balls are left in the bucket and all the others are red? Clue: assuming that he has already replaced half of all the blue balls with red ones, what is the chance that in blindly taking out another ball he will take out a red one instead of a blue one, thus defeating his purpose, *i.e.*, the intended exchange? This is the sort of problem that arises in ventilating a room, when stale and fresh air mix. It means that it takes considerably longer to successfully ventilate a room than is generally assumed. In the case described above, it takes an average of 70 exchanges before half the blue balls have been replaced by red ones.<sup>136</sup>

Calculations have shown that the ventilation facilities in the alleged ‘gas chambers’ of crematoria II and III in Birkenau – facilities designed only for ventilation of ordinary mortuaries – could have performed at most 6 to 8 air exchanges per hour.<sup>137</sup> Due to the poor system configuration (inlet right above outlet) and the alleged overcrowding of the room with bodies, half an hour would never have sufficed to achieve harmless levels of hydrogen cyanide following a gassing, even if there had been

<sup>134</sup> G. Rudolf, *The Rudolf Report*, *op. cit.* (note 27), pp. 211-216.

<sup>135</sup> J. Bailer, *op. cit.* (note 15); G. Wellers, *op. cit.* (note 16), as well as H. G. von Schnering, personal communication.

<sup>136</sup> An accurate mathematical approach is given in G. Rudolf, *The Rudolf Report*, *op. cit.* (note 27), pp. 220-223.

<sup>137</sup> According to the documents, mortuaries 1 of crematoria II and III (approx. 480 m<sup>3</sup>, or 16,950 cu.ft.) had a ventilator for 4,800 m<sup>3</sup> (169,500 cu.ft.) of air per hour at 40 cm water-column. According to W. Zwerenz (unpub., Landshut 1991) and identical findings by W. Lüftl (Vienna, 1992), the difference in pressure that was to be overcome was considerably greater than 40 cm water-column. J.-C. Pressac, *op. cit.* (note 21), p. 38, claims that a much more powerful ventilator with a capacity of 8,000 m<sup>3</sup>/h (282,500 cu.ft./h) had been installed. However, according to C. Matogno, in H. Verbeke, *op. cit.* (note 22), pp. 134, 136, there is no evidence to support this claim, since Pressac’s source also cites the old capacity of 4,800 m<sup>3</sup>/h.



no Zyklon B still releasing gas for hours on end. The eyewitness testimony claiming adequate ventilation after 20 to 30 minutes in mortuaries 1 of crematoria II and III are thus not credible.<sup>138</sup>

This pertains all the more for crematoria IV and V as well as for the sinister Farm Houses (Bunkers) which could have been aired out only via one or two doors. Since they are said to have been equally crammed full of bodies, with the Zyklon B scattered among them, the ventilation time would have been at least one day, the same as was required for ordinary room disinfestations.<sup>139</sup> What is more, ordinary rooms would allow for the removal of the Zyklon B, and generally have windows to facilitate ventilation and are not packed with bodies. Eyewitness testimony telling of work performed without the benefit of gas masks in these ‘gas chambers’ immediately or shortly after the gassing is thus utterly unbelievable. And even if the workers had worn gas masks – carrying the corpses would have been hard work (causing perspiration! cf. Section 3.1.), and in these rooms high in hydrogen cyanide any such work would have been extremely risky due to the potential for poisoning via the skin.

#### 4.2.3. Evaluation of Eyewitness Testimony

Again we will ignore the problem of the Zyklon B input hatches, which demonstrably were not present in the ceilings of mortuaries 1 of crematoria II and III, and we will pretend that they were in fact there.

Under the given technical conditions, the executions with Zyklon B as recounted by the witnesses would not under any circumstances have been possible as rapidly as some allege (‘a few moments’, ‘immediately’), and ‘within a few minutes’ only if horrendous quantities of Zyklon B had been used – which would have been nonsensical (too costly), dangerous and awkward at once. As well, the walls of the chambers would have been exposed to high concentrations of hydrogen cyanide for long periods of time. Mass executions with HCN in huge rooms would have required the application of gaseous HCN, blown in and evenly distributed by fans, or pure liquid HCN, evaporated and distributed by a mixed heating and ventilation device.<sup>140</sup>

The alleged entering of the ‘gas chambers’ without safety measures, the hard work performed in them – sometimes done bare-chested and while eating and smoking – and the simultaneous claim that great quantities of poison gas were used, combine to prove these witnesses guilty of making false statements.

No less false are the times alleged for the ventilation of mortuaries 1 (the ‘gas chambers’) of crematoria II and III, since the witnesses proceeded on the mistaken assumption that a single air exchange would remove all the poison gas. The delay in the reduction of the remaining concentration of hydrogen cyanide means that in a realistic scenario the required ventilation time would exceed that recounted by the witnesses by a factor of 10 or more (diminished circulation due to the bodies, ‘short-circuit’ of air, aftergeneration of gas from the Zyklon B). As well, the problem of continued aftergeneration of gas from the remaining Zyklon B, which would have made it impossible to work within the chambers without protective clothing in anything less than 2 hours even with ongoing ventilation, also prove that the witnesses have not told the truth.

---

<sup>138</sup> A detailed discussion and calculations about the ventilation of this morgue can be found at *op. cit.* (note 29).

<sup>139</sup> *Entseuchungs- und Entwesungsvorschrift für die Wehrmacht*, H. Dv. 194, M. Dv. 277, L. Dv. 416, Reichsdruckerei, Berlin 1939; *Richtlinien für die Anwendung von Blausäure (Zyklon) zur Ungeziefervertilgung (Entwesung)*, Gesundheitsanstalt des Protektorats Böhmen und Mähren, Prague n.d.; Doc. NI-9912 (1) in the Nuremberg Trial; *Technische Regeln für Gefahrstoffe*, TRGS 512, Begasungen, BArbBl. No. 10/1989, 72, in R. Kühn, K. Birett, *Merkmale Gefährlicher Arbeitsstoffe*, ecomed, Landsberg 1990.

<sup>140</sup> This is also the opinion of the French chemical expert on hydrogen cyanide, B. Clair, *op. cit.*, (note 25), who otherwise strongly disagrees with my conclusions; *i.e.*, he believes in the NS ‘gas chambers’.

The ‘gas chambers’ of crematoria IV and V as well as of Bunkers I and II would have had to be designed and built as instruments of mass murder if the mass gassings alleged to have been planned and in progress during the construction of these facilities had really taken place; yet even Pressac admits that the gassing procedures attested to were illogical and ridiculous, and highly dangerous to the *Sonderkommandos* in particular. In the face of all this, anyone approaching this issue from a scientific and technical perspective cannot but conclude that the alleged murderers went to great lengths to devise the most expensive, complicated, dangerous and problematic way to kill people *en masse*. For example, the coal-refining BUNA works of I.G. Farbenwerke AG, only a few miles away, could easily have provided a cheap supply of coal gas high in carbon monoxide for poisoning, or bottled nitrogen for asphyxiation.<sup>141</sup> But in Auschwitz, of all places, it had to be the expensive, scarce and awkward-to-use Zyklon B that was used, even though it was badly needed everywhere else for pest control. Yet in other alleged extermination camps far distant from the BUNA plant, carbon monoxide is said to have been used to kill people, and to have been generated for this purpose with Diesel engines from captured Russian tanks, whose exhaust fumes, however, contain only non-lethal quantities of carbon monoxide when operated in neutral gear (as they would have to have been).<sup>142</sup>

One must realize that near the alleged homicidal ‘gas chambers’ in Auschwitz there were highly efficient delousing facilities, with airlocks, heating, powerful ventilators etc., and all of them had been constructed prior to the alleged homicidal ‘gas chambers’. Further, at the time of construction of these alleged ‘gas chambers’ the technology for fumigating material objects had advanced greatly and the production of such facilities was in full swing. From everyday practical experience in delousing, the difference in time and material (Zyklon B) requirements between fumigations with and without air circulation will have been well-known. One might therefore expect the application of at least similar technological standards for the alleged homicidal gassing facilities, but clearly nothing even remotely approaching such standards was in fact used.

For propagandistic reasons it would have been obvious to present such facilities as the delousing chambers of Buildings 5a and 5b as homicidal ‘gas chambers’. But no attempts were ever made to do so, and there are also no eyewitness statements alleging such a use of these rooms. Further, the doors of the delousing room of Building 5b – both as shown on the construction plans and as they actually exist there today – open inward, which means that in any mass gassing the bodies lying by the doors would have kept these from being opened afterwards. These rooms, therefore, were certainly never used as execution ‘gas chambers’.

We will just comment briefly on the widely held belief that the poison gas entered the alleged execution ‘gas chambers’ via showerheads. In Zyklon B the active substance hydrogen cyanide is adsorbed on the solid carrier substance, mainly gypsum, and is released only gradually. Since the poison is neither a liquid nor a gas under pressure, the hydrogen cyanide from this product could never have been channeled through narrow water pipes and showerheads. Any showers, real or fake, could thus only have served to deceive the victims, but never to introduce the poison gas. Even with all the arguing and dissension that characterizes the overall subject, there is a general consensus on this particular point.

---

<sup>141</sup> A more detailed discussions of the odds and evens of different poisonous gases which could have served for mass murder can be found in G Rudolf, *The Rudolf Report*, *op. cit.* (note 27), pp. 241-244.

<sup>142</sup> Cf. the chapter by F. P. Berg, this volume.

## 5. Valuation of Chemical Analyses

### 5.1. The Samples

Before taking sample material from the alleged Auschwitz ‘gas chambers’ one ought to verify that the material is in fact original, and to investigate its post-war history. The foundations and foundation walls of crematoria IV and V visible today were constructed after the war by the Museum Administration.<sup>143</sup> Since the origin of the material used is uncertain, it hardly makes sense to take samples here.<sup>144</sup> By incredibly good luck, however, the ‘gas chamber’ (mortuary 1) of crematorium II has largely survived intact. Aside from the two holes in the ceiling discussed in 2.4.1. (*illustration 6, 7*), the building materials are not only indisputably original and unaltered, but are also largely protected from weathering by the ceiling. Furthermore, according to Pressac, this room was allegedly the central site, so to speak, of alleged mass murder. This is where most of the gassings are said to have occurred. Taking samples here is thus appropriate not only by virtue of the original nature and history of the material, but also due to the results which an analysis may be expected to return. If iron blue residue is to be expected in homicidal ‘gas chambers’, then here is where one should strike pay dirt. To date there have been three samplings worth mentioning:<sup>145</sup> by Leuchter,<sup>1</sup> Rudolf<sup>19</sup> and Ball.<sup>144</sup> The reader is referred to these sources for details on sample removal and characterization.

### 5.2. Results of the Analyses

Table 3 summarizes the most important results of the analyses of material samples for cyanide content (cyanides = hydrogen cyanide compounds). The first part of the Table reflects samples taken from alleged ‘gas chambers’. The second section pertains to samples from delousing chambers. The third shows the results of analyses of samples relating neither to ‘gas chambers’ nor to delousing chambers. This would actually also be the proper category for all samples taken from the reconstructed foundations and foundation walls of crematoria IV and V as well as from the Farm Houses (‘Bunkers’), whose building materials are of unknown origin. On the basis of control samples it can be shown that due to the nature of the sample material, concentrations of less than 10 mg/kg are unreliable and hence must be considered null (see control analyses to samples R 3 & 8).<sup>146</sup> One can thus observe that the alleged ‘gas chambers’ exhibit the same concentrations of hydrogen cyanide residue as any building selected at random – namely, none that are great enough to be reliably interpreted. The unreliability of low cyanide residues is additionally proven by a sample from a collapsed Bavarian farmhouse, my sample no. 25, which has the highest cyanide level of all samples of this group (9.6 mg/kg, reproducible probably due to low CaCO<sub>3</sub> amount in bricks), and by Leuchter’s sample no. 28 from crematorium I, which he erroneously took from a wall which until 1944

---

<sup>143</sup> Aside from the statements of J. Markiewicz et.al., *op. cit.* (note 11), cf. also J.-C. Pressac, *op. cit.* (note 9), p. 390.

<sup>144</sup> The fact that F.A. Leuchter, *op. cit.* (note 1), as well as J. Ball, *The Ball Report*, Ball Resource Services Ltd., Delta, BC, Canada, 1993, found traces of cyanide in samples taken from there may indicate either the application of HCN on these materials of unknown origin by fumigation or homicidal gassings or that results near the lower detection limit are hardly reproducible and insofar hard to interpret.

<sup>145</sup> We are deliberately ignoring the results of the Krakow Report, *op. cit.* (note 11), since improper analytical methodology renders them useless; cf. *The Rudolf Report*, *op. cit.* (note 27), pp. 250-252, 270-273, and chapter 5.4. in this contribution.

<sup>146</sup> The reason for this may be that high amounts of CaCO<sub>3</sub> may disturb the analysis as described in the according norm (DIN 38 405/D13f.), cf. G. Rudolf, *The Rudolf Report*, *op. cit.* (note 27), pp. 252-258. The reason for the unexpected broad variation of samples with high cyanide residues (my sample no. 11) may be due to the different method of analysis necessary for high cyanide amounts: it can no longer be detected photometrically but must be measured gravimetrically, a method rarely used for cyanides in modern laboratories, which is therefore more liable for errors.

belonged to the wash room, that is, it was *not* part of the alleged 'gas chamber' (1.3 mg/kg). In contrast, the residual quantities in the delousing barracks range from 1,000 to 10,000 mg/kg, meaning that 0.1 to 1% of the plasterwork (not the entire wall!) in fact consists of cyanides. These findings are not only not questioned by the Director of the Auschwitz Museum, but are in fact expressly confirmed.<sup>146</sup> Since the results are no longer subject to doubt, we would urge that no further samples be removed without official sanction, lest these facilities suffer the same fate as did the Berlin Wall.

### 5.3. Interpreting the Results

#### 5.3.1. Rudolf's Interpretation

In view of these perfectly clear results and of the fact that they cannot be explained away by any disintegration processes of iron blue, which remains stable for great periods of time, the question which needs to be addressed is how these results are to be interpreted scientifically.

First of all one has to be careful when comparing the analyses results of samples taken from the delousing chambers with those taken from the alleged homicidal gas chamber. The reason for this is that especially in case of the delousing facilities several factors are unknown which can affect the interpretation of the results:

1. In case of the delousing chambers BW 5a and 5b it is not known how much time passed between the time when their walls were plastered and when they started being used for their purpose.
2. We therefore cannot exactly determine a) the exact humidity, and b) the alkalinity of the walls, when started being used.
  - a) Single layer brick walls, as used in case of the delousing facilities BW 5a and 5b, normally are quite cold and thus wet in winter time. So, if these facilities went into operation in autumn or winter time immediately after having been plastered, their walls certainly would have absorbed enormous amounts of HCN and probably converted it into long-term stable iron cyanide compounds already during the very first gassing (comparable with the quoted construction damage case<sup>102</sup>). Fortunately, we can compare the results of samples taken from an internal wall (no. 12 & 13) with those of external walls (9,11,20,22) of the delousing facility BW 5a, which clearly shows that even dry and warm walls do form high amounts of iron blue residues.
  - b) Furthermore, having enormous problems with a raging spotted fever epidemic, the SS certainly did not wait for fighting the lice until the plaster of the recently finished delousing gas chambers was pH-neutral.

On the other hand, the features of the walls of the mortuary 1 of crematorium II can more easily be determined:

1. We do know, that due to its chemical composition the cement mortar used for plastering the underground morgues remain highly alkaline for many months.
2. We do know that this cement mortar has generally a considerable higher tendency to absorb gaseous and liquid compounds than lime mortar as used in delousing facilities.<sup>147</sup>
3. We do know, that walls in unheated underground rooms have relatively cold walls of high humidity, which increases absorption of HCN enormously (an estimated average wall temperature of 10°C and a relative humidity of the air at around 100% is reasonable, increasing the absorption by around a factor 10 compared to a wall at 20°C and 45% relative humidity).<sup>148</sup>

<sup>147</sup> That is due to its higher inner surface, *i.e.*, like a fine sponge (here cement mortar) can absorb more water than a course one (here lime mortar). W. Czernin, *Zementchemie für Bauingenieure*, Bauverlag, Wiesbaden 1977, p. 49f. (Engl.: *Cement chemistry and physics for civil engineers, ibid.*, 1980); cf. my report (note 19), chapter 2.5.

<sup>148</sup> K. Wesche, *op. cit.* (note 97) vol. 1, p. 37

<b>Table 3: Cyanide Concentrations in the Walls of 'Gas Chambers' and Delousing Chambers of Auschwitz &amp; Birkenau</b>			
<b>No.</b>	<b>Location</b>	<b>Sampler</b>	<b>c[CN<sup>-</sup>] mg/kg</b>
1-7	Crematorium II, mortuary 1 ('gas chamber')	Leuchter	0.0
8	Crematorium III, mortuary 1 ('gas chamber')	Leuchter	1.9
9	Crematorium III, mortuary 1 ('gas chamber')	Leuchter	6.7
10,11	Crematorium III, mortuary 1 ('gas chamber')	Leuchter	0.0
13,14	Crematorium IV, remnants of foundation wall	Leuchter	0.0
15	Crematorium IV, remnants of foundation wall	Leuchter	2.3
16	Crematorium IV, remnants of foundation wall	Leuchter	1.4
17-19	Crematorium IV, remnants of foundation wall	Leuchter	0.0
20	Crematorium IV, remnants of foundation wall	Leuchter	1.4
21	Crematorium V, remnants of foundation wall	Leuchter	4.4
22	Crematorium V, remnants of foundation wall	Leuchter	1.7
23,24	Crematorium V, remnants of foundation wall	Leuchter	0.0
25	Crematorium I, mortuary ('gas chamber')	Leuchter	3.8
26	Crematorium I, mortuary ('gas chamber')	Leuchter	1.3
27	Crematorium I, mortuary ('gas chamber')	Leuchter	1.4
29	Crematorium I, mortuary ('gas chamber')	Leuchter	7.9
30	Crematorium I, mortuary ('gas chamber')	Leuchter	1.1
31	Crematorium I, mortuary ('gas chamber')	Leuchter	0.0
1	Crematorium II, mortuary 1 ('gas chamber')	Rudolf	7.2
2	Crematorium II, mortuary 1 ('gas chamber')	Rudolf	0.6
3	Crematorium II, mortuary 1 ('gas chamber')	Rudolf	6.7/0.0
3	Crematorium II, mortuary 1 ('gas chamber')	Ball	0.4
4	Crematorium III, mortuary 1 ('gas chamber')	Ball	1.2
5	White Farm House, remnants of foundation	Ball	0.07
6	Crematorium V, remnants of foundation wall	Ball	0.1
32	Delousing Room B1a BW 5a, inside	Leuchter	1,050.0
9	Delousing Room B1a BW 5a, inside	Rudolf	11,000.0
11	Delousing Room B1a BW 5a, inside	Rudolf	2,640.0/1,430.0
12	Delousing Room B1a BW 5a, inside	Rudolf	2,900.0
13	Delousing Room B1a BW 5a, inside	Rudolf	3,000.0
14	Delousing Room B1a BW 5a, outside	Rudolf	1,035.0
15a	Delousing Room B1a BW 5a, outside	Rudolf	1,560.0
15c	Delousing Room B1a BW 5a, outside	Rudolf	2,400.0
16	Delousing Room B1b BW 5b, outside	Rudolf	10,000.0
17	Delousing Room B1b BW 5b, inside	Rudolf	13,500.0
18	Delousing Room B1b BW 5a, wood from door jamb	Rudolf	7,150.0
19a	Delousing Room B1b BW 5b, inside	Rudolf	1,860.0
19b	Delousing Room B1b BW 5b, inside	Rudolf	3,880.0
20	Delousing Room B1b BW 5a, inside	Rudolf	7,850.0
22	Delousing Room B1b BW 5a, inside	Rudolf	4,530.0
1	Delousing Room B1b BW 5b, inside and outside	Ball	3,170.0
2	Delousing Room B1b BW 5a, inside and outside	Ball	2,780.0
28	Crematorium I, Washroom	Leuchter	1.3
5	Inmate barracks	Rudolf	0.6
6	Inmate barracks	Rudolf	<0.1
7	Inmate barracks	Rudolf	0.3
8	Inmate barracks	Rudolf	2.7/0.0
23	Inmate barracks	Rudolf	0.3
24	Inmate barracks	Rudolf	0.1
25	Untreated brick from collapsed Bavarian Farmhouse	Rudolf	9.6/9.6

Concentrations are in mg of cyanide (CN<sup>-</sup>) per kg of building material (brick, mortar, concrete, plaster). Cyanide values of less than 10 mg/kg are uncertain, samples returning values of less than 1-2 mg are considered cyanide-free. If two values are given, the second value gives the result of a control analysis performed by a different company.

It is therefore reasonable to assume that the massively higher and longer lasting tendency of the wet and cold cement mortar of the morgues of crematorium II and III to form long-term stable cyanide compounds could easily compensate the somewhat shorter time it was exposed to the poisonous gas, if compared to the scenarios in the warm, dry and short-lasting alkaline internal walls of the delousing chambers.

It is therefore the conviction of the author that the high humidity, the relatively long lasting alkalinity of the cement plaster used in these mortuaries of crematoria II and III, in combination with the realistic homicidal gassing scenarios (high HCN concentrations, slow ventilation process) would have led to the formation of long-term stable cyanide compounds in an amount that should be easily detectable still today. Not at least because the conditions of these mortuaries are very similar to those described in the construction damage case referred to before,<sup>102</sup> which is quoted entirely and henceforth analyzed in Appendix 1 of this volume.

### 5.3.2. Critique of Different Interpretations

There have been several ways of interpreting these results which I shall summarize and criticize here briefly.<sup>149</sup>

There is a number of retorts to my findings which in my eyes are aiming with weak arguments at the wrong points. *E.g.*, Bailer<sup>15,23</sup>, Markiewicz *et al.*<sup>11</sup> and Clair<sup>25</sup> have claimed that no iron blue could form in brickwork merely as consequence of hydrogen cyanide fumigation. This has been sufficiently disproved.<sup>150</sup> Instead they explain the blue color of the delousing chamber walls as paint that was applied during or after the war. However, this hypothesis fails to explain:

- why the blue discoloration on the inside of the walls of delousing building 5a and on the bricks of the *outside walls* of both buildings is irregular and patchy (unless the painters painted the inside as well as the outside by throwing brushes and other paint-bearing objects at the walls instead of painting normally);
- why the inside dividing walls that were added to Building 5a after this facility was discontinued as hydrogen cyanide fumigation center are white, and free of hydrogen cyanide compounds (unless someone decreed that these walls should not be painted to match the splotchy appearance of the other walls);
- why the southern dividing wall of Building 5a, which is located entirely within the building, exhibits only a pale blue color despite a high cyanide content, and why the plaster of Building 5b, while containing similar concentrations of cyanide, is even plain white (unless what was used to paint these walls was not Prussian Blue, *i.e.*, iron blue, but Cyanide White – which has yet to be invented);
- why the deeper, subsurface(!) layers of the walls of the delousing chamber in Building 5b are a greenish blue, and saturated with cyanide compounds (unless for some inexplicable reason the mortar used for these walls was dyed blue before being used);
- why only those chambers in Auschwitz, Birkenau, Majdanek<sup>151</sup> and Stutthof<sup>152</sup> (!) which were used for HCN fumigation have a patchy blue color (where nobody could admire it) and all other walls in all the camps were just painted with white chalk color;

<sup>149</sup> For a detailed discussion see the updated version of my report on the Internet, note 19 and 27, as well as my article, note 29.

<sup>150</sup> G. Rudolf, *The Rudolf Report, op. cit.* (note 27), pp. 269-273; G. Rudolf, in H. Verbeke, *op. cit.* (note 12) and G. Rudolf, *VffG, op. cit.* (note 25).

<sup>151</sup> See J. Graf and C. Mattogno, *CC Majdanek, op. cit.* (note 30), picture section, and color picture on the back cover of this book.

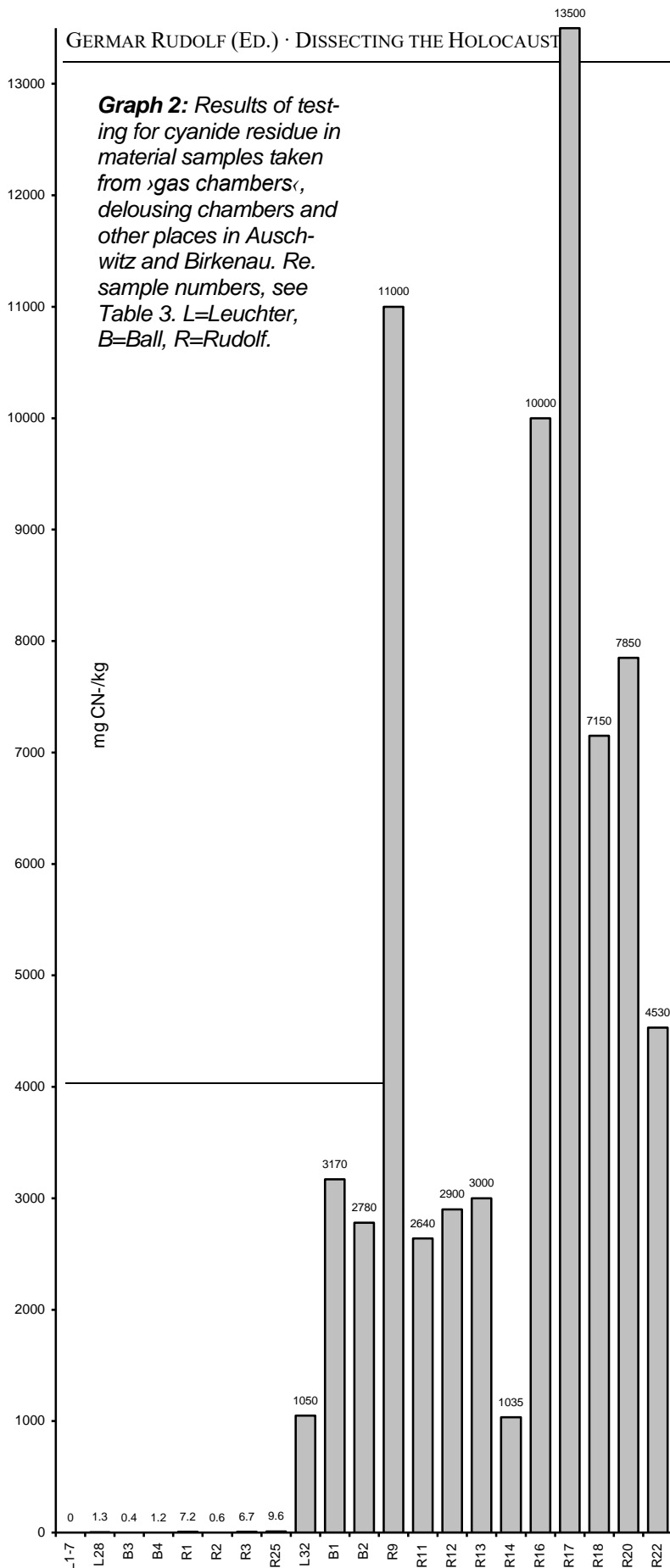

- why there is no layer of paint with a brush-like structure indicating that the walls were indeed painted.<sup>153</sup>

The fact is that the walls of the delousing buildings are saturated through and through with hydrogen cyanide compounds, of which only a part becomes visible as iron blue, predominantly in damp areas and at the surfaces due to accumulation processes. These facts can be explained only as a result of fumigations with HCN.

Another attempt at explaining the difference of the results between alleged execution 'gas chambers' and delousing chambers was somewhat more complicated. As mentioned before, humans are more sensitive to HCN than are insects. Holocaust advocates argue that the execution gassings were performed using only very little hydrogen cyanide, and that they did not take nearly as long as the delousing fumigations of material objects, which often took many hours.<sup>154</sup> These two factors – low concentrations of HCN and shorter fumigation times – resulted in a lack of residue formation.<sup>10,13,15,155</sup>

If one recalls our previous findings regarding the quantities allegedly used (similar to those for delousing fumigations) and the problems of ventilation, which would have taken hours, if not days, then it is quite clear

<sup>152</sup> See J. Graf, C. Mattogno, *Concentration Camp Stutthof and its Function in National Socialist Jewish Policy*, Theses & Dissertations Press, Chicago, IL, 2003, picture section (online: [vho.org/BG/Books/css](http://vho.org/BG/Books/css)), and the color picture on the back cover of this book.

<sup>153</sup> Only a few portion of color paint is the coloring pigment, the rest is diluting filler/carrier material, which, however, cannot be found on these walls.

<sup>154</sup> A. Breitwieser, Head of the Inmate Clothing Depot in Auschwitz, tells of round-the-clock fumigations at the German supply depot, H. Langbein, *Der Auschwitz-Prozeß*, *op. cit.* (note 127), p. 786.

<sup>155</sup> R.J. van Pelt, *op. cit.* (note 28), p. 298, who is otherwise merely parroting what others have said, especially Markiewicz *et al.*, *op. cit.* (note 11).

that this assumption needs wrong premises. The results of the chemical analyses can therefore not be explained in this way.

G. Wellers was the first to advance the theory that the victims had absorbed all the hydrogen cyanide by respiration.<sup>156</sup> This theory has already been clearly refuted in section 4.2.2.1.

Ignoring the scientific facts as summarized here in section 3.3.2., Markiewicz *et al.*<sup>11</sup> and van Pelt<sup>156</sup> have wrongly claimed that iron blue would disappear when exposed to environmental conditions.

A new corny joke was recently added to this debate by Prof. James Roth from the Alpha Analytic Laboratories, Ashland, Massachusetts. I discuss this event here because Prof. Roth's allegations were widely publicized by the international media in connection with the libel case of British historian David Irving against Deborah E. Lipstadt.<sup>157</sup>

In 1988, Roth's laboratory had analyzed the masonry samples from the alleged 'gas chambers' taken by Leuchter in Auschwitz for their cyanide content. During the trial against Ernst Zündel in Toronto that same year, for which the Leuchter report had been produced, Prof. Dr. Roth himself was interrogated as an expert witness. Ten years later, Errol Morris interviewed Roth about this event for his documentary movie *Mr. Death* on Fredrick A. Leuchter. During this interview, Prof. Roth did all he possibly could to distance himself from the possible consequences of the analyses performed by his company. His interview gained importance only due to the fact that the Dutch architectural Historian Prof. Robert van Pelt quoted Roth in his 1999 expert report prepared for the Irving trial. In it, van Pelt wrote about Roth's statements in Morris' movie:<sup>158</sup>

*“Roth explained that cyanide will react on the surface of brick or plaster, penetrating the material not more than 10 microns, or 0.01 mm, or one tenth the thickness of a human hair [...]. In other words, if one wants to analyze the cyanide concentration in a brick sample, one should take a representative sample of the surface, 10 microns thick, and no more.”*

It can be shown that Prof. Dr. James Roth is wrong for the following reasons:

1. It is a fact that the walls of the disinfection chambers in Auschwitz, Birkenau, Stutthof, and Majdanek are saturated with cyanide compounds, and this not only superficially, but into the depth of the masonry, as I have proved by taking samples from different depths of the wall, compare in this regard especially my samples no. 11, 13, 17, 19b, and 23. They prove that hydrogen cyanide can rather easily reach deep layers of plaster and mortar. But even the other samples taken from the surface prove that Prof. Roth's allegation is wrong: Provided that most of the cyanide detectable today is present in the form of iron cyanide (Iron Blue and other cyanoferrates), as Prof. Roth assumes himself, his thesis would mean that 10% to 75% of the iron content of these samples are located in the upper 10 micrometer of my samples (0.010 mm), *i.e.*, they are located in less than 1% of the entire sample mass, and the rest of the sample would have been massively deprived of iron. How this migration of a major portion of iron to a thin surface layer would have happened is inexplicable to me.
2. Furthermore, expert literature is detailed in that
  - a. hydrogen cyanide is an extremely mobile chemical compound with physical properties comparable to water,<sup>159</sup>
  - b. which can quite easily penetrate through thick, porous layers like walls.<sup>98</sup>
3. In addition, it is generally known that cement and lime mortar are highly porous materials, comparable for instance with sponges.<sup>160</sup> In such materials, there does not exist something like

<sup>156</sup> *Ibid.*, p. 306.

<sup>157</sup> This claim played a role in the verdict which should not be underestimated, cf. judgment Gray in court case of note 28.

<sup>158</sup> *Pelt Report, op. cit.* (note 28), p. 307.

<sup>159</sup> W. Braker, A. L. Mossman, *Matheson Gas Data Book*, Matheson Gas Products, East Rutherford 1971, p. 301.



a defined layer of 0.01 mm beyond which hydrogen cyanide could not diffuse, as there can also be no reason, why water could not penetrate a sponge deeper than a millimeter. Steam, for example, which behaves physically comparable to hydrogen cyanide, can very easily penetrate walls.

4. Finally, the massive discolorations of the *outside* walls of the disinfestation chambers in Birkenau and Stutthof, as shown on the cover of this book, are clearly visible and conclusive evidence for the fact how easily hydrogen cyanide and its soluble derivatives can penetrate such walls.

As a professor of analytical chemistry, Prof. Roth must know this, so one can only wonder why he spreads such outrageous nonsense. That Prof. Roth is indeed a competent chemist can be seen from what he said during his testimony under oath as an expert witness during the above mentioned Zündel trial.<sup>161</sup>

*“In porous materials such as brick or mortar, the Prussian blue [recte: hydrogen cyanide] could go fairly deep as long as the surface stayed open, but as the Prussian blue formed, it was possible that it would seal the porous material and stop the penetration.”*

It is also revealing that Prof. Roth mentioned during this interview, if he had known where Leuchter’s samples originated from, his analytical results would have been different. Such an attitude is exactly the reason why one should never tell an ‘independent’ laboratory about the origin of the samples to be analyzed. What Prof. Dr. Roth has demonstrated here is only his lack of professional honesty.

Another strange story is that of Richard Green, a PhD Chemist with quite similar educational background as I have.<sup>26</sup> The layman would expect two experts with similar educational background to come to similar conclusions in questions relating to their expert knowledge. But this is only partly the case. The reason for this is that Dr. Green ignores many facts that are either supported by documentary evidence – like the performance of the ventilation installed in crematoria II and III, or the speed of executions in U.S. execution chambers – or by expert literature – like the higher tendency of cold, moist walls to adsorb HCN, and the longer lasting alkalinity of cement mortar compared to lime mortar.

However, Dr. Green makes some concessions which are important to note:

- a) He agrees that basically all witnesses attest to very short execution times, indicating a rather high concentration of HCN used.
- b) He also agrees *“that Rudolf is correct or nearly correct regarding the formation of blue staining in the delousing chambers.”*

What he does challenge, though, is the possibility of formation of any noticeable quantities of Iron Blue in the homicidal ‘gas chambers.’ One of his flawed and deficient arguments to support his thesis is that in his view, no noticeable amounts of cyanide could have accumulated in the walls of the

---

<sup>160</sup> DIN 4108, part 3 to 5, deals with diffusion of steam into building materials. The most important coefficient for building materials is the so-called coefficient of diffusion resistance; this is a dimensionless number indicating, how much longer the diffusion of steam takes to penetrate a layer of certain materials compared to the time it takes to diffuse through the same layer of still air. This coefficient is valid not only for water vapor, but also for gaseous hydrogen cyanide as well as for any other gas. In the list of 100 different building materials compiled in DIN 4108 part 4, one can find lime and cement mortar with diffusion resistances from 15 to 35, in which case the resistance grows with increasing cement content, for gypsum plaster, the coefficient is 10, for brick walls 5 to 10, for glass wool mats it is 1. That means, if a gas diffuses through a layer of still air with a speed of 1 cm per second, it does take 15 to 35 seconds to diffuse through a 1 cm thick layer of lime or cement mortar and 5 to 10 seconds to diffuse just as deep into a brick wall. (I am grateful to Mr. C.H. Christmann for this reference.)

<sup>161</sup> Kulaszka (ed.), *Did Six Million Really Die? Report on the Evidence in the Canadian “False News” Trial of Ernst Zündel – 1988*, Samisdat Publishers Ltd., Toronto 1992, p. 363 (protocol p. 33-9291).

morgues (‘gas chambers’). According to Dr. Green, one major factor for this is supposed to be the fact that masonry has a neutral pH value which prevents the formation of cyanide salts. But if that were true, how come huge amounts of cyanides did accumulate in the walls of the disinfection chambers?

My argument in this regard is that particularly cement plasters and concretes, as used in morgues 1 of crematoria II and III, are noticeably alkaline for many weeks, months, or even years, which I documented thoroughly with expert literature on the chemistry of building materials.<sup>162</sup> Hence, I concluded that these walls would have been very much inclined to accumulate cyanide salts and to form Iron Blue, even more so than the lime plaster of the disinfection chambers, which in turn provoked the following answer by Dr. Green:

“[In 1993] *The IFRC* [Institute for Forensic Research, Cracow], *on the other hand measured the pH* [of mortar samples from the alleged gas chambers] *to be between 6 and 7* [i.e. neutral].”

Dr. Green obviously did not consult any literature on the chemistry of building materials, as he quotes none. He solely relies on the findings of the Krakow institute. In order to make the reader see how flawed Dr. Green’s way of arguing is, let me say it in a parable:

By referring to a couple of Italian expert pizza baking instructions, I showed that a pizza, when taken out of the oven, is hot or warm for quite a while (one hour). Now, Dr. Green comes along claiming that I am wrong because a Polish friend of his has just now measured the temperature of a pizza which was baked a week ago, and which has been lying around somewhere since. And the Polish scientists found out that this pizza is indeed cold right now. Surprise, surprise! What does the pH value of samples taken 50 years after the erection of these building prove regarding their pH value shortly after they were built? Dr. Green’s way of arguing is childish to the highest degree.

#### 5.4. A serious attempt of deception

Many exterminationists rely heavily on the results of the Krakow Institute of Forensic Research, *i.e.*, the work of Markiewicz and colleagues as published in 1994. These Poles have conducted their analyses with a method which is not able to detect iron cyanide compounds. They did this because they allegedly didn’t understand how such compounds could possibly form:<sup>11</sup>

*“It is hard to imagine the chemical reactions and physicochemical processes that could have led to the formation of Prussian blue [= iron blue, G.R.] in that place.”*

Has anyone ever heard that the non-understanding of a phenomenon is a reason for not examining it? For the Poles it obviously was. And even more: They did not even try to refute the theory I presented in one of my publications of spring 1993.<sup>163</sup> They knew of this publication, since they quoted it, but only as an example of the alleged evil deeds of the deniers and whitewashers of Hitler, whom they intend to refute. That should be enough to show that the intention of the Poles is highly ideologically biased. If they were neutral scientists, they would not care about the dirtiness of Hitler’s laundry.

Moreover, they did not even make an attempt to explain what might be responsible for the high iron cyanide content of the wall’s plaster, the inner mortar, and even the outside bricks as well as their patchy blue coloring without any presence of paint.

Even though they had tampered with the analysis method, when testing their first series of samples, it turned out that only one sample taken from an alleged homicidal ‘gas chamber’ had minimal cyanide residues, in contrast to the samples taken from a delousing chamber. Hence, the Poles sup-

<sup>162</sup> See chapter 6.7.2. of *The Rudolf Report*, *op. cit.* (note 27).

<sup>163</sup> E. Gauss, *Vorlesungen zur Zeitgeschichte*, *op. cit.* (note 18), pp. 163-170; 290-294.

pressed these findings<sup>164</sup> and took more samples,<sup>11</sup> until they found what they were looking for. This time, the samples from both the delousing chambers and the alleged homicidal ‘gas chambers’ showed extremely low but comparable amounts of short-term stable cyanide residues. But at least they established that wet cement mortar absorbs much more than 10 times as much HCN than dry lime mortar does, as I assumed in my extrapolations. In the following table, I compare the results as obtained by the Poles, by Leuchter and by me:

**Table 4: Comparison of the order of magnitude of analyses results of different samples**

AUTHOR:	MARKIEWICZ <i>ET AL.</i>	LEUCHTER	RUDOLF
DETECTION OF:	Cyanide without Iron Cyanides (Short-term Stable Cyanides)	Total Cyanide	Total Cyanide
LOCATION			
DELOUSING CHAMBERS:	0 - 0,8 mg/kg	1,025 mg/kg	1,000 – 13,000 mg/kg
ALLEGED GAS CHAMBER:	0 - 0,6 mg/kg	0 - 8 mg/kg	0 - 7 mg/kg

Even after confronting them with my arguments about their work,<sup>165</sup> the Poles refused to give any explanation for their unscientific behavior. Dr. Markiewicz, who is not a chemist but a “*Specialist for Technical Testing*”, died in 1997. The remaining two co-authors, W. Gubala and J. Labeledz, have been silent about that ever since, like thieves hiding in the night.

It is also indicative that these Polish authors have an ardent supporter in Dr. Green. Although Dr. Green agrees with me that the Iron Blue found in delousing chambers is the result of gassings with hydrogen cyanide, he refuse to acknowledge that the approach of the Krakow team to exclude Iron Blue from the analysis was fraudulent. No matter which results the Polish scientists produced and what their scientific opinion might have been: their behavior is extremely unscientific, as **the most important task of a scientist is to try to understand what has not been understood so far, and to discuss the attempts of others to make understandable**. The Polish scientists did just the opposite: they decided to ignore and exclude what they did not understand.

And the amazing thing about Dr. Green is that he – and with him Prof. van Pelt, who relies on Green<sup>166</sup> – does not only defend Prof. Markiewicz’s behavior in every regard, but he attacks me for my critique against the Polish scientists, while omitting *all the reasons* I gave for doing so. To crown this, Dr. Green even defends the fact that Prof. Markiewicz never even bothered to address any of my critique, even though addressing critiques is paramount for scientists. Dr. Green argues:

*“Rudolf complains that Markiewicz et al. have not responded to his queries. Why should they do so? What credibility does Rudolf have, that demands they answer his every objection no matter how ill-founded?”*

However, since Dr. Green agrees that the Iron Blue detectable in disinfestation walls *is* the result of gassings with Zyklon B, he himself has indirectly admitted that all my objections against Markiewicz’s method of analysis are well-founded, *i.e.*, just the opposite of “*ill-founded*”.

<sup>164</sup> The first paper of J. Markiewicz, W. Gubala, J. Labeledz, B. Trzcinska, was never published by themselves, but only by Revisionists, as this paper leaked out of the Jan Sehn Institute in 1991: “*An official Polish report on the Auschwitz ‘gas chambers’*”, *The Journal of Historical Review*, Summer, 11(2) (1991), p. 207. (online: [vho.org/GB/Journals/JHR/11/2/IHR207-216.html](http://vho.org/GB/Journals/JHR/11/2/IHR207-216.html)), for details see Germar Rudolf, “*A fraudulent attempt to refute Mr. Death*”, online only: [vho.org/GB/Contributions/Fraudulent.html](http://vho.org/GB/Contributions/Fraudulent.html).

<sup>165</sup> G. Rudolf, in H. Verbeke (ed.), *op. cit.* (note 12), pp. 81-90; for an Engl. summary cf. G. Rudolf, “*Some considerations about the ‘Gas Chambers’ of Auschwitz and Birkenau*”, heitherto unpubl. paper presented at the 1st Australian Revisionist Conference, Adelaide, August 9, 1998, (online: [vho.org/GB/Contributions/Green.html](http://vho.org/GB/Contributions/Green.html)) as a reaction on an online-critique by Richard J. Green, *op. cit.* (note 26).

<sup>166</sup> Robert J. van Pelt, *The Case for Auschwitz. Evidence from the Irving Trial*, Indiana University Press, Bloomington/Indianapolis 2002.

And why does Dr. Green think I bear no credibility demanding a discussion of any of my arguments? Not because I lack scientific qualifications. No, he thinks I am an abomination because of my views, and because I have been subject to social persecution and political prosecution, leading to the total destruction of my social existence, my reputation, and finally my freedom. Dr. Green even resorts to calling me a “*liar*,” “*obfuscator*,” and “*hater*” because of my different well-founded opinions.

The scheme is as follows: first, people like Dr. Green attempt to do everything to destroy my reputation by name-calling, persecution, and prosecution, and when they succeed, they claim that there is no need to discuss anything with me anymore, since I do not have any reputation and credibility anyway. This way they can nicely ignore any argument refuting their flawed thesis. And they have the chutzpah to call themselves righteous scientists and to call me a pseudo-scientific liar and obfuscator of the truth.

Dr. Green unconditionally defends the scientific frauds from the Krakow institute, and both get away with it, because in the eyes of the public, both have the ‘politically correct’ ‘scientific’ opinion about Auschwitz. Birds of the same feather flock together.

The same behavior as the Polish scientists, Dr. Green, and Prof. Pelt exposed was shown by the Pope’s Holy Inquisitor Cremonini who refused to look through Galileo’s telescope to see Jupiter’s moons revolving around Jupiter, because he could not – or did not want to – understand what Galileo was saying – since he did not like the consequences for his worldview, which is: if moons revolve around Jupiter, then our Earth might revolve around the sun. Markiewicz, Dr. Green, and van Pelt do the same thing: They refuse to use a ‘telescope’ that enables them to see Iron Blue ‘revolving around the delousing chambers’, because they do not like the impact this has on their worldview: if Iron Blue ‘revolves around the delousing chambers’, then Iron Blue might be expected to ‘revolve around homicidal gas chambers’ as well. And they do not like that at all, because due to lack of Iron Blue, that opens doubts about the reality of the claimed homicidal gas chambers.

What we must conclude is the following: The only ‘scientific’ attempt to refute Fredrick A. Leuchter’s most intriguing thesis turns out to be one of the biggest scientific frauds of the twentieth century. How desperate must they be – those who try to defend the established version of the Holocaust, *i.e.*, the alleged systematic extermination of Jews in homicidal ‘gas chambers’ – that they resort to such obviously fraudulent methods?

## 5.5. The Limits of the Chemical Method

The latest trend in the establishment school of thought is towards altering various factors relating to the homicidal gassings, even if this is in crass contradiction to the eyewitness testimony or the technical facts.

Only a few years ago it was still the norm to speak of daily, even of continual gassings,<sup>167</sup> but the recent, drastic reductions in the numbers of victims, down to at most 630,000,<sup>168</sup> 470,000 to 550,000,<sup>169</sup> or even 356,000 gassing victims,<sup>170</sup> have resulted in the revised assumption of considerably fewer gassings per ‘gas chamber’ – and in fact, some estimates have been reduced to only a few ten-thousand victims per chamber.<sup>171</sup>

<sup>167</sup> *E.g.*, the testimony of M. Buki in the Frankfurt Auschwitz Trial, H. Langbein, *Der Auschwitz-Prozeß*, *op. cit.* (note 127), p. 96.

<sup>168</sup> J.-C. Pressac, *Les Crématoires d’Auschwitz*, ..., *op. cit.* (note 21), p. 148.

<sup>169</sup> J.-C. Pressac, *Die Krematorien von Auschwitz*, ..., *op. cit.* (note 21), p. 202.

<sup>170</sup> F. Meyer, *op. cit.* (note 124).

<sup>171</sup> Personal communication, I. Semyda, Greenwich, CT, USA.

Further, there is a trend, demonstrated above, to reduce noticeably the quantities of hydrogen cyanide allegedly used, contrary to what witnesses claim.<sup>172</sup>

Taking all these hypothetically, conceivably marginal requirements into consideration, it would be possible to arrive at a point where the duration for which the hydrogen cyanide was in contact with the cool and damp walls of mortuaries 1 of crematoria II and III was in fact so short that even a vague prediction of the results yielded by chemical analyses is no longer possible.

By this process the historians of the establishment in fact declare the eyewitness statements regarding the number of victims and the execution conditions to be unbelievable, and they ignore the circumstance that crematoria II and III had no holes through which the Zyklon B could have been introduced. But what do most historians care about factual arguments? They evidently have their ironclad opinion, and that's all there is to it.

However, chemistry is not the right science to find a *definite* answer to the questions whether homicidal gassings took place in Auschwitz and Birkenau or not, simply because the data we have, especially when coming from 'eyewitnesses', are insufficient and imprecise. But our chemical results show at least a high probability that the eyewitness statements about mass gassings are false.

## 6. Conclusions

Examination of the construction of the facilities allegedly used for the mass gassings has shown that the alleged main 'gas chambers' of Auschwitz – the mortuary of the Main Camp crematorium, and the mortuaries 1 (the 'gas chambers') of crematoria II and III – had no contrivances for the introduction of the poison gas substance. The holes visible in the ceilings today were added after the war. If these findings remain unrefuted, this alone renders any mass gassings, as these have been attested to, entirely impossible.

The examination of the formation and long-term stability of hydrogen cyanide residue in the walls of the facilities in question ('gas chambers' and delousing chambers for material objects), as well as the interpretation of the results of analysis of brick samples from these facilities in Auschwitz, have shown:

1. Hydrogen cyanide which reacts to form iron blue in the brick walls, etc. remains stable for many centuries. Its disintegration requires a time frame similar to that of the brickwork itself. Therefore, cyanide residue – if formed – ought still to be present in virtually undiminished quantities today, regardless of weathering effects. The outside walls of the delousing buildings BW5a/b in Birkenau, which are still blue on the outer surface today, as well as being high in cyanide content, serve to prove this.
2. Under such conditions as would actually be possible, the attested-to mass execution gassings with hydrogen cyanide probably would result in the rooms in question exhibiting cyanide residue on a similar scale as is the case in the disinfestation chambers for material objects, including the resultant blue discoloration of the walls.
3. In fact, however, the alleged 'gas chambers' exhibit only insignificant traces of cyanide residue, on the same order of magnitude as may be found in any other building.

Therefore, it is my conviction that the only conclusion which can explain all factors involved is that in the facilities alleged, no mass gassings with Zyklon B can have occurred under the conditions attested to by alleged eyewitnesses, court witnesses, journalists, academics or other popularizers.

---

<sup>172</sup> A hypothetical gassing scenario would proceed very differently if it could actually involve something that is occasionally alleged, namely that the Zyklon B was lowered into the gas chambers of crematoria II and III in nets, so that it could be quickly removed again after the victims had expired. This would have allowed for a more rapid ventilation of the chamber. But since this theory flounders on the nonexistence of the Zyklon B input hatches, we shall ignore it.

# The Crematoria Ovens of Auschwitz and Birkenau

CARLO MATTOGNO

## 1. Authors' Note

The first version of this article, which appeared in German language in 1994,<sup>1</sup> summarized a study on the crematorium ovens of Auschwitz that I had undertaken systematically since 1988 with the precious collaboration of Dr. Ing. Franco Deana.

Over the last 15 years, my historical as well as technical knowledge about this topic has increased to such an extent that it has become necessary to divide my original study into two volumes, the first consisting of the text (with more than 500 pages) and the second consisting of a collection of documents (270 documents and 360 photos).<sup>2</sup> This resulted in increasing difficulties to get said work published to such point that it is still under preparation by my publisher Edizioni di Ar while this summary is being prepared. The first, German language version of this article contained errors in formulation and data, above all due to the lack of documentation available at that time, which I could only partly correct in the second, English language version of this article published in 2000.<sup>3</sup> In fact, this contribution demanded a radical revision in order to adapt it to recently acquired information, which, for several reasons, I have not been able to carry out for the first English version of this article. Although the treatment of the cremation pits would also require a radical revision as a result of new knowledge, it cannot be summarized in just a few pages.<sup>4</sup> These new findings will be addressed in a separated study to be published elsewhere.<sup>5</sup> I therefore keep the text already published in 2000, even though I am quite aware of its deficiencies. Although only one author signs responsible for this version of this article – as well as for the both previous versions – Dr. Ing. Franco Deana should really be considered as a co-author, because he needs to be acknowledged for the precious assistance he always gave me.

Carlo Mattogno

## 2. Introduction

If a monstrous extermination of many hundreds of thousands of people took place in gas chambers in Auschwitz and Birkenau during the Second World War, and if the bodies of the victims were

---

<sup>1</sup> “Die Krematoriumsöfen von Auschwitz-Birkenau”, in: Ernst Gauss (ed.), *Grundlagen zur Zeitgeschichte. Ein Handbuch über strittige Fragen des 20. Jahrhunderts*, Grabert-Verlag, Tübingen 1994, pp. 281-320.

<sup>2</sup> *I forni crematori di Auschwitz. Studio storico-tecnico con la collaborazione del dott. ing. Franco Deana*; printed by Edizioni di Ar, Italy. Distributor: Libreria Ar, via F. La Francesca 26, 84100 Salerno, Italy (cf. Carlo Mattogno, Franco Deana, *The Crematory Ovens of Auschwitz-Birkenau*, Granata Communications, Palos Verdes (CA) 1995).

<sup>3</sup> “The Crematoria Ovens of Auschwitz and Birkenau”, in: Ernst Gauss (ed.), *Dissecting the Holocaust. The Growing Critique of “Truth” and “Memory”*, Theses & Dissertations Press, Capshaw, Alabama, 2000, pp. 373-412.

<sup>4</sup> The version of this article mentioned in the previous note has been criticized with technically dull arguments by John C. Zimmerman (“*Body Disposal at Auschwitz: The End of the Holocaust Denial*”, [www.holocaust-history.org/auschwitz/body-disposal/](http://www.holocaust-history.org/auschwitz/body-disposal/). and “*My Response to Carl Mattogno*”, [www.holocaust-history.org/auschwitz/response-to-mattogno/](http://www.holocaust-history.org/auschwitz/response-to-mattogno/)), that I refuted with my studies “*Supplementary Response to John C. Zimmerman on his ‘Body Disposal at Auschwitz’*”; [www.russgranata.com/Risposta-new-eng.html](http://www.russgranata.com/Risposta-new-eng.html), to which is also referred regarding the alleged cremation pits; see also [www.russgranata.com/jcz.html](http://www.russgranata.com/jcz.html).

<sup>5</sup> Carlo Mattogno, *Vierteljahreshefte für freie Geschichtsforschung* 7(2) (2003), ([vho.org/VffG/2003/2](http://vho.org/VffG/2003/2)) and *The Revisionist* 1(3) (2003) ([vho.org/tr/2003/3](http://vho.org/tr/2003/3)), both in preparation.

disposed of in the cremation facilities in those camps, then the ‘murder weapon’ – the homicidal gas chamber – has an essential counterpart: the cremation oven.

The ‘eyewitnesses’ have tried to persuade us that the crematoria ovens of Auschwitz and Birkenau were satanic contraptions operating above and beyond the realm of physical laws,<sup>6</sup> not ordinary cremation facilities subject to the same laws of chemistry, physics and heat engineering as all other such installations. Historians have chosen to trust blindly in these witnesses, and in the process have let themselves get carried away into making entirely erroneous claims.<sup>7</sup>

Aside from the Revisionists, Jean-Claude Pressac is the only researcher to have approached the historical problem of the cremation of bodies in Auschwitz and Birkenau from a technical perspective. In his book *Auschwitz: Technique and Operation of the Gas Chambers*<sup>8</sup> he comes to the following conclusions:

- The three double-muffle ovens in crematorium I of Main Camp Auschwitz had a capacity of 340 cremations in a 24-hour period.<sup>9</sup> In 1993, he reduced this figure down to 200-250 per day.<sup>10</sup>
- The five three-muffle ovens in crematoria II and III of Birkenau each had a maximum capacity of between 1,000 and 1,500 cremations per 24 hours,<sup>11</sup> but their normal capacity was 1,000 to 1,100 cremations each per 24 hours.<sup>12</sup> In 1993, he reduced this figure down to 800-1,000 per day.<sup>13</sup>
- The two eight-muffle ovens of crematoria IV and V each had a capacity of 500 cremations per 24 hours.<sup>14</sup>

Pressac thus puts the total capacity of the crematoria of Auschwitz and Birkenau at 3,540 cremations per day. From a technical perspective this figure is completely unrealistic.<sup>15</sup>

Among the Revisionists it was particularly Fred A. Leuchter who, in his well-known *Leuchter Report*,<sup>16</sup> turned his attention to the issue of the cremations. Relying primarily on the statements of

<sup>6</sup> We shall restrict ourselves to giving a single representative example. The eyewitness Dr. Miklos Nyiszli sets the daily cremation capacity of the crematoria of Birkenau at 20,000! M. Nyiszli, *Boncolóorvósa voltam az Auschwitz-i krematóriumban*, Világ, 1946, p. 38.

<sup>7</sup> As late as 1992 Franciszek Piper, historian at the Auschwitz Museum, claimed that the “*factual capacity*” of the four Birkenau crematoria had been “*up to 8,000 bodies per day*”. He based his assertion on the eyewitness testimony of Alter Feinsilber, *alias* Stanislaw Jankowski *alias* Alter Szmul Fajnzylberg; F. Piper, *Auschwitz. Wielecie Juden, Polen, Zigeuner... wurden umgebracht*, Universitas, Krakow 1992, p. 21.

<sup>8</sup> Jean-Claude Pressac, *Auschwitz: Technique and Operation of the Gas Chambers*, Beate Klarsfeld Foundation, New York 1989; similar in his later book *Les crématoires d’Auschwitz: La machinerie du meurtre de masse*, CNRS Editions, Paris, 1993.

<sup>9</sup> J.-C. Pressac, *Auschwitz:..., ibid.*, pp. 131, 158, 244.

<sup>10</sup> J.-C. Pressac, *Les crématoires..., ibid.*, p. 49, 80.

<sup>11</sup> J.-C. Pressac, *Auschwitz:..., ibid.*, pp. 179, 475.

<sup>12</sup> *Ibid.*, p. 244.

<sup>13</sup> J.-C. Pressac, *Les crématoires..., ibid.*, p. 39, 80.

<sup>14</sup> J.-C. Pressac, *Auschwitz:..., ibid.*, pp. 244, 384; J.-C. Pressac, *Les crématoires..., ibid.*, p. 80.

<sup>15</sup> Werner Wegner has devoted considerably more care to this problem than Pressac has, but the results of his study, which was published in very brief summary form, are even less well-founded in technical respects than the French historian’s. Wegner writes that in the Birkenau crematoria it was possible to cremate three bodies in one muffle in half an hour, which would have amounted to a capacity of 6,624 bodies per 24-hour period: W. Wegner, “*Keine Vergasungen in Auschwitz? Zur Kritik des Leuchter-Gutachtens*”, in U. Backes, E. Jesse, R. Zitelmann (eds.), *Schatten der Vergangenheit. Impulse zur Historisierung des Nationalsozialismus*, Ullstein-Propyläen, Frankfurt/M., Berlin 1990, p. 460 (online: [vho.org/D/dsdv/Wegner.html](http://vho.org/D/dsdv/Wegner.html)). Another superficial study of this topic was published by Fritjof Meyer in 2002: “*Die Zahl der Opfer von Auschwitz*”, *Osteuropa*, 52(5) (2002), pp. 631-641; see Carlo Mattogno, “*Auschwitz. The new Revisions by Fritjof Meyer*”, *The Revisionist*, 1(1) (2003), pp. 30-37 (online: [vho.org/tr/2003/1/Mattogno30-37.html](http://vho.org/tr/2003/1/Mattogno30-37.html)).

<sup>16</sup> Fred A. Leuchter, *An Engineering Report on the Alleged Gas Chambers at Auschwitz, Birkenau and Majdanek, Poland*, Samisdat Publishers Ltd., Toronto 1988(online: [www.zundelsite.org/english/leuchter/report1/leuchter.toc.html](http://www.zundelsite.org/english/leuchter/report1/leuchter.toc.html)).

Ivan Lagacé, the manager and operator of the Bow Valley Crematorium in Calgary, Canada,<sup>17</sup> Leuchter erroneously arrived at a figure of 156 bodies per day as the total cremation capacity of the crematoria of Auschwitz and Birkenau. This figure is actually far below the actual capacity.

Pressac and Leuchter arrived at conclusions which, though diametrically opposed, are equally unfounded because no serious, fundamental studies have been conducted of the crematoria ovens at Auschwitz and Birkenau, whether by the orthodox historians or by the Revisionists. We intend to close this debilitating gap.

### 3. Modern-Day Cremation

#### 3.1. The Technology of Crematoria Ovens Up To World War One

The cremation of dead bodies was practiced in Europe for more than a thousand years before Homer's time.<sup>18</sup> This custom was carried on until 785 AD, when Charlemagne forbade it, on pain of death, in his Decree of Paderborn.<sup>19</sup> In the following centuries cremation disappeared entirely from Christian Europe.

The idea of cremation regained some popularity during the French Revolution, but it was during the second half of the 19<sup>th</sup> century before it gradually found general acceptance.<sup>20</sup> The trend favoring cremation began to gain momentum in 1849, when the philologist Jakob Grimm gave a memorable lecture "*on the cremation of corpses*"<sup>21</sup> at the Berlin Academy of Sciences. The idea was quickly taken up by eager pioneers, and enthusiastically promoted.<sup>22</sup> The first cremation in a crematorium oven in Europe took place on October 9, 1874 in Dresden, in a makeshift oven designed by Friedrich Siemens. After a few cremations this experimental procedure was banned by the Saxon government.<sup>23</sup>

In those years, Italy was leading this modern movement for cremation, both legally and technologically. The first European crematorium was built in Milan in 1875, one year after cremation was recognized as a legal method for the disposal of the dead.<sup>24</sup> The first German crematorium was put into operation in Gotha on December 10, 1878. This period saw a great fervor of studies and experiments that led to the construction of several types of furnaces. Modern cremation had to satisfy certain ethical, aesthetic, and economic requirements, which were defined during a general conference on cremation technology held June 7, 1876 in Dresden.

<sup>17</sup> Barbara Kulaszka (ed.), *Did Six Million Really Die? Report on the Evidence in the Canadian "False News" Trial of Ernst Zündel – 1988*, Samisdat Publishers Ltd., Toronto 1992, p. 267 (online: [www.zundel.org/english/dsmrd/dsmrdtoc.html](http://www.zundel.org/english/dsmrd/dsmrdtoc.html)).

<sup>18</sup> Carl Schuchhardt, "*Die Anfänge der Leichenverbrennung*", in *Sitzungsberichte der Preussischen Akademie der Wissenschaften. Philosophisch-Historische Klasse*, 1920, p. 502.

<sup>19</sup> *Capitulare Paderbrunnense*; see Max Pauly, *Die Feuerbestattung*, Verlagsbuchhandlung J. J. Weber, Leipzig 1904, p. 8.

<sup>20</sup> B. Reber, "*Un crématoire du temps de la révolution française*", in *Société de crémation de Genève*, Bulletin VIII, Imprimerie Centrale, Geneva 1908, pp. 26-29.

<sup>21</sup> The lecture titled "*Über das Verbrennen von Leichen*" (On the Cremation of Corpses) was published that same year.

<sup>22</sup> E.g., by military physicians like J.P. Trusen, Prof. Moleschott, Prof. Richter, Prof. Reclam und Prof. Küchenmeister. For the beginnings of modern cremation, the reader is referred to the two works already cited, as well as to F. Küchenmeister, *Über Leichenverbrennung*, lecture given on April 8, 1874 for the Neustädter Gymnasial-Stipendienfond, Verlag von Ferdinand Enke, Erlangen 1874; P. de Pietra Santa, *La crémation des morts en France et à l'étranger*, Librairie J.-B. Baillière et Fils, Paris 1874; P. de Pietra Santa, *Modern Cremation*, Publication de la Société Française d'Hygiène; au bureau de la Société, Paris 1889; Rudolph Müller, "*Über Leichenverbrennung*", offprint from: *Medizinische Jahrbücher*, v. 199, issue 1, Vienna 1883; Henry Tompson, *Die moderne Leichenverbrennung*, Fischers Medizinische Buchhandlung, Berlin 1899; K. Weigt, *Almanach der Feuerbestattung*, self-pub. by author, Hannover 1909.

<sup>23</sup> M. Pauly, *op. cit.* (note 19), p. 18.

<sup>24</sup> G. Pini, *La crémation en Italie et à l'étranger de 1774 jusqu'à nos jours*, Ulrich Hoepli Editeur Libraire, Milan 1885, pp. 16, 30, 130f. An extremely precise description of the facility is provided by Wegmann-Ercolani in their small publication *Über Leichenverbrennung als rationellste Bestattungsart*, Cäsar Schmidt, Zürich 1874, pp. 30-33.



Many cremation facilities of the 1870s were as yet very unreliable and costly to operate – some had cremation times of up to 5-6 hours per corpse –, so that some were torn down again after just a few cremations. But much better capacities and fuel efficiencies were quickly reached: The Gorini oven at Riolo, for instance, which started operation on September 6, 1877, needed only 100-150 kg (220-330 lbs) and 1.5-2h per corpse. The oven by Toisoul and Fradet needed ca. 100 kg and just one hour per corpse.<sup>25</sup> In these ovens, the body was directly exposed to the flames, which were produced either by the incineration of the fuel or by combustion of the fuel gases from the gas generator.

A principle devised by Friedrich Siemens introduced the process of wholly indirect cremation using heated air, allowing only hot air but no flame gases to reach the body. This method predominated unchallenged in Germany until 1924. In this new procedure, cremation was performed by means of air heated to 1000°C (1830°F) in a regenerator or recuperator.<sup>26</sup> The experimental prototype of such an oven was installed in 1878 in Gotha and was used for the cremation of animal carcasses only. A cremation took 135 minutes on average; the first cremation required 1,500 kg (3,300 lbs) of brown coal, subsequent ones took from 250 to 300 kg (550 to 660 lbs) or less, with the requirements decreasing step by step.<sup>27</sup>

The Swedish Klingenstierna oven was a distinct improvement over the Siemens oven. Besides a main firing, it had a secondary firing that served mostly to burn off the remaining gases and smoke particles; the combustion air was heated in a recuperator consisting of metal baffles (heat exchanger between the furnace gas and the combustion air); the body was introduced into the incineration chamber on a small cart that remained there for the entire duration of the cremation cycle. In Germany this system was perfected by E. Dorovius and built by the firm of Gebrüder Beck in Offenbach. The first models, which were installed in the crematoria of Heidelberg (1891) and Jena (1898), still retained a cart for introduction of the body, but the 1899 model (Offenbach crematorium) worked without a cart, and the incineration chamber was replaced by a grating of refractory grilles beneath which two sloping surfaces angled like a funnel channeled the ash into the ash pit.<sup>28</sup> The metal type of recuperator was gradually replaced by one with refractory brick, and the oven took on the typical structure of the German crematoria ovens with coke-fired gas generator.

A prototype of the Schneider furnace was installed in the crematorium of Hamburg in 1892. Its structure was similar to that of the Klingenstierna-Beck oven with some improvements to the gas generator. It took approximately three hours to get this oven to an operational temperature. The duration of a single cremation was between 45 and 90 minutes, with a coke consumption of 250-300 kg (550-660 lbs) for the first and 50-100 kg (110-220 lbs) for subsequent cremations. The Rupp-

<sup>25</sup> G. Pini, *op. cit.* (note 24), p. 132. Unless otherwise noted, the following information is taken from this work (pp. 128-171). Cf. also Malachia de Cristoforis, *Etude pratique sur la crémation*, Imprimerie Treves Frères, Milan 1890, pp. 56-135; P. de Pietra Santa, M. de Nansouty, “La crémation”, in *Le génie civil*, nos. 8-12, 1881; Luigi Maccone, *Storia documentata sulla cremazione presso i popoli antichi e moderni con speciale riferimento alla igiene*, Istituto Italiano d’Arti grafiche, Bergamo 1932, pp. 102-124; Fritz Schumacher, *Die Feuerbestattung*, J. M. Gebhardt’s Verlag, Leipzig 1939, pp. 18-32.

<sup>26</sup> F. Küchenmeister, *Die Feuerbestattung. Unter allen zur Zeit ausführbaren Bestattungsarten die beste Sanitätspolitik des Bodens und der sicherste Cordon gegen Epidemien*, Verlag von Ferdinand Enke, Stuttgart 1875, pp. 70f.

<sup>27</sup> Wilhelm Heepke, *Die Leichenverbrennungsanstalten (die Krematorien)*, Verlag von Carl Marhold, Halle a.S. 1905, p. 20. This work contains a very detailed description of the Siemens, Klingenstierna and Schneider ovens, with extraordinarily precise diagrams (pp. 41-58). For these ovens, cf. the publications cited in this work, as well as E. Beutinger, *Handbuch der Feuerbestattung*. Carl Scholze Verlag, Leipzig 1911; Karl von Engerth, *Fortschritte der Feuerbestattung in Deutschland. Vortrag gehalten in der Hauptversammlung des Vereins der Freunde der Feuerbestattung “Die Flamme” in Wien am 19. Februar 1892*, Verlag von Moritz Perles, Vienna 1892; Karl von Engerth, *Die Feuerbestattung*, self-pub. by author, Vienna 1897; Hermann Ortloff, *Gleichberechtigung der Feuer- und Erdbestattung*, Felix Dietrich, Leipzig 1907. In the appendix: the cremation system of Richard Schneider, formerly Dresden, now Berlin, pp. 60-73.

<sup>28</sup> W. Heepke, *op. cit.* (note 27), p. 45-55.

mann furnace had already the typical structure of a modern coke-fired crematorium oven.<sup>29</sup> According to experimental data taken at the crematorium of Stoccarda during 48 cremations between July 20 and September 15, 1909, a cremation lasted in average 1h 33min, with a minimum of 1h 10min and a maximum of 2h 30min.<sup>30</sup>

The oven designed by the Swedish firm Knös introduced some more improvements to the Klingenstierna-Beck system. Its coke consumption for the heating and the first incineration was 300 kg and 50-90 kg for each subsequent cremation. In Germany, the company Gebrüder Beck of Ofenbach produced this oven under a license contract.

### 3.2. Technological Progress and Developments in the Inter-War Years

After the First World War, the peace dictate of Versailles forced Germany to give up coal-rich regions as well as to supply coal to the victorious powers. Hence, Germany saw herself forced to use the coal reserves left to her as efficiently as possible. For these reasons, German industry endeavored to redesign, in terms of heat engineering, all facilities consuming coal and coal products so as to maximize the return achieved per unit of fuel consumption.

Crematoria ovens and their operation were by no means exempt from this need for the thrifty use of coal. Consequently, a Prussian law dating from September 14, 1911 was amended in 1924; this law had permitted only the wholly indirect cremation of bodies, for aesthetic reasons, but this process required more time and fuel than its alternative.<sup>31</sup> The debate about this amendment was accompanied by at times heated arguments among the cremation experts, disputing which of the two methods was the more economic one.<sup>32</sup> This question could be resolved only by means of scientific cremation experiments. The most significant experiments of this period were carried out in 1926 and 1927 in the crematorium of Dessau by the engineer Richard Kessler, who also wrote a detailed scientific report on the subject.<sup>33</sup> In the following we shall examine the results of these experiments.

The construction method of the new ovens took into account the decisive factors involved in the optimum use of combustion heat that engineer Kessler had discovered in his experiments. As a result the efficiency of the oven increased considerably. The most important technological innovations of that time include the reduction of the horizontal cross-section of the gas generator; more efficient recuper-

<sup>29</sup> Hans Keller, *Mitteilungen über Versuche am Ofen des Krematoriums in Biel*. Bieler Feuerbestattungs-Genossenschaft in Biel. Jahresbericht pro 1927/28, Biel 1928.

<sup>30</sup> R. Nagel, *Wege und Ziele der modernen Feuerbestattung*. Verlag Wilhelm Ruppmann, Stuttgart 1922, p. 36.

<sup>31</sup> Engineer H. Kori, "Bau und Betrieb von Krematorien. 1. Neue Wege und Ziele", *Die Wärmewirtschaft*, no. 8, 1924, pp. 115-119; H. Kori, "Bau und Betrieb von Krematorien. 2. Gutachten der Arbeitsgemeinschaft für Brennstoffersparnis", *Die Wärmewirtschaft*, no. 8, 1924, pp. 119f.

<sup>32</sup> Corporate pub., "Bau und Betrieb der Krematorien", *Die Wärmewirtschaft*, no. 7, 1925, pp. 107f.; "Bau und Betrieb der Krematorien. Erwiderung auf den Einspruch des Verbandes der Preußischen Feuerbestattungsvereine vom 9. Oktober 1925 gegen den Erlaß des Herrn Ministers des Innern – II T 2015 – vom 24. Oktober 1924", *Die Wärmewirtschaft*, no. 1, 1926, pp. 9-12; Corporate pub., "Betr. Ofenanlage in Krematorien", *Die Wärmewirtschaft*, no. 3, 1927, p. 51; Chief Engineer H. Tilly, "Über die Wirtschaftlichkeit von Anlagen zur Einäscherung menschlicher Leichen", *Die Wärmewirtschaft*, no. 9, 1926, pp. 143ff.; Chief Engineer A. Peters, "Die Wirtschaftlichkeit von Anlagen zur Einäscherung menschlicher Leichen", *Die Wärmewirtschaft*, no. 11, 1926, pp. 176ff.

<sup>33</sup> Richard Kessler, "Rationelle Wärmewirtschaft in den Krematorien nach Maßgabe der Versuche im Dessauer Krematorium", *Die Wärmewirtschaft*, nos. 8-11, 1927. Abbrev. version: "Rationelle Wärme-Wirtschaft in Krematorien unter besonderer Berücksichtigung der Leuchtgasfeuerung", *V. Jahrbuch des Verbandes der Feuerbestattungsvereine Deutscher Sprache 1930*, Königsberg 1930. It is also worth mentioning the experiments which engineer Hans Keller performed in 1927 in the crematorium of Biel, Switzerland, with an oven with coke-fired gas generator: Hans Keller, "Mitteilungen über Versuche am Ofen des Krematoriums in Biel", in Bieler Feuerbestattungs-Genossenschaft in Biel (Schweiz) (ed.), *Jahres-Bericht pro 1927-28*, Biel 1929. Cf. also Hans Keller, "Versuche an einem Feuerbestattungssofen", offprint from *Archiv für Wärmewirtschaft und Dampfkesselwesen*, yr. 10, issue 6, 1929.

ators; the installation of an afterburning grate; an air intake system to allow for more efficient afterburning; and the installation of appropriate measuring instruments.<sup>34</sup>

In the early 1930s the coke-fired ovens with gas generator had reached the pinnacle of technological perfection, yet at the same time their inexorable decline began as they were being increasingly supplanted by significantly more economic heating systems, particularly ones using gas and electricity. From this point on, the existing coke-fired ovens were either torn down<sup>35</sup> or restructured to accommodate gas heating.<sup>36</sup> The new heating systems necessitated additional studies on the structure of the ovens as well as on the phenomenon of cremation *per se*, and these studies were presented in significant technical publications.<sup>37</sup>

Even though the first German crematorium had already been built in 1878, cremation was not legally permitted until 1911 and it took until the 1930s before formal legislation on this matter actually appeared. The first real and complete Cremation Act was passed on March 15, 1934. Specific guidelines pertaining to the cremation ovens and the cremation process followed soon thereafter.<sup>38</sup>

As the following table shows, the number of cremations in Germany rose astronomically between the time when the first crematorium was opened, and the beginning of the Second World War:<sup>39</sup>

PERIOD	# OF CREMATORIA	# OF CREMATIONS	ANNUAL AVERAGE # OF CREMATIONS
1878-1887	1	496	50
1888-1897	2	2,192	219
1898-1907	15	12,382	1,238
1908-1917	51	88,687	8,869
1918-1927	81	283,976	28,398
1928-1937	118	628,600	62,860

In 1938, 84,634 cremations were performed in 120 crematoria;<sup>40</sup> in 1939 there were 102,112 cremations; in 1940, 108,130; in 1941, 107,103; and in 1942, 114,184.<sup>41</sup>

<sup>34</sup> Friedrich Hellwig, "Vom Bau und Betrieb der Krematorien", *Gesundheits-Ingenieur*, yr. 54, issue 24, 1931, p. 372; Chief Engineer Peters, "Winke für den Betrieb von Einäscherungsanlagen", *Zentralblatt für Feuerbestattung*, yr. 2, 1930, no. 4, pp. 56f.

<sup>35</sup> For example, the old coke oven of the crematorium at Dortmund was dismantled in 1937/38 and replaced with two new ovens of the Volckmann-Ludwig system: Hermann Kämper, "Der Umbau der Leichenverbrennungsöfen und die Einrichtung von Leichenkühlräumen auf dem Hauptfriedhof der Stadt Dortmund", *Gesundheits-Ingenieur*, yr. 64, issue 12, 1941, pp. 171-176.

<sup>36</sup> Engineer Dr. Repky, "Der Umbau koksgefeuerter Krematoriumsöfen auf Leuchtgasbeheizung", *Gesundheits-Ingenieur*, yr. 55, no. 42, 1932, pp. 506-509.

<sup>37</sup> Of the most important technical articles, we would cite: Friedrich Hellwig, *op. cit.* (note 34), in abbreviated form: "Vom Bau und Betrieb der Krematorien", *Zentralblatt für Feuerbestattung*, yr. 4, no. 1, 1932, pp. 8-14; Paul Schläpfer, "Über den Bau und den Betrieb von Krematoriumsöfen", separate reprint from *Jahresbericht des Verbandes Schweizerischer Feuerbestattungsvereine*, Zürich 1937; P. Schläpfer, "Betrachtungen über den Betrieb von Einäscherungsöfen", *Schweizerischer Verein von Gas- und Wasserfachmännern, Monatsbulletin*, yr. XVIII, no. 7, Zürich, July 1938; Richard Kessler, "Entwicklung und Zukunftswege der Einäscherungstechnik", *Zentralblatt für Feuerbestattung*, yr. 3, no. 6, 1931, pp. 83-89; R. Kessler, "Die wärmewirtschaftliche Ausnutzung der Abgase bei Einäscherungsöfen", *Zentralblatt für Feuerbestattung*, yr. 5, no. 2, 1935, pp. 21-26; Viktor Quehl, "Feuerbestattung und Einäscherungsöfen", *Gesundheits-Ingenieur*, yr. 59, no. 38, 1936, pp. 559ff.

<sup>38</sup> "Betriebsordnung für Feuerbestattungsanlagen" of Nov. 5, 1935, as well as the "Verordnung zur Durchführung des Feuerbestattungsgesetzes" of August 10, 1938, reprinted in Fritz Schumacher, *op. cit.* (note 25), pp. 116-121; *Veröffentlichungen des Großdeutschen Verbandes der Feuerbestattungsvereine*, no. 5, self-pub. by the organization, Königsberg/Prussia 1932. These guidelines were also published in *Zentralblatt für Feuerbestattung*, yr. 5, no. 6, 1933, pp. 87-92; *Richtlinien für den Bau und Betrieb von Öfen zur Einäscherung menschlicher Leichen, aufgestellt vom Großdeutschen Verbands der Feuerbestattungsvereine e.V.*, Verlag der Verlagsabteilung des Großdeutschen Verbandes der Feuerbestattungsvereine e.V., Berlin 1937.

<sup>39</sup> *Die Feuerbestattung*, yr. XI, 1939, pp. 8f.

<sup>40</sup> *Ibid.*, yr. XII, 1940, p. 14.

<sup>41</sup> *Ibid.*, yr. XVI, 1944, p. 17.

### 3.3. J. A. Topf & Söhne, Erfurt

Where crematoria ovens are concerned, the firm of J. A. Topf & Sons of Erfurt began manufacturing operations at the start of the First World War and was most notably successful in the early 1920s.<sup>42</sup> Their early models pioneered several innovations, particularly a system of exterior muffle heating, based on a patent by Max J. Kergel.<sup>43</sup> This prevented the cremation products from entering the muffle, thus allowing for an entirely indirect cremation process.

This cremation oven consisted of a coke generator; a self-contained cremation chamber (muffle); a system of baffles underneath (recuperator), which served to preheat the air required for the cremation; and the diversion of the carbon monoxide gases around the muffle.<sup>44</sup> The ovens built during the 1920s needed 60 to 75 minutes and consumed some 160 to 260 kg (350 to 570 lbs) of coke per cremation.<sup>45</sup>

During the 1920s, the firm of J. A. Topf & Sons became Germany's foremost commercial oven manufacturer. Between 1922 and 1927, no less than 18 of the 24 ovens installed in the German crematoria were built by Topf.<sup>46</sup> In the early 1930s Topf's commercial supremacy was consolidated.<sup>47</sup> By now Topf & Sons had achieved a very advanced technological level. They deserve the credit for designing Germany's first fully functional gas-heated cremation oven (1927, in Dresden), as well as the country's first electric cremation oven, which came into service in Erfurt in 1933. The firm also pioneered improvements in cremation technology such as the afterburning grate and the rotating grate.

Even though the electric Topf ovens had no competition in Germany, the company's supremacy in the oven manufacturing field was seriously threatened in those years by the newly developed gas oven of the Volckmann-Ludwig type.<sup>48</sup> In technological respects, the Topf firm responded to the competition posed by the new oven by designing a Model 1934 gas oven.<sup>49</sup> In propagandistic terms they re-

<sup>42</sup> *Phoenix. Blätter für fakultative Feuerbestattung und verwandte Gebiete*, Vienna, no. 10, 1915, p. 296; *ibid.*, no. 4, 1916, pp. 97ff.

<sup>43</sup> Reichspatentamt (Imperial Patent Office), Patent No. 218581. Class 24d. Issued on February 8, 1910. Max J. Kergel in Beuthen, O.-S. *Leichenverbrennungsöfen mit Rekuperator*. Patented in the German Reich as of October 4, 1908.

<sup>44</sup> Balduin Reichenwallner, *Tod und Bestattung*, Katakomben-Verlag / Balduin Reichenwallner, Munich 1926, pp. 28f.

<sup>45</sup> *Öfen für Krematorien System Topf. J. A. Topf & Söhne Erfurt. Maschinenfabrik und feuerungstechnisches Baugeschäft*, publicity leaflet pub. 1926.

<sup>46</sup> *IV. Jahrbuch des Verbandes der Feuerungsbestattungs-Vereine Deutscher Sprache 1928*. Pub. on the occasion of the 22<sup>nd</sup> Association Conference on July 4-8 in Bremen, by the Association Board, Königsberg/Prussia 1928, p. 84.

<sup>47</sup> F. Hellwig, *op. cit.* (note 34), p. 370.

<sup>48</sup> Regarding the electric Topf oven, see Konrad Weiss, "Der erste deutsche elektrisch beheizte Einäscherungsöfen im Krematorium Erfurt", *Gesundheits-Ingenieur*, yr. 57, no. 37, Sept. 15, 1934, pp. 453-457; "Elektrisch betriebener Topf-Einäscherungsöfen D.R.P. angem.", *Zentralblatt für Feuerbestattung*, yr. 7, no. 6, 1935, pp. 88ff.; Konrad Weiss, "Die Entwicklung des elektrisch beheizten Einäscherungsöfens im Krematorium Erfurt", *Gesundheits-Ingenieur*, yr. 60, no. 11, 1937, pp. 159-162; Fritz Schumacher, *op. cit.* (note 25), pp. 28ff.; Rudolf Jakobskötter, "Die Entwicklung der elektrischen Einäscherung bis zu dem neuen elektrisch beheizten Heißlufteinäscherungsöfen in Erfurt", *Gesundheits-Ingenieur*, yr. 64, no. 43, 1941, pp. 579-587. First European cremation oven with electric heating came into service in Biel, Switzerland, on Aug. 31, 1933; cf. Hans Keller, "Der elektrische Einäscherungsöfen im Krematorium Biel", in Bieler Feuerbestattungs-Genossenschaft in Biel (ed.), *Jahresbericht pro 1933*, Biel 1934; Hans Keller, *Der elektrische Ofen im Krematorium Biel*, Graphische Anstalt Schühler A.G., Biel 1935. This experimental oven was gradually perfected by the firm of BBC Brown Boveri, which did not have a large market in Germany; cf. G. Keller, *Die Elektrizität im Dienste der Feuerbestattung*, Aktiengesellschaft Brown, Boveri & Cie, special offprint from the Brown Boveri "Mitteilungen", no. 6/7, Baden (Switzerland) 1942. Regarding the Volckmann-Ludwig oven, cf. accredited engineer Hans Volckmann, "Ein neues Einäscherungsverfahren", *Zentralblatt für Feuerbestattung*, yr. 3, no. 4, 1931; H. Volckmann, "Der neue Einäscherungsöfen System Volckmann-Ludwig", *Zentralblatt für Feuerbestattung*, yr. 3, no. 4, 1931; H. Volckmann, "Das Volckmann-Ludwig-Verfahren und die Kesslerschen Richtlinien", *Zentralblatt für Feuerbestattung*, yr. 6, no. 8, 1934; H. Wolfer, "Der neue 'Volckmann-Ludwig'-Einäscherungsöfen im Stuttgarter Krematorium", *Gesundheits-Ingenieur*, yr. 55, no. 13, 1932.

<sup>49</sup> Hugo Etbach, *Der technische Vorgang bei einer Feuerbestattung*, Druck Johannes Friese, Cologne 1935, pp. 3ff. Regarding the gas-fired Topf oven cf. also F. Schumacher, *op. cit.* (note 25), pp. 25ff.

sponded with rather harsh polemics in the form of a most aggressive article by engineer Kurt Prüfer,<sup>50</sup> the man who would design the three- and eight-muffle ovens of Birkenau; the criticism advanced in that article, however, was refuted by Richard Kessler.<sup>51</sup>

### 3.4. Structure and Operation of coke-fired cremation ovens of the 1930s

This type of furnace consisted of a gas generator, an incineration room or muffle, a post-combustion chamber below it, and a recuperator thereafter. The gas generator, lined with refractory material, had the usual grill for the coke and openings to regulate air intake and to remove ashes and cinders. A vertical or oblique channel conducted the combustion gases into the muffle. As a result of lack of oxygen, the coke burnt only partly in the gas generator, producing carbon monoxide rich gases which were led into the muffle, where it burnt with additional pre-heated air coming in from the recuperator.

The muffle was a horizontal combustion chamber lined with refractory material. The German “*Norms for the construction and operation of furnaces for the cremation of human corpse*” enacted in 1937 prescribed the following minimal measures for such a muffle: width: 900 millimeter; height: 900 millimeter; length: 2500 millimeter.<sup>52</sup>

At the front, the muffle was closed with a guillotine-like shutter made of fireclay. In front of this shutter was an outer metal door. The bottom of the muffle consisted of a grill made of fireclay, on which the coffin was placed. The remains of the body fell through the refractory grilles into the post-combustion chamber with slanted walls narrowing down to a small cavity in which the container for the ashes was placed.

Openings in the post-combustion chamber led the combustion gases into the recuperator, which is a heat exchanger consisting of intertwined, counter-current fresh-air intake and exhaust gas exit channels. As a result of this heat exchange, the recuperator had temperatures between 400 and 600°C. The oven was a two-level structure: the gas generator and recuperator were at a lower level, while the incineration chamber was at an upper level.

The operation of this system was as follows: First, the shutter of the smoke flue was opened. Then, the coke fire in the generator was lit with the help of some wood. As soon as the combustion gases burning in the muffle had increased the temperature to an operational level, the introduction shutter was opened and the coffin was introduced in the muffle. Because of the high temperature of the muffle, the coffin caught fire already during the introduction. It burned quickly, leaving the corpse on the grill. First, the corpse dehydrated, then the combustible parts incinerated. The solid incineration products of the corpse fell into the post-combustion chamber and ultimately into the ash container, while the gaseous products moved into the side flues of the recuperator and down through them into the waste-gas flue, whence they rose up the stack. When the flame development had stopped, the incandescent ashes were scrapped into the ash container. The oven was operated with the help of various controls (fuel supply, recuperator and generator air intake, exhaust shutter).<sup>53</sup>

### 3.5. The Coke Consumption of a Cremation Oven with Coke-Fired Generator

A cremation oven’s fuel consumption depends in the main on the manner of the oven’s construction, the cremation process, the frequency of cremations, the state of the bodies, and the operation of the oven. For this reason it is pointless to speak of an oven’s fuel consumption without considering at

---

<sup>50</sup> Kurt Prüfer, “*Ein neues Einäscherungsverfahren. Eine Entgegnung*”, *Die Flamme*, yr. 40, 1931, pp. 5f.; for the polemics in company correspondence, cf. also Weimar State Archives, 2/555a.

<sup>51</sup> R. Kessler, “*Der neue Einäscherungssofen System Volckmann-Ludwig*”, *Zentralblatt für Feuerbestattung*, 3(3) (1931).

<sup>52</sup> *Richtlinien für den Bau von Öfen zur Einäscherung menschlicher Leichen* aufgestellt vom Großdeutschen Verbands der Feuerbestattungsvereine, in: *Zentralblatt für Feuerbestattung*, 5. Yr., No. 6, 1933, p. 4.

<sup>53</sup> See in particular E. Beutinger, *op. cit.* (note 27), pp. 94-127.

least the following three factors: the oven's construction system, the manner of cremation (direct or indirect), and the frequency with which cremations are carried out.

The procedure involved in indirect cremation is much more fuel-intensive than that of direct cremation, since the former requires that the entire fireproof mass of the recuperator be heated to 1000°C (about 1830°F). The frequency of cremations has a very significant effect on fuel consumption, since the oven's firebrick absorbs most of the heat generated during the first cremations. For this reason fuel consumption is lowest when the oven is operating at thermal equilibrium.

The heat balance of a cremation oven with coke-fired generator is a problem, very difficult to resolve in theory, since in practice the performance is affected by variable factors which cannot be predicted by theory and which affect the operation of the oven from case to case.

In the 1920s this problem was discussed by scientists like Fichtl<sup>54</sup> and Tilly,<sup>55</sup> but the most important contribution to its resolution was Wilhelm Heepke's 1933 article on this subject.<sup>56</sup>

Heepke's calculations showed that the per-cremation coke consumption of a medium-sized oven at thermal equilibrium amounts to 30 kg (66 lbs) of coke (plus the wooden coffin weighing 40 kg, or 88 lbs). However, Heepke's findings are marred by errors both in approach and in arithmetic, and his conclusions are thus questionable. If one takes his errors into account, one arrives at a coke requirement of 20.5 kg (45.1 lbs). This result is consistent with those of experimental origin. The experiment conducted by R. Kessler with coke fuel on January 5, 1927, indicated the following fuel consumption:

- total consumption: 436.0 kg (960 lbs) coke
- preheating of the oven: 200.0 kg (440 lbs) coke
- 8 successive cremations: 236.0 kg (520 lbs) coke
- consumption for 1 cremation, including preheating: 54.5 kg (120 lbs) coke
- consumption for 1 cremation without preheating of the oven: 29.5 kg (65 lbs) coke

The fuel consumption relating to the eight cremations exclusive of the preheating of the oven still includes the consumption producing the heat that is absorbed by the oven's firebrick up to the point where thermal equilibrium is reached. A calculation to take into account the heat loss caused by radiation and conduction shows that the coke consumption for a cremation in an oven at thermal equilibrium is about 20 kg (44 lbs).

This confirms the correctness of this method of calculation, which can thus also be used to determine the thermal balance of the cremation ovens of Auschwitz and Birkenau.

### 3.6. The Duration of the Cremation Process with a Coke-Fired Generator

Cremation is a physical and chemical process requiring a certain minimum time that cannot be decreased further.<sup>57</sup> This minimum time depends in the main on the chemical composition of the body to be cremated. As special experiments conducted in England in the 1970s showed, the body's protein structure is of great importance. Due to its relatively high nitrogen content, its high ignition temperature and the chemical transformations which the proteins undergo at high temperatures, there is a considerable degree of resistance to combustion, which is amplified further by the fact that the protein substance is submerged, as it were, in body fluid and cannot ignite before this fluid has evaporated. In

<sup>54</sup> Engineer Fichtl, "Rationelle Wärmewirtschaft in den Krematorien", *Die Wärme, Zeitschrift für Dampfkessel und Maschinenbetrieb*, 17(34) (1924), pp. 394-397.

<sup>55</sup> H. Tilly, "Luftüberschuß und Brennstoffverbrauch bei der Einäscherung menschlicher Leichen", *Die Wärmewirtschaft*, 3(2) (1926), pp. 190f.; H. Tilly, "Versuch einer rechnermäßigen Erfassung der Vorgänge der Einäscherung menschlicher Leichen", *Die Wärmewirtschaft*, 3(8) (1926), pp. 134ff.; H. Tilly, *op. cit.* (note 32); H. Tilly, "Über die Einäscherung menschlicher Leichen", *Die Wärmewirtschaft*, 4(2) (1927), pp. 19-25.

<sup>56</sup> "Die neuzeitlichen Leicheneinäscherungsöfen mit Koksfeuerung, deren Wärmebilanz und Brennstoffverbrauch", *Feuerungstechnik*, yr. XXXI, 1933: issue 8, pp. 109ff., and issue 9, pp. 123-128. This is a consolidated version of the study on thermal equilibrium which engineer Heepke had presented in his aforementioned book, *op. cit.* (note 28), pp. 60-63.

<sup>57</sup> Cf. Hans Kraupner, Franz Puls, *Die chemischen Vorgänge bei einer Einäscherung*, special offprint from *Städtehygiene*, Ulzen 8/1970.

other words: A cremation carried out under optimum conditions cannot take less time than the time perforce required for this process to take place.

Conversely, the duration of the cremation cycle increases, of course, the more that actual conditions are removed from the optimum, regardless of whether this discrepancy is due to careless operation of the oven or to a less-than-ideal oven construction system.

Before raising the question of the length of the cremation process or the cremation cycle, we must clarify just exactly what we mean by that. In very general terms, we can say that a cremation is completely finished once the ashes remaining of the body have been removed from the oven. For an oven not equipped with an afterburning grate, the cremation time may be defined as the time between the introduction of the coffin into the muffle and the transfer of the glowing ashes from the ash slope into the ash container, in which they gradually collapse altogether. In an oven equipped with an afterburning grate, such as the generator ovens of Beck and Topf and the Volckmann-Ludwig gas ovens of the 1930s, the end of the cremation process is set as the time at which the glowing ashes are removed from the ash slope or transferred from the bottom of the muffle to the afterburning grate.

Even though it violated the ethical norms set by R. Kessler in 1932, it was common practice in some crematoria to introduce the next body into the muffle while the remnants of the previous still burned on the ash slope, so that one oven actually contained two bodies at the same time, albeit at different stages of the cremation cycle. This process was used in ovens such as the Volckmann-Ludwig type in Stuttgart, which were equipped with a damper in the ash settling chamber.

As we have already mentioned, scientific experiments were carried out in England in the 1970s to determine which factors influence the cremation process. The results were announced in July 1975 at the annual conference of the Cremation Society of Great Britain. The experiments were grouped into two series: an introductory series in Ruislip's Breakspear Crematorium and the main series in Hull's Chanterlands Crematorium. The first group of project leaders selected the factors that, in their opinion, would affect the length of the cremation process. The influence of technical factors was equalized by using the same gas-fired oven (Dowson & Mason Twin Reflux Cremator) and the same heater for all experiments.<sup>58</sup>

On the basis of these experiments it was found that the truly decisive factors, where the time required for a cremation is concerned, are the maximum temperature of the oven and the sex of the deceased. Statisticians graphically summarized the results of the experiments. One of the analysts, Dr. E. W. Jones, commented as follows:<sup>58</sup>

*"From his graph he was able to tell us (we thought this rather interesting) that there is a maximum point, or rather a minimum point, of incineration time below which it is impossible to go, and our statistician defined this as a thermal barrier that, because of the make, the nature of human tissues, you cannot incinerate them at a rate which is below round about 63 minutes. Now some people will come up with readings of 60, 59, 58, they are the lower ends of this scatter of readings, and that this thermal barrier's optimum temperature is round about 800-900°C."*

The graph shows that the time that most closely approximates the thermal barrier is 60 minutes, given a temperature of 800°C (1470°F). If the temperature is increased to 1000°C (1830°F), the time required for cremation increases to 67 minutes, and at 1100°C (2010°F) it drops again, to 65 minutes. At higher temperatures, which were not investigated, the time would presumably decrease further, and at extremely high temperatures it probably drops below the thermal barrier. Dr. Jones stated that if one wanted to decrease the cremation time in this way to 20 or even to 15 minutes, one would have to construct an oven capable of working at 2000°C (3630°F).<sup>58</sup>

In reality, the cremation process must take place between fairly precise thermal boundaries. At temperatures of over 1100 to 1200°C (2010 to 2190°F) one encounters the phenomenon of sintering, where the bones of the corpse and the oven refractory begin to soften and to melt together (fuse), and

---

<sup>58</sup> "Factors which affect the process of cremation", Third Session, by Dr. E. W. Jones, assisted by Mr. R. G. Williamson, from: *Annual Cremation Conference Report*, Cremation Society of Great Britain, 1975, p. 81.

at temperatures under 700 to 600°C (1290 to 1110°F) the body merely chars.<sup>59</sup> Dr. E. W. Jones then reports an observation of particular interest to us:<sup>58</sup>

*“Our statistician colleague did some work, he looked into the records of crematoria in Germany during the last war, and it would appear that the authorities there were presented with a similar problem – that they came up against a thermal barrier. They could not design a furnace that reduced the mean incineration time to a very practical effective level. So we started to look at why there is this thermal barrier with human tissues.”*

It was found that the cause of this factor was that the proteins in the human body – when they are heated to 800 to 900°C (1470 to 1650°F) – undergo a chemical transformation. They dissociate and form compounds *“that can only be described as a hard crust.”*<sup>58</sup>

Naturally the cremation process took longer in ovens operating with a coke-fired gas generator. Regarding the time required for the cremation cycle, the data to be found in contemporaneous literature is almost never entirely reliable, first and foremost because what is meant by ‘the time required’ is very rarely clearly defined, and secondly because one must expect that the data have been distorted for reasons of competition or propaganda.

This is why we shall take data supplied by the technical measuring instruments in the ovens themselves as our objective and incontrovertible starting point. From this perspective, the diagram summarizing the cremations performed by R. Kessler with coke fuel on January 5, 1927, is especially significant. This was a case where one is completely justified in saying that the cremations were carried out under the optimum conditions for an oven with a gas generator, because:

- the construction system of the oven was excellent;
- Kessler had taken every measure necessary to prepare the oven in terms of heat engineering;
- the appropriate technical instruments were used to observe the cremation cycle in every phase;
- under the knowledgeable supervision of an expert engineer the operation of the oven went off especially smoothly.

During these experiments the average cremation time was 1 hour and 26 minutes, while the shortest cremation took 1 hour. The average temperature in the muffle was about 870°C (1600°F). We shall return to this point later. In this context it is important to stress that engineer Kessler was using the method of direct cremation. For comparison we refer to a different series of eight cremations that Kessler performed in the same oven, using briquettes instead of coke fuel. That time the average cremation took 1 hour and 22 minutes. Two weeks later the same experiment, using gas heating for the oven, returned an average cremation time of 1 hour and 12 minutes for each of the eight cremations.<sup>60</sup>

#### 4. The Topf Cremation Facilities for Concentration Camps

As of the late 1930s, Topf & Söhne as well as other manufacturers, especially the firm of H. Kori in Berlin and the Didier-Werke (also in Berlin),<sup>61</sup> began to design cremation ovens for the concentration camps. These ovens were constructed more simply than those for civilian use. The Topf firm developed six projects for cremation ovens of this type:

1. Coke-fired single muffle oven, never built.<sup>62</sup>
2. Mobile, petrol-fired two-muffle oven, later converted into a stationary coke-fired oven. This type of oven was installed in Gusen (a subcamp of Mauthausen) and Dachau. The first one was ordered by the *SS-Neubauleitung* of the Mauthausen camp on March 21, 1940, as a mobile, petrol-fired oven (*“fahrbarer Ofen mit Ölbeheizung”*), but on October 9, 1940, it was decided to convert it

<sup>59</sup> R. Kessler, *op. cit.* (note 33), issue 8, p. 140; P. Schläpfer, *“Betrachtungen...”*, *op. cit.* (note 37), p. 151.

<sup>60</sup> R. Kessler, *op. cit.* (note 33), issue 9, pp. 150f. and 156f.

<sup>61</sup> See chapter 4.4.

<sup>62</sup> Drawing of J.A. Topf & Söhne D 58173 of Jan. 6, 1941: *“Einmuffel-Einäscherungsöfen”* coke-fired for the *SS-Neubauleitung* of KL Mauthausen. Source: BAK (Koblenz Federal Archives), NS 4/Ma 54; *Kosten-Anschlag* of Topf firm from Jan. 6, 1941, for *SS-Neubauleitung* of KL Mauthausen reg. a coke-fired crematorium oven with one or two muffles. BAK, NS 4/Ma 54.



into a coke-fired oven.<sup>63</sup> Topf shipped the oven by railroad on December 12, 1940, and it arrived at its destination on December 19.<sup>64</sup> This same day, the *SS-Neubauleitung* of the Mauthausen camp sent a telegram to Topf with an urgent request for an engineer.<sup>64</sup> The Topf firm sent its engineer August Willing to Gusen on December 27,<sup>65</sup> who immediately began his work and finished it on January 22, 1941. The two coke-fired gas generators had been installed during the construction of the oven, which went into operation at the end of January 1941.<sup>66</sup>

According to a Topf letter to the *SS-Neubauleitung* of Dachau of July 25, 1940,<sup>67</sup> the oven of the Dachau camp had been delivered even earlier. The SS authority of the Dachau camp decided also to convert this oven's heating system by replacing the two petrol burners with coke gas generators. Both converted ovens do still exist today in these former concentration camps. Initially, the decision of local authorities to convert the heating system of certain crematorium ovens was prompted by the sheer lack of liquid fuel, but on December 17, 1943, the Chief of *Amt CIII (Technische Fachgebiete)* of the SS-WVHA sent an executive order stating:<sup>68</sup>

*"In the crematoria, the use of liquid fuel can no longer be permitted. The modification to solid fuel has to be done everywhere."*

3. Coke-fired two muffle oven, installed at Buchenwald camp. On June 18, 1938, the Construction Office of the SS administration of Buchenwald-Sachsenhausen camp sent a request to *SS-Gruppenführer Eicke*, head of the *Totenkopfverbände* and of the concentration camps, to authorize the construction of a crematorium at the Buchenwald camp. Eicke forwarded this request to the Head of the SS administration in Munich with a note in which he endorsed the request since, as a result of an increased number of inmates of this camp, Buchenwald was confronted with deceased inmates almost on a daily base, whose bodies had to be cremated in the municipal crematorium of Weimar.<sup>69</sup> The request was welcomed and the authorization was released by the *Hauptamt Haushalt und Bauten* (HHB) at the beginning of December 1939. For the construction of an "emergency crematorium" (*Notkrematorium*), as it is referred to in German administrative documents, a request was sent to the firm Topf. On December 21, 1939, Topf sent an estimate to the appropriate authorities for "1 petrol- or coke-fired Topf incineration oven with double muffle and compressed-air blowers, as well as forced-draft blowers" for 7,753 RM, plus 1,250 RM for the installation.<sup>70</sup>

The "Description of the structure of the new construction of an emergency crematorium in the detention camp Buchenwald" specifies:<sup>71</sup>

*"Due to the high mortality rates in the Buchenwald camp, the construction of an emergency crematorium with petrol-fired cremation oven (double muffle oven) has become necessary. For this, a location of 6 x 9 m and 4 m height is required."*

In its estimate of December 21, 1939, the Topf firm also included a drawing of the oven, edited the same day,<sup>72</sup> and a plan for a small crematorium of just 6 m × 9 m × 4 m.<sup>73</sup> The document just quoted refers to this small crematorium and contains a "cost calculation", a "recapitulation of the costs" and finally a "calculation of the masses" of the emergency crematorium for the Buchenwald

<sup>63</sup> Letter Topf, Feb. 26, 1941, to *SS-Neubauleitung* of KL Mauthausen. BAK, NS 4 Ma/54.

<sup>64</sup> Telegram *SS-Neubauleitung* of KL Mauthausen to Topf, Dec. 19, 1940. BAK, NS 4 Ma/54.

<sup>65</sup> Letter Topf to *SS-Neubauleitung* of KL Mauthausen, Dec. 23, 1940. BAK, NS 4 Ma/54.

<sup>66</sup> Letter *SS-Neubauleitung* of KL Mauthausen to Topf, Feb. 14, 1941. BAK, NS 4 Ma/54.

<sup>67</sup> Letter Topf to *SS-Neubauleitung* of KL Mauthausen, July 25, 1940. BAK, NS 4 Ma/54.

<sup>68</sup> AGK (Archiwum Głównej Komisji Zbrodni Przeciwko Narodowi Polskiemu Instytutu Pamięci Narodowej, Warszawa), NTN, 94, p. 177.

<sup>69</sup> NO-4353.

<sup>70</sup> *Kosten-Anschlag* J.A. Topf & Söhne, Dec. 21, 1939, for *SS-Neubauleitung* of KL Buchenwald reg. a petrol- or coke-fired crematorium oven with two muffles. NO-4448.

<sup>71</sup> NO-4401.

<sup>72</sup> Drawing of J.A. Topf & Söhne D 56570, Dec. 21, 1939, "Doppelmuffel-Einäscherungsöfen mit Ölbrenner" for KL Buchenwald. NO-4444.

<sup>73</sup> Plan of crematorium in KL Buchenwald (Dec. 1939). NO-4444.

camp, whose cost was estimated to 14,200 RM.<sup>74</sup> No documents regarding the realization of this project are known to me. A later, undated project, probably from 1940, shows a more sophisticated crematorium with outer dimensions of 14 m × 12 m, consisting of five rooms. The furnace room (6.50 m × 4.99 m), however, contains only one single muffle oven.<sup>75</sup> According to Kurt Prüfer, a Topf two-muffle oven was installed at Buchenwald in 1940-1941,<sup>76</sup> which evidently was the subject of the estimate mentioned above.

4. Coke-fired two muffle oven type Auschwitz. Three ovens of this type were built in the crematorium of Auschwitz I between 1940 and 1942; one was built in 1945 in the crematorium of Mauthausen.

5. Coke-fired three muffle oven. Two ovens of this model (one also equipped for petrol-firing) were installed in the crematorium of Buchenwald in 1942, two in the crematorium of Groß-Rosen in 1942,<sup>77</sup> and ten in the crematoria II and III of Birkenau in 1942-1943.

6. Coke-fired eight muffle oven. Two ovens of this type were built in the crematoria IV and V of Birkenau in 1942-1943, and one half of such an oven (4 muffles) was installed at Mogilew in 1942. The ovens of Auschwitz will be described in the following paragraphs.

#### 4.1. The Coke-Fired Topf Double-Muffle Cremation Ovens

As far as we know, Topf built four ovens of this type, of which three were installed in crematorium I, the old crematorium of Main Camp Auschwitz, while the fourth was located in the crematorium of Mauthausen.

Work on building the first oven for Auschwitz began in early July 1940. A September 16, 1940 letter from the Auschwitz Administration reveals that the oven had been “*in service for weeks already*”.<sup>78</sup> One can thus assume that the oven was first put into service around the end of July 1940. It was built between July 5 and 25, 1940, and the first cremation took place on August 15.<sup>79</sup>

The cost estimate for the second oven is dated November 13, 1940. The Topf firm delivered the various components of the oven to Auschwitz on December 20 and 21, 1940 and January 17 and 21, 1941.<sup>80</sup> It was constructed between January 26 and February 22, 1941.<sup>81</sup>

Topf revised its cost estimate for the third oven on September 25, 1941,<sup>82</sup> and sent the required material to Auschwitz on October 21, a total of 3,548.5 kg.<sup>83</sup> Construction of the foundation for the third oven began on November 19, 1941, and was completed on December 3;<sup>84</sup> work was then discontinued due to a lack of fireproof material. The pertinent invoice issued by Topf is dated December 16, 1941.<sup>85</sup> Due to a *Waggon Sperre* (railroad car prohibition<sup>86</sup>), however, construction of the ovens

<sup>74</sup> *SS-Neubauleitung* Buchenwald, *Kostenberechnung*, Jan. 10, 1940. NO-4401.

<sup>75</sup> Drawing of the Buchenwald crematorium (Jan. 1940). NO-4445.

<sup>76</sup> Interrogation of K. Prüfer, Feb. 11, 1948, by Lieutenant Colonel of *Smersh* Doperchuk. *Federativnaya Slushba Besopasnosti Rossiskoi Federatsii (FSBRF)*, Fond N-19262, p. 124. German translation in: J. Graf, “*Anatomie der sowjetischen Befragung der Topf-Ingenieure*.” in: *VffG*, 6(4) (2002), p. 404.

<sup>77</sup> So far, no documents were discovered about these furnaces, but in 1948, the Soviet counter-espionage service (*Smersh*) had a plan of the crematorium of Groß-Rosen drawn by the Topf company that showed two triple-muffle ovens. Kurt Prüfer confirmed that they had been constructed in 1942. *FSBRF*, Fond N-19262, p. 183; cf. J. Graf, *ibid.*, p. 412.

<sup>78</sup> Danuta Czech, *Auschwitz Chronicle, 1939-1945*, Henry Holt, New York 1989, p. 16; cf. *RGVA* (Rossiski Gosudarstvenni Vojenni Archiv, Moscow), 502-1-327, p. 216.

<sup>79</sup> *RGVA*, 502-1-214, pp. 95, 97; 502-1-327, p. 215.

<sup>80</sup> *RGVA*, 502-1-327, pp. 168-172.

<sup>81</sup> *RGVA*, 502-1-214, p. 68, 72.

<sup>82</sup> *RGVA*, 502-2-23, pp. 264-266.

<sup>83</sup> *RGVA*, 502-1-312, pp. 104f.

<sup>84</sup> D. Czech, *op. cit.* (note 78), pp. 108, 112.

<sup>85</sup> *APMO*, D-Z/Bau, no. inw. 1967, pp. 130f.

could not start because the Collmener Schamottewerke, supplying Topf with refractory material, had not been able to deliver the required material. The railroad freight car with the refractory material, sent from the Plützsch firm, arrived at the camp on January 3, 1942,<sup>87</sup> but this oven was built in March 1942.<sup>88</sup>

The oven for Mauthausen (near Linz, Austria) was ordered from the Topf firm on October 16, 1941, but the SS Office for Construction Management hesitated for a long time before having it built. The components of the oven were shipped to Mauthausen between February 6, 1942 and January 12, 1943,<sup>89</sup> but the decision to assemble it was not made until late 1944.<sup>90</sup> The oven was finally built in January-February 1945, which explains the fact that it is relatively well preserved.

The two Topf double-muffle cremation ovens presently on display in the crematorium of Auschwitz Main Camp were reconstructed after the war, but in a rather awkward manner, using original parts that had been removed from the ovens by the SS. It is thus entirely pointless to examine these reconstructions in the hopes of gaining an understanding of this type of oven. For this reason our investigation is based wholly on the examination of the oven from Mauthausen, and on the documents available to us relating to the ovens of Auschwitz and that of Mauthausen – all of which were the same model.<sup>91</sup>

The components of the oven of Mauthausen are also included on Topf's shipment list of January 12, 1943.<sup>92</sup> The construction of the double-muffle cremation oven is shown on diagram "Topf D57253", which dates from June 10, 1940 and refers to the first oven built in Auschwitz. The oven is solid brick and sealed with a row of wrought-iron anchors. The dimensions of the Mauthausen oven are virtually identical to those shown on diagram D57253, which correspond to the measurements of the anchor irons itemized on Topf's shipment list of January 17, 1941 with respect to the second oven of Auschwitz. The oven is equipped with two cremation chambers, or muffles.<sup>93</sup> The oven's operation is explained in the "Operation Manual for the Coke-Fired Topf Double-Muffle Cremation Oven."<sup>94</sup>

The crematorium of Auschwitz was originally constructed in accordance with diagram "Topf D50042" of September 25, 1941, which had been drawn up for the construction of the third oven.<sup>95</sup> Each oven was equipped with its own forced-air installation; this consisted of an air blower, which was operated with a 1.5 hp three-phase AC motor coupled directly to the blower shaft, and an appropriate duct. The square stack originally had an area of 500 × 500 mm<sup>2</sup> (19.7" × 19.7"). The exhaust installation, with a capacity of about 4,000 m<sup>3</sup>/h (141,200 cu.ft./h) of stack gas, consisted of an exhaust fan powered with a 3 hp three-phase AC motor coupled directly to the blower shaft; an air shutter sep-

<sup>86</sup> RGVA, 502-1-312, p. 98. During the war, companies needed special permission to receive transportation space in railroad cars due to restricted capacity. At times, no cars were assigned for civil purposes because all transportation was required for military purposes.

<sup>87</sup> RGVA, 502-1-312, p. 83.

<sup>88</sup> RGVA, 502-1-22, p. 11ff.

<sup>89</sup> Letter from the SS Construction Office of the concentration camp Gusen to the Topf firm, Oct. 24, 1942. Letter from the Topf firm to the SS Construction Office of the concentration camp Gusen, Jan. 16, 1943. BAK, NS 4 Ma/54.

<sup>90</sup> Letter from the Topf firm to the SS Construction Office of the concentration camp Mauthausen, Dec. 20, 1944. BAK, NS 4 Ma/54.

<sup>91</sup> Letters from the Topf firm to the SS Construction Office of the concentration camp Mauthausen, Nov. 23, 1940 and Oct. 16, 1941. BAK, NS 4 Ma/54. The letter of Oct. 16, 1941 expressly mentions the delivery of a "Doppelmuffeleinäscherungssofen – Modell Auschwitz" (double-muffle cremation oven – Auschwitz model).

<sup>92</sup> Delivery notice from the Topf firm, Jan. 12, 1943. BAK, NS Ma/54.

<sup>93</sup> Regarding details on construction, cf. our main work, *op. cit.* (note 2), as well as J. A. Topf & Söhne Erfurt. Coke-fired cremation oven and foundation blueprint. D57253. Jan. 10, 1940. Regarding SS New Construction Office of the concentration camp Auschwitz. BAK, NS 4 Ma/54; listing of the materials for a Topf Double-Muffle Cremation Oven, Jan. 23, 1943. BAK, NS 4 Ma/54; bill no. D 41/107, Feb. 5, 1941, BAK, NS 4 Ma/54.

<sup>94</sup> *Betriebsvorschrift des koksbeheizten Topf-Doppelmuffel-Einäscherungssofens* (Operation Manual for the Coke-Fired Topf Double-Muffle Cremation Oven). Sept. 26, 1941. APMO, BW 11/1, p. 3.

<sup>95</sup> APMO, neg. no. 20818/1.

arated the high and low pressure chambers. The function of this installation is described in the relevant operation manual from the Topf firm.<sup>96</sup>

The oven loading system was made up of a carriage via which the body was introduced into the muffle. This conveyance consisted of a carriage, which moved on special rails and on which the coffin was introduced, and of a shunting carriage running above it.

On July 19, 1943 the crematorium was taken out of service,<sup>97</sup> and the ovens were then dismantled.

After the end of the war the Poles reconstructed ovens 1 and 2, for which purpose they used the original parts which had been removed by the SS and of which many were still in the former coke fuel storage room. The reconstruction was done in a remarkably slipshod manner, and the ovens would not be functional in their present state.

## 4.2. The Coke-Fired Topf Three-Muffle Cremation Ovens

Just like the eight-muffle oven, this oven was designed by engineer Prüfer during the last months of 1941. On October 22, 1941 the Central Construction Office of Auschwitz ordered from the Topf firm, five Topf three-muffle ovens with forced-air blower, for the new crematorium, which the Office intended to construct in the Main Camp. These ovens were later installed in crematorium II of Birkenau. The final bill for this was dated January 27, 1943, and the cost per oven was RM 6,378.<sup>98</sup> The five three-muffle cremation ovens for crematorium III were first ordered by the Central Construction Office on September 25, 1942, by telephone, and on September 30 by registered letter.<sup>99</sup> On October 28 the Topf firm sent the Central Construction Office diagram D59394 for the construction of the ovens in crematoria II and III. This diagram has been lost.<sup>100</sup> The final bill for the five three-muffle cremation ovens for crematorium III of Birkenau is dated May 27, 1943. The cost per oven was RM 7,830.<sup>101</sup>

The first two three-muffle ovens supplied by Topf went into service in the concentration camp Buchenwald, on August 23 and October 3, 1942.<sup>102</sup>

The following description of the Topf three-muffle cremation oven is based on direct examinations of the ovens of Buchenwald and on the documents available. Three photographs from SS sources<sup>103</sup> confirm that the three-muffle ovens installed in crematoria II and III of Birkenau were the same model as those in Buchenwald; one of these, however, could also be fired with fuel oil.

Regarding its construction, the three-muffle oven consisted of an oven with two muffles, each with one coke gas generator, and an additional third, central muffle and other technical modifications, which we have already set out elsewhere.<sup>2</sup>

The oven is contained within a solid brick structure with fittings of wrought and cast iron. Considering that the fireproof brickwork of the double-muffle cremation oven of the type installed at Auschwitz weighed about 10,000 kg (22,000 lbs),<sup>104</sup> it is clear that the three-muffle oven was a more economical facility, as one can also deduce from the considerably lower price. The third double-muffle oven of Auschwitz cost RM 7,332 and included a forced-air blower and a conveyance, with the appropriate rails, to introduce the body into the muffle. The ovens of crematorium II of Birkenau cost

<sup>96</sup> Operation Manual for the 'Topf' Exhaust Installation, Sept. 26, 1941. *APMO*, BW 11/1, p. 2.

<sup>97</sup> D. Czech, *op. cit.* (note 78), p. 442.

<sup>98</sup> Letter from Kurt Prüfer to Ludwig and Ernst Topf, Dec. 6, 1941. *APMO*, BW 30/46, p. 6; bill no. 69, Jan. 27, 1943. *RGVA*, 502-1-327, pp. 10-10a.

<sup>99</sup> Letter from the Topf firm to the Central Construction Office of the concentration camp Auschwitz, Sept. 30, 1942. *APMO*, BW 30/34, p. 114, and BW30/27, p. 30.

<sup>100</sup> Letter from the Topf firm to the Central Construction Office of the concentration camp Auschwitz, Oct. 28, 1942. *APMO*, BW 30/34, p. 96.

<sup>101</sup> Bill no. 728 of May 27, 1943. *RGVA*, 502-1-327, pp. 19-19a.!!!

<sup>102</sup> Letter K. Prüfer to head of Topf firm, Nov. 15, 1942. *APMO*, BW 30/46, p. 18.

<sup>103</sup> *APMO*, microfilm nos. 287, 290 and 291.

<sup>104</sup> "Aufstellung der Materialien zu einem Topf-Doppel-Einäscherungssofen" (list of materials for a Topf double-muffle cremation oven) *BAK*, NS4/Ma 54.

RM 6,378 each and included a forced-air installation. Considering that two body conveyances and the rails for five ovens cost RM 1,780, the three-muffle oven with the same equipment actually cost less than a double-muffle oven. The unit price for the ovens for crematorium III, on the other hand, was a little higher (RM 7,380, without the body conveyance), but still much more reasonable.

Crematoria II and III of Birkenau had a large oven room measuring 30 m × 11.24 m (98.4' × 36.9'). The five three-muffle cremation ovens were located along the longitudinal axis. Adjoining the oven room was a crematorium wing 10 m × 12 m (33' × 39') in size and split into two sections by a dividing wall. The smaller section directly adjoining the oven room was in turn subdivided into three rooms: two engine rooms and a room for one of the three exhaust installations with which the crematorium was equipped. The other section contained the stack, the other two exhaust installations and a trash incinerator, which is why this room was labeled “*trash incinerator*” on the corresponding blueprints.<sup>105</sup> The flue gases from the ovens were sucked up by an exhaust installation housed in an adjoining room, and blown into the stack at high velocity.<sup>106</sup> In March 1943 the three exhaust blowers of crematorium II were seriously damaged and had to be dismantled. As a result, the facilities intended for crematorium III were not installed.

Unlike crematorium II, crematorium III was not equipped with the rails via which ovens were loaded; rather, these body conveyances were replaced with litters.<sup>107</sup> Such a litter – they were also used in the Topf double-muffle ovens of Mauthausen and in the Kori ovens in other concentration camps – consisted of two parallel metal pipes 3 cm (approx. 1") in diameter and some 350 cm (11.5') in length. A slightly concave metal sheet 190 cm (6.2') long and 38 cm (1.5") wide was soldered onto their front, where they were to enter the muffle. The two pipes of the litter were soldered onto the oven door at the same distance apart as the guiding rollers, so that they could glide on them easily. In March 1943 it was decided that this system would also be introduced in crematorium II.<sup>108</sup>

The operation of the coke-fired three-muffle oven is explained in the corresponding Operation Manual for the Coke-Fired Topf Three-Muffle Cremation Oven,<sup>109</sup> which was based on the manual for the double-muffle cremation oven. The only significant difference relates to the heat tolerance of the muffles, which were not to be heated to more than 1000°C (1830°F), whereas the double-muffle oven could be heated to 1100°C (2010°F). This lower heat tolerance is due to the lesser quantity of fire-proof brickwork per muffle of this oven type (approximately 2,100 kg, or 4,630 lbs) as compared to that of the double-muffle oven (approximately 3,000 kg, or 6,600 lbs), and probably also to the lesser quality of the materials used.

In Germany, cremation in concentration camps had been regulated at the beginning of World War Two by the “*decree regarding cremations in the crematorium of concentration camp Sachsenhausen*”, which Himmler had issued on February 28, 1940.<sup>110</sup> This decree was entirely in accordance with the legal stipulations in effect for civilian crematoria.<sup>111</sup> Whether these legal regulations were later modified or rescinded, and/or whether other regulations applied to the concentration camps located in the occupied eastern territories than applied to those in the Reich proper, is not known, but it is cer-

<sup>105</sup> Plan of the new crematorium of Auschwitz (and future crematorium II/III of Birkenau). Diagram by the Construction Office of Auschwitz, no. 933, of Jan. 19, 1942. *APMO*, neg. nos. 20957 and 20818/4.

<sup>106</sup> *APMO*, neg. nos. 518 and 520; cf. advance bill from the Topf firm, Dec. 18, 1941. Each exhaust (induced-draft) installation cost RM 3,016. *APMO*, D-Z/Bau, no. inw. 1967, p. 97.

<sup>107</sup> Letter from the Topf firm to the Central Construction Office of the concentration camp Auschwitz, Sept. 30, 1942. *APMO*, BW 30/34 p. 114.

<sup>108</sup> Memo of March 25, 1943. *APMO*, BW 30/33, p. 8.

<sup>109</sup> *Betriebsvorschrift des koksbeheizten Topf-Dreimuffel-Einäscherungsofens* (Operation Manual for the Coke-Fired Topf Three-Muffle Cremation Oven). This document was published for the first time in Dr. Miklos Nyiszli's *Médecin à Auschwitz. Souvenirs d'un médecin déporté, traduit et adapté du hongrois par Tibère Kremer*, Juillard, Paris 1961 (extratextual document); cf. *APMO*, BW 30/34, p. 56.

<sup>110</sup> *Erlaß über die Durchführung von Einäscherungen im Krematorium des Konzentrationslagers Sachsenhausen*. BAK, NS 3/425.

<sup>111</sup> Text from F.Schumacher, *op. cit.* (note 25), pp. 116-120.

tain that the Topf double- and three-muffle cremation ovens were designed along the same norms as the civilian ovens. The Topf cost estimates for these ovens also list carriages or devices for the introduction of coffins into the muffle, which proves that cremation was intended to include the coffin. This is further established by the operating guidelines, which recommended starting the forced-air blower immediately after the introduction of the body, and to leave it on for about 20 minutes. This recommendation is tailor-made for the circumstance that the bodies enter the oven in coffins, since the rapid and intensive combustion of the coffin requires a large quantity of air. In a cremation without a coffin, on the other hand, this stipulation would be completely pointless, because adding a large quantity of cold air during the beginning stage of cremation, where moisture evaporates from the body – a process which robs the oven of a large amount of heat – would only have slowed the cremation process.

The operating instructions also indicate that the ovens were designed for the cremation of one body at a time per muffle, since they specify that the bodies had to be introduced successively. On July 3, 1940, in order to “put the crematorium into operation”, the firm Topf also offered “500 ash urns” and “500 fireclay markers” to the SS-Neubauleitung of Auschwitz.<sup>112</sup> The latter were numbered plates of fireclay, which were placed on the coffin or directly on the corpse to identify the ashes. In 1946, some of these plates were found near the crematorium II. They were handed over to investigating judge Jan Sehn,<sup>113</sup> who, as far as I know, never mentioned them in his findings about his investigations on Auschwitz. This confirms that not even in Birkenau corpses were cremated anonymously in masses, but one at a time.

### 4.3. The Coke-Fired Topf Eight-Muffle Cremation Oven

This oven, whose construction was probably shown on the missing diagrams D59555, D60129 and D60132 from the Topf firm,<sup>114</sup> was designed by engineer Prüfer, presumably in late 1941. In any case it was designed along the lines of the three-muffle oven, whose design diagram bears a lower number, namely D59394.

On December 4, 1941 the Main Office for Budget and Buildings in Berlin ordered from the Topf firm, “4 double-Topf-4 muffle cremation ovens” for Mogilew in Russia, where POW transit camp 185 was located.<sup>115</sup> The order was confirmed on December 9, but only half the oven (four muffles) was shipped to Mogilew on December 30, while the rest remained in Topf’s storehouse for the time being. On August 26, in accordance with the suggestion engineer Prüfer had made on the occasion of his visit to Auschwitz on August 19, 1942, the SS Economic-Administrative Main Office ordered that two of the ovens for Mogilew should instead be sent to Auschwitz. However, the Central Construction Office waited two-and-a-half months before requesting a cost estimate for this model of oven. Topf sent the estimate on November 16. The total price of RM 55,200 – RM 13,800 for each oven – included a 6% surcharge because the company had had to revise the drafts and design new models for the ovens’ fittings so often.<sup>115</sup>

The blueprints of crematorium IV (and crematorium V, in mirror image) of Birkenau which show the foundations and the vertical cross-section of the “eight-muffle cremation oven”, the photos taken by the Poles in 1945 of the ruins of crematorium V, and the direct examination of these ruins, enable us to reconstruct this model of oven with sufficient accuracy.<sup>116</sup>

<sup>112</sup> RGVA, 502-1-327, p. 226.

<sup>113</sup> Testimony of A. Żłobnicki, Nov. 18, 1981. *APMO, Oświadczenia* (explanations), vol. 96, p. 63a and 70.

<sup>114</sup> RGVA, 502-1-313, pp. 139f.

<sup>115</sup> RGVA, 502-1-327, pp. 47f.

<sup>116</sup> Cf. bill no. 380 of April 5, 1943. RGVA, 502-1-314, pp. 29-29a; plan of crematorium IV (and V) of Birkenau. Construction Office Diagram no. 1678 of Aug. 14, 1942. *APMO*, neg. no. 20946/6; plan of crematorium IV (and V) by the Construction Office, no. 2036 of Jan. 11, 1943. *APMO*, neg. no. 6234; *APMO*, neg. fot. nos. 620, 14283, 21334/81, 21334/82, 21334/83, 21334/141; J. A. Topf & Söhne Erfurt Diagram D58173 of Jan. 6, 1941. Single-muffle cremation oven. SS New Construction Office of the concentration camp Mauthausen. *BAK*, NS 4 Ma/54.

The coke-fired Topf eight-muffle cremation oven consisted of eight ovens with one muffle each, as shown on Topf's diagram 58173. Four ovens together make up each of two groups. Each group consists of two pairs of ovens, set up in mirror image so that the back and two central walls of the muffle are shared. The two oven groups are connected by four generators and set up in pairs along the same lines, so that they ultimately form one single oven with eight muffles which is referred to in the corresponding invoice as the "large-area cremation oven", due to its size (its base covered an area of about 32 m<sup>2</sup>, or 344 sq.ft.).

The oven was encased in a solid brick structure containing a series of anchor irons. These are clearly visible on the Polish photographs of 1945 and are still present today in the ruins of this crematorium.

The heating grates were also designed to burn wood, as one can see from Topf's invoice of April 5, 1943, where "wood heating" is mentioned. The system for introducing the bodies into the muffles used a litter like that in crematoria II and III; it was affixed on two simplified rollers bolted to the anchor irons underneath the muffle damper.

The oven was probably not equipped with forced-air blowers, since none are mentioned on the bill of April 5, 1943. The stacks were designed without exhaust systems. The base unit of the Topf eight-muffle cremation oven consisted of two muffles and one generator, and the flue system for the stack gases corresponded to that of the "single-muffle cremation oven" shown on Topf design D58173.

#### 4.4. The Cremation Ovens of the Firm of H. Kori, Berlin, and Ignis Hüttenbau, Teplitz

Where the supply of cremation ovens to German concentration camps is concerned, the Berlin manufacturer H. Kori was Topf's major competitor. Kori's coke- or oil-fired ovens were installed at Dachau, Mauthausen, Majdanek, Stutthof near Danzig (not to be confused with the Alsatian camp Struthof near Natzweiler), Ravensbrück, Groß-Rosen and Neuengamme, among other places.

Strictly speaking, these ovens have no immediate significance to a study of the crematoria at Auschwitz and Birkenau. However, since we shall eventually use some data from Kori ovens to draw certain conclusions about characteristics also present in the Birkenau ovens, we have also analyzed these Kori ovens in detail. Since these analyses would go beyond the scope of the present study, we refer the reader to the relevant sources.<sup>117</sup>

In the course of 1942, a crematorium was built for the ghetto of Terezín, which was called Theresienstadt at that time. A detailed cost estimate exists for this installation dated April 2, 1942, from the firm Ignis Hüttenbau A.G. of Teplitz-Schönau in the then Protectorate of Bohemia and Moravia (today's Teplice in Czechia).<sup>118</sup> Because of the rapid increase of the mortality in the ghetto of Theresienstadt – from 256 deaths in April 1942 over 2,327 in May to 3,941 in June<sup>119</sup> –, the crematorium was equipped with four petrol-fired ovens by Ignis-Hüttenbau.<sup>120</sup>

<sup>117</sup> Cf. the following documents: letter from the Didier-Werke, Aug. 25, 1943, to Herrn Boriwoje Palitsch, Belgrade, regarding SS cremation facility in Belgrade. USSR-64; letter from the firm of H. Kori, May 18, 1943, to accredited engineer Waller of Department CIII of the SS Economic-Administrative Main Office, regarding the delivery of one or two Kori cremation ovens. *KfSD* (Archives of the Curatorship for the Atonement Memorial of the Concentration Camp Dachau), 5732; cremation facility for the POW camp Lublin. Design by the firm of H. Kori J. no. 9122, *KfSD*, 659/41; letter from the firm of H. Kori, Oct. 23, 1941, to SS-*Sturmbannführer* Lenzer, Lublin. *APMM* (Archivum Panstwowego Muzeum na Majdanku), sygn. VI-9a, v. 1; letter from the firm of H. Kori to the Headquarters of the Waffen-SS and Police POW camp Lublin. *APMM*, sygn. VI-9a, v. 1; *APMO*, ZO, sygn. Dpr-20/61a, p. 76.

<sup>118</sup> Letter and cost estimate of the company Ignis Hüttenbau A.G. of Teplitz-Schönau, Apr. 2, 1942, "An die Zentralstelle für jüdische Auswanderer, z.H. des Kommandos der Waffen-SS in Theresienstadt" con oggetto "Errichtung eines Krematoriums in Theresienstadt". Památník Terezín, A 7-856.

<sup>119</sup> *Terezínská Pamětní Kniha*, Terezínská Iniciativa Melantrich, 1995, vol. I, p.33.

<sup>120</sup> See chapter 6.5.

## 5. Coke Consumption of Topf Cremation Ovens of Auschwitz & Birkenau

### 5.1. Heat Balance of Topf Double-Muffle Cremation Ovens at Gusen

The decisive factor influencing the consumption of fuel of a crematorium oven is the frequency of cremation: the higher the frequency, the less fuel is required for each individual cremation. For example, the diagram “*Subsequent cremations*” published by Prof. P. Schläpfer in 1936 based on practical experiences shows a consumption of over 400 kg of coke for the first cremation, starting with a cold oven, of about 200 kg for the second, and little more than 100 kg for the fourth cremation.<sup>121</sup> After the eighth cremation, the graph becomes more or less horizontal, reaching a value of 37.5 kg of coke at the twentieth and last cremation.<sup>122</sup> This means that 20 discontinuous cremations separated from each other by a day or more would have required more than  $(400 \times 20 =)$  8,000 kg of coke, while 20 consecutive cremations in a warm oven would have required only  $(37.5 \times 20 =)$  740 kg. From the tenth consecutive cremation onward the fuel consumption was steady because by then, the refractory material was warmed up and absorbed only as much heat as was necessary to compensate for heat losses due to radiation and convection, *i.e.*, the oven was in a thermal equilibrium. Therefore, in order to find out the minimal fuel consumption of any crematorium oven, it is necessary to establish the conditions when the oven is in a thermal equilibrium, *i.e.*, when the ovens gives off as much heat to the environment as it gets back from the burning fuel.

Between the few relevant surviving documents on the crematorium of Gusen exists a list edited by *SS-Unterscharführer* Wassner, head of the crematorium of Gusen, which documented the number of inmates cremated and the coke consumption per corpse for the period from September 26 to November 12, 1941. According to this document, 677 corpses were cremated in this crematorium between October 31 and November 12, 1941.<sup>123</sup> This amounts to an average of 52 corpses per day, or 26 corpses per day and muffle, with a total consumption of 20,700 kg of coke, or 30.6 kg of coke per corpse.

Since these consumption figures are based on practical data, they are a precious point of departure for the calculation of the heat balance of the Topf ovens of Auschwitz-Birkenau. Mathematically, the heat balance of an oven is expressed by an equation consisting of all losses of heat, split up into various factors (heat sinks, for instance loss by radiation, conduction, hot exhaust gases), and all contributions of heat (heat sources, *e.g.*, burning fuel, coffin, corpse).<sup>124</sup> Except for the volume of air going through the oven, which depends on the management of the oven, all factors can be calculated. But because in the specific case of Gusen the fuel consumption is known by practical data, all factors can be determined.<sup>125</sup>

<sup>121</sup> Diagram entitled “*Einäscherungen hintereinander*”, in P. Schläpfer, “*Über den Bau und den Betrieb von Krematoriumsöfen*”, *op. cit.* (note 37), p. 36.

<sup>122</sup> Naturally it is necessary to always add the heat produced from the coffin.

<sup>123</sup> *ÖDMM (Öffentliches Denkmal und Museum Mauthausen, Public Memorial and Museum of Mauthausen)*, Archiv, B 12/31.

<sup>124</sup> The calculation of the heat balance was conducted according to the method developed by W. Heepke in his article “*Die neuzeitlichen Leicheneinäscherungsöfen mit Koksfeuerung, deren Wärmebilanz und Brennstoffverbrauch*,” in: *Feuerungstechnik*, yr. XXI, issue 8/9, 1933.

<sup>125</sup> Based on W. Heepke’s model, *ibid.*, the fundamental equation of the oven of Gusen that expresses the average consumption of a cremation is:  $\frac{L + W2 + W2a + W3 + Vls - W7}{\eta Hu} = 30.6$ , with L = heat difference of combustion gases between entry and exit + small losses; W2 = vaporization heat of water of the corpse; W2a = heat required to bring water steam up to the temperature of the exiting combustion gases; W3 = heat of the ashes at the extraction from the oven; Vls = loss of heat of the oven by radiation and conduction; W7 = calorific value of the body (and coffin, if applicable);  $\eta Hu$  = efficiency of coke.



## 5.2. Heat Balance of Topf Double-Muffle Cremation Ovens at Auschwitz

The heat balance of the Topf double-muffle ovens at Auschwitz can be calculated following this approach by taking into consideration the slightly different operating temperature, cremation time, and surface area of the oven.<sup>126</sup> Our calculations for the coke required for a single cremation in this type of oven in thermal equilibrium resulted in the following:<sup>127</sup>

- normal corpse: 23.5 kg (51.5 lbs) coke;
- moderately thin corpse: 28.0 kg (61.3 lbs) coke;
- emaciated corpse (“*Muselmann*”): 32.5 kg (71.1 lbs) coke.

## 5.3. Heat Balance of the Topf Three- and Eight-Muffle Cremation Ovens

The three-muffle oven was derived from a double-muffle oven by inserting a third muffle in between. The two outside muffles behaved like those of a double-muffle oven, but gave off high-temperature stack gases to the center muffle. In order to allow the cremation of a body in the center muffle, an excess of combustion air went through the outside muffles, so that their exhaust gases would contain oxygen in sufficient quantities to cremate a body in the center muffle. For this reason, the amount of combustion air was not proportional to the air of the double-muffle oven, which prevents us from making an exact calculation of this oven’s heat balance. All we can say for certain is that the coke consumption of the three-muffle oven must have been slightly higher than that of a double-muffle oven due to increased heat losses resulting from a slightly higher air flow, and that there were additional radiation and conduction losses of the center muffle, which can be calculated. Therefore, the equation for calculating the theoretical minimal value of coke consumption for a triple-muffle oven type Auschwitz is:

$$\frac{C2 + Vls3 - Vls2}{2 \times \eta Hu} \times 2/3 = C3$$

- C2 = coke consumption per corpse of a double-muffle oven;
- Vls3 – Vls2 = difference of heat losses by radiation and conduction between a double-muffle and a triple-muffle oven;
- C3 = coke consumption per corpse of a triple-muffle oven;
- $\eta Hu$  = coke efficiency.

Thus, the minimal theoretical coke consumption per corpse in a triple-muffle oven was 2/3 the value of a double-muffle oven plus the amount of coke to compensate for the additional heat losses of the third muffle by radiation and conduction. Our results are:

- normal body: 16 kg (35.0 lbs) coke;
- moderately skinny body: 19 kg (41.6 lbs) coke;
- emaciated body (“*Muselmann*”): 22 kg (48.1 lbs) coke.

The eight-muffle ovens consisted of two pairs of connected double-muffle ovens. Since the combustion gasses of the first muffle passed across to the second muffle, similar consideration apply to this type of oven: the smoke gasses of the first muffle needed to contain a minimum quantity of oxygen sufficient for the combustion of the corpse of the second muffle. As a theoretical minimum of coke consumption per corpse for this type of oven, we assume half of that of the double-muffle oven:

- normal body:  $23.5 \div 2 \cong 12$  kg (26.3 lbs) coke;
- moderately skinny body:  $28.0 \div 2 = 14$  kg (30.6 lbs) coke;
- emaciated body (“*Muselmann*”):  $32.5 \div 2 \cong 16$  kg (35.0 lbs) coke.

<sup>126</sup> In our calculation (note 2), we also made some adjustments to W. Heepke’s equation for losses he did not take into consideration, see there.

<sup>127</sup> It is assumed: for normal corpses a weight of 70 kg; for moderately thin corpses a weight of 55 kg, with loss of 25% of protein and 30% of body fat; for the emaciated corpse 40 kg, with loss of 50% of protein and 60% of body fat.

The combustion of the body provided the center muffle with enough hot air to balance this muffle's heat losses, so that the coke consumption of the three-muffle oven in fact approximated that of the double-muffle oven while permitting the cremation of three instead of only two bodies. For this reason its efficiency was actually one-third greater than that of the double-muffle oven.

Therefore, the coke requirements of the three-muffle oven were as follows:

- normal body:  $25.0 \text{ kg} \times \frac{2}{3} = 16.7 \text{ kg}$  (36.8 lbs) coke;
- moderately skinny body:  $28.0 \text{ kg} \times \frac{2}{3} = 18.7 \text{ kg}$  (41.2 lbs) coke;
- emaciated body (“*Muselmann*”):  $30.5 \text{ kg} \times \frac{2}{3} = 20.3 \text{ kg}$  (44.7 lbs) coke.

#### 5.4. Observations on the coke consumption of the triple- and eight-muffle ovens

In a memo (*Aktenvermerk*) of March 17, 1943, edited by civil employee Jährling “*on behalf of the firm Topf & Söhne*”,<sup>128</sup> estimates for the coke consumption of the four crematoria of Birkenau are given. This document deserves a closer analysis. Regarding the coke consumption, it refers to “*10 Feuerungen = 350 kg/stdl.*” (10 fireplaces = 350 kg/h), which means that each fireplace of the five triple-muffle ovens of both crematorium II and III was expected to consume 35 kg/h of coke;<sup>129</sup> the same figure of 35 kg/h per fireplace is given for the two eight-muffle ovens located in the crematoria IV and V. This document also states that the amount of coke required during continuous operation (“*bei Dauerbetrieb*”) is only  $\frac{2}{3}$  as compared to a discontinuous operation, which is explained by the fact that the oven is in thermal equilibrium, as explained above.

The reduction of coke consumption during 12 hours of activity by  $\frac{1}{3}$  from 4,200 to 2,800 kg means that during discontinuous cremations, (4,200 – 2,800 =) 1,400 kg of coke were necessary to reheat the five ovens,<sup>130</sup> whereas the remaining 2,800 kg were used for the actual cremations. This results in the following figures:

	availability of coke per oven	availability of coke per muffle	coke consumption per muffle during continuous operation
triple-muffle oven	70 kg/h	23.3 kg/h	15.5 kg/h
eight-muffle oven	140 kg/h	17.5 kg/h	11.7 kg/h

These data are almost identical to those calculated above for normal corpses<sup>131</sup> and confirm the accuracy of our heat balance calculations for both the triple- and the eight-muffle ovens.

## 6. Time Required for Cremation in the Topf Ovens of Auschwitz & Birkenau

### 6.1. The Documents

The highly controversial issue of the time required for a single cremation in the Topf cremation ovens is addressed in three documents that, however, give quite contradictory data.

A letter sent by Topf to the SS New Construction Office of the concentration camp Mauthausen on November 1, 1940 contained the cost estimate for a “*coke-fired Topf double-muffle cremation oven with forced-air installation*” and for a “*Topf draft-enhancing installation*”.<sup>132</sup> The letter states:<sup>133</sup>

<sup>128</sup> *APMO*, BW 30/7/34, p. 54.

<sup>129</sup> Each crematorium had five ovens with altogether ten fireplaces, two in each oven.

<sup>130</sup> All the refractory material to the point of thermal equilibrium.

<sup>131</sup> Since the relative consumptions of double-muffle ovens – and the two outside muffles of the triple-muffle ovens – are known, the consumption of 15.5 kg per hour and muffle can only refer to a normal corpse; if it referred to a medium corpse, the center muffle of the triple-muffle oven would not only consume no energy, but it would actually save energy worth almost 11 kg of coke; if it referred to an emaciated corpse, the energy saving would amount to almost 20 kg of coke. Thus, both hypotheses would be false.

<sup>132</sup> Topf cost estimate for concentration camp Mauthausen, Nov. 1, 1940. *BAK*, NS 4 Ma/54.

*“Our Herr Prüfer has already informed you that in the previously offered oven, two bodies can be cremated per hour.”*

Since the oven at issue is a double-muffle oven of the Auschwitz type, this information of Prüfer’s means that one body could be cremated per hour and muffle. The oven’s theoretical capacity was therefore 48 bodies per 24 hours.

The second document is a letter dated July 14, 1941, in which Topf replied to a specific inquiry of the SS New Construction Office of the concentration camp Mauthausen:<sup>134</sup>

*“30 to 36 bodies may be cremated in about 10 hours in the coke-fired Topf Double-Muffle Cremation Oven.”*

Based on this claim, one cremation in one muffle took 33-40 minutes, and the oven’s theoretical capacity was 72-86 bodies per 24 hours.

The third document is a letter sent on June 28, 1943 by SS-*Sturmbannführer* Bischoff, the Chief of the Auschwitz Central Construction Office, to SS-*Brigadeführer* Kammler, the Chief of the Economic-Administrative Main Office *Amtsgruppe* C. In this letter he mentions the following 24-hour capacities of the crematoria of Auschwitz and Birkenau:<sup>135</sup>

• old crematorium I:	340 persons	• crematorium IV:	768 persons
• crematorium II:	1,440 persons	• crematorium V:	768 persons
• crematorium III:	1,440 persons	<b>Total:</b>	<b>4,756 persons</b>

Based on this document, the time required for a cremation in the double-muffle oven was about 25 minutes, and 15 minutes in the three- and eight-muffle ovens.

In order to determine to what extent the data provided by these three documents are technologically founded, and in order to estimate the minimum time required for the cremation process in the Topf ovens at Auschwitz, we shall apply three objective test criteria plus three additional criteria, all of which are based on practical experience:

1) The results of cremation experiments with coke performed by the engineer R. Kessler on January 5, 1927.

2) An excerpt from the cremation lists of the crematorium at Gusen camp.

3) Numerous excerpts of such lists relating to the crematorium of Westerbork.

4) Another important experimental criterion derives from practical results of animal carcass incineration ovens produced by Kori.

5) The technical data reported by Soviet and Polish sources about the Kori ovens at the concentration camps of Majdanek (August 1944), Sachsenhausen (June 1945), and Stutthof (May 1945) will supply further useful information.

6) Finally, the cremation lists of the crematorium at the Terezín ghetto, containing four petrol-fired ovens made by Ignis-Hüttenbau, which were without any doubt the most efficient ovens built during the Second World War, will allow us to obtain a minimal limit for time required for the cremation process in the cremation ovens built during the 1940’s in German concentration camps and ghettos.

## 6.2. The Cremation Experiments by R. Kessler

As indicated in chapter 3.6., the time required for the cremation process depends mainly on the structure and chemical composition of the human body, but to a significant extent also on the construction and operation of the cremation oven.

<sup>133</sup> Letter from the Topf firm to the SS New Construction Office of the concentration camp Mauthausen, Nov. 1, 1940. BAK, NS 4 Ma/54.

<sup>134</sup> Letter from the Topf firm to the SS New Construction Office of the concentration camp Mauthausen, July 14, 1941. Weimar State Archives, LK 4651.

<sup>135</sup> RGVA, 502-1-314, p. 14a.

Since the cremation ovens of Auschwitz and Birkenau were coke-fired, it is appropriate to compare, for a better understanding of the cremation process, the experiment with coke-fired cremation which engineer Richard Kessler performed on January 5, 1927 in the crematorium of Dessau.<sup>136</sup>

Of course, in order to arrive at a realistic assessment, it is necessary to keep in mind that the oven Gebrüder Beck used by Kessler was technically superior to the Topf ovens of Auschwitz-Birkenau, both due to the higher weight of refractory material and the presence of a recuperator, and because Kessler's oven was equipped with many monitoring devices permitting effective control during every phase of the cremation. Finally, Kessler's cremations were performed with special caution under the surveillance of an expert engineer, so that the entire process was optimized.

The influence of a coffin – present during Kessler's experiments, but absent in Auschwitz – is considered to have had no influence on the duration of the cremation, because the disadvantage of a slightly delayed beginning of the corpse's cremation was compensated by the advantage of additional heat provided by the burning coffin.

Now to Kessler's experimental results. On average, the initial temperature of the cremation was 800°C (1472°F); the highest temperature during the combustion of the coffin of about 1000°C (1832°F) was reached after 12 min. The highest temperature of combustion of the bodies of about 900°C (1652°F) was reached after 28 min. The average duration of evaporation of body fluids was 27 minutes, while the main combustion process within the muffle lasted some 55 minutes. After that, the intensity of combustion decreased gradually until it stopped after another 31 minutes. Thus, the average duration of the entire cremation was 86 minutes.

It is important to realize that Kessler's cremation process was different from the process applied in Auschwitz-Birkenau: For legal reasons, Kessler had to wait until the glowing ash from the cremated body no longer gave off any flames before he transferred it into the ash container. By contrast, in the Topf cremation ovens of Auschwitz and Birkenau the next body was introduced into the muffle as soon as the remains of the first had dropped through the muffle grating into the ash chamber, where the cremation process then concluded. Thus the main part of the cremation in the Topf ovens was finished at the point where the remains of the first body dropped through the grating and into the after-burn chamber, where they then continued to burn for another 20 minutes. This follows from Topf's guidelines.

In Kessler's case, the average time between introducing the body and attaining maximum temperature was 55 minutes. At the point where the maximum heat was attained, the body was still in the muffle, as the increase of the muffle temperature to almost 900°C (1652°F) shows. Therefore the duration of the cremation process up to the point where the remains of the body dropped through the grating into the ash chamber was necessarily longer than 55 minutes. As a point of reference, we conclude that the average duration of the main process of a single cremation in a coke-fired muffle was not shorter than 55 minutes.

### 6.3. The Cremation List of the Crematorium at Westerbork

The crematorium at Westerbork camp (Holland) was equipped with a coke-fired Kori oven, which went into operation on March 15, 1943, at a moment when the mortality was increasing strongly.<sup>137</sup> Several documents on the activity of this crematorium have been preserved. Those of interest here are:

<sup>136</sup> R. Kessler, "*Rationelle Wärmewirtschaft in den Krematorien nach Maßgabe der Versuche im Dessauer Krematorium*", *op. cit.*, (note 33).

<sup>137</sup> Second half-year of 1942: 108; 1943: 593; 1944: 50; 1945: 4; *Rapport over de sterfte in het Kamp Westerbork in het tijdvak van 15 Juli 1942 tot 12 April 1945*. ROD (Rijksinstituut voor Oorlogsdocumentatie, Amsterdam), C[64] 514, p. 1

- the “*Crematorium Operation Book*” (*Crematorium Betriebsbuch*) containing the names of the deceased between June 23, 1943, and March 31, 1944, (numbered from 277 to 510)<sup>138</sup> with date of birth, date of death;<sup>139</sup>
- various cremation lists giving the number of corpses cremated, the time each cremation took, and the amount of coke used;<sup>140</sup>
- also, a “*List of names of Jewish persons deceased in the Westerbork and Buchenwald camps and buried in Dutch cemeteries*” exists, edited by the Dutch Red Cross in which all of the names of the dead Jews to Westerbork are recorded in alphabetical order, giving, *i.a.*, the date of birth, date of death and cremation, as well as the urn number.<sup>141</sup>

According to this, cremations did not take place every day, but only after a sufficient number of corpses had accumulated in the mortuary of the crematorium in order to save fuel.

In the Westerbork camp, a high percentage of the deceased were newborn babies, with 25% in May and June 1943 and 40% in August.<sup>142</sup> Most of these babies were only a few months old and sometimes only a few days. Usually, two of these corpses were cremated together or one baby corpse together with an adult. Two little corpses were usually cremated in between the cremation of two adult corpses, so their cremation coincided with the final phase of proceeding and the initial phase of the succeeding cremation. The average duration for cremating an adult corpse individually was 50 min, whereas the cremation of a baby (average age: one year) together with an adult corpse (average age: 70 years) lasted 57 min. Here, as for the Topf ovens at Auschwitz-Birkenau, the end of the cremation is defined by the moment when the residues of the corpse(s) fell into the post-combustion chamber, enabling the introduction of a new corpse into the muffle.

#### 6.4. The Cremation Lists of the Crematorium at Gusen

This list is subdivided in four columns.<sup>123</sup> The first one (“*Uhr*”) gives the time and the number of wheelbarrows of coke; the second column (“*Datum*”) indicates the date of cremation, the third one (“*Leichen*”) the number of corpses cremated, the fourth (“*Karren Koks 1 K. = 60 kg*”) the total number of wheelbarrows of coke (1 cart = 60 kg), which means that the first column lists the numbers of carts progressively, so the last figure of the first column corresponds to the figure in the fourth column. However, the first column (time) does not give the time of beginning and end of the cremation, but the times when coke was taken from the coke storage or the time when the relevant numbers of coke carts were unloaded near the oven. The only objective criterion that allows establishing the duration of the cremation with some approximation is the combustion capacity of the fireplaces, namely the amount of coke burned in one fireplace in an hour. With natural draft, this capacity was 90-120 kg of coal per hour. According to the above quoted memo of March 17, 1943,<sup>128</sup> the combustion capacity of the fireplaces of the triple- and eight-muffle Topf ovens of Auschwitz were 35 kg of coke per hour. Since the surface of the fireplaces was 0.3 m<sup>2</sup>, the combustion capacity per m<sup>2</sup> was (35 ÷ 0.3 =) 116.7 kg/h ≅ 120 kg/h. The combustion capacity is increased – within certain limits – by the chimney’s draft, pulling oxygen through the grill. For coke-fired ovens, the highest acceptable draft with forced-draft blowers (*Saugzug-Anlage*) was 30 mm of water column,<sup>143</sup> corresponding to the combustion of about 180 kg of coke per hour and square meter of grill.<sup>144</sup> Since each fireplace grill of the oven of Gusen had a surface of (0.5 × 0.5 =) 0.25 m<sup>2</sup>, the maximum capacity, with a draft of 30 mm of water column, was (180 × 0.25 =) 45 kg of coke per hour, or 90 kg for two fireplaces.

<sup>138</sup> Corresponding to the numbers on the urns used; *ROD*, C[64] 292.

<sup>139</sup> *ROD*, C[64] 292.

<sup>140</sup> *ROD*, C[64] 392.

<sup>141</sup> *ROD*, C[64] 314.

<sup>142</sup> *Rapport over de sterfte... op. cit.* (note 137), p. 2.

<sup>143</sup> W. Heepke, *Die Leichenverbrennungs-Anstalten (die Krematorien)*, *op. cit.* (note 27), p. 71.

<sup>144</sup> G. Colombo, *Manuale dell'ingegnere civile e industriale*. Ulrico Hoepli, Milano 1916, p. 366.

Also, the three forced-draft blowers initially installed in crematorium II of Birkenau worked with a pressure of 30 mm of water column, with a gas volume of 40,000 m<sup>3</sup>/h, each driven by a 380 Volt/15 HP engine. The standard forced-draft blowers installed at the oven of Gusen camp were also installed in the crematorium at Auschwitz with a gas volume of 4,000 m<sup>3</sup>/h and an engine of 3 HP. The pressure difference it produced is not known, but it sure was not higher than 30 mm water column.

We return at the problem of the duration of the cremation. We assume that cremation began at 7 am on October 31, 1941, and ended at 23 pm on November 12, 1941, which would have been 304 hours or 18,240 minutes.<sup>145</sup> The duration of the combustion of 20,700 kg of coke actually consumed (see chapter 5.1.) depends of course on the combustion capacity of the fireplaces. As shown above, the maximum combustion capacity of the two Gusen fireplaces with forced-draft blowers at a pressure of 30 mm water column was about 90 kg/h of coke. This results in a total combustion time of the coke of  $(20,700 \div 90 =) 230$  hours or 13,800 min., an average time of activity of the oven of  $(230 \text{ hours} \div 12.67 \text{ days} \cong) 18$  hours per day, and an average incineration time per corpse of  $(30.6 \div 45 \times 60 \cong) 41$  minutes. This is the lowest theoretical value. According to operation instruction of the Topf firm for the double- and triple-muffle oven, the post-combustion of the corpse residues lasted about 20 minutes; adding this time to the main combustion – 40 minutes – results in a total cremation time of 60 minutes, which represents the limit Dr. Jones called “*thermal barrier*”, that is to say the lower time limit which cannot be underpassed. This duration, as will be explained subsequently, is valid for the oven of Gusen, but cannot be attributed directly to the double-muffle oven of the Auschwitz type, to which the Topf letter of July 14, 1941, referred to explicitly.

## 6.5. The Cremation List of Ignis-Hüttenbau Petrol-Fired Oven in Terezín

The Ignis-Hüttenbau ovens in Terezín were by far the most modern and efficient of all those ever installed in German concentration camps. Their design had been inspired by the gas-fired Volckmann-Ludwig ovens. Additionally, they were equipped with a powerful forced-draft blower and an adjustable oil burner. We will later return to these special installations.

The examination of 717 cremations performed in these ovens between October 3 and November 15, 1943 (41 days), results in the following:

- The minimal average cremation time on a single day was about 32 min. in oven no. III (November 9, 1943, with 23 cremations) and about 31 min. in oven no. IV (October 10.)
- The average duration of all cremations was about 36 min. in both ovens.
- 491 of the 682 cremations, for which the duration is indicated, lasted 35 minutes or less (72%); 22% lasted between 40 and 45 min., 42 lasted between 50 and 60 min., 1 lasted more than 60 min.
- In average, it took some 35 min. to cremate a female corpse, and around 36 min. to cremate a male corpse.

In order to save fuel, cremations were performed only in one oven at a time, so that it would be kept in thermal equilibrium. After a certain number of cremations, operation was passed on to the other oven, which was continued in a cyclic manner.

## 6.6. Conclusions

1) The shortest time required for a cremation resulting from experimental data referred to in this chapter is that of the Ignis-Hüttenbau oven in Terezín: 35-36 min. However, it is necessary to keep in mind to what this duration refers to and what made it possible. The Ignis-Hüttenbau ovens were much larger and bulkier than the Topf ovens. In particular, their muffles were 100 cm high, 90 cm wide, and 260 cm long, while the respective dimensions of the Topf triple-muffle ovens were 80,

<sup>145</sup> 12 days plus 16 hours, or 12.67 days.

70, and 200 cm. The Terezín ovens allowed a procedure which was impossible with the Topf ovens: the body was introduced into the front of the muffle in a light coffin of unfinished boards, which was exposed to the combustion air injected from eight nozzles and the flame of the oil burner, thus quickly burning up. Generally after 30-35 minutes, when the body was basically dehydrated and disintegrated, it was pushed into the back part of the muffle. There, the main combustion took place and the remains fell into the post-combustion chamber. This way, another corpse could already be introduced after the last one had barely dehydrated.

2) Such a procedure was impossible with the Topf ovens, both because they were coke-fired and because the dimensions of its muffles rendered it impossible. In the Topf double-muffle oven of Gusen, the theoretical minimal duration of 40 min. depended first of all on the special structure of the refractory grill of the muffle (consisting of transversal and longitudinal beams forming eight rectangular openings of 30 cm × 25 cm),<sup>146</sup> which allowed huge body parts to fall into the post-combustion chamber pretty early, completing the main combustion in there and freeing the muffle for the next corpse. Secondly, the forced-draft blowers in Gusen were much more efficient than those installed in the crematorium at Auschwitz, where the same type of installation served six muffles instead of just two like in Gusen. Thus, the cremation capacity alleged in the Topf letter of July 14, 1941, was based on experiences with the oven at Gusen, but not with those of Auschwitz: the claimed capacity of 30 corpses in ca. 10 hours (= 40 min. for each cremation) assumed the highest obtainable forced-draft pressure. In the light of results obtained with the Ignis-Hüttenbau ovens, a capacity of 36 corpses in ca. 10 hours (= 33 min. for each cremation) was impossible to achieve as an *average cremation time*, a value that could be attained only in exceptional cases. The duration of 40 min. represents a minimum limit, which could not be achieved with the Topf ovens of Auschwitz-Birkenau.

3) The average duration of cremations performed at Westerbork was 50 min., which was confirmed by experiments performed by engineer Kessler. We must consider, however, that the Kori oven of Westerbork could provide more heat than the Topf ovens at Auschwitz due to a bigger fire-place area (0.8 m × 0.6 m, capacity of ca. 58 kg/h of coke),<sup>147</sup> as well as the Topf letter of November 1, 1940, cited above, speaking of an average duration of a cremation in the Auschwitz type oven of 60 min.<sup>133</sup>

4) The 60 min. duration of cremating a single body in the ovens at Birkenau was confirmed by the Topf engineers Kurt Prüfer and Karl Schultze during their interrogation by the Soviet counter-espionage service *Smersh*. During the interrogation on March 4, 1946, K. Schultz stated:<sup>148</sup>

*“Five ovens were in two crematoria, and three corpses were introduced in each oven [one in each muffle], i.e., there were three openings (muffles) in each oven. In one crematorium with five ovens [and fifteen muffles], one could incinerate fifteen corpses in one hour.”*

During the interrogation on March 5, 1946, K. Prüfer explained why the cremation lasted so long in the Birkenau crematoria:<sup>149</sup>

*“In civil crematoria, pre-heated air is blown in with the help of special bellows, due to which the corpse burns faster and without smoke. The construction of the crematoria for the concentration camps is different; it was not possible to pre-heat the air, as a result of which the corpse burned slower and with developing smoke. In order to reduce the smoke and the smell of a burning corpse, a fan is used.*

*Question: How many corpses would be cremated per hour in a crematorium in Auschwitz?*

*Answer: In a crematorium that had five ovens and fifteen muffles, one cremated fifteen corpses in an hour.”*

<sup>146</sup> The muffles of the Topf ovens of Auschwitz-had only transversal beams in a distance of ca. 20 cm.

<sup>147</sup> Drawing H. Kori J.No. 9239.

<sup>148</sup> *FSBRF*, Fond N-19262J, p. 52; cf. J. Graf, *op. cit.* (note 76), pp. 413f.

<sup>149</sup> *FSBRF*, Fond N-19262J, p. 33a; cf. Graf, *op. cit.* (note 76), p. 404.

It is therefore established that the average duration of a cremation in Auschwitz was about one hour. It remains to be seen whether or not the simultaneous cremation of several corpses in one muffle was economically advantageous. This problem will be dealt with in the following chapter.

## 7. The Cremation Capacity of the Crematorium Ovens of Auschwitz-Birkenau

### 7.1. Uninterrupted Operation of the Oven

Even though the duration of the cremation process is an important factor contributing to the capacity of a cremation oven, it is not the only factor, because it is also influenced by two other factors: the duration of consecutive operations and the oven maintenance. In this paragraph, we will consider these technical problems. Like any oven fired with solid fuel, the functionality of a coke-fired oven depends on the working conditions of the grill of the fireplace, which decreases inevitably as a result of the formation of cinders. For this reason, Topf's operation manual for the double- and triple-muffle ovens stated:<sup>109</sup>

*“Every evening the generator grate must be cleaned of coke cinders and the ash must be removed.”*

#### 7.1.1. Formation and Removal of Cinders

The formation of cinders in the fireplaces of the coke gas generators is an inevitable phenomenon because every solid fuel contains incombustible ingredients that become liquid at high temperatures, which drain down through the layer of fuel and solidify on the grill due to the cooling provoked by fresh air.<sup>150</sup> The melting point of coke cinders fluctuates between 1,000 and 1,500°C, but is usually around 1,100-1,200°C,<sup>151</sup> whereas the temperature of coke fireplaces is ca. 1,500°C.<sup>152</sup> To give an idea about the quantity of cinders produced on the grill of a fireplace, we refer to the cremation experiments by R. Kessler of January 5, 1927, during which 436 kg of coke resulted in 21 kg (4.8%) of cinders.<sup>153</sup>

The removal of cinders from the surface of the grill, to which it was sintered firmly, required special tools and was an arduous work. It required, of course, that the grill was free of coke, which means that the oven was shut down. Thus, the time required for the entire procedure included the time to shut down the oven and reheat it after completion:

#### 7.1.2. Duration of Consecutive Operations

In a letter of Hans Kori to *SS-Sturmbannführer* Lenzer of the POW camp Lublin (Majdanek) of October 23, 1941, the warm water production for 50 showers by using the excess heat of the Kori five-muffle oven was considered for *“täglich bei einem 20 Stundenbetrieb”* (with a daily operation of 20 hours).<sup>154</sup> Since in this project engineer Kori aimed to obtain the highest efficiency possible, it is clear that he expected an interruption of the oven's activity for 4 hours each day, which was probably the time required to clean the fireplaces. We can therefore assume that these ovens normally operated uninterruptedly for 20 hours a day. This does obviously not mean that the ovens were unable to operate for more of 20 hours continuously, but only that they worked more efficiently when subject to a 20/4 hours operating/cleaning rhythm. In his testimony during the trial against Rudolf

<sup>150</sup> Hans Schulze-Manitius, *“Moderne Feuerungsroste”*, *Feuerungstechnik*, yr. XXIII, issue 8, 1935, p. 89.

<sup>151</sup> A.J. ter Linden, *“Feuerräume und Feuerraumwände”*, *Feuerungstechnik*, yr. XXIII, issue 2, 1935, p. 14.

<sup>152</sup> H. Keller, *Mitteilungen über Versuche am Ofen des Krematoriums in Biel*, *op. cit.* (note 29), p. 3.

<sup>153</sup> R. Kessler, *op. cit.* (note 33), issue 9, p. 154.

<sup>154</sup> *APMM*, sygn. VI-9a, vol. 1.



Höß, engineer Roman Dawidowski assumed a period of “3 hours of interruption per day for extracting the cinders from the gas generator and for various smaller activities.”<sup>155</sup>

## 7.2. Simultaneous Cremation of More Than One Corpse in One Muffle

To complete the study of the cremation capacity of the Topf ovens, it remains to be examined if it was possible to increase the capacity of the oven by increasing the load, that is to say, by introducing two or more adult corpses in a single muffle. Such a practice was forbidden by law for civil crematoria. As described above, in the Westerbork crematorium this practice was applied only for the simultaneous cremation of adult corpses with the corpses of babies. In the crematorium of Terezín with its four huge petrol-fired ovens, the simultaneous cremation of two corpses in one muffle was common practice, but the corpses were introduced consecutively, one in front of the other. This procedure required a completely different oven design than that of the Topf ovens for the concentration camp, so the experiences with this crematorium cannot serve as a point of reference for the controversial problem analyzed in this chapter.

### 7.2.1. Experiences with Incineration Ovens of Animal Carcasses

From a practical point of view, the technical approach to simultaneous cremation of several corpses is the operation of incineration ovens for animal carcasses. The following table summarizes the results of the operation of eight oven models for the incineration of animal carcasses by the Kori firm,<sup>156</sup> with:

- 1: type of oven
- 2: maximum load of the oven
- 3: relative consumption of fossil carbon<sup>157</sup>
- 4: duration of combustion process
- 5: quantity of fossil carbon required to incinerate 1 kg of organic substance
- 6: time required to incinerate 1 kg of organic substance
- 7: quantity of organic substance incinerated in 1 min. (in kg)

1	2	3	4	5	6	7
1a	250 kg	110 kg	5.0 h	0.440 kg	72 sec	0.83 kg
1b	310 kg	130 kg	6.0 h	0.419 kg	70 sec	0.86 kg
2a	370 kg	150 kg	7.0 h	0.405 kg	68 sec	0.88 kg
2b	450 kg	170 kg	8.0 h	0.377 kg	64 sec	0.94 kg
3a	540 kg	200 kg	9.5 h	0.370 kg	63 sec	0.95 kg
3b	650 kg	225 kg	10.5 h	0.346 kg	58 sec	1.03 kg
4a	750 kg	265 kg	12.0 h	0.353 kg	58 sec	1.04 kg
4b	900 kg	300 kg	13.5 h	0.333 kg	54 sec	1.11 kg

These data are valid points of reference for the subject of this chapter, because these ovens really performed simultaneous cremations of several animal carcasses, or parts of them, in the same muffle. In the oven with the highest capacity, model 4b, the simultaneous incineration of 900 kg of organic substance required 54 seconds and consumed 0.333 kg of fossil carbon per kg of organic substance. For 70 kg of organic substance (an average adult human), this corresponds to 63 minutes and 23.3 kg of fossil carbon. The oven model 2b had a muffle with a surface area (1.38 m<sup>2</sup>), which was quite comparable to that of the Topf triple-muffle oven (1.4 m<sup>2</sup>). In this oven model, the cremation of several corpses of a total weight equal to the greatest load (450 kg) would have resulted in a

<sup>155</sup> AGK, NTN, 93, p. 47.

<sup>156</sup> W. Heepke, *Die Kadaver-Vernichtungsanlage*, Verlag von Carl Marhold, Halle a. S. 1905, p. 43.

<sup>157</sup> This is a theoretical figure assuming carbon that has no other components in it, neither combustible nor incombustible. This way, the influence of coal and coke of various caloric values is eliminated.

cremation time of 75 minutes and a fuel consumption of coke equal to 28.2 for each corpse of 70 kg. However, since the Kori oven had been specially designed for the mass incineration of animals carcasses, these data cannot be transferred directly to the Topf ovens, which means that with the same load, the Topf ovens would have required more time and fuel. In other words: It is feasible to state that simultaneous cremations of multiple corpses, instead of their subsequent cremation, would not have resulted in any savings in the ovens of Auschwitz-Birkenau, neither in time nor in fuel.

### 7.2.2. The Experiences of the Westerbork Crematorium

The experiences from the consecutive cremations in Westerbork confirm this conclusion. As indicated in chapter 6.3., the corpses of two adults were never cremated together in this crematorium. The only kind of simultaneous cremation was that of an adult corpse together with the corpse of a baby. As shown, this prolonged the average cremation time by 14% (from 50 to 57 minutes), which is at least equal to, if not considerably more than, the percentage as the baby's weight compared to that of the adult ( $5\text{-}10\text{ kg} \div 70\text{ kg} = 7\text{-}14\%$ ). This indicates that the simultaneous cremation of two adults would have at least doubled the duration of the cremation.

### 7.3. Technical Features of the Kori Ovens at Lublin-Majdanek, Sachsenhausen, and Stutthof, according to Soviet Claims

After the liberation of the eastern concentration camps, the Soviets established various 'Investigative Commissions' that investigated, *i.a.*, the technical features of the crematorium ovens at Stutthof camp (May 1945),<sup>158</sup> Sachsenhausen camp (June 1945)<sup>159</sup> and Majdanek camp (August 1944).<sup>160</sup> The Soviet experts established the duration of a cremation on the base of a "*Guiding diagram for the determination of the time of combustion of corpses in various crematorium ovens as a function of the temperature,*" claiming the following relation between temperature and the duration of cremation:

1. Klingenstierna oven:	800°C: 120 min		1,200°C: 60 min	
	900°C: 105 min		3. Schneider oven:	1,300°C: 45 min
2. Siemens oven:	1,000°C: 90 min		1,400°C: 30 min	
	1,100°C: 75 min		1,500°C: 15 min	

The source of the data used to edit the diagram is unknown, but it must be assumed that all data with temperatures over 1000°, which were not reached by any crematorium at that time, must have been extrapolated linearly, which is utterly inadmissible because at a theoretical temperature of 1,600°C, this would lead to a cremation time of zero minutes – and even of negative times beyond that!<sup>161</sup> As described in chapter 3.1, all three ovens listed here were extremely old models. They all operated with the indirect firing method, where only heated air of up to 1000°C was employed for the cremation, which took between 45 and 90 minutes. The Soviet experts performed another inadmissible extrapolation regarding the load of the ovens. Since simultaneous cremation were outlawed in civil crematoria, as a result of which there were no experimental data in this regard, the Soviet experts simply took the data relating to individual cremations, but attributed the cremation times to a muffle loaded with 2 to 12 bodies. But as was shown in the previous chapter, increasing the load of a muffle designed for a single corpse unavoidably leads to a progressive increase of the incineration time. Therefore, this diagram of the Soviet experts is lacking scientific foundation. The

<sup>158</sup> "Protocol about technical features of the SS concentration camp of Stutthof", May 14, 1945. GARF (Gosudarstvenni Archiv Rossiskoi Federatsii, Moscow), 7021-106-216, pp. 5f.

<sup>159</sup> GARF, 7021-104-3, pp. 26-31.

<sup>160</sup> GARF, 7021-107-9, pp. 245-249. The original text of this report was translated in the book by J. Graf, C. Mattogno, *KL Majdanek. Eine historische und technische Studie*. Castle Hill Publisher, Hastings 1998, p. 286 (Engl.: *Concentration Camp Majdanek*, Theses & Dissertations Press, Chicago, IL, 2003).

<sup>161</sup> Cf. also Richard Kessler, *Rationelle Wärme-Wirtschaft... op. cit.* (note 33), p. 136.

coke-fired Kori ovens at Sachsenhausen, Majdanek, and Stutthof with an average operating temperature of 800°C and an average duration of a single cremation of 50 minutes (like the Kori oven at Westerbork) could incinerate 144, 115, and 58 bodies in 24 hours, respectively. This means that the Soviet expert calculated capacities, which were 5 times higher than the actual capacity of the Majdanek crematorium and 10 times higher than that of the Stutthof crematorium! What needs to be pointed out, however, is the fact that not even the Soviet experts dared to attribute cremation times lower than 60 minutes to crematorium ovens operating at maximum temperatures of 1,100°C, which could be reached only for a short moment during the combustion of a coffin.

#### 7.4. The Oven Capacity for Normal Cremations at Auschwitz-Birkenau

Therefore, given the capacity of one body per hour and 20 hours' operation per day, the actual maximum capacity of the Topf cremation ovens of Auschwitz and Birkenau per 24 hours was as follows:

CREMATORIUM	# MUFFLES	OPERATION	CAPACITY
Crematorium I	6	× 20 h/day =	120 normal bodies/day
Crematorium II	15	× 20 h/day =	300 normal bodies/day
Crematorium III	15	× 20 h/day =	300 normal bodies/day
Crematorium IV	8	× 20 h/day =	160 normal bodies/day
Crematorium V	8	× 20 h/day =	160 normal bodies/day
<b>TOTAL</b>	<b>52</b>	<b>× 20 h/day =</b>	<b>1,040 normal bodies/day</b>

This cremation capacity is, however, purely theoretical, because it ignores an important fact: according to the memo of March 17, 1943,<sup>128</sup> the normal activity of the crematoria was only 12 hours per day, thus taking into consideration the inevitable occurring breakdowns of machinery. Hence, the actual capacity was only 60% of the values given above:

CREMATORIUM	# MUFFLES	OPERATION	CAPACITY
Crematorium I	6	× 12 h/day =	72 normal bodies/day
Crematorium II	15	× 12 h/day =	180 normal bodies/day
Crematorium III	15	× 12 h/day =	180 normal bodies/day
Crematorium IV	8	× 12 h/day =	96 normal bodies/day
Crematorium V	8	× 12 h/day =	96 normal bodies/day
<b>TOTAL</b>	<b>52</b>	<b>× 12 h/day =</b>	<b>624 normal bodies/day</b>

#### 7.5. The Reason for Extending the Cremation Facilities in Birkenau

Originally, only one new crematorium with 15 muffles was planned to be erected in Birkenau (crematorium II), but this plan was extended in 1942 to four crematoria with altogether 46 muffles. There were two related reasons for extending the cremation facilities in Birkenau. The first reason was an order given by Himmler during his visit to Auschwitz on July 17 and 18, 1942, to enlarge the camp so that it could hold 200,000 inmates.<sup>162</sup> The second factor was the inmates' mortality, caused by a terrible typhus epidemic that broke out in July 1942.

The August of 1942 was the month with the highest mortality in the entire history of the Auschwitz camp.<sup>163</sup> Some 8,600 inmates died during that month alone, almost double as many as during the previous month (about 4,400 deaths). The first known evidence for the decision to erect three more crematoria is dated August 14, 1942 (which is the date given on the construction drawings no. 1678 for the crematoria IV/V<sup>164</sup>). By August 13, more than 2,500 inmates had already died during

<sup>162</sup> Letter Bischoff to Amt CV of SS-WVHA, Aug. 3 and Aug. 27, 1942. *GARF*, 7021-108-32, p. 37 and 41.

<sup>163</sup> The following figures are based on statistical analysis of the Auschwitz *Sterbebücher*; cf. Staatliches Museum Auschwitz-Birkenau (ed.), *Die Sterbebücher von Auschwitz*, Saur, Munich 1995.

<sup>164</sup> *APMO*, negative n. 20946/6

that month, with an average mortality of more than 190 deaths per day. During the six days of August 14 to 19 – the day which is referred to in the discussions summarized in a memo of August 21<sup>165</sup> –, the mortality was even higher: ca. 2,400 deaths, in average ca. 400 per day. The maximum was reached on August 19 with more than 500 deaths. On August 1, 1942, 21,421 inmates were incarcerated in the men's camp. Until August 19, 4,113 of them had died, in average 216 per day, 1,675 of them between August 14 and 19 (279/day). Between August 1 and 19, 1942, the average strength of the men's camp was 22,900. If already such a small population could result in a mortality of 500 corpses per day, what would have happened if a similar epidemic had erupted with a camp holding 200,000 inmates?

## 8. Operation of the Crematoria of Birkenau

The following table shows from when and until when the crematoria of Birkenau existed:

	TIME IN EXISTENCE	DAYS
Crematorium II	March 15, 1943 – November 27, 1944	624
Crematorium III	June 25, 1943 – November 27, 1944	522
Crematorium IV	March 22, 1943 – October 7, 1944	566
Crematorium V	April 4, 1943 – January 18, 1945	656
Crematoria II and III together		1,145
Crematoria IV and V together		1,222

However, the Topf cremation ovens of Birkenau suffered constantly from defects, which interrupted their activity frequently and sometimes for long periods of time.

Crematorium II was subjected to the first serious repairs a little more than a week after it started operating. On March 24 and 25, 1943, the Topf engineers Prüfer and Schultze came to Auschwitz to verify the extent of the damages.<sup>166</sup> At the beginning of April, it was discovered that the damage was not restricted to the three forced-draft blowers, which had burned out, but that parts of the refractory material of flue and chimney had collapsed,<sup>167</sup> so that the Auschwitz Central Construction Office asked Prüfer during his visit (between April 4 and 9) for a “*new suggestion regarding the chimney lining*”.<sup>168</sup> From a drawing of the Central Construction Office, it turns out that the damage had affected parts of the walls delimiting the chimney's center smoke channel.<sup>169</sup> Thus, this crematorium remained inactive from May 17<sup>170</sup> to September 1, 1943,<sup>171</sup> and was doubtlessly operated only at reduced load between the beginning of April and May 16.

Crematorium III was in service from June 25 to December 31, and crematorium IV from March 22 to May 10.<sup>172</sup> As for crematorium V, it was most likely in service at least until crematorium III was put into operation, in other words for less than three months, from April 4 to June 24.<sup>173</sup>

<sup>165</sup> RGVA, 502-1-313, pp. 159f.

<sup>166</sup> APMO, BW 30/25, p. 8.

<sup>167</sup> APMO, BW 30/34, p. 17.

<sup>168</sup> Memo of Kirschnek from Sept. 14, 1943. RGVA, 502-1-26, p. 144.

<sup>169</sup> The chimney of crematoria II & III was subdivided into three smoke channels with a cross-section of 80 × 120 cm.

<sup>170</sup> Between May 17 and 19, Topf engineer Messing disassembled the three forced-draft blowers of crematorium II (RGVA, 502-1-306, pp. 91-91a). A few days later, the Koehler company began the repair job (RGVA, 502-1-313, p. 37).

<sup>171</sup> The work was probably finished toward the end of August, because on August 30, the Central Construction Office requested various painting products from the Supplies Administration for crematorium II (RGVA, 502-1-314, p. 23).

<sup>172</sup> This date is also only approximate. Cracks already appeared in the eight-muffle oven of crematorium IV as early as April 3 (a); the SS Construction Office's telegram to the Topf firm, dated May 14, 1943, requests “*calculations re. heat engineering for stacks of Crematoria II and IV*” (b). This means that the stack of crematorium IV had also been seriously damaged before this date.

a) APMO, BW 30/34, p. 42.

b) APMO, BW 30/34, p. 41.

Thus the following picture emerges of the service and downtime periods of the four crematoria of Birkenau in 1943:

	TIME PERIOD	EXISTENCE	IN SERVICE	OUT OF SERVICE
Crematorium II	March 15 – Dec. 31	292 days	166 days	126 days
Crematorium III	June 25 – Dec. 31	190 days	190 days	–
Crematorium IV	March 22 – Dec. 31	285 days	50 days	235 days
Crematorium V	April 4 – Dec. 31	272 days	82 days	190 days
<b>TOTAL:</b>		1,039 days	488 days	551 days

Furthermore, from October 21, 1943 to January 27, 1944, in other words for 98 days, several ovens of crematoria II and III were probably out of service due to repairs on 20 oven doors.<sup>174</sup>

The data available for 1944 are less complete.

On February 2, 1944, the Central Construction Office asked the camp commander again for permission to allow the engineers Prüfer and Holick access to the camp:<sup>175</sup>

*“in order to inspect and repair the damages to the large disinfection facility in the POW camp and in the crematoria.”*

On February 22, 1944, the camp administration (*Standortverwaltung*) ordered the Central Construction Office to supply 400 refractory bricks “for urgent repairs of the crematoria.”<sup>176</sup>

On April 3, 1944, an order was issued for the “repair of 20 oven doors” for the ovens of crematoria II and III. These repairs were completed on October 17, *i.e.*, 196 days later.<sup>177</sup>

At the beginning of May 1944, the masonry of the smoke flue and chimney was again damaged, because on May 9, the head of the Central Construction Office of the Birkenau camp asked the camp commandant for a “permission to enter the crematoria I-IV” for the Koehler firm,<sup>178</sup> because it had been “commissioned to make urgent maintenance works at the crematoria.”<sup>179</sup>

Between June 20 and July 20 a further “two large and five small oven doors” were repaired.<sup>180</sup> In 1943, crematorium IV sustained irreparable damage, and crematorium V was also seriously damaged. In early June 1944, there was an attempt to repair them, as the order of June 1 to “repair 30 oven doors” in these crematoria shows.<sup>177</sup>

The repairs were completed on June 6, 1944, and that very same day another order was issued for “repairs” to crematoria II through V. These repairs were completed on September 6.<sup>177</sup> However, if we take Pressac’s word, crematorium IV was used as dormitory from late May 1944 on, for the prisoners making up the *Sonderkommando*.<sup>181</sup> One can thus assume that crematorium IV was not in service at all in 1944, whereas crematorium V was functional from early June 1944 until January 18, 1945, *i.e.*, for 230 days.

We summarize. In 1943 the crematorium II worked at least from April 9 to May 16 at reduced load, *i.e.*, for at least 38 days. The damage to the chimney of crematorium I, which subsequently had to be torn down and rebuilt, should have made the Central Construction Office somewhat careful, so that it is reasonable to assume a 50% operation time for crematorium II for this period of

<sup>173</sup> Pressac claims that crematorium IV was no longer used after September 1943 (a), but does not document his claim. According to R. Höß the crematorium had to be “repeatedly shut down, since the stacks were burnt out after a short period of cremations of about four or six weeks” (b).

a) J.-C. Pressac, *Les crématoires...*, *op. cit.* (note 8), p. 81.

b) M. Broszat (ed.), *Kommandant in Auschwitz. Autobiographische Aufzeichnungen des Rudolf Höß*, dtv, Munich 1981, p. 165.

<sup>174</sup> *APMO*, Dpr.-Hd/11a, p. 95 (Höß Trial).

<sup>175</sup> *RGVA*, 502-1-345, p. 50.

<sup>176</sup> *RGVA*, 502-1-313, p. 13.

<sup>177</sup> *APMO*, Dpr.-Hd/11a, p. 96 (Höß Trial).

<sup>178</sup> The Koehler firm had constructed the smoke flues and chimneys of the crematoria II & III.

<sup>179</sup> *RGVA*, 502-1-83, p. 377.

<sup>180</sup> D. Czech, *op. cit.* (note 78), p. 637.

<sup>181</sup> J.-C. Pressac, *Auschwitz...*, *op. cit.* (note 8), p. 389.

time (= 10 h per day), which is equivalent to 19 days of 100% operation. From May 17 to August 31, crematorium II remained closed for 107 days. In addition to this, some individual ovens were out of service as a result of repairing individual oven doors (20 doors for 294 days and 7 doors for 30 days, which is equivalent to 10 oven doors for ca. 600 days). If taking into account that each triple-muffle oven had ten oven doors and that crematoria II and III had ten such ovens altogether, this amounts to additional 60 days of inactivity for these crematoria. On February 2, 1944, damages to the refractory material of crematoria II and III were discovered, which was repaired by February 22. These damages affected at least two ovens (one in each crematorium), leaving them inactive for at least 25 days, which is equivalent to  $(25 \div 5 =)$  5 days of activity for each crematorium. At the beginning of May 1944, damages to the refractory material were discovered in the flues and /or chimneys of crematorium II, III, and V. In lack of any sources, we assume that the ensuing intensive repairs took only 3 days to complete for each crematorium. In 1944, therefore, crematoria II and III remained inactive for at least  $(60+5+5+3+3=)$  76 days, or in average 38 days per crematorium, and crematorium V for at least 3 days.

Thus, the service times for the cremation ovens of Birkenau for the year 1944 and for January 1945 may be summarized as follows; however, this does not take into account the downtime of individual ovens as mentioned previously:

	TIME PERIOD	DAYS	IN SERVICE	OUT OF SERVICE
Crematorium II	Jan. 1 – Oct. 30/44	304	266	38
Crematorium III	Jan. 1 – Oct. 30/44	304	266	38
Crematorium IV	–	–	–	–
Crematorium V	Jan. 1 – Oct. 30/44	304	144	160
<b>TOTAL:</b>		912	676	236

Now we can calculate the total number of days on which the crematoria of Birkenau were in service:

	DAYS IN SERVICE	DAYS IN SERVICE
Crematoria II and III together:	888	Crematoria IV and V together: 276

From March 15, 1943, to October 30, 1944, ca. 50,000 registered inmates died a ‘natural death’ in the camp. Assuming that their corpses were cremated in proportion to the days of activity and the number of muffles of the crematoria (crematoria II & III = 86%, crematoria IV & V = 14%), this means that ca. 43,000 corpses were cremated in crematoria II & III and ca. 7,000 in crematoria IV & V. In case of 20 days of activity of the cremation ovens (see table chapter 7.4.), the cremation of these bodies required thus:

Crematoria II & III:  $(43,000 \text{ corpses} \div 300 \text{ corpses/day} =)$  143 days of both crematoria together

Crematoria IV & V:  $(7,000 \text{ corpses} \div 160 \text{ corpses/day} =)$  44 days of both crematoria together

So for further cremations there would have remained:

Crematoria II & III:  $(888 - 143 =)$  745 days of both crematoria together

Crematoria IV & V:  $(276 - 44 =)$  232 days of both crematoria together

The number of the corpses of alleged gassed victims that could have been cremated is therefore:<sup>182</sup>

Crematoria II & III:  $(745 \times 360 \text{ corpses/day} =)$  268,200

Crematoria IV & V:  $(232 \times 192 \text{ corpses/day} =)$  44,500

---

In Total: 312,700

Even though these figures are based on real data, they are merely theoretical. In the reality, another factor influenced the number of possible cremations in a decisive manner: the duration of the refractory material of the muffles.

<sup>182</sup> I have increased the capacity of the crematoria by  $1/6$  to take into consideration the cremation of children.

## 9. Durability of the Firebrick of the Cremation Ovens

As a result of thermal stresses, the fireproof brick of a cremation oven inevitably wears out, and eventually this becomes a serious hazard. In the civilian cremation ovens which had been constructed in the usual manner and with the building materials normally used in the 1930s, the lifespan of the fireproof brick was about 2,000 cremations, but the Topf firm had managed to extend its durability to 3,000 cremations.<sup>183</sup>

In the cremation ovens in the concentration camps, the problem of wear and tear on the fireproof brick was greater, not only because of the lesser mass of this fireproof material and its lower quality, but also because of the greater rate of use of the facility, and also due to its operation by untrained personnel whose hostile attitude to their work may very well have been reflected in the carelessness they showed in performing that work.

The very real impact of these factors is demonstrated by the case of the Topf double-muffle cremation oven at Gusen. This oven went into service on January 29, 1941<sup>184</sup> but was already damaged only eight months later. On September 24 the SS Construction Office of the concentration camp Mauthausen requested the Topf firm to “*immediately dispatch one of your oven specialists to repair the cremation oven in the labor camp Gusen.*”<sup>185</sup> Topf sent the fitter August Willing, who arrived in Gusen on October 11 and went to work the next day. From the relevant “*receipts for special billing re. day-rate jobs*” we know that this work took from October 12 to November 9, 1941. In 68 work hours in the week of October 16 to 22 he replaced the fireproof brick of the oven (“*dismantling the oven, and rebuilding inside*”). In 52 work hours the following week he finished lining the outside brickwork and performed a test cremation. Willing remained at Gusen until November 9 to tune the oven properly and to supervise its operation.<sup>186</sup>

From February to October 1941, in a period of 273 days, 3,179 inmates died in the Gusen camp;<sup>187</sup> this means that about 1,600 cremations took place in each muffle. This would confirm the average lifespan of the firebrick in a muffle as being about 2,000 cremations. But even assuming that the ovens had been used to the absolute limit of their capacity, the firebrick could not have lasted for more than 3,000 cremations.

Thus, the 46 muffles in the cremation ovens of Birkenau could have cremated a maximum of (46 × 3,000 =) 138,000 bodies. After that, they would have had to be dismantled in order to replace the firebrick.

If Pressac were correct in his assumption that these ovens served for the cremation of not only the 100,000 registered inmates who died of natural causes and are proven to have been cremated here, but also for the cremation of an additional 530,000 gassing victims, then the brickwork of the muffles would have had to be replaced (630,000 ÷ 138,000 =) approximately five times. For crematoria II and III alone this would have required 320,000 kg (705,600 lbs) of fireproof material – not to mention the inevitable damage done to the fireproof inner lining of the generators – and if we take the time needed by August Willing in Gusen as guideline, the work would have taken about 9,000 man-hours to complete.

All this would have generated an immense number of documents, yet the extensive correspondence between the Topf firm and the SS Construction Office contains no trace of such paperwork. There are not even any indirect references or other clues that would hint at such a mammoth task – with one single exception: a letter from Topf to the SS Construction Office, dated December 9, 1941, which in-

<sup>183</sup> R. Jakobsköter, “*Die Entwicklung der elektrischen Einäscherung...*”, *op. cit.* (note 48), p. 583.

<sup>184</sup> This date follows from the list of coke deliveries to the crematorium of Gusen. *ÖDMM*, B 12/31, p. 352.

<sup>185</sup> Letter from the SS Construction Office of the concentration camp Mauthausen to the Topf firm, Sept. 24, 1941. *BAK*, NS 4 Ma/54.

<sup>186</sup> J. A. Topf & Söhne, receipts for special billing regarding day-rate jobs, Oct. 12 – Nov. 9, 1941. *BAK*, NS 4 Ma/54.

<sup>187</sup> Hans Marsalek, *Die Geschichte des Konzentrationslagers Mauthausen. Dokumentation*, Österreichische Lagergemeinschaft Mauthausen, Vienna 1980, p. 156.

dicates that the Construction Office had ordered “one wagonload of firebrick” from Topf. This material, which was enough “for the new construction of one oven”, was to be used “as replacement material for repair work.”<sup>188</sup>

Taking into consideration this restoration of the fireproof brick of two muffles, the six muffles of the Auschwitz I (the Main Camp) were able to cremate a total of 24,000 bodies.

From all this it follows that the ovens of Auschwitz I and Birkenau (Auschwitz II) altogether were able to cremate about (138,000 + 24,000 =) 162,000 bodies during the period of their existence. This figure agrees quite well with the number of known, deceased registered inmates.

Thus, the cremation of the supposed gassing victims was physically impossible in technological respects as well.

## 10. The Number of Cremations in the Crematoria of Birkenau

### 10.1. The SS Estimate

As quoted before, civil engineer Jährling calculated the coke requirements of the four crematoria of Birkenau in a memo of March 17, 1943, “on the basis of data from the firm Topf & Söhne (builder of the ovens) of March 11, 1943”,<sup>128</sup> based on a daily operation time of 12 hours. The Topf letter mentioned by Jährling has not been located. It might have referred to the combustion capacity of the fireplace only, but we are looking for the coke consumption as a function of the number of cremations. Since the coke consumption is also a function of the type of corpse cremated (for emaciated bodies, the quantity of coke estimated by Jährling would have sufficed for 370 bodies),<sup>189</sup> it is preferable to consider the duration of the cremation process, which was in average an hour, plus an additional hour for heating the oven. This means that 506 bodies could have been cremated within 12 hours. From January 1 to March 10, 1943, ca. 14,800 inmates died in Auschwitz, in average 207 per day. In February 1943, the mortality was ca. 7,400 inmates, in average 264 per day.<sup>163</sup> In the same period, according to the *Kalendarium* of Danuta Czech, the number of the alleged gassing victims was ca. 72,700, in average 1,054 per day. Therefore, if there had been any homicidal gasings, calculations for coke consumption and hours of operation would have been based upon 1,250 corpses per day. This figure corresponds to of 17,875 kg of coke<sup>190</sup> compared to the actual estimate of 7,840 kg, and would have required a daily operation of (1,250 ÷ 46 =) 27 hours! This shows that Jährling’s calculations referred exclusively to corpses of registered inmates who died a ‘natural’ death. But even this calculation was enormously exaggerated, because between March 15 and October 25, 1943 (224 days), only 628.5 tons of coke were supplied to the crematoria of Auschwitz-Birkenau, in average 2.8 tons per day, which is only slightly more than a third of Jährling’s estimate. This will be the topic of the next chapter.

### 10.2. The Number of Cremations in 1943: Coke Fuel Consumption

The archives of the Auschwitz Museum contain hundreds of receipts documenting deliveries of coke fuel to the crematoria.<sup>191</sup> A member of the museum staff has compiled a per-month list of the quantities specified on each of these receipts. We have in our possession a list of the coke deliveries for the time from February 16, 1942 to October 25, 1943.<sup>192</sup>

<sup>188</sup> APMO, BW 11/1, p. 4.

<sup>189</sup> See the calculation on that in the first English version of this article, *op. cit.*, (note 3), p. 406.

<sup>190</sup> See table on page 393 of this article: 15.7 kg/h for crematoria II & III, 11.7 kg/h for crematoria IV & V, average: 14.3 kg/h;  $1,250 \times 14.3 = 17,875$ .

<sup>191</sup> Receipt. APMO, segregator 22a, sygn. D-AuI-4, no. 12025-12031.

<sup>192</sup> APMO, D-AuI-4, segregator 22, 22a.



By means of a calculation, J.-C. Pressac has shown that these deliveries are complete as listed.<sup>193</sup> For 1943 they were as follows:

MONTH	COKE [METRIC TONS]	MONTH	COKE [METRIC TONS]
March	144.5	July	67.0
April	60.0	August	71.0
May	91.0	September	61.0
June	61.0	October	82.0

Thus, from March 15 to October 25, 1943, a total amount of 607 tons of coke was delivered to the crematoria. Furthermore, a total of 96 m<sup>3</sup> (3,390 cu.ft.) of wood was delivered in the months of September and October.

The 96 m<sup>3</sup> (3,390 cu.ft.) of wood that were delivered in September and October correspond to about 43 metric tons. If we set the calorific value of one kilogram of wood equal to that of half a kilogram of coke, then 43 metric tons of wood correspond to 21.5 metric tons of coke. On the basis of this relationship we can equate the calorific value of the coke and wood supplied with a total of (607 + 21.5 =) 628.5 metric tons of coke.

From March 15 to October 25, 1943, ca. 16,000 registered inmates died,<sup>163</sup> which means that the coke consumption per corpse was (628,500 ÷ 16,000 =) 39.3 kg. This figure also includes the quantity of coke necessary to preheat the ovens. In chapter 5.4., the importance of this factor on the coke consumption was indicated. It will be emphasized here with an example from the oven at Gusen.

From 26 September to October 15, 1941 (20 days), 193 corpses were cremated in this oven during 10 days of activity. That means that the oven operated in average every second day, each time cremating 19 corpses and consuming 47.5 kg of coke per corpse.

From October 26 to 30 (5 days), 129 corpses were cremated, some of them each day, in average 26 corpses per day with 37.2 kg of coke per corpse.

From October 31 to November 12 (13 days), 677 were cremated, as already mentioned. In a daily cycle, in average 52 corpses were cremated requiring 30.6 kg of coke per body.

This means that changing the operation mode from sporadic (19/day)<sup>194</sup> to continuous (52/day) decreased the coke consumption from 47.5 down to 30.6 kg/body, which is a saving of 35.6%,<sup>195</sup> an amount used to heat up the oven when operated discontinuously. Applying this factor to the coke consumption of the ovens at Auschwitz-Birkenau for emaciated corpses, so that we obtain the coke consumption per corpse for a discontinuous operation (operation only every second day), leads to the following results:

Crematorium I:	$32.5 \div 0.6442 = 50.4$ kg
Crematorium II & III:	$22.0 \div 0.6442 = 34.1$ kg
Crematorium IV & V:	$16.0 \div 0.6442 = 24.8$ kg

From March 15 to August 31, 1943, 3,374 registered inmates died in the Auschwitz main camp alone, as recorded in the *Leichenhallenbuch* (Mortuary Book).<sup>196</sup> Considered the decreasing mortality during July (277) and August (215), the total until October 25 might have amounted to 4,000, which were cremated in crematorium I. From March 15 to October 25, 1943, the crematoria II and III were in service for 222 days, the crematoria IV and V for 132 days. Considering the days of activity and the available muffles, crematoria II & III had 76% of the entire cremation capacity of the camp during that time, whereas crematoria IV & V had 24%. Assuming that cremations took place according to this percentage, this results in:

<sup>193</sup> J.-C. Pressac, *Auschwitz...*, *op. cit.* (note 8), p. 224.

<sup>194</sup> It must be kept in mind that this oven had two muffles, so 19 cremations per day correspond to ca. 10 loadings.

<sup>195</sup> In the intermediate case – numerous, but not many cremations each day, – coke saving would be ca. 1/6.

<sup>196</sup> AGK, NTN 92, pp. 141f. (statistic recapitulation by Jan Sehn).

Crematorium I:	$16,000 - \cong 4,000 \cong$	12,000 bodies
Crematoria II & III:	$12,000 \times 0.76 \cong$	9,100 bodies
Crematoria IV & V:	$12,000 \times 0.24 \cong$	2,900 bodies

The consumptions of coke were therefore as follows:

Crematorium I:	$4,000 \times 32.5 =$	130,000 kg
Crematoria II & III:	$9,100 \times 22 =$	200,200 kg
Crematoria IV & V:	$2,900 \times 16 =$	46,400 kg
<b>Total:</b>		<b>376,600 kg</b>

This total corresponds to  $(376,600 \div 628,500 \times 100 =)$  59.9% of the total supplies during this time, a percentage that is very close to that calculated above for the oven at Gusen (64.4%). The quantity of coke delivered to the crematoria was therefore full compatible with a discontinuous cremation of the corpses of the registered inmates who had died a ‘natural’ death.

We will now examine the assumption of homicidal gassings. According to Czech’s *Kalendarium*, 116,794 persons were gassed between March 15 and October 25, 1943, or rounded up 116,800. As F. Piper confirms,<sup>197</sup> no cremations took place in burning pits in the open in 1943 after crematorium II had been put into service. This means that all corpses of alleged gassings had to be cremated in crematorium ovens. As shown above, at least 376,600 kg of the total delivery of 628,500 kg of coke was required to cremate the corpses of the 16,000 registered inmates who died a ‘natural’ death during this time, which left  $(628,500 - 376,600 =)$  251,900 kg of coke for the cremation of the claimed gassing victims. We assume the most favorable case that these cremations were evenly spread out over time (which is very doubtful from a historical point of view), that all victims had normal bodies, and that the consumption decreased by  $\frac{1}{6}$  due to the presence of children. This results in the following:

Crematoria II & III:	$116,800 \times 0.76 \cong$	88,800 bodies $\times (16 \times \frac{5}{6}) =$	1,184,000 kg
Crematoria IV & V:	$116,800 \times 0.24 \cong$	28,000 bodies $\times (12 \times \frac{5}{6}) =$	280,000 kg
<b>Total:</b>		<b>116,800 bodies</b>	<b>1,464,000 kg</b>

Hence, the cremation of the 116,800 gassing victims would have required at least 1,464,000 kg of coke, but only a maximum of 251,900 kg was available, which would have resulted in  $(251,900 \div 116,800 =)$  2.15 kg of coke per corpse, a quantity that would have been absolutely insufficient to carry out any cremation.

All this points to a plain and simple conclusion: the coke deliveries from March to October 1943 prove indisputably that only the bodies of the inmates who had died of natural causes could be cremated in the crematoria.

THEREFORE, NO MASS MURDERS TOOK PLACE IN AUSCHWITZ AND BIRKENAU IN THE TIME FROM MARCH TO OCTOBER 1943!

## 11. The ‘Burning Pits’ of Birkenau

### 11.1. The Chief Witness, Filip Müller

The foremost ‘witness’ for this manner of body disposal is Filip Müller, who speaks of five pits located in the northern yard of crematorium V. His account is quite long-winded; we shall quote the most important points:<sup>198</sup>

*“The two pits [that had been dug] were 40 to 50 meters long, about 8 meters wide and 2 meters deep. However, this particular place of torment was not yet ready for use by any means. Once the rough work*

<sup>197</sup> F. Piper, “Gas Chambers and Crematoria”, in: Y. Gutman, M. Berenbaum (eds.), *Anatomy of the Auschwitz Death Camp*. Indiana University Press, Bloomington and Indianapolis 1994, p. 164.

<sup>198</sup> Filip Müller, *Auschwitz Inferno: Testimony of a Sonderkommando*, Routledge & Kegan Paul, London 1979, p. 130.

was finished, there followed the realization of the refinements thought up by the arch-exterminator's [Otto Moll's] warped ingenuity.

Together with his assistant, Eckardt, he climbed down into the pit and marked out a 25 centimeters by 30 centimeters wide strip, running lengthways down the middle from end to end. By digging a channel which sloped slightly to either side from the center point, it would be possible to catch the fat exuding from the corpses as they were burning in the pit, in two collecting pans at either end of the channel."

After this work was finished, Moll allegedly climbed into the pit to test the incline of the drain channel with a bucket of water. The incline turns out to be inadequate. It is made steeper, and in the next test the water runs along the channel and flows into a container placed at its end.<sup>199</sup> Müller continues:<sup>200</sup>

"As it began to grow light, the fire was lit in two of the pits in which about 2,500 dead bodies lay piled one on top of the other. Two hours later all that could be discerned in the white-hot flames were countless charred and scorched shapes, their blackish-phosphorescent hue a sign that they were in an advanced stage of cremation. At this point the fire had to be kept going from outside because the pyre which at first protruded about half a meter above the edge of pit had, in the meantime, gone below this level. While in the crematorium ovens, once corpses were thoroughly alight, it was possible to maintain a lasting red heat with the help of fans, in the pits the fire would burn only as long as the air could circulate freely in between the bodies. As the heap of bodies settled, no air was able to get in from outside. This meant that we stokers had to constantly pour oil or wood alcohol on the burning corpses, in addition to human fat, large quantities of which had collected and was boiling in the two collecting pans on either side of the pit. The sizzling fat was scooped out with buckets on a long curved rod and poured all over the pit causing flames to leap up amid much crackling and hissing. Dense smoke and fumes rose incessantly. The air reeked of oil, fat, benzene and burnt flesh. [...]

Some twenty-five bearers were employed in clearing the gas chamber and removing the corpses to the pits. [...] About fifteen stokers had to place the fuel in the pit and to light and maintain the fire by constantly stoking in between the corpses and pouring oil, wood alcohol and liquid human fat over them. There were approximately thirty-five men in the ash team. Some had to dig the ashes from the pits and remove them to the ash depot. The others were busy pulverizing the ashes. [...]

In order to prepare the third pit for cremation old railway sleepers, wooden beams, planks, and sawdust were arranged in layers and covered with a layer of dry fir branches. Then the bearers laid about 400 corpses face upwards in four long rows on top of the fuel. The next layer again consisted of fuel covered, as before, with fir branches. Then followed another layer of corpses. This sequence was repeated once more until, in the end, there were some 1,200 dead bodies in three layers. Meanwhile the stokers had soaked pieces of material and rags in oil and wood alcohol and stuffed them in between the fuel in many places."

The cremation allegedly took five to six hours:<sup>201</sup>

"In the meantime [the fire] had gone out [in the two other pits]. The process of incineration took five to six hours. What was left barely filled a third of the pit."

## 11.2. The Method of Scooping Human Fat

The flashpoint of animal fats is 184°C (363°F).<sup>202</sup> This means that in the presence of fire or embers, animal fats – and human fat also belongs in this category – ignites at 184°C (363°F). Therefore burning wood would inevitably ignite any fat exuding from the corpses. This effect is familiar to anyone who has ever barbecued and had fat drip from his steak into the charcoal: the entire grill is quickly ablaze.

---

<sup>199</sup> *Ibid.*, pp. 131-132.

<sup>200</sup> *Ibid.*, pp. 136f.

<sup>201</sup> *Ibid.*, p. 138.

<sup>202</sup> J. H. Perry, *Chemical Engineer's Handbook*, Wilmington, Delaware, 1949, p. 1584.

Thus, the set-up described by Filip Müller is outrageous nonsense and would not allow for any scooping of the fat whatsoever.<sup>203</sup>

### 11.3. Open-Air Cremations That Actually Did Take Place

John C. Ball demonstrates in the present volume that the air photos taken of Auschwitz by the Allies show no traces of mass incinerations in pits. Aside from the above arguments, we have also explained other reasons that would show the mass incinerations alleged to have taken place in open pits to be impossible.<sup>203</sup>

However, this is by no means to say that no incinerations were carried out in Birkenau in the open air – on pyres or in rudimentary open ovens.

One may reasonably assume that in late 1941, when the mortality rate in Auschwitz rose to frightening proportions, many bodies were taken to Birkenau and buried there in mass graves. According to the Mortuary Book and the Book of the Dead, 1,358 inmates and 3,726 Soviet prisoners-of-war died in November 1941, a total of 5,084 people, 169 per day on average. At that time the crematorium of the Main Camp had only two ovens whose maximum capacity altogether was 84 bodies per day and which, on top of everything else, had sustained some damage.<sup>204</sup> The coke deliveries to the crematorium also prove that only a portion of the deceased inmates could have been cremated. From November 1, 1941 to January 31, 1942, the crematorium received 93.6 metric tons of coke, which would have sufficed for 3,000 bodies at the very most; however, a total of 9,355 inmates died during that period. In the following months the crematorium could just barely handle the cremation of the people who died in the Main Camp. On March 1, 1942, the Soviet prisoners-of-war were taken to Birkenau.<sup>205</sup> On August 6, the inmates of the Women's Camp, which had been opened on March 26, were also transferred there.<sup>206</sup> From March 1, 1942, to February 28, 1943, 14,515 male inmates died in the Main Camp and were registered in the Mortuary Book, and several thousand female inmates also died, but during this same time only 373.5 metric tons of coke were supplied to the crematorium, which would have sufficed for the cremation of at most some 12,200 bodies. All the bodies of inmates who died in Birkenau were buried in mass graves.

In the following months the mortality rate rose sharply due to the dreadful typhus epidemic that had broken out in acute form in July 1942. As a consequence of this epidemic the Head of the camp, Commandant Rudolf Höß, ordered the camp “*completely closed off*” on July 23, 1942.<sup>207</sup>

In other words, bodies buried in mass graves also included many thousands of typhus victims, which made sanitary conditions in Birkenau even more catastrophic, especially if one considers the high water table of Birkenau, which must have swamped the graves quickly. It is easy to believe Pery Broad when he writes – albeit with propagandistic embellishments – that the body toxins of the buried had contaminated the ground water in the entire area,<sup>208</sup> which resulted in the massive death of fish in the lakes surrounding Birkenau, particularly in Harmense.<sup>209</sup> And in fact the pollution by body toxins

<sup>203</sup> For details see our main work, *op. cit.* (note 2), and note 5. Myroslaw Dragan recently conducted an experiment by incinerating a deer carcass in a pit which turned out to be a slow, but feasible method to reduce an animal to ashes; paper to be published in *Vierteljahreshefte für freie Geschichtsforschung* and *The Revisionist*.

<sup>204</sup> The Dec. 9, 1941, letter from the Topf firm to the SS Construction Office of Auschwitz mentions “*a repair of the two coke-fired double-muffle cremation ovens*” which had already been carried out. *APMO*, BW 11/1, p. 4.

<sup>205</sup> D. Czech, *op. cit.* (note 78), p. 139.

<sup>206</sup> *Ibid.*, pp. 148, 212.

<sup>207</sup> *APMO*, camp order. t.l. camp order no. 19/42, sygn. A-AuI-1, p. 17.

<sup>208</sup> About the ground water table in Birkenau cf. Michael Gärtner, Werner Rademacher, “*Ground Water in the Area of the POW camp Birkenau*”, *TR* 1(1)(2003), pp. 3-12 (online: [vho.org/tr/2003/1/GaertnerRademacher3-12.html](http://vho.org/tr/2003/1/GaertnerRademacher3-12.html)); Carlo Mattogno, “*Cremation Pits' and Ground Water Levels at Birkenau*”, *The Revisionist*, 1(1) (2003), pp. 14-17 (online: [vho.org/tr/2003/1/Mattogno14-17.html](http://vho.org/tr/2003/1/Mattogno14-17.html)).

<sup>209</sup> P. Broad, “*Erinnerungen*”, in J. Bezwinska, Danuta Czech, *Auschwitz in den Augen der SS*, 3<sup>rd</sup> ed., Krajowa Agencja Wydawnictwa, Katowice 1981, pp. 165f. Broad makes the anachronistic claim that the mass graves were opened after the discovery of the graves of Katyn (Feb. 1943).

– pollution not only of the ground water but also of the soil and the air<sup>210</sup> – had been one of the main arguments of the proponents of cremation in the late 19<sup>th</sup> century!<sup>211</sup>

The SS in Auschwitz countered this dreadful sanitary problem for the long term by planning the four crematoria of Birkenau (one of which – the one that was to become crematorium II – had already been planned in October 1941, but for the Main Camp) and by the efficient installation of disinfestation and delousing facilities (the Central Sauna), and for the short term by exhuming and burning the bodies.

The decision to construct the crematoria of Birkenau was made in August 1942,<sup>164</sup> at a time when the mortality rate averaged 270 inmates a day due to the typhus epidemic, and this with an average camp population of some 22,000 male and 10,000 female inmates (in August 1942). On the occasion of his inspection of the camp on July 17 and 18, 1942, Himmler had ordered that POW camp Birkenau's initial intended capacity of 125,000 be increased to 200,000. Under these circumstances, it is clear that the 550-per-day capacity of the Birkenau crematoria (for which the memo of March 17, 1943 provides for a daily operation time of 12 hours) was by no means exaggerated in view of potential future epidemics among a three- or four-fold greater camp population.

Little is known about the opening of mass graves and incineration of bodies contained therein. On September 17, 1942, SS-Untersturmführer Walter Dejaco, who together with his colleague Hössler had accompanied Camp Commandant Rudolf Höß to Litzmannstadt (Lodz), drew up a “*travel report*” in which he mentioned that the purpose of the trip had been the “*visual inspection of the special facility, and discussions with SS-Standartenführer Blobel about the implementation of such a facility.*” This special facility was almost certainly a means for incinerating bodies in the open air. Dejaco also reported that the construction materials ordered from the *Ostdeutsche Baustoffwerke* in Posen via “*special order by Staf. Blobel*” had to be delivered to Auschwitz immediately; and that the firm of Schriever & Co. in Hannover had to supply a “*ball grinder for substances*”.<sup>212</sup> This was most likely a device for grinding up the residue left after incineration.

According to Danuta Czech's *Auschwitz Chronicle, 1939-1945*, incineration of exhumed bodies began on September 21,<sup>213</sup> which seems quite credible, and ended in November. It is not known how these bodies were burned, but most definitely not in burning pits. Mass graves were almost certainly located to the southwest of the “*temporary earth basin*”, about 650 ft. west of what was to become Sector BIII of Birkenau, since the air photos from 1944 – specifically those from May 31 – show traces of four huge, parallel trenches in that area. (See the chapter by J. C. Ball, this volume.)

The majority of the inmates who died between September 23, 1942 and the opening of the crematoria were also burnt in the open air.

However, if traces of mass cremations of human beings are in fact found in the vicinity of the former camp Birkenau,<sup>214</sup> this does not in any way mean that the camp was the site of mass murders.

<sup>210</sup> Ptomaines – discovered by Prof. Selmi in Bologna, Italy – are toxic alkaloids forming in dead bodies during putrefaction.

<sup>211</sup> “*Ground water is even better suited than soil and air to spreading the products of putrefaction; it is all the more dangerous in that the underground watercourses can undergo changes which are not noticeable at the surface.*” – “*The hazards of earth burial increase when the bodies are those of victims of infectious diseases.*” M. Pauly, *op. cit.* (note 19), pp. 24f.

<sup>212</sup> NO-4467.

<sup>213</sup> D. Czech, *op. cit.* (note 78), p. 242.

<sup>214</sup> Udo Walendy, *Historische Tatsachen*, no. 60, Verlag für Volkstum und Zeitgeschichtsforschung, Vlotho 1993, pp. 7-10, discusses an expert report of the Polish firm “*Hydrokop*” which conducted some explorative drillings in Birkenau soil and allegedly found such traces. See also note 30 in J. C. Ball's chapter, this volume.

# The Gas Chambers of Majdanek<sup>1</sup>

CARLO MATTOGNO

## Introduction

It was in August of 1944 that a Polish-Soviet investigation committee announced the existence of homicidal gas chambers in the Lublin concentration camp known as “*Majdanek*”. The Polish historians who were responsible for giving credence to ‘findings’ of that committee were confronted with some highly perplexing difficulties; for one thing, the gas chambers which are mentioned in the remaining documentation of the Central Construction Administration of the Majdanek concentration camp are invariably designated as “*Delousing Chambers*” or “*Disinfestation Chambers*”, and secondly, for all practical purposes, there are no eyewitness reports of human beings being homicidally gassed. Polish historiography ‘solved’ the first problem by presupposing the use of ‘camouflage’ language, which means that documents referring to delousing and disinfestation were said to be referring to homicidal gassings of human beings. Deliveries of Zyklon to the camp were interpreted in the same way.

As for the another problem, although it was not able to offer even one eyewitness to describe the alleged homicidal gassing process in a reasonably concrete manner, Polish historiography managed to cook up an atmosphere of homicidal mass gassings by means of short and extremely vague descriptions of (alleged) homicidal gassings. In this manner, a refined system of argument was created in which the decisive proof of the existence of homicidal gas chambers at Majdanek consisted of merely the existence of locations which are alleged to have been gas chambers. This principal item of material proof is supported by two auxiliary proofs: eyewitness testimonies (in the sense mentioned above) and deliveries of Zyklon.

The material proof should in no way be underestimated, since the larger of the alleged homicidal gas chambers – and according to Polish historiography – the chamber most intensively used for criminal purposes, originally were authentic Zyklon B gas chambers. As a matter of fact, even today (or as of this writing) it can be easily proven that cyanide gas was used in these chambers as shown by the intensive blue staining of the walls. Two of the alleged homicidal gas chambers, contain special installations which appear to have been used for the diffusion of carbon monoxide (CO). The problem is therefore an extremely serious one and requires a thorough investigation of both the remaining documents, as well as of the locations concerned.

This present paper,<sup>2</sup> addressing this topic, is intended to provide a decisive answer to the question: **Were there homicidal gas chambers at Majdanek?**

---

<sup>1</sup> This article is an abridged and modified version of the chapter on “*The Gas Chambers*” in the book by Carlo Mattogno and Jürgen Graf on the *Concentration Camp Majdanek. A historical and technical Study*, Theses & Dissertations Press, Chicago 2003 (online: [vho.org/GB/Books/ccm](http://vho.org/GB/Books/ccm)), translated and edited by Carlos Porter and Russ Granata.

<sup>2</sup> The anthology published by Ernst Gauss (ed.), *Grundlagen zur Zeitgeschichte: Ein Handbuch über strittige Fragen des 20ten Jahrhunderts*, Grabert, Tübingen 1994, contains on pages 276-279, a contribution written by Germar Rudolf entitled “*The Gas Chambers of Majdanek*”. Rudolf has not, however, personally inspected the alleged extermination installation in that camp. His critical analysis is partly based on the conclusions drawn by myself during my investigations in July 1992, as well as on the photographs prepared by myself at that time, which I made available to Rudolf together with the necessary explanatory material, for the above-mentioned work. Five of the concerned photographs, as well as my most important comments, are reproduced in his article on pages 257-278.

## 1. The number and purpose of the gas chambers:

### The Polish-Soviet expert report of 4-23 August 1944.

On August 4, 1944, hardly two weeks after the liberation (*i.e.*, the Allied military occupation) of Majdanek, a Polish-Soviet committee carried out their technical and chemical examination of reported mass homicidal gassing installations in that camp. The work was finished on August 23. The Polish-Soviet committee located seven gas chambers on the grounds of the camp, accurate drawings of which were prepared.<sup>3</sup> The most important information on these premises are summarized in the following table.<sup>4</sup>

LOCALITY	POSITION & DESIGNATION	DIMENSION [M]	SURFACE AREA M <sup>2</sup>
Chamber I	<i>Disinfestation installation</i> SE	4.50 × 3.80	17.1
Chamber II	<i>Disinfestation installation</i> NE	4.50 × 3.80	17.1
Chamber III	<i>Disinfestation/Delousing</i>	9.27 × 3.80	35.2
Chamber IV	Barracks 41 <i>gas chamber</i> adjacent to the shower room		72.2 <sup>5</sup>
Chamber V	Barracks 28 Drying installation	11.75 × 6.00	70.5
Chamber VI	Barracks 28 Drying installation	11.75 × 6.00	70.5
Chamber VII	New crematorium, room between morgue and dissection room	6.10 × 5.62	34.9
Cell 14	<i>Disinfestation installation</i> cell fronting Chambers I and II	2.15 × 1.73	3.7

In their conclusions, the committee stated that Chambers I, II, III, IV and VII, were planned and built for mass homicidal extermination, while Chambers V and VI could have been used as disinfection chambers, but were used exclusively for murdered camp inmates' clothing disinfection. Furthermore, in barracks used for stocking chemical products, the committee found the following 52 objects:

- a) five empty containers for carbon monoxide;
- b) one can with a carbon monoxide filter from AUER Company A.G. of Berlin;
- c) 135 Zyklon B canisters with a capacity of 500 grams each, as well as 400 cans, each with a capacity of 1500 grams; 90% of these cans were empty.

The committee also prepared a chemical report on these objects in order to establish what they actually contained. Chemical reaction tests showed that the contents did actually correspond to what the labels stated: carbon monoxide and hydrogen cyanide.<sup>6</sup>

---

This present paper is the result of documentation gathered by myself during my second visit to Lublin (with Jürgen Graf in June 1997) and takes my original conclusions, expands them, and corrects them as is necessary without reference to Rudolf's article. In so doing, I am not committing plagiarism or borrowing since this present paper is supported by my own investigation, and then has been evaluated by Rudolf with my permission. Since the *Rudolf Report* has gone beyond the earlier Leuchter Report, the famous Leuchter Report is not detailed herein. That report for the most part has been superseded in the light of discoveries made since its first appearance (Fred A. Leuchter, *An Engineering Report on the Alleged Gas Chambers at Auschwitz, Birkenau and Majdanek, Poland*, Fred A. Leuchter Associates, Boston, Massachusetts USA, 1988, prepared for Ernst Zündel). The photographs published in this article were taken by myself.

<sup>3</sup> Document 1 shows chambers I-IV, prepared by the Polish-Soviet Committee. Source: *Gosudarstvjennyj Archiv Rossiskoj Federatsii*, Moscow (henceforth GARF); 7021-107-9, p. 251.

<sup>4</sup> The designations in italics are supported by documents.

<sup>5</sup> Without vestibule (6.7 m<sup>2</sup>) or interior area (28.2 m<sup>2</sup>).

<sup>6</sup> GARF; RF, 7021-107-9, 229-243.

## 2. Planning, Construction, and Purpose of the Gas Chambers

The remaining documents prove just the opposite to the conclusions put out by the Polish-Soviet Committee: the documents prove that the *actual* gas chambers of Majdanek concentration camp were planned and built only for sanitary purposes such as delousing chambers.

A blueprint of the Central Construction Office of March 23, 1942,<sup>7</sup> provided for three delousing installations. One was an H-shaped installation in the center of the Majdanek concentration camp (Majdanek was originally known as a “Prisoner of War Camp” and was later called “Lublin Concentration Camp” after April 1943). The H-shaped installation was designated “Delousing” and is located next to the large laundry. A second one was a barracks, also designated “Delousing”, and was located outside the camp on the north-west side. The third was located in that part of the camp which was designated as “Clothing Factory for the Waffen-SS”, as may be seen from the detailed plans.<sup>8</sup>

The H-shaped installation in Lublin concentration camp was planned in October 1941, which was the month when the first prisoners arrived at Majdanek. The plan drawn up by the Hans Kori Corporation projected a large hygienic-sanitary complex which was to consist of two exactly identical delousing installations; one for the prisoners lay on the left wing; the other, consisting of eight clothing delousing chambers, stood on the right.

The inmate delousing installation appears on drawing J.-Nr. 9082<sup>9</sup> which is dated October 23, 1941, and is prepared by the Kori Corporation. It is described in a letter that was sent by that corporation on that same date to SS-Sturmbannführer Lenzer.<sup>10</sup>

As may be seen from the description and the annexed plan, the left wing of the structure was planned for inmate delousing, and provided for the following procedure: undressing room with acceptance of clothing – vestibule – shower room – drying room – vestibule – disinfestation. After complete disinfestation,<sup>11</sup> the inmates entered the right wing where they received deloused clothing.

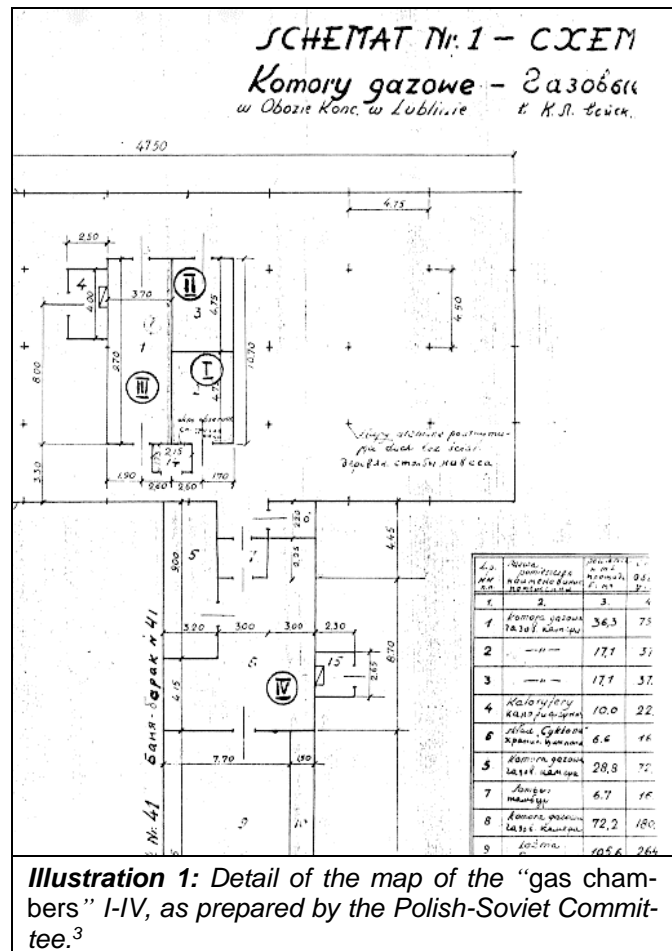

<sup>7</sup> Józef Marszałek, *Geneza i początki obozu koncentracyjnego na Majdanku*, in *Zeszyty Majdanek* (Magazine of Majdanek, hereinafter ZM) I, 1965, “Kriegsgefangenenlager Lublin” (POW camp Lublin), camp map of 23 March 1942 (table without page numbers).

<sup>8</sup> *Ibid.*, “Bekleidungswerk der Waffen-SS Dachau Außenstelle Lublin”, March 1942 (table without page numbers).

<sup>9</sup> “Entlausung und Krematorium” (Delousing and crematorium), Drawing J. No. 9082 of the H. Kori corporation, Berlin, October 23, 1941. *Archivum Panstwowego Muzeum na Majdanku* (hereinafter APMM), sygn. VI-9a, vol. I, p. 9.

<sup>10</sup> APMM, sygn. 9a, volume I.

<sup>11</sup> The disinfestation was carried out with water containing chemical substances in solution. See Walter Dötzer, *Entkeimung, Entseuchung, und Entwesung*, working instructions for clinics and laboratory of the Hygiene Institute of the Waffen-SS, Berlin. Published by the SS Standartenführer Dozent Dr. J. Mrugowsky. Verlag von Urban und Schwarzenberg, Berlin and Vienna 1943, p. 48 ff.



The delousing installation, which was projected as per the Kori letter cited above, was to consist of eight delousing chambers. Each of them were to be two meters wide, 2.10 meters high, and 3.5 meters long. They were to be heated by a coke-fueled air heater located behind the two outside walls between every pair of chambers. A warm air outlet was to be built into the upper part of every interior wall and linked to the air heater. In front of the opposite wall in the floor of every pair of chimneys, was to be a ventilation opening also linked to the air heater through an underground air shaft. These delousing chambers were planned only for the use of hot air and not for Zyklon B! However, this delousing installation planned by the Kori Corporation was never built.

A plan from the Central Construction Office of March 31, 1942, showing the “*Provisional Delousing Installation of Lublin Concentration Camp*”<sup>12</sup> shows eight delousing chambers of considerably smaller size and without air heaters. In all probability these are metallic disinfestation devices such as were installed in the buildings at Birkenau.

This plan shows the eight small cells next to each other in a room measuring 13.5 m × 4 m inside one of the barracks designated as “*Delousing Installations*” measuring 40.76 m × 9.56 m. This cell block separated the “*clean*” side of the building adjacent to the showers from the “*unclean*” side facing the outside. The processing of the inmates provided for the following sequence: entry/registration – undressing/shower room – showers – dressing rooms – exit. Dressing involved the following cycle: the surrender of clothing – delousing (“*unclean*” → “*clean*”) – the acceptance of clean clothing. The shower room was designed for 40 showers; the hot water came from a boiler room. This is what the delousing installation located outside the camp looked like on the original plan dated March 23, 1942. As far as one can tell by looking through a window of the building, which has (otherwise) been made inaccessible to visitors, the plan – with a few modifications – was actually carried out in Hut 42 (BW XII).<sup>13</sup> This building contained the boiler room as well as a chamber finished in concrete which is much bigger than the building shown on the plan.

According to a report from the Central Construction Office, BW XII was 40% completed on July 1, 1942. The report states:

*“BW XII Delousing and Bath – in addition to a second stable with showerbath installation built in the meantime”*.<sup>14</sup>

This second installation to which I will return in the following section, was Hut 14, which was built to the east, next to Hut 42.

On June 19, 1942, SS-Sturmbannführer Lenzer, who was head of the Central Building Inspection Office of the SS-WVHA,<sup>15</sup> forwarded a request dated May 27 from Office BII of the SS-WVHA, to the Building Inspection of the Waffen-SS and Police of the General Gouvernement regarding the construction of a delousing installation for the dressing building in Lublin “*according to the System of disinfestation with hydrogen cyanide*”.<sup>16</sup>

On July 10, 1942, the director of the Central Construction Office sent all the administrative documentation to the Building Inspection of the Waffen-SS and Police of the General Gouvernement. The documentation included in particular: the initial assignment; the annotated report; the building designation A; the cost estimate; the camp plan scaled to 1:500, and the drawing of the disinfestation barracks. The cover letter states:

---

<sup>12</sup> Zentralbauleitung der Waffen-SS u. Polizei Lublin/GG., *Prov. Entlausungsanlage K.G.L. Lublin*, March 31, 1942, *Wojewodzkie Archiwum Panstwowe w Lublinie* (hereinafter WAPL), Zentralbauleitung, 41, p. 5.

<sup>13</sup> This barrack is closed off by a padlock, so the curious must peep through windows.

<sup>14</sup> WAPL, Zentralbauleitung, 8, p. 3.

<sup>15</sup> Amt C/V, Zentralbauinspektion.

<sup>16</sup> WAPL, Zentralbauleitung, 141, p. 5.

*“The supplement to the building application for the construction of a disinfestation installation as Building XII in the fur and garment workshops in Lublin for the sum of 70,000 RM (Reichsmark), with a request for approval and preparation of the means and raw material quotas is hereby enclosed in annex according to the scale of the order of 27 June 1942. The Polish entrepreneurial prices will be determined during the cost estimate.”*<sup>17</sup>

Of the documentation accompanied by this letter, only the annotated report, as well as the cost estimate remain, which were both drawn up dated July 10, 1942, by the director of the Central Construction Administration. The first document, given here in its entirety, explains the purpose of the installation:

*“Explanatory Report  
on the Construction of a Disinfestation Installation  
for the Fur and Garment Factories at Lublin.*

*A disinfestation installation for the disinfestation of all incoming fur and garment materials is to be built according to the plan forwarded from the SS Wirtschafts-Verwaltungshauptamt. The disinfestation chamber, as may be seen from the enclosed diagram, will be built in a very solid manner with a reinforced concrete ceiling. A so-called landing deck will furthermore be built above this delousing chamber. The landing deck is to cover a surface area of 60.0 × 18.0 m in order to lay out and store disinfested materials. The oven, as well as other devices, will be made available by the BII Office. All other matters are to be guided by the diagram.”*<sup>18</sup>

The “cost estimate on the construction of a disinfestation hut for the fur and garment factories of Lublin” consists of 27 sections, and presents a total cost of 140,000 Zloty (Polish currency). Section 18 states:

*“Insert 4 pieces to be delivered by the client air-tight iron doors, [original: “einserne”, misspelled in original] with the help of the locksmith, including all mortise and plaster work.”*<sup>19</sup>

The original plan, of which a final finished drawing has remained – the drawing from the Construction Office “K.G.L. Lublin Disinfestation installation, Building XII<sup>A</sup>”<sup>20</sup> – shows a rectangular block measuring 10.76 m × 8.64 m × 2.45 m in size, containing two disinfestation chambers measuring 10 m in length, 3.75 m in width, and 2 m in height. Every chamber has two adjacent doors measuring 0.95 m in width and 1.80 m in height, so that every one of the shorter sides has one pair of doors which are each three meters apart. Above the block with the two disinfestation chambers there is a landing deck, also rectangular in shape and measuring 18 m × 60 m in surface area and divided in half in the middle into two large halves, equal in size, and corresponding to the “unclean” and “clean” sides. The “clean” half, on the smaller side of the block between the two doors of the disinfestation chamber, contains a coke-fueled oven installation structurally resembling the Kori air heaters described above. The oven is sunk to a depth of 0.66 m, and on the lower part exhibits a filling door and firing door which is accessed by means of 4 steps. The smoke exhaust pipe has been installed in the upper part.

Since the disinfestation installation utilized hydrogen cyanide, this oven warmed the air and sped up the circulation of the air-gas mixture.

Construction of the installation followed this plan, except for the heating system:<sup>21</sup> the oven in the middle was replaced by two hot-air devices which were manufactured by the firm Theodor Klein

<sup>17</sup> *Ibid.*, p. 2.

<sup>18</sup> *Ibid.*, p. 5.

<sup>19</sup> *Ibid.*, pp. 7 and 8.

<sup>20</sup> Bauleitung des KGL Lublin, *Entwesungsanlage Bauwerk XII<sup>A</sup>*, Lublin, August 1942. WAPL, Zentralbauleitung, 41, p. 4.

<sup>21</sup> The dimensions of the other rooms were also changed: the Polish-Soviet Committee gives them as 9.70 m × 3.70 m.

Maschinen-und Apparatebau Ludwigshafen, and were ordered by the Central Construction Administration on September 11, 1942.<sup>22</sup> One was installed in the western exterior wall of the disinfestation chamber (designated as Chamber III in the Polish-Soviet report); the other, as we shall see in the following section, is associated with the “*gas chamber*” in barracks 41.

The Klein hot-air apparatus was a coke-fueled air heater consisting of a furnace (*Feuerung*) with a steam belt (*Heizkammer*) located on top of it and containing a recuperator. The recuperator consisted of a series of vertical heating pipes fitted with ribs. The pipes were connected to the furnace room below, and to the air outlet channel above.

The steam belt<sup>23</sup> contained a fan on top of a chamber next to the furnace. A compressed air pipe led outward from the fan. The opening of the inlet pipe, equipped with an air throttle for regulation, was located in front of the fan. Both pipes – the compressed air pipe and suction pipe – were 31 cm in diameter. These pipes were connected to the location (*Lokal*) containing the air heater through two round openings in the wall. The device worked as follows: smoke from the furnace traveled through the pipes of the recuperator and gave off part of its heat to the pipes; the smoke then exited through the chimney into the open air. When the fan was in operation, the air which was forced out of the place through the air suction pipe, came into contact with the red-hot pipes of the recuperator and was heated. It was then pumped through the compressed air pipe into the place by the fan. This assured a constant circulation of hot air. The air heater was capable of generating heat at 80,000 Kcal/h, raising the air temperature to 120 degrees Celsius. The air temperature was regulated by the air throttle, as well as by specially designed air intakes, bringing cool air from the outside into circulation.<sup>24</sup>

For delousing with Zyklon B gas, if the air temperature was adjusted to a lower level, the air heater fulfilled the same function as the DEGESCH circulation system.

An air heater very similar to the one described above was installed in the autumn of 1942 in BW 20 of the Auschwitz concentration camp (protective custody camp).<sup>25</sup>

On October 22, 1942, the Director of the Central Construction Administration sent a report to the SS Economist of the Superior SS and Police Leaders (SS-Wirtschaftler des Höheren SS- und Polizeiführer] in the General Gouvernement on the state of progress of the work in the various construction projects at the camp. Among the completed construction projects at Lublin Prisoner of War Camp was the construction of:

*“2 delousing huts with baths, built partly on wooden pilings and partly on solid foundations.”*

With regards to the construction project for the fur and garment workshops at Lublin, the report presents “*the construction of a disinfestation installation*” among the completed projects. The “*installation of four disinfestation chambers*” is mentioned among the projects remaining to be completed after 1 November.<sup>26</sup> The disinfection facility was installed next to Hut 41 and consisted of two disinfestation chambers, *i.e.*, BW XII<sup>A</sup>.

As may be seen from the previously quoted Central Construction Administration report on “*completion of the construction in % [i.e., expressed as a percentage of completion] on July 1, 1942,*” these two delousing huts mentioned among the prisoner of war camp construction projects involved

---

<sup>22</sup> Józef Marszałek, “*Budowa obozu koncentracyjnego na Majdanku w latach 1942-1944*”, in *ZM*, IV, 1969, p. 53, footnote 117.

<sup>23</sup> Translators note: a steam belt is part of a vacuum evaporating system in which the liquid to be concentrated circulates through tubes surrounded by steam; also called a calandria.

<sup>24</sup> Instytut Technicki Ciepłej, *Ekspertyza dotycząca konstrukcji i przeznaczenia pieców zainstalowanych przy komorach gazowych w Obozie na Majdanku w Lublinie*, Lodz 1968, APMM.

<sup>25</sup> Rossiski Gosudarstvenni Vojenny Arkhiv, Moscow (hereafter *RGVA*), 502-1-332, p. 46.

<sup>26</sup> WAPL, Zentralbauleitung, 8, p. 22.

huts 42 and 41. However this document refers to Hut 41 as merely a “*stable with shower bath installation*”, which means that a delousing installation must have been installed there over the following months.

This installation is also referred to in a cost estimate dated November 18, 1942, from the Polish firm Michael Ochnik Construction Contractors Lublin for brick work on two large chimneys measuring 0.75 m × 0.70 m × 1.70 m “*in the Gas Chamber*”, including piercing a hole (*aushauen*) in the concrete ceiling, for the fur and garment workshop at a cost of 285 Zlotys.<sup>27</sup>

On January 8, 1943, the Michael Ochnik Company sent the Central Construction Administration a corresponding invoice relating to the Waffen-SS garment workshop in Lublin:

“[...] *for brick work on the chimney and supply of flues*<sup>[28]</sup> *on both sides of the chimney in the gas chamber inside the brick building. Piercing two openings in the cement ceiling, brick lining of chimney measuring 0.75 × 0.75 × 1.70 m.*”<sup>29</sup>

In fact two openings measuring approximately 60 cm × 60 cm and 40 cm × 40 cm, located 4 m apart, are still in existence in the ceiling of the above mentioned room (*Lokal*) today. According to the invoice mentioned above, two pipes were installed in these two openings; the pipes led to a central chimney measuring 0.75 m in diameter and 1.70 m in height.

The disinfestation chamber in BW XII<sup>A</sup> obviously proved insufficient for the requirements of the fur and garment workshops, since, as already stated, the Central Construction Administration planned the construction of four additional disinfestation chambers for this same construction project. Two civilian firms, the above-mentioned Michael Ochnik Construction firm in Lublin, and *Polstephan Bauunternehmung GmbH* (constructing contractors), a Warsaw corporation, were assigned by the Central Construction Administration to complete the work, which consisted of converting an already existing building into a disinfestation installation.

Both firms presented a “*cost estimate for the construction of four disinfestation chambers in an existing building*”, presumably located in the area of the former airport. The cost estimate of the Ochnik firm is dated November 7, 1942, for a total of 8,855 Zlotys.<sup>30</sup> The invoice of the Polstephan firm is dated November 10, 1942, for a total of 10,345 Zlotys.<sup>31</sup> It is clear from both documents that the four disinfestation chambers were to be equipped with “*iron gas[-tight] doors*”, and that the door openings were to measure 0.83 m × 1.93 m. Each chamber was to be connected to a “*disinfestation oven*” – also called a “*gas oven*” – to be protected by a pent roof.<sup>32</sup>

### 3. The Use of the Gas Chambers for Homicidal Purposes

In the section above, I have shown that the actual gas chambers of Majdanek were planned and built exclusively for hygienic-sanitary purposes. It would of course have been theoretically possible to convert them to homicidal purposes at a later time. That possibility will be examined in this section from a technical point of view.

In his response to the Leuchter report, Jean-Claude Pressac provides a detailed and, in parts, a truly perceptive analysis of the gas chambers at Majdanek.<sup>33</sup> That analysis represents an excellent starting point for the discussion below. The following discussion will, however, adopt the number-

<sup>27</sup> *Ibid.*, 145, p. 13.

<sup>28</sup> “*Züge*” in German.

<sup>29</sup> WAPL, *Zentralbauleitung*, 8, p. 14.

<sup>30</sup> *Ibid.*, pp. 1, 2.

<sup>31</sup> *Ibid.*, pp. 5, 6.

<sup>32</sup> *Ibid.*, sections 1, 3, 4, and 7.

<sup>33</sup> Jean-Claude Pressac, “*Les Carences et Incoherences du Rapport Leuchter*”, in *Jour J*, December 1988. Majdanek is discussed on pages vii-x.

ing of the premises used by the Polish-Soviet Committee, with the addition of Chamber IIIa. The term “*Chamber IIIa*” is intended to refer to the eastern delousing chamber in BWXII<sup>A</sup> before it was divided into Chambers I and II.

### a) Chambers I-III

Jean-Claude Pressac, who demonstrates no expert knowledge about the origins and development of this installation, presents historically unfounded hypotheses. He believes that the second air heater was initially installed in the other room of the disinfestation installation (*i.e.*, Chamber IIIa), and that both chambers originally functioned as hot air disinfestation chambers. They are assumed to have been converted into hydrogen cyanide gas chambers at a later time, due to practical difficulties in use.<sup>34</sup>

As seen in the section above however, the disinfestation chambers of the installation adjacent to Hut 41 were initially designed “*according to the hydrogen cyanide disinfestation system*”, so that, in reality there was never any question of converting a hot air installation into an HCN installation, but rather, at most, the other way around. We will return to this question later.

According to J.-C. Pressac:

*“A final conversion of the block led to the creation of gas chambers in which people were killed with carbon monoxide. There cannot be the slightest doubt that this installation served criminal purposes, since carbon monoxide is, of course, deadly to warm-blooded animals, including human beings, but it is totally useless in fighting lice.*

*Location B [= Chamber IIIa] was divided into two rooms equal in size, which I have called B1 [=Chamber I] and B2 [= Chamber II]. Only B1 possessed a system for the introduction of carbon monoxide. This system consisted of perforated metal pipes running along three sides of the room 30 cm above the floor. These pipes were originally connected to steel containers of liquid carbon monoxide. An exterior side room was built in the middle of the western [southern<sup>35</sup>] side of the block. This room had two containers of carbon monoxide (the second container was intended for Room A [= Chamber III]), as well as a glass peephole protected by an iron grid. Homicidal gassings could only take place in Room B1. No corresponding installation was built in Room B2. An opening was made in the ceiling of both chambers, newly built in the above manner. The oven formerly used to heat Room B was now no longer needed, and was removed and re-installed on the southern [eastern] wall of Room C [= Chamber IV]. That this Room B was only divided after its use as a Zyklon B gas chamber is shown by the fact that its walls, one of which is divided in half by the partition, are saturated with blue stains. The partition itself exhibits no blue pigmentation at all.*

*Room A was also equipped for the diffusion of carbon monoxide from the second steel container located in the exterior room. The installation consisted of a pipe (smaller in diameter than in room B1), running along the southern wall [= eastern wall] and 30 cm above the floor. The gas flowed through perforated metal plates at both ends of the pipes, located in the corners of the room. No openings were made in the ceiling, and it was not possible to view the inside of the chamber from the side room.*

*Whether rooms A, B1, and B2 were used as hydrogen cyanide gas chambers for homicidal purposes, is a question which is difficult to answer and which must remain open. In rooms B1 and B2, the Zyklon B granules were supposed to have been poured through the openings pierced in the ceiling. In so far as I have been able to determine, no eyewitness has ever reported seeing an SS man climb up onto the roof by ladder. The ventilation of these two rooms, measuring 36 m<sup>3</sup>, must have been very time-consuming due to the absence of any openings, apart from the opening in the ceiling, as well as the doors, and because of the absence of artificial ventilation. The introduction of Zyklon B into Room A would have in-*

---

<sup>34</sup> *Ibid.*, pp. vii, viii.

<sup>35</sup> The east-west directions given by Pressac are incorrect.

involved difficulties, described by one historian of the Majdanek Museum as follows: ‘The Zyklon was introduced, not through an opening in the ceiling as in the previous chamber [B1] – there was no such opening – but rather, through the doorways before closing the doors.’ Frankly speaking, it is unrealistic to imagine an SS man wearing a gas mask and with a can of Zyklon B in his hand, sprinkling the granules in the 30 cm space between the heads of the victims and the ceiling (involving the risk of the granules falling on to the floor at the front of the room) while attempting to close the door, without causing desperate escape attempts on the part of the victims.

On the grounds stated above, I do not believe that Room A could be used for homicidal purposes using Zyklon B. In rooms B1 and B2, this does of course appear technically possible, but it is unlikely that these premises were really used for this purpose. It rather appears that the SS wished to have two different carbon monoxide gas chambers available (A and B1), which were used for different sized groups of victims: Chamber A (36 m<sup>2</sup>), for groups of 250 to 350 people, and Chamber B1 (18 m<sup>2</sup>), for groups of 125 to 175 people. These figures are repeatedly mentioned by survivors, indicating the strength of the transports sent into the gas chamber. Finally, the openings in the ceiling of building B1 and B2 would have served to accelerate ventilation, rather than for the introduction of Zyklon B. This assumption only applies to B1. B2, despite the opening in the ceiling, appears to have played merely a passive role as a ‘dead room’ in the division of the block for homicidal purposes.

Upon the liberation of the camp, the aircraft hangar protecting the block was partially damaged. The side room was empty. Zyklon B cans were initially piled up there to give the impression that their contents could have been emptied into the pipes of room B1 (instead of through the opening in the ceiling). Five steel carbon monoxide containers were found in the camp. After chemical analysis of their content, two of them were housed in the side room.”<sup>36</sup>

Let us stress once again that Pressac of course considers the use of Zyklon B for homicidal purposes to be possible in theory, but in practice however, he rules out this possibility for Chamber III and considers it dubious for Chambers I and II. I have no choice but to concur with Pressac’s arguments, with the following additional considerations. If the camp authorities had wished to use both disinfestation chambers for homicidal purposes – as well as for the extermination of lice – they would have made an opening in the ceiling for the introduction of Zyklon B in both rooms. The absence of such an opening excludes utilization of Chamber III for such purposes on the grounds stated by Pressac. In Chambers I<sup>37</sup> and II, the existing openings are so small (26 cm × 26 cm and 29 cm × 33 cm respectively), that they could only have accelerated ventilation with difficulty, contrary to the view expressed by J.-C. Pressac. Furthermore, these openings were broken through the ceiling in an extremely unprofessional manner, especially in Chamber II,<sup>38</sup> where there is not even a wooden shaft for the introduction of Zyklon. Everything indicates that these openings were hastily broken through the ceiling simply for purposes of the Polish-Soviet Committee. It is highly revealing that the Soviet journalist Constantin Simonov, correspondent for the *Red Star*, who visited Majdanek immediately after the liberation, describes the openings in the ceiling of the delousing chambers in Hut 42 with great precision, but nowhere does he mention the opening in Chamber I, which he examined immediately afterwards.<sup>39</sup> The inevitable conclusion is that this opening did not exist at that time.

We must now turn to the alleged division of Chamber IIIa into two gas chambers, and the alleged conversion of Chambers I and III into carbon monoxide gas chambers. Pressac has no doubt as to their use for criminal purposes, but his certainty is based upon pure hypothesis – *i.e.*, that the installation was actually utilized with carbon monoxide. The conclusion comes before the proof! The

<sup>36</sup> J.-C. Pressac, *op. cit.* (note 33), pp. vii-ix.

<sup>37</sup> See illustration 2.

<sup>38</sup> See ill. 3.

<sup>39</sup> Constantin Simonov, *Il campo dello sterminio*, Foreign Language Publication House, Moscow 1944, p. 8.

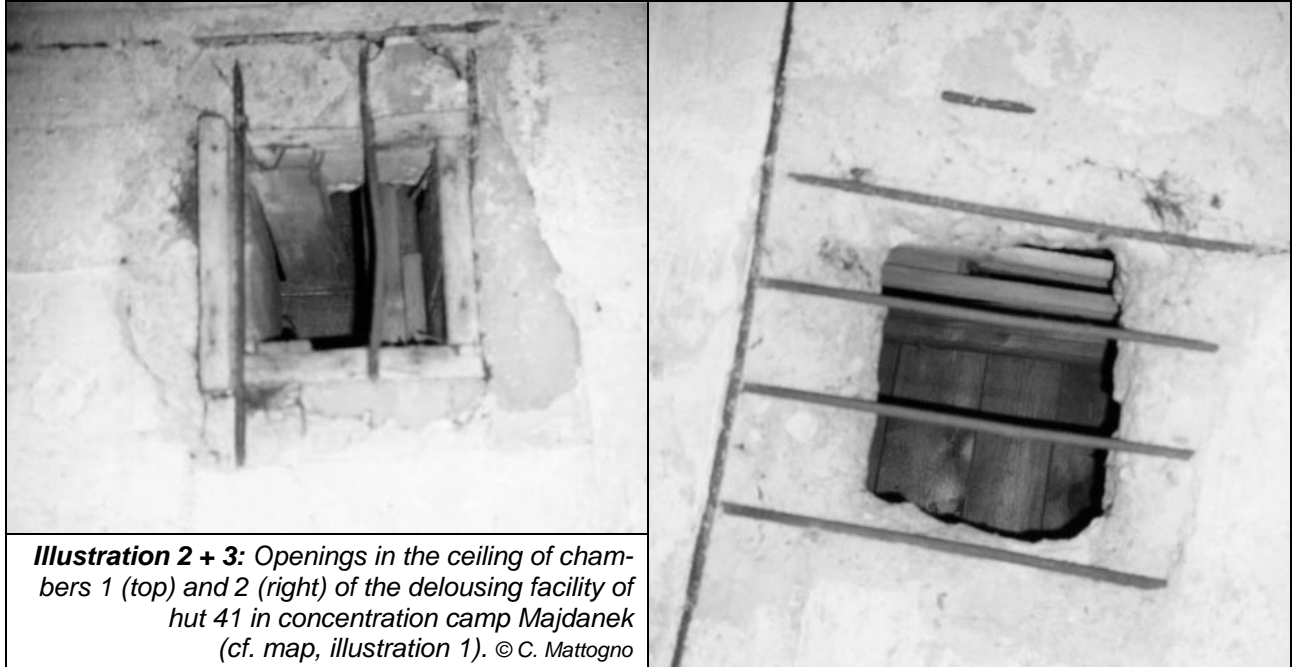

**Illustration 2 + 3:** Openings in the ceiling of chambers 1 (top) and 2 (right) of the delousing facility of hut 41 in concentration camp Majdanek (cf. map, illustration 1). © C. Mattogno

statements of the Polish-Soviet Committee relating to the use of the premises for carbon monoxide gassings are not in fact based on any proof at all. Two facts quite clearly indicate the contrary.

First, in the immediate vicinity of the camp – as correctly emphasized by Pressac – there were no containers in the cell in front of both chambers, but rather, there were Zyklon B cans brought there by recently liberated inmates to give the impression that people had been murdered in these rooms by pouring Zyklon B through pipes. This will be discussed in detail below.

Secondly, two of the five steel containers found by the Soviets in the above-mentioned side room (cell) were later piled up in Hut 52. The report of the Polish-Soviet Committee alleges that these five containers were of CO. But one of the two containers visible in the side room (cell) today – to the right of the observer – bears the inscription CO<sub>2</sub>, *i.e.*, carbon dioxide. This is quite visibly notched into the surface of the container.<sup>40</sup> It is well known that carbon dioxide is not a toxic gas.

These facts permit two important conclusions: first, if one of the five carbon monoxide containers really were of carbon dioxide, the suspicion arises that the other containers were of carbon dioxide as well, and that the Polish-Soviet Committee is guilty of deception on this point, just as on a number of other points.<sup>41</sup> Secondly, even if the other containers actually contained carbon monoxide, there is still no proof that the installations involved were actually utilized for carbon monoxide gassings. This alone suffices to cast doubt on the alleged criminal use of these installations.

The Auer Filter found in the chemical stockpile by the Committee corresponds very exactly to the description of a carbon monoxide filter, with regards to both size and the manner in which it was stored. A specialist in the field of toxic gasses summarizes these matters as follows:

*“A common defect of the various filters especially designed to provide protection against carbon monoxide gas lies in the remarkable hygroscopicity of the absorbing substances: their hygroscopicity alters the distribution of the filtering and absorbent materials in the filter, which restricts their use in a moist*

<sup>40</sup> I was unable to read the inscription on the other container.

<sup>41</sup> The most primitive deception is the technical report on the crematory ovens: the coke-fueled Kori five-muffle ovens, by means of a completely crack-brained series of calculations, are said to have possessed a crematory capacity of 1,920 bodies per day, nineteen times the actual capacity: GARF, RF, 7021-107-9 pp. 245-249.

*environment and requires strict measures for the conservation of the filter itself to prevent premature clogging due to moisture. The filters must be kept in hermetically sealed boxes before use.”<sup>42</sup>*

With regards to the filters under discussion here, these strict conservation measures appear to have been fully and entirely adhered to. They were kept in a hermetically sealed metal box with the following inscription (re-translated from Russian):

*“AUER Filter No. 09903. Do not use after June 1944. Can be used for two years from date of first use. No more than 40 hours working life.*

*Initial use:*

*Date:      Use:                      Hours:*

*From:      To:*

*Attention: After each use, seal the box tightly, top and bottom. Store in a cool dry location.”*

Since the spaces for “Date”, and “Hours” were left blank, we must assume that the filters were still unused. The camp doctor, who was responsible for the storage of anti-toxic gas protection material, would certainly never have permitted use of the filter without completion of the required information on the label.

On the other hand, this same type of carbon monoxide filter was versatile by nature, and provided protection against other gases as well, such as ammonia, benzene, chlorine, phosgene, sulfur dioxide, hydrogen sulfide, and carbon tetrachloride. It could also be used to protect against hydrogen cyanide gas: the Degea CO filter could absorb 6 grams of HCN, and the Dräger CO filter 3.3 grams.<sup>43</sup> Thus, the presence of such a filter in no way proves that it was intended to provide protection against carbon monoxide.

Pressac’s hypothesis appears unfounded, even viewed historically. He believes in particular, that the installation of the pipes in Chambers I and II took place at last after both rooms had first been used as hot air disinfection chambers, and were then used as Zyklon B delousing chambers.

But the pipes fastened along the entire length of the eastern wall of Chamber III are skirted by intensely blue-pigmented plaster,<sup>44</sup> as if they had acted, in a certain sense, as the catalyst for the formation of iron blue (ferric-ferrocyanide). In Chamber I, on the other hand, no traces of blue pigmentation are to be seen.

In Chamber II, blue stains are visible only on the eastern wall between the door and the interior partition in the middle [of the room], as well as on the lower part of the partition itself, *i.e.*, corresponding to the very places where the pipes are located in the adjacent room. This leads to the conclusion that HCN was used in Chamber III after the installation of the pipes, while no HCN was [ever] used in Chamber IIIb at all. The iron blue stains are too small, and are only located at certain



**Illustration 4:** Unsealed opening with nothing more than a grate links Chamber I to the small attached room, hut 41, concentration camp Majdanek (cf. map, illustration 1). © C. Mattogno

<sup>42</sup> Captain Dr. Attilio Izzo, *Guerra Chimica e Difesa Antigas*, Editore Ulrico Hoepli, Milan 1935, p. 183.

<sup>43</sup> Ferdinand Flury and Franz Zernik, *Schädliche Gase, Dämpfe, Nebel, Rauch und Staubarten*, Verlag von Julius Springer, Berlin 1931, p. 617.

<sup>44</sup> See ill. 5.



places in Chamber II; so that they are certainly the result of the phenomenon of cyanide diffusion, corresponding to the diffusion of cyanide to the outside of the northern wall.<sup>45</sup>

Chamber IIIa was divided into Chambers I and II even before the disinfection installation was put into use, which shows that the air heater was not installed as planned. In fact, the eastern walls of Chambers I and II show no trace of the circular openings for the warm air outlet and ventilation intake, as found in the western wall of Chamber III.

From the above, it can be seen that Pressac's hypothesis as to the use of these areas for criminal purposes is based on fallacious premises from the very outset. It is also inexplicable on purely technical grounds. Despite the availability of two real hydrogen cyanide gas chambers which could have been converted for homicidal purpose by merely piercing holes in the ceiling for the introduction of Zyklon B, SS men are supposed to have put in an installation for homicidal gassings using carbon monoxide, and very early on, at that – but what for? If homicidal gassings with Zyklon B worked perfectly at Auschwitz, as we are told they did, then why use carbon monoxide at Majdanek?

From the technical point of view, Pressac's explanation, that Chamber IIIa was divided into two rooms to be used as gas chambers, one of them to gas small groups, and the other to gas large groups, is quite nonsensical. Not only did division of the chamber offer no advantages (groups of 125-175 victims could have been gassed quite easily in the larger chamber without wasting any gas), on the contrary, it would have rendered the gassing procedure much more difficult. First, the partition would have obstructed the natural ventilation of Chamber I and II after opening the doors, which are located opposite each other.

On the other hand, Chamber II, as Pressac himself had to admit, was demoted to a “*dead room*”. The small window in the southern wall of Chamber I raises additional, insoluble problems. In its present condition, it is barred by a grid, but there is no installation for hermetic sealing.<sup>46</sup> After the liberation of the camp, as reported by Simonov, as well as by the Polish-Soviet Committee, it was fitted only with a pane on the observer side of the cell. If this is true, the pane was not initially built in, but was rather merely shoved into the window, which shows no trace of a fixed frame, or attachment clamps for such a pane. The window was therefore not only incapable of being hermetically sealed, it was even capable of removal. Furthermore, it could have easily been smashed by the inmates since the walls are only approximately 40 cm thick. In particular, the grid is large enough to stick one's hand through. Finally, it is impossible to understand why such a window, if it was intended to permit observation of homicidal gassing victims, would have been necessary for Chamber I, but not for Chamber II.

Utilization of carbon monoxide may therefore be excluded. But it remains to be explained why the room was divided into two chambers. In the absence of any documents, we can only form one more hypothesis, but one which is incomparably more plausible than Pressac's hypotheses. Since one of the two containers is CO<sub>2</sub>, and in view of the date of conversion, the following explanation appears far more plausible.

Starting in July 1942, ‘natural’ mortality in the camp was devastating, so much so that 2,431 inmates died in September, and 3,210 in October.<sup>47</sup> The “*old crematorium*” then in existence possessed only two (oil-fired) ovens, which could no longer handle the constantly increasing number of victims. There was also a petroleum shortage. As reported by crematorium director, SS-Oberschar-

---

<sup>45</sup> This phenomenon is also visible, but more intensely, on the outside walls of the disinfection chamber in BW 5a and 5b at Birkenau.

<sup>46</sup> See ill. 4.

<sup>47</sup> *Księga więźniów zmarłych na Majdanku w 1942*, APMM, sygn. I-d-19; *więźniów zmarłych w obozie na Majdanku*, AGKBZH [Archivum Główniej Komisji Badania Zbrodni Hitlerowskich w Polsce] 626 z/OL3. The figure for October is calculated by subtraction. The question of the number of deaths in the camp of Majdanek is discussed in chapter IV of the book cited in footnote 2.

führer Erich Mußfeldt, this finally lead to closure of the crematorium in November of the same year.<sup>48</sup> On the other hand, the morgue, BW XIV,<sup>49</sup> was a half-underground hut of rather modest size, measuring 11.50 m × 6.50 m on the outside,<sup>50</sup> so that it could store only a limited number of bodies at one time. In this desperate situation, the Central Construction Administration decided to convert the disinfection installation adjacent to hut 41 into two additional morgues. One of these (Chamber III) was to be temporary, while the other (Chamber I) was to be permanent in nature. Pipes connected to a container of CO<sub>2</sub> permitted both rooms to be cooled<sup>51</sup> to the desired temperature.<sup>52</sup> CO<sub>2</sub> also has the property of retarding oxidation processes, thus delaying the decomposition of corpses.

When not needed as a temporary morgue, Chamber III could still be used for its original purpose – hydrogen cyanide gas disinfection. That it was so utilized, is proven by the intense blue pigmentation, *i.e.*, the presence of high concentrations of iron blue in all the walls of this room.

As for the little window in the southern wall of Chamber I, there is no proof that it was built at the time of the installation of the pipes in Chambers I and III. Since their utilization as morgues diminished with the opening of the new crematorium in January 1944, a new purpose was no doubt assigned to them. Chamber III, in view of the chronic shortage of Zyklon B, was probably used as a hot-air disinfection chamber, using the air heater. Chamber I was presumably used as a storage area for material requiring visual supervision (for example, weapons).

## b) Chamber IV

Regarding this site, Pressac writes:

*“The use of this room for homicidal purposes is only conceivable under two sets of circumstances: removal of the little window, which could easily have been smashed by the inmates, and the incorporation of mechanical ventilation. After a delousing action, opening the two doors would have created a draught of air carrying toxic vapors into other parts of the hut. It was therefore indispensable that the door leading to the shower room remain hermetically sealed. But if the ventilation only took place in the area between the two upper openings and the door, such ventilation would have been both time-consuming and inefficient. If both doors remained shut, the room could only have been ventilated by pumping in hot air (using the fan on the oven). Cyanide gas is lighter than air, and could have been evacuated through the two openings in the ceiling, dissipating in the atmosphere. After a short time, the residue concentrations of HCN would have fallen to a level at which both doors could have been opened without danger. The draught of air would then have swept away the last traces of the gas and cooled the room. Site C [= Chamber IV] was therefore used as a disrobing room. For homicidal purposes, it would have been the ‘most efficient’ gas chamber in the camp if the window had been removed. The question of whether this was done at the time of the aeration of the camp, is decisive in determining whether or not the room may have been used for homicidal gassings; since I do not know the answer, I must reserve judgment.”*<sup>53</sup>

As seen in the previous section, Hut 41 was built as a mere “*stable with shower bath installation*”, and is so designated on the blueprint dated July 1, 1942. If we compare a diagram of its final condition with the original blueprint for Hut 42 (“*Provisional Delousing Installation KGL Lublin*” dated March 31, 1942, we must conclude that the former was initially designed to be identical to the lat-

<sup>48</sup> Anna Zmijewska-Wiesniewska, “*Zeżnanie szefa krematorium Ericha Musfeldta*”, in *ZM*, I, 1965, p. 140.

<sup>49</sup> On July 1, 1942, this building was already 70% finished, WAPL, Zentralbauleitung, 8, p. 3.

<sup>50</sup> These data have been taken from the corresponding blueprints: K.G.L. Lublin, Leichenhalle, Bauwerk XIV, scale 1:100. WAPL, Zentralbauleitung, 47, p. 14.

<sup>51</sup> It is well-known that the expansion of a compressed gas in liquid form generally causes a drop in room temperature.

<sup>52</sup> The door of room III shows an opening for the introduction of a thermometer.

<sup>53</sup> Pressac, *op. cit.* (note 33), p. ix.

ter, *i.e.*, identical to the central part of the building used for disinfestation, and would therefore have contained the following sectors (from north to south): vestibule/entrance – registration – hair-cutting room – undressing room – shower bath – dressing room – vestibule/exit. This is also shown by the fact that the four principal sectors of both buildings: entrance/undressing room – showerbath – distribution of clothing – boiler-room – dressing room, were of practically the same size.

At the end of September or the beginning of October 1942, a cyanide gas chamber with air-heater was built in Hut 41. The air-heater was connected to the eastern wall. On October 22, the work was finished, and the area was designated “*Delousing Hut with Bath*”. The area previously referred to as an undressing room was used as a gas chamber without any major architectural modification, which proves that it was a temporary installation.

As seen today, Chamber IV is very irregular in shape. It has two dead corners, is closed on three sides, and therefore very difficult to ventilate. This one, exactly identical to the hair-cutting room in hut 42, shows blue pigmentation on the ceiling and plaster of the northern wall. This blue pigmentation is also found in the plaster on the southern wall, but is on the outside of the wall of Chamber IV. An even more intense bluish pigmentation finally appears in the plaster of the eastern wall, in the vestibule.

This gas chamber probably involved ventilation problems, since, as was seen in section 2, the Central Construction Administration decided to install a ventilation chimney on the roof, and wrote in this regard to the above-mentioned Polish firm, the Michael Ochnik Corporation. The relating cost estimate, dated November 18, 1942, provides for the construction of two chimneys measuring 0.75 m × 0.75 m × 1.70 m in size, with the piercing of a hole in the concrete ceiling. However, according to the following invoice dated January 8, 1943, only one chimney was built on the roof of the gas chamber. The chimney is connected “*on both sides*” by “*flues*” connected to “*2 openings in the concrete ceiling*”. There is no doubt that these openings are ventilation intake and outlet openings. This is clearly revealed by the fact that both the openings on the roof of the gas chamber were pierced along the extended axis of the air-heater suction pipe.

The gas chamber was not designed for homicidal purposes. First, the chimney installation, as described in the above-mentioned invoice from the Michael Ochnik Corporation, could never have been used for the introduction of Zyklon B, because the HCN-saturated granules would simply have fallen onto the floor of the fireplace without entering the two parallel flues in the concrete ceiling. Secondly, the southern gas-tight door (the one leading to the shower room) did, of course, close from the outside; but the door opposite from it, closed from the inside. What this means, is that the disinfestation officer responsible for pouring out the Zyklon B granules, entered the room wearing a gas mask, closed the northern door, poured out the Zyklon, left the room through the southern door, and then needed to seal the chamber from the shower room on his way out. In homicidal gassings, it would have been impossible to open the northern door because of the pile of dead bodies lying in front of it, and if it was only possible to open one of the two doors, this would have greatly hindered ventilation.

The two openings visible in the ceiling of the room today measure approximately 60 cm × 60 cm (the eastern opening),<sup>54</sup> and 40 cm × 40 cm (the western opening).<sup>55</sup> Both led to a wooden shaft in which a small chimney made of planks had been built. This shaft was closed by means of a lid, also made of wood, on the roof of the hut. Measured from the ceiling of the room, the chimney is approximately 1.15 m in height. Its present condition (except with regards to the size and selection of raw materials), corresponds to the draft of the cost estimate dated November 18, 1942; so that the actual structure, as built, was modified later. This is shown by the fact that, inside the room, the

---

<sup>54</sup> See ill. 6.

<sup>55</sup> See ill. 7.



**Illustration 5:** and **Illustration 6:** Eastern (top) and western (right) opening in the ceiling of the delousing facility in hut 41, concentration camp Majdanek (cf. map, illustration 1). © C. Mattogno



**Illustration 7:** Blue staining around the pipe near the floor of the eastern wall of chamber III of the delousing facility in hut 41, concentration camp Majdanek (cf. color picture on back cover; cf. map, illustration 1). © C. Mattogno

**Illustration 8:** Window in the eastern wall of chamber IV, hut 41, (delousing gas chamber), concentration camp Majdanek (cf. map, illustration 1). © C. Mattogno

wooden shafts around the openings interrupt the Prussian blue staining on the plaster of the ceiling. The plaster was renewed in many places around the shafts, as may be seen from the snow-white color of the plaster. Finally, the shafts themselves show not the slightest trace of blue pigmentation, quite in contrast to the window frames.<sup>56</sup> Thus, it is incontrovertibly proven that the shafts were only installed at a time when Zyklon B was no longer being utilized in this room.<sup>57</sup> And the presence of blue stains on the window frames shows that the window existed *prior* to the liberation of the camp. Pressac's question, upon which his judgment as to the possibility of homicidal mass gassings in this room is made to depend, is thereby conclusively answered.

The above described modifications may possibly be explained on the assumption that the use of Zyklon B was abandoned, and that delousing actions in Chamber IV were conducted with hot air, using the air heater installed behind the eastern wall.

This assumption is supported by the constant shortage of Zyklon B, which was in particular short supply after the summer of 1943. At that particular time, a devastating typhus epidemic was raging

<sup>56</sup> See ill. 8.

<sup>57</sup> As Germar Rudolf has stressed, ferric-ferricyanide forms especially easily on moist walls (G. Rudolf, *The Rudolf Report*, Theses and Dissertations Press, Chicago, IL, 2003, pp. 159-169); see his contribution on the Auschwitz gas chambers in this volume.

in Majdanek, and huge quantities of Zyklon were needed “*for camp disinfection*” (see section 5). The above described modifications could very well have been carried out at this time (from the summer of 1943 to the beginning of 1944). Since the small quantities of Zyklon allocated to the camp were needed to disinfect the huts, cyanide gas chambers III and IV were converted to hot air disinfection chambers.

The hypothesis stated above relating to the modification of Chambers III and IIIa, also provides an explanation for the installation of Gas Chamber IV. During construction of the disinfection installation, which was really planned for the fur and garment workshop building project, the Central Construction Administration decided to use two rooms of the installation as additional morgues: one (Chamber I), was used as a permanent morgue, and the other, (Chamber III), was planned as a temporary morgue.<sup>58</sup> This meant that the original Chamber IIIa could no longer be used for Zyklon B disinfection. To compensate for the loss of these areas, and to provide a substitute for Chamber III, which could no longer be used for the time being, another temporary cyanide gas chamber was installed in Hut 41, the surface area of which roughly corresponded to Chambers III and IIIa. From a technical administrative point of view, these buildings were part of the fur and garment workshops, even if they were located in a building inside the prisoner of war building project. The choice of Hut 41 for installation of the gas chamber was logical because the disinfected clothing could, by its very nature, be quite easily laid out in the “*clean*” sector, beneath the protective roof located over the original disinfection installation. The disinfection installation – which was already planned on October 22, 1942, and mentioned in the two cost estimates dated October 7 and 10, 1942 – consisting of four gas chambers, was finally allocated to the fur and garment workshop building project as a definitive installation.

### c) Chambers V and IV.

The following fact should first be emphasized: there is no *material* proof that two Zyklon B gas chambers (which are alleged to have been used for the first homicidal gassings prior to the entry into operation of Chambers I-IV), were ever installed in Hut 28.

The description of the Polish-Soviet Committee – in particular, the diagram of the installation as drawn by that Committee<sup>59</sup> – far more resembles a drying installation for the laundry than a delousing installation. In the middle of Hut 28, there were in fact two chambers, each measuring 11.75 m × 6.00 m in size. Each of these chambers has an opening in the ceiling measuring 30 cm × 30 cm. These openings can be hermetically sealed. Both chambers led through two doors in the two opposite longitudinal walls to two locks (*Schleusen*) measuring 2 m × 12.15 m. Each lock contained an air heater which was connected to the chamber in question. These locks possessed two doors, located opposite the doors to the chambers, leading to two rooms measuring 7.50 m × 12.15 m, as well as to an access door in the side wall. This structure would have made ventilation of the two chambers very difficult. The air heaters moreover were connected to the rooms in question by means of one single pipe, which means that the air heaters were not used for circulation, but rather for the introduction of hot air flowing from the air-heater and exiting through the small opening in the ceiling. The air-tight lid was intended to keep the hot air in the rooms for longer time periods when the air heater was out of use; for example when drying clothing during the night.

This assumption is partly supported by the diagram prepared by the Polish-Soviet Committee itself. In it, the hut where the “*Gas Chambers V and VI*” are supposed to have been located is referred to as a “*Suschilka*”, which means drying installation.<sup>60</sup>

---

<sup>58</sup> These two crematoria naturally became superfluous with the construction of the new crematorium.

<sup>59</sup> GARF, RF 7021-107-9, p. 251.

<sup>60</sup> *Ibid.*, p. 115.

Jean-Claude Pressac knows nothing of all this, believes that both chambers were delousing chambers but excludes their use for homicidal purposes. He writes:

*“It is probable that these two improvised chambers were used for the delousing of personal belongings with Zyklon B (HCN). The proximity to the laundry is an additional argument in support of this assumption.”*<sup>61</sup>

Homicidal gassings in these chambers are more than merely improbable. Polish historiography recently quit mentioning the alleged gas chambers in Hut 28, substituting one single gas chamber, the exact location of which cannot of course, be determined. In the official camp history, Józef Marszałek writes in this regard:

*“The concrete gas chambers built for utilization with Zyklon B at Majdanek were put into operation in October 1942. This gas had already begun to be utilized for the killing of Soviet prisoners of war in a provisional gas chamber using the experience accumulated at Auschwitz.”*<sup>62</sup>

Czesław Rajca, who has studied the “direct extermination” of the inmates, repeats this argument in an extensive work on Majdanek:

*“While construction of the [gas] chambers consisting of concrete was awaiting completion – which was the case in October – inmates were killed in a wooden gas chamber located near the bath [correctly: the laundry] using Zyklon B, and probably in a hut installed in intermediate Area I; the location, among other things, of the so-called small crematorium,”*<sup>63</sup>

Since the first Zyklon delivery to Majdanek camp took place on July 30, 1942 – we will discuss the Zyklon deliveries in section 5 – then the gas chamber in question must have been in operation in September and October of that year, if not as early as August.

Yet the letter from the Central Construction Administration dated October 22, 1942, and mentioned in paragraph 2, contains not the slightest reference to this gas chamber, which must have been a Zyklon B disinfection chamber. This means that it did not exist at that time.

## d) Gas Chamber VII

J.-C. Pressac writes:

*“The representative Director of the [Majdanek] Museum writes that this gas chamber was used very little – very, very little; which means, speaking frankly, that it was not used at all. This fiction is maintained to avoid offending the popular superstition that every crematorium must contain a gas chamber (like the crematoria of Auschwitz-Birkenau. [...]) If it had been desired to kill people in that room with Zyklon B, its enclave-shaped location within the building, between the autopsy room, a corridor, and the lying-in-state room, would necessarily have required artificial ventilation, not the slightest trace of which exists. Natural ventilation by means of draughts of air would have required complete evacuation of the crematorium for a period of time which is difficult to estimate.”*<sup>64</sup>



**Illustration 9:** Opening in the ceiling of the alleged homicidal gas chamber in the new crematorium of concentration camp Majdanek.

© C. Mattogno

<sup>61</sup> Pressac, *op. cit.* (note 33), p. vii.

<sup>62</sup> Józef Marszałek, *Majdanek, the Concentration Camp in Lublin*, Interpress, Warsaw 1986, p. 140.

<sup>63</sup> Czesław Rajca, “*Eksterniacja bezposrednia*” in Tadeusz Mencil (ed.): *Majdanek 1941-1944*, Wydawnictwo Lubelskie, Lublin 1991, p. 270.

<sup>64</sup> Pressac, *op. cit.* (note 33), p. ix.

These remarks are amazing and unobjectionable. This may be seen from the diagram of the crematorium drawn up by the Polish-Soviet Committee after inspecting the premises, as well as by a visual inspection of the ‘scene of the crime’. The room known as the “*Gas Chamber*” (“*komora gazowa*”) is, in reality, located between the dissection room and the morgue.

For my part, I should like to add the following considerations:

- a) the walls of the room in question show not the slightest trace of blue pigmentation;
- b) the opening broken through the roof<sup>65</sup> – measuring 26 cm × 26 cm – is not mentioned by the Polish-Soviet committee. In reality, the opening was crudely broken through at a later date, without even cutting the steel reinforcement rods, and without building a wooden shaft, as was the case in Chamber IV;
- c) there are two peep windows in the wall adjacent to the morgue. There is no way to close them, and none is mentioned by the Polish-Soviet Committee; this means that both peep windows are in the original condition. The gas would therefore have penetrated both the morgue and the oven room during any gassing action.

#### 4. Homicidal mass gassings: origins of the accusation.

As established above, the installations in question were technically unsuited for mass homicidal exterminations and consequently, such mass exterminations did not take place. We must now examine the origins of the allegations of mass gassings in Majdanek concentration camp.

The first detailed eyewitness account appeared in 1944 without naming its author. It was published by A. Silberschein. The passages of greatest interest to the present topic are as follows:

*“The **oven hut** [emphasis added] was located in the area between the first and second huts, which measured 10 m.*

*From the outside, these huts resembled the others, except that they had two massive chimneys, like factory chimneys.*

*This hut was divided into three parts, each of which was almost entirely sealed off. The first part was the undressing room (‘Wardrobe’ on the plan). The second was hermetically sealed. This is where the gas experiments were conducted (‘Gassing Room’ on the diagram). In the third room, stood three gigantic ovens. This hut was located between Area 1 and 2 [...].*

*The old and the sick were immediately ordered into the hut containing the ovens. In the first room, they were ordered to undress. In the second, they died of suffocation within two minutes. They were then transported from the second room to the ovens. A fire burned underground, the oven itself did not burn. But it collected hot air at 2,000 degrees. The dead bodies were thrown into the oven; the glowing heat sucked the fluids and moisture completely out of them. Only a few blisters remained, which were so dry, they crackled. Then special trucks carried the remains out of the city to pre-dug graves.*

*Throughout 1942, thousands of Jews were killed in the gas chambers every day. New masses were transported here every week, and that is the way it has continued until this very day.”<sup>66</sup>*

This eyewitness report is illustrated by a diagram of Majdanek, which, in the light of historical and architectural knowledge, enables one to trace the story of homicidal mass gassings at Majdanek to its roots.

The diagram consists of a truly precise drawing of “*Bath and Disinfestation Installation II*”, Hut 42 complete with “*Undressing Room*”, “*Clothing Deposit*” (for the acceptance of clothing), “*Baths*” (showers), and the “*Distribution Room for Inmate Clothing*” (for the allocation of new clothing).

---

<sup>65</sup> See ill. 9.

<sup>66</sup> A. Silberschein, *Die Judenausrottung in Polen*, Fünfte Serie; “*Das K.Z. Lager Lublin*”, manuscript, Geneva 1944, pp. 14-16.

But although the report dates back to 1943, it contains no mention of “*Bath and Disinfestation Installation P*” – Hut 41 – which, according to the Polish-Soviet description, was the center of the entire extermination program, and where exterminations had allegedly already begun in October 1942.

As far as the extermination installation itself is concerned, the witness has patched together a collage of various buildings, which certainly existed, but not in the same place, and not at the same time. The “*Gassing Room*” is simply Hut 28, in which the eyewitness has (mistakenly) placed disinfestation Chamber III located in Building XII<sup>A</sup>, or the gas chamber from Hut 41, both of which were equipped with air heaters. Even if we assume that Hut 28 – which only contained a drying installation in July 1944 – contained a Zyklon B delousing installation at an earlier date, this does not alter the fact that it was located approximately 110 m away from the crematorium, and that the laundry was located in between the two buildings.

The erroneous description of the crematory ovens appears full of riddles at first glance – but only at first glance. Let’s take the key sentences:

*“A fire burned underground, the oven itself did not burn. But it collected hot air at 2,000 degrees.”*

This description in fact does not refer to the crematory ovens at all, but rather to the coke-fired air heaters in Hut 28 and the delousing chambers III and IV. As shown in section 2, these installations are coke ovens whose furnaces were located beneath the floor, so it was true to say “*a fire burned underground*”. No combustion procedure took place in the upper part of the oven at all, so that “*the oven itself did not burn*”; instead it only “*collected hot air*”. The temperature mentioned by the witness – 2,000 degrees Celsius – would, of course, be far too high – not only for a hot air chamber, but for a crematory oven as well.<sup>67</sup> The reported number of victims – thousands per day – at another point – two million victims by the end of 1943<sup>68</sup> – are, of course, purely atrocity propaganda.

Constantin Simonov’s report is of particular significance because the unknown author who visited Majdanek right after the liberation was able to speak with former inmates who told him the story of the camp and explained the function of its installations to him. The Simonov report is based on eyewitness accounts and corresponds to the ‘official’ version of the camp history which was current among the inmates during July and August of 1944. It therefore pre-dates the version of the Polish-Soviet Committee. At several points, it deviates from the now-obligatory version of history as established shortly afterwards. It refers to an extermination installation which was then immediately forgotten and it makes no mention of a “*Gassing Room*” in the old crematorium and mistakenly locates the alleged homicidal gassings in the disinfestation installation adjacent to Hut 41. The killing technique described is rather peculiar:

*“Where does the little window lead? To find the answer to this question, we open the door and leave the chamber. Next to the chamber there is another small concrete chamber. This is where the little window leads. Here, there is an electrical light and a switch. From here, looking outward from the little window, you can see everything in the first chamber. On the floor are a few round, hermetically sealed cans labelled Zyklon B, and, in small letters: ‘For special use in the eastern territories’.<sup>[69]</sup> The contents of the cans was introduced into the adjacent chamber **through pipes** when the chamber was packed full of people.*

*The naked people stood closely next to each other; they didn’t take up much room. 250 people were packed together into 40 square meters of surface area. They were driven inside. The steel door was shut, and the cracks stuffed with clay to provide a hermetic seal. A special team wearing gas masks introduced the Zyklon contents of the round cans into the adjacent chamber through the pipes. ‘Zyklon’*

<sup>67</sup> In this regard, see our study drawn up in cooperation with Dr. Franco Deana “The Crematorium Ovens of Auschwitz Birkenau”, in this volume.

<sup>68</sup> Silberschein, *op. cit.* (note 66), p. 16.

<sup>69</sup> In fact, such a specially labeled Zyklon B never existed.



consists of small **blue** crystals, harmless in appearance. Upon contact with oxygen, however, it immediately begins to release poisonous gas, simultaneously affecting all the vital centers of the human body. **Zyklon was introduced through the pipes.**<sup>[70]</sup> The SS man directing the operation turned on the light switch; looking through the little window, the SS man watched the entire suffocation procedure, which, **as gathered from various eyewitness reports**, lasted between 2 and 10 minutes. Looking through the window, he could see everything without danger: the cruelly distorted faces of the dying, the gradual effect of the gas. The peephole for the executioners is located in just the right spot, at eye level. When the victims died, the observer didn't need to look down, since the victims didn't fall down after their death. The gas chamber was in fact, full to the brim, so that the dead stood standing motionless".<sup>71</sup> [All emphasis added]

This description of the killing method, which is completely hare-brained from a technical point of view, proves that the former Majdanek inmates never saw a homicidal gassing. No witness told Simonov of SS men on the roof of a gas chamber wearing gas masks and carrying Zyklon B cans in their hands; no one told him that the victims were killed with carbon monoxide in two areas containing gas pipe installations. As J.-C. Pressac correctly says, the Zyklon B cans found by Simonov were placed in the side room in front of Chambers I and III to give the impression that the content of the cans was introduced into the chamber through pipes. This process by former inmates of setting the scene, proves *a fortiori* in any case, that the witnesses were never present during any mass homicidal gassing. There is no doubt that rumors of mass homicidal gassings were current in the camp and that former inmates crudely sought to provide these rumors with an aura of authenticity in order to take vengeance on their oppressors, but in reality, their statements show that no homicidal gassings took place.

It is also remarkable that Simonov has nothing to say regarding Chamber IV. It is quite obvious that the former inmates did not consider it to be a homicidal gas chamber.

Later eyewitnesses are so vague and contradictory that we can skip them for the present. It is highly revealing that the long-time director of the Majdanek Memorial, Józef Marszałek, only mentions gassings in two lines in his official history of the camp. In fact, he could think of nothing better to say about the gassing procedures at Majdanek than to quote the eyewitness account of SS man Pery Broad at **Auschwitz**:

*"The technique of killing with gas was described as follows by Perry [sic] Broad, an employee of the Political Division of Auschwitz camp. A similar technique was utilized at Majdanek."*<sup>72</sup>

And that's it from the Memorial Director himself!

## 5. The Zyklon deliveries to Majdanek concentration camp

In Germany, Zyklon B was manufactured by two industrial factories, the Dessauer Werke für Zucker und Chemische Industrie A.G. in Dessau, and Kaliwerke A.G. in Kolin.<sup>73</sup> Distribution was controlled by the *DEGESCH* company (Deutsche Gesellschaft für Schädlingsbekämpfung GmbH) which was the real manufacturer as holder of the patent and manufacturing license. *DEGESCH* did not market the product directly, but rather, through two main representative companies, Heerdt und Lingerl GmbH (*Heli*), a Frankfurt corporation, and *Tesch und Stabenow*, Internationale Gesellschaft für Schädlingsbekämpfung (*Testa*), a Hamburg corporation. These two firms divided the market between them, *Heli* being active west of the Elbe, and *Tesch* east of the Elbe, exclusively in the Su-

---

<sup>70</sup> Since Zyklon B is liquid HCN adsorbed on gypsum rather than a pressurized gas, it cannot be piped.

<sup>71</sup> Simonov, *op. cit.* (note 39), 8, 9.

<sup>72</sup> J. Marszałek, *Majdanek, op. cit.* (note 62), p. 141.

<sup>73</sup> I.G. Farben produced only the warning substance, bromacetic acid methyl ester, as well as the stabilizer, chlor carbonic acid methyl ether.

**TABLE I: ZYKLON B ORDERS AND DELIVERIES TO THE CONCENTRATION CAMP OF MAJDANEK**

ORDERS			DELIVERIES		
Date	Number of cans	Mass [kg]	Period of time	Number of cans	Mass [kg]
25.07.1942/ 22.08.1942-	1,474	2,211	30.07.1942	360	540
			20.08.1942	360	540
			September 1942	754	1,131
			<i>Sub-Total</i>	<i>1,474</i>	<i>2,211</i>
22.05.1943/ 08.06.1943	3,000	4,500	16.07.1943	342	513
			September 1943	666	999
			October 1943 - June 1944	1,992	2,988
			<i>Sub-Total</i>	<i>3,000</i>	<i>4,500</i>
19.06.1944/ 03.07.1944	(500)	(250)	July 1944	(500)	(250)
<b>TOTALS:</b>	<b>4,974</b>	<b>6,961</b>		<b>4,974</b>	<b>6,961</b>

deten district, the General Gouvernement, the Reichskommissariat Ostland, and the Scandinavian states of Denmark, Norway, and Finland. Majdanek concentration camp was located in the territory of the General Gouvernement, and therefore received its Zyklon from Testa.

Extremely detailed correspondence has been found relating to the Zyklon deliveries between the camp administration on the one hand, and Testa and the SS institutions involved in Zyklon distribution for bureaucratic grounds, on the other hand. This correspondence<sup>74</sup> has been studied by Adela Toniak, who reproduced 37 of the 60 documents making up the exchange of correspondence, in a study.<sup>75</sup> The Polish author calculated that a total of 7,711 kg of Zyklon were delivered to the Lublin camp,<sup>76</sup> but her calculations contain two errors. Table I summarizes the Zyklon B orders, as well as actual deliveries.

Although the documents do not permit the slightest doubt that the administration of Lublin camp ordered Zyklon for disinfection purposes to the exclusion of any other purpose, Adela Toniak prefers to stick to her homicidal theories, adducing historically groundless arguments.<sup>76</sup> Without entering into further detail, it should be noted that the correspondence between the camp administration and the Tesch-Stabenow firm repeatedly refers to the “*danger of epidemics*”, “*disinfection of inmate housing and clothing*”, “*thorough disinfection*”, “*disinfection work*”, “*camp disinfection*”, and “*disinfection gas*” (*i.e.*, Zyklon B).<sup>77</sup> Since even Adela Toniak cannot conceal the fact that devastating typhus epidemics repeatedly ravaged Majdanek, and since Zyklon B was the most effective means of combating typhus as she also admits, there is no justification for the assumption that the Zyklon deliveries served any purpose other than the extermination of lice.<sup>78</sup>

The attempt to attribute a criminal purpose to the Zyklon deliveries forms part of an outdated system of interpretation which dominated earlier decades to ill effect, but which has been definitively destroyed by Jean-Claude Pressac. Writing in 1989, Pressac stated that 97 to 98 percent of all

<sup>74</sup> APMM, sygn. I, d. 2, vol. I.

<sup>75</sup> Adela Toniak, “*Korespondencja w sprawie dostawy cyklonu B do obozu na Majdanku*” in *ZM*, II, 1967, p. 129-170.

<sup>76</sup> *Ibid.*, p. 137.

<sup>77</sup> The documents involved are discussed in detail in the book by Jürgen Graf and Carlo Mattogno cited in footnote 1.

<sup>78</sup> The only “*criminal trace*” is the alleged ‘camouflage expression’.

Zyklon B delivered to Auschwitz, was used for disinfestation purposes and that only 2 to 3 percent was used for alleged homicidal gassing of inmates.<sup>79</sup>

In fact, these 2 to 3 percent of all Zyklon delivered to Auschwitz would have sufficed for the gassing of the reported number of victims, so that Pressac's calculation is theoretically correct. But since 2 to 3 percent of all Zyklon deliveries is an amount too small to be statistically significant, the total amount of Zyklon B delivered does not prove any homicidal gassing claims. The same applies to Majdanek.<sup>80</sup>

---

<sup>79</sup> J.-C. Pressac, *Technique and Operation of the Gas Chambers*. The Beate Klarsfeld Foundation, New York 1989, p. 1988. Pressac expresses the same opinion in his second book (German edition: *Die Krematorien von Auschwitz*, Piper Verlag, Munich 1994). The passage in question appears on page 58 of that edition.

<sup>80</sup> Assuming a concentration of HCN 10 times higher than that which is immediately lethal – 0.3 g/m<sup>3</sup> – one 1,500 gram can of Zyklon in Chamber III would have enough to kill 3,000 people. This figure is calculated as follows: Chamber III is approximately 35 m<sup>2</sup> in surface area, with a volume of approximately 70 m<sup>3</sup>. Assuming, with Pressac, a maximum number of 350 victims per gassing action, and theoretically assuming a HCN concentration ten times higher than that which is rapidly lethal to human beings – 0.3 g/m<sup>3</sup> – the quantity of HCN required for one gassing procedure would be as follows:

- effective volume: approximately 50 m<sup>3</sup> (the bodies of the victims would occupy approximately 20 m<sup>3</sup>).
- HCN concentration:  $0.3 \times 10 = 3 \text{ g/m}^3$
- required quantity: HCN:  $3 \times 50 = 150 \text{ gr}$ .

# Diesel Gas Chambers: Ideal for Torture – Absurd for Murder

FRIEDRICH PAUL BERG

## 1. Diesel Exhaust and Zyklon B

Most National Socialist homicidal gassings were supposedly committed with Diesel exhaust rather than cyanide or Zyklon B. Although this is contrary to popular perceptions about the Holocaust story, Diesel exhaust has been dominant, at least in terms of numbers of victims, in the claims of Holocaust scholars since the 1960's. The Diesel allegations did, however, gain some public notoriety with the prosecution of American citizen John Demjanjuk. Demjanjuk was accused of having murdered at least 875,000 Jews with Diesel exhaust at the alleged extermination camp at Treblinka in 1942/43.<sup>1</sup> An nationally syndicated essay from one of America's best-known newspaper columnists Patrick Buchanan raised the subject of Diesel gassing to a fever pitch in the American press. Buchanan, a former assistant to President Ronald Reagan, claimed that Diesel engines could not kill at all.<sup>2</sup> His sweeping statement, which was far too broad, brought him massive criticism but not for any valid technical reasons.<sup>3</sup>

In 1992, a working draft paper authored by Walter Lüftl, President of the Austrian Federal Chamber of Engineers, described mass murder with Diesel exhaust as a “*sheer impossibility*.”<sup>4</sup> Shortly thereafter, he substantiated his view as to the relative harmlessness of Diesel exhaust in an essay,<sup>5</sup> which was publicly attacked as well.<sup>6</sup>

For readers familiar with auto emission issues, much of what follows represents a kind of ‘over-kill’ and rightly so. But in order to put the Holocaust monster to its final, well-deserved rest – at least its Diesel portion – one must be rigorous and even exhaustive. Since Diesel gassings are not technically impossible, we must actually show how it could have been done hypothetically, and then, just how thoroughly unreasonable it is to believe the National Socialists would have ever used the necessary technology.

In any event, according to my conviction, National Socialist homicidal gassings never happened!

---

This chapter is an expanded and revised edition of F. P. Berg's article “*The Diesel Gas Chambers – Myth Within a Myth*”, *The Journal of Historical Review (JHR)* 5(1) (1984), pp. 15-46 (online: [ihr.org/jhr/v05/v05p-15\\_Berg.html](http://ihr.org/jhr/v05/v05p-15_Berg.html)). Although this author gladly takes credit for this work, the editor Germar Rudolf deserves credit also for having made many substantive additions to the arguments and for many important reference citations.

<sup>1</sup> The history of, and public reactions to, this travesty of justice are described in the following chapter by A. Neumaier.

<sup>2</sup> *New York Post*, March 17, 1990; *The Washington Times*, March 19, 1990; repeated on “*This Week with David Brinkley*”, ABC television, Sunday, Dec. 8, 1991.

<sup>3</sup> *The New Republic*, Oct. 22, 1990; G. F. Will, *Newsweek*, March 4, 1996. See especially: Friedrich Paul Berg, Friedrich Paul”, “*Pat Buchanan and the Diesel Exhaust Controversy*,” [www.codoh.com/gcgvwill.html](http://www.codoh.com/gcgvwill.html)

<sup>4</sup> Cf. the chapter by W. Rademacher, this volume, as well as *afp*, “*Österreicher bestreitet Holocaust*”, *Süddeutsche Zeitung*, March 13, 1992, p. 10; *Neue Kronenzeitung*, April 20, 1993; “*Ein rauhes Lüftl*”, *Bau* 5/1995, p. 8; “*Rechte Gutachten*”, *Profil*, June 20, 1994; E. Kosmath, letter to the editor, *Bau* 11/1994; ARA, “*Lüftl wieder in Kammer, ‘Schwieriges Problem’*”, *Standard* (Vienna), Sept. 19, 1994.

<sup>5</sup> W. Lüftl, “*Sollen Lügen künftig Pflicht sein?*”, *Deutschland in Geschichte und Gegenwart*, 41(1) (1993), pp. 13f. (online: [vho.org/D/DGG/Lueftl41\\_1.html](http://vho.org/D/DGG/Lueftl41_1.html)).

<sup>6</sup> J. Bailer, in Brigitte Bailer-Galanda, Wolfgang Benz, Wolfgang Neugebauer (eds.), *Wahrheit und Auschwitzlüge*, Deuticke, Vienna 1995, pp. 99-118, here 100-107; cf. G. Rudolf, “*Zur Kritik an ‘Wahrheit und Auschwitzlüge’*”, in Vrij Historisch Onderzoek (ed.), *Kardinalfragen zur Zeitgeschichte*, Vrij Historisch Onderzoek, Berchem 1996, pp. 91-108, here 98-102 (online: [vho.org/D/Kardinal/Wahrheit.html](http://vho.org/D/Kardinal/Wahrheit.html); English: [vho.org/GB/Books/cq/critique.html](http://vho.org/GB/Books/cq/critique.html)).

## 2. Introduction

In any trial of even the most ordinary murder, one can expect an abundance of information about the murder weapon. One would expect the Allied and German post-war trials about murder as novel and as bestially spectacular as the mass murder of millions of Jews in gas chambers to provide the most extensive and precise documentation possible. Although there is a vast literature based primarily on those trials, as far as the actual mechanics of the extermination process are concerned, all one really finds is an occasional short and vague description.

Nearly sixty years have elapsed since the end of World War Two. The Holocaust specialists have had more than enough time to examine documents and alleged mass murder sites as well as testimony from the most extensive trials in the entire history of the world. Throughout this period they have been extremely active – but aside from a few bits and pieces of so-called ‘confessions’ and ‘eyewitness testimony,’ they have found next to nothing. The vast information gaps about the actual mechanics of the alleged extermination process should arouse the gravest suspicion.

Although the information gaps are bad for the exterminationist position; what is even worse is that the few bits and pieces of information are simply incredible. To characterize the alleged mass murder methodology as ‘hare-brained,’ ‘crackpot,’ or ‘weird’ is to understate the situation. If one looks at the claims critically, sooner or later it becomes obvious that the people who repeat the Holocaust story in one form or another simply have no idea as to what they are talking about. The testimony of so-called ‘eyewitnesses’ is especially weird. The statement by Kurt Gerstein, which for a long time was the evidence most often used by Holocaust specialists, is the best example qualitatively. The other ‘statements’ or ‘confessions’ are even worse.

The absurdities of the various alleged extermination methods do not in and of themselves prove that the Holocaust did not happen, but they should at least persuade reasonable people to ask for some strong corroborating evidence. There are, for example, no autopsy reports of gassing victims. The ‘gas chambers’ of Treblinka, Belzec and Sobibor were all allegedly destroyed before the war ended. Those in Auschwitz and Majdanek as well as those in the camps in the Reich proper are ordinary rooms (mortuaries, shower rooms, delousing chambers) that have been mislabeled ‘gas chambers’ in spite of their obvious design and function – often to keep people alive.<sup>7</sup>

To concoct horrible but conveniently vague ‘eyewitness’ accounts of mass murder is easy. To have such tales accepted about a defeated enemy nation after a brutal war, during which the vast media resources of the victors had already succeeded in portraying the enemy as thoroughly depraved and wicked, is also easy. On the other hand, it is not at all easy to explain how one could possibly commit mass murder with Diesel exhaust. The exterminationists have never provided the necessary explanation, not even in the great Israeli show trial of Ivan Demjanjuk, where precisely such an explanation of the Diesel-murder-method should have been demanded – at least by the defense.

## 3. The Exterminationist Position

Table 1 is from *The Destruction of the European Jews* by Raul Hilberg and was published in 1961. The table summarizes the views of practically all generally accepted ‘consensus’ writers on the Holocaust story over the last 40 years. The camps listed are the only ones still regarded as ‘extermination’ camps.

The fourth column from the left shows that in almost all of the camps, the killing operation supposedly used carbon monoxide (CO). In Auschwitz the killing operation supposedly used only hydrogen cyanide (HCN). Of the five camps where carbon monoxide was supposedly used, the vast majority of victims are said to have been killed in just three camps: Treblinka, Belzec, and Sobibor. The carbon monoxide was supposedly generated by Diesel engines. The number of Jews supposedly killed in Kulmhof (Chelmno) or Lublin (Majdanek) are small compared to the numbers for Treblinka, Belzec and Sobibor. The gas vans supposedly employed in Russia also used Diesels.

---

<sup>7</sup> Cf. the articles by G. Rudolf, Carlo Mattogno, and Jürgen Graf in this volume.

**Table 1: Characteristics of the Death Camps According to Raul Hilberg<sup>8</sup>**

Camp	Location	Jurisdiction	Type of Killing Operation	Number of Victims*
Kulmhof (Chelmno)	Wartheland	Higher SS and Police Leader (Koppe)	gas vans (CO)	150,000
Belzec	Lublin district	SS and Police Leader (Globocnik)	gas chambers (CO)	600,000
Sobibor	Lublin district	SS and Police Leader (Globocnik)	gas chambers (CO)	200,000–250,000 <sup>9</sup>
Lublin (Majdanek)	Lublin district	WVHA (SS Economic-Administrative Main Office)	gas chamber (CO, HCN) shooting	50,000-200,000 <sup>9</sup>
Treblinka	Warsaw district	SS and Police Leader	gas chambers (CO)	750,000 700,000 <sup>9</sup> –1,200,000 <sup>10</sup>
Auschwitz	Upper Silesia	WVHA	gas chambers (HCN)	one million <sup>11</sup>

\*Updated figures were added here; cf. the appropriate notes.

On the basis of generally accepted numbers of victims, *nearly two-thirds of all the alleged Jewish victims of German gas chambers were supposedly gassed with Diesel exhaust.*

For at least several months in 1939 and 1940, Diesel engines had supposedly been used in Germany's euthanasia program to kill Germans who were feeble-minded or incurably ill. The experience gained from this early use of Diesels was allegedly applied later by some of the same people, such as *Reichsamleiter* Viktor Brack and *Kriminalkommissar* Christian Wirth, to kill Jews in Treblinka, Belzec, and Sobibor in eastern Poland. According to Hilberg, it was Wirth who constructed the “*carbon monoxide gas chambers*” for the euthanasia program on the orders of Brack who was “*actually in charge of the [euthanasia] operation.*” Then in the spring of 1942, Brack ordered Wirth to Lublin where “*Wirth and his crew immediately and under primitive conditions began to construct chambers into which they piped carbon monoxide from Diesel motors.*”<sup>12</sup>

In 1978 and 1979, major American television network NBC broadcast a four-day television miniseries entitled “*Holocaust*,” which was essentially a dramatization of the generally accepted Holocaust story. There were several references to the use of Diesel engines for mass murder. In one scene, Dr. Bruno Tesch, who in real life had actually been a highly qualified chemist and was hanged after the war by the Allies,<sup>13</sup> explains to Eric Dorf, a totally fictional SS officer administering the extermination program, that one of the advantages of Zyklon B over carbon monoxide is that Zyklon B “*won't clog machinery – and there's no apparatus to break down, as in carbon monoxide.*” In another scene, Rudolf Höß, the commandant of Auschwitz, is about to start a Diesel engine when Eric Dorf explains to him that he will not need the Diesel any longer because he has ordered another substance, Zyklon B.

Reality is rather different from what was suggested in the NBC miniseries and in some of the literature. The Zyklon B used in Auschwitz consisted of granules made of gypsum and starch, which certainly would have instantly clogged machinery and/or shower piping, although the cyanide gas released from Zyklon-B granules would not clog anything. Diesel exhaust does not clog machinery easily at all – unless the engine is making smoke under an extremely heavy. This smoke contains some solid matter which can, indeed, clog machinery (foul the cylinders), if there is more smoke than can be blown out with the exhaust. Otherwise, no clogging of cylinders occurs.

<sup>8</sup> R. Hilberg, *The Destruction of the European Jews*, Quadrangle Books, Chicago 1961, p. 572; German ed.: *Die Vernichtung der europäischen Juden*, Olle & Wolter, Berlin 1982, p. 604.

<sup>9</sup> Updated with information from the official German *Institut für Zeitgeschichte* (Institute for contemporary History).

<sup>10</sup> Maximum figure given by F. Golczewski in W. Benz, *Dimension des Völkermords*, Oldenbourg, Munich 1991, p. 495.

<sup>11</sup> From 9 million to 500,000, depending on the source. At the moment, 1 million is the officially espoused figure; cf. the chapter on statistics by G. Rudolf, this volume.

<sup>12</sup> R. Hilberg, *op. cit.* (note 8), Eng. ed. p. 562.

<sup>13</sup> William B. Lindsey, “*Zyklon B, Auschwitz, and the Trial of Dr. Bruno Tesch*”, *JHR* 4(3) (1983), pp. 261-303 (online: [vho.org/GB/Journals/JHR/4/3/Lindsey261-303.html](http://vho.org/GB/Journals/JHR/4/3/Lindsey261-303.html)).

## 4. Kurt Gerstein

The statement of Kurt Gerstein remains a major cornerstone of the Holocaust legend. Gerstein was an *Obersturmführer* (First Lieutenant) in the SS and a mine surveyor by profession with a graduate degree in engineering. When he surrendered to the French, he supposedly gave them a prepared statement dated April 26, 1945. He had been elevated to the status of “*righteous gentile*” by the Israelis and various Jewish writers for having at least tried to alert the world to the National Socialist extermination program. As H. Roques pointed out,<sup>14</sup> six different versions of the Gerstein Statement have been found to date and published by various researchers often in grossly distorted and mutilated form.<sup>15</sup> Many parts of Gerstein’s statements range from the fantastically incredible to the downright impossible. He allegedly committed suicide in a French prison after having offered himself in vain as an informer to the French. The trend in recent years has been to dissociate from him as ‘witness for the prosecution’. Nonetheless, his ‘statements’ are the only ones which give at least a few technical details about the alleged Diesel gassings. Raul Hilberg, for example, referred to his ‘statement’ many times without actually quoting from it.<sup>16</sup>

The following text is an excerpt from the Gerstein Statement as given in *Harvest of Hate* by Léon Poliakov. Aside from a rather brazen ‘error’ on the part of Poliakov – namely the claim that 700 to 800 bodies were crowded into 93 square meters (1,000 sqf), instead of only 25 square meters (269 sqf), which is the way the original document actually reads – it is probably no worse than any of the other translations which can be found:<sup>15</sup>

“SS men pushed the men into the chambers. ‘Fill it up’, Wirth ordered; 700-800 people in 93 [sic; original claims 25] square meters. The doors closed. [...]

Then I understood the reason for the ‘Heckenholt’ sign. Heckenholt was the driver of the Diesel, whose exhaust was to kill these poor unfortunates.<sup>[17]</sup> SS Unterscharführer Heckenholt tried to start the motor. It wouldn’t start! Captain Wirth came up. You could see he was afraid because I was there to see the disaster. Yes, I saw everything and waited. My stopwatch clocked it all: 50 minutes, 70 minutes, and the Diesel still would not start! The men were waiting in the gas chambers. You could hear them weeping ‘as though in a synagogue’, said Professor Pfannenstiel, his eyes glued to the window in the wooden door.<sup>[18]</sup> Captain Wirth, furious, struck with his whip the Ukrainian who helped Heckenholt. The Diesel started up after 2 hours and 49 minutes, by my stopwatch. Twenty-five minutes passed. You could see through the window that many were already dead, for an electric light illuminated the interior of the room. All were dead after thirty-two minutes!

Jewish workers on the other side opened the wooden doors. They had been promised their lives in return for doing this horrible work, plus a small percentage of the money and valuables collected. The men were still standing, like columns of stone, with no room to fall or lean. Even in death you could tell

<sup>14</sup> H. Roques, *Faut-il fusiller Henri Roques?*, Ogmios Diffusion, Paris 1986 (cf. online: [abbc.com/aaargh/fran/ACHR/ACHR.a.html](http://abbc.com/aaargh/fran/ACHR/ACHR.a.html)); cf. also André Chelain, *La Thèse de Nantes et l’affaire Roques*, Ogmios Diffusion, Paris 1989; abbrev. German ed.: H. Roques, *Die “Geständnisse” des Kurt Gerstein*, Druffel, Leoni 1986 (online: [abbc.com/aaargh/deut/HRgerstein1.html](http://abbc.com/aaargh/deut/HRgerstein1.html)); cf. D. Felderer, *JHR* 1(1) (1980), pp. 69-80; D. Felderer, *JHR* 1(2) (1980), pp. 169-172 (online: [vho.org/GB/Journals/1/1/Felderer69-80.html](http://vho.org/GB/Journals/1/1/Felderer69-80.html) & .../2/Felderer169-172.html); C. Mattogno, *Il rapporto Gerstein – Anatomia di un falso*, Sentinella d’Italia, Monfalcone 1985; cf. Raul Hilberg, “Expert’s admission: Some gas death ‘facts’ nonsense”, *Toronto Sun*, Jan. 17, 1985.

<sup>15</sup> An example of gross distortions is L. Poliakov, *Harvest of Hate*, Schocken Books (Holocaust Library), New York 1979, p. 195 (French ed.: *Bréviaire de la Haine*, Calman-Levy, Paris 1951, pp. 220ff.).

<sup>16</sup> R. Hilberg, *The Destruction of the European Jews*, Holmes and Meier, New York 1985, pp. 890, 892, 963, 964, 975f.

<sup>17</sup> According to Y. Arad, *Belzec, Sobibor, Treblinka: The Operation Reinhard Death Camps*, University Press, Bloomington 1987, p. 123, the real name of this Heckenholt was Lorenz Hackenholt. Besides Hackenholt, Arad claims that Ivan Demjanjuk was responsible for operating the Diesel gas chambers in Treblinka, *ibid.*, p. 86. In light of the disastrous outcome of the Demjanjuk affair for the Israelis, it should now be obvious that most of the eyewitness accounts used by Arad are worthless. It appears that Arad’s book, published when the Demjanjuk case was not yet settled, is nothing more than propaganda for influencing the trial’s outcome.

<sup>18</sup> This sentence is missing from the version given by H. Rothfels (ed.), “*Augenzeugenberichte zu den Massenvergasungen*,” *Vierteljahrshefte für Zeitgeschichte* 1 (1953), pp. 177-194. Instead, Rothfels remarked: “A strictly personal observation then follows.”

*the families, all holding hands. It was difficult to separate them while emptying the room for the next batch. The bodies were tossed out, blue,<sup>[19]</sup> wet with sweat and urine, the legs smeared with excrement and menstrual blood.”*

It is physically impossible to crowd 700 to 800 people into a space of only 25 square meters, *i.e.*, 28 to 32 people per square meter.<sup>20</sup> According to Gerstein, it was not a peephole through which Professor Pfannenstiel supposedly looked into the gas chamber – it was a window in a wooden door, and not a gas-tight, panic-proof steel door as one might expect. Supposedly, there were wooden doors on two sides of at least one of the gas chambers. We are told that the intended victims were still alive after almost three hours in the gas chambers before the Diesel even started, so there must have been many air leaks into the chambers or else the Jews would have been asphyxiated without the aid of any Diesel.

There is no mention anywhere of the intended victims trying to break out. Wooden doors with glass windows would hardly have withstood a determined group effort to break through. Surely, Prof. Pfannenstiel, with “*his eyes glued to the window,*” would have noticed if some people had been trying to smash the glass. But no, we are told instead that the victims were calm enough and reflective enough to form groups of family members, and hold hands, and even weep.

More than likely, Dr. W. Pfannenstiel, Professor of Medicine at Marburg, had been sent to Belzec and other camps as medical adviser to improve hygiene and health care in the camps. After the war, he was repeatedly interrogated regarding his visit to Belzec with Gerstein. He was charged in two cases but never convicted. In the court-room statements, which are available to us, he never directly disputed Gerstein’s account, but in a private letter he described the Gerstein Statement as “*highly dubious rubbish in which ‘fantasy’ far outweighs fact.*”<sup>21</sup> He also wrote that due to the persecution and slander to which he was exposed, he did not wish to comment further on the matter publicly. In other words, Pfannenstiel had clearly tried to avoid further trouble for himself. The ‘whole truth’ would have been too much for his prosecutors to bear.

According to the last sentence of the Gerstein text quoted above, the bodies of the victims were “*blue.*” Here we have a major flaw as far as the death-from-carbon-monoxide theory is concerned because victims of carbon monoxide poisoning are not blue at all. On the contrary, victims of carbon monoxide poisoning are a distinctive ‘cherry red’ or ‘pink’.<sup>22</sup> This is clearly spelled out in most toxicology handbooks and is probably well known to every doctor and to most, if not all, emergency medical personnel. Carbon monoxide poisoning is actually very common because of the automobile and accounts for more poison gas injuries than all other gases combined.

The Gerstein statement, to its credit, does not claim that carbon monoxide was the lethal ingredient in the Diesel exhaust. It is the post-war exterminationists who insist that death was due to the carbon monoxide in the Diesel exhaust. The recurrence of references to “*bluish*” corpses in several other examples of so-called ‘eyewitness testimony’ from West German trials merely demonstrates the ‘copy-cat’ nature of much of that testimony. That such testimony has been accepted by West German courts specializing in Holocaust-related cases and by the Holocaust scholars, apparently without any serious challenge, merely demonstrates the shoddiness of those trials and the pseudo-scholarship which pervades the subject in general.

<sup>19</sup> Version T2, H. Roques, *op. cit.* (note 14), German ed., p. 57.

<sup>20</sup> Even closely crowded, 10 people per square meter are the maximum; cf. E. Neufert, *Bauentwurfslehre*, Vieweg, Wiesbaden 1992, p. 27; cf. U. Walendy, *Historische Tatsachen* no. 29, Verlag für Volkstum und Zeitgeschichtsforschung, Vlotho 1985, p. 12: 46 persons will fit onto the 4.44 m<sup>2</sup> load area of a heavy-goods vehicle, according to *Quick*, April 25, 1985.

<sup>21</sup> Letter from Pfannenstiel to P. Rassinier, dated Aug. 3, 1963, published in W. Stäglich, U. Walendy, “*NS-Bewältigung*”, *Historische Tatsachen* no. 5, Historical Review Press, Southam (GB) 1979, p. 20.

<sup>22</sup> Regarding the toxicology of carbon monoxide, cf. *e.g.*: W. Forth, D. Henschler, W. Rummel, K. Starke, *Allgemeine und spezielle Pharmakologie und Toxikologie*, 6<sup>th</sup> ed., Wissenschaftsverlag, Mannheim 1992, pp. 756ff.; S. Kaye, *Handbook of Emergency Toxicology*, C. C. Thomas, Springfield 1980, pp. 187f.; C. J. Polson, R. N. Tattersall, *Clinical Toxicology*, Lippincott, Philadelphia 1969, pp. 604-621.



*If the corpses had indeed appeared “blue,” death certainly would not have been due to carbon monoxide poisoning. A bluish appearance could, however, have been an indication of death from asphyxiation, i.e., from lack of oxygen.*

According to Léon Poliakov, a French-Jewish historian who has written at length in support of the Holocaust story,

“[...] *there is little to add to this description [the Gerstein Statement], which holds good for Treblinka and Sobibor as well as for the Belzec camp. The latter installations were constructed in almost the same way and also used the exhaust carbon monoxide gases from Diesel motors as death agents.*”

According to Poliakov, more than a million and a half people were killed with Diesel exhaust.<sup>23</sup>

## 5. Toxic Effects of Carbon Monoxide

To investigate the Diesel gas chamber claim, the two most important questions are:

- How much carbon monoxide is actually needed to kill a human being in half an hour?
- Does Diesel exhaust ever contain that much carbon monoxide?

Carbon monoxide poisoning has been thoroughly studied since about 1920 when it was carefully examined to determine the ventilation requirements of tunnels for motor vehicles, particularly for the Holland Tunnel in New York City. Since the early 1940s, it has been widely accepted on the basis of the research of Yandell Henderson and J. S. Haldane that *given a normal oxygen content of the air*, an average carbon monoxide concentration of “0.4% and above,” as shown on the last line of Table 2, is needed to kill people in “less” than one hour of continuous exposure.<sup>24</sup> Concentrations of 0.15%/vol. to 0.20%/vol. are “*dangerous*,” which means they might kill some people in one hour, especially if those people have, for example, weak hearts. But, to commit mass murder in a gas chamber one would need a concentration sufficient to kill not merely a *portion* of any given group of people but rather, sufficient to kill *all*. The prospect of ‘survivors’ of a gassing being ‘regassed’ later on or disposed of in some other way is too ridiculous.

The vagueness introduced by Henderson’s use of the term “less” is unfortunate. It arises from the fact that although Henderson and others could test for non-lethal effects in a laboratory with a high degree of accuracy, the lethal effects could not be tested in the same way. The lethal effects and the corresponding CO levels were determined by careful extrapolation of carboxy-hemoglobin levels over time from non-lethal tests on humans as well as from some lethal tests on animals. Although the concentrations given for lethal effects are not as precise as one might wish, they are still sufficiently accurate to support some important conclusions about Diesel gas chambers.

According to the exterminationists, the gassing was always done in about half an hour or less.<sup>25</sup>

To determine the carbon monoxide concentration needed to kill in only half an hour instead of a full hour, one can use a widely accepted rule of thumb known as “*Henderson’s Rule*,” which is:

$$\%/\text{vol. CO} \times \text{exposure time} = \text{Constant for any given toxic effect.}$$

<sup>23</sup> L. Poliakov, *Harvest of Hate*, *op. cit.* (note 15), p. 196. Further typical and fundamental sources that speak of the use of Diesel engines include: W. Grossmann, *Die Hölle von Treblinka*, Foreign Languages Publishing House, Moscow 1947: death occurred within 10-20 minutes due to tank engine exhaust, sometimes also due to vacuum and steam; Eliahu Rosenberg, *Tatsachenbericht*, Jewish Historical Documentation, Dec. 24, 1947, p. 4: mass murder with Diesel engine exhaust within 20-35 minutes (published in H. P. Rullmann, *Der Fall Demjanjuk*, Verlag für ganzheitliche Forschung und Kultur, Struckum 1987, pp. 133-144); World Jewish Congress *et al.* (eds.), *The Black Book: The Nazi Crime Against the Jewish People*, New York 1946; reprint by Nexus Press, New York 1981: no fewer than 3 million victims in Treblinka due to carbon monoxide from tank engines, sometimes also due to vacuum and steam.

<sup>24</sup> W. Braker, A. L. Mossman, *Effects of Exposure to Toxic Gases*, Matheson Gas Products, East Rutherford 1970, p. 12; 2<sup>nd</sup> ed., D. Siegel, Lynhurst, N.J., 1977.

<sup>25</sup> According to the eyewitness statements in E. Kogon, H. Langbein, A. Rückerl *et al.* (eds.), *Nationalsozialistische Massentötungen durch Giftgas*, Fischer, Frankfurt/Main 1986, p. 159 (E. Fuchs, 10 mins.), p. 167 (K.A. Schluch, 5-7 mins.), p. 174 (K. Gerstein, 18 mins.), p. 181 (A. Goldfarb, 20-25 mins.), the gassing procedure allegedly sometimes took much less time; in accordance with Gerstein: Matthes, in H. P. Rullmann, *op. cit.* (note 23), p. 167: 30 min.

In other words, for any given toxic effect, the poisonous concentration must be inversely proportional to the time of exposure. This means that to kill in half an hour, one needs twice the concentration that one would need to kill in a full hour. Applying this rule to the ‘0.4% and above’ needed to kill in “less than 1 hour,” we get 0.8%/vol. as the minimum concentration needed to kill in less than half an hour.<sup>26</sup>

Applying the same rule to the 0.15 to 0.20%/vol. range, which is “dangerous” for one hour of exposure, we get 0.3%/vol. to 0.4%/vol. as the range of CO concentration, which is dangerous for half an hour of exposure.

What all this means is that to have any kind of practical gas chamber using carbon monoxide as the lethal agent, one needs an average concentration of at least 0.4%/vol. carbon monoxide – but, possibly as much as 0.8%/vol. We should keep ‘0.4% to 0.8%’ in mind as benchmark numbers to which we will refer shortly. Please note that these data hold true only in the presence of a *normal oxygen content* of the air!

If one were to reduce the oxygen content by half for example – from the normal 21%/vol. to only 10.5%/vol. – any given concentration of CO will be twice as toxic. Even a CO concentration of only 0.2%/vol. would then suffice to kill in one hour. So, in order to determine the actual effectiveness of a given concentration of CO, it is necessary to see it in relation to the actual oxygen concentration present. To properly use the values shown in our tables and graphs, one must determine the CO content that would have the same effect with a normal oxygen level as the actual CO content with reduced oxygen. This concentration, which we shall call the “*effective CO-concentration*,” or  $c(\text{CO}_{\text{eff}})$ , is determined by multiplying the actual CO-concentration, or  $c(\text{CO})$ , by the ratio of the normal oxygen content (21%) to the actual oxygen content (x%):

$$c(\text{CO}_{\text{eff}}) = c(\text{CO}) \times \frac{x\%}{21\%}$$

Another important consideration is always the *average concentration* over the entire time of exposure, and not some quantity of poison measured in pounds or cubic feet. In our current discussion, this is a problem, since to determine the concentration one would like to know the volume of the gas chamber which is not really possible here due to the general lack of information. Neither is it possible to solve this problem by determining an absolute quantity of poison instead of a concentration value. The few data regarding gas chamber size, which we do have for example from the Gerstein Statement, are so unbelievable that there is no point in trying to work from them. But we do know that the average CO concentration will always be less than the CO concentration measured directly on the exhaust side of the Diesel engine.

**Table 2: Toxic Effects of Carbon Monoxide<sup>27</sup>**

Parts of carbon monoxide per million parts of air	Carbon monoxide in %/vol.	Physiological effects
100	(0.01)	Allowable concentration for an exposure of several hours
400 to 500	(0.04 – 0.05)	Inhalation for up to 1 hour without appreciable effect
600 to 700	(0.06 – 0.07)	Appreciable effect after exposure of 1 hour
1,000 to 1,200	(0.10 – 0.12)	Indisposition but no dangerous effects after exposure of 1 hour
1,500 to 2,000	(0.15 – 0.2)	Dangerous concentrations for exposure of 1 hour
4,000 and above	(0.4 and above)	Fatal in exposure of less than 1 hour

<sup>26</sup> F. E. Camps, *Medical and Scientific Investigations in the Christie Case*, Medical Publications Ltd., London 1953, p. 170.

<sup>27</sup> Y. Henderson, H. W. Haggard, *Noxious Gases*, Reinhold Publishing, New York 1943, p. 168.

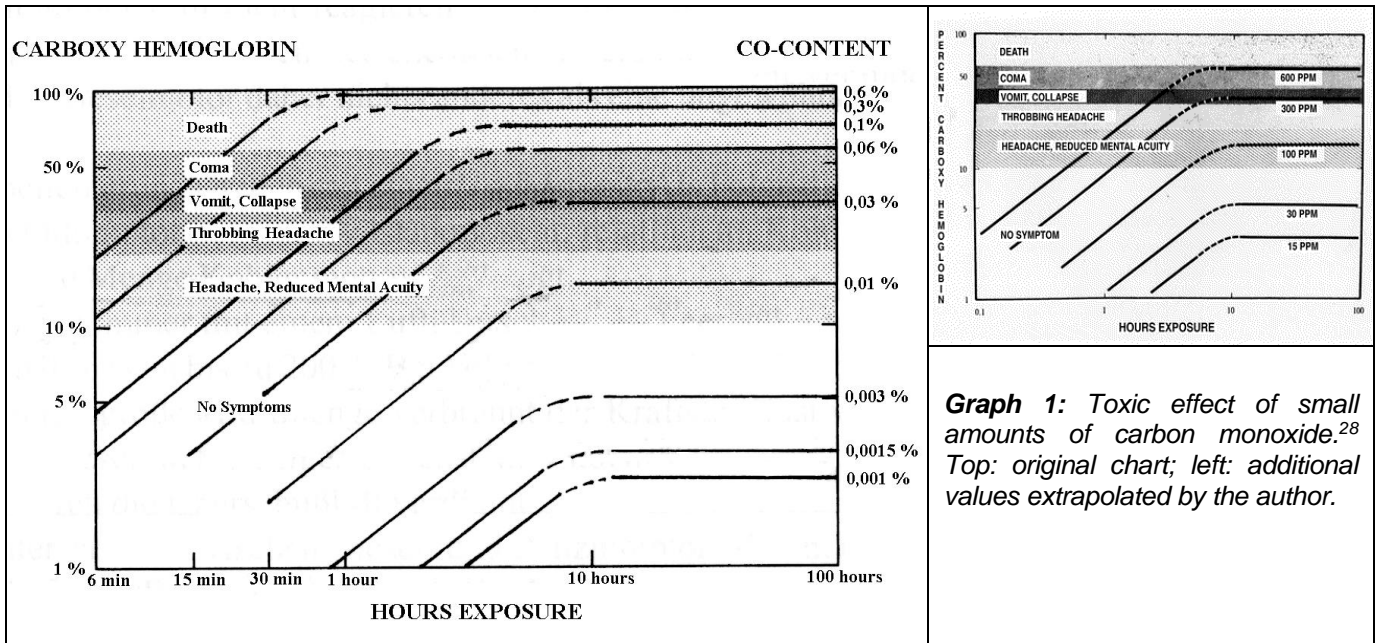

**Graph 1:** Toxic effect of small amounts of carbon monoxide.<sup>28</sup> Top: original chart; left: additional values extrapolated by the author.

Table 3 shows the Hb·CO levels of carbon monoxide victims from the 1950s. In the literature of toxicology, 60% Hb·CO is generally cited as the fatal level (cf. Graph 1). According to Table 3, more than ¼ of all people would be dead at this concentration. Almost another 50% die at levels up to 70% Hb·CO, and the last quarter would die only when the concentration had increased to 80% Hb·CO (see also the scattergram Graph 2). So, to build an effective CO execution gas chamber which, in keeping with eyewitness testimony, kills everyone within half an hour – even young, healthy people with good nerves – the chamber would have to reliably induce a level of 80% Hb·CO. An average CO content of 0.4% by volume in the gas chamber air would be the absolute minimum required (cf. Graph 1).

Graph 1 gives the symptoms from various low-level carbon monoxide exposures as a function of duration of exposure. The highest CO concentration discussed is 600 ppm (parts per million). 600 ppm is another way of saying 0.06%/vol. The chart shows that after one hour of exposure to an average concentration of 600 ppm of CO, one would experience a headache, but not a throbbing one. Even after 100 hours of exposure, the worst that one would experience would be unconsciousness, but not death. However, after only half an hour of exposure to 600 ppm, no symptoms are indicated at all – not even a mild headache. We should keep ‘0.06%’ in mind as another benchmark number to which we will refer later in this chapter.

To obtain more reliable data about the effects of a higher CO content in exhaust than those extrapolated here, one can consult accident and suicide statistics. Accident or suicide victims who died from

Hb·CO [%]	Age of Victims [years]							Sum
	18-30	30-40	40-50	50-60	60-70	70-80	80-90	
<b>40-50</b>	–	–	–	–	–	7	4	11
<b>50-60</b>	2	–	1	3	1	5	5	17
<b>60-70</b>	7	2	6	12	10	8	–	45
<b>70-80</b>	5	2	5	7	8	–	–	27
<b>Total:</b>	14	4	12	22	19	20	9	100

<sup>28</sup> P. S. Myers, “Automobile Emissions – A Study in Environmental Benefits versus Technological Costs”, *Society of Automotive Engineers Transactions* 79 (1970), section 1, paper 700182, p. 662.

<sup>29</sup> Keith Simpson (ed.), *Taylor’s Principles and Practice of Medical Jurisprudence*, J. & A. Churchill, London 1965, pp. 366f.; Graph 2 originally appeared in K. Simpson, R.A. Furbank, *Journal for Medicine*, 2 (1995), p. 5.

carbon monoxide are frequently tested for the carboxy-hemoglobin (Hb·CO)<sup>30</sup> concentration in their blood.

What any would-be National Socialist mass murderers needed to achieve with their gas chambers is called by toxicologists the “LD<sub>100</sub>,” the lethal dose for killing 100% of the victims. The concrete implications of this can be seen from the statistical analysis of a study of 100 deaths from carbon monoxide poisoning.

## 6. The Diesel Engine

### 6.1. Introduction

Although information as to engine type and size might be considered essential in the investigation of any ordinary murder, such details are just too much to expect when one is dealing with the Holocaust hoax. Without more specific information, we must investigate the broader and far more difficult question of whether or not any Diesel ever built could possibly have done the abominable deed. The most frequent claim, however, is that the engines were Diesels from Soviet tanks.<sup>31</sup>

If Gerstein had claimed that the carbon monoxide was generated by gasoline engines, his story would be more credible. Gasoline engines can indeed kill rather easily and with little or no warning because their exhaust is almost odorless. Although Diesel engines look like gasoline engines, at least to most people, they are actually quite different. Any mining engineer or mine surveyor, such as Gerstein was, should certainly have been able to easily distinguish between the two types of engines. For one thing, the sound of Diesels is so distinctive that almost anyone can with a little experience recognize them with his eyes closed.

When Diesels are running, they actually warn us of their presence: their exhaust smells terrible. In other words, every Diesel engine comes with its own built-in ‘warning ingredient.’ The intensity of the smell or stench has, no doubt, given rise to the thoroughly false impression that Diesel exhaust must, therefore, be very harmful. The simple-minded but false logic which guides Holocaust believers is that, since gasoline engine exhaust can certainly kill, even though it has little odor, Diesel exhaust,

When Diesels are running, they actually warn us of their presence: their exhaust smells terrible. In other words, every Diesel engine comes with its own built-in ‘warning ingredient.’ The intensity of the smell or stench has, no doubt, given rise to the thoroughly false impression that Diesel exhaust must, therefore, be very harmful. The simple-minded but false logic which guides Holocaust believers is that, since gasoline engine exhaust can certainly kill, even though it has little odor, Diesel exhaust,

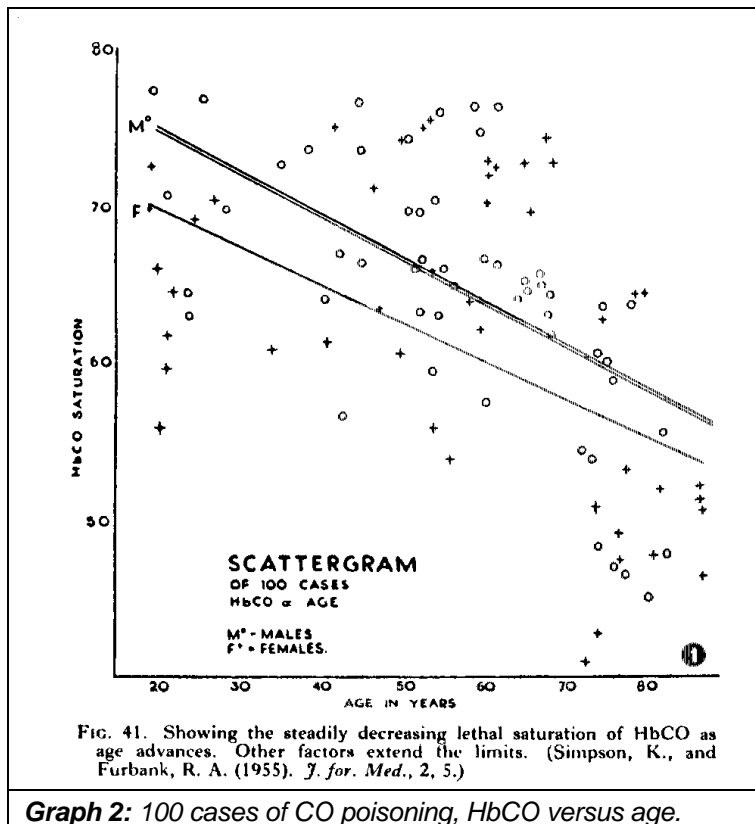

<sup>30</sup> Hb·CO – hemoglobin-carbon monoxide compound, the compound formed by CO and blood hemoglobin, whereby the oxygen (Hb·O<sub>2</sub>, oxyhemoglobin) becomes displaced.

<sup>31</sup> The Soviets used gasoline engines in some of their tanks (models BT, T 28, T 35). Soviet Diesel engines first appeared in 1939 in the T-34 Stalin tank and surprised everyone outside the Soviet Union at the beginning of the German-Soviet war (The heavy tanks KW Ia and KW II had Diesel engines, too). The heavy Diesel engine of the T 34, model “W2”, was a V12 cylinder Diesel (undivided chamber) with 550 hp, 38.86 l cubic capacity and a maximum 1900 rpm; cf. Augustin, *Motortechnische Zeitschrift* 5(4/5) (1943), pp. 130-139; *ibid.*, 5(6/7) (1943), pp. 207-213; *ibid.*, 6(1/2) (1944), p. 40; and H. Scheibert, *Der russische Kampfwagen T-34 und seine Abarten*, Podzun-Pallas Verlag, Friedberg 1988. Diesel engines from submarines are also mentioned: Jochen von Lang, *Eichmann Interrogated*, Farrar, Strauss & Giroux, New York 1983, p. 75 (German ed.: *Das Eichmann-Protokoll*, Severin und Siedler, Berlin 1982, p. 72), mentions a Russian submarine; see also Hannah Arendt, *Eichmann in Jerusalem*, Reclam-Verlag, Leipzig 1990, p. 181, who quotes a statement Eichmann made during the trial. Alleging the use of a large submarine engine in the heart of Poland is ridiculous. Marine engines are invariably far, far heavier than comparable horsepower automotive engines to achieve reliable, continuous, long-term service.

which has an intense odor, must be extremely deadly. The fact is, however, that there is absolutely no relationship between smell and toxicity since the most lethal ingredient by far is CO which is totally odorless. Although Diesel exhaust is not totally harmless, it is one of the least harmful pollutants anywhere except for some possible long-term carcinogenic effects, which are totally irrelevant for any gas chamber for mass murder.

Diesel emissions have until recently been well within the air emission standards of the U.S. Environmental Protection Agency without any modifications or accessories.<sup>32</sup> However, concerns over cancer from Diesel exhaust have made the issue quite complicated in recent years, but those concerns are only for long-term effects. In any event, Diesels have always produced far less than 1%/vol. carbon monoxide, which is still the CO standard for all internal combustion engines. Gasoline engines have only met the same standard after many years of intensive research and the addition of many engine modifications and complex accessories including catalytic converters.

Graph 3 compares carbon monoxide emissions from Diesel and gasoline engines. The latter are also called spark ignition engines because they use spark plugs. Clearly the logical choice between the two types of engines as a source of carbon monoxide would always have been the gasoline engine. From spark ignition or gasoline engines, one can easily get 7%/vol. carbon monoxide – and with maladjustment of the carburetor, as much as 12%/vol carbon monoxide – but from Diesel engines one can never get so much as  $\frac{1}{2}$  %/vol. with liquid fuels, except during overloading.

Carbon monoxide emissions from internal combustion engines are commonly plotted as functions of air/fuel ratio or fuel/air ratio. Fuel/air ratio is merely the reciprocal of air/fuel ratio.<sup>34</sup> It has generally been accepted by the automotive experts that the CO level of Diesel exhaust is related chiefly to these ratios and not to other factors, such as rpm.

An air/fuel ratio of 100:1, for example, means that for every pound of fuel burned, 100 pounds of air are drawn into the engine. However, only about 15 pounds of air can ever react in any way chemically with each pound of fuel regardless of the air/fuel ratio or even the type of engine. This means that at an air/fuel ratio of 100:1, there are always about 85 pounds of air which do not react. These 85 pounds of excess air are blown out of the engine without undergoing any chemical change at all. As far as the excess air is concerned, the Diesel engine is nothing more than an unusual kind of blower or compress-

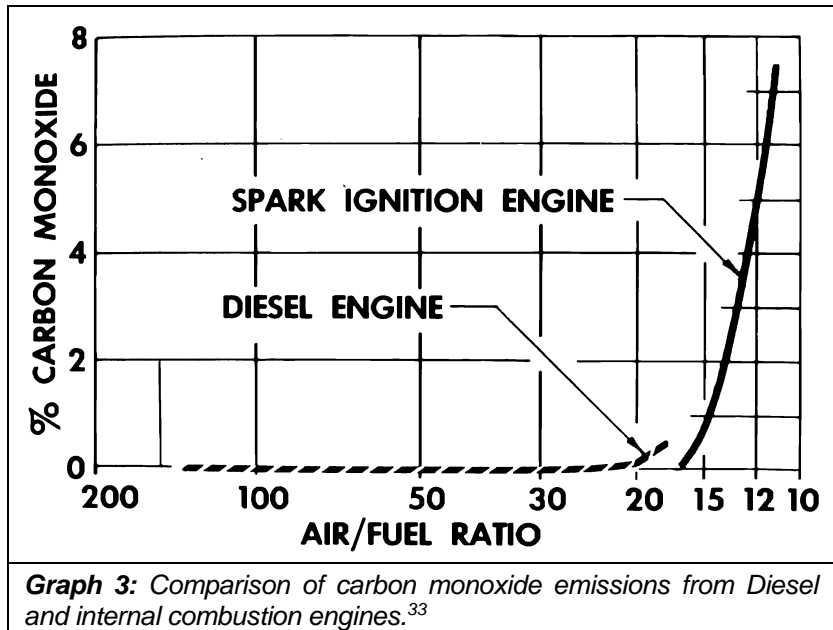

<sup>32</sup> In Germany as well, the emission levels from Diesel engines have always been below the threshold values set by the Federal Emissions Regulation. This is why Diesels were the only kind of engine to be exempt from the mandatory use of catalytic converters until 1994.

<sup>33</sup> David F. Merrion, "Effect of Design Revisions on Two Stroke Cycle Diesel Engine Exhaust", *Society of Automotive Engineers Transactions* 77 (1968), paper 680422, p. 1535.

<sup>34</sup> M. A. Elliott, R. F. Davis, "Composition of Diesel Exhaust Gas", *Society of Automotive Engineers Quarterly Transactions* 4(3) (1950), p. 345. Unfortunately, some of the following graphs use air/fuel, some fuel/air ratios, so we are forced to use them both here. An air/fuel ration of 18:1 equals a fuel/air ration of 0.055 (20:1 = 0.05, 25:1 = 0.04, 33.3:1 = 0.03 ...)

sor. In addition, there are no adjustments that one can make on a Diesel to mistune the engine to change the exhaust emission levels.<sup>35</sup>

Gasoline engines always operate with an air deficit. As a direct result of this deficit, the combustion process in gasoline engines can not possibly go to completion; a significant proportion of carbon monoxide to carbon dioxide will always be formed.

Diesels by contrast always operate with excess air. At idle, Diesels operate with air/fuel ratios as high as 200:1. At full load, the air/fuel ratio is still only down to 18:1. Because of the abundance of air, there is always far greater opportunity for the fuel to burn to completion, thereby producing hardly any carbon monoxide. What little carbon monoxide is produced in the cylinders of a Diesel is subsequently diluted even further by the excess air.

Each cylinder of a Diesel either misfires or fires. If a cylinder misfires, the fuel will simply be blown out as vapor and produce no CO at all. When it does fire, the fuel will always burn to near perfection because of the excess air which is always present. Maladjustment, or faulty injection timing, or defective valves have no significant effect on CO levels for the same reason: the excess air reacts with nearly all of the remaining CO to form carbon dioxide.

As soon as one understands the true differences between Diesel and gasoline engine combustion, the logical choice as a source of carbon monoxide will always be the gasoline engine. The Diesel engine is always an inherently ludicrous choice as a source of carbon monoxide.

## 6.2. Divided Chamber Diesels

There are basically two types of Diesel engines: divided combustion chamber and undivided combustion chamber. The divided chamber category of Diesel engines is generally subdivided into pre-combustion chamber designs and turbulent cell designs.

Graph 4 shows a pair of emission curves for Diesels with divided combustion chambers (Engine A and B).<sup>36</sup> These curves were the result of exceptionally careful tests made in the early 1940s in the United States by the U.S. Bureau of Mines (USBM) to determine whether or not Diesel engines could operate underground without endangering miners.<sup>37</sup> The conclusion of the USBM had been, at least until the 1970's energy crisis, that Diesels could operate underground in non-coal mines subject to USBM approval of the engines. Today, Diesels are also widely used in U.S. coal mines. The earlier exclusion of Diesels from US coal mines had nothing whatever to do with health and safety considerations, but job security for coal miners and the political persuasiveness and eloquence of John L. Lewis, the charismatic president of the miners' union who had insisted: "*no Diesels in UMWA mines.*"<sup>38</sup>

<sup>35</sup> Over the years, a number of exterminationists have falsely speculated that Diesels could simply be adjusted somehow by perhaps turning a screw somewhere or by changing the injection timing to give high CO emission levels. If it were so easy it would be of great concern to auto emission inspectors but it is of no concern at all. The excess air in the cylinders and exhaust drives the combustion process toward near perfection. There is no basis anywhere in the automotive literature for such an exterminationist argument. Let the exterminationists try to find such evidence in the literature or anywhere else. The EPA will be extremely interested.

<sup>36</sup> In the past 50 years the data used for Graphs 4 and 5 have been repeatedly used in the technical literature by numerous engineers. This shows, on the one hand, how reliable the data are that were used for this graph. On the other hand it also underlines the nature of this data as the worst possible emission curves of Diesel engines. Two earlier works which drew on this data are: H. H. Schrenk, L. B. Berger, "*Composition of Diesel Engine Exhaust Gas*", *American Journal of Public Health* 31(7) (1941), p. 674; and Martin A. Elliott, "*Combustion of Diesel Fuels*", *Society of Automotive Engineers Quarterly Transactions* 3(3) (1949), p. 509.

<sup>37</sup> While the experiments involved, and their purpose, were discussed in numerous articles, the paper by J. C. Holtz, "*Safety with mobile Diesel-powered equipment underground*", *Report of Investigations No. 5616*, U.S. Department of the Interior, Bureau of Mines, Washington, D.C., 1960, p. 67, is probably the best; cf. Holtz, R. W. Dalzell, "*Diesel Exhaust Contamination of Tunnel Air*", *ibid.*, 1968.

<sup>38</sup> The earlier exception for coal mines arose not from true health and safety considerations but from the political pressure of the United Mine Workers Union which saw all liquid fuels as a threat to job security. Diesel locomotives had cost the UMWA thousands of jobs. Electrically-driven vehicles and equipment, with lengthy power cables, derived

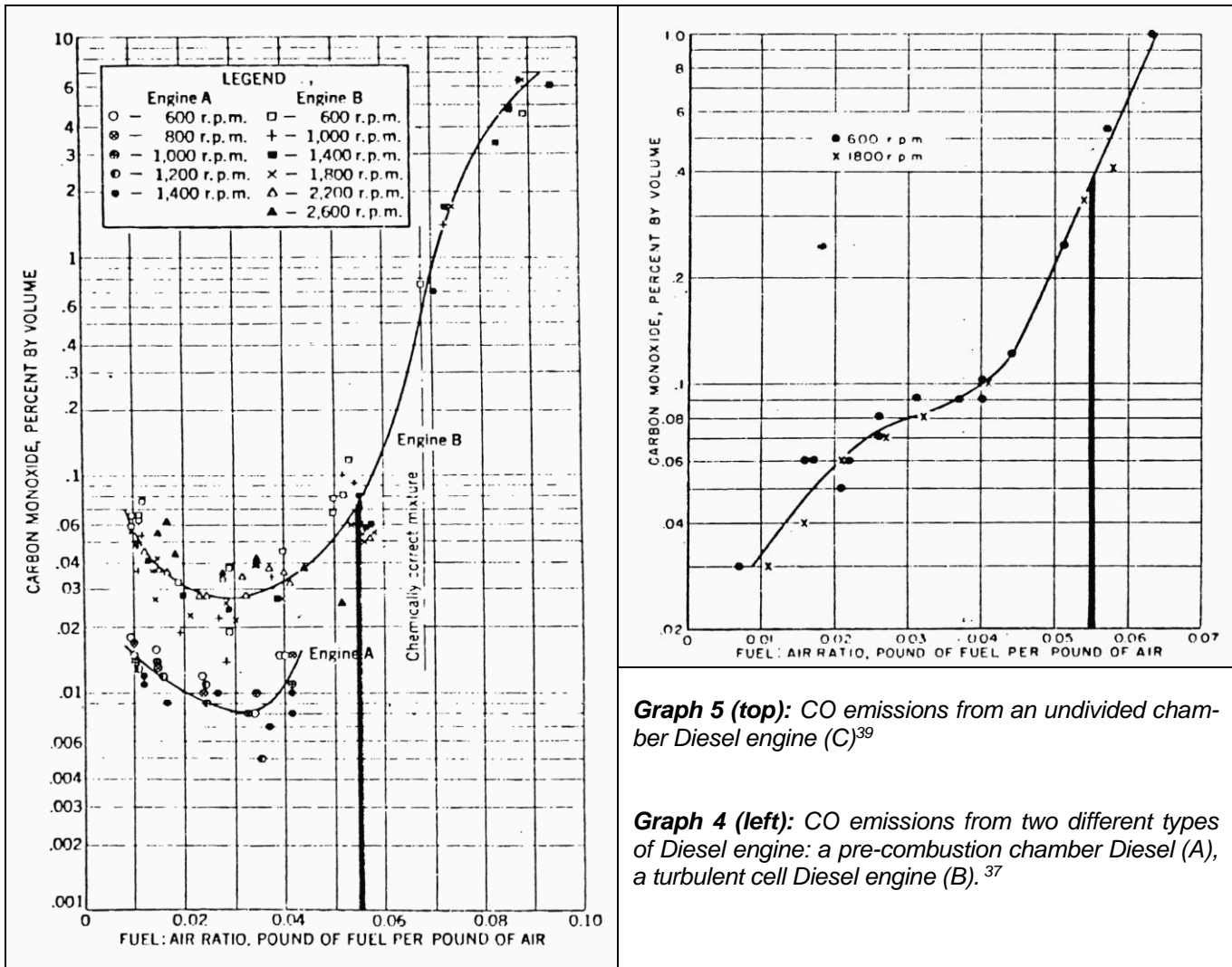

The lower curve in Graph 4 is for a pre-combustion chamber Diesel (Engine A). The upper curve is for a turbulent cell Diesel (Engine B). The lowest fuel/air ratio always corresponds approximately to idle and a 'no-load' condition. At idle, neither of these types of Diesels could produce enough carbon monoxide to even give a headache after half an hour of continuous exposure.

As one starts to impose loads on these engines, and in effect increases the fuel/air ratios, the carbon monoxide levels actually decrease at first. Only as one approaches full load, represented by the solid heavy line in the figure, do the carbon monoxide levels rise significantly to a maximum of 0.1%/vol. at a fuel/air ratio of 0.055. The solid vertical line represents the safe maximum set by engine manufacturers.

### 6.3. Undivided Chamber Diesels

The emission curve in Graph 5 (Engine C) shows that an undivided chamber Diesel still produces only about 0.03%/vol. carbon monoxide at idle, which is not enough to cause a headache in half an hour.<sup>39</sup> However, as increasing loads are imposed on such an engine, the carbon monoxide levels do eventually rise rather sharply. At full load, represented by the heavy vertical line, the carbon monox-

their energy from coal burned in electric power plants and were, therefore, entirely acceptable to the union. S.O. Ogden "The war over Diesels," *Coal Mining & Processing*, June 1978, p. 102.

<sup>39</sup> Data taken from: M. A. Elliott, R. F. Davis, *op. cit.* (note 34), p. 333.

idle level is indeed at about 0.4%/vol. In other words, here we have a Diesel which looks as if it could have been used to commit mass murder in half an hour.

The problem for this engine, and for all Diesels, is that to operate *at full load continuously* for long periods, such as half an hour, one risks fouling and damage from accumulated solids inside the cylinders. If one operates at lower and safer fuel/air ratios than 0.055 (air/fuel ratio 18:1), that is with lower loads, the carbon monoxide emission levels drop very dramatically. For example, at 80% of full load, which is generally regarded as the safe maximum for continuous operation and which occurs at a fuel/air ratio of about 0.045 (air/fuel ratio  $\cong$  22:1), the carbon monoxide level is only 0.13%.

That the emission curves in Graphs 4 and 5 are indeed typical of all Diesel engines over the last sixty years is attested to by the fact that these particular curves have been referred to in countless journals and books on Diesel emissions. In other words, there are no better examples of Diesel emissions. To be sure, there are many other test results in reputable automotive engineering journals such as the *Society of Automotive Engineers Transactions*. But if one takes the trouble to look through the *SAE Transactions* of the last sixty years as well as through other journals, one will not find any examples of worse carbon monoxide emissions than the curve in Graph 5 for engine C. Our analysis of engine C represents the worst case that anyone is likely to find anywhere, for any Diesel engine.<sup>40</sup>

#### 6.4. Fuel/Air Ratios, Load, and the Internal Speed Governor

One might think that all one has to do to get a high fuel/air ratio is to press the fuel pedal to the floor – without any external load being coupled to the engine. What happens then, as the fuel pedal is simply pressed ‘to the metal,’ is that the fuel/air ratio will indeed go to the maximum that the fuel injection stop setting will allow and, because of that, the engine speed will rapidly increase as well. Within a few seconds, the engine speed will approach the maximum safe engine speed set by the manufacturer. Long before that speed is reached, however, an internal speed governor in the fuel injection pump assembly will restrict the fuel supply – and quite severely – to protect the engine by ensuring that the maximum safe engine speed or ‘redline’ speed is never exceeded. The actual fuel/air ratio at ‘high speed idle’ will stabilize after a few seconds, since there is no load, to nearly the exact same low fuel /air ratio as at ‘low speed idle.’ At high speed idle, more fuel will be consumed per second, but because more air is also being drawn into the engine, the fuel/air ratio will remain nearly the same as at low speed idle. In other words, pushing ‘to the metal’ without an external load will not raise the fuel/air ratio, except initially.

To actually maintain a high fuel/air ratio for more than just a few seconds, either of two methods, or a combination thereof, is essential. One method involves coupling a load, such as a pump, fan, or generator to the engine to hold the engine speed safely below the ‘redline’ speed. Another method is by ‘choking,’ which means restricting the air supply to the engine.

As a practical matter, coupling an external load to an engine in a typical truck or tank is far from easy. Nothing like it is even remotely suggested in any of the anecdotes or documents anywhere in the Holocaust literature. This method will be investigated more closely in section 8.1.

Reducing the air intake, however, is quite easy, but experiments have shown that this method still does not meet the necessary requirements, see section 8.2.

### 7. Toxicology of Diesel Exhaust

#### 7.1. Effect of Reduced Oxygen Content

Is it possible that the Jews died from reduced oxygen in the Diesel exhaust? Such a theory would at least be consistent with the claim that the corpses were “blue.” A bluish coloring to certain parts of a corpse is indeed a symptom of death from lack of oxygen. Normal air contains 21%/vol. oxygen. In Graph 6 we see that the oxygen concentration corresponding to idle in the exhaust of any Diesel en-

<sup>40</sup> D. Pankow, *Toxikologie des Kohlenmonoxids*, VEB Verlag Volk und Gesundheit, Berlin (East) 1981, p. 24, also states that Diesel engines under full load do not produce more than 0.4% CO by volume.



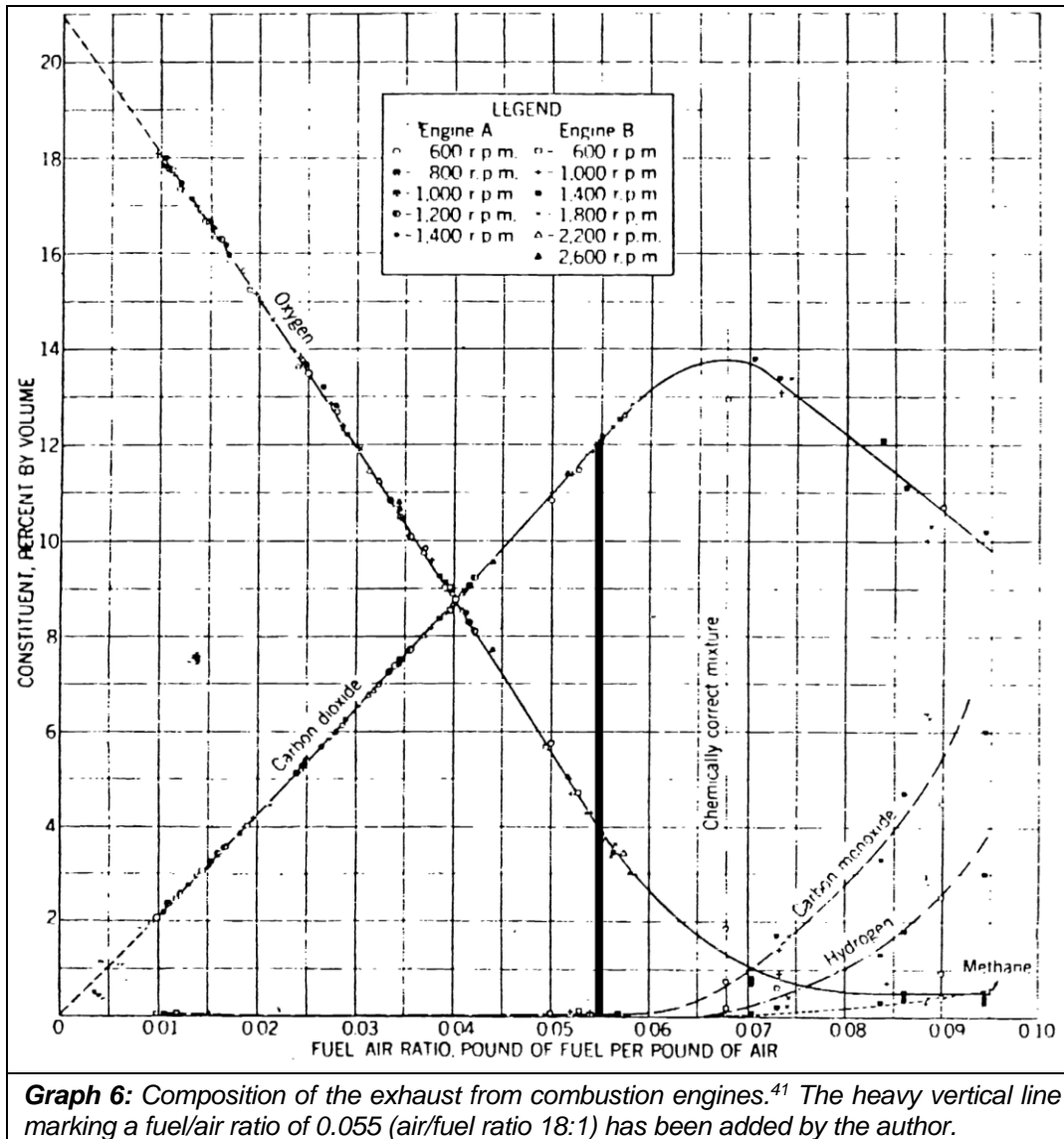

gine (divided or undivided chamber), shown at the right in the graph at an air/fuel ratio of 100:1 (fuel/air ratio 0.01), is 18% which is just a few percent less than one finds in normal air.<sup>41</sup> At full load (fuel/air ratio 0.055), the oxygen concentration in the exhaust of any Diesel engine is approximately 4%.

Probably the best discussion of the effects of reduced oxygen levels, or asphyxia, is provided by Henderson and Haggard, according to whom an oxygen content of less than 10%/vol. causes loss of consciousness, and an oxygen content of less than 6%/vol. is fatal.<sup>42</sup> According to Haldane and Priestley, "air containing less than 9.5 per cent of oxygen would ordinarily cause disablement within half an hour."<sup>43</sup> But disablement is still not death!

Clearly, there is no magic number below which death would automatically occur, or above which life would necessarily continue. However, for any gas chamber relying upon reduced oxygen as the killing method, one would have to reduce the oxygen to below 9.5%/vol. and perhaps even below 6%/vol.

<sup>41</sup> Edward F. Obert, *Internal Combustion Engines and Air Pollution*, Intext Educational Publishers, New York 1973, p. 361.

<sup>42</sup> Y. Henderson, H. W. Haggard, *op. cit.* (note 42), pp. 144-145.

<sup>43</sup> J. S. Haldane, J. G. Priestley, *Respiration*, Yale UP, New Haven 1935, pp. 223-224.

Load range	Fuel/Air (Air/Fuel) Ratio	O <sub>2</sub> Content [%/vol.]	CO <sub>max</sub> Content [%/vol.]	F <sub>O<sub>2</sub></sub>	CO <sub>eff</sub> [%/vol.] at 21%/vol. O <sub>2</sub>
Full load	0.055 (18:1)	4.0	0.400	5.25	2.100
	0.05 (20:1)	6.0	0.220	3.50	0.770
Heavy load	0.04 (25:1)	8.8	0.090	2.40	0.220
	0.03 (30:1)	10.8	0.080	1.94	0.160
Partial load	0.029 (35:1)	12.0	0.075	1.75	0.130
	0.025 (40:1)	13.5	0.070	1.55	0.110
Light load	0.016 (60:1)	16.0	0.050	1.31	0.066
Idle	0.01 (100:1)	18.0	0.060	1.17	0.070

From Graph 6 we see that to reduce the oxygen concentration in the exhaust to just 9%, any Diesel would have to operate at a fuel/air ratio of about 0.04, which corresponds to roughly  $\frac{3}{4}$  of full load. To reduce the oxygen concentration to as low as 6%, a Diesel would have to operate at close to full load. In other words, any Diesel gas chamber relying on the reduction of oxygen as a killing method would have to operate at more than  $\frac{3}{4}$  of full load.<sup>44</sup>

From the above it is evident that over most of their operating ranges, Diesels discharge sufficient oxygen so that one can literally inhale pure Diesel exhaust and survive. The smell will be brutally unpleasant, but not harmful. From idle to at least  $\frac{3}{4}$  of full load, Diesel exhaust contains sufficient oxygen to sustain human life for at least half an hour.

## 7.2. Combined Effects of Carbon Monoxide and Reduced Oxygen

Table 4 shows carbon monoxide levels for various load ranges of the Diesel with the worst emission values, *i.e.*, Engine C from Graph 5. When dividing the actual O<sub>2</sub> content in the exhaust by the normal oxygen content in air (21%), one gets a factor F<sub>O<sub>2</sub></sub>. One can then multiply the actual CO content by this factor to determine the toxicologically effective CO content (see section 5). Table 4 shows us that the desired, high effective CO content that *guarantees the death of all the victims* within half an hour (0.4 to 0.8%) can only be attained near full load.<sup>46</sup>

## 7.3. Carbon Dioxide

If Jews were not killed with carbon monoxide or from a lack of oxygen, could they have died instead from the effects of carbon dioxide? Carbon dioxide is no more poisonous than ordinary water. Most toxicology handbooks do not even mention it. When mentioned at all, it is generally classified as a “*non-toxic, simple asphyxiant.*” There are, however, occasional accidental fatalities where carbon dioxide is directly involved. Death in almost all such cases is caused by a lack of oxygen. The lack of oxygen arises from the fact that the carbon dioxide is much heavier than oxygen and will, especially in an enclosed space, displace oxygen in the same way that water will displace air in the lungs of a drowning man. The actual cause of death in either situation is not the carbon dioxide or the water, but rather the lack of oxygen in the blood (suffocation). One symptom of this kind of death is a bluish appearance of the skin.

<sup>44</sup> Note: The composition of exhaust gasses is almost independent from the rpm’s of the engine. The rpm’s simply determine how *much* gas is produced. If the rpm’s are lower, for the same fuel/air ratio the whole process will take longer.

<sup>45</sup> Based on the data from Graphs 4 and 5.

<sup>46</sup> One objection to my 1984 essay was that I had not properly considered the combined effects of carbon monoxide and reduced oxygen. If one determines an “*effective carbon monoxide level,*” as explained in this text, one will see that there is no significant increase in toxicity for half-hour exposures due to reduced oxygen until one gets the engine running under heavy loads which is exactly what I claimed in 1984.

Carbon dioxide can be beneficial and therapeutic.<sup>47</sup> It is commonly used in clinical medicine as a harmless stimulant for respiration. For this purpose it is supplied under pressure in cylinders (Carbogen) containing oxygen and 7%/vol. carbon dioxide.<sup>48</sup> Normally, when a person exhales, the air leaving the lungs contains about 5.5%/vol. carbon dioxide.

Levels of 3%/vol. carbon dioxide are quite tolerable for exposures lasting several days. For example, in the 1950s the U.S. Navy experimented with gas mixtures containing 3%/vol. carbon dioxide and 15%/vol. oxygen (25% less oxygen than in normal air), for use in American submarines with exposures lasting up to several weeks.<sup>49</sup>

For Diesel engines, the carbon dioxide level at or near idle is only about 2%/vol. and gradually increases to about 12%/vol. at full load as shown in Graph 6 (page 448). A carbon dioxide level of 12%/vol. may cause cardiac irregularity and may, therefore, be dangerous for people with weak hearts.<sup>50</sup> In contrast to Diesels, gasoline engines produce 12%/vol. already at idle. In general, if enough oxygen is available, a carbon dioxide level even as high as 12%/vol. is not likely to cause death. It is generally accepted that only carbon dioxide concentrations greater than 20 to 30%/vol. are dangerous.<sup>51</sup> However, when the carbon dioxide level is as high as 12%/vol. in Diesel exhaust, the corresponding oxygen level is dangerously low.

The principal danger to life from Diesel exhaust arises not from any secondary components, but strictly from the combined effects of CO and reduced oxygen.

#### 7.4. Aldehydes, Sulfur Dioxide, Nitrous Oxides and Hydrocarbons

Other pollutants in Diesel exhaust, besides carbon monoxide, are primarily aldehydes (OCHR), sulfur dioxide (SO<sub>2</sub>), nitrous oxides (NO<sub>x</sub>, max. 0.1%), and hydrocarbons (C<sub>x</sub>H<sub>y</sub>). The smell or stench for which Diesel engines are notorious is caused by trace amounts of certain hydrocarbons and aldehydes which the most modern analytical instruments can barely identify, let alone measure. The sensitivity of the human nose to these compounds is, however, extremely high and out of all proportion to the actual quantities present. Some of the hydrocarbons are considered carcinogenic and thus represent a potential long-term hazard, but they are irrelevant to our study.

The sulfur dioxide content of the exhaust, which can be fairly high for sulfurous fuels, causes irritation of the respiratory tract, but these irritations cannot become critical within the time frame at issue here.

Nitrogen dioxide (NO<sub>2</sub>), if present in high concentrations, can cause edema of the lungs after half an hour's exposure. However, even the worst edema will not kill in half-an-hour, but only after a delay of about 24 hours.<sup>52</sup> One-time, brief exposure to lower concentrations of NO<sub>2</sub> merely irritate the lungs and mucous membranes, as do any sulfur oxides potentially present, so that we need not consider them further. Nitrogen monoxide (NO), on the other hand, has physiological effects similar to CO.<sup>53</sup> Unlike CO, however, its concentrations decrease with decreasing oxygen concentrations in the combustion process, *i.e.*, with higher load, and do not attain any levels critical to health.<sup>54</sup> Furthermore,

<sup>47</sup> L.J. Meduna, *Carbon Dioxide Therapy*, C. C. Thomas, Springfield 1958, pp. 3-19.

<sup>48</sup> J.D.P. Graham, *The Diagnosis and Treatment of Acute Poisoning*, Oxford UP, London 1962, pp. 215-217.

<sup>49</sup> L.T. Fairhall, *Industrial Toxicology*, Williams & Wilkins, Baltimore 1957, p. 180.

<sup>50</sup> M. Daunderer, *Klinische Toxikologie*, 32<sup>nd</sup> supplement 21/87, ecomed, Landsberg 1987, p. 1.

<sup>51</sup> J.M. Arena, *Poisoning: Toxicology – Symptoms – Treatments*, C. C. Thomas, Springfield 1979, p. 243; J.D.P. Graham, *op. cit.* (note 48), p. 216.

<sup>52</sup> W. Forth *et al.*, *op. cit.* (note 22), pp. 760ff.; M. Daunderer, *Klinische Toxikologie*, 33<sup>rd</sup> supplement 1/88, ecomed, Landsberg 1988, pp. 1ff.

<sup>53</sup> W. Forth *et al.*, *op. cit.* (note 22), pp. 761, 765; M. Daunderer, *Klinische Toxikologie*, 34<sup>th</sup> supplement 2/88, ecomed, Landsberg 1988, pp. 1ff.

<sup>54</sup> Cf. R.E. Pattle, H. Stretch, F. Burgess, K. Sinclair, J.A.G. Edginton, *Brit. J. industr. Med.* 14 (1957) pp. 47-55, here p. 50. This study was brought to the author's attention by Charles D. Provan an independent researcher who still believes in Nazi gassings. I referred to this possibility and to this source in 1994 for the first time: F.P. Berg, "Die Diesel-Gaskammern: Mythos im Mythos", in Ernst Gauss (ed.), *Grundlagen zur Zeitgeschichte*, Grabert, Tübingen 1994, pp. 321-345.

NO converts rapidly to NO<sub>2</sub>,<sup>55</sup> so that the NO concentration enhances the effects of the CO in the exhaust only imperceptibly.

The peroxide (ozone) forming effects of nitrous oxides near ground level as well as the carcinogenic components of Diesel exhaust are the reason Diesel engines have recently also been subjected to special emission guidelines. They supposedly pose a danger to human respiration. This is why the studies conducted in Germany of health hazards posed by Diesel exhaust were almost entirely confined to analyses of the proportions of smoke solids and non-combusted hydrocarbons.<sup>57</sup>

## 7.5. Diesel Smoke

Diesels tend to smoke, especially under heavy load. This is not due to any inherent inefficiency of Diesels. On the contrary, Diesels are extremely efficient. The smoke is the result of the nature of Diesel combustion and the heavier fuels which Diesels use compared to gasoline engines.

The solid heavy lines in Graphs 4-7 represent the smoke limit that manufacturers have found necessary to protect their engines from excessive wear. As a practical matter, a Diesel cannot operate to the right of the vertical lines in Graphs 4 and 5 (fuel/air ratio of 0.055 = air/fuel ratio of 18:1) with liquid fuels because the internal accumulations of smoke solids would destroy the engine within a short time and would stall the engine.<sup>58</sup> Many manufacturers are more conservative and limit their engines to fuel/air ratios below 0.050.

Diesel engines can operate safely at fuel/air ratios above 0.055 (air/fuel ratios below 18:1) only if they are burning a clean, gaseous fuel. This is the only way to avoid the buildup of solid material within the cylinders. The data shown to the right of the vertical line were only gathered because the researchers at the USBM chose to test their engines for theoretical reasons with gaseous fuel far beyond the normal (manufacturer recommended), full load settings of the respective engines.<sup>59</sup> The data for clean, gaseous fuel is irrelevant to our analysis because if the Germans had had a gaseous fuel for the Diesel engines – for example, pure CO – they could have sent that gas directly to the gas chamber. Using a Diesel engine as some kind of intermediate step would have made no sense; it could only have made the gas far less toxic. Since carbon monoxide is highly combustible and because of the excess air, practically all of the carbon monoxide going into the Diesel would have been consumed.

Diesel smoke contains a liquid phase and a solid phase. The liquid phase generally gets blown out of the engine with the exhaust and, therefore, can do no harm to an engine. But if enough solid material is also produced, and rapidly enough, some of that material will accumulate in the cylinders where, in just a few minutes, it can severely damage piston rings and valves and even cause an en-

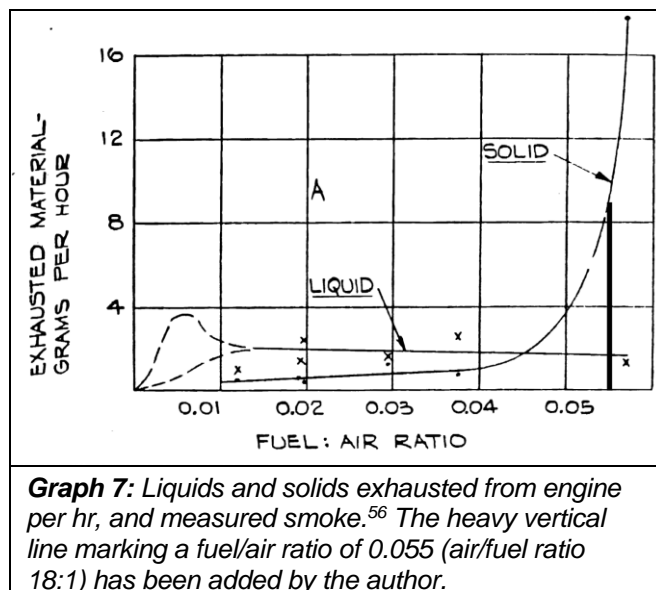

<sup>55</sup> J. Falbe, M. Regitz (eds.), *Römpp Chemie Lexikon*, v. 5, Thieme, Stuttgart 1992, pp. 4314f.

<sup>56</sup> M. A. Elliott, R. F. Davis, *op. cit.* (note 39), p. 345.

<sup>57</sup> R. Kühn, K. Birett, *Merkblätter Gefährlicher Arbeitsstoffe*, 69th supplement 11/93, Technische Regeln für Gefahrstoffe (TRGS) 554: "Dieselmotoremissionen", ecomed, Landsberg 1993; *ibid.*, 61st supplement 9/92, TRGS 102, Technische Richtkonzentrationen (TRK) für gefährliche Stoffe, pp. 93ff.; L. Roth, M. Dauderer, *Giftliste*, 23rd supplement 2/86, TRGS 102, ecomed, Landsberg 1986, pp. 51ff.

<sup>58</sup> Cf. the experiment by R. E. Pattle *et al.*, *op. cit.* (note 54).

<sup>59</sup> It is interesting to note that some people cite this data as proof that it is possible to attain high CO-levels with Diesel engines: cf. Martin Pägert, ([www.eikon.e-technik.tu-muenchen.de/~rwulf/leuchter/leucht19.html](http://www.eikon.e-technik.tu-muenchen.de/~rwulf/leuchter/leucht19.html)). What is not mentioned, however, is that this is possible only with special, gaseous fuels, not with Diesel fuel.

gine to simply self-destruct and stop. The amount of solids produced by Diesel engines increases dramatically just above a fuel/air ratio of 0.055. For this reason, manufacturers as a rule equip the fuel injection pumps with stops so that the engines can only operate below 0.055, or even 0.050.

Operating any Diesel engine near the maximum load recommended, regardless of the particular design or engine type, would have produced significant amounts of smoke. Smoke is generally also noticeable immediately after start-up, even at idle or under light load, when the engine has not yet had time to reach its normal operating temperature.

Pattle *et al.* found that an engine running at less than half load and producing 0.22%/vol. CO also produces extremely pungent, tear-inducing smoke which, if piped into a gas chamber, would reduce visibility to a mere foot or so.<sup>58</sup>

It should surprise no one that there is no mention of smoke from the Diesel – black, white, dense or otherwise – anywhere in the Gerstein statement or in any of the postwar trial testimony. Can one really believe Jews locked in gas chambers would have patiently withstood such torture?

## 7.6. Noise, Vibration, Stench

The stench of Diesel exhaust is familiar to anyone who has ever driven a car behind a truck or bus anywhere in the world. That stench is, in effect, a powerful ‘warning ingredient’ to the presence of a Diesel engine – at least until recent years when the addition of catalytic converters and other equipment reduced the stench substantially. Ironically, it was the removal of a warning ingredient in Zyklon B in 1944 which some holocaust believers have often cited as ‘proof’ of a fiendish National Socialist desire to deceive intended victims. With Diesel exhaust, a technology to remove its warning ingredient simply did not exist until many years later – and yet, the National Socialists still supposedly used Diesels for mass murder instead of, for example, gasoline engines which have no such warning ingredient. In other words, the arguments about ‘warning ingredients’ in connection with the ‘Holocaust’ are at least as nonsensical as everything else.

But in addition to smoke and smell, Diesel engines are notorious also for their intense noise and vibration. One might even say that the noise and vibration are additional ‘warning ingredients.’ Because of their higher compression ratios, lower rpm’s, and the explosive type of combustion, the amount of vibration that Diesels produce is substantially greater than that of any comparably-sized gasoline engine. The noise and vibration are among the major reasons why Diesels have not generally been used in automobiles. They are just too noisy for many people to bear.

If the 550 hp, V-12 cylinder Diesel from a typical Soviet T-34 tank had been mounted on the floor of a small building and run for half an hour at more than  $\frac{3}{4}$  of full load (at more than 375 hp), the noise and vibration would have been at least as noteworthy and as wildly spectacular as the wailing of any Jews – and yet, there is no mention of any such noise or vibration in the Gerstein Statement, or in any of the post-war trial testimony.

## 7.7. Diesels for Underground Mining – a Brief History

Since tests with lethal emissions on humans are not possible, accidental human deaths have always been an invaluable, alternative source of information for toxicologists. Parts of underground mines can often become totally enclosed just like gas chambers from the inevitable accidents, especially roof failures, which often occur there. Gasoline engines have generally been outlawed for underground applications because of their notorious, toxic exhaust, but the history of Diesels underground is quite different.

Diesel engines were first used underground in coal mines in 1928 in Germany, in the Saar region, and quite safely from all this author has seen in the excellent German literature on this subject, especially in the German mining journal *Glückauf*.<sup>60</sup> In Britain, Diesels were first used underground in

---

<sup>60</sup> H.H. Müller-Neuglück, H. Werkmeister, “*Grubensicherheit der Diesellokomotiven*”, *Glückauf*, Aug. 23, 1930, p. 1145.

Yorkshire in 1939, more than ten years later, but in the following decades, thousands more were used throughout Britain.

For the mining industry, where heavy machinery is used in the most difficult and unnatural circumstances imaginable and where the industrial accident rate has always been among the highest anywhere, one might expect many fatal accidents. The British safety record with Diesels, however, was a stunning surprise to many mining professionals, especially in the USA, where Diesels were not permitted for underground coal mines until the 1970's. The British safety record was spelled out in June of 1974 when S. Gilbert of the British National Coal Board wrote the following in a major British mining journal about their experience going back 35 years to 1939:<sup>61</sup>

*“Although it is accepted that there are potential hazards arising from the emission of noxious gases in the exhaust gases of Diesel engines, the degree to which these are controlled in British coal mines has proved to be very effective.. An examination of ALL safety records has revealed that no person has suffered any harmful effects either temporarily or permanently as a direct result of breathing any toxic gas emitted from any vehicle powered by a Diesel engine.”*

Another quote from the technical literature summarizes much of what can be found there. The following is from an American essay by Dennis S. Lachtman, Director for Health Engineering for the EIMCO Mining Machinery company in a section subtitled: *“NO significant human hazard seen in over 20 studies.”*<sup>62</sup>

*“A number of studies evaluating human response to exposure of Diesel have included experience among Diesel bus workers, Diesel railroad workers, and metal and non-metal miners working with Diesel production equipment and underground. There are more than 20 human health studies involving working populations exposed to Diesel exhaust emissions. As can be seen from a careful review of these studies, NO SIGNIFICANT health hazards have been associated with exposures to Diesel exhaust emissions.”*

*More recently, the National Institute for Occupational Safety and Health (NIOSH) has reported on epidemiological studies it has performed in underground mines. One of these studies included an MSHA<sup>63</sup> and NIOSH joint study of the relationship between the underground environments in 22 metal and non-metal mines looking at the health of more than 5000 miners. This comprehensive study focuses on the health effects of both silica dust and other substances including those found in Diesel exhaust. [...] The researchers reported that the data showed an ABSENCE of harmful effects from Diesel exhaust.”*

There was not even one injury from Diesel exhaust. No doubt, there must be some occasional deaths somewhere in the world, but they are certainly few and far between. This does not prove that Diesels cannot be used to commit mass murder, but it is all the more reason to believe that murder with Diesel exhaust is far from easy. The only evidence of Diesels having ever been used anywhere, anytime for murder in all of human history is within the ‘Holocaust’ claims and there the best evidence by far is the Gerstein statement.

The fact that the general non-toxicity of Diesel exhaust was rather well known in the pre-WW2 German mining industry and the fact that Kurt Gerstein had been trained as a mine surveyor with, no doubt, some practical experience in German mines suggest that his obviously concocted ‘statement’ near the end of the war may have been deliberately constructed around Diesel exhaust so that what would seem at first glance to be a highly incriminating eyewitness account would eventually, long after the war, be recognized as worthless.<sup>64</sup>

Every year, thousands of deaths occur worldwide due to carbon monoxide poisoning from gasoline engines. Suicides in cars from gasoline engine exhaust are common also and are well documented in public health reports. The most common deaths from carbon monoxide occur, however,

<sup>61</sup> S. Gilbert, “The Use of Diesel Engines Underground in British Coal Mines”, *The Mining Engineer* (GB), June 1974, p. 403.

<sup>62</sup> Dennis S. Lachtman, “Diesel Exhaust – Health Effects”, *Mining Congress Journal*, January 1981, p. 40.

<sup>63</sup> Mine Safety & Health Administration.

<sup>64</sup> Other obvious falsehoods within his ‘statement’ may have been intended to serve the same purpose. He may have simply wanted a cover story to save himself without providing any long term comfort to Germany’s enemies. His own role in the SS with the application of Zyklon B, albeit for life saving work, would have given him additional reason to be fearful about his own future.

when people simply park their vehicles and run their car or truck engines to keep warm in winter – or cool in summer – by means of an automotive air conditioner. Approximately one thousand accidental deaths still occur in this way every year in the US alone, even though American cars are routinely equipped today with catalytic converters and emission controls. But there are no known deaths in cars or trucks with Diesel engines! Every night across the world, tens of thousands of truck drivers sleep in their truck cabs with the Diesel engines running throughout the night – to keep warm in winter or cool in summer. Although there are always some exhaust leaks into the van compartment of a truck, there is no evidence of even one trucker dying, or being injured, in such circumstances. It never happens. There are no known Diesel suicides either. Diesel exhaust is inherently safe.

## 7.8. An Expert Opinion from Israel

A major engineering textbook from 1998, which should contain just about everything one needs to know about Diesel emissions, is entitled: *Handbook of Air Pollution from Internal Combustion Engines* with the subtitle *Pollutant Formation and Control*. The book is co-authored by a dozen of the world's leading experts on automotive emissions. It should be an excellent source of information on precisely how one might kill people with Diesel exhaust. But in the entire 550 page book, which is rather typical of all other books one can find on this subject, there was only one sentence relevant to our subject.<sup>65</sup>

*“Although carbon monoxide (CO) emissions are regulated, they will not be considered here, as the Diesel engine combustion process by definition inhibits the production of CO.”*

In other words, the toxic effects from carbon monoxide in Diesel exhaust, including long-term effects, were just not worth bothering with as a pollutant of any kind. What is ironic is that the editor is an Israeli professor of engineering in the Department of Mechanical Engineering at Ben-Gurion University. His name is Eran Sher. Someone should reach out to him and ask if he believes the National Socialists murdered people with Diesel exhaust and whether he had ever considered testifying as an expert in the trial of John Demjanjuk.<sup>66</sup> On whose side would he have testified?

Surely, if Eran Sher and the Israelis really believe it happened in National Socialist Germany, then it might happen again. Surely, we should be concerned that Arab leaders may use their tens of thousands of Diesel trucks to perpetrate another ‘Holocaust.’ Surely, the United Nations arms inspectors who are searching for weapons of mass destruction in the Middle East will miss the boat if they fail to investigate Arab Diesels.

## 8. Diesel Gas Chamber Operation

### 8.1. Imposing an Engine Load

To impose a substantial load on any engine is far from easy. For example, if one has an ordinary truck, a full load can be imposed on the engine by first filling the truck with a heavy cargo and then racing the vehicle up a steep hill with the fuel pedal to the floor. Under that condition, one would probably be putting out about 0.4%/vol. CO, which is indeed lethal, from the exhaust pipe of an undivided chamber Diesel. However, if the truck is simply parked in a driveway, it is practically impossible to impose any significant load on the engine. Merely ‘racing’ the engine with the transmission in neutral will impose no more than a few percent of load. Letting the clutch slip and stepping on the accelerator may impose a somewhat greater load on the engine – but the clutch will rapidly burn out.

---

<sup>65</sup> Eran Sher (ed.), *Handbook of Air Pollution from Internal Combustion Engines: Pollution Formation and Control*, Boston, San Diego, New York, London, Sydney, Tokyo, Toronto: Academic Press, 1998, p. 288.

<sup>66</sup> See for this Arnulf Neumaier, “*The Treblinka Holocaust*”, this volume; cf. also Yoram Sheftel, *The Demjanjuk Affair. The Rise and Fall of the Show Trial*, Victor Gollancz, London 1994.

Jacking up the rear end of the vehicle and applying the brakes while racing the engine will impose a somewhat greater load, but the brake linings will rapidly burn out.<sup>67</sup>

The only way to realistically impose a significant load on any engine is by coupling to the engine some kind of brake dynamometer or other load, such as a generator with an electrical load, a fan, pump, or the like.

Brake dynamometers were available, but, although the Germans must have had many in engineering testing laboratories, they are not readily available. They are not the kind of equipment that one finds in auto repair shops even today. They cost far more than the engines to which they are attached, since they are not mass-produced – at least not at that time.

An electric generator arrangement seems possible, since Treblinka and Belzec would have needed electricity, even if only to keep the barbed wire charged and the lights burning, and also because in those days the rural areas of these camps in eastern Poland may not have been connected to a public power grid. However, such an arrangement suggests a continuous operation of both the generator and the Diesel engine, which is contrary to the Gerstein Statement. According to that statement, the engine had to be started just for the gassing. There is nothing in the statement to even remotely suggest that the engine served any other purpose than to kill Jews. If it had had a dual purpose, for example to also drive an electric generator, one would expect some comment about the lights going on as the gassings began, but there is nothing of the sort. In fact, according to the Gerstein statement, Pfannenstiel had “*his eyes glued to the window in the wooden door*” before the Diesel even started which strongly suggests that the “*electric light which illuminated the interior of the room*” must have been on before any gassing even started. In other words, there must have been electricity from a power source other than the alleged Diesel gassing engine.

Postwar ‘eyewitnesses’ for Treblinka related trials actually claimed that the same building where the ‘gassing Diesel’ was housed also contained a second engine which operated independently of the first and which supplied electrical power to the camp.<sup>68</sup> In other words, these accounts specifically show this generator *not* to be related to those engines that allegedly produced poison gas, just as accounts of the poison gas engines never suggest any other, continuous use of those engines. On the contrary: accounts describing events as the engine was supposedly being started are amazingly similar. The command given to the engine operator to start the engine – “*Ivan, water!*” (Treblinka) – or similar events for Belzec (“*Heckenholt Foundation*”) appear not just in the Gerstein Statement, but run like a central theme throughout of the eyewitness literature.

From documents of the Central Construction Office of Auschwitz (*Zentralbauleitung*), we know that the SS provided this camp with emergency power equipment consisting of German Diesel engines rated at 440 hp and electric generators rated at 250 kW.<sup>69</sup> Witnesses stated explicitly that the power facilities were constantly running under some load in Treblinka due to the lack of a connection to a public network and that these engines operated *in addition to* the gassing engines which operated only sporadically. Something is obviously wrong with these ‘eyewitness’ stories. Anyone with any expertise would have used the exhaust of the engine driving the generator which was already operating under load, instead of an additional engine for gassing purposes without any load. Besides, the ex-

<sup>67</sup> When testing the emissions of Diesel engines, German engineers sometimes impose load on the engine without coupling any equipment by simply opposing the inertia of the engine. Accelerating an engine with the fuel pedal depressed and with no load increases the engine speed rapidly and the fuel/air ratio as well, but only for a few seconds. This may suffice to measure the engine’s exhaust composition at high fuel/air ratios, but if the cylinder wall temperatures are still unusually low, this may give erroneous test result.

<sup>68</sup> E. Fuchs, in E. Kogon et al. (eds.), *op. cit.* (note 25), p. 163: “[...] *I set up a light machine in the extermination camp there, so that the barracks can be lit electrically [...]*”; E. Roosevelt, A. Einstein et al. (eds.), *The Black Book of Polish Jewry*, Roy Publishers, New York 1943, pp. 142ff.: murder by means of steam, Diesel engines for supplying power. Cf. also A. Donat (ed.), *The Death Camp Treblinka*, Holocaust Library, New York 1979, p. 157, as well as the verdict of the Düsseldorf District Court in the Treblinka Trial, Ref. 8 I Ks 2/64, p. 300; Y. Arad, *op. cit.* (note 17), p. 42.

<sup>69</sup> *Kostenüberschlag über Notstromaggregate für K.G.L.*, Central Construction Office of the Waffen-SS and Police of Auschwitz, O./S., Oct. 26, 1942.



haust from the engine driving the generator was already there and available (where else would the exhaust go except into the sky). To start an extra Diesel with or without some specially-arranged load is ridiculous.

## 8.2. An Inhalation Study on Living Animals – Combining all Possible Effects

Arguably, the analysis of CO and reduced oxygen has until now been highly theoretical – and yet, it has still not included possible combinations of effects with all other ingredients in Diesel exhaust. A theoretical analysis of all such combinations of effects is beyond analysis. Happily, there is a detailed study of the actual effects of full strength Diesel exhaust on living animals. It appeared in the *British Journal of industrial Medicine* in 1957.<sup>58</sup> To my knowledge, this is the only study of this type ever undertaken and is the most important single piece of evidence for the analysis of Diesel toxicity anywhere.

Eight experiments were performed with undiluted exhaust from a small Diesel engine<sup>70</sup> under four different operating conditions – two essentially identical experiments for each operating condition. Each experiment was performed on four rabbits, ten guinea-pigs, and forty mice. The animals were only introduced into the chamber after the Diesel exhaust concentrations had had approximately half-an-hour to stabilize and purge the chamber of all other air.

In the two tests under “low” load (Condition A: no external load, only accessories such as the cooling fan), which was essentially an “idle” condition, there were no fatalities among any of the test animals even after five hours of continuous exposure. But even under Conditions B and C where the engine was under heavy load (with “a large fan and two hydraulic pumps to provide the load”), the survival rate was as follows:

1. All rabbits survived the five hour exposure and even continued to live for a week thereafter.
2. Of the guinea-pigs, only one died during the actual five-hour exposure period, although most died over the next seven days.
3. Of the mice, only a minority died during the five hour exposure and most even survived through the following week.

Under Condition D, which was by far the most extreme test with a severely restricted air intake,<sup>71</sup> a maximum CO level of 0.22%/vol. was produced with an oxygen concentration of 11.4%/vol. Although many, but not all, of the mice died within an hour, all of the rabbits and guinea-pigs survived for more than one hour of continuous exposure.<sup>72</sup>

For exposures only as long as Gerstein alleged (32 minutes), the survival rates would have certainly been even better. In other words, on the basis of tests on living animals with full-strength Diesel exhaust, Gerstein’s gas chamber would have been a complete fiasco.

---

<sup>70</sup> Engine size certainly determines the total amounts of pollutants, toxic or otherwise that an engine will produce, but it has no bearing on the concentrations of those pollutants in the exhaust. It is the concentrations which are the critical consideration and not the total amounts of pollutants once levels have stabilized inside the gas chamber. A large engine will fill a potential gas chamber quicker than a small engine, but that is all. Concentrations within the chamber will never exceed the levels measured directly in the engine’s exhaust.

<sup>71</sup> Diesel engines have never used carburetors (all gasoline engines did until recently), and hence no idle-mixture adjustment screws which were always part of the carburetors and allowed fuel/air ratios to be easily maladjusted. For this reason, Pattle *et al.* (note 54) went to the round-about-method of ‘choking’ rather than purchasing a suitable brake dynamometer, which suggests just how difficult it was to get such devices even in a postwar environment. The choking employed was extreme: the air intake was restricted to less than 2½% of its normal size, which caused engine misfiring during warm-up.

<sup>72</sup> R. E. Pattle *et al.* made two experiments with that setting, one resulting in only 0.12% CO, the other in 0.22% CO; no reason was given; CO<sub>2</sub> was between 2.34% and 3.58%; *op. cit.* (note 54), pp. 49f. For another discussion of the same material see: Conrad Grieb “*Holocaust: Dieselmotorabgase töten langsam,*” *Vierteljahreshefte für freie Geschichtsforschung* 1(3) (1997), pp. 134-137 (online: [vho.org/VffG/1997/3/Grieb3.html](http://vho.org/VffG/1997/3/Grieb3.html)).

### 8.3. Actual Concentrations of Poison Gas in a Gas Chamber

When the exhaust from a Diesel engine enters a gas chamber, the carbon monoxide concentration will initially be extremely low and the oxygen level will be high. As more and more Diesel exhaust fills the gas chamber, the carbon monoxide concentration will gradually rise to the same level as one finds directly inside the exhaust pipe of the Diesel engine – without ever exceeding that level.

It is impossible to determine from the Gerstein Statement how long it would have taken before the CO concentration in the gas chamber equaled that in the exhaust because Gerstein does not provide nearly enough information about the engine or alleged gas chamber in Belzec.

For Treblinka, the ‘eyewitness’ statements are somewhat more detailed, but still contradictory. It is generally alleged that the larger and more important of the two gas chamber buildings in Treblinka consisted of 10 chambers, five on each side of a corridor.<sup>73</sup> Each chamber measured 8 m in length, 4 m in width, and 2 m in height, totaling 320 m<sup>2</sup> in area and a 640 m<sup>3</sup> in volume. The chambers were allegedly filled with the exhaust from only one Russian Diesel tank engine, which could have only been the 550 hp V12 with a displacement of 38.86 liters.<sup>74</sup> The total area of 320 m<sup>2</sup> could not have held more than 3,200 persons at one time.<sup>75</sup> Given an average body volume of 75 l, these people would have taken up a space of 240 m<sup>3</sup>, leaving about 400 m<sup>3</sup> air volume.

The Russian Diesel tank engines of those days had a maximum speed of 2,000 rpm.<sup>76</sup> Since a four-stroke engine discharges the contents of its cylinders only every second revolution, an engine running at 2,000 rpm blows an exhaust volume of one thousand times its cubic capacity into the chamber per minute, *i.e.*, 38.86 m<sup>3</sup>. Therefore, after a little more than ten minutes, enough exhaust would have been discharged to replace the entire air volume of the gas chambers only once. The eyewitnesses claim that the gas chambers were sealed hermetically; in other words, they were air-tight.<sup>68</sup> But this is impossible, since there must have been some openings for the excess gas to escape.<sup>77</sup> Also, without many holes and cracks, everyone would have already died during the “2 hours and 49 minutes” by Gerstein’s stopwatch. However, since some of the Diesel exhaust would have also escaped through holes or cracks – not just normal air from within the chamber – and since the intended victims would have also consumed some of the carbon monoxide, a minimum of two complete air exchanges of the room volume seem entirely reasonable for filling the chamber entirely with the exhaust. At 2,000 rpm, therefore, one cannot expect the CO content to have reached the level of the exhaust itself in less than 20 minutes from the start of the gassing procedure. If a restricted air intake to the engine had produced a 0.22%/vol. CO content in the exhaust in the worst case possible, the average CO concentration would have then approximated 0.11%.<sup>78</sup> The full 0.22%/vol. CO would have been available for no more than the last twelve minutes of the gassing, which took 32 minutes at most. The 20 minutes with a CO level of 0.11%/vol. and the additional 12 minutes at 0.22%/vol. CO result in an effective average for thirty-two minutes of only 0.15%CO/vol. (simply on the basis of mathematical averaging). At an oxygen content of ca. 11.4%/vol., this amounts to an effective CO content of 0.28%/vol., which is

<sup>73</sup> For a detailed analysis of the gas chamber claims for Treblinka, see C. Mattogno, J. Graf, *Treblinka. Vernichtungslager oder Durchgangslager?* Castle Hill Publishers, Hastings 2002, pp. 145-151, also in particular the Soviet ‘gas chamber’ plan on page 397; Engl.: *Treblinka. Extermination Camp or Transit Camp?* Theses & Dissertations Press, Chicago 2003.

<sup>74</sup> Cf. A. Donat (ed.), *op. cit.* (note 68), pp. 34, 157ff., and the Treblinka verdict of Düsseldorf, *ibid.*, p. 300ff.; Y. Arad, *op. cit.* (note 17), p. 119f.; J.-F. Steiner, *Treblinka*, Stalling, Oldenburg 1966, p. 173. Regarding the engine type, cf. note 31.

<sup>75</sup> J.-F. Steiner, *op. cit.* (note 74), p. 173, speaks of 200 people per chamber. J. Wiernik (in A. Donat, *op. cit.* (note 68), p. 161), on the other hand, fantasizes about 1,000 to 1,200 per chamber, whose area he gives as 7 × 7 m, in other words more than 20 people per square meter. Y. Arad, *op. cit.* (note 17), pp. 120f., puts a maximum of 380 but an actual estimate of up to 300 people into each chamber, and at times speaks of only 6 chambers, not 10.

<sup>76</sup> Augustin, *Motortechnische Zeitschrift* 5(4/5) (1943), pp. 130-139.

<sup>77</sup> The resultant excess pressure would have exploded the chamber after only a few minutes; cf. the chapter by A. Neumaier in this volume.

<sup>78</sup> Assuming a linear increase in the CO content.

not enough to kill all humans within half an hour. In other words, it is well below the 0.4%/vol. of CO that we had identified in Section 5 of this article as the minimum needed.

In the animal experiment previously described with a real CO concentration of 0.22%/vol., *which was already established before the test animals were even introduced* and which, because of the reduced oxygen content of 11.4%/vol., corresponded to an effective CO concentration of  $(0.22 \times 21 \div 11.4 =)$  0.4%/vol., it still took more than three hours to kill *all* of the test animals. It is, therefore, perfectly reasonable and even quite conservative to say that in a similar gassing attempt with humans and with only a gradually increasing CO concentration, the majority of people in the alleged gas chamber would still be alive after one or even two hours. Such a result would have been an utter fiasco.

#### 8.4. Exhaust Gas Recirculation for Mass Murder

The remaining question is whether a Diesel gas chamber might have worked by recirculating the exhaust gas from the engine. This is actually a well-known problem with Diesel exhaust going back to at least the 1920's in Germany. The concept is to have the air intake, as well as exhaust, connected directly to the same gas chamber. The exhaust then goes around through the engine and the gas chamber, and on back through the engine, and around again, and again. Eventually, so much oxygen is consumed and so much carbon monoxide is produced, that together these changes kill everyone. But, the engine eventually also shuts itself down when there is no longer enough oxygen to sustain combustion; at that point, the engine also ceases producing any more carbon monoxide. The problem is that in order to receive an exhaust gas with a relatively high content of CO, the engine has to be suffocated to a degree

Carbon monoxide gas is an excellent fuel and actually burns far more easily than Diesel fuel or even gasoline. As the exhaust gas recirculates, any additive increase in carbon monoxide levels which one might at first expect will, in fact, not occur at all so long as there is still sufficient oxygen to allow the CO to burn in the cylinders. If the CO level is initially only 0.05% after the first pass through the engine, one might – wrongly – expect it to double to 0.10% after the second pass, and then rise to 0.15% after the third pass, and so on, and on. In reality, however, the carbon monoxide concentration is not at all accumulative so long as the air to fuel ratio remains above 15:1. Since the initial fuel/air ratio is probably more than 100:1, there will be no significant change in CO concentration until several complete exchanges of gas have occurred and just shortly before the engine shuts down. This is confirmed by results in a US Bureau of Mines study which also shows that the CO levels remain low until just shortly before the engine shuts down.<sup>79</sup>

Whether the engine dies before the intended victims die is the important question. In order to obtain 0.22%/vol. of CO in the experiment conducted by Pattle *et al.*, the engine's air intake had to be so severely restricted that it did misfire during warm-up.<sup>71</sup> This means that choking the engine even more by reducing the oxygen concentration from 21%/vol. of normal air down to 11.4%/vol. of recirculated exhaust gases would have shut down the engine most likely well before all victims had died. There is no mention in the Gerstein statement or anywhere else of the engine shutting down. The only reference to engine problems is that Mr. Heckenholt allegedly needed more than two hours just to get the engine *started*, during which time the survival of the victims would have required many air leaks into the gas chamber. It seems about as reasonable as anything else to conclude from the Gerstein statement that the engine ran throughout the 32-minute gassing period without any problem from lack of oxygen, or for any other reason. In other words, even the recirculation argument fails to fit any of the Diesel gas chamber scenarios from Gerstein, or anyone else.

---

<sup>79</sup> W.F. Marshall, R.W. Hurn, "Hazard from Engines Rebreathing Exhaust in Confined Space", U.S. Department of the Interior, Bureau of Mines, Report of Investigations 7757, 1973, pp. 7-10.

## 8.5. The Most Likely Diesel Arrangement for Mass Murder

Without a thorough understanding of the basic characteristics of Diesel engines, the simple-minded method that would have come to mind most readily would have been to simply park a Diesel truck or a T-34 tank outside the gas chamber building and pipe the exhaust into the gas chamber without any load on the engine. Such an arrangement would have annoyed the hell out of any group of intended victims, but would have given them nothing worse than a headache. The headache would have been due to the stench, and smoke, and noise, but certainly not to carbon monoxide and/or lack of oxygen. As a method for mass murder, it would have been a fiasco.

For any Diesel arrangement to have been even marginally effective for mass murder, it would have required an exceptionally well-informed team of individuals to know and do all that was necessary. They would have had to be familiar with the carbon monoxide and oxygen emission curves for their particular engine. Such information is probably not known even today by most engineers. The Diesel gas chamber designers would also have had to know either 1) how to impose and maintain an engine load of more than  $\frac{3}{4}$  of full load on their engine, since anything less would just not have been enough, or 2) how to combine a restricted air intake with some lesser degree of engine loading to achieve the same effect. If they had overloaded the engine or had operated it for too long at or near full load (more than 80% of full load is generally considered unsafe for continuous operation), they might after each gassing have had to overhaul and perhaps replace the engine because of fouling and damage from engine smoke. Merely to gather and assemble the appropriate equipment, including the equipment for imposing and controlling an artificial load, would have been a major undertaking which would have required the expertise of experienced engineers, not just ordinary auto mechanics. If the engine (550 hp!) had been mounted on the floor of the building, it would have required a proper foundation with some provision to isolate vibrations so as to avoid tearing the building apart.

The all-important question is: if any persons had been smart enough and resourceful enough to know and do all that was necessary to make a workable Diesel gas chamber, why would they have bothered with a Diesel engine in the first place? For all their efforts, they would have had an average effective concentration of less than 0.4%/vol. carbon monoxide and more than 4%/vol. oxygen, resulting in execution times of probably more than two hours. Any common, ordinary gasoline engine without any special attachments would easily have given them ten times more carbon monoxide at idle as any comparably-sized Diesel at full load.. Any common, ordinary gasoline engine would easily have given them 7%/vol. carbon monoxide and less than 1%/vol. oxygen. If one had fiddled with the carburetor, one could have had as much as 12%/vol. carbon monoxide by merely turning one small screw, namely the idle-mixture adjustment screw. Comparing the two types of engines with both operating at idle or under light load, the difference is even more dramatic. At idle or under light load, any common, ordinary gasoline engine without any special attachments would easily have given more than one hundred times as much carbon monoxide as any comparably sized Diesel.

The hoax becomes even more obvious when one discovers that far better sources of carbon monoxide, better even than gasoline engines, were readily available to the Germans – and required neither Diesel fuel nor gasoline.

## 9. Half a Million Poison Gas Generators on Wheels – Never Used for Mass Murder!

During World War Two, most European countries relied for most of their non-military automotive transport upon vehicles which used neither gasoline nor Diesel, but burned solid fuels such as wood, coke, or coal instead. The solid fuel, which was generally wood, was first converted into a mixture of combustible gases by burning in a generator, usually mounted at the rear of the vehicle. The gases were then withdrawn from the generator by engine suction through a pipe beneath the vehicle, and then burned in a modified gasoline or Diesel engine located at the front of the vehicle. The combustible gas produced in this way always contained between 18%/vol. and 35%/vol. carbon monoxide.

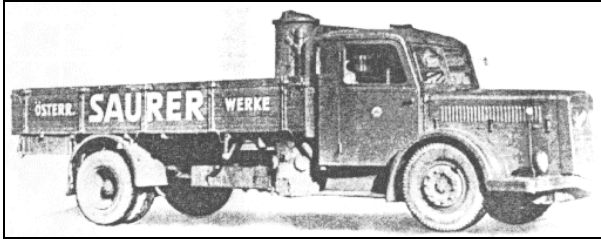

**Illustration 2:** Saurer BT 4500 with producer gas generator.<sup>84</sup> A Saurer truck similar to this type allegedly was used for mass murder in Kulmhof/Chelmno – not with producer gas, but incredibly with its exhaust gas.<sup>85</sup>

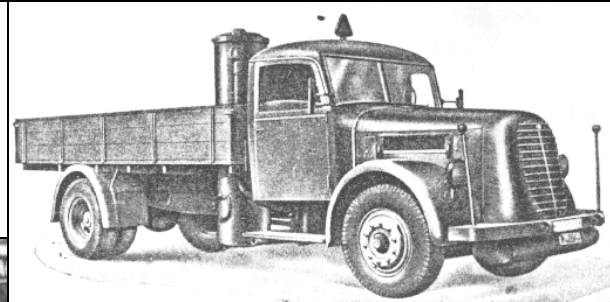

**Illustration 3:** Austro-Fiat 4 D 90 A, producer gas generator as standard fitting.<sup>84</sup>



**Illustration 1:** A typical gaswagon which had originally been a conventional bus but which was subsequently retro-fitted with a gas-generator and a Saurer engine.<sup>81</sup>

The exhaust of engines operated with this producer gas never contained more than 0.3%/vol. CO, since nearly all of the CO was consumed in the engine.<sup>80</sup>

In German-speaking parts of Europe, these vehicles were called *Generatorgaswagen*, or simply *Gaswagen*. If they burned wood, which most of them did, they were also called *Holzgaswagen* which translates literally as “woodgaswagons.” In English-speaking countries, these vehicles were generally called “*producer gas vehicles*.” However, they could just as appropriately have been called “*poison gas vehicles*” because that is precisely what they were. The operation of these vehicles required special safety procedures as well as special government-approved training and licensing of the *many hundreds of thousands of drivers who drove these vehicles daily throughout German-occupied Europe*.<sup>82</sup>

Every driver of a producer gas vehicle was required to know and comply with the following guidelines and to keep them at hand in the vehicle:<sup>83</sup>

### “*Safety Guidelines for Producer Gas Vehicles*”

*dated November 28, 1942.*

*The gas from the gas generator contains up to 35% carbon monoxide (CO). Carbon monoxide can be fatal at concentrations as low as 0.1% when inhaled. For this reason – especially while starting the fire or during refilling – there is a **danger of poisoning!***

*Start and refill the gas generator only out-of-doors! Do not linger unnecessarily near the blower discharge. **Do not let engines run in garages.***

#### ***Responsibilities of the supervisor and driver:***

<sup>80</sup> H. Bour, I. McA. Ledingham, *Carbon Monoxide Poisoning*, Elsevier, Amsterdam 1967, p. 2.

<sup>81</sup> W. Oerley, “*Entwicklung und Stand der Holzgaserzeuger in Österreich, März 1938*”, *Automobiltechnische Zeitschrift* 11 (1939), p. 314.

<sup>82</sup> The German technical automotive literature of that time is chock full of material about this technology that has been so completely forgotten today. For an introductory overview, cf. *Automobiltechnische Zeitschrift* 18 (1940) and 18 (1941). Cf. also E. Eckermann, *Alte Technik mit Zukunft: Die Entwicklung des Imbert-Generators*, Oldenbourg, Munich 1986.

<sup>83</sup> H. Fiebelkorn, *Behandlung und Instandsetzung von Fahrzeug-Gaserzeugeranlagen*, W. Knapp, Halle 1944, p. 189; cf. 2<sup>nd</sup> ed., *ibid.*, 1948.

<sup>84</sup> Walter J. Spielberger, *Kraftfahrzeuge und Panzer des österreichischen Heeres 1896 bis heute*, Motorbuch Verlag, Stuttgart 1976, pp. 207, 213.

*All persons who work with producer gas generators are required to learn and conform to the necessary procedures for a safe and orderly operation. The manufacturer's operating instructions must be strictly followed and kept available within the vehicle. Furthermore, these safety guidelines must also be kept with the vehicle documents for each producer gas vehicle [...]" (emphasis as in original)*

Already the first two sentences of these “safety guidelines” tell every driver the two most important facts they should know if they wish to commit mass murder. Producer gas is poison gas! All producer gas vehicles were, in effect, self-propelled gas generators. The fuel itself was poison gas.

Wherever possible, liquid fuels had to be reserved for the military, at least for the duration of the war. The interest which even Adolf Hitler showed is demonstrated by his remarks at an exhibition of Mercedes-Benz heavy trucks with Mercedes-Benz gas producers that burned coal:<sup>86</sup>

*“Vehicles of this kind will retain their special significance after the war as well; for given the trend towards increasing motorization, we will never have a surplus of liquid fuel and will always be dependent on imports. The additional domestic fuels thus benefit our own national economy.”*

By the autumn of 1941, some 150,000 producer gas vehicles were already in use in Germany and the areas controlled by her. The conversion of existing trucks to producer gas resulted in a monthly savings of about 45 million liters of liquid fuel. The goal was “to free every bit of dispensable fuel for the Wehrmacht.”<sup>87</sup> By the end of the war, more than 500,000 producer gas vehicles had been put into service by the Germans.<sup>88</sup>

On May 30, 1942, Reichsmarschall Göring established a “Generator Central Office” for his Four-Year Plan:<sup>89</sup>

*“to boost generator production, to determine new types on the basis of the fuel situation at hand, to develop new solid fuels for use in the generator, and to develop suitable processes for preparation and low-temperature carbonization etc.”*

Göring stated:<sup>90</sup>

*“I refer to the explanations in my aforementioned decree, regarding the urgency of making Germany as well as the occupied territories and dependent lands largely independent of liquid fuel as quickly as possible, and would ask you to vigorously support the efforts of the Central Office through the increased use of generators.”*

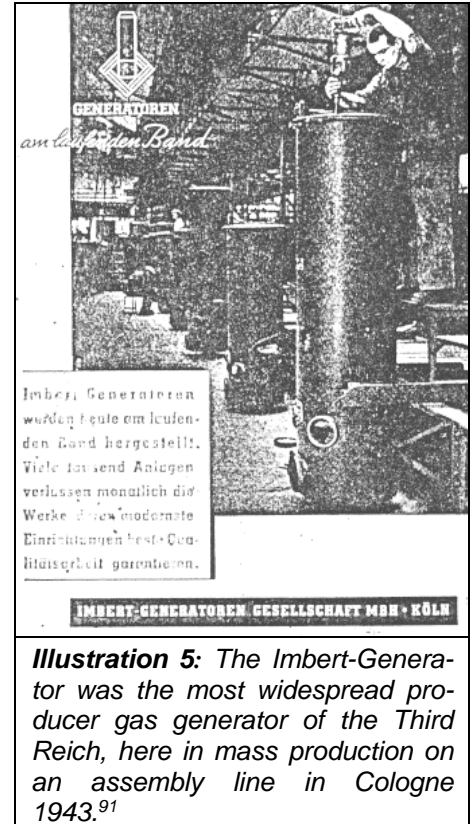

**Illustration 5:** The Imbert-Generator was the most widespread producer gas generator of the Third Reich, here in mass production on an assembly line in Cologne 1943.<sup>91</sup>



**Illustration 4:** Another German war-time producer gas truck form Saurer (Type 5 BHW)

<sup>85</sup> Cf. the chapter by I. Weckert, this volume.

<sup>86</sup> A. Hitler, July 15, 1940, quoted from W. Ostwald, *Generator-Jahrbuch*, 1942, J. Kasper & Co., Berlin 1943, p. 79.

<sup>87</sup> W. Ostwald, *op. cit.* (note 86), pp. 41f.

<sup>88</sup> E. Eckermann, *op. cit.* (note 82).

<sup>89</sup> E. Hafer, *Die gesetzliche Regelung des Generatoren- und Festkraftstoff-Einsatzes im Großdeutschen Reich*, J. Kasper & Co., Berlin 1943, p. 15.

<sup>90</sup> Letter from H. Göring to the Reich Economic Minister, the Reich Transportation Minister, the Commanders-in-Chief of the Wehrmacht units, the Chief of the Wehrmacht Supreme Command, the Reich Ministers for Armament and Munition as well as for the occupied eastern territories, according to E. Hafer, *op. cit.* (note 89), p. 17.

As the war continued, conversion to solid fuel became more and more urgent. On September 22, 1942, Reich Minister Speer, acting in his capacity as plenipotentiary for armament production (GBRüst), ordered the conversion of all medium and heavy vehicles including buses in all German-occupied regions.<sup>92</sup> A year later, the GBRüst's amendment of September 13, 1943, eliminated all exemptions. Now the conversion of all civilian vehicles was mandatory as well, including even the smallest automobiles.<sup>93</sup> After the war, in a long report about German oil production, the U.S. Strategic Bombing Survey stated that even some of the best German tanks, 50 *Königstiger*, had been driven with producer gas just before the war's end.<sup>94</sup>

The vast numbers of producer gas vehicles as well as the fervor with which the Germans developed new vehicles and uses for this gas technology, which is so evident throughout their wartime automotive literature, undermine the Holocaust story in general. If the Germans had ever intended to commit mass murder with carbon monoxide, they certainly would have had enough brains to employ this superb poison gas technology long before using anything as idiotic as Diesel exhaust. And, it would have worked!

Eichmann and the other 'transportation experts' involved in the "*final solution of the Jewish question*," which was indeed primarily a transportation problem, would certainly have been fully aware of these vehicles. If they had had any expertise at all, they would have also been aware of some of the unique features of these vehicles as well. For example, each generator had a startup blower which was powered by either a small electric motor or by hand. It would have been childishly easy to attach a hose, or pipe, to the exhaust of that blower so as to force poison gas into any cellar, barracks, or prison, but nowhere in the vast Holocaust literature is any such technology even suggested.

Another irony is the fact that the same producer gas technology was actually used to gas rats and other vermin. According to the public health literature from the Third Reich, producer gas equipment from the firm of Nocht-Giemsma for killing rats was "*very common*."<sup>95</sup> And yet, no one thought of using this obvious, practical, effective, simple, and cheap technology on humans – even Jews who had sometimes been compared to rats as in the film "*Der Ewige Jude*" (The Eternal Jew). Obviously, the National Socialists were not nearly as fiendishly clever, as exterminationists often claimed they were, in connecting Jews to rats.

## 10. Vans with Diesels for Mass Murder?

### 10.1 Origins of the Diesel Story

---

<sup>91</sup> *Motortechnische Zeitschrift*, Nr. 6/7, 1943, p. 3A.

<sup>92</sup> E. Hafer, *op. cit.* (note 89), p. 36.

<sup>93</sup> E. Hafer, *op. cit.* (note 89), supplement, p. 35a.

<sup>94</sup> U.S. Strategic Bombing Survey, *The German Oil Industry Ministerial Report Team 78*, War Department, Washington, D.C., 1947, p. 73. More than likely these were training tanks (*Schulungspanzer*) drafted into combat during the last months of the war.

<sup>95</sup> L. Gassner, "*Verkehrshygiene und Schädlingsbekämpfung*", *Gesundheits-Ingenieur* 66(15) (1943), p. 175.

The producer gas vehicles are not the same as the “gas vans” allegedly used for mass murder in Chelmno and by the *Einsatzgruppen* in Russia, despite the ironic circumstance that the words used in German for both kinds of vehicles are similar. According to all the ‘evidence,’ the murderous “gas vans” were ordinary heavy vehicles whose exhaust (most often from a Diesel operating at idle) became the lethal gas. The gas van story is based primarily on a strange Nuremberg trial document known as PS-501, which is a probable fabrication based upon an unavailable, innocuous letter from SS-Untersturmführer Becker to SS-Obersturmbannführer Walther Rauff, in which Bekker requested all-wheel-drive vehicles so that he could more easily travel the muddy Russian roads. The letter suggests modifications to an S-vehicle.<sup>96</sup> The text of an unavailable original seems to have been rewritten with several changes to give it an incriminating significance. There are several different versions of this ‘document’ which has been critically assessed in the present volume by Ingrid Weckert.

The Diesel murder claims probably originated in mid-1943 Soviet propaganda. A short time earlier, in April 1943, the German discovery of the massacre of thousands of Polish officers at Katyn had exposed the Soviets as ruthless mass murderers. The Germans had openly invited internationally-renowned forensic scientists, even from enemy countries, to thoroughly examine the victims.<sup>97</sup>

To avenge themselves on the Germans for the debacle of Katyn, the Soviets staged show trials a few months later in Char’kov and Krasnodar. In the course of those trials, some unfortunate German prisoners provided ‘confessions.’ However, the Soviets denied any and all non-Soviet experts access to the alleged sites of the massacres. The Soviets accused the Germans of having driven civilians into the countryside in Diesel trucks. After the trucks containing the victims were parked, the Diesel engine exhaust was allegedly redirected into the interior, and the victims expired shortly thereafter.

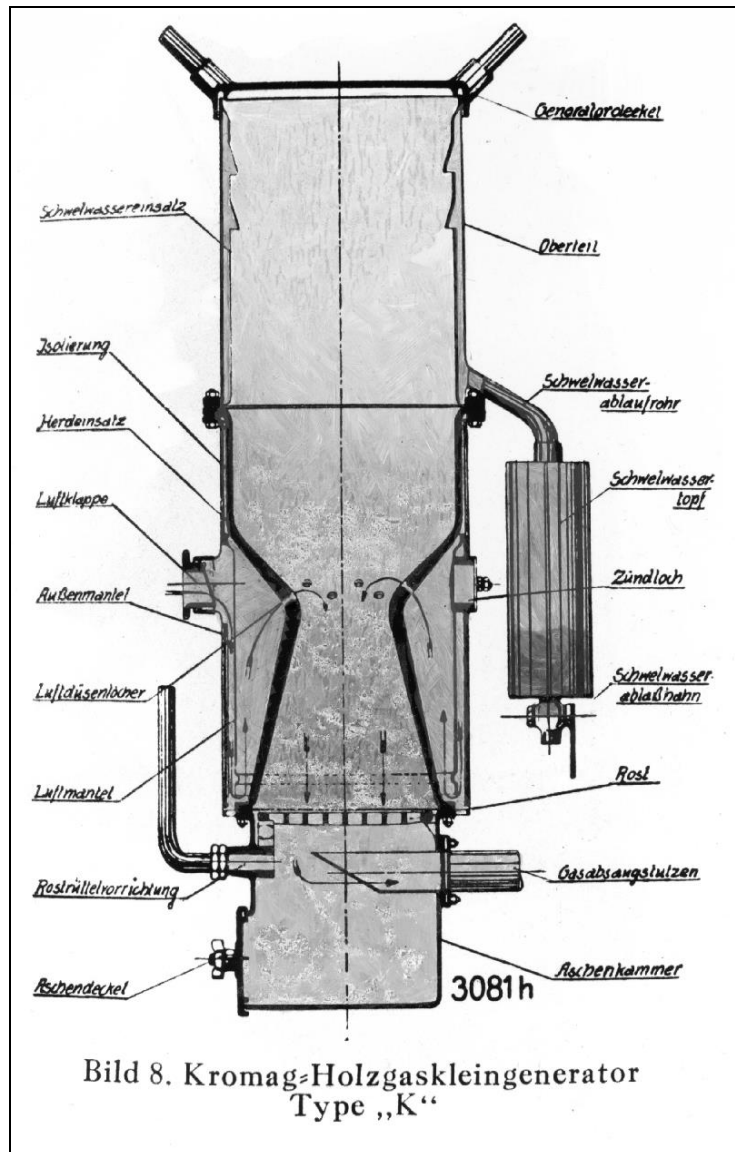
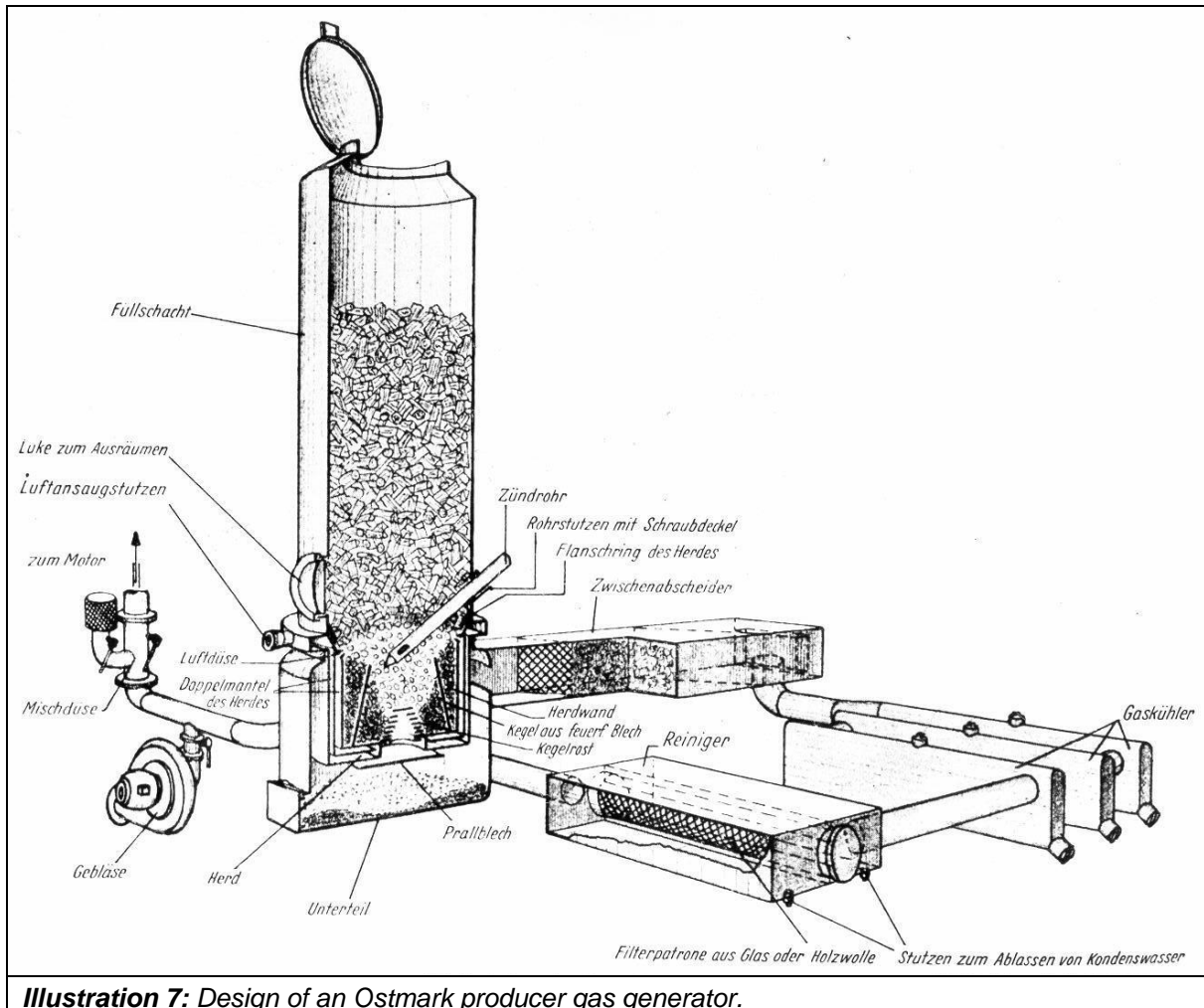

**Illustration 6:** German war-time producer gas generator made by Kromag

<sup>96</sup> “S” stood for “standard” as in standard drive via the rear wheels, as opposed to the “A” vehicles with all-wheel drive, and the special or “Sonder” vehicles abbreviated as “Sd.-Kfz”; all vehicles such as tanks, for example, had their own *Sonder* class numbers. Another *spezial* class was designated with a lower case “s.” cf. W. Spielberger, *Spezial-Panzer-Fahrzeuge des deutschen Heeres*, Motorbuch-Verlag, Stuttgart 1977, pp. 153f.; W. Spielberger, *Die Halbkettenfahrzeuge des deutschen Heeres*, 2<sup>nd</sup> ed., *ibid.*, 1984, pp. 170f.; W.J.L. Davies, *German Army Handbook 1939-1945*, Arco, New York 1981, p. 90. In other words, the German designations had nothing whatever to do with any sinister cover-up as Hilberg and others have often alleged.

<sup>97</sup> F. Kadell, *Die Katyn-Lüge*, Herbig, Munich 1991.





**Illustration 7:** Design of an Ostmark producer gas generator.

In this scenario, the Diesel engines would have been operating without any load and at fast idle at the very worst. The CO concentrations under such conditions would hardly have caused a headache in half an hour.

Some of these trucks were said to have been manufactured by the firm of Saurer.<sup>98</sup> The ironic part of this tale is that even before the war, Saurer was arguably the manufacturer of the world's best and most efficient producer gas trucks. During the war, this Swiss-Austrian firm continued its technical leadership over Mercedes, Opel, and Ford who were actually manufacturing far more producer gas vehicles.<sup>98</sup> More than 6,000 Saurer trucks were built in Vienna during the war and most, if not all, had producer gas generators and Diesel engines. How absurd to believe anyone with even a minimum of technical understanding would even try to use the exhaust from these trucks for murder, when the fuel itself was a thousand times more lethal!

A television series produced during the collapse of the Soviet Union and aired in the United States in 1993, provided further insight into the Soviet origins of the gas van tale. The four-part broadcast was entitled: "*Monster: A Portrait of Stalin in Blood*." At one point in the second part, subtitled "*Stalin's Secret Police*," KGB officer Alexander Michailov claimed that the gas trucks were invented in

<sup>98</sup> All Saurer Diesel engines employed, even before the war, a swirl chamber (*Doppelwirbelkammer*) machined into the top of each piston. This design had been unused for many years after the war and after the demise of the Swiss Saurer. However, the concept has been revived as "*bowel in piston*" by Audi and is now used widely in the most advanced Diesel engines of VW and Mercedes Benz to help meet the most stringent environmental emissions standards; see John B. Heywood, *Internal Combustion Engine Fundamentals*, McGraw-Hill, 1988. Of all the Diesels available, the Saurer designs were the least likely to have served as any kind of source for toxic emissions.

Moscow by Isai Davidovich Berg – no relation to this author – and were already in use a few years before the war. According to Michailov, these may have served as a model for Hitler’s SS and the Gestapo. Diesel engines were not mentioned. This is explained by the fact that all pre-war trucks in the Soviet Union had only gasoline engines. There were no Diesel engines since the entire transportation system in the USSR was based on earlier, western engine types such as that of Ford Motor Co. More than likely, the Soviet allegations of gas trucks are truly based on the Soviets’ own mass murder technology to which they simply added Diesel engines to make them seem more sinister and, most of all, more German.

The gas van story is an adaptation of some documentary materials relating to the perfectly innocent use of producer gas vehicles – supported, of course, by appropriate ‘eyewitness’ testimony. It is within the gas van story, however, that one can see in miniature the process by which the Holocaust story in general has been confabulated.

The earliest reference to mass murder in gas vans that I have ever found is from July 1943, when *Pravda* reported on the show trials of a number of German prisoners who had supposedly murdered Soviet citizens in Krasnodar with Diesel powered vans. English translations of the *Pravda* stories appeared in *The Trial* in Britain through Hutchinson & Co. and Foreign Languages Publishing House where we have the following text:<sup>99</sup>

*“In the autumn of 1942, the Germans began to use specially equipped automobiles which the population called ‘murder vans,’ for the purpose of doing away with Soviet citizens.*

*These ‘murder vans’ were covered five-ton or seven-ton gray-painted motor trucks, driven by Diesel engines.”*

From a later trial in Kharkov in December of 1943 we have the following claim:<sup>100</sup>

*“The vans are lined inside with galvanized iron and have airtight folding doors at the back. The floor is equipped with a wooden grating under which passes a pipe with apertures. The pipe is connected to the exhaust pipe of the engine. The exhaust gases of the Diesel engine, containing highly concentrated carbon monoxide, enter the body of the van, causing rapid poisoning and asphyxiation of the people locked up in the van.”*

The simple fact is that Diesel exhaust never contains “highly concentrated carbon monoxide.”

In a later publication entitled “*Soviet War Documents*” from December 1943 and published by the Soviet Embassy in Washington, DC, we have a description of the gas van on page 172. According to that description, the engine was a “*Sauer*” engine. There is no “*Sauer*” engine manufacturer but there is the famous company called “*Saurer*” which was discussed earlier. The connection that is made here to a company called “*Sauer*” is significant because it reappears in the infamous fake letter from Becker to Rauff in Nuremberg File PS-501.<sup>101</sup> By their common errors one can recognize the work of the forgers. There is never any mention anywhere of the engines having been gasoline engines – although that would have certainly made sense technically – nor is there any mention of producer gas wagons which would have made all the sense in the world.

## 10.2. The Vans of Chelmno

The least important of the six supposed extermination camps, in terms of numbers of victims, is Chelmno. Oddly enough, it is the Chelmno story that seems to have some persistence even among Holocaust skeptics. The ‘evidence’ is especially vague and consists essentially of anecdotes, many describing events long after September 13, 1943, when all use of liquid fuels (gasoline or Diesel fuel) for non-military vehicles was strictly prohibited and when producer gas was required as the only alternate fuel. The anecdotes invariably allege that the driver, just prior to departure with a batch of entrapped victims, would work on something or other (always totally undefined as to what and how) be-

<sup>99</sup> *The Trial in the Case of the Atrocities Committed by the German Fascist Invaders and their Accomplices in Krasnodar and Krasnodar Territory, July 14 to 17, 1943*, Foreign Languages Publishing House, Moscow 1943.

<sup>100</sup> *The People’s Verdict*, Hutchinson & Co., London, 1944, page 43.

<sup>101</sup> Nürnberger Dokument PS-501; cf. I. Weckert in this volume.

neath the vehicle to redirect the exhaust from the engine (Diesel or gasoline – take your pick) into the van compartment to kill the victims. For producer gas vehicles, a lengthy startup procedure (half-an-hour seems to have been common) involving many adjustments to the gas generator and piping below the vehicle was, indeed, always necessary, but this was not the case for vehicles using liquid fuels. More than likely, some ‘witnesses’ had actually seen a producer gas startup procedure and then, after the war, embellished that true experience to make something atrocious. But what argues most strongly against all such stories is that the use of trucks (medium and heavy) using any kind of liquid fuel had already been prohibited a year earlier by Speer on September 22, 1942; smaller vehicles were still exempt until a year later (see section 9). To break the law for a few per cent of CO from gasoline engine exhaust – or even only a fraction of a percent from Diesel engine exhaust – when the legally required fuel was far more lethal, is too ridiculous. It never happened!.

### 10.3. Accidental Gassings from Producer Gas Vehicles

Producer gas is poison gas – extremely poisonous with CO concentrations as high as 35%. Although there is no credible evidence of any deliberate gassings with producer gas vans, there were no doubt many fatal, accidental gassings. These arose almost inevitably from the nature of the half million producer gas vans which made their own CO. Fatal accidents were inevitable from the earliest uses of these vehicles and, no doubt, became more frequent as the war made it more difficult to properly train drivers. However, this author has found no actual record of any such accidents in the German wartime literature. The severe dangers of accidental poisonings and explosions are, however, clearly spelled out in the German literature including the safety guidelines.

It is in the post-war literature of Scandinavia that one can, however, find the most startling detailed information as to the many medical problems arising from producer vehicles. Poisonings from producer gas were so common in Sweden, for example, that two special clinics were established to treat the victims.<sup>102</sup> When the war ended, the use of these vehicles declined only gradually. In the early 1950’s in West Germany, at least 20,000 were still in use, and their safe operation was still of great concern to medical professionals.<sup>103</sup>

## 11. An Empire Built on Coal, Air, and Water

In addition to producer gas, the Germans had the world’s most advanced coal gasification technology.<sup>104</sup> One of the first steps was to produce carbon monoxide, which could then in turn be used either as fuel or as an intermediate raw material in the synthesis of other products. The following postwar statement by some of America’s greatest experts on German industry summarized the situation:<sup>105</sup>

*“War-time Germany was an empire built on coal, air and water. 84.5% of her aviation fuel, 85% of her motor fuel, more than 99% of all her rubber, 100% of her concentrated nitric acid – the base substance for all military explosives – and 99% of her no less important methanol were synthesized from these three raw materials. [...] Coal gasification facilities, where coal was converted into producer gas, were the body of this industrial organism.”*

---

<sup>102</sup> Aage Grut, *Chronic Carbon Monoxide Poisoning*, Ejnar Munksgaard, Copenhagen 1949, p. 69. See also Leo Noro, “Über die durch Motorabgase verursachten Kohlenoxydvergiftungen bei der Mannschaft von Panzerformationen”, *Acta Medica Scandinavica*, CXXI(IV) (1945); K. v. Bagh, “Neurologisch-psychiatrische Gesichtspunkte zur Diagnostik und Behandlung der chronischen Generatorgasvergiftungen”, *Annales Medicinæ Internæ Fenniae*, Vol. 35, 1946.

<sup>103</sup> E. W. Baader, *Gewerbekrankheiten*, Munich/Berlin 1954, pp. 178-184.

<sup>104</sup> Cf. esp.: W. Gumz, J. F. Foster (Battelle Memorial Institute), “A Critical Survey of Methods of Making a High BTU Gas from Coal”, *Research Bull. No. 6*, American Gas Association, New York 1953; further detailed references are given there.

<sup>105</sup> U. S. Strategic Bombing Survey, *Oil Division Final Report*, War Department, Washington, D.C., 1947, p. 1 [retrans. from German trans.].

Because of Germany's isolation from adequate sources of petroleum and natural rubber, she had already converted much of her industry during World War One to use coal as a substitute source of hydrocarbons for making synthetic liquid fuels as well as a vast assortment of chemical substances, including synthetic rubber. Millions of tons of carbon monoxide were produced as part of this technology and would have been more than enough to kill the entire population of Europe many times over.

Coal gasification plants were located in all of Germany's industrial regions. One region containing several such plants was Silesia, where the abundance of coal had for more than a century been the basis of that region's industry. One Silesian facility was the IG Farbenindustrie A.G. plant at Auschwitz, a small portion of whose carbon monoxide could easily have been diverted through a small pipeline to Auschwitz-Birkenau only a few miles away. But no one alleges that carbon monoxide was ever used for mass murder at Auschwitz, although that would have been an ideal place for it. For mass murder at Auschwitz, the Germans supposedly used a completely different substance: Zyklon B.<sup>106</sup>

## 12. Scholarly Evasion and Metamorphosis

A marvelous attempt at evasion and distortion took place nearly twenty years ago in the Holocaust story. A group of twenty-four of the world's leading Holocaust 'scholars' tried to *drop* the Diesel claim by not even mentioning the engine type and by referring only to gasoline engines. This amazing metamorphosis took place in *Nationalsozialistische Massentötungen durch Giftgas*, published in Germany in 1983.<sup>107</sup> This extremely pretentious book represents the state of Holocaust mythomania in the first half of the 1980s and was recommended by the World Jewish Congress in London.<sup>108</sup> For example, the next to last chapter entitled "*The two Poison Gases*" (*Die Zwei Giftgase*) even gives the molecular weight of CO, twice, as well as many other totally irrelevant technical properties of CO and HCN. Many readers were no doubt impressed.

The clumsy juggling of evidence, which characterizes this book, is shown by the fact that although the Gerstein Statement refers to Diesel engines four times, the portion quoted in this supposedly definitive rebuttal of the Revisionists does not mention the Diesels at all, nor does it even describe the alleged killing process.<sup>109</sup> For such a description, the book gives instead a piece of post-war testimony by Dr. Pfannenstiel, in which there is also no mention of the use of Diesels, but only of the use of "*Diesel fuel*" in the engine.<sup>110</sup> How one could possibly have operated a gasoline engine with Diesel



Bild 3. Omnibus mit 26 Sitzen und Holzgasantrieb. Bauert Prof. Dr. Dietrich. Der Generator ist im Heck angebracht und vollständig verkleidet. Die Lüftung im Heck dient zur Belüftung und sind gleichzeitig Stützpunkte für das Bodenpersonal. Zusätzlicher Holzvorrat befindet sich auf dem Dach über dem Heck.  
Fertigung der Teile und die Deckung der zu erwartenden Kraftstoffnachfrage.

**Illustration 8:** German war-time producer gas coach.

**Illustration 9 (below):** wide-spread German war-time logo for producer gas technology



<sup>106</sup> Cf. the chapter by G. Rudolf, this volume, as well as F. P. Berg, "*Typhus and the Jews*", *JHR* 8(4) (1988), pp. 433-481 (online: [who.org/GB/Journals/JHR/8/4/Berg433-481.html](http://who.org/GB/Journals/JHR/8/4/Berg433-481.html)); F. P. Berg, "*The German Delousing Chambers*", *JHR* 7(1) (1986), pp. 73-94 (online: [codoh.com/gcgv/gcgvtyph.html](http://codoh.com/gcgv/gcgvtyph.html)).

<sup>107</sup> E. Kogon *et al.* (eds.), *op. cit.* (note 25).

<sup>108</sup> *Chicago Jewish Sentinel*, Dec. 22, 1983.

<sup>109</sup> E. Kogon *et al.* (eds.), *op. cit.* (note 25), pp. 171f. Another claim in this book which indicates gasoline engines is that of E. Fuchs, from 1960: "*It was a heavy Russian gasoline engine (presumably a tank or tractor engine) with at least 200 hp (V-engine, 8 cylinders, water-cooled)*", p. 158, excerpted from papers of the Dortmund Public Prosecutor's Office, Ref. 45 Js 27/61 (Ref. ZSL: 208 AR-Z 251/59, v. 5, fol. 988). However, the Soviets only used Diesel engines for their powerful tank engines, cf. note 31.

<sup>110</sup> Testimony by Prof. W. Pfannenstiel, around 1960, excerpted from papers of the Munich I Public Prosecutor's Office, Ref. 22 Js 64-83/61 (Ref. ZSL: 208 AR-Z 252/59, v. 1, fol. 135ff.), quoted from: E. Kogon *et al.*, *op. cit.* (note 25), p. 173. Cf. note 21.

fuel was, of course, left to the reader's imagination. The fact is that *any gasoline engine simply would not operate with Diesel fuel – and vice versa.*

A fatal flaw in the non-Diesel version of the CO murder story is the recurrent claim that the corpses were “blue.” Death from gasoline engine exhaust would ‘only’ have been due to carbon monoxide and could ‘only’ have caused a distinctive cherry red or pink appearance. Although Pfannenstiel’s post-war testimony is not nearly as wild as the Gerstein Statement, nonetheless, he and other so-called eyewitnesses also repeated the claim that the corpses were “blue.”<sup>111</sup>

That the Gerstein Statement, even in a severely and fraudulently abbreviated form, was included in *Massentötungen* at all only shows how desperate the Holocaust scholars are to scrape together anything and everything in support of their monstrous fantasy. The new ‘revised’ version of the Holocaust story is even more absurd than the old version. Although an engineer might mistake a gasoline engine for a Diesel engine, how could anyone mistake red for blue? Perhaps they were all color-blind?

The Diesel gas chamber claim is rubbish – apparently some of the exterminationists including Raul Hilberg recognize that now. However, the alternate claim that gasoline engine exhaust was used instead is rubbish also, since it contradicts the only evidence that is available, namely the contradictory statements of the witnesses. For this reason, the Holocaust pundits have recently returned to the old story: the 1993 *Enzyklopädie des Holocaust*<sup>112</sup> agrees with the Jerusalem verdict<sup>113</sup> about Demjanjuk’s alleged crimes in Treblinka as well as with the findings of German courts:<sup>114</sup> They were Diesel engines!<sup>115</sup>

### 13. Conclusion

Although it would have been theoretically possible to commit the deeds alleged for Treblinka, Belzec, and Sobibor with Diesel engines, it would have required an inordinate amount of expertise and determination as well as technical apparatus to impose or simulate sufficient load on the Diesel engines. Such expertise is not even remotely indicated by the eyewitness testimony or by any other evidence. Even if all the necessary conditions had been met, the would-be murderers would ultimately

<sup>111</sup> E.g., his testimony on June 6, 1950, before a Darmstadt court, quoted from Saul Friedländer, *Counterfeit Nazi: The Ambiguity of Good*, Weidenfeld and Nicolson, London 1967, p. 118; cf. also, e.g., K. A. Schluch, around 1960, excerpted from documents of the Munich I Public Prosecutor’s Office, Ref. 22 Js 64-83/61 (Ref. ZSL: 208 AR-Z 252/59, v. VIII, fol. 1511), quoted from: E. Kogon *et al.* (eds.), *op. cit.* (note 25), p. 168; cf. A. Rückerl (ed.), *Nationalsozialistische Vernichtungslager im Spiegel deutscher Strafprozesse*, dtv, Munich 1978, p. 142; for a more in-depth analysis of the dilemma faced to this day by every German who ever had anything even remotely to do with one of the camps – Treblinka, Belzec and Sobibor were in fact more transit camps than concentration camps – see W. Lindsey, *op. cit.* (note 13), as well as the chapter by M. Köhler, this volume.

<sup>112</sup> E. Jäckel, P. Longerich, J. H. Schoeps (eds.), *Enzyklopädie des Holocaust*, 3 vols., Argon, Berlin 1993, entries for “Aktion Reinhard”, v. 1, p. 15 “Benzin oder Dieselmotoren” (Gasoline or Diesel Engines), “Belzec”, v. 1, p. 176 “Dieselmotor mit 250 PS” (Diesel engine with 250 hp), “Sobibor”, v. 3, p. 1332 “200 PS-Motor” (Engine with 200 hp), “Treblinka”, v. 3, p. 1428 “Dieselmotor” (Diesel engine), “Gaskammer” (Gas chamber), v. 1, p. 505 “Dieselauspuffgas [...] in den Vernichtungslagern im Generalgouvernement” (Diesel exhaust ... in the extermination camps in the General Government) and “Vernichtungslager” (Extermination camps), v. 3, p. 1496: “These extermination camps [Belzec, Sobibor, Treblinka] used carbon monoxide gas produced by Diesel engines.” According to this source, the Sobibor camp (250,000 victims) is the only case where there is any uncertainty regarding the engine type. In Belzec (600,000 victims) and Treblinka (700,000 to 1,200,000 victims) they were definitely Diesel engines.

<sup>113</sup> Jerusalem District Court, Criminal Case No. 373/86, verdict against Ivan (John) Demjanjuk, p. 2: “Diesel motors”, p. 7: SU-tanks: V12 Diesel engines with 500/550 hp.

<sup>114</sup> A. Rückerl (ed.), *op. cit.* (note 111), pp. 61, 64, 133 (re. Belzec); 203f., 226 (re. Treblinka); regarding Sobibor there is talk of gasoline engines: pp. 108, 165, 200; cf. the verdict of the Munich I District Court, Ref. 110 Ks 3/64 (Belzec) and the verdicts of the Düsseldorf District Court, Ref. 8 I Ks 2/64 and 8 Ks 1/69 against K. Franz and F. P. Stangl (both Treblinka), in H. Lichtenstein, *Im Namen des Volkes?*, Bund, Cologne 1984, pp. 187f. (death after 15 minutes due to Diesel exhaust gas in gas-tight chamber in Belzec), p. 201 (3 screwed-down Diesel engines in Treblinka).

<sup>115</sup> The chemist J. Bailer also fervently defends the Diesel version, although he plays with a stacked deck, cf. note 6. The same goes for Martin Pägert, *op. cit.* (note 59).



Illustration 10: New Russian Word admits frankly: The Revisionists have the “air superiority”; Diesel exhaust is unsuitable for mass murder! Here the issue of February 28, 1995: “Ideology Holocaust” (Проверка Катастрофой)

have had an arrangement which at best (worst?) would still have been only marginally effective at its morbid task. It would be hard to imagine a mass murder method more awkward and more inefficient. Even if some deranged minds had tried for a time to commit murder with Diesel exhaust, after a few tries it would have become apparent to even the most demented fiend that something far better was needed. The idea that the National Socialists actually used such a method not just for a few fiendish experiments, but continually over many months in several different locations is too preposterous. It never happened!

If the National Socialists had ever intended to commit mass murder with CO, they would doubtless have used the ubiquitous producer gas technology. 500,000 producer gas vehicles are the incontrovertible evidence that the Diesel claim is totally absurd.

According to *Novoje Russkoje Slowo* (*New Russian Word*),<sup>116</sup> a New York daily newspaper edited by and for emigrated Russian Jews, the world’s most renowned Holocaust historian Prof. Raul Hilberg made the following statement:

*“The Nazis did not manufacture soap from human fat, and did not kill their victims with Diesel exhaust. All these rumors were circulated in 1942, but we have the duty to thoroughly separate these rumors and fabrications from the facts and truth. Little lies provide fodder for the deniers and act against us.”*

The absence of credible evidence will continue to drive revisionism long after the current crop of revisionists has gone. Ultimately, the purveyors of the National Socialist homicidal gassing claims condemn themselves. The German officials who suppress, even with imprisonment, the least expression of doubt about the gassing claims condemn themselves as well.

<sup>116</sup> Y. Manin, *Novoje Russkoje Slowo*, February 26-29, 1995; regarding more details about this article: M. Dragan, “Revisionisten haben Luftüberlegenheit”, *Vierteljahreshefte für freie Geschichtsforschung*, 1(3) (1997), p. 138 (online: vho.org/VffG/1997/3/Dragan3.html).



# The Treblinka Holocaust

ARNULF NEUMAIER<sup>1</sup>

“Achieving our quest of a ‘new world order’  
depends on our learning the Holocaust’s lessons.”

Ian J. Kagedan<sup>2</sup>

## 1. The Demjanjuk Trial and Treblinka

### 1.1. Background of the Demjanjuk Trial

In the days of the Soviet Union, the American immigrants from Ukraine were split into two factions, one of which was favorably disposed towards Moscow. At that time, this group published a weekly paper titled *News from Ukraine*. Michael Hanusiak, one of the participants in this publishing venture, made no bones about his close ties to Soviet authorities in Moscow. H. P. Rullmann believes that one of the foremost tasks of this group was the defamation of the anti-Communist, nationalist Ukrainians in exile, whom they charged with collaboration with the ‘German Fascists’ during the Second World War.<sup>3</sup> This approach had already been practiced in other cases, which not only resulted in the creation of internal strife amongst these Ukrainians-in-exile but also detracted from their collective public reputation.<sup>4</sup> This Soviet method of combating opponents by means of disinformation and falsified or completely fabricated evidence is well-known. In the mid-1980s even the Federal Department of the Interior issued a warning regarding this practice.<sup>5</sup> It is all the more astonishing that the American authorities were taken in by the Communist Ukrainians-in-exile in the case of Demjanjuk in the mid-1970s.

In 1975, after allegedly in-depth research in Soviet archives, Michael Hanusiak submitted to the US Department of Immigration and Naturalization in New York, a list with 70 names of presumed National Socialist collaborators of Ukrainian origin; this list also included the name of John Demjanjuk, who until 1981 was an American citizen living in Cleveland, Ohio, where he worked as auto mechanic. In the case of Demjanjuk, Hanusiak came up with an incriminating statement by one H. Daniltschenko, according to whom Demjanjuk had served in the concentration camps Sobibor and Flossenbürg.<sup>6</sup> This, along with a picture of an ID card allegedly documenting Demjanjuk’s employment in these two camps, prompted the American Immigration and Naturalization Office to take up the case of John Demjanjuk.<sup>7</sup> The role which pro-Communist Hanusiak played in building Demjanjuk up to be Ivan the Terrible can hardly be misinterpreted. The true instigators of what was

---

<sup>1</sup> Arnulf Neumaier died in 2000. Three years after his death, Carlo Mattogno and Jürgen Graf published a thorough study of the Treblinka camp with numerous documents which were unknown to Neumaier: *Treblinka. Vernichtungslager oder Durchgangslager?*, Castle Hill Publisher, Hastings 2002 (online: [vho.org/D/Treblinka](http://vho.org/D/Treblinka)). This book will soon appear in English at Theses & Dissertations Press. Some of the more important new findings of Mattogno and Graf were included in this revised edition of Neumaier’s contribution.

<sup>2</sup> Director of government relations for B’nai B’rith Canada, “*Memory of Holocaust central to new world order*”, *Toronto Star*, Nov. 26, 1991, p. A17.

<sup>3</sup> H. P. Rullmann, *Der Fall Demjanjuk*, Verlag für ganzheitliche Forschung und Kultur, Struckum 1987, p. 76.

<sup>4</sup> Cf. the cases of K. Linnas, F. Wallus and Feodor Fedorenko: H. P. Rullmann, *op. cit.* (note 3), pp. 87, 96ff., 164; U. Walendy, *Historische Tatsachen (HT)* no. 25, Verlag für Volkstum und Zeitgeschichtsforschung, Vlotho 1985, p. 35 (Wallus); U. Walendy, *HT* 34, *ibid.*, 1988, p. 14 (Linnas).

<sup>5</sup> Memo of the Federal Minister of the Interior, *Innere Sicherheit* no. 1, Bonn, March 20, 1985.

<sup>6</sup> H. P. Rullmann, *op. cit.* (note 3), p. 77f., from *News from Ukraine*.

<sup>7</sup> Cf. memo from H. E. Wagner, Deputy Director of the Immigration and Naturalization Service, New York, Jan. 29, 1976.



in effect a new Eichmann Trial are not difficult to discern behind the scenes. After the *News from Ukraine* urged the American authorities in 1976 to take steps against Demjanjuk, the American Department of Justice requested that Demjanjuk be stripped of his citizenship due to false claims made in his immigration papers. Meanwhile, witnesses were found in Israel who identified John Demjanjuk on photographs as being Ivan the Terrible of Treblinka. Investigations regarding Sobibor as well as Treblinka followed. In 1979 the case was officially taken up by the OSI (Office of Special Investigations), the American ‘Nazi-hunting’ office set up under President Carter.

However, the Trawniki ID card No. 1393, issued to the name Demjanjuk, which had been reprinted in the *News from Ukraine* and later became the only piece of documentary evidence used in the trial, exists in two variations: the second card numbered 1393 and bearing the name Demjanjuk belongs to the papers of the concentration camp Flossenbürg, which are held in the Federal Archives in Koblenz. Similar names are very common in the Ukraine. But timewise the number does not correspond to Demjanjuk’s stay in Trawniki. – Furthermore, ID numbers were only used once.

The ‘original ID card’ was not available for the pre-trial investigations in Jerusalem. This central piece of evidence was clearly not officially available from the Soviet Union, for which reason Armand Hammer, the American billionaire of Jewish extraction, was called in. Hammer had already enjoyed an extremely good business relationship with Soviet circles in Lenin’s time.<sup>8</sup> In any case the Trawniki ID card did not get to Jerusalem through official channels, but personally via Armand Hammer. If the ID card were officially released, appropriate papers would have been present both in Moscow and in Israel.

Dieter Lehner, the expert from the Demjanjuk defense team, has exposed the ID card as a total fabrication,<sup>9</sup> a discovery matching those of the German Federal Criminal Police Office. Even though the Israeli authorities were already apprised of this fact by the Federal Criminal Police as early as 1987, the Court suppressed this information. Chief Prosecutor Michael Shaddek commented merely:

“As far as I am concerned Demjanjuk did commit murders – whether in Treblinka, in Sobibor or elsewhere, that’s secondary.”

And in response to the objection that the Federal Criminal Police Office had proven the SS ID card to be fake:

“We are relying on our own expert reports and consider them no less convincing than before.”<sup>10</sup>

But German authorities also played a strange game where the forged Trawniki ID card was concerned. For example, the *Münchener Merkur* reported that the Federal Chancellery itself saw to it that the Demjanjuk defense team did not learn of the German expert reports by Lehner and the German Federal Criminal Police Office [*Bundeskriminalamt*, BKA], and that the latter was ordered from higher-up to keep silent about its findings. And what is more: the expert witness from the BKA who did ultimately take the stand in the Jerusalem Court after all, had been instructed by the German authorities to draw up a partial report for this trial, dealing exclusively with certain similarities between the retouched ID card photo and John Demjanjuk’s real-life features. In this way the impression was evoked in the Jerusalem Trial that the ID card was genuine. The partial report was submitted by BKA expert Dr. Altmann. In a memo he drew up at that time, BKA Department Chief Dr. Werner described these actions of the German authorities thus:

“Clearly, factual doubts had to be subordinate to the political considerations.”<sup>11</sup>

---

<sup>8</sup> Cf. A. Hammer’s correspondence, in H. P. Rullmann, *op. cit.* (note 3), p. 87ff.

<sup>9</sup> D. Lehner, *Du sollst nicht falsch Zeugnis geben*, Vowinkel, Berg am See n.d. [1988]; cf. H. P. Rullmann, *op. cit.* (note 3), p. 103ff.

<sup>10</sup> *stern*, March 5, 1992, pp. 198ff.

<sup>11</sup> For details cf. A. Melzer, “*Iwan der Schreckliche oder John Demjanjuk, Justizirrtum? Justizskandal!*”, *SemitTimes*, spec. ed., Dreieich, March 1992, esp. pp. 3, 13; also *Münchener Merkur*, March 26, 1992. I am grateful to D. Lehner for further information, cf. *op. cit.* (note 9).

It has turned out that the photograph on the ID card is an old photo of Demjanjuk from 1947 which was taken from his American immigration file(!) and retouched for the ID card.

When the first doubts were raised about the authenticity of the heretofore unknown ID card, the Jerusalem Court suddenly had several other specimens of identical make on hand; the origin of these cards, which were also fabrications, has not been determined.<sup>9</sup>

The supposition that the KGB might have officially fabricated the ID card is largely refuted by the poor quality of the fabrication and by the ignorance, shown by the card, of the administrative structure of that branch of the police that was responsible for issuing this kind of ID card, as expert Lehner was able to demonstrate convincingly.<sup>9</sup> This does not, however, rule out that a certain circle within the KGB contributed to the fabrication of the card, a circle which must also have had connections to the American immigration authorities, where the photo originated. These circles are in all probability identical to those who worked from the start to set Demjanjuk up as Ivan the Terrible in order to revitalize the Holocaust Religion.

The proceedings to expatriate Demjanjuk began in 1981 before the Cleveland District Court. Naturally, five survivors of Treblinka recognized Demjanjuk as Ivan the Terrible, and the Court's copies of the Trawniki ID card No. 1393 became the chief piece of evidence on whose basis judge Battisti stripped Demjanjuk of his American citizenship.<sup>12</sup>

On the request of Israel, deportation proceedings began in 1984, and the deportation itself followed in February 1986, in violation of all traditions of international law, as the alleged site of the crime (Treblinka) was located in Poland, and at a time when the state of Israel did not yet even exist. How very important this Trawniki ID card was to the OSI in this trial is demonstrated by the fact that the OSI, together with Israeli authorities, attempted to persuade a number of witnesses to confirm the authenticity of this fabricated card against their better knowledge.<sup>13</sup>

## 1.2. The Demjanjuk Trial in Jerusalem

With the start of the Demjanjuk Trial in Jerusalem on February 16, 1987, the Treblinka Holocaust was restored to the active memory of the world public. According to the testimony of Jewish witnesses, Treblinka had been a World War Two extermination camp where vast numbers of Jews were killed – between 700,000 and 3 million, depending on the source consulted.<sup>14</sup> The Jerusalem Court decided arbitrarily to set the number of victims at 875,000.<sup>15</sup>

The intended linchpin in this revival of the Treblinka Holocaust was the Ukrainian John Demjanjuk. This man was declared to be “*Ivan the Terrible*” of Treblinka where he was said to have committed every means of killing, cruelties and perversions imaginable. Not enough that he allegedly drove the Jews into the gas chambers personally, armed with iron canes and a sword, and cut off women's breasts with the bayonet – no, he also operated the Diesel engines whose exhaust gas was piped into the gas chambers, there to kill the Jews. The fact that these claims contradicted the sole alleged documentary proof, which indicated that Demjanjuk had been employed in the camps Sobibor and Flossenbürg (and only in those camps) – this fact was generously overlooked.

The chief witness for the prosecution in the Jerusalem Trial, Eliahu Rosenberg, had stated in Vienna on December 24, 1947, in a “*fact report*” whose twelve pages he had each initialed personally, that the Ukrainian Ivan had been clubbed to death in his sleep.<sup>16</sup> When Demjanjuk's defense attorney Dov Eitan pointed out to Rosenberg during the Jerusalem Trial that John Demjanjuk, present

<sup>12</sup> Personal info. D. Lehner, July 26, 1993.

<sup>13</sup> H. P. Rullmann, *op. cit.* (note 3), pp. 118ff., 174ff.

<sup>14</sup> 700,000 is the figure cited, for ex., by the *Institut für Zeitgeschichte*; cf. the chapter by G. Rudolf, this volume; the highest figure is given in World Jewish Congress *et al.* (eds.), *The Black Book – The Nazi Crime against the Jewish People*, New York 1946, reprint: Nexus Press, New York 1981, pp. 400ff.

<sup>15</sup> Jerusalem District Court, Criminal Case 373/86.

<sup>16</sup> E. Rosenberg, *Tatsachenbericht*, Jewish Historical Documentation, Dec. 24, 1947; pub. in H. P. Rullmann, *op. cit.* (note 3), pp. 133ff.

there in the courtroom, could not be Ivan the Terrible, since according to his – Rosenberg’s – own testimony Ivan was already dead since 1943, Rosenberg said that this had been a misunderstanding on the part of the secretary recording his report at the time, and that he had had only third-hand knowledge of the death of Ivan the Terrible. The secretary in question, T. Friedman, refused to testify on this issue, since Jewish sources had threatened him with death in the event that he were to confirm that Rosenberg had really reported the death of Ivan the Terrible as his own personal experience at the time in question.<sup>17</sup> Clearly, therefore, Rosenberg had really affirmed Ivan’s death under oath.

So had Ivan the Terrible been resurrected?

It is characteristic of the psyche and the mental state of this kind of witness to substantiate alleged mistakes with the wish for a specific reality; the truth is subordinated to intentions and wishes. Regarding the motives prompting the state of Israel to hold this trial, Jewish publisher A. Melzer wrote that in the mid-1980s the collective Israeli awareness of the Holocaust was on the wane. It had become little more than one chapter among many. Further, the view taken of the Jews by the world public at that time was becoming increasingly shaped by the actions of the Israelis towards the Palestinians, which began to be likened to those of Himmler’s SS. This was probably the reason why the proceedings in the Jerusalem District Court dealt less with the case of John Demjanjuk than, essentially, with the total destruction of the Jews in Europe. The ‘Auschwitz Cudgel’ was in need of exercising.<sup>18</sup>

Ever since the mid-1970s, Ivan the Terrible, personified by John Demjanjuk, was systematically built up to be a symbol of the Treblinka Holocaust. The circumstance that the Monster of Treblinka had to be a Ukrainian probably has historical roots in the time when the Cossacks liberated the western part of the Ukraine from Jewish oppressors and tax-collectors.<sup>19</sup> Oaths of vengeance and instinctive hatred à la the Old Testament survive for centuries.

Two revealing circumstances may aid in the further assessment of the events and connections relating to the Trawniki ID card.

One rather strange event took place in Jerusalem on November 29, 1988. On November 20, 1988, Demjanjuk’s attorney, Dov Eitan, had received a comprehensive report from the subject expert for the defense, a report which proved conclusively that the chief piece of evidence against Demjanjuk, the Trawniki ID card, was a fabrication. For the December 4, 1988, appeal date Eitan had announced a surprise for the Jerusalem Court, but mysteriously fell out of a 15th story window of the Eilon Hotel on November 29, 1988.<sup>20</sup> Dov Eitan’s (un?)timely death was never solved. At his funeral, the second defense attorney was attacked by someone who threw acid in his face.<sup>21</sup>

Incidentally, the ID card no longer played a significant part in the verdict that was handed down against Demjanjuk in April 1988, whereas it had been a vital element in his extradition to Israel. The Jerusalem Court pointed out that it had been the witnesses, first and foremost, who had proven Demjanjuk’s guilt beyond a doubt. But the testimony of those witnesses was of far more questionable evidential value, as Dr. Elisabeth Loftus, Jewish-American expert on eyewitness testimony, noted; Loftus had previously all but proven the unbelievable nature of witness testimony in hundreds of trials.<sup>22</sup> Many of the witnesses against Demjanjuk contradicted not only themselves or at least their

---

<sup>17</sup> *Ibid.*, pp. 132, 145.

<sup>18</sup> Cf. A. Melzer, *op. cit.* (note 11).

<sup>19</sup> Cf. S. T. Possony, “*The Ukrainian-Jewish Problem: Historical Retrospective*”, *Ukrainian Quarterly* 2 (1975), pp. 141ff.

<sup>20</sup> *United Press International*, Nov. 30, 1988, p. 2; cf. *Annales d’Histoire Révisionniste (AHR)* 6 (1988/89), p. 167.

<sup>21</sup> *United Press International*, Dec. 2, 1988, p. 2; cf. *AHR* 6 (1988/89), p. 167; Demjanjuk’s second defense attorney has published the entire scandal surrounding this trial: Yoram Sheftel, *The Demjanjuk Affair. The Rise and Fall of the Show Trial*, Victor Gollancz, London 1994. This book is highly recommended.

<sup>22</sup> E. Loftus, K. Ketcham, *Witness for the Defense*, St. Martin’s Press, New York 1991; cf. J. Cobden, *JHR* 11(2) (1991), pp. 238-249 (online: [vho.org/GB/Journals/JHR/11/2/Cobden238-249.html](http://vho.org/GB/Journals/JHR/11/2/Cobden238-249.html)); more general: E. Loftus, K.

earlier statements, but also usually recounted utterly incredible, even downright grotesquely unrealistic scenarios. The decisive factor for Dr. Loftus was that some of the witnesses, due to their advanced age, could barely recall the names of their own children, or how they had only just arrived in the courtroom, while professing to be perfectly capable of identifying John Demjanjuk and to remember all the details of the events in the Treblinka camp or elsewhere. Even though Dr. Loftus realized that the media hullabaloo about John Demjanjuk, about the Treblinka camp and about the eyewitness testimony given in the past few decades rendered impartial, uninfluenced, probative testimony impossible, she refused to make her services as expert witness available to the defense, since she wanted to be on Israel's and the Jews' side in this trial even though she was aware that in doing so she was deliberately opposing justice and truth. Her acknowledgement of the error she thus committed is devastating and well worth reading.

Aside from the manipulation of witnesses already mentioned, H. P. Rullmann tells of the many and varied insults, suspicions and threats hurled at witnesses for the defense, going as far as the arrests of those witnesses;<sup>23</sup> of orders issued by the Court to 'go easy' on the witnesses for the prosecution, in other words, not to analyze or cross-examine their testimony;<sup>24</sup> of unchecked applause etc. by court spectators when witnesses for the prosecution made incredible and grotesque, incriminating statements;<sup>24</sup> of the live television broadcasting of the trial in Israeli schools as well as the worldwide broadcasting of trial highlights;<sup>25</sup> of the interpretation of Demjanjuk's profession of innocence as stubborn denial motivated by a lack of remorse.<sup>26</sup> The ultimate high point of the trial was the verdict, which had been based exclusively on eyewitness testimony: it sentenced Demjanjuk to death by hanging and prompted an almost Purim-fest-like joyful dancing in the courtroom. Of course Demjanjuk's defense appealed this sentence.

The public statements of Elisabeth Loftus, one of the best-known experts on eyewitness testimony anywhere, already sufficed to discomfit the Jerusalem court responsible for Demjanjuk's appeal, since it had to expect that appeal proceedings would not only expose the SS ID card as fake, but also that the witnesses would be shown up to be perjured liars, and by a Jewish expert, no less! But by the early 1990s the case had taken on even far more interesting and, for Israel, more unpleasant aspects. In view of the fact that Demjanjuk's expatriation and extradition had been obtained by fraud, by means of a faked ID card, an increasingly powerful lobby group in the United States began to speak out for the reversal of the Jerusalem verdict as well as for Demjanjuk's return and repatriation to the States, since Israel was obviously not willing or able to conduct a lawful trial against a former American citizen.

The American Member of Congress, James V. Traficant, and Patrick Buchanan, one of the best-known American journalists, and assistant to President Reagan, numbered among the most active of these lobbyists. As early as 1986 Buchanan had called the trial of Demjanjuk a new Dreyfus Affair.<sup>27</sup> But in early 1990 Buchanan went a considerable step farther when, regarding Demjanjuk's alleged mass murders in Treblinka, he wrote in *The Washington Times* and *The New York Post*:<sup>28</sup>

*"The problem is: Diesel engines do not emit enough carbon monoxide to kill anybody. The Environmental Protection Agency never requires emission inspections of Diesel cars or trucks. In 1988, ninety-seven youths, trapped 400 feet underground in a D.C. tunnel, while two locomotives spewed Diesel exhaust into the car, emerged unharmed after forty-five minutes. Demjanjuk's weapon of mass murder cannot kill."*

---

Ketcham, *The Myth of Repressed Memory*, *ibid.*, 1994; in abbreviated form: E. Loftus, "Creating False Memories", *Scientific American*, Sept. 1997, pp. 50-55.

<sup>23</sup> H. P. Rullmann, *op. cit.* (note 3), pp. 23, 100, 124, 145, 191.

<sup>24</sup> *Ibid.*, p. 19.

<sup>25</sup> *Ibid.*, pp. 17, 21.

<sup>26</sup> *Ibid.*, p. 26.

<sup>27</sup> *The Plain Dealer* (Cleveland/Ohio), Oct. 1, 1986; cf. H. P. Rullmann, *op. cit.* (note 3), p. 26.

<sup>28</sup> *New York Post*, March 17, 1990; *The Washington Times*, March 19, 1990; *The New Republic*, Oct. 22, 1990.

In 1991 Pat Buchanan was George Bush sen.'s strongest Republican rival in the primaries for the American presidency. He did not deviate from his conviction even during these election campaigns. On television he even supplemented his previous statements by saying that Treblinka had no doubt been a terrible place where hundreds of thousands of Jews had been taken and where *thousands* had died – in other words, not hundreds of thousands, as was alleged!<sup>29</sup> So Israel saw itself faced with a powerful current in American politics and journalism which was not only close to providing the next President of the United States but which also disputed that Treblinka had been an extermination camp.

At the same time as these developments, several eastern European émigrés groups drew up reports in defense of John Demjanjuk, and concluded on the basis of substantial evidence that no mass murder could have taken place in Treblinka and that even for this reason alone, John Demjanjuk must be innocent, as must any other accused.<sup>30</sup>

Only someone who was unaware of these events could have been surprised when the Jerusalem Appeal Court announced Demjanjuk's acquittal in the summer of 1993.<sup>31</sup> Demjanjuk was acquitted for lack of precisely that so-called evidence that had resulted in his death sentence before. Strangely enough, most of the American and all of the European media then proceeded to laud Israel as a state truly under the rule of law – even though the administration of justice in the Demjanjuk Trial had not measured up even remotely to any such standard. The gulf between a death sentence and an acquittal is too great. But if perchance the Court had realized that it was the false statements of the witnesses that had resulted in a miscarriage of justice, then the witnesses ought now to have been charged. But this was not done. For a time it was even debated in Israel whether one should not perhaps charge Demjanjuk for crimes he may have committed in the camps Sobibor and Flossenbürg, but eventually this option was rejected.<sup>32</sup> The iron had grown too hot for Israel, since any further trial could have resulted in other aspects of the Holocaust being drawn into undesirably controversial discussion. It is also possible that the collapse of the Soviet Union gave rise to factors – such as easier access to archives and to the supposed sites of the crimes – which made it more advisable to send Demjanjuk back to the United States in September 1993, acquitted, but nevertheless unlawfully handcuffed during his trip home.<sup>33</sup> In 1998, John Demjanjuk received his U.S. citizenship back,<sup>34</sup> only to have it revoked again in early 2002 after the OSI claimed that Demjanjuk allegedly was a guard in the camps of Sobibor, Majdanek, and Flossenbürg.<sup>35</sup>

Will the trial of John Demjanjuk become, in a sense, the writing on the wall? Will it bring a turning point in the Treblinka Holocaust, in the 'immolation of the Jews' as a whole? As the Prophet Daniel put it in Daniel 5: "*mene, tekel, u-pharsin*" – or, in English, 'weighed in the balances, and found wanting'.

## 2. The Camps in the Treblinka Area

In an analysis of the eyewitness testimony and accounts existing with regard to the Treblinka group of camps, the first thing one notices is that they are completely contradictory of each other. The witness claims diverge so widely – not only where the numbers of victims are concerned, but also with respect to the alleged methods of killing, about the way the bodies and evidence were

---

<sup>29</sup> "The Week with David Brinkley", *ABC Television*, Sunday, Dec. 8, 1991.

<sup>30</sup> T. Skowron, *Amicus Curiae Brief*, Polish Historical Society, PO Box 8024, Stamford, CT 06905, 1992; similar efforts were undertaken by the Ukrainian Friends of Fairfield Association, *ibid.*, which, however, is probably to some extent identical to the Polish Historical Society. (Online: [vho.org/GB/c/AmicusCuriaeDemjanjuk.html](http://vho.org/GB/c/AmicusCuriaeDemjanjuk.html))

<sup>31</sup> The daily press of July 30, 1993.

<sup>32</sup> *Die Welt*, Aug. 2, 1993.

<sup>33</sup> For the history of the Demjanjuk Trial, cf. J. A. Brentar, *JHR* 13(6) (1993), pp. 2-8; J. Sobran, *JHR* 13(6) (1993), pp. 9f..

<sup>34</sup> *The Plain Dealer*, Cleveland, Feb. 21, 1998.

<sup>35</sup> *CNN*, Feb 21, 2002; [www.cnn.com/2002/LAW/02/21/demjanjuk.citizenship/](http://www.cnn.com/2002/LAW/02/21/demjanjuk.citizenship/); cf. *AP*, March 14, 2000.

eliminated, and about the location, size, form and equipment of the alleged extermination camp – that it is impossible to cull a plausible overall account from this material.<sup>36</sup> Udo Walendy has drawn up a detailed study of these contradictions and inconsistencies, to which readers interested in specifics are referred.<sup>37</sup> We shall touch on only the grossest discrepancies here and will then focus on the scenario on which the Holocaust-dogmatists have agreed after a 50-year process of evolution and selection from among the ‘usable eyewitness testimony’, even though such a practice by the establishment historians is devoid of any scientific value due to the selectivity with which the sources are treated.

## 2.1. The Malkinia Camp

Among the confused and mostly contradictory descriptions of the camp Treblinka II (*i.e.*, B) and the corresponding sketches of this camp,<sup>38</sup> which were also used in the Treblinka Trials of 1950-51, 1964-65 and 1969-70,<sup>39</sup> there is not one which clearly establishes that aside from the camp Treblinka I (A) and II (B), there was another camp, Malkinia, 3.7 miles north of Treblinka. This was a transit and delousing camp approximately 740' × 820' (607,000 sq.ft.) in size, probably for Jews being deported to destinations in Byelarus and Ukraine.

In prison, more than 15 years after the fact, Kurt Franz – the main defendant in the Treblinka Trial of 1965 – drew a sketch, from memory, of the camp where he had been employed as of November 1942.<sup>40</sup> This sketch could perforce not be correct in every detail, considering the many years of constant influencing that had gone by, but it differed entirely and not only in its external form from Treblinka II (B) as it is shown on an official Polish layout.<sup>41</sup> As we know today, the camp as described by the witnesses is a mixture of conditions and elements from the camps Treblinka II and Malkinia. A stunning confirmation of Franz’s camp sketch was found on an aerial photograph of May 13, 1944, which is held in the National Archives.<sup>42</sup> This camp is also the source of the terms ‘lower’ and ‘upper’ camp, as Franz had already marked on his sketch. The smaller ‘upper camp’ was separated from the ‘lower camp’ by a road. Franz was able to label the buildings in the camp and to mark his sketch with a large number of the surnames of the personnel in Malkinia, including his own surname, Franz, in relation to certain areas of the camp. The fact that many eyewitnesses describe *this* camp casts a rather dubious light on these witness statements, as the transit camp Malkinia has never been suspected of harboring an extermination center.

<sup>36</sup> For the most important witness accounts, cf. E. Klee, W. Dreßen, V. Rieß (eds.), *“Schöne Zeiten”*. *Judenmord aus der Sicht der Täter und Gaffer*, S. Fischer, Frankfurt/Main 1988; see also the works cited further on, as well as World Jewish Congress (ed.), *op. cit.* (note 14).

<sup>37</sup> U. Walendy, *Historische Tatsachen* no. 12: *“Das Recht, in dem wir leben”*, Verlag für Volkstum und Zeitgeschichtsforschung, Vlotho 1982, pp. 28-35; and esp.: *ibid.*, no. 44: *“Der Fall Treblinka”*, 1990.

<sup>38</sup> Some examples: H. P. Rullmann, *op. cit.* (note 3), p. 151; G. Sereny, *Am Abgrund*, Ullstein, Frankfurt/Main 1979, p. 154; R. Glazar, *Die Falle mit dem grünen Zaun*, Fischer, Frankfurt/Main 1992, p. 191; A. Donat (ed.), *The Death Camp Treblinka*, Holocaust Library, New York 1979, pp. 259 and 318f.; Y. Arad, *Belzec, Sobibor, Treblinka: The Operation Reinhard Death Camps*, University Press, Bloomington 1987, p. 39; E. Kogon, H. Langbein, A. Rückerl et.al. (eds.), *Nationalsozialistische Massentötungen durch Giftgas*, Fischer, Frankfurt/Main 1983, pp. 243f.; E. Jäckel, P. Longerich, H. J. Schoeps (eds.), *Enzyklopädie des Holocaust*, v. 3, Argon, Berlin 1993, p. 1431.

<sup>39</sup> District Court Frankfurt, Ref. 14/53 Ks 1/50; District Court Düsseldorf, Ref. 8 I Ks 2/64; *ibid.*, Ref. 8 Ks 1/69.

<sup>40</sup> Sketch by K. Franz, in U. Walendy, *“Der Fall Treblinka”*, *op. cit.* (note 37), p. 24; this also contains almost all the sketches mentioned in note 38, as well as those by R. Ainsztein, *Jewish Resistance in Nazi-occupied Eastern Europe*, Elek, London 1974, pp. 716ff. (p. 26).

<sup>41</sup> Camp sketch from the brochure *Vernichtungslager Treblinka*, Treblinka-Museum; U. Walendy, *“Der Fall Treblinka”*, *op. cit.* (note 37), p. 29.

<sup>42</sup> Ref. No. GX 72 F-933 SK, exp. 139; cf. the chapter by J. C. Ball, this volume, as well as J. C. Ball, *Air Photo Evidence*, Ball Resource Service Ltd., Delta, BC, 1992, p. 88.

## 2.2. The Treblinka II (B) Camp

Treblinka II has gone down in Holocaust history as an extermination camp, whereas the camp Treblinka I, closely associated with a gravel pit, has hardly figured in subject literature at all. Since it is beyond the scope of this study to analyze all the accounts that have been advanced with respect to Treblinka II, and since it is only our intent to consider the necessary prerequisites and consequences of the mass extermination alleged by the witnesses, we shall confine the following to the most striking points.

In a brochure from 1943 the World Jewish Congress reported that construction of a “slaughter house” for Jews from Poland and other European nations had begun in March 1942 in an area 12,350 acres in size.<sup>43</sup> It is hard to imagine that even people largely lacking in gray matter could seriously propose a camp almost 20 square miles in size, yet this figure nevertheless found its way into a prosecution document with the International Military Tribunal in Nuremberg.<sup>44</sup> This fact alone suffices to reveal the producer-directors of the extermination scenario of Treblinka II in a suspicious light.

This author has in his possession a copy of an official-looking plan of the camp Treblinka II (cf. *illustration 1*, next page), showing an archive number, two rubber stamps and a legend, but apparently no date. The scale of 1:2,000 is wrong, as this would result in only half the camp dimensions given. A camp sketch in a brochure of the Treblinka Museum shows the same shape as that on the official-looking plan, but gives a scale of 1:4,000. All camp sketches known to date exhibit more or less considerable deviations in detail. In terms of the points of the compass, the various maps agree with each other but not with the air photos of expert John C. Ball.<sup>45</sup>

T. Skowron has also shed some light on the state of these camp sketches, which were drawn up on the basis of eyewitness accounts; to date he has located more than 40 different sketches.<sup>46</sup>

## 2.3. The Origin of the Current Version of Treblinka

Treblinka II was situated in an area by no means particularly remote and it concealed few secrets. The train line leading from the village of Treblinka to Siedlce ran at a distance of all of 300 meters from the camp, parallel to the nearby road; scarcely two kilometers separated the camp from the hamlets of Wólka Okraglik in the east and Grady and Poniatowo in the west.<sup>47</sup> If one credits the testimony of eyewitnesses, lively contacts even existed between the camp inmates and the local populace, with which a flourishing barter trade flourished.<sup>48</sup> In fact, soon after the opening of the camp (July 23, 1942), information from it was reaching the outer world. This was essentially coming from Jews who had run away from Treblinka, from the populace which resided in the area surrounding the camp, as well as from the Polish railway workers who operated the trains with the deportees. In these reports, the following methods of killing were mentioned:

1. Exhaust gases of a motor in whose fuel “toxic substances” had been mixed (Report of the Polish underground newspaper *Informacja bieżąca*, October 5, 1942<sup>49</sup>).
2. A gas with a delayed effect, which enabled the victims to leave the gas chamber and walk to the mass graves; there they lost consciousness and fell into the graves (*Informacja Bieżąca*, September 8, 1942.<sup>50</sup>

---

<sup>43</sup> World Jewish Congress (ed.), *Lest we forget*, Spett Printing Co., New York 1943.

<sup>44</sup> International Military Tribunal, *Trial of the Major War Criminals*, IMT, Nuremberg 1947, v. III, p. 567; Document PS-3311.

<sup>45</sup> J. C. Ball, *Air Photo Evidence*, *op. cit.* (note 42).

<sup>46</sup> T. Skowron, *op. cit.* (note 30), pp. 29ff.

<sup>47</sup> *Atlas samochodowy Polski*, Warsaw/Breslau 1997.

<sup>48</sup> Testimony of Abraham Krzepicki and Samuel Willenberg, quoted in A. Donat (ed.), *op. cit.* (note 38), pp. 125, 192.

<sup>49</sup> Krystyna Marczevska, Władysław Ważniewski, “Treblinka w świetle Akt Delegatury Rządu na Kraj”, in: *Biuletyn Głównej Komisji Badania Zbrodni Hitlerowskich w Polsce*, vol XIX, Warsaw 1968, pp. 138ff.

<sup>50</sup> *Ibid.*, pp. 137ff.

3. A mobile gas chamber, which moved along the mass graves and unloaded the bodies into them (*Informacja bieżąca*, August 17, 1942).<sup>51</sup>
4. Shooting with machine guns (Report of the Resistance to the Polish government-in-exile in London, March 31, 1943).<sup>52</sup>
5. Quick lime in the trains; the deportees arrived in Treblinka as corpses and were buried there (further report of the Resistance to the Polish government-in-exile, March 31, 1943).<sup>52</sup>
6. Electric current (“*Ghetto Chronicle*” of Emmanuel Ringelblum, entry for October 15, 1942).<sup>53</sup>
7. Hot steam. This murder method was described in several reports and dominated propaganda concerning Treblinka up into 1944. Of capital importance in connection with this is an unusually detailed report dating from 15 November 1942, from the resistance movement of the Warsaw Ghetto with the title *Likwidacja żydowskiej Warszawy* (Liquidation of Jewish Warsaw), in which mass killing by means of steam is described as follows:<sup>54</sup>

*“It [the death house] is a walled building. [...] It consists only of three small chambers in addition to a boiler room. Along the North wall of this house runs a corridor from which one can enter the doors into the chambers. The exterior wall of the chambers possesses a flap-door (until a short while ago there was a door, which for practical reasons was replaced by a flap-door). In addition, a ramp in the shape of a baking trough runs up to the level of the flap-door. A boiler room is directly annexed to the building. Within the boiler room there is a large boiler for the production of water vapor and super-heated water vapor forces its way into the chambers by means of pipes which run through the death chambers and have the corresponding number of openings. [...] The floor in the chambers is slippery, people slide and fall over, but cannot stand up again, since new crowds of victims who have been violently driven inside roll on top of them, The commander [of the camp guards] flings small children onto the heads of the women in the chambers. In this way the execution chambers are filled to the bursting point, and then the doors are hermetically closed, and there begins slow suffocation of the people by the water vapor, which enters through the numerous openings in the pipes. In the beginning, choked-off screams break forth from inside, then gradually become weaker, and after 15 minutes the execution is finished.*”

*Now it’s the turn of the grave-diggers. With screaming and curses the German overseers drive the grave-diggers to work, which consists of pulling the corpses out of the execution chambers. The grave-diggers stand by the ramp, facing the flap-door. The flaps open but no corpses fall out. Under the influence of the steam, all of the bodies have formed a monolithic mass which is cemented together by the sweat of the murdered victims. In their death struggles, many hands, legs and trunks have become entwined in a macabre fashion. To make it possible for the grave-diggers to pull out individual bodies, pails of cold water are poured over this mass from out of the closest well. Now one body is separated from another and they can be easily removed. In general, the external aspect of the bodies has not changed; only the head and buttocks have darkened to violet. The grave-diggers, beaten and harried without respite by the Germans, put the bodies on the ramp until the chambers have been emptied.”*

According to this report, two million Jews had already been murdered in Treblinka by this method (thus, about 17,000 per day!); it said that after the Germans had begun to also kill non-Jewish Poles with steam, the entire population of Poland had “*the spectre of death in the steam chambers*” before its mind’s eye.

This report enjoyed wide circulation. A complete English translation appeared by the year 1943 in the omnibus volume *The Black Book of Polish Jewry*, and on August 8, 1943, the *New York Times*, in an article headlined “*2,000,000 Murders by Nazis Charged. Polish Paper in London says Jews*

<sup>51</sup> *Ibid.*, p. 136.

<sup>52</sup> *Ibid.*, pp. 153ff.

<sup>53</sup> Emmanuel Ringelblum, *Kronika getta warszawskiego*, edited by Artur Eisenbach, Czytelnik, Warsaw 1983, p. 416.

<sup>54</sup> The report is completely reproduced in K. Marczewska, W. Waźniewski, *op. cit.* (note 49), pp. 139-154. A German translation can be found in Mattogno, Graf, *op. cit.* (note 1), pp. 63-71.



*are Exterminated in Treblinka Death House,*” reported that according to information from Poland, two million Jews had been murdered in Treblinka by steam.

In 1944, the Rabbi Abraham Silberschein published an eight-page report in Geneva concerning Treblinka, which largely adopted the claims of the resistance movement of the Warsaw Ghetto, but which was nevertheless ambiguous with regard to the technique used to do the killing: on the one hand, Silberschein spoke of “*gas chambers*” and of “*gas which flows out of the pipes,*” but on the other hand, of how the corpses stuck to one another “*under the influence of the steam.*”<sup>55</sup>

For the orthodox ‘Holocaust’ historians, all of this is naturally most embarrassing, and many of them resort to shameless falsification of the historical sources. This is particularly true of the Israeli historian Yitzhak Arad, whose book *Belzec, Sobibor, Treblinka. The Operation Reinhard Death Camps*<sup>56</sup> is regarded as the standard work about these three camps. Arad mentions in it the report of November 15, 1942, but brazenly substitutes “*gas chambers*” for the embarrassing steam chambers!<sup>57</sup>

The suppression of the steam chambers in favor of gas chambers received its impetus from a report of the Jewish-Polish cabinetmaker Jankiel Wiernik, which first appeared in May 1944 in the Polish language but was then translated into English that same year.<sup>58</sup> Wiernik, who according to his statements had been interned in Treblinka for a year and had escaped from there, plagiarized in this text the report of the resistance movement of November 15, 1942, but replaced the steam chambers with gas chambers in every instance and mentioned a motor as the instrument, without, however, specifying that it had been a diesel motor. Evidently he believed – with good reason – that steam as a murder method was all too unbelievable.

Why the motor? In Treblinka there was certainly an electrical plant, since the camp was not connected to the local power supply. The generator of such a plant was customarily driven by a diesel motor. Since the exhaust fumes of such machinery have an atrocious odor, Wiernik, a layman with respect to the technical facts, obviously believed they made a suitable instrument for murder. After the Red Army had gained control over the area around Treblinka in August 1944, a Soviet investigatory commission quickly got to work and ‘determined’ that in Treblinka three million people had been killed. However, neither steam nor gas were now named as the method of murder, but instead suffocation by means of chambers which were vacuum-pumped.<sup>59</sup>

*“The ‘bath’ was a building which consisted of 12 compartments each of which were 6 meters x 6 meters in dimension. About 400 to 500 persons were driven into one compartment at the same time. They had two doors which could be hermetically sealed. In the corner, between ceiling and wall, were two openings connected with hoses. Behind the ‘bath’ stood a machine. It pumped the air out of the room. People suffocated in 6 to 10 minutes.”*

The Soviet-Jewish propagandist Vassily Grossmann entered the area of the former Treblinka camp in September 1944 and spoke with numerous witnesses who had already been questioned in advance by the Soviet investigatory commission. In his book *Die Hölle von Treblinka* (The Hell of Treblinka), which appeared in 1945, he wrote:<sup>60</sup>

*“The most diverse means were employed for the killing: the exhaust fumes of a heavy Panzer [armored tank] motor, which served the power station of Treblinka, were squeezed inside. [...] The second proce-*

<sup>55</sup> Abraham Silberschein, *Die Judenausrottung in Polen*, Geneve 1944, Third Series, pp. 33-40. Longer excerpts in Mattogno, Graf, *op. cit.* (note 1), pp. 72-77.

<sup>56</sup> Indiana University Press, Bloomington and Indianapolis 1987.

<sup>57</sup> *Ibid.*, p. 78.

<sup>58</sup> *A year in Treblinka*, published by American Representation of the General Jewish Workers’ Union of Poland, New York 1944. Also reproduced in A. Donat, *op. cit.* (note 38).

<sup>59</sup> Akt 24, August 1944, Gosudarstvenny Arkhiv Rossiskoi Federatsii (State Archive of the Russian Federation), Moscow, 7021-115-11, pp. 103ff.

<sup>60</sup> Wassili Grossmann, “*Die Hölle von Treblinka*”, in: *Die Vernichtungslager Majdanek und Treblinka*, Stern Verlag, Vienna 1945, pp. 49ff.

*...dure, which was used most often in Treblinka, was the pumping out of air from the chambers by means of special suction devices. [...] And finally, the third method, rarer but likewise employed, the murdering by steam, which also was based upon depriving the organism of oxygen."*

In addition to these three techniques, others were also described by witnesses. One of the best known of the Treblinka chief witnesses, Samuel Rayzman, on the occasion of being questioned by a Soviet military examining judge on 26 September 1944, stated that the killings in Treblinka were performed in the beginning "by means of evacuation of the air from the compartments," but then – according to Rayzman, –<sup>61</sup>

*"they resorted to another method – poisoning by chlorine gas and Zyklon gas."*

The quotations cited make clear the incredible chaos which prevailed among the witnesses at that time with respect to the technology of murder in Treblinka. In December 1945, the Polish government, in a report presented to the Nuremberg Tribunal, was still speaking of how in Treblinka several hundred thousand Jews had been exterminated by steam,<sup>62</sup> yet at approximately the same time, the Polish judge Zdzisław Łukasziewicz, head of a committee charged with the investigation of the events in Treblinka, opted for the motor-gas chambers, apparently because this seemed to him to be the most believable of the diverse murder instruments described by the witnesses.<sup>63</sup>

It is worth remarking that the technique for killing which was also claimed for the "extermination camp" Belzec during the war and during the immediate post-war period, does not agree with the version later sanctioned by the official historiography.

Various sources describe the methods for the alleged extermination camp Belzec, where, it is claimed, the victims were killed with electric current, on an enormous platform that could be submerged in water; the victims were then immediately incinerated, using electricity.<sup>64</sup> This account shows a complete lack of technical and scientific understanding; the excessive powers of imagination it attests to render an ordinary person speechless. We shall therefore dispense with a serious evaluation of it here, even though this tale was even accorded a hearing before the IMT.<sup>65</sup>

The version of the diesel exhaust chambers made its final successful breakthrough in 1951. That was when a book entitled *Bréviaire de la Haine* (Breviary of Hatred) appeared from the pen of the French-Jewish historian Léon Poliakov, which quickly became a classic of orthodox historiography. Poliakov cited a long excerpt there from the Gerstein report, and commented on it as follows:<sup>66</sup>

*"We do not need to add much to this description; it applies to Treblinka and Sobibor just as it does to the Belzec camp. The facilities were designed there quite similarly, and carbon monoxide produced by a diesel motor was the chosen method for administering death."*

In such a way were the steam and the suctioned-air chambers, as well as the various other murder methods hawked by the witnesses, finally consigned to the junkyard of history, and the diesel gas chambers of Treblinka, Belzec, and Sobibor became transmogrified into 'established historical facts.'

<sup>61</sup> URSS-337, p. 9 of the German version.

<sup>62</sup> PS-3311.

<sup>63</sup> URSS-344, p. 321.

<sup>64</sup> M. Tregenza, "Belzec Death Camp", *The Wiener Library*, 41-42 (1977), pp. 16f.; *Biuletyn Żydowskiego Instytutu Historycznego* (Warsaw) 9-10 (1954), p. 307; *Polish Fortnightly Review*, Dec. 1, 1942, p. 4; *New York Times*, Jan. 20, 1942, p. 23, and Feb. 12, 1944, p. 6; Documents of the Foreign Office, FO 371-30917-5365 and 371-30924-5365; World Jewish Congress *et. al.* (eds.), *The Black Book of Polish Jewry*, Roy Publishers, New York 1943, p. 131; A. Silberschein, *Die Judenausrottung in Polen*, manuscript, Geneva 1944, pp. 21f.; S. Szende, *Der letzte Jude in Polen*, Europa-Verlag, Zürich 1945, pp. 291f.; cf. also C. Mattogno, *AHR* 1 (1987), pp. 82ff.

<sup>65</sup> *IMT* v. VII, p. 576f.

<sup>66</sup> L. Poliakov, *Bréviaire de la Haine*, Calmann-Lévy, Paris 1951, p. 224.

### 3. The Extermination Camp Treblinka

According to the current (2003) teachings of the official ‘Holocaust’ thesis, a large part of the Polish Jews were deported to the extermination camp Treblinka as of the summer of 1942. Without first being registered in the camp, they were gassed in Diesel gas chambers, and buried in mass graves until winter. As of spring 1943, it is said, the gassing victims were immediately incinerated without leaving a trace, as were the exhumed bodies.<sup>67</sup> Allegedly this was done in pits several meters deep and very long (formerly these pits were ‘mass graves’), on a grating of steel girders supported by concrete pillars. In autumn 1943 the camp was razed to the ground and all evidence was eliminated. According to reports some 870,000 to 1.2 million Jews fell victim to this scenario.<sup>68</sup> But before examining details of this account, we shall first present a general overview of the matter.

#### 3.1. Generalities on the Site of the Crime and the Murder Weapons

Under normal circumstances, solving a crime involves criminological investigations in order to obtain irrefutable evidence with which to convict the criminal. Since eyewitness statements are frequently very imprecise, it is the task of the courts to establish the true state of the matter on the basis of incontrovertible facts and evidence. Murder ranks among the most heinous of crimes, which is why it is particularly necessary in such cases to precisely establish the relevant facts. In such a crime, the scene of the crime, the murder weapon, the course of events, the cause of death, and the motive are generally investigated in order to ascertain the identity of the murderer/s. The whereabouts of the victims is also of central importance.

If the victim of an alleged crime cannot be located, it is difficult if not downright impossible to prove that the crime took place. In murders with only one or at most a very few victims, the elimination of evidence may be possible, provided that the site of the crime and the method of eliminating the victims remain unknown. If, however, the number of victims is great, and if the site of their elimination is precisely documented cartographically and even recorded on aerial photographs, then given the standards of modern technology the crime can be established with absolute certainty. One need only recall, for example, that in the course of archaeological digs the discovery of ashes suffices to establish the presence of human settlements beyond any doubt even hundreds of thousands of years after the fact. To date forensic investigations of the Holocaust have been based almost exclusively on eyewitness testimony.<sup>69</sup> In only one single case is there a report of an excavation, which the Court of Siedlce had commissioned. This excavation was carried out in Treblinka II on November 9-13, 1945.<sup>70</sup> We shall touch on the results of this investigation a little later.

According to the expositions of the supporters of the Holocaust dogma, the deportation, internment and killing of the Jews during the Second World War was a systematic and methodical program for purposes of exterminating the European Jews. The supposedly methodical and systematic nature of this campaign requires that there was a plan providing for it. To date, however, the sources available to researchers have yielded no evidence for a plan or its systematic implementation – unless all or

---

<sup>67</sup> Some witnesses claim that the cremations began in autumn of 1942; cf. R. Glazar, *op. cit.* (note 38), p. 34.

<sup>68</sup> E. Jäckel et.al. (eds.), *op. cit.* (note 38), p. 1430: 0.87 million; W. Benz (ed.), *Dimension des Völkermords*, Oldenbourg, Munich 1991, p. 468: 1.2 million.

<sup>69</sup> The only exceptions are some more recent investigations, of Auschwitz in particular: F. A. Leuchter, *An Engineering Report on the alleged Execution Gas Chambers at Auschwitz, Birkenau and Majdanek, Poland*, Samisdat Publishers, Toronto 1988 (online: [www.zundelsite.org/english/leuchter/report1/leuchter.toc.html](http://www.zundelsite.org/english/leuchter/report1/leuchter.toc.html)); Ger.: F. A. Leuchter, *Der erste Leuchter Report*, *ibid.*; G. Rudolf, *The Rudolf Report*, Theses & Dissertations Press, Chicago, IL, March 2003 (online: [vho.org/GB/Books/trr](http://vho.org/GB/Books/trr)); cf. the chapter by G. Rudolf, this volume.

<sup>70</sup> Central Commission for Investigation of German Crimes in Poland, *German Crimes in Poland*, Howard Fertig, New York 1982; cf. U. Walendy, *Historische Tatsachen* no. 44: “*Der Fall Treblinka*”, *op. cit.* (note 37), p. 15. Walendy has recently reported about a hushed-up analysis of soil samples taken from the vicinity of the supposed mass cremations in Auschwitz, *Historische Tatsachen* no. 60: “*Naturwissenschaft ergänzt Geschichtsforschung*”, Verlag für Volkstum und Zeitgeschichtsforschung, Vlotho 1993, pp. 6ff.



ders and decrees that are supposed to have been issued with respect to the solution of the Jewish Question were in the form of a secret code. But even for this no evidence has been uncovered, for no source has yet been found which contained a definition of the codes comprising such a secret language; however, such a ‘Rosetta Stone’ would have been indispensable to ensure a proper understanding between the issuers and the receivers of the orders. It was and remains a characteristic habit of the Germans to organize and document every measure taken right down to the smallest detail, and this practice was particularly evident among the authorities of the Third Reich. The Holocaust dogmatists’ theory that the mass murder was guided by improvisation, coincidences and spontaneity, and even by a decision-making process based on mind-reading,<sup>71</sup> is utterly implausible and downright ludicrous, not only for Germany but on the whole.

### 3.2. Site of the Crime: the Upper Death Camp

As already mentioned, the dubious witness statements and the lack of any definite identification of the murder site by courts or commissions, as well as the commensurate efforts at securing evidence, preclude any exact and reliable reconstruction of the so-called site of the crime. The very fact that there are sketches of the site which show a rectangular camp area and others that show oblique-angled outlines with variant measurements compels one to view the matter with some doubt. Therefore it would seem best to regard as the alleged site of the crime, that camp ‘Treblinka II’ which is shown on an official looking ground plan and which appears on German aerial photographs from the year 1944.<sup>42</sup> According to the plan from the Treblinka Archives, the camp had an area of 1,447,200 sq.ft., as stated, and the so-called Extermination Area measured 193,700 sq.ft. Working from the air photos, the Extermination Area measured about 230 ft. × 295 ft., corresponding to an area of 67,800 sq.ft. According to the accounts at hand, the Extermination Area included the two buildings housing a total of 13 hermetically sealed gas chambers, as follows:<sup>72</sup> the first Death House, with three gas chambers of approximately 16 ft. × 16 ft. each (other claims allege 13 ft. × 13 ft.) and 8.5 ft. in height, was a concrete construction built in late summer and early autumn 1942. The second Death House, built a little later, had ten gas chambers and an area of 26 ft. × 13 ft. (other claims are 23 ft. × 23 ft.) per gas chamber, and was a stone building with a concrete foundation. Five gas chambers each flanked a 5 ft. wide corridor. The outer walls had gas-tight trap doors that could be pulled up to speed the emptying of the gas chambers. Adjoining the gable wall was the engine room, whence the Diesel exhaust gas was piped into the chambers.

Whereas the *Black Book* of 1946 speaks of 4,000 to 6,000 people being squeezed into the chambers at one time, most sources are content with fewer than 2,000. The mass graves for accommodation of the bodies are also part of the immediate site of the crime. According to Eliahu Rosenberg,<sup>73</sup> these mass graves, located near the gas chambers, measured 394 ft. × 49 ft. × 20 ft.,<sup>74</sup> but these dimensions vary from 164 ft. in length × 33 ft. in width × 16.4 ft. in depth to 492 ft. in length × 82 ft. in width × 33 ft. in depth, depending on the source. Later the site of the crime was functionally enhanced by the addition of gratings, or grilles, for burning the bodies.

Drawing on the accounts provided by witnesses and the subject literature, we shall examine a few aspects of this, with an eye to the technical prerequisites and their feasibility. These are elements that ought to have been realized long ago, and taken into consideration in the relevant trials. To illustrate the absence of a critical mindset and the frightening incapacity for technical conceptualiza-

---

<sup>71</sup> E.g., cf. the statements of Jewish Holocaust expert Professor Dr. R. Hilberg, in *Newsday*, Feb. 23, 1983, part II/3: “an incredible meeting of minds, a consensus – mind-reading by a far-flung bureaucracy.”

<sup>72</sup> Cf. the Düsseldorf verdict in the trial of K. Franz, District Court Düsseldorf, Ref. 8 I Ks 2/64, reprinted in A. Donat, *op. cit.* (note 38), pp. 296, esp. pp. 300f., also pp. 34, 157, 161; Y. Arad, *op. cit.* (note 38), pp. 42f., 119.

<sup>73</sup> E. Rosenberg, in H. P. Rullmann, *op. cit.* (note 3), p. 137.

<sup>74</sup> Cf. Y. Arad, *op. cit.* (note 38), pp. 33, 42; A. Donat, *op. cit.* (note 38), pp. 92, 153, 170f.

tion on the part of judges and public prosecutors, the following example is taken from the book *Nationalsozialistische Massentötungen durch Giftgas*:

“The building was low, long and broad [...] it was of gray concrete, had a flat roof of roofing felt [!!! A.N. ...] Three steps without banisters led into the building [...] The chambers were 5 ft. above ground level [...]”<sup>75</sup>

This means that for each step the riser was an astonishing 1.6 ft. high, which would have been quite an obstacle in filling the gas chambers with the people to be gassed.

### 3.3. The Murder Weapon

In recent times no one has given any serious consideration to the alleged facilities for the production of high-temperature steam, of sub-atmospheric pressure, or of chlorine gas for mass killing; these claims have clearly been rejected for their absurdity. But it is inexplicable why witnesses, historians and the courts have agreed on Diesel exhaust gas as the ‘murder weapon’ for Treblinka, Belzec and Sobibor. It is quite incomprehensible why those planning the extermination of incredibly great numbers of Jews should have resorted to the exhaust from Diesel engines, since we know today from many environmental reports that the exhaust from gasoline-powered engines is a hundred times more poisonous than that from a Diesel engine. A comparison of the various witness statements does not clarify just exactly how the gas affected those locked into the gas chambers. Any grave toxic effects of the exhaust from a Diesel engine can be ruled out due to the low carbon monoxide content of said gas.<sup>76</sup> Piping Diesel exhaust gas into the gas chambers would amount to a reduced but still adequate supply of oxygen to the rooms in question.

It is more than strange that the *Black Book* of 1943<sup>64</sup> cites a CO content of 2 to 3% for Diesel exhaust. It is not likely that this was printed in error, since the allegedly lethal nature of Diesel exhaust is still a vital brick in the foundation of the Holocaust. The value of 2 to 3% CO given for Diesel exhaust cannot be traced back to any witness statements. One may assume that the World Jewish Congress had subject experts at its disposal in this issue as well; the accompanying expositions of the biochemical effects of CO on hemoglobin would suggest this.

After escaping from the combustion chamber, the exhaust gases of internal combustion engines are channeled into exhaust pipes, whence they pass into the open air. If the gas escaping out the end of the exhaust pipe is stopped up, the pressure will increase until the engine stalls. The degree to which the pressure can rise varies with the type and construction of the engine.<sup>77</sup>

According to the witnesses, the engines used to supply the gas chambers with gas were heavy Diesel engines taken from Soviet tanks, whose power ranged up to 550 hp. Since Diesel engines have a high compression ratio (1:15), it may be assumed that they are still able to function even if the pressure of the exhaust increases by 0.5 atm. after exiting the cylinder.

Now if these exhaust gases are channeled into a hermetically sealed room, the pressure there can also increase by 0.5 atm. (corresponding to a weight of 500g/cm<sup>2</sup>, or 1,024 pounds per sq.ft.); this means that there would have been a force equivalent to the weight of 5 metric tons pushing outward against each square meter of surface area. This would have been the situation in any gassing as described by the witnesses for these allegedly hermetically sealed gas chambers. To illustrate the total force acting on the walls of the gas chamber, let us look at the dimensions of the chambers of Death House 2. Given the assumed height of 6.6 ft. and a room length of 26.25 ft., the wall surface area comes to about 173 sq.ft.; the force pushing outwards against the wall amounts to the equivalent of 80 metric tons. Imagine, if you will, three tractor-trailers of more than 25 tons each, simultaneously pushing against the wall!

<sup>75</sup> E. Kogon, H. Langbein, A. Ruckerl, *op. cit.* (note 38), p. 183.

<sup>76</sup> Cf. F. P. Berg’s detailed chapter, this volume.

<sup>77</sup> Exhaust-driven turbosuperchargers have a pressure requirement of 0.5 atm. and more.

The ceiling of this facility has a total surface area of 603 sq.ft. The force acting on it from below would be equivalent to the weight of 280 metric tons. The dead weight of such a ceiling is approximately 10 metric tons. If the ceiling did not actually lift off, it would at least snap in half upwards, since the steel reinforcement of reinforced ceilings is located in the lower third of the ceiling as seen in cross-section. Since according to Ruckerl *et al.* the floor of this gas chamber was 5 ft. above ground level, there must have been an empty space beneath it. Therefore the floor must have had a load-carrying capacity of more than 5 t/m<sup>2</sup>. Ceilings and floors of 6 t/m<sup>2</sup> weight-bearing capacity would not have simply vanished into thin air after the war.

Similar considerations apply to the doors of the gas chambers. The aforementioned trap doors measured 8.2 ft. width × 6.6 ft. assumed height, *i.e.*, 54 sq.ft. The pressure brought to bear on them would thus have amounted to 25 tons pushing outward – and yet these doors still managed to remain airtight. No doubt such a highly engineered door would be a prized museum exhibit.

Regarding the weight put on walls, ceilings and doors, we shall quote the *Black Book* of 1946,<sup>14</sup> which states:

*“The second method, the one that was most widely used, was pumping air out of the chambers with suction pumps until the victims were dead.”*

Rachel Auerbach cites a modified version, according to which the air was pumped out before the Diesel exhaust was piped in.<sup>78</sup> That even just the first half of this would have sufficed to kill the victims if the gas chamber had survived the process from a construction point of view is something which clearly does not occur to Ms. Auerbach. For these methods of killing, the forces acting on the building would have been reversed in comparison to the previous, *i.e.*, acting inwardly from without, and of even greater intensity up to twice the previously demonstrated values, since the difference in pressure between a normal room and one pumped to vacuum conditions is approximately 1 atm. It must be stressed that even considerably smaller pressure differences between the gas chamber and the atmosphere would have demolished the building.

Let us briefly consider how long it would have taken to attain an excess pressure of 0.5 atm. in the gas chamber of 603 sq.ft. area × 6.6 ft. height, *i.e.*, 3,980 cu.ft. Of the aforementioned Soviet Diesel engines, the W2 with 38 liter cubic capacity would be a possibility.<sup>76</sup> In a gassing situation the air volume in the gas chamber (volume of chamber minus volume of victims locked into it) would have been approximately 2,684 cu.ft. Assuming that the engine ran at 500 rpm, the volume of exhaust gas output would have been 335 cu.ft. per minute. The introduction of a total of 1,342 cu.ft. of exhaust gas would have increased the pressure in the gas chamber to 1.5 atm. within 4 minutes. Even running at full load and under the most unfavorable conditions, a Diesel engine does not put out enough toxins in this short time to suffice to kill anyone – but the volume of exhaust certainly would suffice to blow up hermetically sealed brick-walled rooms.

How would a homicidal gassing process even be possible if, for example, the ten gas chambers of Death House 2 were simultaneously filled with 6,000 people, as the *Black Book* reports? The hallway leading to the gas chambers was allegedly 5 ft. wide. This is just wide enough to allow two people to enter it side by side. So if the victims-to-be are lined up outside the Death House, two abreast and each 2 ft. behind the person before them, we end up with a line-up almost 1¼ mile long. Entering the Death House, filing into the gas chambers and crowding them closely with victims will allow a marching speed of the line-up of, perhaps, 1¼ mile per hour if the victims behave with great discipline and cooperation. The absurdity of the conditions required for this best-case scenario shows that one hour certainly would not have sufficed to crowd the 6,000 people forcibly into the chambers. This means that the victims in the chamber that was filled first would have already been locked up in their air-tight room for an hour or more before the gassing even began; for to assume that the gassing began as soon as the first chamber was filled contradicts eyewitness testimony, for

---

<sup>78</sup> R. Auerbach, in A. Donat, *op. cit.* (note 38), pp. 35, 50.

example the claim that Ivan the Terrible not only drove the victims into the chambers but also operated the Diesel unit. He could not have done both at once. This further indicates that the victims locked up in the chamber that was filled first had less than 16 m<sup>3</sup> oxygen available to them.

According to technical specifications for engineers, the oxygen requirement for people performing even non-strenuous work is  $\frac{2}{3}$  liters per minute. Under the conditions given – being crowded together in a small room – this is the least amount required. This means that 600 persons under the specified conditions use up some 400 liters of oxygen per minute, so that as long as consumption remained steady, the available oxygen would already have been completely used up within 40 minutes; dead bodies would have been all that was left in the chamber, long before the start of any gassing. In fact, oxygen consumption decreases with the onset of death, so that it would have taken the victims about one hour to suffocate. Even the witnesses ought to have noticed that. These, however, report that death by suffocation took 24 or even 48 hours when the Diesel engines failed to work; this account, therefore, must be rejected as being a sheer flight of fancy.<sup>79</sup>

If, however, the chambers were not hermetically sealed and were only enriched, so to speak, with Diesel exhaust gas, then the 15-17% oxygen content of the exhaust would not have been fatal.<sup>80</sup>

Incidentally, it does not make sense that individual chambers should have been used for gassings, since one single large room would have been much more practical in terms of filling and emptying as described for the alleged scenario.

The divergent eyewitness testimony regarding the function of the Diesel engines in the camps necessitates further observations. From time to time it is claimed that the engines used for gassing also supplied electrical power to the camps.<sup>81</sup> According to the claims for Treblinka II, the lower camp already existed before the upper one was constructed. If the Diesel engine mentioned for the upper camp had been meant to supply the entire Treblinka II camp, then the lower camp would have had to obtain its electricity from elsewhere until the upper camp was built. But if the engine had been intended to supply only the upper camp, this would have been technical nonsense, since due to the nature of the facilities all that would have been required was at most 100 light bulbs @ 75 Watt – a total of 7.5 kW – for lighting purposes. The Soviet tank engines had a capacity of up to 550 hp ( $\cong$  400 KW), which is why no one would have used them to generate 7.5 kW of electricity. At such a low level, one may assume that the composition of the Diesel exhaust would have approximated that of an engine running at idle. One must also bear in mind that it is highly unlikely that engines from captured Soviet vehicles would have been used to generate electrical power, since in the case of a break-down it would have been difficult during wartime to obtain replacement parts for these engines. Eyewitnesses even tell of such defects and break-downs, and claim that they caused repeated delays in the gassings.

The water supply (the camp had its own well) was also dependent on electrical power. Since witnesses have reported time and again that the gassing engines were turned on for the gassings, and were turned off again after the gassings were finished (after 5 to 45 minutes<sup>82</sup>), but the electrical and water supplies would have had to be present without interruption, one may consider it certain that the gassing engine in the upper camp cannot have served to generate electrical power for the lower camp. Treblinka II will thus have been connected to the power supply of the nearby town, and probably also had a separate emergency power back-up in the event of power failures.

<sup>79</sup> R. Auerbach, *ibid.*, pp. 49f.; J. Wiernik, *ibid.*, p. 172.

<sup>80</sup> It should be mentioned here that CPR involves mouth-to-mouth resuscitation and that the life-restoring breath (exhaled by the person performing the resuscitation) contains about 15% oxygen.

<sup>81</sup> J. Wiernik, in A. Donat, *op. cit.* (note 38), p. 157; verdict, Düsseldorf, *ibid.*, p. 300; Y. Arad, *op. cit.* (note 38), p. 42. However, these witnesses state that the engine used for generating electric power was an additional Diesel engine used independently of the gassing engine. We are working on the assumption that the witnesses were mistaken and that the gassing engine and the generator engine were one and the same.

<sup>82</sup> Y. Arad, *op. cit.* (note 38), pp. 69, 71, 86; A. Donat, *op. cit.* (note 38), pp. 36, 49, 159, 172, 311; R. Glazar, *op. cit.* (note 38), p. 19; J.-F. Steiner, *Treblinka*, Stalling, Oldenburg 1966, pp. 180, 213.



Accounts of interruptions of the described gassings due to Diesel engine failures are not restricted to Treblinka. For Belzec SS-Führer Gerstein reported such a failure of a Diesel engine<sup>76</sup> which was used solely for gassings, and would thus almost certainly have been run at idle – if Gerstein’s report were correct, but this can almost definitely be ruled out.<sup>83</sup> Since according to Gerstein the people in the gas chambers remained alive for hours while the engine was out of service, a closed chamber must have been very well ventilated indeed.

Any serious plan to commit mass murder by means of exhaust gas would thus not only have provided for a different (non-Diesel) kind of engine, it would also have had to provide for back-up facilities.

All the considerations and calculations presented here are quite simple on the whole, and it is therefore utterly incomprehensible that such technical analyses have not been commissioned and carried out long ago. Another point which the courts really ought to have noted is that so far not one single case is known of someone committing suicide with the exhaust gas from a Diesel engine, whereas suicide by means of exhaust from a gasoline-powered engine is unfortunately not at all a rare occurrence. Thus the toxic effects of Diesel exhaust falsely alleged by the Holocaust dogmatists have not found practical application outside a gas chamber.

The technical considerations set out in the foregoing show that the gas chambers as they are described would not have been physically able to serve as murder weapon as they are commonly believed to have done. The following investigation shall shed some light on the alleged removal of the bodies, which allegedly left no traces whatsoever.

## 4. Treblinka: Elimination of Corpses Without a Trace

### 4.1. Burial Pits

According to Eliahu Rosenberg,<sup>16</sup> after the trap doors of the gas chambers were pulled up, the corpses (some 850,000 altogether) were taken to pits measuring 394 ft. in length, 49 ft. in breadth and 20 ft. in depth. Based on Rosenberg’s testimony, and assuming a likely gradient of 65° in the sandy and gravelly terrain of the Treblinka area and a 1.6 ft. soil layer to cover the mass grave, such a burial pit would have had a fillable volume of some 282,500 cu.ft.

Some witnesses have stated that the bodies were layered into the pit and that each layer was covered with a layer of soil; others claim that the bodies were haphazardly thrown into the pit. Both situations would allow for approximately 8 bodies per cubic meter (10 per 44 cubic ft.), meaning that the pits described would have accommodated about 64,000 bodies each. Interestingly enough, none of the witnesses mention the considerable amount of excavated soil, which came to about 339,000 cubic ft. per pit, given a 20% loosening-up of the soil. The gradient of a pit dug in natural ground conditions is known to be much steeper than that of the pile of dug-up contents. If the surface area of the burial pit measured 19,300 sq.ft., as alleged, then given a gradient of approximately 30° for the excavated gravel or sand – and after subtracting approximately 35,300 cu.ft. for the material with which the corpses were covered – the area taken up by the dug-up material piled 20 ft. high along the pit would have been approximately 28,000 sq.ft.

According to the Slovenian historian Tone Ferenc,<sup>84</sup> the upper extermination area, which is said to have been within the camp area of Treblinka II, covered an area of about 172,000 sq.ft.; however, to forestall any objections on this score, we shall base our further considerations on the size of the extermination area indicated by the archival plan, namely about 193,700 sq.ft. This area held not only burial pits and the material dug up in the course of their excavation, but gas chambers and other buildings as well. If one accepts the 875,000 dead mentioned in the Jerusalem Trial of John

---

<sup>83</sup> Cf. H. Roques, *Die "Geständnisse" des Kurt Gerstein*, Druffel, Leoni 1986 (online: [abbc.com/aaargh/deut/HRgerstein1.html](http://abbc.com/aaargh/deut/HRgerstein1.html)).

<sup>84</sup> In U. Walendy, *"Der Fall Treblinka"*, *op. cit.* (note 37), p. 11.

Demjanjuk, then 14 burial pits à la Rosenberg and a total of some 4.6 million cu.ft. of excavated earth would have been involved in the accommodation of all these bodies. Since these 14 pits would have taken up an area of 271,150 sq.ft, they could not have fit into the extermination area measuring only 193,700 sq.ft. Further, the heaps of excavated material resulting from the 14 burial pits would have required an additional area of more than 392,000 sq.ft.

If, on the other hand, one proceeds on the assumption that the claims of 3 million victims are correct, then 47 burial pits covering some 910,000 sq.ft. would have been needed; these would have taken up almost two-thirds of the area of Treblinka II – not even including the excavated soil going with them.

Finally, some comments on the allegedly 20-ft.-deep burial pits. First of all, it seems unlikely that the pits would have been dug that deep, as doing so would have required either complicated heavy machinery or increased expenses related to the construction of ramps. The excavators allegedly used in Treblinka would hardly have been adequate to this task.<sup>85</sup> At depths of 20 ft., it is also probable that ground water seepage occurs, which would have impeded or downright prevented the construction and use of pits of such depth. However, since the camp Treblinka I, with a large gravel pit, is said to have been located near Treblinka II, a ground water level lower than 20 ft. is certainly conceivable. If one proceeds on the assumption of a more realistic pit depth of approximately 10 ft., then a pit of the aforementioned surface area would have held some 35,000 bodies, and 25 pits would have been needed, covering a total of 484,200 sq.ft. excluding the area taken up by the excavated soil. The excavated material itself would have required an area of 570,300 sq.ft., making for a total of almost 1.1 million sq.ft. For the alleged 3 million victims, 86 pits covering 1.67 million sq.ft. would have been needed, plus the corresponding area for the excavated soil.

In the case of Auschwitz, quantitative considerations based on events ‘attested to’ by witnesses, and on the technical and material consequences resulting from the alleged events, have brought about a constant and ongoing reduction in the number of victims.<sup>86</sup> Scientific facts have always been the enemy of religious dogma.

## 4.2. Elimination of the Corpses – Not Quite Without a Trace

The elimination of victims without a trace is a vital link in the chain of evidence for the Holocaust in general. Elimination without a trace is the prerequisite for an arbitrary number of victims. This is how the numbers of victims alleged for Treblinka come to vary from 700,000 to 3 million – a phenomenon that also appears in other cases.<sup>87</sup> The casual treatment of such high numbers of victims seems questionable from the start, and ought to prompt those concerned with the topic to gather scientifically irrefutable facts so as to prevent the Holocaust from becoming a matter of faith. But smoke and mirrors and eyewitness testimony have been deemed good enough. The technically unrealistic claims regarding the mass murder of human beings are compounded by the utterly unbelievable accounts of the removal of bodies without any trace. Millions of dead cannot simply vanish into thin air. In this context the reader is referred to the case of Katyn, where the 4,500 Polish officers murdered by the Soviets in 1940 were discovered in 1943.<sup>88</sup>

According to eyewitness testimony, Himmler ordered the incineration of bodies in the extermination camp Treblinka to eliminate any evidence of the killings; this order was allegedly given in March 1943.<sup>89</sup> This is said to have involved the exhumation and burning of the bodies that had al-

<sup>85</sup> Cf. the pictures from K. Franz’s photo album, in G. Sereny, *op. cit.* (note 38), p. 210; A. Donat, *op. cit.* (note 38), p. 264; Y. Arad, *op. cit.* (note 38), p. 95.

<sup>86</sup> Cf. G. Rudolf’s chapter about the statistics of Holocaust victims, this volume.

<sup>87</sup> For ex., cf. the chapters by H. Tiedemann about Babi Yar, G. Rudolf about Auschwitz.

<sup>88</sup> F. Kadell, *Die Katyn-Lüge*, Herbig, Munich 1991.

<sup>89</sup> Cf. Y. Arad, *op. cit.* (note 38), p. 170.

ready been buried. Various eyewitness accounts exist of this procedure in Treblinka, which allegedly went on from about March to August 1943.

Regarding the burning of the corpses, Eliahu Rosenberg has stated:

*“After Himmler inspected the camp he ordered the burning of all the bodies lying in the pit [...] For this purpose, two iron rails were placed on the ground parallel to each other, and the bodies that were dug out of the pit with excavators were stacked on top of each other like fire logs. It frequently happened that the corpses, especially those just freshly killed, didn’t burn well, and so we had to pour gasoline over them [...] At that time we had only one burning site, and of course that wasn’t enough, since we couldn’t burn more than a hundred bodies a day. An SS-Oberscharführer, Herbert Floss by name, was brought in from the neighboring camp [...] He set up five or six burning sites and also introduced a new way to layer the bodies [...]”*<sup>90</sup>

In his testimony in Jerusalem, at the Demjanjuk trial, he also persisted in his convictions:

*“In Treblinka we learned that little children burn better than grown men. All it takes is a match to light them. That’s why the Germans, damn them, ordered us to put the children in the pit first.”*<sup>91</sup>

The witness Szyja Warszawski, who came to Treblinka in July 1942, told of gassings with chlorine and of at least 10,000 victims a day, and stated with respect to cremation:

*“[...] Usually the bodies were put into pits 33 ft. deep and wide and many times as long. In January 1943 [...] five to six gratings were set up on the ground. The grates, which consisted of iron rails, were supported by cement posts about two feet above the ground. A grate like that was 33 ft. long and 13 ft. wide. A fire was started underneath. Bodies were layered on the burning grate with an excavator machine. Once the bodies caught fire they would continue burning by themselves. Mass cremation began in late February 1943. The ashes that remained after the burning were thrown back into the pits where the bodies had been dug out earlier. Sweet-peas were sown over top and trees brought over from the forest were planted to camouflage the site [...] For some pits only the top layer of bodies was dug out. The rest of the bodies were covered over with soil, and the site was camouflaged as well [...]”*<sup>92</sup>

Without going into detail about the strange and contradictory claims in these statements, we shall add some excerpts from Wassily Grossmann’s book *Die Hölle von Treblinka*, where the cremations are described as follows:

*“At first the cremation of the bodies just wouldn’t work – the bodies did not catch fire properly [sic!]; it was observed however, that female bodies burned easier. Vast quantities of expensive gasoline and oil were wasted on kindling [sic!] the bodies, but the results were pathetic [...] An expert [...] came from Germany, from the SS. What multitalented experts the Hitler regime gave rise to! [...] A specialist for digging up and burning millions of human corpses was also found.*

*Under his direction the construction of furnaces began. It was a very special kind, a cross between a pyre and a furnace [...] The excavator dug a boiler trench 820 to 980 ft. long, 65 to about 80 ft. wide and 16 ft. deep. Reinforced concrete pillars sticking about 40 to 50 inches out of the ground were evenly spaced in three rows on the bottom, along the entire length of the trench. These pillars supported steel joists running the entire length of the trench. Across these joists rails were placed 2 to 3 inches apart. In this way the grating of an enormous oven was formed [...] Soon a second and then a third oven of the same size was constructed. Each grating was loaded with 3,500 to 4,000 bodies at a time.*

---

<sup>90</sup> E. Rosenberg, *Tatsachenbericht*, pp. 9f., in H. P. Rullmann, *op. cit.* (note 3), pp. 141f.

<sup>91</sup> E. Rosenberg’s testimony at the Demjanjuk Trial in Jerusalem, quoted from U. Walendy, *HT* no. 34, Verlag für Volkstum und Zeitgeschichtsforschung, Vlotho 1988, p. 24.

<sup>92</sup> S. Waszawski, document of the Main Commission for the Investigation of the Hitlerite Crimes in Poland. The author has a German copy of the interrogation transcript. (cf. Główna Komisja Badania Zbrodni Hitlerowskich w Polsce, *Obozy hitlerowskie na ziemiach polskich 1939-1945. Informator encyklopedyczny*. Państwowe Wydawnictwo Naukowe, Warsaw 1979).

[...] *People who participated in the cremation of the bodies recount that the ovens resembled gigantic volcanoes. [...] Dense, black, fat columns of smoke rose heavenward [...] Even twenty to twenty-five miles away, the people saw [...] these flames at night, rising up beyond the treetops of the spruce forests surrounding the camp. The entire area was polluted with the stench of burning human flesh [...] The traces are indelible.*<sup>93</sup>

Jankiel Wiernik, who is the only one of the witnesses to claim that he participated directly in the cremation for a longer period of time, writes:

*“It turned out that bodies of women burned more easily than those of men. Accordingly, the bodies of women were used for kindling the fires.”*<sup>94</sup>

Richard Glazar comments succinctly:

*“The human body does not burn particularly well, quite the opposite.”*<sup>95</sup>

Rachel Auerbach has compiled various witness statements and summarized them thus:

*“Polish people still talk about the way soap was manufactured from the bodies of Jews.... The discovery of Professor Spanner’s soap factory in Langfuhr proved that their suspicions had been well founded. Witnesses tell us that when the corpses were burned on pyres, pans would be placed beneath the racks to catch the fat as it ran off, but this has not been confirmed. But even if the Germans in Treblinka or at any of the other death factories failed to do this, and allowed so many tons of precious fat to go to waste, it could only have been an oversight on their part.”*<sup>96</sup>

*In Treblinka, as in other such places, significant advances were made in the science of annihilation, such as the highly original discovery that the bodies of women burned better than those of men.*

*‘Men won’t burn without women.’ [...] [T]he bodies of women were used to kindle, or, more accurately put, to build the fires among the piles of corpses [...] Blood, too, was found to be first-class combustion material. [...] Young corpses burn up quicker than old ones. [...] [W]ith the help of gasoline and the bodies of the fatter females, the pile of corpses finally burst into flames.”*<sup>97</sup>

Yitzhak Arad, trying to sound scientific, reports:

*“[T]he corpses... [were] arranged [...] in layers on the roaster to a height of 2 meters. [...] When all was ready, dry wood and branches, which had been laid under the roaster, were ignited. The entire construction, with the bodies, was quickly engulfed in fire [...] and the flames would reach a height of up to 10 meters. [...] [T]he SS men in charge of the cremation became convinced that the corpses burned well enough without extra fuel. Yechiel Reichman, a member of the ‘burning group’, writes: ‘The SS ‘expert’ on bodyburning ordered us to put women, particularly fat women, on the first layer of the grill, face down. The second layer could consist of whatever was brought – men, women, or children – and so on, layer on top of layer [...]”*<sup>98</sup>

*These [fresh] bodies did not burn as well as those removed from the ditches [i.e., the graves] and had to be sprayed with fuel before they would burn.”*<sup>99</sup>

But something does seem to have struck one of our Holocausters as odd. Jean-François Steiner vividly describes the problem resulting from the actual, enormous wood (fuel) requirements involved in cremation:

*“The prime costs proved to be prohibitive: aside from the vast quantities of gasoline, just as many logs were needed as there were bodies. It was not a viable undertaking, for even if all the forests of Poland*

<sup>93</sup> W. Grossmann, *Die Hölle von Treblinka*, Foreign Languages Publishing House, Moscow 1947.

<sup>94</sup> J. Wiernik, in A. Donat, *op. cit.* (note 38), p. 170.

<sup>95</sup> R. Glazar, *op. cit.* (note 38), p. 34.

<sup>96</sup> R. Auerbach, in A. Donat, *op. cit.* (note 38), pp. 32-33.

<sup>97</sup> *Ibid.*, p. 38.

<sup>98</sup> Y. Arad, *op. cit.* (note 38), p. 175.

<sup>99</sup> *Ibid.*, p. 176.

*might still have been felled as a last resort, the gasoline supply would nevertheless run short. Stalingrad had fallen, and with that, the rich petroleum fields of the Caucasus had shimmered away into nothingness like a mirage.*"<sup>100</sup>

But J.-F. Steiner, who also compiled many eyewitness statements, manages to find a way out of this predicament; he too came across the bodies that burn of their own accord:

*"There were fire-resistant [bodies] as well as such that caught fire easily. The trick was to use the good ones to burn the bad. According to his [Herbert Floss's] research – which evidently had been far advanced – old bodies burned better than new ones, fat ones better than skinny ones, women better than men, and children not as well as women but better than men. From this it followed that old corpses of fat women were the ideal kind."*<sup>101</sup>

Some witness statements do in fact indicate that there were units in the camp whose task it was to supply firewood. While Abraham Krzepicki and Samuel Willenberg can only tell of a unit that tore branches off trees in order to decorate the fence surrounding the extermination camp with them, for camouflage purposes,<sup>102</sup> Y. Arad reports that a "wood commando" which initially had to provide only the wood required for construction and firewood later also had to procure the wood needed for cremation.<sup>103</sup> However, there is a consensus among the witnesses and Holocaust believers that the wood was only lit as a sort of camp fire underneath the mountains of corpses, until these had caught fire and burned on their own. R. Glazar is the only one to be able to provide details of this "wood commando": it consisted of 25 men, whose efforts yielded so few twigs and branches that a "camouflage commando" of 25 men had to climb unfelled trees in order to break off additional branches, which were woven into the camp fences to keep outsiders from looking in.<sup>104</sup> Apparently, the "wood commando" did not fell many trees.

Incidentally, Steven Spielberg has shown himself quick to learn from the aforementioned 'witnesses': in one scene of his movie *Schindler's List* he shows a gigantic conveyor belt continually heaping bodies onto an enormous pile of corpses magically burning on by themselves.<sup>105</sup>

### 4.3. Cremation of Bodies, or Fire Victims?

Even though they are contradictory, the many eyewitness accounts do offer numerous details of the extermination activities in Treblinka II; on the other hand, the issue of the fuel necessary for the elimination of the bodies – that is, for their incineration – is ignored, glossed over, or dismissed with unacceptable claims. This consistent approach suggests that the issue, not being resolvable, is repressed either consciously or unconsciously. Szyja Warszawski came up with what is no doubt the easiest solution to the fuel problem when he declared:

*"[...] Once the bodies caught fire they would continue burning by themselves",*

and Grossmann also took a turn in this direction when he stated:

*"[...] the bodies did not catch fire properly",*

and

*"[...] kindling the bodies".*

The witnesses appear to agree on the opinion that female corpses burn by themselves particularly well, and can thus serve to ignite and burn other corpses. These claims imply that mere kindling suffices to set corpses on fire.

---

<sup>100</sup> J.-F. Steiner, *op. cit.* (note 82), p. 294.

<sup>101</sup> *Ibid.*, p. 295.

<sup>102</sup> In: A. Donat, *op. cit.* (note 38), pp. 124, 192.

<sup>103</sup> Y. Arad, *op. cit.* (note 38), p. 110.

<sup>104</sup> R. Glazar, *op. cit.* (note 38), pp. 59, 108, 116, 126ff., 134ff.

<sup>105</sup> Cf. the chapter by U. Walendy, this volume.

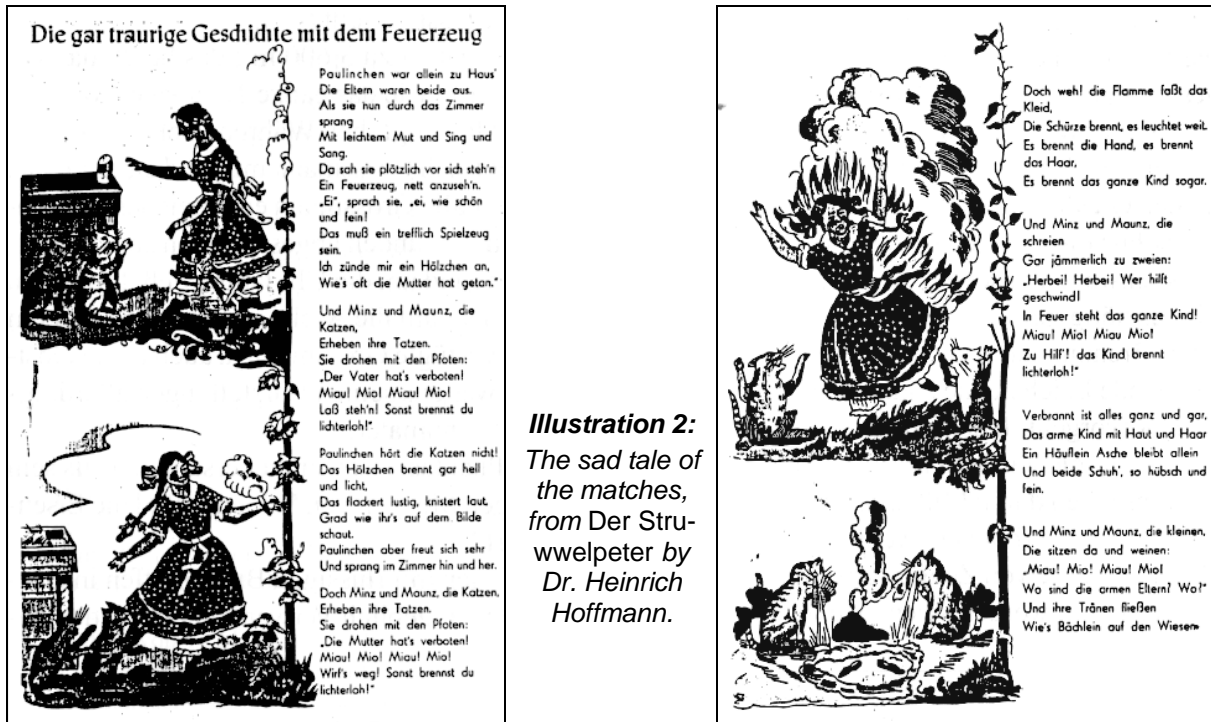

**Illustration 2:**  
*The sad tale of  
the matches,  
from Der Stru-  
wulpeter by  
Dr. Heinrich  
Hoffmann.*

However, this easy way out does not suffice to truly solve the problem of the cremation of corpses, for the worldwide presence and use of oil-, natural gas- or coal-fired crematoria refutes it conclusively, as do all the laws of nature. Some 65% of the human body is unburnable water.

When a major earthquake struck India in September 1993, claiming some 20,000 lives, it was feared that epidemics would break out if the fuel (wood) needed for the cremation of the bodies could not be procured in time. In India, where the cremation of bodies has been the rule rather than the exception for a long time, self-burning corpses have yet to be discovered, even though the country suffers from fuel shortage in this context.

Psychologists ought to investigate the patently false witness claims, since there is no scientific or literary precedent for any similar event, which might have found its way into the witnesses' subconscious mind in the form of a literary experience. An event somewhat similar to the claims of the witnesses may be found in the German well-known children's picture-book *Der Struwwelpeter*, where the dreadful fate of Paulinchen, a girl playing with matches, is described in order to deter children from doing the same. All that remains of Paulinchen is a pile of ashes and the girl's shoes.

If the story of Paulinchen, who burned up all by herself, and of the remaining little pile of ashes were the psychological key to the claims of Warszawski and the others, then Paulinchen's shoes, which failed to burn, might also be the key to Gerstein's story about Belzec, where a 5-year-old child allegedly had to take the shoes of the Jews who were to be gassed to a 40-ft.-high(!) pile of shoes.<sup>83</sup> Possibly these oddly similar statements even lead back to another as yet unknown common source reflecting a key childhood experience. The author of the storybook is Dr. Heinrich Hoffmann; however, the Stars of David located in the original edition near the passage in question do not allow for any further conclusions.

If the eyewitness testimony quoted previously with regard to the cremation grating are already utterly unbelievable, the claims made by W. Grossmann in his book also reveal a very sick imagination. His term "*boiler trench*", which is neither known from other contexts nor makes any intrinsic sense, should suffice to bring psychologists into play. The purpose of such a neologism is probably to convince the amateur audience of the speaker's authority, to impose and to reinforce ignorance, to create a guilty conscience, and thus to render the lie believable.

Moving on, Grossmann describes the oven grating and states that three supports of reinforced concrete posts (!!!) and steel joists some 40 inches high were set up along the length of the trench, across which rails were placed 2 to 3 inches apart.<sup>106</sup> In this way there are about 5 rails per running meter, which – assuming a rail length of only 40 ft., although the trench is said to have been as much as 82 ft. in width – results in a total rail length of just over 11 miles. To allow for the burning of the alleged millions of bodies, Grossmann reports two further boiler trenches, making for a total rail length of 33.5 miles. Where on earth did all these rails come from? According to Grossmann the grates were loaded with 3,500 to 4,000 corpses at a time. How were the bodies counted, and who distributed them on the grating, and how?

From the dimensions given, the surface area of one grating may be calculated as 38,700 sq.ft.; this means that for the three boiler trenches the total surface area was 116,100 sq.ft., in other words, roughly the same area as the entire death camp. The total volume of soil excavated – 2.86 million cu.ft. – was even greater than that for the mass graves. Whereas Warszawski's much smaller grating held veritable mountains of dead bodies, Grossmann is content with about one body per square yard of grating surface. Assuming that, in the case of Grossmann, cremation could be finished in 5 hours (without the ashing of the bones), it is difficult to understand why cremation was carried on 'round the clock'; in any case, it would have been necessary to extinguish the fires every now and then in order to remove the ashes and to add more fuel. But who knows, perhaps the corpses available to Grossmann were not only self-burning, but also burned without leaving any residue – he doesn't say. At any rate he makes no mention of the fuel.

The sick imagination on which such an account is based is not as astonishing as the fact that millions of people believe it. What became of the enormous number of rails and of the reinforced concrete pillars, and who carried out the transports?

Occasionally, witnesses have mentioned that bodies were burned with liquid fuel in pits in Treblinka II; methyl alcohol and gasoline were allegedly used.<sup>107</sup> In such a case, as in all open-air incinerations, only a small percentage of the energy released by the fuel in fact acts on the object to be burned, in contrast to suitable furnaces where insulated walls concentrate the heat in a small space.

Intensive incineration, with high temperatures and corresponding energy density, requires a plentiful oxygen supply and a large fuel surface. This simple fact has found practical application in, for example, spirit stoves and blowtorches, where fuel and air nozzles are important. This effect is also commonly used in internal combustion vehicles, in the form of fuel injection and air turbulencing. Due to the insufficient oxygen supply in pits several yards deep, the cremation of corpses as described by the witnesses is not physically possible. The reader is referred to a type of fireplace used by the ancient Romans; even in those early days the Romans already knew to supply these fireplaces with air via underground pipes.

If one wanted to incinerate bodies in the open air and with liquid fuels, it would be necessary to prevent the fuel from seeping into the ground by placing metal pans underneath the burning grates. Because of the disadvantageous conditions, the quantity of energy required for cremation could not be less than that generated by solid fuels such as wood or coal. Regarding the cremation grates described, there would have been the additional problem of body parts falling into the gasoline-filled pans, thus being extinguished. Pouring liquid fuel over human bodies can result in their charring but not in their incineration.<sup>108</sup>

---

<sup>106</sup> Cf. Y. Arad, *op. cit.* (note 38), p. 171, 174; A. Donat, *op. cit.* (note 38), pp. 170f.

<sup>107</sup> E.g., B. A. Krzepicki, in A. Donat, *ibid.*, p. 92: he claims that old clothes, bags, and all kinds of garbage were used as fuel; cf. also J. Wiernik, in A. Donat, *ibid.*, p. 181: after being lit, the bodies burned on their own.

<sup>108</sup> This was determined by two reports which, being of Communist origin, are above suspicion of pro-Nazi bias. These reports were drawn up for the East German and Soviet military in order to determine whether it would be possible, in the event of mass deaths due to war, to dispose of bodies in the open air: J. Loscher, H. Schumann (eds.), *Militärhygiene und Feldepidemiologie*, Militärverlag der DDR, Berlin 1987; F. G. Krotkov, *Uberka polej crasgenij* –

While the complete incineration of a body in the retort of a crematorium requires at least 66 lbs. of coke fuel,<sup>109</sup> then the equivalent incineration in the open air will require at least 16 gallons of gasoline, given a suitable set-up. Under the technical conditions described for Treblinka, the incineration of the 875,000 victims alleged in Jerusalem would have taken some 13.2 million gallons of gasoline. Given this daily requirement of fully 10 tank cars of gasoline – an overall total of no less than 2,000 – the train of tank cars would have been all of 9.3 miles long. And this at a time when every gallon of gasoline was badly needed for fighter planes and vehicles of all kinds!

According to a November 27, 1986, report of the New Delhi *Schenectady Gazette*, cremations and the consumption of wood involved therein (due to the lack of corpses that will burn by themselves) are a serious concern for the inhabitants of India, since entire forests have been cut down over time for just this purpose. According to this report, the daily incineration of 21,000 bodies requires 6,433 metric tons of wood, *i.e.*, 675 lbs. per body. In applying these conditions to Treblinka, we shall simplify the matter somewhat by ignoring the problems involved in the prior exhumation of the bodies; let it suffice to consider only one unreality, namely the incineration of the bodies.

To forestall objections of any kind, we shall reduce the consumption of wood for mass cremations from 675 lbs. to 440 lbs. per body.<sup>110</sup> From various eyewitness accounts it follows that the cremation process lasted until early August, a total of about 185 days. This means that a minimum of 4,700 bodies had to be cremated every day, requiring 950 metric tons of dry wood daily. The engineering handbook *Hütte* indicates a volume of 74.15 cu.ft. per metric ton for spruce wood,<sup>111</sup> and of 109.5 cu.ft. per metric ton for spruce wood fire logs.<sup>112</sup> This means that the volume of the wood needed in Treblinka daily for incinerating the corpses would have been about 104,000 cu.ft. This volume is perhaps easier to grasp when visualized as a stack 3 ft. high, 3 ft. wide and about 1.75 miles long. Every day!

The cremation gratings, described by Warszawski as measuring 13 ft. × 33 ft. and with 1.5 ft. elevation above the ground, had a spatial volume of approximately 650 cu.ft. underneath the grating. To ensure that the firewood would receive enough draft (oxygen), a maximum of 530 cu.ft. could have been placed underneath. This quantity corresponds to a net weight of 10,600 lbs. and would have sufficed for cremating 24 (twenty-four!) bodies. If one assumes that, in this case, the complete incineration of the bodies took only 2 hours (which, however, is far too short to be realistic), then even cremating ‘round-the-clock’ would have disposed of 288 bodies at most. The high piling-up of bodies on the grating, as it is described by witnesses, would have brought nothing but disadvantages, if only due to the inhibited access granted the flames. But if 4,700 bodies had to be burned every day, this would have required more than 16 gratings as described above, with a total surface area of 6,890 sq.ft.

Stoking the cremation sites with wood, and removing the ashes and skeletons, are elements which have been ignored to date. Given the heat of the fire under the gratings and the stench of the burning bodies, it would have been impossible to perform these necessary tasks while the fire was burning. It is thus safe to say that continuous cremation in the manner described, and using the burning sites described by the witnesses, would not have been possible. Burning the 4,700 bodies would have required at least twice the number of gratings.

With reference to the number of bodies to be incinerated, we still need to examine the source, processing and transportation of the needed quantities of firewood. The total cremation process in Tre-

---

*opyt sovetskoy mediciny v veli koj otetshestvennoy vojne 1941-1945*, tom 33: “gigiena”, Moscow 1955, esp. pp. 236ff.; cf. also the chapter by C. Mattogno, this volume.

<sup>109</sup> Cf. the chapter by C. Mattogno, this volume.

<sup>110</sup> Based on experiments with the cremation of animal flesh, Carlo Mattogno calculated a need of some 350 lbs (160 kg) of dried wood for the cremation of a corpse of 98 lbs (45 kg), or 583 lbs of wood for a 165 lbs corpse. C. Mattogno, J. Graf, *op. cit.* (note 1), p. 185.

<sup>111</sup> Akademischer Verein Hütte, *Hütte*, v. 1, Ernst & Sohn, Berlin 1955, p. 1037.

<sup>112</sup> *Ibid.*, p. 1035.



blinka would have required 430 million pounds, or 195,000 metric tons, of air-dried (seasoned) wood. Due to the short notice and brief time that Himmler allegedly allotted for this process, such a large quantity of air-dried wood would certainly have been impossible to get, which is why only fresh (“green”) wood of lower calorific value would have been available. The calorific value of seasoned wood is 3,600 kcal/kg, whereas that of green wood is only 2,000 kcal/kg.<sup>113</sup> Therefore the total required quantity of wood would have increased to 351,000 metric tons, and the daily requirement of green wood was thus approximately 1,900 metric tons. Assuming medium-sized trees of 1 cord volume and 1,500 lbs., the total number of trees needed comes to roughly 515,000.

There were two options for obtaining the required quantity of wood: either there was a large forested area near the camp where the demand for firewood could be met, and whence the wood would then be transported to the camp with suitable vehicles, or the wood had to be brought in from other areas by rail.

Let us suppose for the moment that the wood supply was nearby. Assuming that a 15-ton truck can make 3 runs daily, allowing for loading and unloading of the truck, then 126 trips would need to be made daily, using some 42 trucks. None of the eyewitness statements indicate the presence of such a fleet of trucks. The same goes for the labor force required for the daily felling, limbing, sawing and splitting as well as loading and unloading of 2,800 trees. If, given the primitive conditions that prevailed, we assume that two men could have processed – that is, felled, limbed, sawed and split – one tree per day (an utter illusion), then the lumberjacks would clearly have had to number at least 5,600.

To give an idea of how large a forest would need to be in order to supply such vast quantities of wood, let us assume a yield of 325 cord per acre, which for 515,000 trees would require a forest of 1,590 acres, or just short of 2.5 square miles. To put it more graphically, such a forest would have been 2.5 miles long and 1 mile wide. Is it really conceivable that the witnesses and the local residents could have failed to notice such a large deforested area? The site would still be apparent today.

If one proceeds instead on the assumption that the quantity of wood needed would not have been available locally, then it would have had to be brought in from elsewhere, for example in the form of large fire logs, in rail wagons. If one performs the corresponding calculations for this scenario, then a freight train of 63 cars of 30 metric tons each would have had to be unloaded in the camp every day – a total of 185 freight trains. In the end the total length of the trains would have reached 116 km, or 72 miles. This begs the question: where are the pertinent Reichsbahn (German Railway) documents about these enormous wood transports? The authorities and offices in question would hardly have dispensed with payment and not submitted their accounts.

Regarding the claim that the 875,000 corpses were eliminated completely with out any trace, we must consider the quantities of ashes that remain. The quantities of wood ashes are considerable, and vary with the type of wood. We shall postulate the low value of 6.6 lbs. per ton of dry wood.<sup>112</sup> The wood ashes remaining would then have weighed approximately 1,000 metric tons; the equivalent of the payload of 100 10-ton trucks.

The ash content of a human body makes up about 5.6% of the body’s weight;<sup>114</sup> given a 132 lb. body, this comes to 7.3 lbs. The ashes from the 875,000 burned bodies would thus have weighed 6,387,500 lbs. The total quantity of ashes – wood ashes plus human ashes – would therefore have weighed almost 4,000 metric tons, or 8.6 million pounds, all of which (according to the witnesses) were then mixed with the soil and thrown back into the pits.<sup>115</sup> Even if this quantity of ash had been mixed with the roughly 3.53 million cubic feet of soil excavated from the burial pits, it would be easy to find evidence for human remains of the quantity alleged by the witnesses. It must also be

---

<sup>113</sup> *Ibid.*, p. 1243.

<sup>114</sup> *Schlag nach! Natur*, Bibliographisches Institut, Leipzig 1952, p. 512.

<sup>115</sup> Cf. A. Donat, *op. cit.* (note 38), p. 181; Y. Arad, *op. cit.* (note 38), pp. 171, 176.

noted that in the incineration of corpses under the conditions specified by the witnesses, the bones would not have turned to ash, but would have remained as bones.

The witnesses have described how the skeletal remains of the corpses were broken up, and screened and sifted over and over again to ensure that no evidence would remain. Given the primitive equipment described by the witnesses – wooden rollers and thin sheets of metal for crushing the bones – it might have been possible for a man to break up and sift two skeletons per hour in the manner specified. Thus, if one Jewish laborer had pulverized 20 skeletons per day, 240 Jewish laborers would have been needed for this task alone. Adding up the required personnel – 5,600 Jewish laborers for obtaining the wood, 240 for pulverizing the bones, and 150 to stoke the fire sites – fully 6,000 Jewish workers were needed to complete all the required tasks in a solid seven-day work week. Additionally, further hundreds of Jewish workers would have been needed to carry out various other tasks reported by witnesses: excavating and filling trenches, camouflage activities, sorting the valuables of the murdered Jews, cutting the hair and extracting the gold teeth of the victims, rendering services to the SS, administration, rations and supplies for the camp, etc. There would also have to have been reserve labor standing by at all times. Thus the camp would have had to have a permanent workforce of at least 8,000. This number stands in glaring contrast to the mere 700 Jewish laborers attested to for Treblinka.<sup>116</sup>

And finally, we must note that the teeth of the supposed victims could not have been destroyed by the primitive methods attested to.<sup>117</sup> Even if each of the alleged victims had only 20 of the usual 32 teeth left at the time he or she died, there would have been at least 17.5 million teeth to be disposed of at Treblinka. This means that we should still be able to find some 5 teeth per cubic foot of the 3.53 million cu.ft. of material excavated at the alleged site of the crime.

All these calculations are based on the number of victims (875,000) specified by the Jerusalem court. If, on the other hand, one were to postulate the 3 million Treblinka victims alleged by Grossmann and others, then the data ascertained in the previous must be multiplied by a factor of 3.5, meaning: 6,650 metric tons of wood daily to cremate the corpses; a total of approximately 1,200,000 tons of firewood, *i.e.*, almost two million trees, for whose transport trains totaling about 252 miles would have been required. The area of the forest thus required amounts to 9 square miles. There would have been roughly 13,700 tons of ashes to hide, containing at least 60 million teeth. And where on earth were the 20,000 Jewish laborers needed to do all the work involved?

#### 4.4. The Polish Forensic Investigations of November 1945

As already mentioned, from November 9 to 13, 1945, a group of experts assembled by the Polish state attorney's office conducted an inspection tour of Treblinka. What they found there was described in a report composed after the trip by a member of the group, Judge Z. Lukaszkiwicz, as follows:<sup>118</sup>

*“Protocol of the work which has been performed on the grounds of the death camp Treblinka, which forms the object of the judicial examination.*

*From 9 to 13 November 1945 the examining magistrate of Siedlce, Z. Łukaszkiwicz, together with the State Attorney for the District Court of Siedlce, J. Maciejewski, performed the following tasks on the camp grounds:*

*9 November 1945*

<sup>116</sup> J. Wiernik, in A. Donat, *op. cit.* (note 38), p. 155.

<sup>117</sup> Cf. some relevant forensic studies, set out by A. Summers, T. Mangold, *The File on the Tsar*, Victor Gollancz Ltd., London 1976; also C. Loos, “Où sont les traces de millions de brûlés?”, *Revue d’Histoire révisionniste* 5 (1991), pp. 136-142 (online: [www.lebensraum.org/french/rhr/Loos.pdf](http://www.lebensraum.org/french/rhr/Loos.pdf)).

<sup>118</sup> This report is reprinted in S. Wojtczak, “Karny obóz pracy Treblinka I I ośrodek zagłady Treblinka IP”, in: *Biuletyn Głównej Komisji Badania Zbrodni Hitlerowskich w Polsce*, XXVI, Warsaw 1975, p. 159-164.

*Excavations were begun on the grounds using the services of 20 workers who had been mustered by the community administration for duty as road laborers. The excavations began at the location described by the witness Rayzman, on 6 November, where the so-called 'camp hospital' had stood and where, according to the witness, a mass grave is supposed to exist. Since at the said location a 4 to 5-meter deep bomb crater is present – two bombs still lie at a slight distance from this crater – the digging was begun in this crater. In the course of this work numerous Polish, besides Russian, German, Austrian and Czech coins, as well as broken pieces of various kinds of containers were discovered. At the end of the work, at approximately 3 P.M., at a depth of 6 meters, we encountered a stratum which had not been previously uncovered. There were no human remains found.*

*10 November 1945*

*The work was continued, with 36 workers assigned who had been commandeered for road labor. At a depth of 6 meters a stratum begins which has never before been uncovered by anyone. It consists partly of all sorts of kitchen utensils and different kinds of household objects; there are pieces of clothing besides. At a depth of 7 meters, we reached the floor of the pit – a stratum of yellow sand which is not mixed with gravel. By means of expansion of the excavation we succeeded in determining the shape of the pit. It has sloping walls, and the bottom measures about 1.5 meters [sic!] Presumably, the pit has been excavated with a dredge. During the course of the excavations, numerous more or less badly damaged Polish documents were discovered, and further a badly damaged personal identity card of a German Jew, as well as several more coins: Polish, German, Russian, Belgian and even American. After we had made certain that this pit, filled with broken pieces of the containers mentioned, ran in a north-south direction on the grounds of the camp property – 2 meters more [in a northerly direction] had been excavated – the workers started work at this location.*

*11 November 1945*

*A series of test excavations were performed at the place where the [gas] chambers had to have been, in order to find their foundation walls if possible. Pits 10 - 15 meters in length and 1.5 meters deep were dug. Undisturbed strata of earth were revealed by this.*

*The crater produced by the explosions (numerous fragments attest to the fact that these explosions were set off by bombs), is, at maximum, 6 meters deep and has a diameter of about 25 meters – its walls give recognizable evidence of the presence of a large quantity of ashes as well as human remains – and was excavated farther in order to discover the depth of the pit in this part of the camp. Numerous human remains were found by these excavations, partially still in a state of decomposition. [...] The soil consists of ashes interspersed with sand, is of a dark gray color and granulous in form. During the excavations, the soil gave off an intense odor of burning and decay. At a depth of 7.5 meters the bottom was reached, which consisted of strata of unmixed sand. At this point the digging was stopped here.*

*13 November 1945*

*With the assistance of 30 workers employed for road work, the opening of a pit was begun – a site where refuse was deposited in the northeastern section of the camp. In this location, as the workers from the nearby hamlet had stated, a very large number of documents was found up till now. Work was begun at this location where the people [of that area] had dug a three-meter-deep pit in a search for gold. During the course of the digging, broken pieces of all sorts of kitchen containers as well as a large number of rags were continually found. Aside from the coins discovered so far, there were yet found Greek, Slovakian and French [coins], as well as documents in Hebrew and Polish, and remnants of a Soviet passport. At a depth of 5 meters, the work was stopped due to the steadily worsening weather conditions.*

*The Examining Magistrate The State Attorney*

*Łukasziewicz Maciejewski*

*Decision:*

*The Examining Magistrate of Siedlce, on 13 November 1945, in regard to the facts of the case, as is to be concluded from the witness testimony examined up till now and the results of the work carried out at the site and place, that with great probability, no mass graves are any longer to be found today on the grounds of the former camp, and with consideration of the oncoming autumn, the present rainfall and the necessity of a rapid conclusion to the judicial preliminary investigations, makes the decision, in view of all these facts, to stop the work on the territory of the former death camp Treblinka.*

*The Examining Magistrate*

*Łukasziewicz”*

The efforts of the commission to find evidence for the claimed enormous mass-murder in Treblinka had therefore proven themselves to be a complete failure. The experts had a spot excavated where, according to the witness Rayzman, a mass grave had been located, but discovered no trace of such a thing. At a place where, according to witnesses, the two ‘gas chambers’ had stood, they found merely layers of undisturbed earth. All of the objects they found, as well as human remains, merely showed that there had been a camp in Treblinka and that bodies had been buried or cremated there, but nothing furnished even a trace of proof for any mass murder, to say nothing of one amounting to many hundreds of thousands of people!

In October 1999, an expert team scanned the soil of the alleged extermination camp Treblinka with a ground penetrating radar. This device detects any disturbances of the soil layers, caused either by objects or by former digging activities, up to a depth of 65 feet. The data gathered showed no evidence of disturbance in the soil whatsoever.<sup>119</sup>

In 2002, Italian historian Carlo Mattogno and Swiss scholar Jürgen Graf published the first comprehensive monograph on Treblinka, further substantiating the thesis presented here, and providing plenty of circumstantial evidence that Treblinka was indeed a transit camp mainly for deported Polish Jews on their way to other camps, both east and south of Treblinka.<sup>1</sup>

## 5. Summary

To summarize the most important points of the previous:

1. Eyewitness testimony regarding the location, dimensions and internal structure of the supposed extermination camp Treblinka are utterly inconsistent and contradictory, and virtually impossible to reconcile with actual facts.
2. The alleged killing methods reveal an outlandish imagination. For this reason all the alleged killing methods other than the Diesel technique have generally been consigned to the Memory Hole.
3. However, Diesel exhaust gas is not suited to mass murder of human beings.
4. The introduction of exhaust gas from heavy Diesel engines into a hermetically sealed, brick-walled room results in the destruction of the facility in question. The same goes for the removal of the air from such rooms.
5. Given the size of the rooms and the great numbers of victims hermetically locked up in them, as described by the witnesses, death by asphyxiation would have occurred within a relatively short time.
6. The burial pits and cremation sites described would have covered an area far greater than the entire so-called death camp.
7. Empirical knowledge as well as the laws of physics prove that corpses cannot burn by themselves.

<sup>119</sup> Richard Krege, “‘Vernichtungslager’ Treblinka – archäologisch betrachtet”, *Vierteljahreshefte für freie Geschichtsforschung* 4(1) (2000), pp. 62-64. (online: [vho.org/VffG/2000/1/Krege62-64.html](http://vho.org/VffG/2000/1/Krege62-64.html))

8. The quantity of wood required for cremation of the victims would have been so great that there would most definitely be Reichsbahn papers documenting the transports, but no such papers have been found to date. There is also no evidence for the deforestation of large forested areas in the vicinity of Treblinka.
9. The witnesses make no mention of large quantities of fuel or of their transportation to the camp and the cremation sites.
10. Pulverizing more than 6.6 million pounds of bones with wooden rollers, sheets of metal, and sieves is not a method suitable for the elimination of evidence for human body parts.
11. The umpteen million teeth cannot be destroyed at all in this manner.
12. A minimum of 3,200 Jewish laborers would have been needed to manage all the work involved in the alleged elimination-without-a-trace of the bodies of the Treblinka gassing victims.
13. The existence of these great quantities of ashes and bones and the millions of teeth could still be conclusively proven even today.
14. An investigation that was ordered by a Polish court and included excavations in Treblinka yielded no proof for the claims of the witnesses. No large mass graves, no human ashes, and no signs of large-scale disturbances of the soil as entailed in the creation of mass graves or burning pits were found.
15. Analysis of German air photos as well as recent data gathered with ground penetrating radar has shown that no major disturbances of the natural ground structure occurred within Treblinka II or in its vicinity.
16. It is also proven that after the camp was dismantled the Germans had engaged in no camouflage activities – such as planting lupine or trees, as witnesses have claimed.
17. According to the December 2, 1941, edition of the official *Amtlicher Anzeiger* of the German occupation forces, Treblinka was to become a labor camp.<sup>120</sup> One might be surprised that the German occupation powers would officially announce the setting-up of the camp, but there simply was not anything secret about labor camps. The Malkinia camp was probably a transit camp for further transport to eastern settlements in Belarus and Ukraine.

In conclusion, it should be stressed once again that disputing (‘denying’) the Holocaust is still a criminal offense in the Federal Republic of Germany. The ‘self-evident nature’ of the Treblinka Holocaust as proclaimed by the courts is based solely on

*eyewitness testimony.*

In light of the circumstances described here, it is not surprising that by now even the staff of the Holocaust Memorial Site at Jerusalem admit<sup>121</sup> that the heart of the problem with the Treblinka camps is the

*eyewitness testimony.*

---

<sup>120</sup> Cf. M. Weber, *AHR* 3 (1987), pp. 127-142; M. Weber, A. Allen, *JHR* 12(2) (1992) pp. 133-158 (online: [vho.org/GB/Journals/JHR/12/2/WeberAllen133-158.html](http://vho.org/GB/Journals/JHR/12/2/WeberAllen133-158.html)).

<sup>121</sup> Cf. also the experiences of I. Weckert, described in her chapter in the present volume.

# Babi Yar: Critical Questions and Comments

HERBERT TIEDEMANN

“*Courage means seeking the truth and proclaiming it!*”

Jean Jaurés

1. Preamble

The subject of ‘Babi Yar’ is confusing in many respects. For a general overview, this brief summary shall therefore identify the major problem areas:

1. The mass murder at Babi Yar took place almost four months prior to the Wannsee Conference, where the killing was allegedly first planned.
2. Widely divergent dates are given for the murder.
3. Depending on the source, the number of victims varies by as much as two orders of magnitude.
4. Widely different methods and weapons are alleged for the murders.
5. There is also no consensus on where the killings took place.
6. The witnesses, or reports respectively, make highly contradictory claims in other respects as well.
7. The number of alleged victims by far exceeds the number of Jews remaining in Kyiv after the Soviet evacuation.
8. To date there has been no forensic investigation of the murder site and weapons. No attempts were ever made to ascertain and secure any evidence.
9. It is also odd that the Soviets would use a site as a location for a garbage dump and incineration area where countless victims were allegedly murdered by the archenemy during the ‘Great Patriotic War’.
10. And finally, the allegations are disproved by wartime air photos.

We shall employ standard scientific methodology to examine the issues briefly touched on above. Following some introductory information for a better general understanding of the topic, individual sections will present the first reports, eyewitness accounts, and other sources, and will discuss specific questions that arise in context. A separate section is devoted to general questions.<sup>1</sup>

## 2. By Way of an Introduction

The taking of Kyiv by the Germans on September 19, 1941, by no means heralded the end of unrest for this city. Kyiv had hardly been occupied when “*tremendous explosions occurred one after another.*”<sup>2</sup> On September 24, the Hotel Continental was blown up, along with the Headquarters of the rear area of the 6th Army. On September 25 a conflagration of the downtown area of Kyiv, Khreshchatyk, continued to spread. Mines had destroyed almost all public buildings – *after* the German troops had moved in, and many died. By the end of September a Soviet map for setting of delayed action mines had been found which showed about 50 objects readied for radio detonation. In addition, an enormous quantity of mines, explosives and ‘Molotov Cocktails’ had also been discovered. Most of the city center had burned down and some 50,000 persons were homeless. Hundreds of German soldiers had been

---

<sup>1</sup> For another thoroughly critical study of the alleged mass murder of Babi Yar with even more documents and reports about this event, *e.g.*, an unsigned copy of a document without letterhead, filed in *Bundesarchiv – Militärarchiv*, rev. RH 26-454/28, (strange report of an unknown “*Kriegsverwaltungsrat*” from October 2, 1941), cf. esp. U. Walendy, “*Babi Yar – Die Schlucht ‘mit 33,771 ermordeten Juden’?*”, in *Historische Tatsachen* No. 51, Vlotho 1992.

<sup>2</sup> General Jodl, on June 4, 1946, in Nuremberg before the International Military Tribunal, *Trial of the Major War Criminals*, IMT, Nuremberg 1947, v. XV, p. 329.

killed fighting the fires. Many organized saboteurs and partisans were left behind in the city abandoned by the Soviets; Kyiv was still a battlefield.

According to a document of a rather suspicious origin presented at the International Military Tribunal (IMT), all Jews were allegedly arrested and 33,771 of them were executed on September 29 and 30 in retaliation for the ‘arson’.<sup>3</sup>

Prior to the evacuation, about 175,000<sup>4</sup> but possibly as few as 160,000<sup>5</sup> Jews lived in Kyiv. Yet Einsatzgruppen Event Report No. 106 of October 7, 1941, claims:

“The number of Jews allegedly amounts to 300,000 [...].”<sup>6</sup>

The Jews were allegedly instructed, by means of a poster,<sup>7</sup> to bring their possessions and gather at a street corner on September 29, 1941. From there, it is said, they would be marched to Babi Yar at the northwestern outskirts of Kyiv.

‘Babi Yar’ translates roughly as ‘Ravine of Old Women’. It is not, however, a ravine, but rather a branching system of erosion channels, from 30 ft. to about 3,000 ft. across and from zero to about 150 ft. depths at the wider sections of the larger western gorges.

The eastern part of this erosion feature was about 1,300 ft. in length and a maximum of 30 ft. in width and extended from the north approaching the Jewish Cemetery lying on its eastern side to about 200 ft. This Cemetery measured roughly 1,300 ft. × 1,000 ft. The broader branch of this erosion feature is located about ¼ mile farther to the west. To the south of the Jewish Cemetery is Melnikowa Street, and to the southeast there is a large military camp that already shows up on air photos dating from May 17, 1939.<sup>8</sup> Not the erosion gully next to the Jewish Cemetery, but the entire extensively fissured area was called Babi Yar. On September 29 and 30, 1941, it is said, countless victims – most of them Jews – were murdered there. But also in this case, no one ever took the trouble of confirming the various allegations and witness statements by means of detailed forensic investigations. An objective analysis is thus required.

### 3. Initial Reports

1. On October 21, 1941, the London office of the Jewish Telegraphic Agency (JTA) reported that the pro-NS Ukrainian newspaper *Krakiwski Wisti*, published in Krakow, had written

“[...] that soon after the occupation of the city [Kyiv], all Jews, including men, women and children of all ages, were taken from their homes and driven into barbed-wire enclosures located at the outskirts of Kyiv. From there they were driven by foot to an undisclosed destination.”<sup>9</sup>

- Some 160,000 to 170,000 Jews, but according to Einsatzgruppen Event Report 106 as many as 300,000 Jews, lived in Kyiv at the start of the war. The orderly gathering and transfer of such great numbers of people would have been noticed by countless witnesses, all of whom would

---

<sup>3</sup> Document R-102 in *IMT* v. XXXVIII, pp. 292f.

<sup>4</sup> *Encyclopaedia Judaica*, Keter Pub. Ltd., Jerusalem, and Macmillan, New York 1971, v. 10, p. 994.

<sup>5</sup> Yisrael Gutman (chief ed.), *Encyclopedia of the Holocaust*, Macmillan, New York 1990, v. 1, pp. 133f.; cf. E. Jäckel, P. Longerich, H. J. Schoeps (eds.), *Enzyklopädie des Holocaust*, Argon, Berlin 1993, v. 1, pp. 144ff.

<sup>6</sup> *Bundesarchiv* [Federal Archives] Koblenz, R 58/218; J. Mendelsohn (ed.), *The Holocaust*, Garland, New York 1982, v. 10, pp. 51ff.

<sup>7</sup> E. R. Wiehn (ed.), *Die Schoah von Babi Yar*, Hartung-Gorre, Constance 1991, pp. 7f., 84, 86, 137, 141, 143f., 166f., 195f., 477.

<sup>8</sup> US National Archives, Record Group No. 373, exposure no. 45.

<sup>9</sup> A copy of this newspaper can be obtained from Polish Historical Society, PO Box 8024, Stamford, CT 06905. The report was written by the leaders of the Central Ukrainian Charitable Committee (Krakow) who arrived in Kyiv on Sept. 29, 1941, for their first visit of the ‘liberated’ capital of Ukraine. The leader of this mission was Prof. Kubyiovych, editor of the *Encyclopedia of Ukraine* (cf. note 61). I owe this information to Dr. Myroslaw Dragan.

have attested to a ‘mass migration’ of people with their possessions. Why are there no such witnesses?

- The report mentions neither a date nor a place. It is claimed that the Jews were driven on foot from barbed-wire enclosures to an unknown destination, but not that they were murdered “*at the outskirts of Kyiv*”.
  - During March 1996 major Ukrainian newspapers reported that Ukrainian American historians determined that the Jews were deported from Babi Yar via the nearby military railroad station to Minsk. During the stay behind barbed wired enclosures, Germans allegedly extracted from the Jews the customary war tax in valuables.<sup>10</sup>
2. On November 13 the secret broadcasting station of the Polish Underground in Lvov (Lemberg) issued another report,<sup>11</sup> which was passed on through Warsaw and was received and deciphered in London on November 17 via 819 Selim, a secret Polish receiving station in Istanbul:<sup>12</sup>

*“Germans and Ukrainians are slaughtering Jews by the thousands: in Kyiv 35,000 [have been] shot, about 3,000 small children were murdered with clubs by Ukrainians [...].”*

- The tale of the clubbing murders was not publicized by the Polish government-in-exile.
  - How could the Jews be shot in Kyiv if, according to 1., they had been driven off to an unknown destination?
  - Why is no place or date given despite the importance of the message?
3. On November 16, 1941, the JTA then offered the following cryptic message:<sup>13</sup>

*“Somewhere in Europe [...] from an unimpeachable source that 52,000 men, women and children [...] were mercilessly and systematically executed [...] in accordance with the cold-blooded Nazi policy of extermination [...].”*

- This hair-raising news flash was squeezed in among rather trivial reports. And this despite the fact that it could have prompted an international outcry?
  - Why, again, are the place and date, as well as further details, not given?
  - Was the *Jewish Telegraphic Agency* aware of the “*cold-blooded Nazi policy of extermination*” even before the ‘Nazi’ authorities themselves, who were responsible for the Final Solution and who were not even superficially briefed on the matter until January 20, 1942, at the ‘Wannsee Conference’?
4. On December 31, 1941, the JTA wrote:<sup>14</sup>

*“[...] the latest report from Kyiv which reached here today through secret channels gives a horrible picture of what has happened to the Jews in that city since the Nazi occupation. The report reveals that in addition to executing practically the entire Jewish male population of Kyiv on the charge that the Jews who remained in the city were ‘Soviet spies and guerrillas’, the Nazi military command ordered thousands of Jews confined in mined cemetery grounds. The victims, most of them women, were blown up by the exploding mines. Those who survived were machine-gunned to death*

<sup>10</sup> Cf. Voldymyr Katylnyckyj in *The Kyiv Evening News*, March 16-19, 1996; a few days later this was allegedly reprinted in *For Free Ukraine* (Lviv). On July 10, 1997, the body of Katylnyckyj and his mother were found with multiple stab wounds in their modest apartment. This unchecked information were supplied by Myroslaw Dragan. Radiogram No. 346/KK.

<sup>12</sup> M. Wolski, *Fact Sheet on the Occasion of the Fiftieth Anniversary of the Babi Yar Massacre*, Polish Historical Society, PO Box 8024, Stamford, CT 06905, Oct. 1991, pp. 2f.; cf. M. Wolski, *Revue d’Histoire Révisionniste* 6 (1992), pp. 47-58 (online: [www.lebensraum.org/french/rhr/Babiy.pdf](http://www.lebensraum.org/french/rhr/Babiy.pdf)).

<sup>13</sup> J. Patek, *Memorial Services Commemorating the 50th Anniversary of Babi Yar Could be Attenuated by Aerial Photos Showing Absence of Mass Graves There* (unpub. MS).

<sup>14</sup> *JTA Daily News Bulletin*, v. VIII no. 316, Wed., Dec. 31, 1941: “*Retreating Nazi Armies Intensify Anti-Jewish Terror in Ukraine*”, Jewish Telegraphic Agency, New York.



*by the German soldiers. (Earlier reports estimate that 52,000 Jews were murdered in Kyiv when the Nazis first occupied the city.)”*

And in the following paragraph:

*“[...] the Nazi military forces [...] issued an order in the middle of December requesting all the remaining Jews in Kyiv to report to the occupation authorities on a certain date. Aware of the fact that the order meant a new Jewish massacre, many Jewish mothers killed their children and committed suicide, while elderly Jews threw themselves to death by jumping from open windows [...].”*

- Did the armed forces commit the atrocities?
  - The men were shot. Where? When? The women were blown up by exploding mines, and in a cemetery. What happened to the children?
  - The latter would have required many tens of thousands of anti-personnel mines, which would then have been unavailable for more important use in the war. It takes a considerable amount of time and work to mine an area. And how were the bodies removed from the mined area afterwards?
  - How does the story of the Jews remaining in Kyiv fit in with the other reports?
  - How likely are the infanticides and suicides? Any witnesses?
5. On January 6, 1942, Vyacheslav Molotov, the Soviet People’s Commissar for Foreign Affairs, announced to the governments allied with the Soviet Union:<sup>15</sup>

*“A large number of Jews, including women and children of all ages, was gathered in the Jewish Cemetery of Kyiv. Before they were shot, all were stripped naked and beaten. The first persons selected for shooting were forced to lie face down at the bottom of a ditch and were shot with automatic rifles. Then the Germans threw a little earth on them. The next group of people selected was forced to lie on top of them, and shot, and so on.”*

- It takes many workers and a great deal of time to strip and beat up tens of thousands of people. And how long would it take to force as many people as constitute the entire population of a medium-sized city, to lie down in groups at the bottom of a ditch? How many people would it take to shovel a layer of earth over each layer of bodies?
  - To shoot people with automatic rifles, one needs at least twice as many bullets as there are people to be shot. 100,000 rifle bullets weigh about 2,820 pounds. Since especially their lead core survives for practically forever, finding them ought to be an easy matter. Why have no investigations ever been conducted? Why do none of Kyiv’s inhabitants mention the noise of firing?
  - Automatic rifles?
  - About 1,060,000 cu.ft. of soil must be excavated to accommodate 50,000 bodies. When was this excavation done, and by whom? Even given a mass grave depth of about 16 ft., the graves would have taken up more than 64,500 sq.ft. of space. Excavation problems, and the resultant time required?
  - Why do the needle-sharp air photos show not even the slightest trace of any disturbances of the ground?<sup>16</sup>
  - Molotov’s alleged location contradicts other testimony.
6. The *JTA* report of March 15, 1942:<sup>17</sup>

*“240,000 Jews executed by Gestapo in Ukraine”*

and

---

<sup>15</sup> V. M. Molotov, *The Molotov Notes on Nazi Atrocities*, The American Council on Soviet Relations, New York Jan. 6, 1942, p. 14.

<sup>16</sup> J. C. Ball, *Air Photo Evidence*, Ball Resource Services Ltd., Delta/BC, 1992, pp. 106ff.; cf. his chapter, this volume.

<sup>17</sup> Jewish Telegraphic Agency, *Daily News Bulletin*, March 15, 1942, p. 1, JDC Representative Reports.

“burying Jewish victims at one great tract of land, near Kyiv, by Germans even before life left them [...] ground moving in waves.”

Patek also comments on this:<sup>18</sup>

“S. Bertrand Jakobsen, chief representative of the American Jewish Joint Distribution Committee, [...] quoted one Hungarian soldier declaring that [at] one great tract of land, near Kyiv, the Ukrainian capital, he saw the ground move in waves. The Germans, he said, had just conducted mass executions of Jews and had buried their victims even before life had left them.”

- Place?
  - Date?
  - Murder weapons?
  - How can a ground move in waves?
  - Were spectators admitted – Hungarian soldiers, for example?
7. On July 20, 1942, the *Podziemna Obsługa Prasy Pozagettowej*, the Warsaw ghetto’s underground press agency, claimed:<sup>19</sup>

“Not a single Jew is left in Kyiv because Germans have thrown the entire Jewish population in Kyiv into the river Dnjepr.”

- Was there not one among all those tens of thousands who could swim? This killing method would have endangered the troops’ own water supply, while also causing a very considerable danger of epidemic – a nightmare for any troop commander.
  - The bodies would have drifted downstream and been noticed by countless witnesses. Why are there no such witnesses?
8. On October 28, 1942, it was reported:<sup>20</sup>

“[...] killing the Jewish victims by Germans on the site of the former Zaitsev’s brick factory in Kyiv, followed by carting and dumping of bodies into the Dnjepr river.”

- Another version of the murder and the murder site!
  - How were they killed? Why are there no witnesses?
9. The same issue adds yet another variant on the murder:<sup>20</sup>

“[...] 32 Jewish orphans in the woods who were lined up and then the Nazis deliberately drove their tanks over these children, crushing all of them, and compelled the accompanying 118 non-Jewish orphans to bury them.”

- Did the German armed forces have nothing more pressing to do than to engage in murderous tank maneuvers in the woods? The German tanks of that time were not very well motorized and quite slow, and poorly suited for use in the woods and for such a task. Their chains were only about 12 inches wide, while the ground clearance was large, approximately 18 inches. Close-range visibility out of tanks was very poor.
  - Where are the witnesses from among the 118 non-Jewish orphans?
  - How credible is it that the murderers would let 118 witnesses (children!) watch?
10. W. H. Lawrence reports from Kyiv:<sup>21</sup>

“50,000 Kyiv Jews Reported Killed.”

<sup>18</sup> J. Patek, *op. cit.* (note 13); cf. E. R. Wiehn, *op. cit.* (note 7), p. 102.

<sup>19</sup> “Kijow”, in *Podziemna Obsługa Prasy Pozagettowej*; cf. Archives of the Jewish Historical Institute in Warsaw, Ringelblum-I file, p. no. illegible, July 18, 1942.

<sup>20</sup> *JTA Daily News Bulletin*, “Systematic Execution of Jews in Nazi-Occupied Russia Reported by Partisans”, by JTA from Kujbishev; JTA New York edition, Oct. 28, 1942, p. 3.

<sup>21</sup> H. W. Lawrence, “50,000 Kyiv Jews Reported Killed”, *New York Times*, Nov. 29, 1943, p. 3.

- Instead of specifics regarding the place, date, murder weapons and further evidence, the *New York Times* wrote:

*“The evidence remaining is sparse.”*

11. On the evening of February 28, 1944, Radio Moscow reported about German atrocities in Kyiv. They come up with another method of murder:<sup>22</sup>

*“More than 195,000 Soviet citizens were tortured to death, shot, or poisoned in murder vans by the Germans during the occupation of Kyiv.”*

- Date? Place? The number of victims has grown to almost 200,000, which would make it even easier to secure evidence. Why was this not done?
- ‘Gas vans’ are a very questionable killing method and are absent in later sources.<sup>4f.</sup>

## 4. Eyewitness Accounts

1. In November 1943, one “Aloshin” told W. H. Lawrence, reporter for the *New York Times*:<sup>21,23</sup>

*“[...] German troops [...] ordered them into the ravine, where they were directed to give up their valuables. Part of their clothing also was removed. Then [...] they were placed on a platform, machine-gunned and thrown into the ravine.”*

- So now it was the Wehrmacht who were the killers. Does this fit in with the other reports, for example the ‘Event Reports’?<sup>24</sup>
- How were the clothing and the valuables removed from the ravine?
- Mass murder on a platform? Why? And if so, then it would be possible for groups at most, not all at once. When was the platform built, and by whom?
- In a narrow, winding ravine, the line-ups of people to be executed cannot be very long. One cannot simply swing the machine gun/s in any large angle one might wish to, without endangering one’s own people, without losing accuracy and penetration at oblique angles, and without facilitating the escape of some of the victims.
- The bodies must be removed as the groups are executed, otherwise they would result in an enormous pile. If one allows ten minutes for the undressing, shooting and removal of the bodies from each group of at most 100 people, then the murder would have taken at least 83 hours.
- How is it possible to lead the victims into the ravine and then throw them into that same ravine after shooting them?
- In late September dusk comes relatively early in Kyiv. On September 29 it rained heavily, all the roads were soggy, on the 30th it rained and snowed and road conditions grew even worse.<sup>25</sup> Since it is impossible to execute groups of any appreciable size in the dark, the murder could have been carried out only during the daylight hours, *i.e.*, it would have taken more than a week. Bright floodlights are not an option in wartime, especially near the front – and with partisans in the vicinity. And Wiehn<sup>26</sup> raves about beautiful September days!

---

<sup>22</sup> J. Patek, *op. cit.* (note 13), p. 9.

<sup>23</sup> *The Black Book*, Nexus Press, New York 1946 (repub. 1981), p. 360. The Literature Commission of the Soviet Anti-Fascist Committees, chaired by Ilya Ehrenburg, brought various eyewitness accounts into circulation between 1944 and 1980. These statements were incorporated into various “*Black Books*” published in the Soviet Union, Romania and Israel. For example, Gutman, *op. cit.* (note 5, v. 1, p. 135), refers to *The Black Book of Soviet Jewry*, New York 1981, by Ehrenburg and Grossmann.

<sup>24</sup> For a more detailed critique of all event reports referring to Babi Yar, cf. U. Walendy, *op. cit.* (note 1), pp. 22-32.

<sup>25</sup> U. Walendy, *ibid.*, p. 30.

<sup>26</sup> E. R. Wiehn, *op. cit.* (note 7), p. 20.

2. Vilkis, a Jew born in Odessa, reports:<sup>13,27</sup>

*“[...] a near-by Jewish cemetery, where marble grave markers were removed and brought to Babi Yar, where they formed crude stoves [...] but (the bodies) did not burn well because of lack of draft.”*

- Vilkis goes on to claim that the Germans sent prisoners into the cemetery to get the iron rails from the graves, which were then used to construct cremation grates. During the cremation the Germans had also brought other victims in murder vans in which they had been asphyxiated. These too, he contends, were cremated.
- People and transportation are required to move marble grave markers. Why has no one ever searched for these grave stones as evidence?
- How many such oven gratings would one need to construct in order to cremate that many bodies in so crude a manner? Would it even work at all?
- Where did the enormous quantities of fuel come from? Based on findings from India – the only country where bodies are cremated in the manner under discussion here – we note: To achieve a marginally adequate, but nevertheless still only partial cremation, 200,000 bodies would require at least 51 million pounds of firewood – a pile 3 ft. high, 3 ft. wide and 34 miles long. Who cut this firewood, and where? How was this huge quantity transported? Who carried the countless bodies to the cremation site? Who removed the remains? Where are the witnesses from among this veritable army of laborers? The claim that cremation gratings were constructed from graveside rails is even less credible; these gratings would have collapsed almost immediately due to the heat.

3. The unnamed son-in-law of one Chaim Shapiro who was taken to Babi Yar recounts:<sup>13</sup>

*“At the cemetery the Jews were forced to undress. Fifty six thousand (56,000) Jews were slaughtered. Those who did not die instantly were buried alive. [...]*

*[...] on the tenth day [after the shooting] we were driven to Lukianova [Babi Yar] ravine. We stood there panic-stricken. From beneath the freshly strewn earth streamed rivers of blood, the blood of 56,000 murdered Jews. It cried to us from under the earth. My hair turned gray that morning.”*

- From where does Chaim Shapiro’s son-in-law get his information? What is his name, anyhow? Why was he not among the victims? After all, wasn’t everyone allegedly killed? What was the date? Where is the murder site? Why is the place where the victims undressed not the same as the other witnesses claim?
- What would a forensic doctor say about the rivers of blood allegedly streaming from bodies killed ten days earlier?
- The part about the blood crying from the earth is from the Bible; in Genesis 4:10 we read:
 

*“The voice of thy brother’s blood crieth unto me from the ground.”*
- Can hair spontaneously turn gray?
- Were Jews forcibly driven to the site of the mass murder in order to produce witnesses?

4. In E. R. Wiehn’s book, L. Levitas<sup>28</sup> tells of one Riva Kogut, who was later known as Raissa Genrichovna Dashkevich:

*“Early on September 29 the Kyiv Jews walked in a continuous line in the direction of Syretz to the train station [...] First the documents were taken away and [...] thrown onto a pile, at the next point the luggage was taken away, [...] already on the grounds of the Jewish cemetery the people were forced with clubs to undress and were then driven to the ravine. That was the ravine of Babi Yar.*

<sup>27</sup> *The Black Book*, Nexus Press, New York 1946, p. 361.

<sup>28</sup> E. R. Wiehn, *op. cit.* (note 7), pp. 252f.

*Then the people were driven [...] down the slope of the ravine. [...] where narrow, terrace-like places had already been prepared. [...] From the opposite side came the thunder of machine guns. There, [...] hundreds of Jews were shot. [...] Everything happened so fast, [...] blows [...] dog bites [...]. The people lost their minds, many turned gray with horror. [...] A severe chill and the pain in my head forced me to move, I began to climb up. [...]"*

- Multiple graying of the hair?
  - To the train station?
  - Beaten up on the cemetery grounds?
  - Narrow terraces had been prepared? By whom? When, in the brief time since the taking of Ky-iv?
  - Gunned down with machine guns from across the ravine?
  - Dog bites? Hundreds of victims – not tens or even hundreds of thousands?
5. Dimitri Orlow, one of the alleged witnesses quoted in a 1980 Black Book from the ‘Holocaust Library’,<sup>29</sup> testified:

*“An entire office operation with desks had been set up in an open area. The crowd waiting at the barriers erected by the Germans at the end of the street could not see the desks. Thirty to forty persons at a time were separated from the crowd and led under armed guard for ‘registration’. Documents and valuables were taken away. The documents were immediately thrown onto the ground, and witnesses have testified that the square was covered with a thick layer of discarded papers, torn passports, and union identification cards. Then Germans forced everyone to strip naked: girls, women, children, old men. [...] Their clothing was gathered up and carefully folded. Rings were ripped from the fingers of the naked men and women, and these doomed people were forced to stand at the edge of a deep ravine, where the executioners shot them at pointblank range. The bodies fell over the cliff, and small children were thrown in alive. Many went insane when they reached the place of execution.”*

- Orlow allegedly saw all of this in the space of a few minutes, from the grounds of a cable factory.<sup>30</sup>
- Date? Where was the office operation set up? How much personnel and time would the various operations require? Soviet citizens did not carry passports! Corroborating witnesses???
- Even if the people at the barriers could not see the desks, they would not have failed to hear the gunfire. Why was there no attempt at escape, especially after dark? The rugged, fissured region was ideally suited for hiding.
- At this point, an important general note. More than half of the alleged route taken to the execution site ran through built-up urban areas. Why did Stalin’s thugs fail to locate decent witnesses even in this area? Why are there also no witnesses or reports from the Wehrmacht? Vacationers, for example, would hardly have kept such horrible goings-on to themselves.
- We learn that groups of thirty to forty persons at a time were led off under armed guard. How much time would this alone take?
- Children and girls? According to Jewish and Soviet sources almost everyone except for the elderly had been evacuated in time (for example, cf. the sources quoted by Sanning<sup>31</sup>).
- It would take a very long time to carefully remove and fold the clothing of such great numbers of people.

---

<sup>29</sup> I. Ehrenburg, W. Grossmann (eds.), *The Black Book*, Holocaust Library, New York 1980, p. 7; cf. J. Patek, *op. cit.* (note 13) as well as E. R. Wiehn, *op. cit.* (note 7), p. 147

<sup>30</sup> Cf. E.R. Wiehn, *ibid.*

<sup>31</sup> W. N. Sanning, *The Dissolution of Eastern European Jewry*, Institute for Historical Review, Torrance, California 1983; German ed.: *Die Auflösung des osteuropäischen Judentums*, Grabert, Tübingen 1983, ch. 2 and 4.

- So here the victims are standing at the edge of a deep ravine, in other words not *in* the ravine. Do people who were exposed to such an awful situation forget in only a very few years where the victims stood?
  - The bullets that missed their targets still flew a long way! What measures were taken to ensure that German units were not accidentally shot in the process? One of the military camps, for example, was only about a fifth of a mile away from the execution site.
  - The gradient of the pile of bodies soon becomes problematic. The executed victims must be moved off. Imagine, if you will, how long it would take two persons to extract one body from the bloody pile (which does not offer a very stable surface to stand on), to move it many dozens of yards on average, to deposit it and then to return to the pile of corpses. The place had to be cleared prior to new executions, and then to be manned. Added to this is the bringing-in of the earth and the covering of the mass graves with that earth. Why are there no witnesses for any of this either? Why do the air photos not show any traces of all this?
  - Small children were thrown in alive. Were they sorted out first? Or did the executioners shoot past them? Was the shooting interrupted for this horrible activity? Where was the cable factory from where Orlow was able to observe all this in a few minutes?
6. According to Orlow,<sup>13</sup> other witnesses said that Germans “*dashed the little ones against the rock*”. Anyone who reads the Bible attentively will find that Holocaust tales are nothing new to the Jews (Genesis 6, Genesis 19:24, Exodus 11, Joshua 6, Matthew 2:16). Furthermore, pious people in particular draw inspiration from scripture. Psalms 137:9:
- “Happy shall he be, that taketh and dasheth thy little ones against the stones.”*
7. Tamara Mikhasev:<sup>7,13,32</sup>
- “[...] a young Russian woman whose Jewish husband was a Commander in the Red Army [...] left the place of execution with an ethnic German who was married to a Jewish woman. [...] This Russified German picked up the boy [his son] again, kissed his eyes and said farewell to his wife and mother-in-law.”*
- So a young Russian woman and an ethnic German were admitted as spectators at the execution site, to witness the top-secret mass execution of the Jews?
  - Mikhasev embellishes her story with the barking of many dogs, and with dance melodies blaring from loudspeakers to drown out the screams of the victims.<sup>33</sup>
8. The Jewess Nesya Elgort tells us:<sup>7,13,34</sup>
- “With her little son [she] miraculously escaped [...] untouched by the bullets [...] [from] under a heap of warm bloody bodies [...] hundreds and thousands of bodies piled on top of each other.*
- [...] It is now difficult for me to understand how I got out of that ravine of death, but I crawled out, driven by an instinct for self-preservation.”*
- Neither Nesya Elgort nor her little son was hit by a bullet! How did she manage to crawl out – with her child! – from beneath an enormous pile of bodies? Even with optimum positioning – which is more than unlikely, given the circumstances – the bodies would ultimately have weighted down the thoraces of mother and son to the point where breathing became impossible. One must also ask whether she or the child would not have been harmed by the impact of a body falling down on them, even from as little as 6 to 10 ft. above?
  - She escaped unnoticed from the ravine. Were there no guards?

<sup>32</sup> I. Ehrenburg, W. Grossmann (eds.), *op. cit.* (note 29), pp. 3, 8.

<sup>33</sup> E.R. Wiehn, *op. cit.* (note 7), p. 148.

<sup>34</sup> I. Ehrenburg, W. Grossmann (eds.), *op. cit.* (note 29), pp. 8f.

- Why were only women able to escape, but not a single one of the men, who in this case would have been physically better qualified?
9. The Jewess Yelena Borodansky-Knysh arrived at Babi Yar<sup>7,13,35</sup>
- “[...] [when] *it was already dark. [...] They took our clothing [...] and led us about fifty meters away, where they took our documents, money, rings, ear-rings. They wanted to remove the gold teeth of one old man, and he tried to resist.*
- “[...] *At about midnight the command was given in German for us to line up. [...] A second later bodies started falling on me. [...] We were sandwiched between bodies. [...] A German soldier was checking with a bayonet to make sure no one was still alive. By chance he was standing on me, so the bayonet blow passed me.*
- “[...] *I freed myself, got up, and took my unconscious daughter in my arms. I walked along ravines. [...] Crawling over ravines, I made my way to the village of Babi Yar.*”

She also provides this sideline story from the place of horror:<sup>36</sup>

*“I’ll never forget one girl, Sara; she was about fifteen years old. I can’t describe how beautiful she was. Her mother was [...] killed with a rifle butt [...]. Five or six Germans stripped [the girl] naked, but I didn’t see what happened after that. I didn’t see.”*

- Why did this witness not arrive at Babi Yar until after dark? On what day, anyway? Many witnesses would have noticed the great crowd of victims-to-be between the time of their morning gathering at the street corner and their much later arrival at the undressing-place. Where are all these witnesses?
  - The Jews allegedly had to report on the morning of September 29. But the murder took place not only on the 29th, but on September 30 as well. Wiehn<sup>37</sup> even claims that “*the death march lasted three days and three nights.*” Where did the tens of thousands spend the night (or nights)?
  - According to this version, the victims were first stripped naked and then, about 50 meters away, relieved of documents, money and jewelry. Was the procedure changed every few minutes?! Why has no other witness mentioned that the victims’ teeth were checked? How much time would that have taken?
  - Did the Kyiv Jews understand orders given in German?
  - How can the German soldier have stood on Yelena Knysh if she was covered by bodies? How much time would it take to climb over mountains of bodies in order to kill anyone still living with a bayonet? Were victims not buried alive after all?
  - Where exactly is the village of Babi Yar??? How likely is the story of the girl Sara’s forcible stripping by five or six Germans, perhaps even within the range of machine gun scatter?
10. One single eyewitness was permitted (or ordered) by the Soviets to testify abroad. In 1968 Dina Pronitscheva testified in Darmstadt in the trial of 11 members of *Einsatzkommando 4a*. The case files are kept under lock and key!

Philip Shabecoff, reporter for the *New York Times*, wrote:<sup>38</sup>

*“When the shooting stopped, the walls of the ravine were dynamited and the rubble was shovelled over the bodies of the men, women and children who lay in it. Some were still alive when buried.”*

What A. Kuznetsov learned from Pronitscheva and incorporated into his novel *Babi Yar*<sup>39</sup> does not agree with other testimony, for example:

---

<sup>35</sup> *Ibid.*, pp. 9f.

<sup>36</sup> E.R. Wiehn, *op. cit.* (note 7), p. 149.

<sup>37</sup> *Ibid.*, p. 146.

<sup>38</sup> “*At Babi Yar Trial only Four Spectators*”, by Philip Shabecoff reporting from Darmstadt, *The New York Times*, Feb. 14, 1968, p. 11.

“[...] *machine-gunning of the Jews by German soldiers across the width of the Babi Yar Ravine throughout the night, half in darkness, illuminated by a small bonfire.*”

But the matter becomes even more confusing when one reads Dina Pronitscheva's account in Wiehn's opus<sup>40</sup>. Significant differences in her recorded statement at the Darmstadt Trial are added in parentheses, with the note S:

*“On September 28, 1941, an order from the German authorities was posted throughout the city [...] about 8 o'clock in the morning [S: at 8 o'clock] near Djechtjarewska and Melnik Streets [S: Djachterowskaja and Melnikow] [...] my parents and my sister went to the meeting place [...] [S: It was very hot.] I accompanied them and then intended to return to my family [...] Large groups of people. [...] They were accompanied by Ukrainians, Russians, and citizens of other nationalities [...]. The streets [...] leading to the cemetery area were totally overcrowded with people. As we neared the gathering place we noticed the encirclement by German soldiers and officers [...] policemen, too. [S: Tank riders.] [S: We went up a hill:] [...] led us in groups of about 40-50 into a so-called 'Corridor' about 10 ft. wide which was formed by Germans standing close together on either side, with sticks, rubber truncheons and dogs [...]. Everyone was brutally beaten by the Germans. [S: Many fell down and were trampled to a thin pulp.] [At] the place at the end of the 'Corridor' [...] policemen stripped them [...] down to their underwear. [S: stark naked.] The beaten and stripped people were taken in groups to the ravine of Babi Yar [...]. They led us to a ledge over the ravine and began to shoot us with submachine guns. [S: machine guns.] [S: entirely different version: a German soldier offered her freedom in return for sex. She claimed to be a Russian, proved it by means of an employment book and union card, was then sent up a hill and not driven into the ravine with others until evening, on the orders of a German officer.] [...] when it was my turn I threw myself into the ravine alive [S: jumped into the pit.] [...]. Here, too, Germans and policemen went around and shot or beat to death anyone who was still alive [...]. One of the policemen or Germans turned me over with his foot, [...] stepped on my hand and my breast [S: he beat me] [...]. Then they began to [...] cover the bodies with soil and sand. [S: I remained lying under the soil.] I couldn't breathe anymore, freed myself of the earth with one hand [S: my right hand, on which the soldier stood, gave me trouble] and crawled to the edge of the ravine [...]. On the second day I saw the Germans chase an old woman and a boy of about 5 or 6 years, who had fled from the ravine. The old woman was shot, they stabbed the boy with a knife. About 30 ft. away from this spot seven Germans came along, leading two young girls. They raped them there and then stabbed them to death.”*

- Re. Shabecoff's report in the *New York Times*: who drilled the blast holes, where did the equipment come from, and why are there once again no witnesses to this considerable amount of work? Why is no trace of any of this visible on the air photos?
- Re. Kuznetsov: they shot across the ravine at night? Wouldn't that endanger even their own people?
- Re. what Wiehn<sup>7</sup> saw fit to publish, and re. Pronitscheva's testimony in Darmstadt, we have the following questions:
- About 8 o'clock or at 8 o'clock? Incorrect street names from a Kyiv resident? Why is her 'weather report' entirely wrong? How can one return to one's family when they had just been transported? How were the Ukrainians, Russians and citizens of other (which?) nationalities separated from the doomed? Where is the hill? Why did all the other witnesses forget the 'Beating Corridor'? What are Tank riders?
- Stripped down to their underwear, or stark naked? Employment book and union card retained even though she was stark naked? Ledge over the ravine? Ravine or pit? A hill? Submachine

<sup>39</sup> A. V. Kuznetsov, *Babi Yar*, Farrar Straus and Giroux, New York 1970, p. 109.

<sup>40</sup> E.R. Wiehn, *op. cit.* (note 7), p. 175ff.; cf. also P. Longenrich (ed.), *Die Ermordung der europäischen Juden. Eine umfassende Dokumentation des Holocaust 1941-1945*, Piper, Munich 1989, pp. 124-127.



guns or machine guns? Has anyone ever tried to turn, with his foot, a person wedged between other bodies? The soldier beat a girl he presumed was dead? What presence of mind a girl must have, not to shriek or to react in some other way when someone steps on her hand and breast, or beats her! Why did no one notice that she freed herself? Not even the soldier standing on her right hand? How daring must a girl be, to still observe events near the site of the crime two days later – and how insensitive to the cold, considering that she is either in her underwear or entirely naked. How likely is the tale of the proposition and of the girls who were first raped and then stabbed? Sexual intercourse with Jews was considered defilement of the blood, and was forbidden. Why did she understand German in Babi Yar, but not a word of that language in Darmstadt? Might her job – actress in a puppet theater – explain her facility at confabulation?

11. Ernst Klee, Willi Dreßen and V. Rieß<sup>41</sup> have culled the testimony of three witnesses – Höfer, Kurt Werner and Anton Heidborn – from the files held at the Central Office in Ludwigsburg; these files are not, however, made available to critical researchers.

According to Höfer, the Jews had to undress and neatly stack their clothes at a spot 500 ft. from the ravine (according to Werner it was a kilometer, about  $\frac{2}{3}$  of a mile). Then the naked victims were led into a ravine which according to Höfer was 500 ft. long, 100 ft. wide and 50 ft. deep, whereas Werner claims it was 1,300 ft. long, 260 ft. wide at the top and 33 ft. wide at the bottom, and 33 ft. deep. According to Höfer, two or three narrow passages led into the ravine; according to Werner the victims were led to the edge of the hollow and then ran down the slopes of their own accord.

Höfer maintains that there was only one marksman at each end of the ravine; Werner tells of a total of 12. Höfer testified that a “*packer*” stood at each end and placed each victim onto the previous bodies. Then each was shot by a member of the police, with a submachine gun, per a bullet in the neck. The children were shot together with their mothers.

Werner reported that the Jews had to “*lie down facing the earth up against the walls of the hollow*” and were then murdered via a bullet in the neck. The next victims then had to lie down on top of the bodies.

Three days after the execution they began covering the heaps of corpses with earth. According to Heidborn a hand was seen waving from among the bodies three days later.

- Time required, given two “*packers*” and marksmen, or 12 marksmen?
- How does the position of the victims, up against the wall of the ravine, agree with the picture<sup>42</sup> where “*exhumed bodies*” are shown lying flat?
- Why are critical researchers not allowed access to documents, and not only in Ludwigsburg? Why does not even public prosecutor Willi Dreßen take exception to the contradictions, to say nothing of the physical impossibilities alleged? Why do the authors make no mention of the 300,000 Jews postulated for Kyiv in Event Report 106, and mention only the 150,000 from Event Report 97 of September 28, 1941?<sup>43</sup>
- Why does even Reitlinger,<sup>44</sup> the Holocaust Pope, marvel how it was possible to keep that many people together on the road for two whole days, but Klee and his co-authors do *not* notice this problem?

---

<sup>41</sup> E. Klee, W. Dreßen, V. Rieß (eds.), “*Schöne Zeiten*”, *Judenmord aus der Sicht der Täter und Gaffer*, S. Fischer, Frankfurt/Main 1988, pp. 66ff.

<sup>42</sup> E.R. Wiehn, *op. cit.* (note 7), p. 161.

<sup>43</sup> E. Klee *et al.*, *op. cit.* (note 41), p. 67.

<sup>44</sup> G. Reitlinger, *The Final Solution*, A. S. Barnes & Co. Inc., New York 1961, p. 263; German ed.: *Die Endlösung*, Colloquium, Berlin 1992.

12. Now for Adalbert Rückerl. His anonymous witness would seem to be Werner, from the previous scenario. The witness reports:<sup>45,46</sup>

“[...] *shot [...] the entire Jewish population of Kyiv. [...] Executions [...] until five or six o'clock. [...] All were naked.*”

In the second publication<sup>46</sup> we find that Rückerl draws on Event Report 106<sup>3</sup> unmodified. He quotes the blocking-off of the execution place, the filling-in of the pits after the execution, as well as a few individual Soviet citizens who had secretly witnessed the execution. He suggests that neutral witnesses were only rarely available and that their testimony was generally not suited to convicting the accused. As an example he quotes the statement of the witness N. T. Gorbacheva from Kyiv:<sup>47</sup>

“[...] *I lived in Kyiv, at 55 Tiraspol's-Kaja Street, Door 2. [...] near the place called Babi Yar. On September 22, 1941, I saw with my own eyes [...] how, in the course of the day, about 40 lorries drove to Babi Yar, loaded with Jewish residents. [...] I and some other women [...] went, unnoticed by the German guards, to the place where [...] the people were being unloaded. We saw that about 50 ft. from the beginning of the Babi Yar the Germans forced the Jews to undress and ordered them to run along the Babi Yar. Then the Germans shot at the running people with submachine guns and machine guns. [...] There were not only people who had been shot, but also injured people and even living children in the ravine. Nevertheless the Germans filled the ravine in; the thin layer of soil moved visibly.*”

The only things Rückerl contests is the date, and the use of lorries for all the victims. He lets it stand for those who could not walk. Rückerl withholds the fact that Gorbacheva claimed:<sup>48</sup>

“*The shooting of the Jews went on for several days.*”

- According to the unnamed witness<sup>45</sup> 6 o'clock was ‘closing time’. So all those who tell of murders at night must have lied?
- Is Rückerl so unfamiliar with the Soviets’ Babel of propaganda and lies that he considers a book printed in Moscow in 1963 to be a reliable document?
- Was he able to find a ‘Tiraspol'skaja Street’ (that’s how it would be written correctly!) on a street map of Kyiv, and near the ‘place’ Babi Yar (which is not a ‘place’ at all)?
- How many people – along with their possessions – can 40 lorries carry?
- Does Rückerl really believe that some of the ladies of Kyiv were so insane, so utterly fearless, or so curious that they would sneak past the guards posted by the evil enemy, and then watch the mass murder? Is there ‘a Babi Yar’ that has a beginning and which one can run along? Are executions carried out by shooting at running targets with various kinds of firearms?
- How does the “*thin layer of soil*” agree with the great quantities of earth needed to fill in a ravine? And would anyone who had not been hit by a bullet not suffocate directly after being buried alive?

13. In Babi Yar in March 1942<sup>49</sup> Adalbert Hartl, Gestapo Expert for Church Matters, observed:

“*small explosions that shot up clods of earth. It was the spring thaw that was letting the gas from the thousands of bodies escape.*”

<sup>45</sup> A. Rückerl, *NS-Verbrechen vor Gericht, Versuch einer Vergangenheitsbewältigung*, C. F. Müller, Heidelberg 1984, pp. 43ff.

<sup>46</sup> A. Rückerl (ed.), *NS-Prozesse nach 25 Jahren Strafverfolgung: Möglichkeiten – Grenzen – Ergebnisse*, C. F. Müller, Karlsruhe 1972, pp. 86f.

<sup>47</sup> In: *Verbrecherische Ziele – verbrecherische Mittel!*, Verlag für fremdsprachige Literatur, Moscow 1963, pp. 177f.

<sup>48</sup> E. R. Wiehn, *op. cit.* (note 7), p. 82.

<sup>49</sup> *Ibid.*, p. 138.

- What is a Gestapo Expert for Church Matters doing at Babi Yar? The small explosions and rocketing clods of earth are nonsense, for even when wet ground freezes solid it is never gas-proof – especially not sandy soil.

## 5. Other Sources

1. A physician named Dr. Gustav Wilhelm Schübbe allegedly killed 21,000 persons single-handedly, with morphine injections. 110,000 to 140,000 victims were allegedly killed in this way at the “*German Annihilation Institute*” in Kyiv.<sup>50,51</sup>
  - Injections of morphine, which was in very short supply and badly needed for wounded soldiers? And how long would it take one physician to give 21,000 injections?
  - According to the files of the US Document Center in Berlin, which holds more than one million records pertaining to members of the NSDAP (‘Nazi’ Party), Dr. Gustav Wilhelm Schübbe was never stationed in Kyiv.
  - Why did neither the USSR nor the Jews ever search for the location of this “*Annihilation Institute*”?
2. After the liberation of Kyiv, Moscow newspapers and the *New York Times* reported that 40,000 (!) inhabitants of Kyiv had written to Joseph Stalin and given the number of victims of Babi Yar as more than 100,000.<sup>52</sup>
  - When, where and how did these people die?
  - What happened to all these ‘witnesses’?
3. In 1963 Nikita Khrushchev sharply criticized the literary champions of “*Jewish martyrdom*”, especially Yevgeny Yevtushenko, who had drawn notice the year before with his poem *Babi Yar*:<sup>53</sup>

*“I urge Comrade Yevtushenko and other young literati to appreciate the trust of the majority [of the people], not to seek cheap sensationalism [and] not to pander to the mood and tastes of the Philistines. Do not be ashamed, Comrade Yevtushenko, to admit your mistakes. [...]*

*When the enemies of our Cause begin to praise you for pleasing tales, then the people will criticize you, and rightly so.”*

The cause for Khrushchev’s reference to “*propitious tales*” was Yevtushenko’s readings of his poem *Babi Yar*. Khrushchev’s blunt words weigh very heavily, for several reasons:

- Would Khrushchev have used the term “*cheap sensationalism*” if the hated enemy from the ‘Great Patriotic War’ had in fact murdered thousands of Soviet citizens at Babi Yar? Would he then have cautioned Yevtushenko against “*pander[ing] to the mood and the tastes of the Philistines*”?
- Would Khrushchev then have admonished against “*pleasing tales*”?
- In his capacity as Head of the Soviet Communist Party and General Secretary of the Ukrainian Communist Party, Khrushchev on June 24, 1941, ordered the liquidation of the political prisoners in Lvov (Lemberg). The NKVD then began with the mass murders in the prisons of Lemberg and other places in the western Ukraine. The Soviets also laid the blame for these massa-

---

<sup>50</sup> “*German Doctor Admits Killing 21,000 Himself*”, *The New York Herald Tribune*, May 1, 1945; this article does not mention Babi Yar specifically.

<sup>51</sup> “*Murder of 140,000 Upheld by Germany*”, *The New York Times*, May 1, 1945.

<sup>52</sup> “*Kyiv Lists More Victims, Letter to Stalin Says 100,000 Were Massacred by Nazis*”, telegram from Moscow to the *New York Times*, *The New York Times*, Dec. 4, 1943.

<sup>53</sup> N. S. Khrushchev, in *Erhabener Ideengehalt und künstlerische Meisterschaft – Die große Kraft sowjetischer Literatur und Kunst*, Moscow, March 8, 1963, p. 207; also *Pravda* of March 8, 1963.

cles at the Germans' door. Khrushchev knew exactly who had done the murdering and who it was who had suffered!

- Furthermore, Khrushchev, a Ukrainian, knew very well that the minorities predominating in the economy and in industry, research, teaching and politics in the Ukraine – in other words, the Greater Russians and especially the Jews – had been given priority in the evacuation. He knew the evacuation rates of the Jews, for example Minsk 94%, Šitomir 88%, Novograd-Volynskij 90%, Poltava 96%, Černigov 97%, Zdanov 100%, and Taganrog 100%. For Vinnica, Kyiv and Uman it was about 80%:<sup>54-58</sup>

*“In Kyiv practically the entire Jewish youth had left the city with the Red Army. Only older people remained.”*<sup>54</sup>

- Wiehn, for example, ought also to have noticed that, for on his p. 146 we read:<sup>37</sup>

*“Sarra Evenson’s advanced age had made her evacuation from Kyiv impossible.”*

- Since Wiehn must also have read the information he quoted from Reitlinger<sup>59</sup> regarding evacuation rates, one cannot help but suspect a deliberate attempt to falsify history and even to commit academic fraud. Incidentally, a few pages further one finds yet another and even more time-consuming and extremely dubious murder method. Reitlinger:<sup>60</sup>

*“[...] that the victims were shot in the neck at the precise moment when they stepped from a board into the cave.”*

- A cave???
- At the 20<sup>th</sup> Party Convention of the Soviet Communist Party in February 1956, Khrushchev succeeded Stalin and charged him with organized mass murder.
- Yevtushenko got the inspiration for his poem *Babi Yar* from the American Jew Joseph Schechtman; it was not his own experiences he described with such a flaming pen.

4. In its entry “*Babi Yar*” the *Encyclopaedia Judaica* (Jerusalem, 1972) devotes 92% of its entry space (21.65 inches of text) to Yevtushenko’s poem, but only 8% (1.8 inches of text) for an account of the massacre.<sup>13</sup> The encyclopedia claims that 100,000 died in Babi Yar, 33,771 of them in the last days of September.

- Could the *Encyclopaedia Judaica* not come up with any better evidence than a poem?

5. The *Encyclopedia of Ukraine*,<sup>61</sup> published in Toronto in 1988, states that only 3,000 Jews were executed in September, and gives their total number as “*more than 150,000*”.

6. The *Encyclopedia of the Holocaust*<sup>5</sup> (New York, 1990) alleges a wide range of things, which for reasons of space we shall discuss in table form:

<sup>54</sup> Institute of Jewish Affairs (ed.), *Hitler’s Ten Year War*, New York 1943, p. 186.

<sup>55</sup> *Encyclopedia Judaica*, *op. cit.* (note 4), v. 11, p. 57.

<sup>56</sup> R. Hilberg, *The Destruction of the European Jews*, Holmes & Meier, New York 1973, p. 192; 1<sup>st</sup> ed.: Quadrangle Books, Chicago 1961; 2<sup>nd</sup> ed. 1967; later ed.: Holmes & Meier, New York 1985.

<sup>57</sup> G. Reitlinger, *op. cit.* (note 44), pp. 227, 237.

<sup>58</sup> *Encyclopaedia Judaica*, *op. cit.* (note 4), v. 10, p. 994; *Encyclopedia of Ukraine*, University of Toronto Press, Toronto 1988, v. 1, p. 154.

<sup>59</sup> E. R. Wiehn, *op. cit.* (note 7), p. 133.

<sup>60</sup> *Ibid.*, p. 137.

<sup>61</sup> *Encyclopedia of Ukraine*, University of Toronto Press, Toronto 1988, v. 1, p. 154.

<b>ENCYCLOPEDIA OF THE HOLOCAUST:</b>	<b>CRITICAL COMMENTS:</b>
Not until after the war did it turn out that the blasting in Kyiv had been carried out by units of the NKVD which had remained behind.	The information regarding the blasting is false. <sup>62</sup>
On September 26 the Germans decided to kill all the Kyiv Jews as retaliatory measure.	Where is some conclusive evidence for such a German decision of September 26?
SS- <i>Standartenführer</i> Blobel attended this meeting.	How does this claim agree with the fact that Blobel was off duty at the time, due to his head injury of September 24? <sup>63</sup>
On September 28 [1941] placards were posted, ordering that the Jews had to gather at the corner of Melnik and Dekhtyarev Streets at 8 o'clock on the morning of September 29, to be resettled.	There is no evidence whatsoever for a placard produced by the printing unit of the 6th Army.
The text of the placards was written by Propaganda Division No. 637, and the placards had been printed by the printing unit of the 6th Army.	The Propaganda Division and the printing unit of the 6th Army could be forgiven for mistakes in the Russian and Ukrainian texts, but why are there grammatical errors in the German text as well? And why is no issuing authority mentioned on the placards?
An area including the Jewish Cemetery and part of the ravine was fenced in with barbed wire and guarded by a special commando of police, Waffen-SS and Ukrainian police.	What/who is the source for the information that the Jewish Cemetery and part of the ravine were fenced in with barbed wire? Waffen-SS? Ukrainian policemen?
Outside the ravine the Jews had to hand over their valuables, to undress entirely, and then to go to the upper edge of the ravine in groups of 10.	Groups of 10 would mean 3,377 groups. Even allowing only 5 minutes per group, this would still take 281 hours, or 24 days when working 12 hours a day.
On reaching the edge they were shot with automatic weapons (German edition: with machine guns). At the end of the day the bodies were covered with a thin layer of soil.	Extra time needed for removing the piles of bodies and for covering with soil?
In the following months, thousands more Jews were captured and shot in Babi Yar.	If some 80% of the approximately 160,000 Jews – <i>i.e.</i> , 128,000 – had been evacuated, then how could 33,771 be murdered on September 29 and 30 and thousands more in the following months? Where did the enormous number of bullets and cartridges go?
Some of the Kyiv inhabitants helped the Jews disappear.	

<sup>62</sup> Cf. introductory information and General Jodl, in *op. cit.* (note 2).

<sup>63</sup> U. Walendy, *op. cit.* (note 1), pp. 29, 37.

<b><i>ENCYCLOPEDIA OF THE HOLOCAUST:</i></b>	<b>CRITICAL COMMENTS:</b>
But the Ukrainians of Kyiv denounced Jews in such numbers that the short-staffed SIPO and Security Service could not process all the letters that arrived by the laundry-basketfull. <sup>39</sup>	Given the local support for the Jews, how can one also explain letters of denunciation by the laundry-basketfull? And how the short-staffing?
According to Soviet researches, 100,000 people were murdered in Babi Yar, including gypsies and Soviet prisoners-of-war.	What documents are there to prove the total of 100,000? Does the claim that in Babi Yar also prisoners-of-war were murdered not make Khrushchev's criticism of Stalin even more significant?
As of mid-August 1943 the graves were opened with bulldozers, but the bodies were transported by fettered inmates, among them 100 Jews.	Did the Germans have bulldozers? Is this sort of equipment used in a narrow ravine? Do the air photos give any indication of such activities? Why bulldozers, if the main part of the work had to be done by slaves in chains? Where did the 100 Jews come from?
The bodies were burned on a base of railroad tracks and on pyres of tree trunks, for which purpose they were doused with gasoline.	Where did the enormous quantities of railroad tracks and firewood come from, especially in view of the advancing Russian front? Whence the gasoline, which was not even in adequate supply for tanks and the Luftwaffe?
The bones were crushed on gravestones from the Jewish Cemetery.	Gravestones for crushing bones? Evidence?
The cremation lasted from August 18 to September 19, 1943.	
The ashes were screened and sifted in order to retrieve all of the gold and silver.	How long would it take to screen and sift all the ashes, along with everything that had become mixed with them? To where did the gravestones and the ashes go?
After the bodies were cremated, 15 prisoners escaped.	
Jews were not mentioned as victims in the inscription on the memorial erected in 1974. Modified in 1991, the inscription now also commemorates the Jews (German edition).	Why did the first inscription withhold the information that there were Jews among the victims?

About two weeks after the recapture of Kyiv in late 1943, the western journalists who had been invited<sup>21</sup> Were told that six weeks earlier the Germans had finished the blasting, exhumation and open-air incineration of 70,000 bodies, the crushing of the unburned bones and the bulldozing of the material into the ravine.

- What happened to the difference of 30,000 bodies, and where are all the witnesses for these blazing fires, for the clouds of smoke and the infernal stench? It ought to have been an easy matter for the Soviets to procure evidence and witnesses to prove all these claims to the journalists – or perhaps not? Why did the physical evidence fail to impress the journalists?

7. On the fiftieth anniversary (1991) of the German ‘attack’ on the Soviet Union, the *ZDF* (German Television) broadcast a film series by Guido Knopp, who had produced it in collaboration with *Gostelradio*, a Soviet state undertaking which even then was at times still strictly controlled by the KGB. In the course of this broadcast series, Babi Yar was also discussed (June 18, 1991).

- A woman named Sheila Polischtschuk recounted roughly the same as set out above in Section 4 Part 9. Her mother had thrown herself and her child, Sheila, into the ravine. Mother and daughter were covered up by more and ever more bodies. The mother had pushed her fists under her daughter’s neck so she would not drown in the blood. A soldier allegedly stood on her mother and thus missed her with the bayonet. The mother managed to work her way out from under this mountain of corpses, taking her unconscious daughter with her.
- A ‘ravine’ was shown, which looked more like a 30-ft.-deep and 65 to 100-ft.-wide gravel pit.
- Another picture, taken at an angle from behind, showed a row of fully dressed (!) persons at the edge of a pit, with their backs to the pit.
- A film of an ‘interrogation’ from Stalin’s days was shown; the interrogatee admitted having shot 120 persons. Six men had been assigned as guards and six as execution commando. He claimed to have shot about 120 people in a period of 36 hours.

Given the killing rate admitted to by the interrogatee, it would have taken about 10,131 hours to manage the 33,771 executions claimed in the *ZDF* broadcast.

- How did Sheila Polischtschuk’s mother manage to turn herself and her daughter around 180 degrees and to throw herself head over heels into the ravine without either of them sustaining bruises or broken bones and without either of them crying out? If the mother had to keep the child from drowning in the blood, then the daughter must have lain practically at the bottom of the ravine, *i.e.*, she and her mother were among the first victims. So the piles of corpses lying on both of them must have been an enormous weight.
- If mother and daughter were underneath many bodies, how could the soldier stand on the mother?
- If the soldier stood on the mother – in other words, if the other part of the story is not true – then why did his bayonet not strike mother or daughter after he had changed his position?
- If the mother could work her way out from under a mountain of corpses, then in order to free her daughter she would have had to move other bodies around. After all, the bodies were not lying there neat and orderly, they were quite entangled! Why did the guards not notice her activity?
- And for the sake of a bit of variety, other sources also tell of escaped mothers. Jean-François Steiner’s book<sup>64</sup> is based on many instances of alleged eyewitness testimony and claims that “Ivan“, who was later promoted to “*the Terrible*“, was killed during the Treblinka revolt (which claim, however, was rescinded during Demjanjuk’s first trial). This book tells of a very similar case which allegedly took place at about the same time, in Ponar near Vilna. Driven into a corner, Steiner admitted that his book was really just a novel (but the *Brockhaus Enzyklopädie* quotes it as factual source in its article on Treblinka!). Kuznetsov’s book<sup>39</sup> and *Schindler’s List*<sup>65</sup> are also works of fiction!
- Other questions regarding Knopp’s film:
- Despite all the top secrecy, who managed to take a photo of the victims lined up to be shot? Who, furthermore, managed to do this from a clearly visible vantage point and even potentially

---

<sup>64</sup> J.-F. Steiner, *Treblinka, la révolte d’un camp d’extermination*, Fayard, Paris 1966, pp. 17ff.; German ed.: *Treblinka, die Revolte eines Vernichtungslagers*, Stalling, Oldenburg 1966, pp. 338f.

<sup>65</sup> Regarding *Schindler’s List* cf. the contribution of Udo Walendy in this volume.

within the scatter field of the machine gun fire? Why does the rather out-of-focus picture reveal characteristics common to many other falsified propaganda pictures? Why are the people dressed? According to the witness, six men were designated as execution commando and six as guards. Where did the ‘bayonet men’ come from? How many prisoners or groups can be guarded by six men?

8. Novelist Guido Knopp<sup>66</sup> writes in the left-hand column of page 132 of his book:

*“[...] many soldiers stood with machine guns. [...] They led us to a ravine, where big boxes stood, in which they collected the documents and other things. [...] Then an execution commando took up position. Mother did not wait for the commando, she threw herself and me into the pit and fell on me. The special units began to cover us over with dead bodies. After that they shot another group. [...] A soldier stood on my mother and stabbed the wounded man lying beside her. When they passed on to share the spoils, mother pulled me out unconscious and carried me away.”*

In the right-hand column of the same page, however, we read:

*“When they arrived at the ravine after the beating, they had to lie down on the ground in rows, in small groups. Then the execution commando went into action. A burst of machine gun fire, a few shovels of earth that only barely covered the bodies, and then the next group was driven into the ravine.”*

- How does Knopp imagine the machine gun execution of victims that are lying down?
- And what must one think of authors who, when writing the right column of a page, can no longer remember what they wrote in the left column?
- For comparison, we have the sworn statement of Professor Aloshin, according to whom heavy machine guns were set up on either side of the ravine. And:

*“then Russian prisoners-of-war who were stationed on either side of the ravine with shovels [...] had to throw sand over the victims.”*

- The victims had been herded into the ravine; the heavy machine guns were fired downward at a sharp angle – not an easy task.
- At the bottom, he said, the bodies piled up every which way – not, as Knopp describes, *“in rows on the ground.”* From experience with the mass graves in Hamburg, for the 40,000 victims of the British terrorist attacks, we know that the prisoners-of-war would have had to shovel about 742,000 cu.ft. of sand in order to cover the victims. Given a more careful layering of the bodies, as in Katyn, there would still have been about 503,200 cu.ft. to shovel. Since the bodies were in the pit, they would either have had to dig into the embankments or to bring the sand in from outside. More work, and lots of it! Do the air photos reveal any of this? How much sand can one worker shovel per day, under such conditions?
- Where does Knopp glean his knowledge of large empty halls in which those still living spent night?<sup>66</sup> There were no halls at Babi Yar. And why is there not so much as one single witness for these treks – from the ‘halls’ back to the murder sites?

9. Professor Dr. Wolfgang Benz:<sup>67</sup> In the ravine

*“[...] there were 3 groups of marksmen, a total of about 12 marksmen. [...] They stood behind the Jews and killed them with shots to the neck.”*

- Shooting in the neck was the well-known murder method of choice for the GPU, NKVD, KGB, and Stasi!

10. On February 18, 1946, the Soviet prosecutor Smirnov declared at the IMT:<sup>68</sup>

<sup>66</sup> G. Knopp, *Der verdammte Krieg – Unternehmen Barbarossa*, Bertelsmann, Munich 1991, p. 132.

<sup>67</sup> W. Benz (ed.), *Legenden, Lügen, Vorurteile... Ein Lexikon zur Zeitgeschichte*, dtv, Munich 1990, p. 44.



*“In Kyiv, over 195,000 Soviet citizens were tortured to death, shot, and poisoned in the gas vans, as follows:*

*(1) In Baybe-yar, over 100,000 men, women, children, and old people.”*

- How does this version agree with the various eyewitness testimony?
- Did the Communist regime concoct these claims in order to blame its own mass murders on the Germans?
- The approximately 10,000 Ukrainians who were murdered in Vinnica by the Soviets via bullets to the neck and then thrown into mass graves<sup>69</sup> come to mind, as do other massacres.

11. N. F. Petrenko and N. T. Gorbacheva testified:<sup>70</sup>

*“[...] the Germans threw babies at the breast into graves and buried them alive with their dead or wounded parents.”<sup>71</sup>*

- Evidence? Specifics re. place, date, etc.?

12. In C. Clarke’s book we read:<sup>72</sup>

*“German tanks roared through the large Jewish quarter, after the occupation, blasting every living object in sight, and then burning Jews alive in flaming buildings and killing them in woods over the mass graves excavated by the victims while some Jews were tied to trees and shot or bayoneted.”*

- Evidence? Witnesses?
- Time required for the victims-to-be to excavate the mass graves?
- Place? Date?
- Why the time-consuming procedure of tying to trees?
- If there was a large Jewish quarter, why were the Jews not simply ordered to gather there and led off, instead of marching them in many columns into northwestern Kyiv and producing many witnesses in the process – witnesses who, however, mysteriously were not to be found later?

13. In her book, published in 1987 in Israel, Leni Yahil wrote:<sup>73</sup>

*“The 30,000 Jews who assembled [in Kyiv] were taken to the forest and slaughtered over the course of two days.”*

- Leni Yahil does not name witnesses, nor does she give an explanation and/or evidence for how it was possible to assemble and lead off more than 30,000 people within a few hours, without thousands of people noticing and potentially appearing as witnesses later.
- Yahil transfers the murder site to a forest. So it wasn’t a ravine? Evidence? Air photos?

14. As noted in sections 4 and 6, the Jews of Kyiv and its environs were informed via placards that they had to assemble with all their belongings at a specific place. This placard was not ready until the day before.

This organizational point is of utmost importance and should be examined a little more closely, for the relevant considerations apply *mutatis mutandis* for all the various versions of the massacre.

The placard was printed in Russian, Ukrainian and German and allegedly read [translation of German text]:<sup>7</sup>

---

<sup>68</sup> Document USSR-9, Extraordinary State Commission on the Atrocities Perpetrated by the German Fascists in City of Kyiv, para. 5, col. 1, *IMT* v. VII, p. 556.

<sup>69</sup> *Amtliches Material zum Massenmord von Winniza*, Franz. Eher Nachf., Berlin 1944.

<sup>70</sup> N. F. Petrenko, N. T. Gorbacheva, eyewitness testimony, Document USSR-9, *IMT* v. VII, 1948, p. 541.

<sup>71</sup> See also A. Ruckerl, *op. cit.* (note 46), pp. 86f.

<sup>72</sup> C. Clarke, *Eichmann – The Man and His Crimes*, Ballantine Books, New York 1960, p. 62.

<sup>73</sup> L. Yahil, *The Holocaust*, Oxford University Press, New York 1990, p. 257; first pub. in Israel.

*“All the Jews of Kyiv are to gather until 8 o’clock on Monday, September 29, 1941, at the corner of Melnik and Dokteriwski Streets (at the cemeteries). Bring your papers, money and valuables, also warm clothing etc.*

*Anyone failing to comply with this order, and found elsewhere, will be shot.*

*Anyone breaking into vacant Jewish homes or appropriating items from the same will be shot.”*

Fundamental questions:

- Why is no issuing authority given?
- Name and rank of the issuing commander?
- Date of issue?

Regarding the German text:

- 8 o’clock in the morning or 8 o’clock in the evening? “*Until*” 8 o’clock?
- The original German text was printed using ‘oe’, ‘ae’ and ‘ss’ instead of ‘ö’, ‘ä’ and ‘ß’. Did the printer for the 6th Army not have any umlauts in his fonts?
- “*Dokteriwski Street*” is incorrect. The street was called ‘Djegtjariwskoi’, i.e., Tarburner Street.
- “*Melnik Street*” is incorrect. It is correctly called ‘Melnikowa Street’. It is named for a Mr. Melnikow.
- “*An den Friedhöfen*” (the original German wording for “*at the cemeteries*”) is incorrect German. It should read ‘Bei den Friedhöfen’. Aside from that, the Russian text has only *one* cemetery.
- The *Encyclopedia of the Holocaust*<sup>5</sup> claims that the purpose of the order was ‘resettlement’. What is the source of this insight? The placard makes no mention of this.<sup>7</sup>
- What is meant by “*found elsewhere*”? When people converge on a location from everywhere else, *everywhere* is “*elsewhere*”.
- How likely is it that a military propaganda division and an army printer would do such sloppy work?

Regarding the Russian text:

- The term used for Jews (“*schidy*”) is contemptuous Russian gutter jargon. What sort of results can one expect when even the order to assemble bodes ill? Did the Germans actually want to run the risk of having a large part of the Jews not show up at all, and go into hiding? Perhaps they even intended that in such a case they would put all armed conflict on hold, and employ their forces in locating the Jews instead...?
- Here, too, the street names are incorrect. Moreover, the declension of street and that of cemetery are both wrong.
- The Russian text specifies 8:00 a.m. No mention is made of resettlement!
- In the list of things to bring, what does “*etc.*” mean? Did that not risk having the great Jewish population come to the gathering place loaded down with masses of baggage and horses and wagons, hand carts and baby buggies crammed full of belongings, blocking all the streets of Kyiv in the process?

Regarding the Ukrainian text:

- Again, incorrect street names, and no hint as to the purpose of the assembly.

Whoever may have been responsible for this ‘order’ – what were they thinking of:

- after the occupation of Kyiv, and with an anonymous placard, with name-calling and threats of execution, to order perhaps 100,000 or even more Jews to assemble literally over night and with potentially all their belongings, at a single street corner at 8 o’clock the next morning?
- How was this ‘message’ supposed to reach the Jews in Kyiv and its environs, shortly after the extremely destructive armed conflict?

- How did they intend to handle this enormous and unorganized crowd (no staggered times for the summoned, in alphabetical order, for example)? Did they deliberately risk chaos in the streets – something which the occupiers of a large, partisan-riddled city precisely did *not* need?
  - How are these great masses of people and goods to fit at one street corner?
  - How does one print approximately 2,000 placards in a city with no electrical power?
  - Where and how does one post the placards, while potentially risking one’s life to snipers?
  - Why did none of the many German Army privates notice the huge crowds, the miles-long exodus, or the placards (which, after all, they could read!) and mention all of this at an appropriate time, if only to their families?
  - Why did none of the foreign correspondents, whom the ‘German gangs of killers’ allowed to view the captured and burning city of Kyiv, see or at least hear about even a single one of the alleged 2,000 placards?
  - In a just recently captured and still very dangerous city, is there nothing more pressing for the occupiers to do than to create additional problems on an enormous scale, especially in contexts which, after all, were not terribly urgent?
  - Wiehn<sup>7</sup> and others seem not to have noticed that there were several rather different versions of the placard. According to Reitlinger,<sup>74</sup> the placard specified “*within three days*”, and “*for resettlement*”. According to L. Ozerow,<sup>75</sup> the placard was in Ukrainian and Russian and stated “*7 o’clock*”. Arch-Stalinist Ilya Ehrenburg claims 7 o’clock,<sup>76</sup> and his street names are also wrong. A. Kuznetsov<sup>77</sup> (placard source<sup>78</sup>) also has no idea of the correct street names, and gives neither the Ukrainian nor the German text. Event Report No. 128 of November 3, 1941, allegedly announced the resettlement via “*brick-wall posting*”.<sup>79</sup> The term “*brick-wall posting*”, which is quite unusual in the German language, appears to be in common usage by Russians speaking German.<sup>80</sup>
15. On October 6, 1991, on the occasion of a night-time commemoration at Babi Yar, a middle-aged orthodox Jew told Ukrainian Television in Kyiv:<sup>81</sup>
- “150,000 Jews were massacred by the Germans in two days, with the active participation of a minority of Ukrainians from Kyiv and the passive cooperation of the majority.”*
- Where does he get his figure of 150,000 murdered?
16. Vladimir Posner, an American-born Jewish NKVD collaborator, claimed that 200,000 were murdered.<sup>82</sup>
- Evidence?
17. On April 23, 1990, Vitaly Korotych, a Ukrainian NKVD and KGB collaborator, claimed that there had been 300,000 victims at Babi Yar.<sup>83</sup>
- How did Korotych come up with this figure?

---

<sup>74</sup> Wien, *op. cit.* (note 7), p. 137.

<sup>75</sup> *Ibid.*, p. 143.

<sup>76</sup> *Ibid.*, p. 167.

<sup>77</sup> *Ibid.*, p. 195.

<sup>78</sup> *Zentrales Staatliches Archiv der Oktoberrevolution, Verzeichnis*, 65<sup>th</sup> ed. Chr. 5., Moscow.

<sup>79</sup> Wien, *op. cit.* (note 7), p. 477.

<sup>80</sup> Deutsch-russisches Wörterbuch, *Sowjetische Enzyklopädie*, Moscow 1971, p. 577.

<sup>81</sup> Ukrainian television, Kyiv, Oct. 6, 1991.

<sup>82</sup> V. Posner, H. Keyssar, *Remembering War: a US-Soviet Dialogue*, Oxford University Press, New York 1990, p. 206.

<sup>83</sup> V. Korotych, *Lecture in Toronto, Canada, at the Canadian Institute of Internal Affairs*, April 23, 1990.

18. On September 5, 1991, *The Washington Times* published the claim of Genadi Udowenko, the Ukrainian Ambassador to the United States, who alleged that 50,000 Jews, most of them children, had been butchered during the first week of the dreadful massacre of Babi Yar.<sup>84</sup>
- Did he perhaps get this information from I. M. Levitas, the Head of the Society for Jewish Culture in Kyiv, who had made the same claim in an interview with a Kyiv newspaper?<sup>85</sup> That would mean that despicable Jewish parents had abandoned more than 25,000 children when they were evacuated by the Soviets. This, however, is disproved by Jewish and Soviet publications,<sup>31,54-58</sup> which stressed the evacuation of *families* in order to sustain morale.
19. In her book<sup>86</sup> the Kyiv author and poet Dokia Humenna, who had witnessed the entire time of occupation in Kyiv, devotes fully half a sentence to the alleged massacre of Babi Yar. She describes it as a rumor, and states that the alleged killing methods were machine gun executions, electric shock, hand grenades, and burying injured Jews alive.
- Why does this contemporaneous witness deem Babi Yar worth only half a sentence?
  - Why does she consider it a rumor?
  - What is the source for the new murder methods of electric shock and hand grenades?
20. Readers of the *Great Soviet Encyclopedia* of 1950 will search in vain for an entry for Babi Yar.<sup>87</sup> The 1970 edition claims 50,000 to 70,000 victims.<sup>88</sup>
- Isn't it surprising that the mighty encyclopedia of 1950 forgot about Babi Yar even though 'Smirnov & Co.' had testified to the most gruesome things about it only a few years earlier, in Nuremberg?
21. The 1955 and 1971 editions of the Ukrainian encyclopedias are unaware of Babi Yar.<sup>89,90</sup>
22. The following important encyclopedias do not mention (are not aware of) Babi Yar:
- *Grand Larousse Encyclopédique*, Paris, 1960;<sup>91</sup>
  - *Brockhaus*, 1967;<sup>92</sup>
  - *Enciclopedia Europea*, Rome, 1976;<sup>93</sup>
  - *Enciclopedia Universal Nautea*, Madrid, 1977;<sup>94</sup>
  - *Encyclopedia Britannica*, 1945 to 1984 editions;<sup>95</sup>
  - *Academic American Encyclopedia*, 1991;<sup>96</sup>
- The 1987 (most recent) edition of the *Brockhaus Enzyklopädie* has already heard of Babi Yar.<sup>97</sup> According to this work, more than 30,000 Jews were murdered by members of a German police battalion in a ravine in northern Kyiv. Yevtushenko's poem and Shostakovich's 13th symphony are cited, but a reader will search in vain for better data.

<sup>84</sup> R. Grenier, "Infectious Nationalism", *The Washington Times* (from New York), September 5, 1991, p. G4.

<sup>85</sup> Cf. E.R. Wiehn, *op. cit.* (note 7), pp. 114f.

<sup>86</sup> D. Humenna, *Kreshchaty Yar*, Association of Ukrainian Authors and Journalists, New York 1956, p. 195.

<sup>87</sup> *Bolschaja Sowjetskaja Enzyklopedia*, Moscow 1950, v. 4, p. 1.

<sup>88</sup> *Bolschaja Sowjetskaja Enzyklopedia*, Moscow 1970, v. 2, p. 501.

<sup>89</sup> *Encyclopedia of Ukraine*, Shevchenko Scientific Society, Paris / New York 1955, v. II, pp. 5-33.

<sup>90</sup> Ukrainian National Association (ed.), *Ukraine, a Concise Encyclopedia*, University of Toronto Press, Toronto 1971, v. II, p. 1271.

<sup>91</sup> *Grand Larousse Encyclopédique*, Librairie Larousse, Paris / New York 1960, v. 1, p. 817.

<sup>92</sup> *Brockhaus Enzyklopädie*, Wiesbaden 1967, v. 2 and supp. v. 22.

<sup>93</sup> *Enciclopedia Europea*, Garzanti, Rome 1976, v. 1, p. 934.

<sup>94</sup> *Enciclopedia Universal Nautea*, Ediciones Nauta, Madrid 1977, p. 192.

<sup>95</sup> *Encyclopaedia Britannica*, Encycl. Brit. Inc., Chicago, editions from 1945 to 1984.

<sup>96</sup> *Academic American Encyclopedia*, Grolier Inc., Danburry 1991, v. 3, p. 7.

<sup>97</sup> *Brockhaus Enzyklopädie*, Mannheim 1987, v. 2, p. 446.

The latest *Brockhaus Enzyklopädie*'s newest discovery is probably the result of its collaboration with *Meyers Enzyklopädisches Lexikon*.<sup>98</sup> The latter contains similar information, as well as a reference to A. V. Kuznetsov's documentary novel. The Babi Yar points of the compass are given incorrectly in both encyclopedias.

23. In his book,<sup>99</sup> the Jew J. G. Burg (actually Joseph Ginzburg), who – along with his family – experienced the deportation in the East first-hand, reports that after the Red Army had retreated from the area of Czernovyč the local population carried out numerous pogroms against the Jews, and that it took severe intervention by German and her allied troops to put a stop to these pogroms.

- Why does Burg not mention any similar mass murders committed by the Germans?

24. On page 78 of J. Heer's and K. Naumanns's book *Verbrechen der Wehrmacht 1941-1944* pictures 1 and 2 allegedly show "*The victims on their way to Babi Yar*"<sup>100</sup> on a bright, sunny day.

- According to the *Kriegstagebuch des OKW, Raum Kiew*, from Sept. 29 and 30, 1941, the weather was rainy, the roads muddy.
- The road visible on the picture is dry.
- Some people on that picture are walking in the opposite direction.
- Not masses of people (33,000!) are walking on this picture, but only a few.
- There are no guards visible, even though they certainly would have been necessary if the alleged victims could hear the machine guns firing in the background.
- The people shown do not carry any belongings, although they allegedly were told to do so.
- The road allegedly shown runs from the Southeast to the Northwest. Thus, according to the shadows, the sun is shining from the west at an angle of some 50°. This is impossible for Kyiv during the end of September!
- The Hessische Hauptstaatsarchiv, referred to by Heer and Naumann as having delivered this picture, wrote April 15, 1997:<sup>101</sup>

*"It is not known here, where the assignation to Babi Yar stems from."*

25. And last but not least: at the memorial ceremony in Babi Yar in October 1991, the President of the *Bundestag* (German Parliament), Professor Dr. Rita Süßmuth, accused the Germans of the murder as follows:

*"Fifty years ago, 33,771 Jews were murdered here in the course of two days, and at least as many again in the following two years; countless other persons shared the same fate later. By the end of the German occupation of the Ukraine, the ravine had become a mass grave."*

- From where does she get her figures?
- Does this academic feel that she is above the scientific maxim of *de omnibus dubitandum est* (everything is to be doubted)?
- How many persons does the good professor consider "*countless*"?
- Did this President of the *Bundestag* not swear an oath of office?

## 6. Fundamental Questions

### 6.1. Regarding the Number of Victims

The 'precise' figure of 33,771 murdered Jews stems from Event Report 106 of October 7, 1941.<sup>3</sup> In the following, we shall just briefly show why even the very few figures given in Event Report

---

<sup>98</sup> *Meyers Enzyklopädisches Lexikon*, Bibliographisches Institut Mannheim, Mannheim 1971, v. 3, p. 274.

<sup>99</sup> J. G. Burg, *Schuld und Schicksal*, Schütz, Preußisch Oldendorf 1990, p. 50.

<sup>100</sup> Johannes Heer, Klaus Naumann (ed.), *Verbrechen der Wehrmacht 1941-1944*, Hamburger Edition, Hamburg 1995.

<sup>101</sup> Letter of the Hessische Staatsarchiv of April 15, 1997, to the author.

106 prove that what we have here are clumsy fabrications. Other evidence for the fabrication has been provided by Walendy,<sup>24</sup> among others.

One must assume that the destruction of the Jews was led by German experts. Wiehn<sup>7</sup> emphasizes that the *Einsatzkommandos* were headed by intellectuals (p. 17). But it is an unforgivable mistake for experts to claim that there were about 300,000 Jews in Kyiv, especially two-and-a-half weeks after that city had been occupied, by which time there would have been a relatively reliable overview of the situation.

140,256 Jews lived in Kyiv in 1928-1931.<sup>102</sup> It was a known fact that prior to the Second World War the Jewish population of the Ukraine had dropped by about one-third due to emigration to the less anti-Semitic northern and eastern regions of the Soviet Union;<sup>103</sup> this rate was a little lower for Kyiv due to the urbanization of the Jews. And it was also a known fact that the population of Kyiv had shrunk from some 850,000 – 930,000 persons to about 305,000 due to evacuations.<sup>104,105</sup> So if there had still been 300,000 Jews in Kyiv on about October 7, then these ‘experts’ would have found practically no one in Kyiv who was *not* Jewish – and it would not have taken experts to notice that.

Thus the “*non-Jewish population of Kyiv*” which Event Report 106 mentions and which expected the German authorities to take retaliatory measures due to the arson perpetrated by the Jews, would have consisted almost entirely of ghosts. And the *Encyclopedia of the Holocaust*,<sup>5</sup> too, would have been conjuring up ghosts in speaking of non-Jewish sectors of the Kyiv population that helped the Jews to hide, or that wrote denunciatory letters by the laundry-basketfull.

The literature<sup>31,54-58</sup> shows that fewer than 40,000 Jews, most primarily the elderly, remained in Kyiv by the time the German troops arrived.

Reitlinger<sup>106</sup> states that in early 1946, at a time when the great remigration of deportees and evacuees from Siberia had only just begun, there were already 100,000 Jews in Kyiv again. In 1959 there were 154,000.<sup>107</sup> Wiehn states that in 1959 15% of the inhabitants of Kyiv, *i.e.*, about 166,500, reported Yiddish as their mother tongue.<sup>108</sup> Added to this there is a significant unreported number, for the Russian census did not check the information regarding religion or ethnic origin and many Russian Jews preferred, and continue to prefer, to conceal their ethnicity. Furthermore, many were left out of the group at issue due to mixed marriages. One can thus safely assume that at least as many Jews lived in Kyiv in 1959 as had lived there in 1939. And finally, it is beyond dispute that a great many Jews died in the camps in Siberia, and that the birth rate was also noticeably below normal.

What would an unbiased court do when the numbers of alleged victims in a crime under investigation diverge this dramatically?

## 6.2. Regarding the Time of the Murder

According to the *Brockhaus Enzyklopädie*<sup>109</sup> the “*order for the final solution of the Jewish question*” was issued on July 31, 1941 (Nuremberg Trial Document NG 2586e), and was announced on the occasion of the ‘Wannsee Conference’ (January 20, 1942).<sup>110</sup>

<sup>102</sup> *Brockhaus Enzyklopädie*, *op. cit.* (note 92), 1970, v. 9, p. 516.

<sup>103</sup> W. N. Sanning, *op. cit.* (note 31), English ed. pp. 85ff.

<sup>104</sup> *Ibid.*, Table 6, English ed. p. 101.

<sup>105</sup> *Zentralblatt des Reichskommissars für die Ukraine*, Rowno, year 2 no. 2, Jan. 9, 1943, pp. 8-20.

<sup>106</sup> G. Reitlinger, *op. cit.* (note 44), p. 500.

<sup>107</sup> W.N. Sanning, *The Dissolution...*, *op. cit.* (note 31), p. 119.

<sup>108</sup> E.R. Wiehn, *op. cit.* (note 7), p. 112.

<sup>109</sup> *Brockhaus Enzyklopädie*, *op. cit.* (note 92), v. 9, p. 514.

Quite aside from the fact that historians and other interested persons are still searching in vain for this order for mass extermination, it is more than odd that many tens of thousands would have been slaughtered in Babi Yar before the order was even made known. Therefore, let us take a closer look at the relevant documentation.

In the January 26, 1942, letter from the Chief of the Security Police and the Security Service (Heydrich) to Under Secretary of State Luther in the Foreign Office, we read:

*“Now that the fundamental line to be taken with regard to the practical final solution of the Jewish question has been determined and the authorities involved are in complete agreement, I would ask you [...]”*

and farther down:

*“[...] to assign your official in charge of completing the outline requested by the Reich Marshal, in which the organizational, factual and material prerequisites for the practical implementation of the tasks involved in the solution are to be identified, to the required discussions of specific details. I intend to hold the first discussion of this kind on March 6, 1942 [...]”*

In other words, considerations of all the organizational, factual and material prerequisites for a practical implementation of the tasks involved in the solution were not even begun until about mid-March 1942. Heydrich announced his appointment as delegate for the preparations for the Final Solution. This further confirms our earlier arguments.

Fundamental questions were to be settled. It is a big step from settling fundamental questions to planning details, and another step to implementing detailed plans. Heydrich mentioned retrospectively: *“forcing [the Jews] back, speeding up [their] emigration”*, and:

*“The goal was to cleanse the German sphere of Jews in a lawful manner. **After prior approval** by the Führer, **the evacuation of the Jews EASTWARD** has replaced emigration as a further possible solution.”* (Emphasis added.)

How likely are mass murders months before the prior approval of the victims’ evacuation? Part of the purpose of the evacuation was also to gain experience *“relating to the coming final solution of the Jewish question.”* So, there was not even an overall concept at that time.

To deal with the final solution (which the document shows to be, at this point, evacuation and the use of Jews as labor force), consultations between experts from the Foreign Office, the Security Police and the Security Service are suggested. Again there is nothing definite.

This gives rise to a pressing question: On whose orders were the “33,771 murders” committed on September 29 and 30, 1941, four months before the Wannsee Conference was convened and easily five months before the disputed Wannsee Conference Protocol copies finally reached the participants? Surely mass murder without backing from higher-up is anything but likely. All the more so, considering that even later on, *i.e.*, after the Wannsee Conference, a good number of concentration camp commandants were convicted by Hitler’s justice system, some of them even executed, for cruelty and other irregularities.<sup>111</sup>

So when did the murders really take place?

---

<sup>110</sup> Cf. Roland Bohlinger, Johannes P. Ney, *Zur Frage der Echtheit des Wannsee-Protokolls*, 2<sup>nd</sup> ed., Verlag für ganzheitliche Forschung und Kultur, Viöl 1992, 1994; Roland Bohlinger (ed.), *Die Stellungnahme der Leitung der Gedenkstätte Haus der Wannsee-Konferenz zu dem von Bohlinger und Ney verfaßten Gutachten zur Frage der Echtheit des sogenannten Wannsee-Protokolls und der dazugehörigen Schriftstücke*, Verlag für ganzheitliche Forschung, Viöl 1995.

<sup>111</sup> K. Koch (Buchenwald) and H. Florstedt (Majdanek); cf. A. Ruckerl, *op. cit.* (note 46), pp. 126f.

### 6.3. Regarding the Site of the Crime

Where was the crime committed?

- In the cemetery, beside the cemetery, in a forest and if so, in which one?
- At the edge of the ravine, in the ravine, and in which ravine anyhow?
- In a brickworks, in Kyiv, in gas vans, or perhaps even in the Dnjepr River?

### 6.4. Regarding the Murder Weapons

What do the sources discussed allege the murder weapons to have been?

- machine guns
- submachine guns
- automatic rifles
- rifle butts
- clubs
- rocks
- tanks
- mines
- hand grenades
- gas vans
- bayonets and knives
- burial alive
- drowning
- injections
- electric shock
- Did the Germans avail themselves of the Soviet method of shooting victims in the neck?

What would an unbiased court do if it had to pass judgment on an alleged mass murderer, if the witnesses were in such thorough disagreement?

### 6.5. Logistic and Organizational Questions

Shooting 33,771 or even far more people within two days and then removing all traces of the deed (which is impossible anyhow, with the investigative means available today!) would require superb organization and logistics. Some aspects thereof were discussed in the context of specific issues, and for reasons of space constraints we shall have to leave it at that.

We would stress, however, that these problems would have been unmanageable under extreme conditions such as prevailed right after the taking of Kyiv, with fires, blasting and partisan activity on the one hand and the continuing battles at the front, with their concomitant demand for human and material resources, and in autumn of 1943 in the face of the advancing deadly front of the Soviet army.

### 6.6. Securing Evidence

Why did no one ever try to secure any evidence in order to prove the murders?

By way of contrast, some time ago, following a double murder of policemen, the German police vowed to dig up the entire military training area of Sennelager if necessary to find the bodies.

When the German Federal Criminal Police Office got into trouble in the context of the cause of death of a terrorist following the 1993 incident in Bad Kleinen (one terrorist was shot by the police, another one arrested), a Minister resigned, a very high-ranking official got his walking papers, the



entire track was gone over virtually with a fine-tooth comb, domestic and foreign institutes were commissioned with investigations, the Special Unit involved was interrogated, physical evidence was compared with testimony – practically everything that *could* be done to remove any and all doubts *was* done.

But in the case of Babi Yar, witnesses and allegations (and from Stalin's glorious days, no less!) are blindly given full credence even though they contradict each other and claim the silliest impossibilities.

Why does no one bother to lift a finger in this instance, to secure bodies and remains, residue, murder weapons etc., even though countless victims are at issue? Is such conduct by the authorities responsible in keeping with the binding international legal guidelines?

It is clearly not necessary to specify which questions a high-ranking, disinterested, international and incorruptible committee of experts would have to examine in order to arrive at a relevant forensic assessment!

But the incriminating *documents* must also be examined very critically, not least of all because they too are rendered questionable by the evidence contained in the air photos.<sup>116</sup> The so-called Gerstein Report,<sup>112</sup> and the Jerusalem Trial of John Demjanjuk<sup>113</sup> no less, show that the champions of one particular school of thought do not hesitate to commit grotesque falsifications even many decades after the end of the war. Some few examples:

Despite a clear and unequivocal international report issued after the discovery of the mass graves of Katyn, the atrocity propaganda churned out by Ilya Ehrenburg and Wassily Grossmann continued – not only throughout the Nuremberg Trials, but right up until a few years ago – to impute the Stalinist mass murders to the Germans.<sup>114</sup> In this vein, Katyn and Babi Yar are not the only examples that come to mind; there are also the massacres of Lvov, Char'kov, Bykivnia, Bielhorodka, Darnitza and Vinnica. They represent many hundreds of thousands of victims, including some from the liquidation era of Lazar Moisejevich Kaganovich.<sup>115</sup> Katyn is the only case so far where the Soviets have admitted as late as 1991 that *they* were the perpetrators!

## 6.7. Babi Yar: From Mass Murder Site to Garbage Dump

After the end of the war the Soviets turned the ravine of Babi Yar into a municipal garbage dump, and later into a garbage incineration site.<sup>116</sup>

That the Soviets intended to build a sports facility over the site of indescribable crimes is no less incomprehensible...<sup>117,118</sup>

To the best of this author's knowledge, Khrushchev's reprimand to Yevtushenko was never made public in the western world. Did this terse rebuke perhaps reflect the plain and simple truth?

*Just what is self-evident about Babi Yar?*

---

<sup>112</sup> H. Roques, *Faut-il fusiller Henri Roques?*, Ogmios Diffusion, Paris 1986; cf. the chapter by F. P. Berg, this volume.

<sup>113</sup> Cf. the chapter by A. Neumaier, this volume.

<sup>114</sup> Cf. F. Kadell, *Die Katyn-Lüge*, Herbig, Munich 1991.

<sup>115</sup> *Brockhaus Enzyklopädie*, *op. cit.* (note 92), 1970, v. 9, p. 602; and R. Conquest, *The Harvest of Sorrow*, Oxford University Press, Oxford / New York 1986, p. 328.

<sup>116</sup> *Semit – Das deutsch-jüdische Meinungs- + Zeitungsmagazin*, Dreieich 1991, no. 4, p. 68.

<sup>117</sup> *Neue Zürcher Zeitung*, Zürich, Jan. 20, 1963, p. 6.

<sup>118</sup> V. Nekrasow, *Literaturnaja Gazeta*, Moscow, Oct. 10, 1959.

# Reprisals and Orders From Higher Up

KARL SIEGERT, WITH COMMENTS BY GERMAR RUDOLF

\* \* \*

## Introduction by Germar Rudolf, Editor

In early 1944 the Allies landed in Italy, a few miles south of Rome. In order to keep the immense cultural treasures of Rome safe from harm, the German Field Marshal Kesselring declared Rome an “open city”, i.e., a battle-free zone. This made Rome the hotbed of all kinds of partisan groups and foreign secret service activities. Since Italy was at that time engaged in a sort of civil war (not all Italians agreed with the ousting of Mussolini and the betrayal of Germany), the situation in Rome, only a few miles behind the battle front, was explosive. These were the conditions under which Obersturmbannführer [Lieutenant Colonel] Herbert Kappler of the Security Police was charged with keeping peace and order in the city, a task at which he was indeed largely successful.

On March 23, 1944, however, something happened. On this day, as on many other days before, the police regiment “Bozen”, which was comprised almost entirely of South Tyroleans, marched through the Via Rasella. As the regiment passed by a street-sweeper’s cart, an enormous explosive charge in the cart, mixed with iron shrapnel, blew up. 32 of the German policemen were killed instantly, another 10 died later of their injuries. 60 policemen were badly wounded.

To prevent an escalation of the partisan warfare in Rome, the Wehrmacht Supreme Command reacted to this assassination (which had violated international law) by posting placards announcing that if the perpetrators did not turn themselves in, 10 civilians would be shot for every policeman that had been killed. Kappler even released captured partisans with the order to inform the assassins in the underground of this announcement and to persuade them to surrender. When no one had given themselves up by March 24, 335 persons were executed in the Ardeatine Caves near Rome; Kappler had assembled this group mostly of prisoners, and of criminals, saboteurs, spies and partisans who had already previously been sentenced to death.

After the war, Kappler was sentenced to lifetime imprisonment for this act, but his subordinates were acquitted.<sup>1</sup> However, some left-wing lobbyists and the public prosecutor also wanted to imprison, for life, one Captain Erich Priebke, who had belonged to Kappler’s unit and had participated in the execution. The Argentinean government had extradited him to Italy in 1996. The Italian military court acquitted Priebke on August 2, 1996, on the grounds that the limitation period had expired. At this announcement an irate lynch mob gathered outside the court,<sup>2</sup> so that the judges ordered Priebke taken into custody again, and decided in early February 1997 that he would have to

---

<sup>1</sup> Rudolf Aschenauer, *Der Fall Kappler*, Damm-Verlag, Munich 1968; this work also contains much information on the legality of the execution of hostages, esp. pp. 6-8.

<sup>2</sup> Two detailed monographs appeared in Italy about the Priebke case: Pierangelo Maurizio, *Via Rasella, cinquant' anni di menzogne* (Via Rasella, Fifty Years of Lies), Maurizio Editione, Roma 1996; Mario Spataro, *Repressaglia* (Reprisal), edizione Settimo Sigillo, Roma 1996). In Germany the *Deutsche Rechtsschutzkreis* was the first to publish a brief summary of the case, well worth reading: Günther Stübiger, *Der Priebke-Prozeß in Italien*, Schriftenreihe zur Geschichte und Entwicklung des Rechts im politischen Bereich, issue 5, Deutscher Rechtsschutzkreis, Postfach 40 02 15, D-44736 Bochum 1996, DM 5.-; more detailed: G. Gysecke, *Der Fall Priebke*, Verlagsgesellschaft Berg, Berg am Starnberger See 1997.

be retried before a military court.<sup>3</sup> This court eventually decided, on July 22, 1997, that Priebke would have to go to prison for five years.<sup>4</sup> Meanwhile, those partisans who had been responsible for the explosives attack and who are still living today are also being investigated, on charges of murder, even though it is rather unlikely that they will be tried.<sup>5</sup>

In discussions of the Priebke case, the point at issue is not so much the details of the case per se as first and foremost the legitimacy of executions of hostages or of reprisals against civilians by a military occupation power. In this context, Dr. jur. Karl Siegert, Professor at the University of Göttingen, drew up a legal expert report shortly after the end of the war, pertaining to the trial conducted at that time in Italy against Herbert Kappler.<sup>6</sup> Since this expert report is of extraordinary importance, we shall reproduce it in the following – leaving out, for reasons of space, the discussions of legitimate requisitions.<sup>7</sup> The report is followed by several other examples as well as supplemental explanations pertaining to partisan warfare during the last war, and the German reaction to them.

*Germar Rudolf*

\* \* \*

## I. The Legal Sources of International Law and Their Development

*Reprisals* were not regulated by the Hague Land Warfare Convention of October 18, 1907.<sup>8</sup> They received first mention in Article 2 Section 3 of the Geneva Agreement of September 27, 1929, about the treatment of prisoners of war. This Agreement prohibited reprisals against prisoners of war. A general prohibition of reprisals against civilians was not issued until August 12, 1949, by the Geneva Convention Relative to the Protection of Civilian Persons in Time of War.<sup>9</sup> Its Article 33 decrees:

---

<sup>3</sup> “SS man on trial again for caves massacre”, *The Daily Telegraph*, April 15, 1997, p. 16.

<sup>4</sup> AP, “Priebke convicted in WWII massacre”, Rome, July 22, 1997. Priebke was sentenced to 15 years’ imprisonment, of which 10 years were amnestied. The co-defendant, Karl Hass, was sentenced to 10 years, of which he served only 8 months before being freed under an amnesty. Meanwhile, Priebke has found refuge in an Italian monastery: Reuter, “Ex-Nazi Priebke rejects Italy court order to move”, Rome, August 7, 1997. In his appeal Priebke was given a life time sentence, ZDF-heute News, March 7, 1998.

<sup>5</sup> Reuter, “Italian judge reopens 53-year-old bombing probe”, Rome, June 28, 1997; however, the matter will only proceed to trial if the court can force itself to interpret the bombing attack as not having been directed against the German occupation troops, for such things are not a punishable offense under present Italian law.

<sup>6</sup> Prof. Dr. jur. Karl Siegert, *Repressalie, Requisition und höherer Befehl*, Göttinger Verlagsanstalt, Göttingen 1953, 52 pp. Copies of this expert report are available from Castle Hill Publishers, PO Box 118, Hastings TN34 3ZQ, UK, for US \$10.-.

<sup>7</sup> Due to space limitations, the section dealing with lawful requisitions will not be reproduced here, and for this reasons the following sections are numbered out of sequence. Since the author of this contribution deceased long time ago, we were not in every case able to determine the complete data of all works, which are in most cases quoted only in a very brief form in the original work. The sources which were cited, but which are omitted here due to the abridgement, are: Galasso and G. Sucato, *Codici penali militari di pace e di guerra*, 2<sup>nd</sup> ed., [Stella?] Roma 1941, Heinrich B. Gerland, *Deutsches Reichsstrafrecht*, 2<sup>nd</sup> ed., de Gruyter, Berlin and Leipzig 1932 (reprint: Keip, Goldbach); F. von Liszt, Schmidt, *Lehrbuch des deutschen Strafrechts*, v. 1, 26<sup>th</sup> ed., de Gruyter, Berlin 1932, H. Maschke, *Das Krupperteil und das Problem der Plünderung*, Musterschmidt, Göttingen 1951; Pannain, *Manuale di diritto penale, parte generale*, Roma 1942; W. Rentrop, E. Hasper, (eds.), *Requisitionen, Besetzungsschäden und ihre Bezahlung*, Fachverlag für Wirtschafts- und Steuerrecht, Stuttgart 1950; Rogowski, *Repressalie*, Dissertation, Göttingen 1950; *Summing Up*, Judge Advocate 3-5-1947 in Venedig, Extract.

<sup>8</sup> Cf. R. von Laun, *Haager Landkriegsordnung*, 4<sup>th</sup> ed., Wolfenbüttler Verlagsanstalt, Wolfenbüttel 1948.

<sup>9</sup> Comité international de la croix rouge, *Les conventions de Genève du 12 août 1949*, Geneva 1949.

“Reprisals against protected persons and their property are prohibited.”

Article 34 supplements this with the order that taking hostages is also prohibited. In the time of the Second World War, therefore, there was a gap in the conventions for the treatment of civilians.

*Requisitions* are discussed in Article 52 of the Hague Land Warfare Convention of October 18, 1907. In this context, however, developments have since gone beyond the framework of the Convention [...].<sup>7</sup>

There are no international legal agreements concerning *orders from higher up* and their effect on the legitimacy or indictability of the actions of soldiers carrying out a reprisal or requisition, unless we accept the decrees of the victorious Allies in the London Agreement of August 8, 1945, as international law.

Under these circumstances we must go beyond the framework of the Convention.

The regulations of international law follow from three sources:

1. International treaties
2. International customs as expressions of a general practice that is acknowledged as legal regulation
3. General principles of law

In international and national practice as well as in international jurisprudence these three sources have increasingly found recognition. First and foremost we would mention Article 38 of the Statute of the International Court of Justice. We would also mention the American Nuremberg verdicts in Cases VII and XI, and refer to the Italians Pallieri, Cavaglieri and Francesco Rocco, the Frenchman Cavaré, the Austrian author Verdroß, the Dane Alf Ross, the Germans Wilhelm Sauer, Ernst Sauer, Drost, Schütze, Schwarzenberger, and others.<sup>10</sup> Some authors, such as Anzilotti, Hyde, Guggenheim and Sibert, recognize only two judicial sources of international law, namely treaties and common law.<sup>11</sup> The third source – the general principles of law – is also needed, however, to supplement the treaties and common law.<sup>12</sup>

With the aid of these three judicial sources, we can achieve a reconciliation between the older Continental system characterized by the closed, logical structure of its principles (main advocate, Anzilotti), and the Anglo-American system of jurisprudence guided by practical examples (case law).<sup>13</sup> In this way it is also possible to systematically consider and solve even newer problems of international law which were not yet known to the authors of the older agreements.

<sup>10</sup> Cf. A. Verdroß, *Völkerrecht*, 2<sup>nd</sup> ed., Springer, Vienna 1950, pp. 107-113, and Pallieri as quoted there; Drost, *Grundlagen des Völkerrechts*, Munich and Leipzig 1936, pp. 48ff., who also quote Cavaglieri; Francesco Rocco, *Sistema di diritto internazionale*, Napoli 1938, p. 28; Cavaré, *Le droit international publique positif*, V. 1, Paris 1951, p. 194; Wilhelm Sauer, *System des Völkerrechts*, Röhrscheid, Bonn 1952, pp. 364f.; Ernst Sauer, *Grundlehre des Völkerrechts*, Pick, Cologne 1947, p. 31 (2<sup>nd</sup> ed.: Heymann, Cologne 1955), and others; G. Schwarzenberger, *Einführung in das Völkerrecht*, Mohr, Tübingen 1951, pp. 26, 28; H. A. Schütze, *Die Repressalie unter besonderer Berücksichtigung der Kriegsverbrecherprozesse*, Röhrscheid, Bonn 1950, p. 3; Verdict of the American court-martial no. XI in Nuremberg, of April 11, 1949 (Wilhelmstraße), Protocols, p. 27 616; Alf Ross, *Lehrbuch des Völkerrechts*, Kohlhammer, Stuttgart 1951, pp. 81ff.; Laun, *op. cit.* (note 8), pp. 20ff.; Verdict of the American court-martial no. VII in Nuremberg, of Feb. 19, 1948 (SouthEast Trial), Protocols, p. 10300. Further listings in A. S. de Bustamente Sirven, *Droit international publique*, v. 1, Recueil Sirey, Paris 1934, pp. 60ff., and G. H. Hackworth, *Digest of international law*, vol. I, U.S. Gov. Print. Off., Washington 1940, p. 1.

<sup>11</sup> D. Anzilotti, *Lehrbuch des Völkerrechts*, 3<sup>rd</sup> ed., trans. by Bruns and Schmid, de Gruyter, Berlin 1929, p. 49; C. C. Hyde, *International Law*, v. I, Little Brown & Cie., Boston 1947, p. 10; P. Guggenheim, *Lehrbuch des Völkerrechts*, v. 1, Verlag für Recht und Gesellschaft, Basel 1948, pp. 141, 145; M. Sibert, *Traité de droit international*, v. 1, Dalloz, Paris 1951, pp. 32, 34.

<sup>12</sup> Also Verdroß, *op. cit.* (note 10), pp. 115, 120.

<sup>13</sup> For details cf. Schütze, *op. cit.* (note 10), pp. 11-15.

This goes first and foremost for the application of the Hague Land Warfare Convention of 1907. At the time of its inception there were as yet only few automobiles, neither armored vehicles nor airplanes, neither carpet-bombing nor nuclear weapons, and also no “total war” where civilians are both actively and passively enlisted for participation. In this context, the problem of partisan warfare has attained a significance that could be in no way foreseen in 1907. As well, the inhabitants of occupied zones, even if they have not actively taken up arms, are subjected to the effects of war in a completely different way than was the case in earlier wars. The Belgian court-martial in Lüttich has stated that certain regulations of the Hague Land Warfare Convention are entirely outdated.<sup>14</sup> In his study of the development of the law governing occupation in wartime from 1863 to 1914, the American author Graber<sup>15</sup> wrote in 1949 that it is necessary to examine whether the regulations issued between 1863 and 1914 do in fact still represent the fundamental principles of international law as these pertain to wartime occupation, or whether it is necessary to work out an entirely new law incorporating the new aspects of war-time occupation in present times.

According to the American verdict in Case V, it is necessary to examine the actions of the accused in relation to the circumstances and conditions of their surroundings:<sup>16</sup>

“Sensible and practical guidelines must be applied.”

The aforementioned American verdict in Case VII (SouthEast Trial) speaks of the fundamental principles of justice which most nations have adopted.<sup>17</sup> But justice is not the only thing to evolve and change. Views and judgments about facts of recent history are also subject to change based on the discovery of new historical sources. The view of history that prevailed in 1945 no longer agrees with today’s.

The best example of this is the 1940 war in Norway. The Nuremberg trial of the chief war criminals dealt with the Norwegian campaign as a case of German aggression.<sup>18</sup> Later publications, however, showed that long before the German plans were made, an attack on Norway’s neutrality was being prepared in England, under the direction of the then Minister of Defense, Churchill.<sup>19</sup> On February 5, 1940, the Allied Supreme Council of War decided to deploy three or four divisions to Narvik, in northern Norway.<sup>20</sup> In the night of April 7-8, 1940, British and French naval forces placed mines in Norwegian territorial waters.<sup>21</sup> Thus, the British and French governments prepared and partially implemented an attack on Norway and its neutral status before the Germans ever did. Consequently, the view of history expressed by the International Military Tribunal in Nuremberg with respect to the case of Norway was wrong. We must ask that both sides be judged according to the same standards.

One can even go a step further and apply the so-called principle of *tu quoque* to suspend an aspect of international law if the opposing side also violates it. The International Military Tribunal applied

---

<sup>14</sup> Verdict of the permanent court-martial of the province of Lüttich, 2<sup>nd</sup> French chamber, of June 29, 1951, No. 2251 of the St. L., 1947 against Lippert, Strauch and others (Lippert), p. 26; H. A. Smith, *The crisis in the law of nations*, Stevens & Sons, London 1947, p. 16, 32; Laun, *op. cit.* (note 8), p. 15; H. R. Hoppe, *Die Geiselschaft, ihre Entwicklung und Bedeutung*, dissertation, University of Göttingen, Göttingen 1952, p. 12.

<sup>15</sup> D. A. Graber, *The development of the law of belligerent occupation, 1863-1914*, Columbia Univ. Press, New York 1949, p. 292.

<sup>16</sup> Verdict of the American court-martial no. V in Nuremberg, of Dec. 22, 1947 (Case V), Protocols, p. 10747. SouthEast Trial, *op. cit.* (note 10), Protocols, p. 10397.

<sup>18</sup> Vgl. M.P.A. Hankey, *Politics, trials and errors*, Pen-in-Hand, Oxford 1950, p. 71, and IMT, *Der Prozeß gegen die Hauptkriegsverbrecher*, 14.11.1945-1.10.1916, v. XXII, Nuremberg 1947f., p. 510; K. Heinze, K. Schilling, *Die Rechtsprechung der Nürnberger Militärtribunale*, Girardet, Bonn 1952, Nr. 584.

<sup>19</sup> Evidence from Churchill’s *Zweiter Weltkrieg* and other sources, in W. Hubatsch, *Die deutsche Besetzung von Dänemark und Norwegen, 1940*, Musterschmidt, Göttingen 1952, pp. 13ff.

<sup>20</sup> Cf. Hubatsch, *ibid.*, p. 16.

<sup>21</sup> Cf. *ibid.*, p. 140.

this principle in favor of Admiral Dönitz with respect to his conduct of unrestricted submarine warfare when the American Admiral Nieflitz testified that his forces had also engaged in unrestricted submarine warfare in the Pacific.<sup>22</sup> The American verdict in Case XII (trial of the Wehrmacht Supreme Command) stated that Germans may not be punished for an act for which Americans, British, French or Russians would not also be prosecuted or convicted.<sup>23</sup> Unfortunately this principle was not applied with anything near the desirable degree of consistency.

The principle of *tu quoque* is dangerous because it can lead to a disintegration of the fundamentals of international law, whereas what we need to do is to build up and consolidate a system of international law. If, however, two warring parties consistently disregard a judicial norm, the evolution and development of the law must be reviewed in the context of this *desuetude*.<sup>24</sup> Such a case represents a modification of common law.

## II. Lawful Reprisals

### a) Confusion of Concepts

The preceding general comments were necessary in order to create a solid foundation for understanding before we enter the maze of reprisal law. The late criminologist Franz Exner stated at the International Military Tribunal in Nuremberg that there is only one aspect of reprisal law about which there is absolute certainty, namely, that reprisals against prisoners of war are inadmissible, and that everything else is contested and by no means valid international law.<sup>25</sup> Even the definition of the various concepts is often unclear. In particular, the concepts of collective punishment, hostages, retaliation and reprisal are frequently confused. However, they are clearly distinct.

*Collective punishment* avenges a concrete individual act by punishing a group of persons who bear a share of the responsibility for the act. If such shared responsibility is not given, then under Article 50 of the Hague Land Warfare Convention of 1907 collective punishment is prohibited.<sup>26</sup>

The term *retaliation* is also frequently used. This refers to the reaction to a breach of international law with a similar countermeasure.<sup>27</sup>

Concerning the concept of *reprisals*, Oppenheim-Lauterpacht's definition has been most widely accepted.<sup>28</sup> According to this definition, a wartime *reprisal* is the case if one warring party retaliates against another by means which are otherwise unlawful acts of warfare, and with which he wants to force his opponent, his opponent's branches and the members of the opposing armed forces to give up their illegal acts of war and to return to the principles of lawful warfare.

<sup>22</sup> Cf. *IMT*, v. XXII, pp. 635f., and Hoppe, *op. cit.* (note 14), p. 114. The American Nuremberg verdict in the SouthEast Trial, *op. cit.* (note 10), considers *tu quoque* as mitigating circumstance, cf. protocols pp. 10002 and 10147, as well as K. Heinze, K. Schilling, *op. cit.* (note 18), No. 611, 612.

<sup>23</sup> Verdict of the American court-martial no. XII in Nuremberg, of Oct. 27, 1948 (Trial of the Wehrmacht Supreme Command), Protocols, p. 27616.

<sup>24</sup> Wahl, *Raub und Plünderung in den besetzten Gebieten*, expert report to the U.S. case Fall XI, 1948, p. 29, speaks of a change in legal norms and adds that at least those who themselves had conducted a ruthless war against civilians ought to be denied the active authorization to bring about the criminal punishment of another party.

<sup>25</sup> Cf. Exner, *IMT*, v. IX, p. 364.

<sup>26</sup> Cf. Laun, *op. cit.* (note 8), p. 48.

<sup>27</sup> Cf. E. Vanselow, *Völkerrecht*, Mittler, Berlin 1931, p. 85; Hyde, *op. cit.* (note 11), v. III, p. 1840, says: "*similar in kind*".

<sup>28</sup> L.F.L. Oppenheim, H. Lauterpacht, *International Law, a Treatise*, v. II, 6<sup>th</sup> ed., Longman, London 1944, 7<sup>th</sup> ed., *ibid.* 1952, §247; similarly §358 of the *American Rules of Land Warfare* (U.S. War Dept. General Staff (ed.), Gov. Print. Off., Washington 1914-15 & 1917) with approval of Hackworth, *op. cit.* (note 10), v. VI, p. 181. Cf. also Art. 8 of the *Italian Legge di guerra* of July 8, 1938, as well as Sucato, *Istituzioni di diritto penale militare*, v. II, Roma 1941, p. 509.

This definition shows better than most others<sup>29</sup> that a reprisal is *not* retrospective punishment or revenge for past injury.<sup>30</sup> Rather, a violation of international law by the opposing side is its prerequisite, and its purpose is to force this opposing side to restrict itself to internationally lawful behavior in future.<sup>31</sup> Reprisals differ from collective punishment in that they are directed against members of an enemy nation with *no* regard for their personal guilt, whereas collective punishment has such guilt as its particular requirement.<sup>32</sup> This difference is often overlooked. The American verdict in Case IX,<sup>33</sup> for example, speaks first of “*reprisals*” and then of “*general penalty*” in the sense of Article 50 of the Hague Land Warfare Convention. In this way the verdict comes to false conclusions with regard to “*reprisals*”.<sup>34</sup>

Another difference between reprisals and collective punishment is that the former tries to achieve a specific mode of behavior on the part of the enemy,<sup>35</sup> whereas collective punishment finds its justification and its legal grounds strictly within the crime that was committed. In this way, one could perhaps draw a parallel between collective punishment and a court sentence, vs. reprisals and measures taken by the police.

Reprisals differ from self-defense in that they have as their prerequisite an act that was committed in violation of international law, while self-defense has no such prerequisite. The two concepts are similar in that both aim to prevent future violations of the law.

If a reprisal interferes with the freedom or the lives of individuals, it overlaps with the concept of *hostage-taking*. We shall leave out of consideration the so-called *contractual hostages*, which may be taken as part of an international agreement in order to ensure its implementation, as well as hostages that were taken to enforce requisitions, contributions, etc.<sup>36</sup> *Security hostages*, however – forcibly taken guarantors for the lawful behavior of the opposing party<sup>37</sup> – do come within our present scope. These hostages are liable with their life, and if their side engages in unlawful actions, they become the victims of reprisals. But if persons are not taken prisoner for reprisal purposes until

<sup>29</sup> Eg. cf. Vanselow, *op. cit.* (note 27), p. 85; E. von Waldkirch, *Das Völkerrecht*, Helbing und Lichtenhahn, Basel 1925, p. 328.

<sup>30</sup> P. Fauchille, *Traité de droit international publique*, Tome II, 8<sup>th</sup> ed., Rousseau, Paris 1921, n. 1022, emphasizes this.

<sup>31</sup> Similarly K. Strupp, *Wörterbuch des Völkerrechts*, v. I + II, de Gruyter, Berlin 1924f, p. 350; F. von Liszt, M. Fleischmann, *Das Völkerrecht*, 12<sup>th</sup> ed., Springer, Berlin 1925, p. 439; Schütze, *op. cit.* (note 10), p. 41; Guggenheim, *op. cit.* (note 11), v. II, p. 583; Art. 358 of the American *Rules of 1940*; Fauchille, *op. cit.* (note 30), n. 1022, describes reprisals as “*moyen de coercion, non un châtement*”.

<sup>32</sup> Laun, *op. cit.* (note 8), p. 43, even suggests that reprisals were usually deliberately and on principle directed against innocent persons. But then he speaks of collective punishment without regard for guilt, and thus leaves the way open for misunderstandings. Hyde, *op. cit.* (note 11), v. III, p. 1843, points out, as do we, the clear distinction between “*relation*” and “*penalty*”. Art. 454 of the British *Manual of Military Law* (by L.F.L. Oppenheim and J. E. Edmonds, Her Majesty Stationary Office, London 1929) emphasizes that “[...] *reprisals* [...] *in most cases inflict suffering upon innocent individuals* [...]”. R. v. Keller, *Der Geisel im modernen Völkerrecht*, Forchheim 1932, p. 57, aptly differentiates between reprisals and collective punishment by pointing out the different elements of liability and punishment.

<sup>33</sup> Verdict of the American court-martial no. IX in Nuremberg, of April 10, 1948 (Case IX), Protocols, English text, pp. 6759f.

<sup>34</sup> The verdict overlooks the fact that Art. 50 of the Hague Land Warfare Convention regulates only the “*general penalty*”, but says nothing about retaliation and reprisals; similarly, Hyde, *op. cit.* (note 11), v. II, p. 1840, n. 1, unclear Guggenheim, *op. cit.* (note 11), v. II, p. 824.

<sup>35</sup> Hoppe, *op. cit.* (note 14), p. 48, describes them as measure to force submission. v. Keller, *op. cit.* (note 32), p. 37, says that their nature is expressed in their guarantee function. The Italian verdict of the Tribunale Territoriale di limna of July 20, 1948 says aptly (p. 44): “*La rappresaglia deve avere scopo repressivo e preventivo, non vendicativo*”.

<sup>36</sup> Cf. Laternser, *Verteidigung deutscher Soldaten*, Bohnemeier, Bonn 1950, p. 128.

<sup>37</sup> Cf. Vanselow, *op. cit.* (note 27), p. 240.

AFTER an act has been committed, then it is no longer appropriate to speak of hostages.<sup>38</sup> They are then reprisal prisoners.<sup>39</sup>

In the subject literature, discussions about the permissibility of the execution of hostages always focus on the question of whether killing is a permissible form of reprisal. In this respect, the issue of the execution of hostages is identical to that of lawful reprisals.<sup>40</sup>

Let us investigate whether reprisals and the killing of security hostages were permissible up to 1949. Since customs and common law are very important in this context, let us first take a look at how reprisals were applied in practice.

## b) Reprisals from 1863 to 1951

The American verdict in the SouthEast Trial (Case VII) assumed<sup>41</sup> that the Germans had been the first to kill reprisal prisoners and security hostages. This is easily disproved.

Let us look first at the time preceding the *start of the First World War*.

As early as July 30, 1863, the American President Lincoln threatened to execute prisoners of war in retaliation against the killing of Negroes; General Sherman ordered the execution of 54 prisoners of war as reprisal for the murder of 27 of his soldiers, whose bodies had been found bearing the notice “*Death to the plunderers*”.

During the Russo-Turkish War of 1877, the Russian Commander of Thessaly ordered that the inhabitants of houses from which shots had been fired at Russian soldiers be hung from their house doors.<sup>42</sup>

Considerable numbers of hostages were also taken during the wars of the 19<sup>th</sup> century, for example in the Italian wars of 1848/49 and 1859, in the Crimean War and in the German wars of 1864 and 1866, by the French in Algiers, by the Russians in the Caucasus, by the English in their colonial wars,<sup>43</sup> and in the Franco-Prussian War of 1870/71 as well.<sup>44</sup> In the latter case, as well as in the Boer War, hostages were taken predominantly to ensure safe conduct for railway trains.<sup>45</sup>

*In the First World War*, set customs became established regarding the taking of hostages, as well as their execution, since the Germans, the Russians and the French (in Alsace) all took non-participants as security hostages.<sup>46</sup> Hyde tells of the execution of hostages by the Bulgarians.<sup>47</sup> According to Hackworth, the French government in 1918 suggested retaliation against an Austrian

<sup>38</sup> But this was the wording of an order of Hitler’s of March 23, 1944, in the case of the Via Rasella in Rome; cf. Laternser, *op. cit.* (note 36), p. 63.

<sup>39</sup> Cf. Hoppe, *op. cit.* (note 14), p. 50. Similarly, the American verdict in the SouthEast Trial, *op. cit.* (note 10), Protocols, p. 10320, G. Lummert, *Die Strafverfahren gegen Deutsche im Ausland wegen Kriegsverbrechens*, Arbeitsgemeinschaft vom Roten Kreuz in Deutschland (British Zone), Hamburg 1949, p. 61, Engl. *Law Reports of Trials of War Criminals*, v. VIII, London 1948, Case 44 (Kesselring), p. 14.

<sup>40</sup> In §358d of the American *Rules of Land Warfare* the problems of hostages and reprisals are also presented in a close relationship; cf. Laternser, *op. cit.* (note 36), p. 129.

<sup>41</sup> *Op. cit.* (note 10), Protocols, p. 10324; also Oppenheim-Lauterpacht, *op. cit.* (note 28), 7<sup>th</sup> ed., v. II, p. 591, where the killing of hostages is treated as a one-sided (reprehensible) German practice.

<sup>42</sup> Account by Laternser, *op. cit.* (note 36), p. 192.

<sup>43</sup> Evidence in Hoppe, *op. cit.* (note 14), p. 26.

<sup>44</sup> For examples see v. Keller, *op. cit.* (note 32), pp. 47ff., Schütze, *op. cit.* (note 10), p. 46, and others.

<sup>45</sup> Cf. v. Keller, *op. cit.* (note 32), pp. 48-54. The railway hostages have been condoned by Oppenheim-Lauterpacht, among others: *op. cit.* (note 28), v. II, p. 259. Art. 463 of the British *Manual* objects to them because they are also endangered by legitimate incidents of war.

<sup>46</sup> Cf. Hoppe, *op. cit.* (note 14), p. 41; v. Kellers, *op. cit.* (note 32), pp. 25, 39.

<sup>47</sup> Hyde, *op. cit.* (note 11), v. III, p. 1903, n. 3.



breach of international law; this retaliation was to involve the reprisal execution of two Austrian officers (prisoners of war) for each French airman that was killed.<sup>48</sup>

After the First World War this practice was commonly retained and perpetuated. In December 1918, for example, the Belgian Commanders of occupied cities in the Rhineland ordered the taking of hostages whose lives were to guarantee the safety of the occupation troops.<sup>49</sup> In 1919, the Romanian General Madarescu demanded 500 hostages, of which he threatened to shoot 5 for each Romanian killed.<sup>50</sup> In Beuthen, Upper Silesia, the French took more than 20 reprisal prisoners in retaliation against the shooting death of one Major.<sup>51</sup> Further, during the invasion of the Ruhr region in 1923, French Commanders imposed severe prison sentences on German persons in retaliation for acts of sabotage committed against the invaders by the populace.<sup>52</sup> Security hostages were also taken there on railway trains serving the French and Belgian regime.<sup>53</sup> During the political upheavals in Ireland in 1919-1921, the British troops carried out numerous reprisal killings.<sup>54</sup> And we should also mention that the French active service order of 1924 instructs that, when occupying enemy territory, “prendre des otages”.<sup>55</sup>

In the Second World War, the practice of taking and killing hostages was continued by all parties involved. The fact that it occurred frequently on the German side may be partially explained by the great extent of the enemy territory occupied by fairly weak military forces, but also by the fanatical resistance of the population of these occupied regions, who paid no heed to the relevant regulations of the Hague Land Warfare Convention of 1907.

Since the attitude of the civilians towards the German soldiers was more positive in Italy than in the other European countries, few executions of hostages and reprisal prisoners took place there, apart from the special incident of the “Fosse Ardeatine” (March 24, 1944).

Between 1941 and 1944 executions were especially numerous in the Balkans, where partisan activities were particularly widespread. In this respect, the Chief of the Wehrmacht Supreme Command issued an order on September 16, 1941, which named the vengeance death of 50 to 100 Communists per German soldier as generally appropriate ratio.<sup>56</sup> On the basis of this order, an attack of bandits at Topola (resulting in 22 dead and 16 missing on the German side) was followed by the order to execute 2,200 prisoners; 449 were in fact executed.<sup>57</sup> There were also numerous other instances of hostage killing, but the ratio of 1:100 was never applied.

The war in Russia also led to reprisals. Paget,<sup>58</sup> for example, reports that 50 hostages were shot in Simferopol in the Crimea, after executions at a ratio of 1:100 had been threatened as vengeance against bomb explosions where Germans were killed.

<sup>48</sup> Hackworth, *op. cit.* (note 10), v. VI, p. 272. However, the American Department of States did not agree in this case.

<sup>49</sup> Evidence in Laternser, *op. cit.* (note 36), p. 192. Hoppe, *op. cit.* (note 14), p. 42, and v. Keller, *op. cit.* (note 32), p. 43, specifically mention the Belgian General Lemercier. – That the hostages were not killed was primarily due to the correct behavior of the Rhinelanders.

<sup>50</sup> Cf. Hoppe, *op. cit.* (note 14), p. 42.

<sup>51</sup> Cf. v. Keller, *op. cit.* (note 32), p. 43.

<sup>52</sup> *Ibid.*, pp. 44f.

<sup>53</sup> *Ibid.*, p. 54.

<sup>54</sup> Numerous references in Laternser, *op. cit.* (note 36), p. 74, Hoppe, *op. cit.* (note 14), p. 43, and others [cf. Winston Churchill, *The World in Crisis*, vol. 5: “The Aftermath”, T. Butterworth, London 1929, pp. 278ff.]

<sup>55</sup> Cf. v. Vanselow, *op. cit.* (note 27), p. 240, A. 162 and Hoppe, *op. cit.* (note 14), p. 44.

<sup>56</sup> Cf. the American verdict in the SouthEast Trial, *op. cit.* (note 10), Protocols, p. 10 345, and Schütze, *op. cit.* (note 10), p. 47. For the individual cases, cf. Laternser, *op. cit.* (note 36), p. 222-227.

<sup>57</sup> Cf. Laternser, *op. cit.* (note 36), p. 223, and the American verdict, Southeast Trial, *op. cit.* (note 10), Protocols. p. 10353.

<sup>58</sup> R.T. Paget, *Manstein, seine Feldzüge und sein Prozeß*, Limes, Wiesbaden 1952, p. 171f. Further cases are discussed in the American verdict for the Wehrmacht Supreme Command trial, *op. cit.* (note 23), pp. 10010 ff, 10051, and others.

In the Belgian trial of General von Falkenhausen, the conditions in *Belgium* and *northern France* were discussed in detail. In particular, an extensive collection of documents was presented, which Behling has supplemented with a chronological table of the executions.<sup>59</sup>

This was a case of numerous attacks by partisans. Reprisal executions followed in each case; the ratio of victims of the attacks to hostages executed varied from 1:5 to 1:25. Generally, 10 Belgians or French were shot per German killed.<sup>60</sup> The number depended on the circumstances of each particular case, for example on the severity of the attack.

In one case, after a German soldier was murdered in Haarlem, *Holland*, the execution of 100 prisoners was ordered; 10 were actually shot.<sup>61</sup>

There is no need to go into details here, since the German side always took pains to establish the permissibility of reprisals and reprisal killings. Examples from the *opposing sides*, on the other hand, are more impressive. The aforementioned collection of documents from the Falkenhausen Trial contains extensive materials on this topic.<sup>62</sup> We shall just mention the following example.

After the capture of Bengasi, Montgomery stated that he believed that numerous mines and traps had been set in the city. For every British soldier that was killed, he would have 10 Italians shot.<sup>63</sup> A November 30, 1944, radio message from the Allied headquarters in Paris stated:<sup>64</sup>

*“Regarding General Leclercq’s proclamation in Strassbourg, according to which 5 hostages were to be shot for every French soldier killed in ambush, Headquarters has ordered that Allied expedition troops operate in accordance with the Geneva Convention of 1929 and especially its Article 2, which states that reprisals against prisoners of war are prohibited.*

*Under martial law, however, taking hostages in order to ensure that the inhabitants of the occupied territory obey the orders of the military government is permitted by the laws of warfare. Such hostages may be tried in court, and even sentenced to death.*

*Therefore, under certain circumstances – especially in cases where civilians have violated the orders of the Geneva Convention – the threat expressed by General Leclercq may be enforced, but not against prisoners of war.”*

According to Falkenhausen Document 58a, 6 officers and 34 soldiers were executed at Annecy (Haute Savoie), and another 40 Germans at Habère, as reprisal for atrocities allegedly committed by a Russian battalion.

On April 24, 1945, in Reutlingen, Württemberg, four reprisal prisoners were shot by the French for the murder of a French soldier.<sup>65</sup> On April 28, 1945, the following announcement was made in Leutkirchen:<sup>66</sup>

*“[...] 4. If a German shoots at Frenchmen, or if any other incident whatsoever happens, 5 houses will be torched and 100 Germans executed.*

*[...] 6. I am responsible, on pain of my own death, to ensure that these orders are enforced [...] the Mayor [...].”*

<sup>59</sup> Cf. collection of documents pertaining to the Falkenhausen Trial before the 2<sup>nd</sup> French Chamber, on March 9, 1951, No. 1658 crimes de guerre, des notices de 1948, No de l’affaire: 48 against von Falkenhausen and others; also Behling, *Zeittafel und Materialien zur Frage der während des 2. Weltkrieges im Befehlsbereich Belgien-Nordfrankreich durchgeführten Exekutionen*, Brüssel 1950, Zeittafel.

<sup>60</sup> For details cf. Behling, *ibid.*, p. 15-104.

<sup>61</sup> Cf. Steinmetz, summation for G. B. Haase in the criminal trial before the Special Court in Groningen, p. 17.

<sup>62</sup> Document collection, *op. cit.* (note 59), Fa-Doc. 53-76.

<sup>63</sup> Falkenhausen-Dokument 55.

<sup>64</sup> Falkenhausen-Dokument 56 b.

<sup>65</sup> Falkenhausen-Dokument 57 b.

<sup>66</sup> Falkenhausen-Dokument 63 a.

In Markdorf, 4 German civilians were executed per 1 French soldier shot.<sup>67</sup>

In Saulgau it was proclaimed on April 27, 1945, that if a French soldier were killed or even only wounded, 20 hostages would be shot and the corresponding city district would be burned to the ground.<sup>68</sup>

The Berlin Ordinance of July 1, 1945,<sup>69</sup> stated, *inter alia*:

*“Anyone who commits an attack on a member of the occupation forces or on a bearer of official functions, or who commits arson for reasons of political enmity, seals not only his own fate but that of 50 former members of the Nazi Party as well. Their lives are forfeit together with that of the assassin or arsonist.”*

Falkenhausen Document 74 tells of the execution of 8-12 Germans for one officer killed during the American march-in in Treseburg.

Further threats of reprisal killings were proven in the SouthEast Trial in Nuremberg in Case VII;<sup>70</sup> examples include a ratio of 1:25 in Stuttgart, 1:10 in Birkenfeld, 1:30 in Markdorf, and an American threat of 1:200 in Harz. Hoppe<sup>71</sup> mentions further that the Americans took French officials hostage in 1941 in Syria; as well, the Russians took Persian officers hostage in 1949 in Azerbaijan. Further, the French took and killed hostages in Indochina.<sup>72</sup> Sonnenburg<sup>73</sup> reports that the French shot 80 prisoners of war in Fort Mont Lucon in 1944, as well as 20 hostages in Saigon in May 1951.

According to the publication *Der Heimkehrer*,<sup>74</sup> French officers and soldiers returning from Indochina stated that they could not understand what was happening at that time, 7½ years after the war, to the former members of the German occupation forces. They pointed out that incidents like Oradour take place in Indochina on a weekly basis, and must take place, in fact, for the sake of the protection of the French troops there.

*As we can see, hostages were taken by all sides in World War Two, and in many cases they were also killed as reprisal.*

### c) Fundamental Permissibility of Reprisals

From the way in which reprisals were used we can conclude that they were applied as a form of lawful justice. Therefore, for the time prior to Geneva Convention of August 12, 1949, and in the context of our previous findings (cf. p. 530), the permissibility of reprisals *per se* – disregarding for the moment the individual circumstances and prerequisites, and the legal consequences – may be considered to have been an international custom expressing a general practice acknowledged as lawful.

At times this common law has been disputed in the subject literature. However, the overwhelming number of examples from the first half of the 20<sup>th</sup> century proves the fundamental permissibility of reprisal measures during the Second World War. It was not until the Geneva Convention of August 12, 1949, that this state of affairs was changed, but of course only for the time following, not retroactively for the past.

---

<sup>67</sup> Falkenhausen-Dokument 65 a.

<sup>68</sup> Falkenhausen-Dokument No. 65 a.

<sup>69</sup> Falkenhausen-Dokument No. 71 a.

<sup>70</sup> Cf. Latenser, *op. cit.* (note 36), p. 193, and Schütze, *op. cit.* (note 10), p. 94.

<sup>71</sup> Hoppe, *op. cit.* (note 14), p. 43, as quoted in Hammer and Salvin, *Taking of hostages*, 1944, p. 32.

<sup>72</sup> *Deutsche Zeitung u. Wirtschaftszeitung*, 24.1.1951; *Frankfurter Allgemeine Zeitung*, 19.5.1951; both quoted in v. Hoppe, *op. cit.* (note 14), p. 43.

<sup>73</sup> K. Sonnenburg, *Die französischen Kriegsverbrecherprozesse*, Arbeitsgemeinschaft für Recht und Wirtschaft, Munich 1951, pp. 27f.

<sup>74</sup> Edition of October 1952.

The earlier international agreements do not oppose the development of common law regarding the use of reprisals. In particular, Article 50 of the Hague Land Warfare Convention dealt only with collective punishment, but not with reprisals and not with hostage-taking.<sup>75</sup>

We would point out that in Italy, both Article 8 of the Martial Law of July 8, 1938, and Article 176 of the *Codice Penale Militare di Guerra* acknowledge the permissibility of reprisals. Article 358d of the *American Rules of Land Warfare* of 1940<sup>76</sup> also permits reprisals, including the killing of reprisal prisoners.

In its Articles 452-464, the British *Manual of Military Law*<sup>32</sup> fundamentally permits reprisals. Only in its Article 461 does it forbid the killing of contractual hostages. This does not prohibit the killing of reprisal prisoners. And in the Kesselring trial, which dealt mostly with the permissibility of the execution of reprisal prisoners, the Judge Advocate General stated on May 3, 1947:<sup>77</sup>

“However, I have come to the conclusion that there is nothing which makes it absolutely clear that in no circumstance and especially in the circumstances which I think are agreed in this case – that no innocent person properly taken for the purpose of a reprisal cannot be executed.”

Thus, British law also permits the execution of reprisal prisoners.<sup>78</sup> In Germany there was no Martial Law and no special *Manual*; but the permissibility of reprisal killings has been much discussed in German and Swiss literature, and affirmed without exception.<sup>79</sup> The American verdict in the SouthEast Trial (Case VII) stressed<sup>80</sup> that many nations, including the USA, Great Britain, France and the Soviet Union, have acknowledged the lawfulness of the execution of hostages. Incidentally, other academic literature is also predominantly in favor of viewing reprisals, including reprisal killings, as permissible.<sup>81</sup> Only a minority has rejected them, and called them a war crime;<sup>82</sup> however,

<sup>75</sup> For details cf. i Schütze, *op. cit.* (note 10), pp. 54 and 80; cf. also note 2 regarding Art. 452 of the British *Manual*, and v. Keller, *op. cit.* (note 32), p. 37.

<sup>76</sup> Commented on by: Hackworth, *op. cit.* (note 10), v. VI, p. 181 s.

<sup>77</sup> Report by Laternser, *op. cit.* (note 36), p. 193, and Schütze, *op. cit.* (note 10), p. 85.

<sup>78</sup> This was already pointed out by J. M. Spaight, *War Rights on Land*, Macmillan, London 1911, p. 465, and S. Glueck, *War Criminals, Their Prosecution and Punishment*, A. A. Knopf, New York 1944, p. 55, both cited in Laternser, *op. cit.* (note 36), p. 193. Much harsher measures, which in fact violate international law, are urged by the English *Handbook of Modern Irregular Warfare*, Pamphlet No 1: The Principles of Irregular Warfare (Document Warlimont No. 10 in Case V before the American Military Tribunal in Nuremberg). This work states, among other things: “[...] 7. [...] best method of dealing with informers is their ruthless extermination as soon as discovered. Pin a note to the body saying why they were killed [...] 8. for the time being every soldier must be a potential gangster [...]: use the gangster methods [...] 9. close combat [...] you have to kill [...] a strangle hold from behind [...]”

<sup>79</sup> Eg. cf. Vanselow, *op. cit.* (note 27), p. 241; J. C. Bluntschli, *Das moderne Völkerrecht*, 3<sup>rd</sup> ed., Beck, Nördlingen 1878, p. 319; F. von Liszt, M. Fleischmann, *op. cit.* (note 31), p. 493; J. Kohler, *Grundlagen des Völkerrechts*, Enke, Stuttgart 1918, p. 218; A. Waltzog, *Recht der Landkriegsführung*, Vahlen, Berlin 1942, p. 83; Hoppe, *op. cit.* (note 14), p. 134; Schütze, *op. cit.* (note 10), pp. 56, 74, 79, with co-authors; also, Lummert, *op. cit.* (note 39), p. 63, and H.-H. Jeschek, *Die Verantwortlichkeit der Staatsorgane nach Völkerstrafrecht*, Bonn 1959, p. 335. On a tangent, Schneeberger, “Reziprozität als Maxime des Völkerrechts”, *Schweizerische Juristenzeitung*, 1948, pp. 201-208, here p. 207; instead of reprisals he acknowledges only “negative reciprocity”.

<sup>80</sup> SouthEast Trial, *op. cit.* (note 10), Protokolle, p. 10325ff.

<sup>81</sup> Cf. Glueck; Flore; Pfenninger; Rivier; Hammer and Salvin; Kuhn; E. C. Stowell, *International Law*, Holt, New York 1931; Jessup, Pilloud, all of them cited in Hoppe, *op. cit.* (note 14), pp. 69 and 93; verdict of the permanent court-martial of Brussels, 2<sup>nd</sup> French Chamber of March 9, 1951, (cf. note 59: Falkenhausen), pp. 28 f; verdict Lippert, *op. cit.* (note 14), pp. 36/37, and the American verdict in the SouthEast Trial, *op. cit.* (note 10), pp. 10325ff., where it is also pointed out that many nations, including the United States, Great Britain, France and the Soviet Union, have acknowledged the execution of hostages as being lawful; cf. also Sterling E. Edmunds, *The lawless law of nations*, J. Byrne, Washington, D.C., 1925; German trans.: *Das Völkerrecht, ein Pseudorecht*, de Gruyter, Berlin 1933, p. 331, printed as Falkenhausen-Dokument No. 1. Cf. also Fauchille, *op. cit.* (note 30), n. 1021; he adds his regrets about the cruelty involved.

<sup>82</sup> Cf. Roosevelt, Bernadotte, Westlake, Wheaton, Melen, all of them cited in Hoppe, *op. cit.* (note 14), pp. 95f., also

these minority voices have lost their weight by the fact that soldiers from their own nations have themselves applied reprisals as common law. Their rejective view can thus be accorded value only in the context of efforts to abolish this common law.<sup>83</sup>

#### d) Prerequisites for Reprisals

The acknowledgement of reprisal killing as common law has provided a basis for further analysis. From what has been said so far, we can also draw conclusions as to individual prerequisites as well as regarding the degree of the reprisals (to be discussed in Section e).

Where prerequisites are concerned, Exner's view<sup>84</sup> that there is nothing about this issue that is not disputed would seem to be accurate. However, there is much that can be eliminated from this dispute if we remember the difference between collective punishment and reprisals (cf. previous, p. 533). A reprisal does not in *any way* require *blame* or *guilt* on the part of the person affected. This is why, for example, the prosecutor in the Kesselring Trial falsely accused the defendant of having made use of innocent persons.<sup>85</sup> This is also why reprisals may be imposed on persons or groups of persons that were demonstrably innocent of the violation of international law that is to be avenged.<sup>86</sup>

From practical examples, from martial laws and from jurisprudence we can derive a number of other prerequisites.

1. Punishments may be imposed on the basis of actions of individual persons. Where reprisals are concerned, it is disputed whether the actions of any single individual can give grounds for a reprisal. For example, Strupp<sup>87</sup> requires that the action must emanate from the enemy state. According to Article 358c of the American *Rules of Land Warfare* of 1940, however, illegal acts justifying a reprisal can be committed by a government, its military commanders, or a community or group of its individuals. According to Article 453 of the British *Manual of Military Law*, they can be committed by a government, by its military commanders, by several persons, or by individuals. Consequently, the actions of any single individual can give rise to a reprisal.<sup>88</sup>
2. The action that gives rise to a reprisal must *violate international law*. Where partisan activities are concerned, the question is first of all whether the partisans, in accordance with Article 1 of the Hague Land Warfare Convention, wore an insignia clearly visible from a distance, and whether they bore their arms openly. Consequently, the partisan activity in the Balkans has been described as a violation of international law.<sup>89</sup> Similarly, the July 20, 1948, verdict of the Tribu-

---

Nuvolone, *La punizione dei crimini di guerra*, 1945, p. 139. – Oppenheim-Lauterpacht *op. cit.* (note 28), 7<sup>th</sup> ed., v. II, p. 592, declares the killing of hostages to be a “war crime”; he completely overlooks the fact that it was used by all warring parties; cf. also his error already discussed in the previous, note 41.

<sup>83</sup> Let us hope that the abolition of reprisals, as decided at the Geneva Convention of August 12, 1949, will be carried through and that the reprisals of recent years (cf. prev. pp. 20f.) will remain exceptions and will not re-establish the old common law.

<sup>84</sup> Exner, *IMT*, IX, p. 364.

<sup>85</sup> Cf. Latenser, *op. cit.* (note 36), p. 72.

<sup>86</sup> Eg. Schütze, *op. cit.* (note 10), p. 73, and Rolin, Oppenheim-Lauterpacht and Hyde, cited there. Cf. also Fauchille, *op. cit.* (note 30), n. 1019, as well as Westlake, quoted in Latenser, *op. cit.* (note 36), p. 73.

<sup>87</sup> Strupp, *op. cit.* (note 31), p. 350.

<sup>88</sup> On the other hand, the Oct. 25, 1952, verdict of the Italian *Tribunale Supremo Militare* in the Kappler case states (regarding B, 3): “*L'inosservanza che legittima la rappresaglia del nemico deve essere effetto di azione od omissione imputabile allo Stato, rispettivamente in contrasto con divieti o comandi del diritto internazionale.*” It disputes that these prerequisites were met in the case of the assassination in the Via Rasella on March 23, 1944, which was committed by partisans. With that, the Court is in opposition to the rules mentioned in the text, which must be regarded as expression of the international legal regulations that are in force.

<sup>89</sup> Cf. Schütze, *op. cit.* (note 10), p. 48, and the American verdict in the SouthEast Trial, *op. cit.* (note 10), p. 10314.

nale Territoriale di Roma had declared that the bombing attack perpetrated against the German police company in the Via Rasella in Rome on March 23, 1944, had been in violation of international law (verdict p. 42).

3. Further, the application of reprisals requires that an appropriate investigation has been conducted first. Article 358b of the American *Rules of Land Warfare* speaks of a “careful inquiry”.<sup>90</sup> However, the circumstances surrounding the incident must also be considered. In reprisals, a quick reply to the violation of international law is important. If, for example, all likely participants in a crime have been arrested and their guilt has been established, it is not necessary to wait and see if more evidence might turn up in the future.
4. Another prerequisite that has been mentioned is that a *public warning* shall precede the implementation of any reprisal.<sup>91</sup> This would mean that relevant proclamations warning of reprisals are issued, either during march-in, or after the first attack to stave off any repetition thereof. Such warnings would certainly be nice; but neither the American *Rules* nor the British *Manual* require them, and so we cannot consider them an absolute prerequisite.
5. Besides the prerequisites already discussed, there is also the decisively important factor of *military necessity*. In this context, Article 358b of the American *Rules* states that the reprisals must never be a means of mere vengeance, but an inevitable last resort in order to force an enemy to give up an unlawful practice. Thus, Fauchille<sup>92</sup> states that reprisals must be a matter of necessity. Like Vanselow, Sibert, Bluntschli and the verdict in the Falkenhausen Trial, Hyde states that military necessity is the only limit on reprisals.<sup>93</sup> Oppenheim adds:<sup>94</sup>

“Victory is necessary in order to vanquish the enemy, and this necessity justifies all the undescrivable horrors of war, the immense sacrifices of human life and health and the inevitable destruction of property and the devastation of land. Aside from the limits imposed on the warring parties by international law, all kinds and degrees of force can and at times must be applied in war in order to achieve that goal, in spite of the cruelty and the extremes of misery that war brings with it. War is a struggle for existence waged between nations, and no degree of individual suffering and hardship can be specially taken into account; the national existence and independence of the warring nations is a higher consideration than any individual welfare.”

We must particularly keep in mind that the Hague Land Warfare Convention, according to Section 6 of its Introduction, serves only as a *general guideline* for the warring parties in their relations with each other and the population, and applies only insofar as *military interests permit*. Far too little attention was paid to this restriction in the post-war trials. Many an excessively harsh verdict has been due to this omission. The Introduction makes it clear that military necessity plays an important role in the application of the Hague Land Warfare Convention and that the latter does not define formal conditions. Even at that early date the authors left room for natural

<sup>90</sup> Similarly, Art. 456 of the British *Manual*. Laternser, *op. cit.* (note 36), p. 76, speaks of an appropriate investigation. – The American verdict in the Wilhelmstraßen Trial, *op. cit.* (note 10), also demands (Protocols, p. 28078) that attempts should be made to isolate the guilty person/s and to try them before a court of law.

<sup>91</sup> Eg. Waltzog, *op. cit.* (note 79), p. 83; Laternser, *op. cit.* (note 36), p. 199; J. Hatschek, *Völkerrecht*, Deichert, Leipzig and Erlangen 1923, p. 405 regarding b; Fauchille, *op. cit.* (note 30), n. 1023, and the American verdict in the Southeast Trial, *op. cit.* (note 10), p. 10323. – Jackson, *IMT*, IX, p. 362, stated that a protest must precede reprisals.

<sup>92</sup> Fauchille, *op. cit.* (note 30), n. 1023. For further references to the prerequisite of military necessity, cf. Hoppe, *op. cit.* (note 14), pp. 71-74, e.g., Wright, Spaight and §22f of the American *Rules*. The American verdict in the trial of the Wehrmacht Supreme Command rejects this characteristic, *op. cit.* (note 23) (Protocols p. 9932).

<sup>93</sup> Hyde, *op. cit.* (note 11), v. III, p. 1843. Similarly, Vanselow, *op. cit.* (note 27), p. 241; Sibert, *op. cit.* (note 11), p. 564; verdict Falkenhausen, *op. cit.* (note 81), pp. 28f; Bluntschli, *op. cit.* (note 79), p. 319; Manassero, *I codici penali militari*, v. 1 + 2, 2<sup>nd</sup> ed., Milano 1951, II, p. 555.

<sup>94</sup> L.F.L. Oppenheim, *International Law*, 4<sup>th</sup> ed., Longman, London 1926, v. II, p. 123 [retranslated from German], quoted by: Laternser, *op. cit.* (note 36), p. 191.

developments; and the developments after 1907 must be considered (cf. previous, p. 532). But this can only be done if the factor of military necessity is given the attention it deserves. In the American verdict against the Japanese General Yamashita, military necessity was treated as decisive factor.<sup>95</sup>

6. The American verdict in Case VII (SouthEast Trial) demanded another prerequisite, namely a *link* between the place of the crime and that of the reprisal; the victims of the reprisal, it said, should come from the same area where the unlawful attack took place.<sup>96</sup> We have not found this prerequisite expressed anywhere else in the subject literature. Further, it is not justified. The required characteristic of military necessity for the reprisal action means that there must be an inquiry into whether the action and its scope was militarily necessary. In this way, even if there is no connection between the location of the crime and that of the reprisal, a retrospective observer may perceive the military necessity in, for example, the circumstance that a reprisal managed to restore peace to a previously unruly region.
7. In the aforementioned SouthEast Trial verdict, the American court identified a number of further prerequisites for a reprisal.<sup>97</sup> It stated that all sorts of rules ought to have been proclaimed before any hostages were executed. These rules include:
  1. Registration of the inhabitants,
  2. mandatory carrying of passports and ID cards,
  3. the establishment of prohibited zones,
  4. restriction of the people's freedom of movement,
  5. introduction of curfew hours,
  6. prohibition of assembly,
  7. detention of suspect persons,
  8. traffic restrictions,
  9. restrictions on food supply,
  10. evacuation of areas of unrest,
  11. imposition of mandatory financial contributions,
  12. forced labor to make up for the damage done by sabotage,
  13. the destruction of property at the location of the crime,
  14. as well as other measures that are not forbidden by international law and which are likely to produce the desired result.

This verdict is an isolated case. Nowhere else have we found demands such as these – concocted in a bureaucratic ivory tower, and quite impracticable. One does not need to have been in the Balkans to realize that such measures were not suited to preventing acts of sabotage. Only a small part of the measures listed could be applied in Central Europe or in the United States within the framework of military necessity.

### e) Enforcement of Reprisals

As we can see, reprisals could be ordered if there was a military necessity for them. Now let us examine how they were to be carried out.

1. The matter of who is *responsible* for ordering the reprisals is not entirely clear. An individual soldier may not take reprisal measures on his own initiative. Article 358b of the American *Rules*,

---

<sup>95</sup> Cf. A. F. Reel, *The case of General Yamashita*, Univ. of Chicago Press, Chicago 1949, p. 296, n. 13, in a similar vein Manassero, *op. cit.* (note 93), p. 555.

<sup>96</sup> SouthEast Trial, *op. cit.* (note 10), Protocols, p. 10354. Elsewhere this verdict speaks of a connection of geographic, racial or other nature.

<sup>97</sup> *Ibid.*, p. 10322.

for example, states that the highest available office should be consulted, unless military necessity demands immediate action. According to Article 455 of the British *Manual*, “*even though there are no international rules on the subject, reprisals should never be ordered by an individual soldier, but only ever by a commander.*” In the case of France, Fauchille<sup>98</sup> states that the orders for a reprisal should come from the commanding General, if possible. According to Article 10, Section 2 of the Italian Martial Law of July 8, 1938, reprisals... if immediate and exemplary action is necessary,... may be ordered by any other “*comandante*” as well. Such a “*comandante*” can be a soldier, for example,<sup>99</sup> who has an operating unit under his command;... it must be a unit which allows its commander the opportunity for initiative, even if limited.

In Germany, reprisals were to be ordered by a higher commander, generally a divisional commander.<sup>100</sup> As Laternser comments aptly, there was no applicable rule of martial law here, especially since lower-ranking commanders were also responsible in the English, American and Italian armed forces. Therefore, since reprisal law in particular is governed by the principle of reciprocity,<sup>101</sup> other commanders could also lawfully order reprisals during the Second World War, despite this purely German regulation. This is why Waltzog<sup>102</sup> says, correctly, that the regulation stating that only a divisional commander could give the order was binding only for as long as the opponent also observed such a restriction. But since Germany’s opponents in World War Two acted differently even in their formal regulations, German commanders of lower rank similar to English commanders or Italian *comandantes* were also entitled to order reprisals.

In conclusion we shall add that the American verdict in Case VII (SouthEast Trial) expresses the opinion that under international law a *judicial decision* is required prior to an execution.<sup>103</sup> This view is incorrect. Under continental law reprisals are never within the jurisdiction of a court. Courts are responsible only for punishment, not for the assessment of military necessities. The opinion expressed in the verdict proves that the court confused the concepts of reprisals and punishment.

2. Where the *extent of reprisals* is concerned, practice and legislation as well as the subject literature of international law are very unclear. The numerous examples of practical cases, of which we have mentioned a few (cf. Section b), range from a ratio of 1:1 to one of 1:200 (Americans in April 1945, in the Harz). Similarly, only a part of the authors contributing to the subject literature support the theoretical demand for a balance between the number of victims of an assassination and that of the victims of the resulting reprisal.<sup>104</sup> Schütze advocates proportionality, but declares the principle to be a flexible one and suggests that the extent of the reprisal is determined primarily by its purpose, which is to be an effective means of coercion.<sup>105</sup> Lo Cascio considers the limit of a reprisal to be an appropriately high quotient of damage sustained vs. inflicted.<sup>106</sup> On the oth-

<sup>98</sup> Fauchille, *op. cit.* (note 30), n. 1024.

<sup>99</sup> Cf. Sucato, *op. cit.* (note 28), v. II, pp. 507f.

<sup>100</sup> Cf. Waltzog, *op. cit.* (note 79), p. 84; Laternser, *op. cit.* (note 36), p. 200.

<sup>101</sup> Eg. cf. Schneeberger, *op. cit.* (note 79), pp. 201ff.

<sup>102</sup> Waltzog, *op. cit.* (note 79), p. 84.

<sup>103</sup> SouthEast Trial, *op. cit.* (note 10), Protocols p. 10327; opposing this (and rightly so) cf. Schütze, *op. cit.* (note 10), pp. 92f.; Hoppe, *op. cit.* (note 14), p. 75; Lummert, *op. cit.* (note 39), p. 61; Jeschek, *op. cit.* (note 79), p. 335.

<sup>104</sup> Eg. Guggenheim, *op. cit.* (note 11), v. II, p. 585; F. von Liszt, M. Fleischmann, *op. cit.* (note 31), p. 4397; Oppenheim-Lauterpacht, *op. cit.* (note 28), 6 th. ed., p. 115; the American verdicts in the SouthEast Trial, *op. cit.* (note 10), p. 10320, and in case IX (*op. cit.* (note 33), p. 6982); Art. 459 of the British *Manual*; Art. 358e of the American *Rules*; Law Reports, *op. cit.* (note 39), case 43 (Mackensen-Maeltzer), p. 5; Nuvolone, *op. cit.* (note 82), p. 137.

<sup>105</sup> Schütze, *op. cit.* (note 10), p. 65; similarly, Jeschek, *op. cit.* (note 79), p. 223.

<sup>106</sup> Lo Cascio, in *Archiv des Völkerrechts* (Tübingen), v. III., 1952, pp. 357-366, here p. 366.



er hand, Strupp, Hatschek, Fauchille, Hyde, Lummert and others reject the requirement of proportionality outright.<sup>107</sup>

Repeatedly we also see the matter of military necessity being considered in setting the extent of a reprisal. For example, von Keller<sup>108</sup> states aptly that the number of prisoners must be high enough that pressure is actually exerted on those responsible. Fauchille writes:<sup>109</sup>

*“Il faut donc qu’elles (les représailles) soient de nature à faire impression sur ceulx-là-mêmes dont dépend la cessation de cette conduite.”* (Therefore, the reprisals must be of a nature to make an impression on those on whom the cessation of this conduct depends.)

Thus, the extent of a reprisal ultimately becomes a matter of the military commander’s situational judgment.<sup>110</sup>

*In view of all this, we can sum up by saying that there was no set common law with respect to proportionality, much less with regard to a ratio of 1:1. And thus we must agree with Laternser,<sup>111</sup> that in the Italian case of the Fosse Ardeatine on March 24, 1944, given the particular circumstances in Rome (only 20 km behind the Nettuno front), the execution of 330 Italians ordered in reprisal for the death of 33 German policemen<sup>112</sup> did not exceed the degree warranted by military necessity.*

Another factor in determining the extent of a reprisal is the further damage it can prevent. For example, a reprisal may prevent a riot that would involve further loss of life on both sides. The balance, therefore, must be comprehensively qualitative, not schematic.<sup>113</sup>

3. Not only the number of victims, but also the *circumstances of the reprisal’s enforcement* are determined by military necessity. Just as the ordering of a reprisal killing must be the last resort, the manner of its implementation must also be limited. Since a reprisal, in its individual case, suspends a norm of international law, its implementation must be limited and must observe the principles of humaneness as far as possible.<sup>114</sup>

An important aspect of this is that a reprisal must be carried out *quickly* in order to be effective.<sup>115</sup> For this reason it is not generally possible to prepare for it in every detail. Rather, it is better to accept some disadvantages if the speed of implementation would suffer otherwise, and perhaps even necessitate harsher measures.

<sup>107</sup> Strupp, *op. cit.* (note 31), p. 351; Fauchille, *op. cit.* (note 30), n. 1024; Hatschek, *op. cit.* (note 91), p. 405; Hyde, *op. cit.* (note 11), v. III, p. 1843, n. 9; v. Waldkirch, *op. cit.* (note 29), p. 328; Vanselow, *op. cit.* (note 27), p. 85; v. Keller, *op. cit.* (note 32), p. 59; Hoppe, *op. cit.* (note 14), p. 89; Lummert, *op. cit.* (note 39), p. 60; Schneeberger, *op. cit.* (note 79), p. 207.

<sup>108</sup> v. Keller, *op. cit.* (note 32), p. 59.

<sup>109</sup> Fauchille, *op. cit.* (note 30), n.1024.

<sup>110</sup> Cf. also Lummert, *op. cit.* (note 39), p. 61.

<sup>111</sup> Laternser, *op. cit.* (note 36), pp. 76f.

<sup>112</sup> Since more policemen eventually died of their injuries, the number of casualties is even greater. Additionally there were about 60 officers severely injured, so that the bottom line is a ratio of about 1 : 3 to 1 : 4.

<sup>113</sup> Cf. R. Frank, *Strafgesetzbuch*, 18<sup>th</sup> ed., Mohr, Tübingen 1931, p. 153; Siegert, *Notstand und Putativnotstand*, Mohr, Tübingen 1931, p. 24; H. Henkel, *Der Notstand nach gegenwärtigem und künftigem Recht*, Beck, Munich 1932, pp. 43 ff.; Maurach, *Kritik der Notstandslehre*, Heymann, Berlin 1935, pp. 72 ff., esp. pp. 79ff. (reprint: Keip, Goldbach); E. Mezger, *Strafrecht, I. Allgemeiner Teil. Ein Studienbuch*, 4<sup>th</sup> ed., Beck, Munich 1952, §48; A. Schönke, *Strafgesetzbuch, Kommentar*, 6<sup>th</sup> ed., Beck, Munich 1952, p. 199; G. Bettioli, *Diritto penale, parte generale*, 2<sup>nd</sup> ed., Driulla, Palermo 1950, p. 251ss. The latter rightly calls for a “*bilanciamento qualitativo*” (p. 254).

<sup>114</sup> Accordingly, Section 9 of the Introduction to the Hague Land Warfare Convention after the “*lois de l’humanité et les exigences de la conscience publique*”; cf. Hoppe, *op. cit.* (note 14), p. 90.

<sup>115</sup> Jackson (*IMT*, IX, p. 362) says that a reprisal must be carried out within an appropriate period of time; also Hoppe, *op. cit.* (note 14), p. 117.

4. The *termination of reprisals* is also limited by military necessity. As soon as such necessity ends – specifically, as soon as the opponent gives in to the pressure exerted on him and ceases to act in violation of international law – the measures ordered as coercion must be ended.<sup>116</sup>  
[...]<sup>7</sup>

### III. Higher Orders

If the foregoing considerations regarding reprisal law and requisitions had been consistently applied in the trials of the post-war years, then under the principle of “*equality under the law*” a large part of our prisoners of war would already have to have been acquitted. In the remaining cases, where such measures must be assumed to have been a violation of international law, one must consider the additional factor of higher orders. We shall investigate this in the following.

#### a) General Principles

Superiors’ orders have always had special significance regarding the criminal liability of a subordinate obeying them. It would be impossible to command soldiers or police forces if the subordinates were authorized or perhaps even obliged to examine the lawfulness of an order before carrying it out. Alternatively, every military or police commando would have to be assigned its own legal adviser. For this reason, military law has everywhere and at all times depended on discipline, *i.e.*, on the *general principle that the subordinate must obey his superior’s orders if such orders are given within the limits of his jurisdiction*. Consequently, if the carrying-out of the order constitutes a violation of some law, criminal liability is on principle restricted to the superior who had given the order, and conversely the subordinate who had obeyed the order on principle remains exempt from liability. This is explicitly set out by §47 of the German Military Criminal Code, by Article 18 of the Swiss Military Criminal Code, by Article 40 Sections 2 and 3 of the Italian Codice Penale Militare di Pace, and by other regulations.<sup>117</sup> For example, §443 of the British *Manual of Military Law* of 1914 decreed that members of the armed forces who violated accepted rules of warfare on the orders of their commanding officers are not war criminals and therefore cannot be punished by the enemy.<sup>118</sup> Similarly, Article 347 of the American *Rules of Land Warfare* ruled out the punishment of subordinates obeying orders.

As a practical example we would mention the execution of the order issued to the British Admiral Sommerdille, to sink the French fleet at Oran in the summer of 1940; 1,500 French marines lost their lives in the process.<sup>119</sup> In France, Article 327 of the Code penal rules out liability for manslaughter or bodily harm if the actions in question were ordered by the law or by the lawful government.<sup>120</sup> – The other nations had similar regulations.

Thus, we find that even during the first years of World War Two the regulations in force in the various nations were quite similar to each other.

<sup>116</sup> Cf. Guggenheim, *op. cit.* (note 11), v. II, p. 586, and the British *Manual*, Art. 460.

<sup>117</sup> The view expressed here is also shared by Oppenheim, Manner and Kelsen, who are quoted in Laternser, *op. cit.* (note 36), pp. 116ff.

<sup>118</sup> Quoted according to Aschenauer, “*Richterliche Nachprüfungspflicht und Handeln auf Befehl*”, in *Die andere Seite*, Juni 1950, pp. 2-41, here p. 27. Another reference in E. Schwinge, “*Angehörige der ehemaligen deutschen Wehrmacht und der SS vor französischen Militärgerichten*”, *Monatsschrift für deutsches Recht*, 1949, pp. 650-654, here p. 650.

<sup>119</sup> Cf. Paget, *op. cit.* (note 58), p. 140, and Aschenauer, *op. cit.* (note 118), p. 30.

<sup>120</sup> Cf. Aschenauer, *op. cit.* (note 118), pp. 25f., with further references regarding disputed aspects of Art. 526 of the Justice Militaire of 1928, which regulates the punishment of insubordination; cf. also Henri D. de Vabres, *Précis de droit criminel*, 2<sup>nd</sup> ed., Paris 1951p. 72ff.

## b) Post-1944 Break With Traditional Principles

But after 1944 this tradition was overthrown. The first step was taken by the American scholar Glueck,<sup>121</sup> who suggested that since the application of the non-liability clause contained in the British and American regulations would in many cases prevent the conviction of war criminals, it was necessary to pass a new and realistic regulation.

Similarly, the English author Lauterpacht changed his views.<sup>122</sup> Consequently, the majority of the Allied nations adjusted their principles regarding actions based on orders.<sup>123</sup> This is how the American *Rules* (Article 347) and the British *Manual of Military Law* (§443) came to be revised, giving rise to special laws – such as Article 3 of the French Ordonnance of August 28, 1944,<sup>124</sup> the Danish bill of July 12, 1946, §5 of the Norwegian law governing the punishment of war criminals, §13 of the June 19, 1945, Decree of the Czech President, and the Belgian law of June 26, 1947.<sup>125</sup> The new and retroactive regulations of all these laws corresponded with the London Agreement of August 8, 1945, in introducing the criminal liability of the subordinate following orders, and reduced the circumstance of higher orders to no more than a mitigating factor whose precise extent would depend on the court.

These are the Special Laws under which the trials of the German, Italian and Japanese so-called war criminals were conducted. Because these laws were one-sided, they could not form a new international law. Italy in particular did not join in this creation of special laws, and retained its prior regulations.

## c) Post-1949 Restoration of the Original Principles

In those countries that had rescinded the tradition by which a commanding officer's orders exempted a subordinate from punishment, a return to the earlier principles was soon demanded. For example, in its verdict of June 29, 1951, against Lippert and others,<sup>126</sup> the Belgian court-martial in Lüttich rejected the criminal liability of the accused because these had acted under orders. The Brussels court-martial came to a similar decision on March 9, 1951, in its verdict against General von Falkenhausen.<sup>127</sup>

In the oath of allegiance demanded of its soldiers, the Russian armed forces exact a vow of unconditional obedience.<sup>128</sup> Further, the English Generals Montgomery and Robertson, the American General Clay and Admiral Blandy have stated clearly that a soldier must obey orders unquestioningly.<sup>129</sup> Thus, a French Captain who had acted on higher orders and had 10 foreign internees executed (in violation of international law) was acquitted; on the other hand, some Dutch soldiers were

---

<sup>121</sup> In: War Criminals, their Prosecution and Punishment, quoted by Aschenauer, *op. cit.* (note 118), p. 27.

<sup>122</sup> Cf. Oppenheim-Lauterpacht, *op. cit.* (note 28), 6<sup>th</sup> ed., v. II, pp. 452f.

<sup>123</sup> Cf. K. Heinze, K. Schilling, *op. cit.* (note 18), p. 131, N. 161; Smith, *op. cit.* (note 14), p. 47; Jeschek, *op. cit.* (note 79), pp. 260f.

<sup>124</sup> Cf. the expert report by Vabres, Henri D. de, *Rechtsgutachten*, June 25, 1949.

<sup>125</sup> All quoted in Aschenauer, *op. cit.* (note 118), p. 28.

<sup>126</sup> Lippert, *op. cit.* (note 14), Ref. No. 2251, p. 58.

<sup>127</sup> Verdict Falkenhausen, *op. cit.* (note 81), p. 29. Cf. also Smith, *op. cit.* (note 14), p. 47, and in *Free Europe* (vol. 13, No 162, 1946, July); Paget, *op. cit.* (note 58), p. 145; Hankey, in F. H. Maugham, *UNO and War Crimes*, Murray, London 1951, p. 111; Hyde, *op. cit.* (note 11), v. III, p. 1811; Kelsen and Morgan, both quoted in Lummert, *op. cit.* (note 39), pp. 33f.

<sup>128</sup> Cf. Aschenauer, *op. cit.* (note 118), p. 28; Jeschek, *op. cit.* (note 79), p. 270; R. Maurach, *Die*

*Kriegsverbrecherprozesse gegen Deutsche in der Sowjetunion*, Arbeitsgemeinschaft vom Roten Kreuz in Deutschland (British Zone), Hamburg 1950, p. 38.

<sup>129</sup> Quoted from Aschenauer, *op. cit.* (note 118), p. 30f.

convicted because they had refused to carry out an unlawful order to burn down an Indonesian village.<sup>130</sup>

According to a newspaper report,<sup>131</sup> J. E. Edmonds, one of the two authors of the British *Manual of Military Law*, stated that the 1944 revision of the *Manual* had been made without consulting or even notifying the author; the other author, Oppenheim, had already passed away at the time. Therefore, conversely, the information provided by Lord Hankey of the British House of Lords is not really surprising: namely, now that England has no so-called war criminals left to convict, the revision of 1944 has quietly disappeared from reprints of the *Manual of Military Law*, leaving only the old text of 1929, which does provide for the exemption of liability in the presence of higher orders.<sup>132</sup>

In light of these circumstances we cannot agree with the view expressed in the American verdict in the Nuremberg SouthEast Trial,<sup>133</sup> that the civilized nations had increasingly espoused the principle that higher orders could not be claimed as defense against criminal acts. This court's opinion has already failed due to the military necessities of post-war times. Its implementation would have undermined all military authority. And this is why the latest (7th, 1952) edition of the well-known *Manual* by Oppenheim-Lauterpacht contains the following section:<sup>134</sup>

*“Given a reference to higher orders for purposes of justifying a war crime, a court must unquestionably consider that obedience to any not blatantly illegal order is the duty of every member of the armed forces, and that under the conditions of war-time discipline one cannot expect a subordinate to carefully weigh the legal basis of the orders he receives. It must also be considered that the norms regarding the conduct of war are often controversial, and that an act intended to serve as reprisal, though it might at other times constitute a war crime, can be carried out in obedience to orders.”*

*These conditions in and of themselves already suffice to rid the disputed action [Kappler's and Priebke's involvement in reprisal shootings, E.G.] from the stigma of a war crime.*

As a result, the Nuremberg court's attempts to revise the general principles failed. Therefore, under international law, orders issued by a responsible superior on principle preclude criminal liability on the part of the subordinate obeying the orders; the superior giving the orders is criminally liable for their implementation.

This restoration of the previous legal position must also be considered with respect to those war crimes for which sentence has already been passed – and reflected in a pardon, if necessary.

#### d) Liability of the Recipient of an Order in Exceptional Cases

There are individual exceptions to the general principle discussed here. In the passage quoted above, Lauterpacht acknowledges the exemption from punishment if the order given is “*not blatantly illegal*”. In Article 40 Section 4 of the Italian Codice Penale militare di Pace an exception is introduced to the principle of the superior's sole liability, for the event that carrying out the order given does in fact obviously constitute a crime (costituisce manifestamente reato).<sup>135</sup> Article 18 Section 2 of the Swiss Military Criminal Code states that the subordinate is also criminally liable if he is aware that, by following the order, he contributes to a crime or misdemeanor. It is left to the judge's personal discretion to moderate or dispense with punishment. Therefore, the subordinate has no

<sup>130</sup> Cf. *ibid.*, p. 33.

<sup>131</sup> *Frankfurter Allgemeine Zeitung* of August 7, 1952.

<sup>132</sup> Cf. Th. W. van den Bosch, *Tijdschrift voor Strafrecht*, Deel LXI, p. 19.

<sup>133</sup> SouthEast Trial, *op. cit.* (note 10), Protocol, p. 10301.

<sup>134</sup> Oppenheim-Lauterpacht, *op. cit.* (note 28), v. II, 7<sup>th</sup> ed., p. 569.

<sup>135</sup> Also, verdict of the American military tribunal in Nuremberg, Case IV, Protocol, p. 8087, cited in K. Heinze, K. Schilling, *op. cit.* (note 18), p. 126, No. 618.

clear-cut duty to evaluate his orders.<sup>136</sup> According to §47 Section 1 of the German Military Criminal Code, the subordinate obeying the orders was punished as participant in a criminal act if:

1. he went beyond the orders given him;
2. he knew that his superior's orders pertained to an act whose aim was the commission of a general or military crime or misdemeanor.<sup>137</sup>

If the subordinate's share of the blame was minor, his punishment might be dispensed with.

### e) Significance of Führer Orders for a Subordinate's Exemption from Liability

During World War Two Germany as well as other countries saw trends towards the limitation of exceptions to the general principles, and towards the introduction of strict discipline with a concomitant, absolute exemption from liability and punishment for the subordinate obeying orders. Today it is apparent that these views were wrong. But we must take into consideration the circumstances prevailing in those days in the "Führer state". Since 1938 Hitler had been the Supreme Commander of the German Wehrmacht, and the highest Chief of the SS and the SD ever since their establishment. As a result, and in accordance with the organization of an authoritarian state, he was able to give direct orders to any office or position he chose. In this context, the American verdict at Nuremberg in Case XII (Wehrmacht Supreme Command Trial) stated:<sup>138</sup>

*"Hitler's personal decrees had the force of law."*

In Huber's book *Das Verfassungsrecht des Großdeutschen Reiches* this was expressed as follows:<sup>139</sup>

*"The Führer consolidates within his person all sovereign power of the Reich: all public power in the state as well as in the Movement is derived from his leadership power [...] He is the carrier of all political power [...] He is the highest carrier of all social functions [...]"*<sup>140</sup>

This means that he could also give binding orders in individual cases, and these orders had the force of law. This was expressly confirmed by the Reichstag in its well-known decision of April 26, 1942.<sup>141</sup> In other words, in deviation from the principle of the separation of powers, Hitler as head of state could give an individual order which required the same obedience as does a law in a democratic state.

*From today's perspective we must deny an authoritarian head of state's order its force of law if this order violates natural right.* In other words, when retrospectively assessing the legitimacy of an act from those days, we cannot content ourselves with the simple observation that it was done on the basis of an order from the highest chief of state. If such an order violated natural right, we cannot consider it legitimate, and carrying out such an order may be regarded as *unlawful*. But before we treat the carrying-out of the order as a *criminal offense*, we must in any case consider the application of the aforementioned (in d) §47, Sections 1 and 2 of the Military Criminal Code. Further, we must then also consider whether there may not also be other grounds for ruling out liability, either as typical or as individual case. Let us take a brief look at these issues in the following.

---

<sup>136</sup> Cf. F. H. Comtesse, *Das Schweizerische Militärstrafgesetzbuch*, Schulthess, Zürich 1946, p. 59.

<sup>137</sup> Similar comments were made in the American verdict at Nuremberg in Case IV, Protocol, p. 8087. For the inconsistent punishment of subordinates obeying orders, cf. Jeschek, *Zeitschr. f. d. ges. Strafrechtsw.* 65, 123.

<sup>138</sup> Quoted in Aschenauer, *op. cit.* (note 118), p. 25; cf. also Lummert, *op. cit.* (note 39), pp. 32 and 56.

<sup>139</sup> 2<sup>nd</sup> ed., Hanseatische Verlagsanstalt, Hamburg 1939, pp. 230 and 278, quoted in Aschenauer, *op. cit.* (note 118), p. 10.

<sup>140</sup> Similarly, Jahrreiss, *IMT*, XVII, p. 536.

<sup>141</sup> *Reichsgesetzblatt*, 1912, Teil I, p. 247

## IV. Errors and State of Emergency

### a) Errors

Our analysis of the reprisal issue has shown that jurists from the various countries are by no means in agreement on what is permitted and what is not. Therefore it is not surprising that military practice also varies in many respects. In view of the disagreement even between the subject experts, we cannot by any means expect soldiers to be clear on the issues of right and wrong as these pertain to reprisals and requisitions. Rather, in many cases where a court deems an act to be unlawful it is probably correct to assume that the accused believed that his actions were legitimate. In other words, many persons charged with war crimes believed their actions to have been permissible, *i.e.*, they were not aware that they were unlawful.

Even in Germany there is much controversy about how someone who is unaware of the *unlawfulness* of his actions should be treated under the law.<sup>142</sup> It is beyond the scope of the present study to discuss this controversy in detail; suffice it to say that British and American criminal law do not require an awareness of the illegality of one's actions.<sup>143</sup> In every case, however, it is important to determine whether the judicial system in question requires the affirmation of the guilt of an accused. Articles 5 and 47 of the Italian Criminal Code, for example, permit the consideration of a non-criminal error on the part of the accused. If an accused believes his actions to be permissible, for example on the basis of a misinterpretation of the Hague Land Warfare Convention, then he must not be punished for a deliberate offense. Under German law the element of intent would be inapplicable if, for example, someone charged with unlawful confiscations had erroneously believed that there was a pressing need for his actions, to serve the war effort.<sup>144</sup> These examples may indicate that the question of blame as pertaining to unlawful reprisals and requisitions must be of far greater significance than the post-war trials would in fact show.

### b) State of Emergency

The *state of emergency* is an aspect particularly important to the cases dating from the last war. We have already pointed out the tendency for commanding officers to demand unconditional obedience from their subordinates. This was accompanied by a considerable tightening of law and justice as it pertained to military disobedience and insubordination. Someone who sought to act on natural right and an accordingly lack of obligation to the orders of the state leadership (cf. p. 548), and thus disobeyed an order from a higher source, would have had to expect a severe backlash and harsh punishment. Especially in the last years of the war these dangers were by no means vague; they were very immediate indeed. Since not only the threats of punishment were draconic, but the sentences passed were also very severe, anyone who had dared insubordination would have put himself in immediate danger of his life. Thus, such cases always represented a state of emergency, as according to §54 of the German Criminal Code. A soldier could therefore not have been expected to act in keeping with natural right. Though he was obliged to stand up to dangers in battle, he could not have been expected to willingly run the risk of execution for insubordination.<sup>145</sup> Therefore his conduct would have been exempt from liability as per §54 of the German Criminal Code.<sup>146</sup>

<sup>142</sup> Eg. cf. Entscheidungen des Bundesgerichtshofs in Strafsachen, Band 2, pp. 194-212; Schönke, *op. cit.* (note 113), pp. 224ff.; Mezger, *op. cit.* (note 113), Postscript, pp. 1-7; Siegert, *op. cit.* (note 113), p. 73; and others.

<sup>143</sup> Cf. A. R. Tidow, *Der Schuldbegriff im englischen und nordamerikanischen Strafrecht*, Röhrscheid, Bonn 1952, pp. 111, 181.

<sup>144</sup> Cf. E. Schwinge, *Militärstrafgesetzbuch, Kommentar*, 5<sup>th</sup> ed., Junker & Dünnhaupt, Berlin 1943, p. 302; W. K. M. M. von Gleispach, *Das Kriegsstrafrecht*, Teil II, Kohlhammer, Berlin/Stuttgart 1940, p. 13.

<sup>145</sup> Also, Lummert, *op. cit.* (note 39), pp. 55, 57f. – The International Military Tribunal in Nuremberg (*IMT*, XXII, p. 530)

## V. Summary

We have seen how a wide range of legal aspects bear upon an area of exceedingly practical significance and how international and national law, conventions and common law must all be considered in order to arrive at a just solution. In some respects, wartime saw a kind of intellectual confusion that did not allow for equal and balanced justice for all. The post-war years, and with them an increasing distance from the events of the war, provided the basis for a morally unexceptionable order. Reprisals were prohibited at the Convention of August 12, 1949, the theory and practice of requisitions have been reconciled, and the issue of higher orders has seen a return to principles that agree with criminal law *per se*. On the other hand, matters must also be put right for the past. First and foremost it is necessary to subject the cases of our prisoners of war still detained today by our erstwhile enemies to a review guided by the reformed legal perspectives. The way in which these cases are dealt with shows whether the path is now clear for equal justice for all, and thus for a new European peacetime order.

\* \* \*

## Concluding Remarks by Gernar Rudolf

German newspapers rarely carry articles about reprisals threatened or implemented by the western Allies at or after the end of the war. However, the *Stuttgarter Zeitung*, for example, reported that the French had threatened reprisal executions at a ratio of 1:25 even in the event that shots would be taken at their soldiers at all, regardless of the actual outcome.<sup>147</sup> On April 4, 1992, the *Paderborner Zeitung* reported an incident where the Americans had taken harsh revenge for the death of their General Maurice Rose, who had been shot in regular combat: 110 German men not involved in the event were killed.<sup>148</sup> Probably there are a great many more such examples, where harsh reprisals or unlawful acts of revenge were inflicted on the German population. We know very little today about conditions prevailing from 1945 to 1947, especially in West Germany, since these actions on the part of the victors were never prosecuted. The Germans were forbidden to prosecute because of a law that is still in effect today, and the victors, naturally enough, had no particular interest in such prosecution.<sup>149</sup> The fact that East and Central Germany saw some dreadful excesses is somewhat more fully documented, on the other hand, since this was in the interests of the anti-Communist western powers.

In light of the facts as established by Professor Siegert, reprisals and the execution of hostages will be considered to be tactically questionable and perhaps morally reprehensible, but strictly speaking these acts were not unlawful at the time they took place. This also should be ever kept in mind when the topic at issue is the reactions of German troops in Russia and Serbia, *i.e.*, in vast re-

---

considered whether a choice in accordance with moral law was actually possible; similarly, the verdict of the American military tribunal of Nuremberg in Case VI, Protocol pp. 16172f., quoted in K. Heinze, K. Schilling, *op. cit.* (note 18), p. 113, No. 554.

<sup>146</sup> Cf. Siegert, *op. cit.* (note 113), pp. 44ff., and others. Regarding Italy we refer to Art. 54 of the Codice penale, and to Bettiol, *op. cit.* (note 113), p. 334. – The state of emergency was also examined by the American courts in cases V, VI, IX through XII; cf. K. Heinze, K. Schilling, *op. cit.* (note 18), pp. 111-117.

<sup>147</sup> hoh, “*Die Franzosenzeit hat begonnen*”, *Stuttgarter Zeitung*, 25.4.1995

<sup>148</sup> Cf. Heinrich Wendig, *Richtigstellungen zur Zeitgeschichte*, issue 8, Grabert, Tübingen 1995, p. 46. In fact, this has not been a reprisal, but merely a mass murder; cf. also *ibid.*, issue 2 (1991), pp. 47ff.; issue 3 (1992), pp. 39ff.; issue 10 (1997), pp. 44f.

<sup>149</sup> One exception is a recently publicized case of the unwarranted murder of 48 German soldiers who had already surrendered: Michael Sylverster Kozial, “*US-Kripo ermittelt nach 51 Jahren*”, *Heilbronner Stimme*, September 24, 1996; “*Später Fahndung nach Mördern in US-Uniform*”, *Stuttgarter Zeitung*, September 27, 1996, p. 7.

gions where a weak occupation power had to battle brutal partisans in order to facilitate the oft-disrupted flow of supplies to the eastern front. Partisan attacks began immediately following the start of the eastern war; certain partisan units deliberately let themselves be overrun, in order then to engage in sabotage behind the advancing German troops and to commit horrific atrocities against soldiers and civilians they caught unaware. Later on, partisan units as large as entire divisions were flown into the hinterland of the German troops, or smuggled in through the lines.<sup>150</sup>

Naturally, the data to be found in the subject literature about the numbers of partisans and the damage they caused vary widely, since there are few reliable documents about this kind of unlawful warfare and since the Soviet Union also always had a strong propagandistic interest in the historiography of partisan warfare. The most reliable data seems to be that provided by Bernd Bonwetsch,<sup>151</sup> who gives the numbers of partisans as follows: late 1941: 90,000; early 1942: 80,000; mid-1942: 150,000; spring 1943: 280,000; by 1944, skyrocketing to approximately half a million. These figures are based both on Soviet and on contemporaneous Reich-German sources. The damage done by the partisans, especially in the area of Byelorussia, is considerably more difficult to quantify. Wilenchik tells of impressive quantities of weapons and ammunition that were allegedly at the partisans' disposal, as well as of extensive crippling of the German supply lines through paralysis of railway lines, especially in 1944.<sup>152</sup> In general terms, this is confirmed by Werner.<sup>153</sup>

Regarding the numbers of German soldiers and civilians killed by partisans, Bonwetsch contrasts the claims from Soviet sources – up to 1.5 million – with those from the German side: 35,000 to 45,000,<sup>154</sup> which he considers to be more reliable, since allegedly the German sources would have had no reason to minimize the figures. However, he overlooks the fact that it is generally customary in war to downplay one's own losses. Seidler<sup>155</sup> recently published a balanced up-to-date study about the Wehrmacht's struggle in the partisan warfare, showing not only the disastrous and probably decisive effects of the partisan's attacks against German units and especially their supplies, but he proves also that most of the German reactions were totally covered by international law – although not always most far-sighted. Furthermore, he shows that those orders from higher up which broke international laws (e.g., the infamous “*Kommissar order*”, which might be considered morally appropriate, but politically stupid and judicially untenable) were in most cases sabotaged by the front units, and that these orders, after long-lasting and massive protest, were eventually revoked.

In a book critically discussed by the renowned German historians Andreas Hillgruber and Hans-Adolf Jacobsen, Boris Semionovich Telpuchowsky writes:

*“Within three years of the war, the Byelorussian partisans eliminated approximately 500,000 German soldiers and officers, 47 Generals, blew up 17,000 enemy military transports and 32 armored trains, destroyed 300,000 railway tracks, 16,804 vehicles and a great number of other material supplies of all kinds.”*<sup>156</sup>

<sup>150</sup> Relevant orders were issued by Stalin and were broadcast via all Soviet Russian stations; cf. *Keesing's Archiv der Gegenwart*, 1941, July 3rd + 21st 1941; cf. *Sowjetski Partisani*, Moscow 1961, p. 326.

<sup>151</sup> Bernd Bonwetsch, “*Sowjetische Partisanen 1941-1944*”, in Gerhard Schulz (ed.), *Partisanen und Volkskrieg*, Vandenhoeck & Ruprecht, Göttingen 1985, pp. 99, 101.

<sup>152</sup> Witalij Wilenchik, “*Die Partisanenbewegung in Weißrußland*”, in Hans Joachim Torke (ed.), *Forschungen zur osteuropäischen Geschichte*, v. 34, Harrassowitz, Wiesbaden 1984, pp. 280f., 285, 288f. This chapter has a certain anti-Fascist undertone.

<sup>153</sup> S. Werner, *Die 2. babylonische Gefangenschaft*, originally self-published by author, Pfullingen 1990; 2<sup>nd</sup> ed. Grabert, Tübingen 1991, pp. 88-93 (online: [vho.org/D/d2bg/I\\_II.html](http://vho.org/D/d2bg/I_II.html)); English online only ([vho.org/GB/Books/tsbc](http://vho.org/GB/Books/tsbc)).

<sup>154</sup> B. Bonwetsch, op.cit. (note 151), pp. 111f.

<sup>155</sup> Franz. W. Seidler, *Die Wehrmacht im Partisanenkrieg*, Pour le Mérite, Selent 1998; cf. Hans Poeppel (ed.), *Die Soldaten der Wehrmacht*, 3<sup>rd</sup> ed., Herbig, Munich 1999.

<sup>156</sup> B.S. Telpuchowski, *Die Geschichte des Grossen Vaterländischen Krieges 1941-1945*, Bernard & Graefe Verlag für Wehrwesen, Frankfurt/Main 1961, p. 284; comparable Seidler, op. cit. (note 155), p. 36f.; similar data may also be



The data also diverge greatly regarding the personnel (and concomitant costs) involved in the Germans' efforts to maintain security behind the frontlines: 300,000 to 600,000 persons were needed according to Soviet sources, vs. roughly 190,000 according to German sources.<sup>154</sup>

To what degree these data were inflated in order to glorify the partisans is not known, but there is no doubt that the policy of *scorched earth*<sup>157</sup> practiced by the Red Army in their retreat in 1941-42, together with the acts of sabotage and murder by the partisans, were the major contributing factors in the defeat of the German army in the East. The brutality with which the Red Army and especially the partisans fought, right from the start of the war and on orders from the highest echelons, was described vividly by J. Hoffmann,<sup>158</sup> for example, and again recently by A.E. Epifanow<sup>159</sup> and Franz W. Seidler<sup>160</sup>; A.M. de Zayas, in his study of the Wehrmacht War Crimes Bureau, also confirmed and corroborated much of the material which the Reich government had already collected even in those days to document the atrocities committed by not only the Red Army.<sup>161</sup> De Zayas also reports that the German wartime leaders did not resort to reprisals as a standard matter of course, but rather for the most part after carefully weighing the pros and cons. Especially in Russia, however, this could not prevent the fact that lower-ranking units, acting on the basis of their own experiences with the Soviet manner of warfare, engaged in reprisals (and revenge) not ordered or approved by higher ranks.<sup>162</sup>

As we know today, the German Wehrmacht deployed in the East fought not only for the survival of the Third Reich, but after they abandoned all illusions of imperialism, they also fought for the freedom of all of Europe from Stalinism,<sup>163</sup> and therefore, in light of Prof. Siegert's findings, we must observe that there was nothing unlawful and very little immoral about the merciless battle of the German security forces against unlawful Soviet partisans, even if that battle did involve draconic reprisals. If the official Soviet information about the numbers of German soldiers and/or their allies killed by partisans should be accurate, then it must be noted that reprisal killings of several millions of people (ratio 1:10) would have been *theoretically* justified. But even the numbers given by German authorities (some 40,000 victims) could have resulted theoretically in reprisal killings of

---

found in Heinz Kühnreich, *Der Partisanenkrieg in Europa 1939-1945*, Dietz, Berlin (East) 1965; for further interesting information, see I.I. Minz, I.M. Rasgon, A.L. Sidorow, *Der Große Vaterländische Krieg der Sowjetunion*, SWA Verlag, Berlin 1947; it is said that the Washington National Archive's document copies regarding partisan warfare in the former Soviet Union have recently been made unavailable to the public. This information and the preceding references are courtesy of Fritz Becker; cf. also Becker, "Stalins völkerrechtswidriger Partisanenkrieg", *Huttenbriefe* 15(4) (1997), pp. 3-6 (online: [vho.org/D/Hutten/Becker15\\_4.html](http://vho.org/D/Hutten/Becker15_4.html)).

<sup>157</sup> Cf. Walter N. Sanning, "Soviet Scorched-Earth Warfare", in *The Journal of Historical Review*, vol. 6/No. 1, Spring 1985, pp. 92-116 (online (German): [vho.org/D/DGG/Niederreiter29\\_1.html](http://vho.org/D/DGG/Niederreiter29_1.html)).

<sup>158</sup> J. Hoffmann, *Stalin's War of Extermination 1941 - 1945*, Theses & Dissertations Press, Capshaw, AL, 2001, pp. 305-327.

<sup>159</sup> A.E. Epifanow, H. Mayer, *Die Tragödie der deutschen Kriegsgefangenen in Stalingrad von 1942 bis 1956 nach russischen Archivunterlagen*, Biblio, Osnabrück 1996.

<sup>160</sup> Franz W. Seidler, *Verbrechen an der Wehrmacht*, Pour le Mérite, Selent 1998, pp. 5f. (online: [vho.org/D/vadw/vadw.html](http://vho.org/D/vadw/vadw.html)); English in preparation.

<sup>161</sup> A. de Zayas, *Die Wehrmachtsuntersuchungsstelle*, 4<sup>th</sup> ed., Ullstein, Berlin 1984, passim., esp. pp. 273-307.

<sup>162</sup> *Ibid.*, pp. 198-23.

<sup>163</sup> Cf. J. Hoffmann, "Die Sowjetunion bis zum Vorabend des deutschen Angriffs", in Horst Boog *et al.*, *Das Deutsche Reich und der Zweite Weltkrieg*, vol. 4: *Der Angriff auf die Sowjetunion*, 2<sup>nd</sup> ed., Deutsche Verlags-Anstalt, Stuttgart 1987; Hoffmann, "Die Angriffsvorbereitungen der Sowjetunion", in B. Wegner (ed.), *Zwei Wege nach Moskau*, Piper, Munich 1991; V. Suvorov, *Icebreaker: Who Started the Second World War?*, Hamish Hamilton, London 1990; Suvorov, *Der Tag M*, Klett-Cotta, Stuttgart 1995; E. Topitsch, *Stalin's War: A Radical New Theory of the Origins of the Second World War*, Fourth Estate, London 1987; cf. W. Post, *Unternehmen Barbarossa*, Mittler, Hamburg 1995; F. Becker, *Stalins Blutspur durch Europa*, Arndt Verlag, Kiel 1996; Becker, *Im Kampf um Europa*, 2<sup>nd</sup> ed., Leopold Stocker Verlag, Graz/Stuttgart 1993; W. Maser, *Der Wortbruch. Hitler, Stalin und der Zweite Weltkrieg*, Olzog Verlag, Munich 1994.

about 400,000 civilians. It goes without saying that such numbers are horrific, and we can just be thankful that reprisal killings are forbidden nowadays and hope that the law will be observed. We must, however, ask whether such killings actually took place in those days.

The so-called *Einsatzgruppen of the Security Police and the SD (Security Service)* were among others the units in charge of combating the partisans.<sup>164</sup> They started with not more than 4,000 men in summer 1941, but at the end of 1942 up to 15,000 Germans and 240,000 natives were involved,<sup>165</sup> an increase of manpower which indicates very well the parallel increase of partisan warfare at that time. Considering their relatively unsuccessful efforts at curbing partisan activity, we must note that these initially numerically weak troops were obviously entirely overwhelmed by their task of policing the enormous region (many hundred thousands of square kilometers), which they were in charge of and whose more remote areas were increasingly under the control of partisans.<sup>166</sup> Thus it appears a bit ridiculous when H. Höhne states:<sup>167</sup>

“Heydrich’s Death envoys started their cruel adventure: 3,000 men were hunting Russia’s five million Jews.”

Höhne omits to say that at the same time these troops were fighting against some 100,000 partisans. The allegations made against these troops today – namely, that, aside from their hopeless battle against the partisans, they also cooperated with many Wehrmacht soldiers to kill several million Jews as part of the Final Solution – beg the comment that, as Gerald Reitlinger says, this is absolutely unbelievable;<sup>168</sup> further, we would agree with Hans-Heinrich Wilhelm that the figures given in the various documents are probably entirely unreliable.<sup>169</sup> This holds true for at least as long as no serious efforts are made to locate the mass graves of the alleged victims, and as long as the criticisms presented in this volume regarding the cases of Babi Yar,<sup>170</sup> Marijampol<sup>171</sup> and the gas vans<sup>172</sup> are not accorded any serious discussion.<sup>173</sup>

Aside from all this, I consider it possible and even likely that German units in the hinterland shot countless civilians in the course of the so-called “gang battles”, and primarily in the form of reprisal

<sup>164</sup> For more details about this combat cf. F. W. Seidler, *op. cit.* (note 155), pp. 69-132.

<sup>165</sup> Cf. H. Höhne, *Der Orden unter dem Totenkopf*, Bertelsmann, Munich 1976, pp. 328, 339; cf. H. Krausnick, H.-H. Wilhelm, *Die Truppe des Weltanschauungskrieges. Die Einsatzgruppen der Sicherheitspolizei und des SD 1938-1942*, Deutsche Verlags-Anstalt, Stuttgart 1981, p. 147, cf. p. 287; Richard Pemsel, *Hitler – Revolutionär, Staatsmann, Verbrecher?*, Grabert, Tübingen 1986, pp. 403-407.

<sup>166</sup> For more information about the partisan warfare cf., e.g., Erich Hesse, *Der sowjetrussische Partisanenkrieg 1941-1944 im Spiegel deutscher Kampfanweisungen und Befehle*, 2<sup>nd</sup> ed., Muster-Schmidt, Göttingen 1992; John A. Armstrong (ed.), *Soviet Partisans in World War II*, Univ. of Wisc. Press, Madison, Wisc., 1964; Tomas Nigel, *Partisan Warfare 1941-1945*, Osprey, London 1983.

<sup>167</sup> H. Höhne, *op. cit.* (note 165), p. 330.

<sup>168</sup> G. Reitlinger, *Die SS, Tragödie einer deutschen Epoche*, Desch, Munich 1957, p. 186; similar Efraim Zuroff, *Beruf: Nazijäger. Die Suche mit dem langen Atem: Die Jagd nach den Tätern des Völkermordes*, Ahriman, Freiburg 1996, p. 44, where he says that 3,000 men, “mobil killing units, whose task was to kill all Jews and communist officials in the area occupied by the Wehrmacht.” This included the huge area “from the suburbs of Leningrad in the north to the Asov sea in the south.[...] Their weapons were conventional firearms. Nevertheless they succeeded in killing 900,000 Jews in 15 months.” Zuroff wonders, but he has no doubts. This has been possible, according to Zuroff, because of the “fanatic support by the native population.” (p. 47) That there has been a massiv partisan warfare in the back of the fighting German army is either unknown to Zuroff or he is not interested in it.

<sup>169</sup> Cf. introductory comments by G. Rudolf, note 143, p. 44.

<sup>170</sup> Cf. the chapters by John C. Ball and Herbert Tiedemann in the present volume.

<sup>171</sup> Cf. introductory comments by G. Rudolf, note 145, page 45.

<sup>172</sup> Cf. the chapter by Ingrid Weckert in the present volume.

<sup>173</sup> Regarding the activities of the Einsatzgruppen as troops to combat partisans or to murder the Jews (depending on which view one takes), Udo Walendy has written three critical studies well worth reading: *Historische Tatsache* Nr. 16 & 17, “Einsatzgruppen im Verband des Heeres”, parts 1 & 2; *Historische Tatsache* Nr. 51, “Babi Jar – die Schlucht mit 33.771 ermordeten Juden?”; Verlag für Volkstum und Zeitgeschichtsforschung, Vlotho 1983, 1983, and 1992.

killings.<sup>174</sup> Obviously, in selecting the victims of such reprisals, one would not choose Ukrainians, Byelorussians or members of the Balkan, Baltic or Caucasian peoples, of whom considerable numbers fought in German units. The fact that the Jews were predominantly unpopular amongst these peoples was mainly due to fairly recent causes. In the previous decades many people had had terrible experiences with Communist commissars, disproportionately many of whom were of Jewish descent, especially in the first few decades of Soviet Bolshevism.<sup>175</sup> The Russian Jewess Sonja Margolina has made some interesting points regarding the involvement of the Russian Jews in the Bolshevik reign of terror:<sup>176</sup>

*“Nevertheless: the horrors of revolution and civil war, just like those of the repressions later, are closely tied to the image of the Jewish commissar.”* (p. 47)

*“The Jewish presence in the instruments of power was so impressive that even such an unbiased contemporaneous researcher as Boris Paramonov, a Russian cultural historian living in New York, asked whether the promotion of the Jews into leadership positions may perhaps have been a ‘gigantic provocation’.”* (p. 48)

Margolina has written a particularly detailed analysis of a book which appeared in 1924 under the title *Rußland und die Juden*. This book examines the causes of the Russian Jews’ conspicuously above-average participation in the excesses of the October Revolution and the dictatorship that followed it, and analyzed the consequences of this involvement. In their appeal *“To the Jews in all nations!”* the authors of this book discussed by Margolina wrote:

*“The Jewish Bolsheviki’s overeager participation in the subjugation and destruction of Russia is a sin that already bears within itself the seeds of its retribution. For what greater misfortune could happen to a people than to have its own sons engage in excesses. Not only will this be counted against us as an element of our guilt, it will also be held up to us as reproach for an expression of our power, for a striving for Jewish hegemony. Soviet power is equated with Jewish power, and the grim hatred of the Bolsheviki will transform into a hatred of the Jews [...] All nations and peoples will be swamped by waves of Judeophobia. Never before have such thunderclouds gathered above the heads of the Jewish people. This is the bottom line of the Russian upheaval for us, for the Jewish people.”* (p. 58)

Margolina quotes further from this anthology:

*“The Russians have never before seen a Jew in power, neither as governor nor as policeman, nor as postal official. There were both good and bad times in those days too, but the Russian people lived and worked and the fruits of their labors were their own. The Russian name was mighty and threatening. Today the Jews are at every corner and in all levels of power. The Russians see them at the head of the Czarist city, Moscow, and at the head of the metropolis on the River Neva and at the head of the Red Army, the ultimate mechanism of self-destruction. [...] The Russians are now faced with a Jew as judge as well as executioner; they encounter Jews at every step, not Communists who are just as poor as they themselves but who nevertheless give orders and take care of the interests of the Soviet power [...] It is not surprising that the Russians, in comparing the past to the present, conclude that the present power is Jewish, and so bestial precisely because of that.”* (p. 60)

In the early 1990s, Professor Dr. Ernst Nolte also pointed out the Jews’ intimate entanglement in Communism, though naturally he rejects equating the Jews with Bolshevism. Nolte writes:<sup>177</sup>

---

<sup>174</sup> For the time between Jan. 1, 1943, and Oct. 31, 1944 (22 months), the German authorities have claimed 145,364 personens killed in the partisan warfare, 88,493 imprisoned, and 90,993 civilians “registered”, i.e., either sent into camps or otherwise punished; cf. F. W. Seidler, *op. cit.* (note 156).

<sup>175</sup> Germar Rudolf, Sibylle Schröder “Partisanenkrieg und Repressaltötungen”, *Vierteljahreshefte für freie Geschichtsforschung*, 3(2) (1999), pp. 145-153, have discussed this recently.

<sup>176</sup> S. Margolina, *Das Ende der Lügen*, Siedler, Berlin 1992.

<sup>177</sup> E. Nolte, “Abschließende Reflexionen über den sogenannten Historikerstreit”, in U. Backes, E. Jesse, R. Zitelmann (eds.), *Die Schatten der Vergangenheit*, Propyläen, Berlin 1992, pp. 83-109, here pp. 92f.

“For readily apparent social reasons, was not the percentage of persons of Jewish extraction particularly great among the participants in the Russian Revolution, different from the percentages of other minorities such as the Latvians? Even at the start of this century Jewish philosophers were still pointing with great pride to this extensive participation of the Jews in Socialist movements. After 1917, when the anti-Bolshevist movement – or propaganda – stressed the topic of the Jewish People’s commissars above all others, this pride was no longer expressed, [...] But it took Auschwitz to turn this topic into a taboo for several decades.

It is all the more remarkable that in 1988 the publication *Commentary*, the voice of right-wing Jews in America, published an article by Jerry Z. Muller who recalls these indisputable facts – though of course they are open to interpretation:

‘If Jews were highly visible in the revolution in Russia and Germany, in Hungary they seemed omnipresent. [...] Of the government’s 49 commissars, 31 were of Jewish origin [...] Rakosi later joked that Garbai (a gentile) was chosen for his post ‘so that there would be someone who could sign the death sentences on Saturdays’. [...] But the conspicuous role of Jews in the revolution of 1917-19 gave anti-Semitism (which ‘seemed on the wane by 1914’) a whole new impetus. [...] Historians who have focussed on the utopian ideals espoused by revolutionary Jews have diverted attention from the fact that these Communists of Jewish origin, no less than their non-Jewish counterparts, were led by their ideals to take part in heinous crimes – against Jews and non-Jews alike.’”

Referring to the causal nexus Nolte had postulated between GULag and Auschwitz, Muller concludes:

“The Trotskies make the revolutions [i.e., the GULag] and the Bronsteins pay the bills [in the Holocaust].”<sup>178</sup>

Thus it seems understandable that National Socialism, and the eastern peoples fighting alongside for their freedom, equated the Jews in general with the Bolshevist terror and the activities of the commissars – though such an identification, being sweeping and collective, was unjust. Nevertheless, it is therefore more than plausible that it was Jews, first and foremost, who were made to pay for the partisan warfare and other war crimes of the Soviets. Anyone who (rightly) criticizes this, however, should also not omit to consider where the blame for this kind of escalation of the war in the East was to be found. And clearly it was to be found with Stalin who, as an aside, had treated the Jews in his sphere of influence at least as mercilessly ever since the war had begun, as Hitler had.<sup>179</sup>

Germar Rudolf

<sup>178</sup> J.Z. Muller, “Communism, Anti-Semitism and the Jews”, in *Commentary*, issue 8, 1988, pp. 28-39; for a more ideological approach to National Socialist anti-Semitism cf. Erich Bischoff, *Das Buch vom Schulchan aruch*, Hammer Verlag, Leipzig 1929; on this expert opinion one of the best known National Socialist anti-Semites, Theodor Fritsch, relied heavily: T. Fritsch, *Handbuch zur Judenfrage*, 31<sup>st</sup> ed., Hammer-Verlag, Leipzig 1932; a comparison to modern Jewish critics of Judaism is extremely revealing, cf. Israel Shahak, *Jewish History, Jewish Religion*, Pluto Press, London 1994 (online: [codoh.com/zionweb/zishahak/zishahakan01.html](http://codoh.com/zionweb/zishahak/zishahakan01.html)).

<sup>179</sup> Regarding the question of the involvement of Jews in the soviet partisan warfare against German troops cf. E. Jäckel, P. Longerich, J. H. Schoeps (eds.), *Enzyklopädie des Holocaust*, Argon, Berlin 1993, p. 1348; cf. Nechama Tec, *Defiance, the Bielski Partisans*, Oxford University Press, New York 1993.



## Appendix 1:

### *Wood Preservation through Fumigation with Hydrogen Cyanide: Blue Discoloration of Lime- and Cement-Based Interior Plaster*

HELMUT WEBER, WITH COMMENTS BY GERMAR RUDOLF

*Water- and oil-based substances are not the only means for preserving wood; for a long time wood has also been fumigated with toxins, such as hydrogen cyanide.*

*Hydrogen cyanide, or hydrogen cyanide, is a weak acid, which reacts with moist, very alkaline plasters through the process of neutralization: the product is calcium cyanide. The highly reactive cyanide ion combines with iron ions to form, among other things, the complex salt known as Prussian Blue. This is why, in the case of the architectural damage described herein, the iron-rich plaster became discolored blue.*

#### **Background**

*Approximately three years ago [1976] a church of average size was extensively restored. Aside from drying out the brickwork and removing salt deposits, a fumigation with hydrogen cyanide (of the Zyklon B type) was also performed. This method was used to treat parts of the gallery as well as the structural woodwork for the choir section, which had been infested by various wood pests. It is important to note that this method does not provide protection against reoccurrence; it is not a preventative measure and serves strictly to eradicate the pests already present.*

*In such fumigations, gaseous toxins are distributed throughout the space in question. They are left to react for an appropriate period of time, and then the space is aired out and the toxins are removed to the outside world. Of course it is important that the facilities to be fumigated are sealed off as tightly as possible during the procedure.*

*In the case under investigation here, fumigation was carried out after the outside walls of the building had been dried out with an electro-osmotic device and after the plaster in the interior had been restored. In this context it is important to note that the plaster used was a porous hydrophobic kind with moisture-damming properties: such restoration plasters are characterized by low capillary water absorption and greatest possible permeability to water vapor; limit values may be set at  $A \leq 0.3 \text{ kg/m}^2\text{h}^{0.5}$  and  $s_a \leq 2 \text{ m}$ . The plaster contained perlite as filler and, as later analyses showed, had a relatively high iron content, exceeding 1% by weight on average. The plaster was bound with lime and cement and consequently was highly alkaline.*

*Several weeks' time elapsed between replastering and the fumigation. The fumigation was carried out by an expert firm, which had already successfully treated several hundred other facilities. And at first there were no problems in this case either. Following the fumigation the remaining work was carried out without complications. The work consisted in the main of re-*

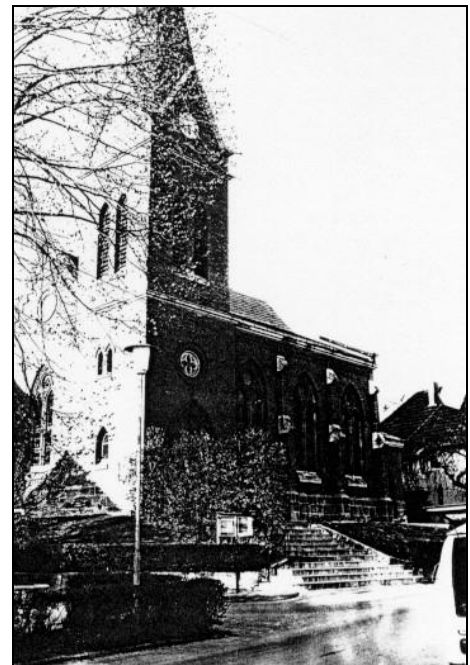

**Illustration 1:** The Protestant church in D-96484 Meeder-Wiesenfeld (near Coburg), which in 1976 became the victim of a Zyklon B fumigation.

painting various parts of the interior, which were of art-historical value, as well as of the application of a coat of paint onto the new plaster surfaces. The paint used was a pure lime-based paint.

Several months after the building was opened to the public, small ink-blue spots appeared at various places on the newly plastered surfaces. Little attention was paid to them at first; it was assumed that they were ink stains or the like. But the spots grew larger, and in some parts of the building discolored patches up to about a square meter (10 sq.ft.) in size developed. The persons in charge were helpless. The specialists who had been called in from the appropriate firms could not explain this phenomenon, and not even the subject literature contained anything pertinent.

## Causes

It took chemical analyses of the plaster to determine the causes of this blue discoloration. These analyses confirmed the initial suspicion that the substance known as Berlin Blue had formed.

Chemically speaking, hydrogen cyanide (HCN) is a very weak acid. It is bound by damp, highly alkaline brickwork through neutralization. This produces calcium cyanide ( $\text{Ca}(\text{CN})_2$ ), for example:

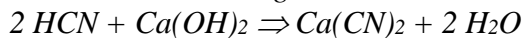

The cyanide ion is a highly reactive ion, which joins with metals to form very stable complex salts. The best-known complex salts are the yellow and red iron cyanides. These compounds form when iron ions combine with cyanide: with the iron(II) ion, the yellow ferrocyanide forms, and with the iron(III) ion, the red ferricyanide is produced:

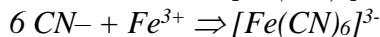
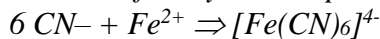

In the presence of excess iron(II) or iron(III) ions, the yellow or red iron cyanide then reacts to form blue compounds which are described in the literature as Berlin Blue and Turnbull's Blue, respectively:

### Holzschutz durch Blausäure-Begasung Blaufärbung von Kalkzement-Innenputz

Holz kann nicht nur mit wässrigen und öligen Systemen geschützt werden, seit langem wird Holz auch mit Giftstoffen wie z. B. mit Blausäure begast.

Blausäure ist eine schwache Säure, die durch feuchten, stark alkalischen Putz durch Neutralisation gebunden wird; es entsteht Calciumcyanid. Das sehr reaktionsfähige Cyanidion bildet mit Eisenionen u. a. das Komplexsalz Berliner Blau. Dadurch verfärbte sich im hier beschriebenen Schadenfall der stark eisenhaltige Putz blau.

**Sachverhalt**

Vor etwa drei Jahren wurde eine Kirche mittlerer Größe umfassend restauriert. Neben der Trockenlegung des Mauerwerks und einer Salzsanierung wurde auch eine Begasung mit Blausäure (System Zyklon B) durchgeführt. Dadurch sollten die von verschiedenen Holzschädlingen befallenen Bauteile der Emporen und das Chorgestühl behandelt werden. Es sei vermerkt, daß sich ein vorbeugender Schutz mit diesem Verfahren nicht erzielen läßt. Es dient ausschließlich der Bekämpfung von Schädlingen.

Bei solchen Begasungen werden gasförmige Giftstoffe im Raum verteilt. Man läßt sie eine entsprechende Zeit einwirken und anschließend werden die Gifte durch Belüftung an die Außenwelt abgegeben. Wichtig ist natürlich, daß eine möglichst gute Abdichtung des Objektes vorgenommen wird.

Im vorliegenden Fall erfolgte die Begasung nach der Trockenlegung der Außenmauern des Bauwerks mit einer elektromotorischen Anlage und nach einer Putzsanierung im Inneren. Wichtig ist in diesem Zusammenhang der Hinweis, daß für die Putzsanierung ein porenhydrophober Putz mit dämmenden Eigenschaften eingesetzt wurde. Solche Sanierputze sind Putze mit möglichst geringer kapillarer Wasseraufnahme und möglichst hoher Wasserdampfdurchlässigkeit, als Grenzwerte können angegeben werden  $A \leq 0,3 \text{ kg/m}^2\text{m}$  und  $sg \leq 2 \text{ m}$ . Der Putz enthielt als Füllstoff Perlite und hatte,

wie spätere Analysen zeigten, einen relativ hohen Eisengehalt. Der Eisengehalt lag im Mittel über 1 Gew.-%. Der Putz war gebunden mit Kalk und Zement und war demzufolge stark alkalisch.

Der Zeitraum zwischen Neuverputz und Begasung betrug einige Wochen. Die Begasung wurde von einem Fachbetrieb durchgeführt, der bereits an mehreren hundert Objekten mit Erfolg tätig geworden ist. Es traten auch im vorliegenden Falle zunächst keinerlei Probleme auf. Nach der Begasung wurden die weiteren Arbeiten ohne Schwierigkeiten durchgeführt. Sie bestanden hauptsächlich in der farblichen Fassung verschiedener kunsthistorisch wertvoller Teile des Innenraumes sowie im Aufbringen eines neuen Farbstriches auf den Putzflächen. Als Farbstrich wurde eine reine Sumpfkalkfarbe verwendet.

Einige Monate nach der Übergabe des Bauwerkes traten – zunächst wenig beachtet – an einzelnen Stellen im neu verputzten Bereich kleine tintenblaue Flecken auf. Man glaubte zunächst, diese seien auf Verunreinigung mit Tinte oder ähnlichem zurückzuführen. Die Flecken vergrößerten sich und in einzelnen Bereichen des Objektes traten Verfärbungen auf bis zu einer Größe von etwa einem Quadratmeter. Man stand dem Problem ratlos gegenüber. Die zu Hilfe gerufenen Spezialisten der einschlägigen Firmen konnten sich diesen Effekt nicht erklären, ähnliches war auch in der Literatur nicht beschrieben.



120

**Illustration 2:** First two pages of the quoted article, including a b/w photo of the patchy iron blue staining on the plasterwork of the Protestant church of Wiesenfeld.

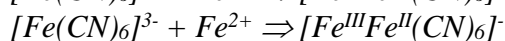
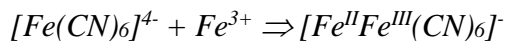

The formation of these compounds was what had caused the discoloration at the plaster's surface in the church. Conclusive proof of this was easily furnished. Spraying plaster surfaces which had not yet turned blue with a solution of iron(II) or iron(III) salts, respectively, produced a spontaneous blue discoloration, which otherwise would have formed only slowly, as the reaction progressed by itself.

## Clean-Up and Restoration

A waiting time of about two years was allowed before attempts were made to rectify the damage, so that, quantitatively speaking, the reaction would have largely run its course. It turned out that even after one-and-a-half years new blue discolorations still formed in some places. Clean-up and restoration itself is costly; all the new plaster that was applied must be removed again. This is all the more regrettable because it necessitates protective measures for all wood paneling in the gallery and for the organ, since otherwise the dust generated by the clean-up activities would inevitably do damage.

After the plaster has been removed, a new plaster as free of iron components as possible will be applied. Either a lime-based mortar or a so-called restoration plaster may be used. After the plaster has hardened, the entire interior must be color-matched to the remaining parts of the church. This is always problematic, since all paints – even lime-based paint – undergo a certain aging process, and mixing the paint to match the ground color present will likely prove difficult.

It is safe to assume that the problem will then be cleared up and that no new blue discolorations will appear. In the areas still bearing the original plaster, i.e., in the upper regions of the church, this is not to be expected anyhow, since the alkalinity required for neutralizing the hydrogen cyanide is not present there.

An easier clean-up method, i.e., a conversion of the blue patches into colorless compounds, is not possible by any common chemical means.

## Commentary

It goes without saying that fumigations involving highly toxic substances must be performed only by expert contractors with the appropriate training and licenses. During the treatment the premises in question are kept under guard so that no unauthorized persons can enter them. Despite the toxicity of the substances involved, no accidents have been reported to date. Cases of damage to the facilities themselves have also been very rare. One spectacular case of such damage was reported for the first time in 1974, by Grosser and Roßmann.

But despite being highly uncommon, this report of damage also shows how difficult it is for an architect to use chemicals in construction. Plasters and paints must also be considered from a chemical perspective because, as clearly demonstrated by the present case, it is the combination of various factors which ultimately does the damage. It is suggested that in similar cases of fumigation, an appropriate construction-chemical investigation be conducted first to determine whether discolorations such as were the case here might result. The alkalinity and the iron content of the brickwork or plaster are factors requiring particular attention.

## For Further Reading

Grosser, D., and E. Roßmann: Blausäuregas als bekämpfendes Holzschutzmittel für Kunstobjekte. Holz als Roh- und Werkstoff, v. 32 (1974), pp. 108-114.

The preceding account was published on pages 120f. of volume 4 of the series *Bauschäden Sammlung. Sachverhalt – Ursache – Sanierung*, edited by Günter Zimmermann, published in 1981 by Forum-Verlag, Stuttgart, and rediscovered by Walter Lüftl, to whom we owe thanks. A more re-



cent review about damages caused by HCN fumigations, including further cases as here described, was published in 1995.<sup>1</sup>

This striking example ought to suffice to refute any objections to the effect that, for chemical reasons, no long-term stable cyanide compounds could have formed in the walls of those Birkenau crematoria that are termed gas chambers, and that there must be a different explanation for the large quantities of cyanide that are to be found in the camp's delousing facilities, evidenced by the patchy-blue discoloration of the plaster there.<sup>2</sup>

The fact that the expert literature is unaware of more such damages caused by HCN might have mainly three simple reasons:

1. The first fumigation of a building or room normally takes place only after it has been used for quite a long period, *i.e.*, years, since new buildings are not vermin-infested. Therefore the plaster of the fumigated walls is carbonized, *i.e.*, no longer alkaline and thus not liable to accumulate high amounts of cyanides after only one fumigation.
2. Normally, a building is fumigated only now and then, *i.e.*, hardly ever more than once a decade or even longer periods of time.
3. Furthermore, a room to be fumigated normally is at least fairly dry as it is required by the legal regulations and operational instructions. But humidity is required for the accumulation of cyanide and its chemical conversion into long-term stable compounds.

Before we compare the case described in the previous article with the circumstances in Auschwitz and Birkenau, we must point out that, despite affirmations to the contrary, accidents have indeed happened in the course of HCN fumigations of buildings. As in any commercial activity, accidents do occasionally happen here as well.<sup>3</sup> The sweeping claim that highly alkaline plaster is the only kind to combine with hydrogen cyanide is also untrue. While a high degree of alkalinity does facilitate the rapid absorption of large quantities of HCN, slightly alkaline or even neutral plasters can also accumulate considerable quantities over time, as the HCN delousing chambers in Majdanek show (cf. the contribution of Carlo Mattogno in this volume). It is interesting to compare the case described here with the alleged gas chambers in crematoria II and III (in each case, mortuary 1) of Birkenau, on the one hand, with the delousing facilities of Buildings 5a and 5b on the other. These have already been described in detail in the chapter by Gernar Rudolf (this volume):<sup>4</sup>

The iron content of the plasters in Birkenau was determined by Gernar Rudolf as documented in his report.<sup>4</sup>

The alkalinity of the plasters in the mortuaries of the crematoria will have been similar to that in the church described previously, since in both cases the plasters were cement-based, which are clearly alkaline in the long term. The plaster in the delousing facilities is a lime-based mortar and therefore was probably strongly alkaline only in the beginning – which may have sufficed to form reasonable amounts of iron blue if the fumigations started right away after the plastering had been finished.

Despite the fact that the temperature is generally low in churches, and that as a result plasters there usually have a high moisture content, the plaster in the church in question was likely only moderately

---

<sup>1</sup> E. Emmerling, in M. Petzet (ed.), *Holzschädlingsbekämpfung durch Begasung*, Arbeitshefte des Bayerischen Landesamtes für Denkmalpflege, Bd. 75, Lipp-Verlag, Munich 1995, p. 43-56.

<sup>2</sup> *E.g.*, J. Markiewicz, W. Gubala, J. Labeledz, *Z Zagadnien Nauk Sadowych*, Z. XXX (1994), pp. 17-27; J. Bailer, in B. Bailer-Galanda, W. Benz, W. Neugebauer (eds.), *Wahrheit und Auschwitzlüge*, Deuticke, Vienna 1995, pp. 111-118; B. Clair “Revisionistische Gutachten”, *Vierteljahreshefte für freie Geschichtsforschung (VffG)* 1(2) (1997), pp. 102f; for critiques of these see G. Rudolf's contribution about the ‘gas chambers’ of Auschwitz.

<sup>3</sup> For example, one case is described by S. Moeschlin in *Klinik und Therapie der Vergiftung*, Thieme, Stuttgart 1986, pp. 300f.

<sup>4</sup> For a more detailed account, cf. Gernar Rudolf, *The Rudolf Report*, Theses & Dissertations Press, Chicago, IL, March 2003, pp. 279-283 (online: vho.org/GB/Books/tr).

PROPERTY \ LOCATION	CHURCH CLEAN-UP AND RESTORATION	CREMATORIUM II/III (MORTUARY 1)	DELOUSING FACILITIES OF BUILDINGS 5A/B
Iron content	>1% by vol.	1-2% by vol.	0.5-5% by vol.
Alkalinity	high	high	low to high
Moisture	moderate	high	moderate to low
Time elapsed between plastering and fumigation	several weeks	between several weeks and 3 months	(several weeks???)
No. of fumigations	1	allegedly ≥400	probably ≈300
Cyanide present	clearly apparent	negative or traces not reproducible	clearly apparent (0.1-1% by vol.)

damp due to its hydrophobic (water-expellent or repellent) consistency. The walls of the [underground] unheated mortuaries 1 of crematoria II and III of Birkenau, on the other hand, would have been very moist, especially if one assumes mass gassings to have been a fact (condensation of body moisture on the cool walls). On the other hand, the delousing facilities of Buildings 5a/b, which were located above the ground and were equipped with heating systems, will have had dry and warm walls, except perhaps the external walls on cold (wintery) days.

Since crematoria II and III were built in the winter of 1942-43 and were allegedly put into operation as mass gassing facilities right away, in spring 1943, a time period of between a few weeks and up to three months would have elapsed between the time of completion of the plasterwork and the time of the first fumigation – just as much as, or a bit more than, in case of the church. The time between the completion of the delousing facilities and the first fumigation is unknown, but it was likely no more than a few days, since the disastrous hygienic situation in Birkenau must have urged the SS to operate these facilities as soon as they were finished.

Therefore, the only significant differences between the Birkenau mortuaries and the fumigated church was the higher moisture content of the mortuaries' walls and the possibly longer time gap between completion and start of operation in case of the mortuaries. Both factors are likely to compensate each other. Thus, one would have to expect a similar tendency to form long-term stable cyanide compounds in both cases. But we cannot find any significant cyanide residues in the mortuaries now testified to have been homicidal 'gas chambers'!

If one attempts to maintain a theory of the mass gassings in those mortuaries, despite the actual state of affairs, which is clearly contrary to what one would have to expect under the exterminationist hypothesis, then one is indeed forced to go against eyewitness claims and to minimize the number of gassings, to greatly reduce the quantities of poison allegedly used, and to decrease the application time to a technically absolutely impossible level – while disregarding entirely the lack of any means for introducing the poison gas substance into the rooms, and also disregarding entirely the paradox posed by the alleged gas chambers of Majdanek and Stutthof, where huge amounts of iron blue did form, due to alleged homicidal gassings, as we are told. In actual fact, these facilities in Majdanek and Stutthof were never anything else than simple, straight-forward hydrogen cyanide delousing chambers (compare the chapter by Carlo Mattogno, this volume).



## Appendix 2:

# *Grundlagen zur Zeitgeschichte* (Dissecting the Holocaust): Expert Report

JOACHIM HOFFMANN

### Preamble

Accredited chemist Germar Rudolf[...] has written me to request an expert statement regarding an anthology titled *Grundlagen zur Zeitgeschichte: Ein Handbuch über strittige Fragen des 20. Jahrhunderts*, edited by Ernst Gauss and published in 1994 by Grabert-Verlag in Tübingen, Germany. The foremost issue was to be the question of the work's scientific, *i.e.*, academic nature, rather than the content per se.

As an historian specializing in recent and East European history, and on the basis of my decades of professional experience and practice in the academic service of the Federal Republik of Germany, I am qualified and entitled to give an expert opinion on the matter in question.

Regarding my personal qualifications, I wish to state that I was a member of the Militärgeschichtliche Forschungsamt [Centre for Research in Military History] in Freiburg from 1960 to 1995. For almost three decades my work has focused exclusively on matters related to the German-Soviet war. Through the publication of academic books and periodical articles on this topic I am well established as an expert in my field, both at home and abroad. Accredited chemist Rudolf [...] and the co-authors of the anthology at issue are not personally known to me.

### The Formal Aspect

As pointed out in the anthology in question, the book does not offer a comprehensive overview of the course of the National Socialist persecution of the Jews during World War Two. Rather, the focus is on specific individual topics regarding disputed and controversial aspects of killings of the Jews. The various contributions to the book are expertly written in a predominantly investigative style. Where detail and completeness are concerned, the body of supporting and documenting references leaves little to be desired and is extremely helpful to a reader seeking further information, not least of all since sources from the opposing subject literature are also cited without reservation. It appears, therefore, that this anthology is part of the large-scale academic dispute over a serious contemporary issue which reaches far beyond its actual academic scope and into the political realm.

The individual contributions to this anthology are logically consistent and objectively descriptive in structure, even though at times a polemic note does become evident – as is perhaps inevitable in such emotionally charged topics, and as is also quite common in political and historical controversies. In any case, a striving for new understanding is tangibly apparent throughout the book. From this perspective, therefore, the anthology cannot be denied an academic character, particularly if one compares it with many a publication from its opposing side, whose academic nature is also never questioned. There is much in the various contributions that strikes one as thoroughly convincing. Much else may be merely noted with objective interest. Elsewhere, doubts and criticisms also come to mind. The issue may perhaps be simplified by pointing out that what we are dealing with in this great controversy is a rather more accusatory style of literature on the one hand, and a rather more

apologetic one on the other. This is to suggest that in the heat of controversy, both sides may be overly inclined to overshoot the mark and to leave the solid ground of provable facts behind. One might perhaps summarize by saying that the time for conclusive declarations regarding the great persecution of the Jews has not yet come.

## The Problem of Self-Evidentness

There can be no doubt about the fact that genocide was committed against the Jewish people by the Einsatzgruppen of the Security Police and the SD and by the SS personnel in charge in the concentration camps in the former General Government of Poland. Hitler, Himmler and Dr. Goebbels clearly admitted these misdeeds on several occasions. The anthology's editor, Ernst Gauss, also considers this as given in his chapter. And in fact, the genocide provides an unspoken backdrop for the anthology at issue. To rule out any misunderstanding, it would perhaps have been better to spell these things out unambiguously and to clarify that an academic controversy today can no longer dispute the mass killings per se, but rather only the numbers of victims and the methods of murder. In this respect, we admittedly may expect to see far-reaching modifications as yet. In this context as well, the rather overused concept of self-evidentness is in need of limitation, or at least of a more precise definition.

## Two Important Examples

We shall give two especially significant examples of this.

### 1) [Downward Revision of the Number of Auschwitz Victims]

From 1945 to 1990, the figure of 4 million victims in Auschwitz was considered self-evident and was accorded judicial notice in the Federal German courts. But where did this figure come from? It originated with Soviet war propaganda. On March 1, 1945, an official Soviet announcement stated for the first time that “*at least five million people were exterminated*” in Auschwitz. This figure was then reduced to four million in the official Soviet communiqué of May 7, 1945. This number of 4 million victims – put about by Soviet war propaganda, in other words by the NKVD, and in no way proven by any evidence whatsoever – was adopted by the public in western countries, and persisted unchanged until 1990, when it was officially reduced to 1.5 million virtually overnight. Currently the number of Auschwitz victims is set at a remaining 631,000 to 711,000, and a further reduction has not been ruled out.

### 2) [The Total Number of Jewish Victims]

To this day the total number of Jewish victims is generally given as 6 million. According to the current opinion of the German experts on contemporary history, this figure was first provided to the Americans by SS Sturmbannführer Dr. Hoettl in spring 1945, and repeated at the IMT in Nuremberg on November 26, 1945. It must be noted, however, that this selfsame figure was demonstrably first put forth in the foreign press as early as January 4, 1945, several weeks prior to the January 27, 1945, liberation of the Auschwitz concentration camp (with its alleged 4 million victims) – put about by none other than the infamous Soviet Minister of Propaganda, Ilya Ehrenburg. Thus it was Ehrenburg who came up with the figure of six million. [cf. Joachim Hoffmann, *Stalin's War of Extermination 1941 – 1945*, Theses & Dissertations Press, Capshaw, AL, 2001, pp. 189f.]

Regarding Ehrenburg himself, it must be mentioned that in 1941 Stalin had given him the general order to incite a boundless national and racial hatred against all Germans. Ehrenburg's years-long unbridled frenzies of hatred culminated in his call to “*put an end to Germany*” and in an effort

which he described as “*modest and honorable*”, namely “*to reduce the population of Germany*”, towards which end the only thing left to decide was whether it would be better “*to kill the Germans with axes or with clubs*”.

Both examples show that new evidence can immediately overthrow something that is allegedly self-evident, and, accordingly, it is the duty of any contemporary historian to call allegedly conclusive findings into question. Even in matters involving grave charges, the principle of self-evidentness has been known to become invalidated. As an example one need only consider the claim (widely accepted in Germany in particular, but now denied by Yad Vashem itself) that the Germans had manufactured soap from the bodies of murdered Jews – a fabrication that also goes back to Soviet war propaganda. Therefore, the anthology at issue here does not commit anything unlawful, but rather engages in a justified and necessary pursuit in its attempt to critically examine allegedly self-evident issues on the basis of new evidence or findings, as it is in fact the natural task of historiography to do.

## The Problem of Eyewitness Testimony

Several contributions to this anthology point out, and rightly so, that the testimony of eyewitnesses is unreliable; these contributions back their claims with numerous examples, some of which are indeed truly grotesque. Such experiences certainly agree with those of other historians of the Second World War. This is not to say that eyewitness statements are entirely superfluous, but practical experience definitely has shown that they must always be examined and corroborated with authentic documents. My personal experience has been that as early as 1970 eyewitness testimony about details of the events of the war was so unreliable that it would have been a breach of professional duties to base a historical treatise on them alone.

## Benz’s Anthology

On the whole, the contributions to the anthology here at issue frequently manifest a profound understanding of the subject and its associated literature, even though some suggestions made do appear questionable at times. However, the establishment literature about the Holocaust also often contains factual errors. One example in this context is Benz’s 1991 anthology *Dimension des Völkermords*, which displays a downright disarming ignorance of the state of affairs on the Soviet side. The authors of the Gauss anthology object, and correctly so, that Benz bases his studies uncritically

*Joachim Hoffmann, Dr. phil., born 1930 in Königsberg, East Prussia; studied modern history, eastern european history and comparative ethnology at the University of Hamburg and Berlin’s Free University. He received his PhD in history in 1959. Between 1960 and 1995, he was historian at the Militärgeschichtliche Forschungsamt der Bundeswehr (Research Department for Military History of the German Army). His field of expertise was “Armed Forces of the Soviet Union”; Dr. Hoffmann has authored numerous articles and books about political, diplomatic and military history of the 19<sup>th</sup> century and about the history of the German-Soviet war. In 1991, he was granted the “Dr. Walter-Eckhardt” Award, and in 1992 the “General Andrej Andrejewitsch Wlassow” Cultural Prize. He died in February 2002.*

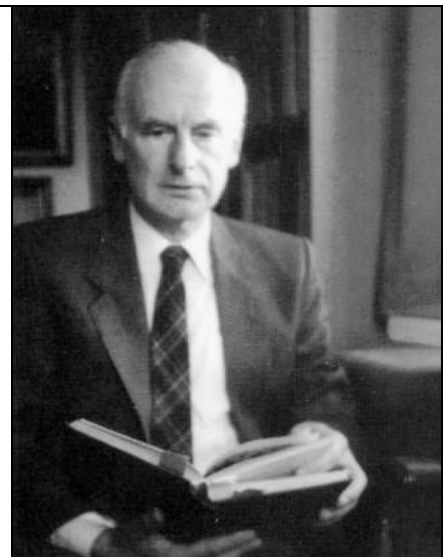

on the announcements made by Soviet war propaganda and on the publications about Soviet show trials. The anthology edited by Benz attempts, by means of elaborate statistical minutiae, to prove the correctness of the six-million figure. Anyone who has worked with demographic statistics knows what serious errors can enter into such complex analyses even under a strictly objective agenda. Benz is entirely unaware that Ehrenburg had already introduced the six-million figure into the annals of war propaganda on January 4, 1945. Thus, he will have to accept the charge that, though unwittingly, he has really only worked to confirm a propaganda figure of Ehrenburg's. From this perspective, his and his co-authors' research findings offer a foothold for fundamental criticism.

## Babi Yar

The mass execution of Jewish inhabitants of Kyiv, known as the massacre of Babi Yar, is also subjected to justified and necessary criticism in the anthology here at issue. Over time, the actions of Einsatzkommando 4a of the Security Police and the SD under Blobel have experienced propagandistic inflation to the point where restoring the actual facts to their real dimensions is an obligation for anyone striving for historical veracity. Of course this does not impinge on the fact that thousands of Jews were killed in Kyiv.

## Overall Impression

The overall impression evoked by this anthology edited by Gauss is that its contents must be acknowledged – with critical common sense, of course – no less than is always undisputedly and unrestrictedly done with the 'official' literature about the Holocaust. The principle of *audiatur et altera pars* [let the other side be heard] must apply in this case as well! A suppression of this carefully documented work would represent a forcible obstruction of the legitimate striving for scientific and academic understanding. The state of knowledge is never static. Experience has shown that exaggerations and errors always grind themselves down in the course of a normal academic controversy. One must not deny a mature and free researcher and reader his ability to exercise his critical faculties. It would then be only a small step from suppressing unpopular books, to burning them; and then, though with different motivations, we would be right back where the entire misfortune began.

## Conclusion

As historian officially commissioned by the Militärgeschichtliche Forschungsamt I have spent two-and-a-half decades studying the Soviet military literature about the history of the Red Army and the Second World War in its original documentary texts – an endless chain of misrepresentations, fabrications, distortions and slander. But even this historical literature turned up the occasional truths. I could not have carried out my academic duties if I had rejected the Soviet publications out-of-hand as being unacademic. The same goes infinitely more for the anthology here at issue, which is on a respectable academic level and which doubtless contributes much to our understanding of aspects of the war, despite any reservations one may have.

[sgd.] Dr. J. Hoffmann, Acad. Director (retired)  
[written on September 28, 1995]

---

On June 15, 1996, judge Burkhardt Stein from Tübingen County Court ordered the confiscation and incineration of all books *Grundlagen zur Zeitgeschichte* and the destruction of all means for manufacturing them (Ref. 4 Gs 173/95). The expert reports presented by the defense were ignored.

## Appendix 3:

# Censorship in Germany? Never! Unless...

ANTON MÄGERLE

## Prologue

In German history, censorship unfortunately has been more of a rule than an exception. It was introduced by the Catholic Church in the form of the Inquisition. However, it was left to the well-known Austrian statesman Metternich to perfect the system of suppressing freedom of speech by means of a comprehensive spy and surveillance apparatus. Neither the German Empire nor the Weimar Republic were particularly soft in their dealings with unwelcome literature,<sup>1</sup> but the worst reputation was doubtless acquired by the Third Reich, which managed, within the twelve years of its existence, to black-list some 10,000 books. While these books were not burned, they did disappear from the shelves of bookstores, to be banished to library archives.<sup>2</sup>

But what is not nearly as well known is the fact that it was the Allied ‘liberators’ of Germany who staged the greatest campaign of book destruction that mankind had ever seen. Among the victims of Allied displeasure were 34,645 titles as well as, comprehensively, all school textbooks published between 1933 and 1945; not only were these no longer permitted to be printed and sold after the war – they also had to vanish from the archives of many libraries.<sup>3</sup> In the years from 1946 to 1952, the Soviet Occupation Power published four such lists (“*Liste der auszusondernden Literatur*”, or list of proscribed literature) of titles earmarked for destruction. In accordance with the instructions in the censors’ introduction to the second and third volumes, the first three of these lists also went into force in the western Occupation Zones.

## The German Constitution

In its Article 5, Section 1, Clause 3, the current German Constitution (Grundgesetz, or GG) prohibits censorship. Section 2 of that same Article, however, limits this freedom from censorship as per the regulations imposed by “*general laws*”, among other things. A fundamental human right can

---

<sup>1</sup> For more see Claus Nordbruch, *Sind Gedanken noch frei? Zensur in Deutschland*, Universitas, Munich 1998.

<sup>2</sup> The opinions about this differ slightly: acc. to Dietrich Strothmann, *Nationalsozialistische Literaturpolitik*, 3rd ed., Bouvier, Bonn 1985, some 12,500 books, acc. to Dietrich Aigner, *Die Indizierung “schädlichen und unerwünschten Schrifttums” im Dritten Reich*, vol. XI of the *Archiv für Geschichte des Buchwesens*, Buchhändlervereinigung, Frankfurt/Main 1971, the number was less than 10,000.

<sup>3</sup> For some more details see, e.g., Martin Lüders, *Nation und Europa*, vol. 47(9) (1997), pp. 7-11. The list of all books banned by the Allies (*Liste der auszusondernden Literatur*) was recently reprinted by Uwe Berg-Verlag, Toppenstedt (Germany) 1983/84 (Deutschen Verwaltung für Volksbildung in der sowjetischen Besatzungszone/Ministerium für Volksbildung der Deutschen Demokratischen Republik (ed.) *Liste der auszusondernden Literatur. Index der in der sowjetischen Besatzungszone verbotenen Bücher nach dem Stand vom 1. April 1946; Erster Nachtrag zum Index der in der sowjetischen Besatzungszone verbotenen Bücher nach dem Stand vom 1. Januar 1947; Zweiter Nachtrag zum “Index” der in der sowjetischen Besatzungszone verbotenen Bücher nach dem Stand vom 1. September 1948; Dritter und letzter Nachtrag zum “Index” der in der sowjetischen Besatzungszone verbotenen Bücher nach dem Stand vom 1. April 1952*, 4 vols., Zentralverlag, Berlin (East) 1946-1948, 1953). It can be found completely at [vho.org/censor/tA.html](http://vho.org/censor/tA.html).



thus be suspended, at least theoretically, by everyday laws such as those of criminal law.<sup>4</sup> In this respect, the German Federal Constitutional Court (Bundesverfassungsgericht) has determined that “*general laws*” are such that do not prohibit a specific opinion, or freedom of speech per se. Furthermore, general laws may impose limits on a fundamental right only if doing so serves to safeguard another fundamental right. In accordance with the principle of proportionality, the benefits of both conflicting fundamental rights must be weighed against each other.<sup>5</sup>

Further restrictions imposed on freedom of speech by Article 5 Section 2 GG serve the protection of young people and of personal honor. According to rulings of the German Federal Constitutional Court, the core significance of the human right to freedom of speech is that censorship of publications is permitted only if these publications are at least a constant or typical source of endangerment to the young people who might read, hear or watch them.

Regarding injury to honor, the Federal Constitutional Court has ruled that such injury generally has not occurred if no insulting expressions have been used.

## Criminal Law

The German Criminal Code (Strafgesetzbuch, StGB) has at its disposal tools facilitating censorship, particularly in §§ 185, 189 and 130f. While §§ 185 and 189 (slander, disparagement of the memory of persons deceased) may be subsumed under the category of “*injuries to honor*”, §§ 130f. (incitement of the people, incitement to hatred) are a mixed grouping of injuries to honor, injury to human dignity (Article 1 GG), and endangerment of the public peace, a conceptual chimera which we shall not investigate in greater detail here.

The autumn 1994 revision of § 130 StGB (the so-called *Lex Deckert*) decreed, among other things, that it is a criminal offense

“*publicly or in an assembly, and in a manner likely to lead to a breach of the peace, [to] endorse, deny or trivialize any act committed under National Socialist rule [which was] of the type specified in § 220a Section 1 [i.e., genocide, A.M...]*”

This is precisely the scenario which the Federal Constitutional Court has actually ruled out: this law criminalizes a specific opinion about one detail of the history of only one single, past regime. From this perspective alone, this “*hastily passed and unthought-out*”<sup>6</sup> “*special law against freedom of speech*”<sup>7</sup> would seem to be unconstitutional, and it has been criticized commensurately in German legal subject literature, where it is described as being, in effect, “*an attack on the intellectual freedom of dissidents*”<sup>8</sup> and “*virtually the classic example of a norm [...] directed against a specific opinion.*”<sup>7</sup>

“*The legitimacy of this regulation is dubious at the very least. One can already question whether a lie is a criminal wrong at all; one must question whether the mere denial of a historical fact, in the absence*

---

<sup>4</sup> Two recent studies of censorship in Germany, highly to be recommended: Jürgen Schwab, *Die Meinungsdictatur. Wie “demokratische” Zensoren die Freiheit beschneiden*, Coburg: Nation Europa Verlag, 1997, 338 pp.; Claus Nordbruch, *op. cit.* (note 1).

<sup>5</sup> The Federal Constitutional Court’s decisions were quoted from: Karl-Heinz Seifert, Dieter Hömig (eds.), *Grundgesetz für die Bundesrepublik Deutschland*, 2nd ed., Nomos Verlagsgesellschaft, Baden Baden 1985.

<sup>6</sup> Eduard Dreher, Herbert Tröndle (eds.), *Strafgesetzbuch*, 47<sup>th</sup> ed., Beck, Munich 1995, *Strafgesetzbuch*, 47<sup>th</sup> ed., MN 18 regarding §130.

<sup>7</sup> Stefan Huster, “*Das Verbot der ‘Auschwitz-Lüge’, die Meinungsfreiheit und das Bundesverfassungsgericht*”, *Neue Juristische Wochenschrift*, 1995, pp. 487ff., here p. 489.

<sup>8</sup> Daniel Beisel, “*Die Strafbarkeit der Auschwitz-Lüge*”, *Neue Juristische Wochenschrift*, 1995, pp. 997-1000, here p. 1000.

*of any characteristics of agitation, may be described and dealt with as incitement of the people, of all things.*"<sup>9</sup>

The concept of “*denying*” something which the state deems true is a new element in German criminal law and poses problems which it seems quite impossible for criminal procedure to solve. In order for denial to objectively constitute a criminal offense, it must be done deliberately; that is, the denier must *know* that he is not telling the truth and the judge must prove this knowledge, which in and of itself is already virtually impossible. But in order to be able to also punish (especially) the so-called ‘criminals of conviction’ who are convinced that they are telling the truth, the German judiciary has concocted an entirely new definition of intent:

*“In this case, intent can only be the knowledge that one’s conviction puts one into conflict with that which ‘general opinion’ indisputably regards as a historical fact. Admittedly, in a state under the rule of law this places a system of criminal law based on guilt squarely at the crossroads [to criminal law based on arbitrariness]. Just as Auschwitz will ever remain a nightmare for the Germans, the ‘Auschwitz Lie’ will clearly remain the same for German criminal law.”*<sup>10</sup>

However, the revised § 130 StGB includes regulations which even go considerably further. It criminalizes not only dissident views of certain aspects of National Socialist persecution of minorities, but in a sense anything and everything which could be considered incitement to hatred against population subgroups of potentially any definition. In this regard the foremost German criminal law commentary observes that this amendment means that practically any kind of criticism of population subgroups – however they are defined – can become a criminal offense, since the legal right that is supposed to be protected (the anti-discrimination rule) is rendered too general and vague in this Section.<sup>11</sup>

Furthermore, it also permits precautionary censorship, as it were, by providing for the confiscation of publications or other data carriers which are allegedly intended for distribution. The judiciary holds that the intent to distribute prohibited publications exists if a person has in his or her possession, more than one single copy of a data carrier.

That this new German law is difficult to reconcile with international human rights standards is a fact openly acknowledged by Germany’s leading politicians, but it is excused by virtue of the country’s particular history.<sup>12</sup>

## Indexing

The first step in the process of German censorship is the black-listing or “*indexing*” of, for example, a book or pamphlet. This indexing is done by the Federal Review Office for Youth-Endangering Media (*Bundesprüfstelle für jugendgefährdende Medien*, BPjM).<sup>13</sup> Until 2002, this authority could only become active after a complaint by, e.g., a public youth welfare department. However, a more restrictive law introduced in 2002 now allows this authority to index media without the need of a complaint. This indexing means that the black-listed work may no longer be advertised and that it may not be sold or otherwise made available to persons under 18 years of age. In

<sup>9</sup> Karl Lackner, *Strafgesetzbuch*, 21st ed., Munich, 1995, MN 8a regarding §130; the criticisms of this article are legion; cf. Hans A. Stöcker, *Neue Zeitschrift für Strafrecht*, 1995, pp. 237-240; Manfred Brunner, *Frankfurter Allgemeine Zeitung*, Aug. 17, 1994; Ernst Nolte, *ibid.*, Sept. 8, 1994; Ronald Dworkin, *Tageszeitung*, May 17, 1995; Horst Meier, *Die Zeit*, Sept. 15, 1995; Horst Meier, *Merkur* 12/1996: 1128-1131.

<sup>10</sup> Theodor Leckner, in Adolf Schönke, Horst Schröder (eds.), *Strafgesetzbuch*, 25th ed., Beck, Munich 1997, p. 1111.

<sup>11</sup> *Ibid.*, p. 1103.

<sup>12</sup> Federal Minister of Justice Edzard Schmidt-Jorzig, Ruge. NeunzehnZehn: “*Ehrenschutz für Soldaten – Gesetz gegen die Meinungsfreiheit?*”, 3-SAT, March 10, 1996, 19:10; same, *Mut*, no. 351, 11/1996: 32-35; Wolfgang Schäuble, *Frankfurter Allgemeine Zeitung*, April 24, 1996, p. 41.

<sup>13</sup> Until 2002, this authority carried the name Bundesprüfstelle für jugendgefährdende Schriften, BPjS.

practical terms this means that the work ceases to exist for the public, as one can then legally learn of its existence only by private means – or, alternately, via the list of indexed works, which the BPjM regularly publishes in its *Report*. By now this list includes thousands of printed, audio and audio-visual works.<sup>14</sup> Once readily accessible by everybody, this *Report* is now sold only to libraries, wholesalers, and retailers, and even libraries have stopped giving free access to it, which renders the censorship activities of this authority more and more obscure. This tendency to hide its censorship activities was even more enhanced in 2002, when the law was changed so that media, which are regarded to be an especially severe threat to the mental development of young people, are now listed in secret lists. The victims of this secret censorship are media whose content violates German criminal law (libel, denigration of the dead, incitement to hatred, stirring up the people), which includes basically all revisionist literature.<sup>15</sup>

While the BPjM was initially created primarily to protect German youth from pornography and the glorification of violence, it has increasingly also engaged in the battle against politically or historically unpopular literature. As early as 1990 Eckhard Jesse, who is today a Professor of Sociology in Chemnitz, criticized that the BPjM had “in many ways turned out to be a gateway for one-sided anti-Fascism”<sup>16</sup> and that its measures are “difficult to reconcile with the principles of a liberal society [...], because, on principle, in an open society the printed and spoken word may not be stifled.”<sup>17</sup>

To date, this astonishing admission of the violation of human rights through censorship under the auspices of the Federal Constitutional Protection Office, which edited the contribution of Jesse, has received little attention.

The decision of German courts in the case of the book *Wahrheit für Deutschland* (Truth for Germany) has taken on a central significance where the BPjM’s practice of censorship is concerned. This book dealt in an allegedly unacademic manner with the question of who bears the blame for World War Two.<sup>18</sup> The BPjM black-listed it in the late 1970s. In 1994 the Federal Constitutional Court declared this black-listing decision unlawful,<sup>19</sup> but the BPjM promptly re-indexed the book on slightly reworded grounds.<sup>20</sup> The author’s appeal against this, as well as his complaint to the



<sup>14</sup> The latest “comprehensive listing”, *Gesamtverzeichnis indizierter Bücher, Taschenbücher, Broschüren und Comics, Stand 30.4.1993*, includes about 2,500 titles. Some 120 more have since joined the ranks. The list of indexed video tapes is about the same length. Added to this are several hundred electronic sound and data carriers. The current indexing lists are published in the periodical of the Federal Review Office for Youth-Endangering Publications, *BPjS aktuell*. To order: Bundesprüfstelle, Postfach 26 01 21, D-53153 Bonn, Germany.

<sup>15</sup> See the German government website [www.bmfsfj.de](http://www.bmfsfj.de) for more information.

<sup>16</sup> Eckhard Jesse, “Streitbare Demokratie und ‘Vergangenheitsbewältigung’”, in Bundesamt für Verfassungsschutz (ed.), *Verfassungsschutz in der Demokratie*, Carl Heymanns Verlag, Cologne 1990, p. 304, cf. p. 289.

<sup>17</sup> *Ibid.*, p. 287; cf. also p. 303: “Liberal society may not stifle or suppress the free exchange of ideas and points of view.”

<sup>18</sup> Udo Walendy, *Wahrheit für Deutschland*, 3rd ed., Verlag für Volkstum und Zeitgeschichtsforschung, Vlotho 1976.

<sup>19</sup> Ref. 1 BvR 434/87.

<sup>20</sup> *JMS-Report*, February 1/1995, pp. 52-54.

Administrative Court of Cologne, were successful. According to the verdict the BPjM had failed to prove that the book posed a danger to the young people who might read it:

“The BPjM fails to realize that it is precisely the possibility for open debate among different views which furthers the critical abilities of young people, and this demands free and unfettered discussion. Besides instruction in historical events, this requires particularly the critical examination of divergent views. In its considerations the BPjM has completely disregarded that this [...] can (perhaps) protect young people much more effectively from susceptibility to distorting portrayals of history than indexing can, which latter may even endow such opinions with a justified attraction.”<sup>21</sup>

However, this verdict, as well as the Federal Constitutional Court’s previous verdict, also indicate that these principles do not apply if it is, for example, the historiography about the fate of the Jews in the Third Reich that is questioned. Such questioning, the argument goes, not only represents a scientifically blatantly incorrect opinion, it also glorifies National Socialism and disparages the Jews as a group. This does not by any means require that the publication in question verbally attacks the Jews or identifies itself with National Socialist ideology. Not even an open declaration of sympathy with the Jews and a condemnation of National Socialist transgressions in other respects will serve in the publication’s favor if the factual nature of the Holocaust is questioned at even one single point in the work. German courts consider even one such occurrence to be adequate proof of a glorification of the National Socialist system and of an intention to slander the Jews.

To date, appeals against the black-listing of “*Holocaust-denying*” books have been uniformly unsuccessful, since German courts refuse all motions to bring evidence in such trials.<sup>22</sup> Documentation, however, is very fragmentary in this context. Older books which dispute the factuality of the Holocaust – such as *Geschichte der Verfemung Deutschlands* (History of the Defamation of Germany),<sup>23</sup> *Hexeneinmaleins einer Lüge* (Magic Square of a Lie),<sup>24</sup> *Feuerzeichen* (Fire signal)<sup>25</sup> or *Die 2. babylonische Gefangenschaft* (The 2nd Babylonian Captivity)<sup>26</sup> – are not to be found on the Index of the BPjM. On the other hand, one of the first books of this genre – a book that, regarding its style, must certainly be accorded scientific and academic credit, namely, *Der Jahrhundertbetrug*<sup>27</sup> (The Hoax of the Century) – was black-listed as early as spring 1979.<sup>28</sup>

A work issued by the publisher *Kritik-Verlag*, lately of Denmark, has achieved fame at least indirectly. In the early 1970s this publisher issued a brochure titled *Die Auschwitz-Lüge* (The Auschwitz Lie), in which a former German soldier described his experiences in Auschwitz, which are diametrically opposed to those recounted in the well-known eyewitness testimony.<sup>29</sup> At least in Germany the title of this publication became the embodiment of what is otherwise known less polemically as Holocaust revisionism, *i.e.*, the thesis that there was no Third Reich policy of extermination of the

<sup>21</sup> Ref. 17 K 9534/94.

<sup>22</sup> In article 244 the German Code of Criminal Procedure provides for the option to refuse evidence if the point at issue is self-evident, which is a fundamental premise on the part of the courts, where the Holocaust is concerned (“*judicial notice*”).

<sup>23</sup> Franz J. Scheidl, self-pub., 6 vols., Vienna 1967. Most of the books mentioned here can be found on the web site [vho.org](http://vho.org), some of them even in an English translation (at least linked to).

<sup>24</sup> Emil Aretz, Verlag Hohe Warte, Pähl 1973.

<sup>25</sup> Ingrid Weckert, Grabert, Tübingen 1981; ordered seized and destroyed in 1995; in English: *Flashpoint: Kristallnacht 1938*, Institute for Historical Review, Newport Beach (CA) 1991.

<sup>26</sup> Steffen Werner, 2nd ed., Grabert, Tübingen 1991; ordered seized and destroyed in 1995.

<sup>27</sup> Arthur R. Butz; in German: Verlag für Volkstum und Zeitgeschichtsforschung; in English: *The Hoax of the Twentieth Century*, Institute for Historical Review, Newport Beach (CA) 1976, 1992.

<sup>28</sup> *Gesamtverzeichnis indizierter Bücher, Taschenbücher, Broschüren und Comics, Stand 30.4.1993*, p. 8: Index No. E 2765, *Bundesanzeiger* no. 95 of May 22, 1979.

<sup>29</sup> Thies Christophersen, “*Die Auschwitz-Lüge*”, *Kritik* issue no. 23, Mohrkirch: Kritik Verlag, 1973, available today from Vrij Historisch Onderzoek, Berchem Belgium.

Jews. A portrait of Thies Christophersen, the brochure's author, who was prosecuted in Germany and had fled abroad, was used in 1995 by Amnesty International as advertisement for free speech because even the most controversial of all opinions, namely the one that disputes the Holocaust, ought to be protected by the human right to freedom of speech.<sup>30</sup> The publication was not indexed until 1993, fully 20 years after its first publication.<sup>31</sup>

Since the 1994 tightening of criminal law no change has become apparent in the BPjM's decision-making process, and neither is any change necessarily to be expected, since the BPjM proceeds in accordance with the Law for Youth Protection (Gesetz zum Schutz der Jugend, or GjS), not with criminal law.

## Confiscations to 1994

The second stage of German censorship is the so-called confiscation (or seize-and-destroy) stage. This stage hardly registers with the public at all, and even Professor E. Jesse, whom we quoted earlier, seems either not to be aware of it or to ignore it. The confiscation of a publication takes place on the order of a court. What happens to the confiscated copies of such a publication is not quite clear, but it probably varies with the police station in charge. One publisher who is quite frequently the target of such book confiscations reported that he had been told that the books are burned under police supervision.<sup>32</sup> In one case the press reported that confiscated literature is being burnt in waste incinerators.<sup>33</sup>

According to information from the German Federal Government, and unlike for indexed works, there is no office or authority which publishes an even remotely complete list of confiscated books; similarly, the confiscation orders issued by the courts are not published anywhere.<sup>34</sup> Certainly every court that orders or revokes the confiscation of a publication is required to communicate its decision to the Federal Criminal Investigation Office (Bundeskriminalamt), which therefore ought to have a complete and current list, particularly as it serves the courts as information central regarding confiscation orders already issued.<sup>35</sup> However, these confiscation orders are published only every now and then in the *Bundeskriminalblatt*, a publication not readily accessible to the public. What goes for the public's review of black-listing does not go for the actual confiscation of the works in question. In this respect the public is left completely in the dark.

Although pornographic or pro-violent publications are also affected by confiscations, these are not discussed here, since the destruction of political or historical publications is a much more explosive issue from a human-rights point of view.

Up to 1994 it was still possible to keep track of all the confiscated publications with political or historical content. The most spectacular case was no doubt the confiscation of the revisionist book

---

<sup>30</sup> The leftist *Tageszeitung* (Berlin) reported on this in a surprisingly fair manner, Dec. 12, 1995.

<sup>31</sup> *Bundesanzeiger* of Sept. 30, 1994.

<sup>32</sup> Wigbert Grabert, of Grabert Verlag in Tübingen, to the author.

<sup>33</sup> *Abendzeitung* (Munich), March 7./8., 1998: "The remaining copies are occasionally being burnt in a waste incinerator.", regarding R. J. Eibicht, *Hellmut Diwald*; cf. *Zur Zeit* (Vienna), no. 9/1998 (Febr. 27): "65 years ago this happened publicly, today this is being achieved on the quiet in waste incinerators."

<sup>34</sup> Admission of the Federal Government, *Bundestagsdrucksache* 13/4222, March 26, 1996, p. 6. Germar Rudolf tries to compile a list of books confiscated in Germany, see [who.org/censor/Censor.html](http://who.org/censor/Censor.html). Due to lack of official information, this list is necessarily incomplete. Links to confiscated books that are available online can be found there, so no further URLs are given for them in this article's footnotes.

<sup>35</sup> *Richtlinien für das Strafverfahren und das Bußgeldverfahren* (Guidelines for penal procedure and fining procedure), No. 208, II + IV; according to Gerd Pfeiffer (ed.), *Karlsruher Kommentar zur Strafprozeßordnung*, 3rd ed., Beck, Munich 1993, p. 2174.

*Der Auschwitz-Mythos* (The Auschwitz Myth). Due to the book's 'Holocaust-denying' theses, the author, a former judge, was stripped of his doctorate, and his pension was reduced.<sup>36</sup>

Another interesting case are the confiscations of the books published by the revisionist Jew Joseph Ginsburg, under the pseudonym J. G. Burg. His Holocaust-denying books also fell victim to German book burning, even though – being a Jew, and in light of the contents of his writings – he could hardly be accused of anti-Semitism.

Up to the winter of 1996, and where political and historical publications are concerned, the BPjM itself had listed the confiscation of only a few issues of the Swiss-based revisionist periodical *Der Eidgenoss*. The various issues of the revisionist periodical *Historische Tatsachen* (Historical Facts), on the other hand – which have long been subject to confiscation, and which are published by the same publisher whose book *Wahrheit für Deutschland* the BPjM has now been trying for over 20 years to ban – are not mentioned.<sup>38</sup> It was not until the spring of 1997 that the BPjM updated its list, particularly with four books by the Swiss revisionist author Jürgen Graf. With one exception, however, these books had all been confiscated before late 1994, and one had already been de-indexed again in 1995.<sup>39</sup> The BPjM itself is thus even less clear on the state of confiscations than is the author of the present article.

**Germany today:  
94,215 Criminal  
Prosecutions  
Because of "Thought Crimes"  
During the Last Nine Years:**

Year	Right	Left	Foreign	Sum
1994	5,562	185	235	<b>5,982</b>
1995	6,555	256	276	<b>7,087</b>
1996	7,585	557	818	<b>8,960</b>
1997	10,257	1,063	1,029	<b>12,349</b>
1998	9,549	1,141	1,832	<b>12,522</b>
1999	8,698	1,025	1,525	<b>11,248</b>
2000	13,863	979	525	<b>15,367</b>
2001	8,874	429	353	<b>9,656</b>
2002	9,807	331	467	<b>10,605</b>

- **Right:** "Offenses with right wing extremist background", that is: "Propaganda Offenses" and "Stirring up the People"
- **Left:** "Offenses with left wing extremist background", generally referred to as "other offenses"
- **Foreign:** offenses committed by foreign extremists, mainly against the German law of organizations ("Vereinsgesetz") by Kurds in the prohibited Kurdistan Liberation Army PKK<sup>37</sup>

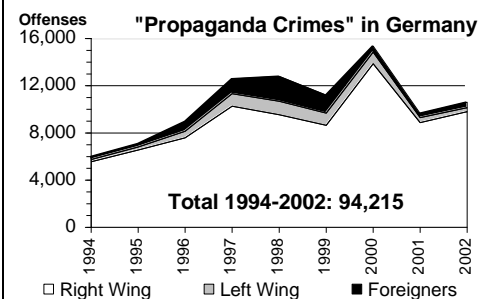

***Especially right-wingers are  
persecuted in Germany.***

<sup>36</sup> Cf. Wigbert Grabert (ed.), *Geschichtsbetrachtung als Wagnis*, Grabert, Tübingen 1984; see also DGG, "Bundesverwaltungsgericht im Dienste der Umerzieher. Erstmals Doktorgrad aus politischen Gründen aberkannt", in *Deutschland Geschichte und Gegenwart* 36(3) (1988), p. 18 (online: [vho.org/D/DGG/DGG36\\_3\\_2.html](http://vho.org/D/DGG/DGG36_3_2.html)); DGG, "Unglaubliches Urteil im Fall Dr. Stiglich", *ibid.*, 36(1) (1988), p. 7 (online: [.../DGG36\\_1\\_1.html](http://.../DGG36_1_1.html)); DGG, "Vernunft wird Unsinn ... Späte Rache für den 'Auschwitz-Mythos'", *ibid.*, 31(1) (1983), pp. 19f. (online: [.../DGG31\\_1.html](http://.../DGG31_1.html)); DGG, "Ende der Wissenschaftsfreiheit?", *ibid.*, 29(3) (1981), p. 38 (online: [.../DGG29\\_3\\_1.html](http://.../DGG29_3_1.html)).

<sup>37</sup> Bundesministerium des Inneren (ed.), *Bundesverfassungsschutzbericht* (Report of the German Office for the Protection of the Constitution), Bundesdruckerei, Bonn 1995-2002, quoting data as provided by the German Federal Bureau of Investigation (Bundeskriminalamt). Since the German government keeps changing the online addresses of their publications, only the addresses of the two latest reports are given here:  
2001: [www.bmi.bund.de/Annex/de\\_20737/Verfassungsschutzbericht\\_2001\\_-\\_Pressefassung.pdf](http://www.bmi.bund.de/Annex/de_20737/Verfassungsschutzbericht_2001_-_Pressefassung.pdf);  
2002: [www.bmi.bund.de/Annex/de\\_24336/Verfassungsschutzbericht\\_2002.pdf](http://www.bmi.bund.de/Annex/de_24336/Verfassungsschutzbericht_2002.pdf).

<sup>38</sup> However, the black-listing of two of these issues is mentioned: *Historische Tatsachen* no. 23 ("Zigeuner bewältigen eine 1/2 Million"), Decision No. 4208, *Bundesanzeiger* 204 of Oct. 31, 1991, and *Historische Tatsachen* no. 36 ("Ein Prozeß, der Geschichte macht"), Decision No. 4029, *Bundesanzeiger* 64 of March 31, 1990.

<sup>39</sup> Jürgen Graf, *Auschwitz. Tätergeständnisse und Augenzeugen des Holocaust*, Neue Visionen, Würenlos 1994; confiscated by the Mannheim County Court, 41 Gs 2626/94, released by the Mannheim District Court, 5 KLS 7/95.

## Confiscations after 1994

This ‘moderate’ confiscation policy changed radically after the revised § 130 StGB took effect on December 1, 1994. Even though the time from December 1, 1994 (the date the new § 130 StGB came into force), and mid-1997 (the authorship date of this article) is only two and a half years, the list of books ordered seized and destroyed during this period is about as long as that of the books which to our knowledge were confiscated in the previous 45 years of the Federal Republic of Germany’s existence.

It is important to note that in most instances the court case reference numbers given refer not only to the confiscation proceedings directed at the books themselves, but refer also to concomitant criminal trials of authors, editors, publishers, booksellers, sometimes even against the printers and multiple-copy purchasers of the publications in question. Criminal prosecution of the purchasers of prohibited publications is initiated even if the books were bought at a time when they were not yet prohibited. In actual fact almost all such trials are of this retroactive nature, *i.e.*, they deal with cases where books were bought before they were confiscated, since as a rule it is no longer possible to obtain the books at all after they have been violently withdrawn from the market.

In reply to an inquiry the Ministry of Justice of the Federal Land of Baden-Württemberg has stated that in the time between the end of 1994 and mid-1996, in Baden-Württemberg alone, there were 32 cases of preliminary proceedings being instituted against private individuals for their multiple purchases of such books.<sup>40</sup> Projected to cover all of Germany, this figure indicates some 250 to 300 such criminal cases.

Revisionist books which, to our knowledge, have not even been black-listed yet – such as *Feuerzeichen* or *Die 2. babylonische Gefangenschaft* – were not the only victims of this new wave of censorship. Books with strictly political content, such as *In Sachen Deutschland* (In the Matter of Germany) or *Wolfsgesellschaft* (society of wolves), were also destroyed. Both these books deal in an unpolemic but rejective manner with the problems of multiculturalism and the supposed incompetence of German politicians. However, since this openly negative attitude allegedly represents incitement against the foreigners in Germany and against the establishment political parties and their representatives, in other words since the books endangered the internal peace of the Federal Republic, they were confiscated.

It is impossible to discuss every prohibited book adequately within the scope of this article. We shall therefore focus on only one case, namely the first seize-and-destroy order that was issued after the legal revision of December 1, 1994. This order was carried out in late March 1995 against the scientific handbook *Grundlagen zur Zeitgeschichte* (Foundations of Contemporary History, German original of this work), which deals very critically with the Holocaust. Since then, 1,000 persons, primarily from the ranks of academia, have spoken out publicly in support of de-indexing this book,<sup>41</sup> and two distinguished historians have even testified in court that the book is scientific and academic in nature and thus ought to be protected under Article 5 Section 3 of the Constitution, where freedom of research is guaranteed without limitations.<sup>42</sup>

---

<sup>40</sup> Landtag (state parliament) of Baden-Württemberg, 12th session, Paper 12/334, Parliamentary question by Rep. Michael Herbricht REP, “*Appell der 500*” Stuttgart, Aug. 27, 1996. Position of the Baden-Württemberg Ministry of Justice, Stuttgart, Sept. 23, 1996, Ref. 4104 - III/185, Dr. Ulrich Goll.

<sup>41</sup> “*Appell der 100 · Die Meinungsfreiheit ist in Gefahr!*”, *Frankfurter Allgemeine Zeitung*, May 17, 1996; in the *Stuttgarter Nachrichten* and the *Stuttgarter Zeitung* on July 19, 1996, with 500 signatures; in the *Westfalen-Blatt* on Sept. 13 and 18, 1996, with 1,000 signatures each.

<sup>42</sup> Expert reports by Prof. Dr. Ernst Nolte and Dr. Joachim Hoffmann, Tübingen County Court, Ref. 4 Gs 173/95; the latter was published in *Vierteljahreshefte für freie Geschichtsforschung*, 1(3) (1997), pp. 205ff., see Appendix 2.

Meanwhile, the Ministry of Justice of Baden-Württemberg has announced that this constitutional provision is not sacrosanct. The Ministry has ruled that destruction of a scientific work is permissible if said work unduly restricts the fundamental rights of a third party.<sup>43</sup> This interpretation is not new, as the German Constitutional High Court decided already in 1985 in the matter of Wilhelm Stäglich/*Der Auschwitz-Mythos*, that the freedom of science is no longer granted when its results allegedly attacks the human dignity of Jews.<sup>44</sup> The implications of this are that scientists may not postulate certain theses and may not question or seek to refute certain establishment theses when this perhaps runs counter to Jewish interests. This ruling of the German Constitutional High Court is quite obviously a violation of human rights, for this interpretation strikes at the heart of the fundamental right to freedom of research, *i.e.*, the right to freedom of choice in the selection of one's theses and the right to openness of research findings (cf. Karl R. Popper<sup>45</sup>). Publications of subject specialists have confirmed that this approach is clearly unconstitutional.<sup>46</sup>

The trial concerning the book *Grundlagen zur Zeitgeschichte* – that is, concerning the freedom of its authors, editor, publisher, printer, sellers and buyers – will likely drag on for several more years and is indeed a crucial case which will contribute significantly to shaping the future course of human rights in Germany.

## Personal Fates

Naturally, every trial for printing, publishing or disseminating a prohibited work also involves at least one personal fate. Exactly how many persons have been punished in recent years for their will to disseminate publications which were outlawed afterwards is not known; the aforementioned figure of several hundred preliminary proceedings, however, would indicate that the number is substantial. In the following we shall touch on only four of the most prominent examples from recent years. (The corresponding court case reference numbers may be found with the entries for the books in question, in the appended list of confiscated books.)

First and foremost, we would mention the case of Günter Deckert, the former Federal Chairman of the German right-wing Nationaldemokratische Partei (National Democratic Party). This case even attracted international attention. As early as 1994 Deckert was sentenced to two years' imprisonment for having interpreted, in an assenting manner, an American speaker's English-language presentation which disputed the mass extermination of the Jews in Auschwitz.<sup>47</sup> This case has been partially recounted in the book *Der Fall Günter Deckert* (The Case of G.D.), co-edited by Deckert himself.<sup>48</sup> This book, in which Deckert supported his revisionist views with new arguments, as well as the sale of 50 copies of the revisionist anthology *Grundlagen zur Zeitgeschichte*, resulted in renewed proceedings against him, the bottom line of which was that he was sentenced to another 20 months' imprisonment in spring 1997. He is supposed to be released from jail in August 2000 – after almost 5 years.

<sup>43</sup> As a reaction to the appeal referred to in note 41 during the parliamentary session referred to in note 40, see IDN, “*Appell der 500' vor Landtag*”, DGG 44(4) (1996), S. 9f. (online: vho.org/D/DGG/IDN44\_4.html); VHO, “*Zur Wissenschaftsfreiheit in Deutschland. Justizminister Württemberg: Wissenschaftsfreiheit ist nicht existent*”, *Vierteljahreshefte für freie Geschichtsforschung* 1(1) (1997), pp. 34-37 (online: vho.org/VffG/1997/1/VHOWiss1.html)

<sup>44</sup> Federal Constitutional Court, ref. 1 BvR 408f./83, reprinted in W. Grabert, *op. cit.* (note 36), pp. 287ff.

<sup>45</sup> Karl Raimund Popper, *Objektive Erkenntnis*, 2nd. ed., Hoffmann & Campe, Hamburg 1984.

<sup>46</sup> Cf. also Daniel Beisel, *op. cit.* (note 8).

<sup>47</sup> Incidentally, this American citizen, Frederick A. Leuchter, was arrested in Germany shortly before he was to appear on a major German television show. He fled to the United States when he was released from pre-trial detention, to await his trial in freedom.

<sup>48</sup> G. Anntohn, H. Roques, DAGD/Germania Verlag, Weinheim 1995



The second-worst fate struck a long-time publisher from Vlotho, the academically accredited political scientist Udo Walendy. In December 1996 he was sentenced, in his last possible appeal, to 15 months' imprisonment for four issues (nos. 1 (2<sup>nd</sup> ed.), 59, 60 and 64) of his revisionist series *Historische Tatsachen*, a series which includes 77 issues to date. In May 1997 the County Court of Herford struck a supplemental blow, as it were, by sentencing Walendy to yet another 14 months' imprisonment for his issues 66 and 68. Subsequently, Walendy's license as a publisher was withdrawn in September 1999, so it is no longer permitted to Herrn Walendy to publish or distribute any media.<sup>49</sup> This case shows especially clearly how German censorship has escalated since the introduction of the relevant legal revisions in late 1994: while none of Walendy's issues had had any criminal consequences for the author prior to the revision, fully six of the twelve issues that appeared afterwards resulted in trials and convictions, even though neither the style nor the content of the periodical had changed in any way.<sup>50</sup>

Our third example is the fate of academically accredited chemist Germar Rudolf, who also publishes under the pseudonym Ernst Gauss. For drawing up and disseminating a chemical and technical expert report known as *Das Rudolf-Gutachten* (The Rudolf Report), which claims to disprove the mass gassings in Auschwitz, he was sentenced in June 1995 to 14 months' imprisonment and has since been prosecuted and persecuted for authoring or editing various revisionist books and brochures (for example, *Grundlagen zur Zeitgeschichte, Prof. Dr. Ernst Nolte: Auch Holocaust-Lügen haben kurze Beine, Auschwitz: Nackte Fakten, Kardinalfragen zur Zeitgeschichte*, various issues of the Journal *Vierteljahreshefte für freie Geschichtsforschung*). He avoided his first prison sentence as well as the trial for editing the book *Grundlagen zur Zeitgeschichte* by fleeing into exile.<sup>51</sup> Wigbert Grabert, the publisher of the book *Grundlagen zur Zeitgeschichte*, was unable to avoid his punishment, and was fined DM 30,000.00.

And last but not least, we would mention the case of Hans Schmidt, an American citizen born in Germany. He is the head of a US-based right-wing organization that claims to represent the interests of the German-Americans in the United States. In this capacity he has for many years annoyed numerous prominent persons in Germany with Open Letters. When Schmidt visited Germany in the summer of 1995, he was held in custody, awaiting trial, for more than five months, since one of these Open Letters, in which he had described the German elites as “*infested by Jews and Freemasons*”, allegedly constituted incitement of the people. Schmidt avoided prosecution by fleeing to Florida.<sup>52</sup>

The fact that there is no publicly accessible list of confiscated books makes it difficult in some cases to determine whether or not a confiscation order exists. Sometimes one only learns of confiscations by the various public prosecutors' offices in the course of full-blown criminal investigations. If proceedings are then stopped or abandoned for reasons other than supposed innocence (for example, a legally valid conclusion to the proceedings, lapse, or a consolidation with other proceed-

---

<sup>49</sup> Oberkreisdirektor Herford, ref. 32/33.31.10.

<sup>50</sup> U. Walendy has published a separate issue on his own case: *Historische Tatsachen* no. 69: “*Ausgehebelte Grundrechte*”, and no. 77 “*Vv'-Strafgefangener Walendy*”, Verlag für Volkstum und Zeitgeschichtsforschung, Vlotho/Weser 1996/1999. Of course it is necessary, when reading this work, to distinguish carefully between facts and the author's opinions, which are perforce subjective.

<sup>51</sup> About Germar Rudolf see Wilhelm Schlesiger, *Der Fall Rudolf*, Cromwell Press, London 1994; Herbert Verbeke (ed.), *Kardinalfragen zur Zeitgeschichte*, Vrij Historisch Onderzoek, Berchem 1996. Naturally, the need to distinguish carefully between facts and the subjective opinion of the author(s) applies in this case as well.

<sup>52</sup> Hans Schmidt has also reported on this: *Jailed in “Democratic” Germany. The Ordeal of an American Writer*, Milton/FL: Guderian Books, 1997, 490p. Again, it is necessary to distinguish carefully between facts and the author's subjective opinion. The Australian citizen Dr. Fredrick Toben shared Schmidt's fate in spring 1999 when he traveled to Germany in order to challenge the censorship of the German authorities. He was subsequently arrested and sentenced; see his website at [www.adelaideinstitute.org](http://www.adelaideinstitute.org).

ings, frequently accompanied by the withholding of evidence such as the confiscated books), the legal state of the confiscation proceedings – *i.e.*, with respect to the ‘weapon’, the book – often remains unclear. And quite a few of the censored publishers and authors are not very co-operative, as they do not want to see their case dragged into the public. They fear damage to their reputation, so they stay silent, too. Obviously, the general confusion regarding the law in matters of German book confiscations is a constant uncertainty factor for every publisher, bookseller and book buyer. For this reason a trend towards preventive self-censorship is becoming increasingly manifest in Germany: to avoid the incalculable risk of criminal prosecution, one is less and less inclined to pick up politically or historically hot potatoes which a judiciary might choose to single out as being right-of-center. This silent, hidden censorship is admittedly the most effective and thus the most dangerous one that can be. That in the long term this must bring catastrophic effects on social and political life in Germany seems not to interest anyone.

Now it does not really matter what one thinks of the theses advocated by this group of persons. The fact is that the human right to freedom of speech must be indivisible, as Professor R. Dworkin already put it in *Index on Censorship*.<sup>53</sup> And since none of the cases described here involved any calls to violence, instructions for violent acts, or trivializations of violence – at most, violence is disputed for certain historical events, or portrayed as less than generally usual in other accounts – the harshness with which the German judiciary proceeds against these dissidents is incomprehensible and unjustified.

If the cases described herein affected any other persons or groups, then there would be a worldwide outcry in the press, denouncing such human rights violations. But since the victims are after all only the *right* ones, the matter is ignored and hushed up. But from an objective perspective there is no difference between, for example, Communists and Jehovah’s Witnesses being imprisoned in the Third Reich for their beliefs, and right-wingers and Revisionists being thrown behind bars in the Federal Republic of Germany today for the sake of their publications. Human rights remain human rights. They go for leftist radicals just as for right-wingers.

Considering the results of a more comprehensive, highly recommended study about the deterioration of civil rights in Germany in general,<sup>54</sup> one must conclude that Germany’s tradition of free speech is rather underdeveloped. The general German attitude behind this – ‘tough measures are justified to prevent the repetition of this dark (Third Reich) chapter of our history’ – is understandable, but it is wrong, too, since it leads to the paradox and perverse situation where, in order to prevent the persecution of minorities and the burning of books, minorities are persecuted and books are burned. This is exactly the situation we are facing in Germany today. In light of her history, the only correct position for Germany to take would doubtless be the strict and impartial granting of human rights for everyone – and that is not to suggest that this time they ought to be denied the other side for a change, either. Obviously, where human rights are concerned, Germany is caught in a historical vicious circle, or, to use a different metaphor: the pendulum is swinging wildly from one extreme to the other. It is high time that it came to rest in the middle.

<sup>53</sup> R. Dworkin, “A new map of censorship”, in *Index on Censorship*, 1/2 (1994), pp. 9-15; cf. R. Dworkin, “Forked tongues, faked doctrines”, *ibid.*, no. 3 (1997), pp. 148-151.

<sup>54</sup> G. Rudolf, “Discovering Absurdistan”, *The Revisionist* 1(1) (2003), pp. 203-219 (online: [vho.org/tr/2003/2/Rudolf203-219.html](http://vho.org/tr/2003/2/Rudolf203-219.html)).



# A Brief History of Holocaust Revisionism

WILLIS A. CARTO

I am not the first to point out that every person who sets down history in some measure revises that which has gone before, or there would be no point to his efforts. In the U.S., which is the focus of this essay, the term ‘historical revisionism’ was first used to describe the work of historians after the first World War who debunked the war guilt theory which undergirded the Versailles Treaty, the left-over wartime propaganda that Germany was singularly guilty for that pointless and tragic war. In this effort, Dr. Harry Elmer Barnes was prominent, although not the only historian involved. Thus, it was only natural that the term ‘Holocaust revisionism’ came into use to describe a process that began immediately after the second World War, a process in which Dr. Barnes was involved, although this time, rather quietly, for the peddlers of false history relative to ‘The Holocaust’ – as the extermination tale has come to be known – are far stronger, better organized, fueled by vast quantities of money, and able to stifle the writings and tar the reputation of anyone so foolish as to contradict the extreme thesis that six million Jews were gassed or otherwise dispatched by the National Socialists.

This writer’s education into the credibility of the six million thesis began, when I came across a simple letter to the editor of *Our Sunday Visitor* in the June 14, 1959, issue written by Steven F. Pinter, who claimed to have been in Dachau for 17 months after the war as a U.S. government attorney and said there were no gas chambers there or in any other detention camp in Germany. This simple letter could not outweigh the tons of newsprint and books concerning the Holocaust, of course, but from that time forward I began weighing the evidence on both sides instead of accepting the exterminationist thesis uncritically. I was a potential Holocaust revisionist.

The first writer to seriously debunk the Holocaust, aside from early critics of the Nuremberg War Crimes trials who only mentioned it marginally, was a remarkable Frenchman, Paul Rassinier, a Socialist who had himself been a German wartime detainee, or as they say, ‘concentration camp survivor’. His first two books, *Passing of the Line* and *The Lies of Ulysses*, were published in French in 1948 and 1950, respectively (Editions bressanes, Paris), followed by many more book, perhaps the most famous being *The real Eichmann trial, or the incorrigible vanquishers* and *The Drama of the European Jews*.<sup>1</sup>

In Germany, Dr. Dr. Dr. Franz J. Scheidl started as early as 1945 to write a comprehensive work about *The History of the Defamation of Germany* consisting of eight volumes, four of which were dedicated to the ‘Holocaust’ and other propaganda of WWII.<sup>2</sup> The manuscript was finished in 1950, but because no publisher dared to touch it, the author published a revised version himself as late as 1967.

Meanwhile, in California, a sometime Stanford history professor, Dr. David Hoggan, was working on what became the first book in English on the same subject. Apparently, he began his labors in 1960 and by 1968 had mailed copies of the manuscript to friends and others he knew would be in-

---

For a more comprehensive history of Holocaust revisionism, see Carlo Mattogno, “*The Myth of the Extermination of the Jews: Part II*”, *The Journal of Historical Review*, 8(3) (1988), pp. 261-302; online: [vho.org/GB/Journals/JHR/8/3/Mattogno261-302.html](http://vho.org/GB/Journals/JHR/8/3/Mattogno261-302.html).

<sup>1</sup> *Le Véritable Procès Eichmann ou les vainqueurs incorrigibles / Le Drame des juifs européens*, Les Sept Couleurs, Paris 1962/1964 (online: [abbc.com/aaargh/fran/archRassi/vpe/vpe.html](http://abbc.com/aaargh/fran/archRassi/vpe/vpe.html) and [.../archRassi/dje/dje.html](http://.../archRassi/dje/dje.html)).

<sup>2</sup> *Geschichte der Verfemung Deutschlands*, 8 Vols., published by author, Vienna (partly online: [www.vho.org/D/gdvd\\_2](http://www.vho.org/D/gdvd_2)).

terested. How many copies he sent out is unknown, but it is known that he sent copies to Barnes, Ralph Townsend of Springfield, Virginia, Prof. James J. Martin of Colorado Springs, and Tom Serpico, publisher of Catholic miscellany and historical books in Hawthorne, California. This manuscript, an account of inconsistencies in the Holocaust tale, was written anonymously, although I assume that many persons who received it knew the identity of the author. After he read it, Tom Serpico passed his copy to me.

I reasoned – incorrectly as it was – that the author was probably Barnes, whom I did not at that time know personally. I asked Tom if he was going to publish it and he was not. Being the proprietor of a small publishing house, The Noontide Press, I immediately published it in 1969, citing the author as Anonymous and writing a brief introduction using a pseudonym, E. L. Anderson. To it I appended four short articles that had appeared in *The American Mercury* magazine which I published at the time. One of the articles was by Dr. Austin J. App, titled, “*That Elusive Six Million*”, which had appeared in the Summer 1966 issue of *Mercury*. The volume consisted of 104 pages of the Hoggan manuscript plus the four page introduction and 13 pages of reprints from *Mercury*, including Dr. App’s seminal article. I was genuinely surprised to learn, shortly after the book’s publication of its first printing of 2500 copies, that the real author was David Hoggan.<sup>3</sup>

In 1972 in England, Richard Verral, under the pseudonym of Richard Harwood, brought out the first edition of *Did Six Million Really Die?*<sup>4</sup> Later editions were titled *Six Million Lost and Found*. Largely a republication of Noontide’s *The Myth of the Six Million* in an illustrated 8.5×11 format, with some additions and textual changes by Verral, millions of copies of this ‘new’ edition of the Noontide book have since been circulated (including in tabloid newspaper format edition) and it has been translated into several languages.

In 1973, Thies Christophersen published in German his personal account of Auschwitz entitled *The Auschwitz Lie*.<sup>5</sup> In 1974, it was published in English and has become one of the most widely-distributed documents in the field.

In 1975, Earl W. Thomas of Silver Spring, Maryland, had Barnes translate Rassinier’s *Drama of the European Jews*, added a foreword by Michael Hardesty and published it under Steppingstones Publications. Later, in 1978, with the blessing of Rassinier’s widow and under the imprint of The Noontide Press, I published a library-quality hardbound compilation of Rassinier’s various works under the title, *Debunking the Genocide Myth – A Study of the Nazi Concentration Camps and the Alleged Extermination of European Jewry*.<sup>6</sup>

In 1976, the first edition of Arthur R. Butz’s *The Hoax of the Twentieth Century* appeared in England. In 1978, I published the first American edition of this full-sized, indexed, 315-page, heavily-documented work through The Noontide Press. Later, after I set up the Institute for Historical Review (IHR), the IHR assumed publication of the Butz book. The book was mentioned even in the mainstream press and has gone through ten printings.<sup>7</sup>

In late 1978 and early 1979, Dr. Robert Faurisson, then professor at the University of Lyon, France, published his two famous revisionist articles in the renowned French newspaper *Le Monde*, challenging the gas chamber myth, which caused a major uproar in France.<sup>8</sup>

In 1979, the German Judge Dr. Wilhelm Stäglich published his book *The Auschwitz Myth*, in which he critically analyzed the evidence for the ‘Holocaust’, mainly as presented during the Frank-

---

<sup>3</sup> This book, including all appendices, is available online at: [vho.org/GB/Books/tmotsm](http://vho.org/GB/Books/tmotsm)

<sup>4</sup> Online available at [www.zundelsite.org/english/harwood/Didsix01.html](http://www.zundelsite.org/english/harwood/Didsix01.html)

<sup>5</sup> *Die Auschwitz-Lüge, Kritik* No. 23, Mohrkirch 1973.

<sup>6</sup> Online: [abbc.com/aaargh/engl/RassArch/PRdebunk/PRdebunk1.html](http://abbc.com/aaargh/engl/RassArch/PRdebunk/PRdebunk1.html)

<sup>7</sup> Online partly at: [www.vho.org/GB/Books/thottc](http://www.vho.org/GB/Books/thottc)

<sup>8</sup> *Le Monde*, Dec. 29, 1978, and Jan. 16, 1979.

furt Auschwitz Trial in 1963-1965.<sup>9</sup> This book of high scholarly standards caused a major furor in Germany, leading to its confiscation and burning, the withdrawal of Stäglich's PhD title by the once famous University of Göttingen, and the change of German penalty law to outlaw revisionism.<sup>10</sup>

The year 1979 was a significant year for Holocaust revisionism in general with the sponsorship of the First International Revisionist Conference in Los Angeles, the founding of the IHR, and the preparation of the first issue of *The Journal of Historical Review* (datelined Spring, 1980) and mailed to former subscribers to the *Mercury*, which I suspended at that time to make room for the new publication. Volume One, Number One of the *Journal* was devoted to printing the papers delivered to the 1979 conference by Udo Walendy, Dr. Austin J. App, Louis Fitzgibbon, Dr. Arthur Butz, and Prof. Robert Faurisson.

Between that issue of the quarterly *Journal* and the Winter, 1992 issue were 43 others, all issued on time except for a single issue combining the Summer, Fall and Winter, 1984 issues, a circumstance required by the firebombing and total destruction of the IHR by arsonists on July 4, 1984. At least \$400,000 in book, video and magazine inventory, all internal records including book manuscripts, all equipment and furniture were a total loss.

After this debacle, it was uncertain that the IHR could continue. However, my wife Elisabeth and I decided to attempt another incarnation which, by dint of hard labor and a growing public acceptance of Holocaust revision, became even more successful than before – until October 1993, when the IHR came under the control of others.

During the period beginning with its founding through 1993, in addition to the 45 issues of the *Journal*, the IHR brought out the following books regarding the Holocaust:

- 1979, *Anne Frank's Diary a Hoax*, Ditlieb Felderer;
- 1983, *The Dissolution of Eastern European Jewry*, Walter Sanning (aka Wilhelm Nedereiter);
- 1986, *The Auschwitz Myth*, Judge Wilhelm Stäglich;<sup>11</sup>
- 1987, *No Time for Silence*, Dr. Austin J. App;
- 1989, *The Confessions of Kurt Gerstein*, Henri Roques,

as well as many other books on other aspects of historical revisionism, wartime propaganda and the promotion of piece.

Today, the two primary periodicals in the English language that carry historical revisionism are *The Barnes Review (TBR)*, a 72-page bimonthly of which I am the publisher,<sup>12</sup> and the more scholarly magazine *The Revisionist (TR)*, a 120-pages quarterly of which Germar Rudolf is the publisher.<sup>13</sup> In addition to Holocaust revisionism, both magazines carry forward the tradition of historical revisionism that began after World War I to which it adds revision of all historical subjects from the prehistoric period to contemporary.

As the owner of Theses & Dissertations Press, Germar Rudolf also publishes a series called *HOLOCAUST Handbooks*, of which *Dissecting the Holocaust* was the first issue.<sup>14</sup> In the back of this book, the reader can find detailed information about other books of this series.

<sup>9</sup> *Der Auschwitz-Mythos*, Grabert, Tübingen 1979 (online: vho.org/D/dam).

<sup>10</sup> The so-called "Lex Engelhard" was introduced in 1985; re. Book confiscation, see Wigbert Grabert (ed.), *Geschichtsbetrachtung als Wagnis*, Grabert, Tübingen 1984; re. Withdrawal of PhD-title, see DGG, "Bundesverwaltungsgericht im Dienste der Umerzieher. Erstmalig Doktorgrad aus politischen Gründen aberkannt", DGG 36(3) (1988), p. 18 (online: vho.org/D/DGG/DGG36\_3\_2.html); DGG, "Unglaubliches Urteil im Fall Dr. Stäglich", *ibid.*, 36(1) (1988), p. 7 (online: .../DGG36\_1\_1.html).

<sup>11</sup> Online: codoh.com/trials/tristagintro.sht.

<sup>12</sup> Address: 130 Third Street SE, Washington, D.C., 20003; online: www.barnesreview.org

<sup>13</sup> Address: PO Box 257768, Chicago, IL 60625; online: www.vho.org/tr

<sup>14</sup> For an update on this series, see www.tadp.org.



# Bibliography

## Monographs, Anthologies, and Collections quoted

- Academic American Encyclopedia*, Grolier Inc., Danbury 1991
- Hans G. Adler, Hermann Langbein, Ella Lingens-Reiner (eds.), *Auschwitz – Zeugnisse und Berichte*, Europäische Verlagsanstalt, Cologne 1984
- Hans G. Adler, *Theresienstadt 1941-1945*, Mohr, Tübingen 1955
- Günter Agde, *Sachsenhausen bei Berlin. Speziallager Nr. 7, 1945 – 1950*; Aufbau-Taschenbuch-Verl., Berlin 1994
- Dietrich Aigner, *Die Indizierung "schädlichen und unerwünschten Schrifttums" im Dritten Reich*, vol. XI of the *Archiv für Geschichte des Buchwesens*, Buchhändlervereinigung, Frankfurt/Main 1971
- Reuben Ainsztein, *Jewish Resistance in Nazi-occupied Eastern Europe*, Elek, London 1974
- Akademischer Verein Hütte (ed.), *Hütte*, Ernst und Sohn, Berlin 1942, 1951, 1955
- Alliierte Kriegsverbrechen und Verbrechen gegen die Menschlichkeit* (Allied War Crimes and Crimes Against Humanity), 2<sup>nd</sup> ed., Arndt, Kiel 1997
- American Jewish Yearbook*, New York 1980, Vol. 81
- American Representation of the General Jewish Workers' Union of Poland, *A year in Treblinka*, New York 1944
- Amtliches Material zum Massenmord von Katyn*, Comp. and ed. from documentary evidence, on commission by the Foreign Office, Franz Eher Nachf., Berlin 1943
- Amtliches Material zum Massenmord von Winniza*, Franz. Eher Nachf., Berlin 1944
- Wladyslaw Anders, *The Crimes of Katyn, Facts and Documents*, Polish Cultural Foundation, London 1965
- Anglo-Hebrew Publishing (ed.), *Holocaust Denial: New Nazi Lie or New Inquisition?*, InfoText, London n.d
- Gunther Anntohn, Henri Roques, *Der Fall Günter Deckert*, DAGD/Germania Verlag, Weinheim 1995
- Annual Cremation Conference Report*, Cremation Society of Great Britain, 1975
- Christoph Anstötz, Rainer Hegelmann, Hartmut Kliemt, *Peter Singer in Deutschland: Zur Gefährdung der Diskussionsfreiheit in der Wissenschaft*, Lang, Frankfurt 1995
- Dionisio Anzilotti, *Lehrbuch des Völkerrechts*, 3<sup>rd</sup> ed., trans. by Cornelia Bruns and Karl Schmid, de Gruyter, Berlin 1929
- Atlas samochodowy Polski*, Warsaw/Breslau 1997
- Austin J. App, *No Time for Silence*, Institute for Historical Review, Costa Mesa, CA, 1987
- Yitzhak Arad, *Belzec, Sobibor, Treblinka: The Operation Reinhard Death Camps*, University Press, Bloomington, Indiana 1987
- Jay M. Arena, *Poisoning: Toxicology – Symptoms – Treatments*, C. C. Thomas, Springfield 1979
- Hannah Arendt, *Eichmann in Jerusalem*, Reclam, Leipzig 1990
- Emil Aretz, *Hexen-Einmal-Eins einer Lüge*, Hohe Warte, Pähl 1973
- John A. Armstrong (ed.), *Soviet Partisans in World War II*, University of Wisconsin Press, Madison 1964
- Rudolf Aschenauer, *Macht gegen Recht*, Arbeitsgemeinschaft für Recht und Wirtschaft, Munich 1952
- Rudolf Aschenauer, *Zur Frage einer Revision der Kriegsverbrecherprozesse*, pub. by author, Nuremberg 1949
- Rudolf Aschenauer, *Landsberg. Ein dokumentarischer Bericht von deutscher Sicht*, Arbeitsgemeinschaft für Recht und Wissenschaft, Munich 1951
- Rudolf Aschenauer, *Der Fall Kappler*, Damm-Verlag, Munich 1968
- Rudolf Aschenauer (ed.), *Ich, Adolf Eichmann*, Druffel, Leoni 1980
- Atlas samochodowy Polski*, Warsaw/Breslau 1997
- Y. Auron, *Jewish-Israeli Identity*, Tel Aviv 1993
- Ferdinand Avenarius, *Das Bild als Verleumder*, Callwey, Munich 1916
- Ferdinand Avenarius, *Das Bild als Narr*, Callwey, Munich 1918
- Wolfgang Ayaß, Dietfrid Krause-Vilmar, *Mit Argumente gegen die Holocaust-Leugnung*, Polis-Schriftenreihe der Hessischen Landeszentrale für politische Bildung, Wiesbaden 1996
- Enrique Aynat, *Estudios sobre el 'Holocausto'*, Graficas Hurtado, Valencia 1994
- Enrique Aynat, *Los 'Protocolos de Auschwitz': Une fuente historica?*, García Hispán, Alicante 1990
- E. W. Baader, *Gewerbekrankheiten*, Munich/Berlin 1954
- Roland Baader (ed.), *Die Enkel des Perikles – liberale Positionen und Sozialstaat und Gesellschaft*, v. 2, Resch, Gräfelfing 1995
- Uwe Backes, Eckhardt Jesse, Rainer Zitelmann (eds.), *Die Schatten der Vergangenheit*, Propyläen, Berlin 1992
- James Bacque, *Crimes and Mercies*, Little, Brown & Co., Toronto 1996



- James Bacque, *Other Losses*, Stoddart, Toronto 1989
- John C. Bailar, *Comprehensive Inorganic Chemistry*, Vol. 3, Pergamon Press, Oxford 1973
- Brigitte Bailer-Galanda, Wolfgang Benz, Wolfgang Neugebauer (eds.), *Wahrheit und Auschwitzlüge*, Deuticke, Vienna 1995
- Dantschik Baldajewa, *GULag Zeichnungen*, Zweitausendeins, Frankfurt 1993
- John C. Ball, *Air Photo Evidence*, Ball Resource Services Ltd., Delta, B.C., 1992
- John C. Ball, *Schindler's List – Exposed as Lies and Hate*, Samisdat Publishers, Toronto 1994
- Maurice Bardèche, *Nürnberg oder die Falschmünzer*, Priester, Wiesbaden 1957; Reprint: Verlag für ganzheitliche Forschung und Kultur, Viöl 1992
- Clarence L. Barnhart, Robert K. Barnhart (eds.), *World Book Encyclopedia*, Doubleday, Chicago/London 1980
- Till Bastian, *Auschwitz und die 'Auschwitz-Lüge'. Massenmord und Geschichtsfälschung*, Beck, Munich 1994
- Max Bauer (ed.), Wilhelm G. Soldan-Heppe, *Geschichte der Hexenprozesse*, esp. v. 1, Müller, Munich 1912
- Yehuda Bauer, *Jews for Sale?*, Yale University Press, New Haven 1994
- Bruno Baum, *Widerstand in Auschwitz*, Kongress-Verlag, Berlin (East) 1949, 1957, and 1961
- Fritz Becker, *Im Kampf um Europa*, 2<sup>nd</sup> ed., Leopold Stocker Verlag, Graz/Stuttgart 1993
- Fritz Becker, *Stalins Blutspur durch Europa*, Arndt Verlag, Kiel 1996
- Kurt Behling, *Zeittafel und Materialien zur Frage der während des 2. Weltkrieges im Befehlsbereich Belgien-Nordfrankreich durchgeführten Exekutionen*, Brüssel 1950, Zeittafel
- Michael Behrens, Roberta von Rimscha, 'Politische Korrektheit' in Deutschland. Eine Gefahr für die Demokratie, Bouvier, Bonn 1995
- Wolfgang Behringer (ed.), *Hexen und Hexenprozesse in Deutschland*, dtv, Munich 1988
- Rolf Bender, Susanne Röder, Armin Nack, *Tatsachenfeststellung vor Gericht*, 2 vols., Beck, Munich 1981
- Wilbourn E. Benton, Georg Grimm (eds.), *Nuremberg. German Views of the War Trials*, Southern Methodist UP, Dallas 1955
- Wolfgang Benz (ed.), *Dimension des Völkermords*, Oldenbourg, Munich 1991
- Wolfgang Benz (ed.), *Legenden, Lügen, Vorurteile... Ein Lexikon zur Zeitgeschichte*, dtv, Munich 1990
- Paul Berben, *Dachau. The Official History*, The Norfolk Press, 1975
- Vaclav Berdych, *Mauthausen*, Nase Vojsko, Prague 1959
- Heinz Bergschicker, *Der Zweite Weltkrieg*, Deutscher Militärverlag, Berlin (East) 1964
- Giuseppe Bettioli, *Diritto penale, parte generale*, 2<sup>nd</sup> ed., Driulla, Palermo 1950
- Emil Beutinger, *Handbuch der Feuerbestattung*, Carl Scholtze, Leipzig 1911
- Wilhelm R. Beyer (ed.), *Rückkehr unerwünscht*, dtv, Munich 1980
- Jadwiga Bezwinska, Danuta Czech, *Auschwitz in den Augen der SS*, 3<sup>rd</sup> ed., Krajowa Agencja Wydawnictwa, Katowice 1981
- Bieler Feuerbestattungs-Genossenschaft in Biel (Switzerland) (ed.), *Jahresbericht pro 1933*, Biel 1934
- Bieler Feuerbestattungs-Genossenschaft in Biel (Switzerland) (ed.), *Jahresbericht pro 1927-28*, Biel 1929
- Joseph Billig, *Les camps de concentration dans l'économie du Reich hitlérien*, Presses Universitaires de France, Paris 1973
- Erich Bischoff, *Das Buch vom Schulchan aruch*, Hammer Verlag, Leipzig 1929
- G. Bischof, S. E. Ambrose (ed.), *Eisenhower and the German POWs: Facts against falsehood*, Louisiana State University, Baton Rouge 1992
- David F. Bjorklund (ed.), *False-Memory Creation in Children and Adults*, Lawrence Erlbaum Ass., Mahwah, NJ, 2000
- Benjamin Blech, *The Secret of Hebrew Words*, Jason Aronson, Northvale, NJ, 1991
- Sam E. Bloch, *Holocaust and Rebirth: Surviving Bergen Belsen*, Holocaust Library, New York 1972
- Johann C. Bluntschli, *Das moderne Völkerrecht*, 3<sup>rd</sup> ed., Beck, Nördlingen 1878
- Heinz Boberach, Institut für Zeitgeschichte (ed.), *Inventararchivalische Quellen des NS-Staates*, 2 vols., ed. by IfZ, K.G. Saur, Munich 1991 and 1995
- Wladimir Bobrenjow, Waleri Rjasanzwe, *Das Geheimlabor des KGB*, edition q, Berlin 1993
- Hans-Kurt Boehlke, *Friedhofsbauten*, Callwey Verlag, Munich 1974
- Roland Bohlinger (ed.), *Die Stellungnahme der Leitung der Gedenkstätte Haus der Wannsee-Konferenz zu dem von Bohlinger und Ney verfaßten Gutachten zur Frage der Echtheit des sogenannten Wannsee-Protokolls und der dazugehörigen Schriftstücke*, Verlag für ganzheitliche Forschung, Viöl 1995
- Roland Bohlinger, Johannes P. Ney, *Zur Frage der Echtheit des Wannsee-Protokolls*, 2<sup>nd</sup> ed., Verlag für ganzheitliche Forschung und Kultur, Viöl 1992, 1994
- Jean-Marie Boisdefeu, *La controvers sur L'extermination des Juifs par les Allemands*, vol. 1, V.H.O., Berchem 1994
- Jean-Marie Boisdefeu, Enrique Aynat, *Estudios sobre Auschwitz*, publ. by E. Aynat, Valencia 1997
- Bolschaja Sowjetskaja Enzyklopedia*, Moscow 1950, v. 4; 1970

- Emmi Bonhoeffer, *Zeugen im Auschwitz-Prozeß*, Kiefel, Wuppertal 1965
- Horst Boog et al., *Das Deutsche Reich und der Zweite Weltkrieg*, vol. 4: *Der Angriff auf die Sowjetunion*, 2<sup>nd</sup> ed., Deutsche Verlags-Anstalt, Stuttgart 1987
- Wolfgang de Boor, *Wahn und Wirklichkeit. Psychiatrische Grenzfälle vor Gericht*, Verlag C. H. Beck, München 1997
- Ugo Bordoni, *Trattato generale teorico pratico dell'arte dell'ingegnere civile, industriale ed architetto*, Casa Editrice Dottor Francesco Vallardi, Milan n.d.
- Henri Bour, Ian McA. Ledingham, *Carbon Monoxide Poisoning*, Elsevier, Amsterdam 1967
- William Braker, Allen L. Mossman, *Effects of Exposure to Toxic Gases*, Matheson Gas Products, East Rutherford 1970; with Daniel Siegel, Lynhurst, N.J., 1977
- W. Braker, A. L. Mossman, *Matheson Gas Data Book*, Matheson Gas Products, East Rutherford 1971
- Britannica Book of the Year*, Encyclopedia Britannica Inc., Chicago, editions 1986-1995
- Der große Brockhaus*, encyclopedia, vol. 6, Leipzig 1930
- Brockhaus Enzyklopädie*, Wiesbaden 1967, 1970 & 1987
- Dietrich Bronder, *Bevor Hitler kam*, 2<sup>nd</sup> ed., Marva, Genf 1975
- Martin Broszat (ed.), *Kommandant in Auschwitz*, dtv, Munich 1981, 1983
- Martin Broszat, *Studien zur Geschichte der Konzentrationslager*, Schriftenreihe der Vierteljahrshefte für Zeitgeschichte, No. 21, Stuttgart 1970
- D. Brugnioni, *Photo Fakery: The History and Techniques of Photographic Deception and Manipulation*, Brassey's, Washington, D.C., 1999
- Dino A. Brugnioni, Robert Poirer, *The Holocaust Revisited: A Retrospective Analysis of the Auschwitz-Birkenau Extermination Complex*, Central Intelligence Agency, Washington 1979
- Hans Buchheim, Martin Broszat, Hans-Adolf Jacobsen, Helmut Krausnick, *Anatomie des SS-Staates*, 2 vols., Walter Verlag, Freiburg 1964
- Bundesamt für Verfassungsschutz (ed.), *Verfassungsschutz in der Demokratie*, Carl Heymanns Verlag, Cologne 1990
- Bundesministerium des Inneren (ed.), *Bundesverfassungsschutzbericht*, Bundesdruckerei, Bonn 1995-1998
- Bundesprüfstelle für jugendgefährdende Schriften (BPjS) (ed.), *Gesamtverzeichnis indizierter Bücher, Taschenbücher, Broschüren und Comics, Stand 30.4.1993*, BPjS, Bonn 1993
- Josef G. Burg, *NS-Prozesse des schlechten Gewissens*, G. Fischer, Munich 1968
- Josef G. Burg, *Schuld und Schicksal*, Damm, Munich 1962
- Josef G. Burg, *Zionnazi Zensur in der BRD*, Ederer, Munich 1980
- Antonio S. de Bustamente Sirven, *Droit international public*, v. 1, Recueil Sirey, Paris 1934
- Jozef Buszko, *Auschwitz. Geschichte und Wirklichkeit des Vernichtungslagers*, Rowohlt, Reinbek 1980
- Jozef Buszko (ed.), *Auschwitz, Nazi Extermination Camp*, Interpress Pub., Warsaw 1985
- Rupert Butler, *Legions of Death*, Arrow Books Ltd., London 1986
- Arthur R. Butz, *The Hoax of the Twentieth Century. The Case against the presumed extermination of European Jewry*, Historical Review Press, Brighton 1977 / Institute for Historical Review, Torrance, CA, 1985
- Martin Caidin, *The Night Hamburg Died*, Ballantine Books, New York 1960
- Francies E. Camps, *Medical and Scientific Investigations in the Christie Case*, Medical Publications Ltd., London 1953
- Louis Cavaré, *Le droit international publique positif*, v. 1, Pichon et Durand-Auzias, Paris 1951
- Stephen Challen, *Richard Korherr and his Reports*, Cromwell Press, London 1993
- Thies Christophersen, "Die Auschwitz-Lüge", *Kritik* issue no. 23, Kritik Verlag, Mohrkirch 1973; reprint Vrij Historisch Onderzoek, Berchem 1999
- Winston L. Churchill, *The World in Crisis*, vol. 5: *The Aftermath*, T. Butterworth, London 1929
- A. de Cocatrix, *Die Zahl der Opfer der nationalsozialistischen Verfolgung*, International Tracing Service/ICRC, Arolsen 1977
- G. Colombo, *Manuale dell'ingegnere* (Engineer's Handbook), 82<sup>nd</sup> ed., Heopli, Milano
- Comer Clarke, *Eichmann – The Man and His Crimes*, Ballantine Books, New York 1960
- Colloque de l'Ecole des Hautes Etudes en sciences sociales (ed.), *L'Allemagne nazie et le genocide juif*, Gallimard and Le Seuil, Paris 1985
- Comité international de la croix rouge, *Les conventions de Genève du 12 août 1949*, Geneva 1949
- F.H. Comtesse, *Das Schweizerische Militärstrafgesetzbuch*, Schulthess, Zürich 1946
- Cyril Connolly (ed.), *The Golden Horizon*, Weidenfeld & Nicolson, London 1953, pp. 109f
- Robert Conquest, *The Harvest of Sorrow*, Oxford University Press, Oxford / New York 1986
- Karl Corino (ed.), *Gefälscht!*, Rowohlt, Reinbek 1992
- Stéphan Courtois, *Qui savait quoi? L'extermination des juifs 1941-1944*, Editions la Découverte, Paris 1987
- Malachia de Cristoforis, *Etude pratique sur la crémation*, Imprimerie Treves Frères, Milan 1890
- Collin Cross, *Adolf Hitler*, Hodder and Stoughton, London 1973

- Danuta Czech (ed.), *Auschwitz Chronicle, 1939-1945*, Henry Holt, New York 1989
- Danuta Czech (ed.), *Auschwitz Chronicle: 1939-1945*, I.B. Tauris, London/New York 1990
- Danuta Czech, *Kalendarium der Ereignisse im Konzentrationslager Auschwitz-Birkenau 1939-1945*, Rowohlt, Reinbek 1989
- W. Czernin, *Zementchemie für Bauingenieure*, Bauverlag, Wiesbaden 1977
- Maximilian Czesany, *Europa im Bombenkrieg 1939-1945*, Leopold Stocker, Wien 1998
- J. Dassié, *Manuel d'archéologie aérienne*, Editions Technique, Paris 1978
- Max Daunderer, *Klinische Toxikologie*, collection of supplements, ecomed, Landsberg 1987f
- W.J.L. Davies, *German Army Handbook*, Arco Publishing, New York 1973 and 1981 / Allan, London 1973
- Lucy S. Dawidowicz, *The Holocaust and the Historians*, Harvard UP, Cambridge, Mass., 1981
- DEGESCH, *Acht Vorträge aus dem Arbeitsgebiet der DEGESCH*, 1942
- Ebbo Demant (ed.), *Auschwitz – 'Direkt von der Rampe weg...'*, Rowohlt, Reinbek 1979
- Helmut Denning (ed.), *Lehrbuch der Inneren Medizin*, 6<sup>th</sup> ed., Thieme, Stuttgart 1964
- Gerhard Detlefs, *Die Pervertierung der Meinungsfreiheit*, Hohenrain, Tübingen 1995
- Leo Deuel, *Flug ins Gestern – Das Abenteuer der Luftbildarchäologie*, Deutscher Taschenbuch Verlag, Munich 1981
- Deutschen Verwaltung für Volksbildung in der sowjetischen Besatzungszone (ed.), *Liste der auszusondernden Literatur*, 3 vols., Zentralverlag, Berlin (East) 1946, 1947, 1948; facsimile reprint, Uwe Berg-Verlag, Toppstedt 1983
- Deutscher Bundestag, Press- und Informationszentrum (ed.), *Zur Verjährung nationalsozialistischer Verbrechen*, Zur Sache vol. 3-5/80, Bonn 1980
- Deutscher Rechtsschutzzkreis (ed.), *Zur Problematik der Prozesse um 'Nationalsozialistische Gewaltverbrechen'*, Schriftenreihe zur Geschichte und Entwicklung des Rechts im politischen Bereich, issue 3, Bochum 1982
- Deutsch-russisches Wörterbuch, Sowjetische Enzyklopädie*, Moscow 1971
- Hellmut Diwald, *Deutschland einig Vaterland*, Ullstein, Frankfurt/Main 1990
- Dokumentation zur Massenvergasung*, Bundeszentrale für Heimatdienst, Bonn 1962
- Dokumentationszentrum des österreichischen Widerstandes, Bundesministerium für Unterricht und Kultur (ed.), *Amoklauf gegen die Wirklichkeit*, Vienna 1991
- Alexander Donat (ed.), *The Death Camp Treblinka*, Holocaust Library, New York 1979
- Milo Dor, Reinhard Federmann, *Das Gesicht unseres Jahrhunderts*, Econ, Düsseldorf 1960
- John W. Dower, *War without Mercy*, Pantheon Books, New York 1986
- Eduard Dreher, Herbert Tröndle (eds.), *Strafgesetzbuch*, 47<sup>th</sup> ed., Beck, Munich 1995
- Heinrich Drost, *Grundlagen des Völkerrechts*, Duncker und Humblot, Munich and Leipzig 1936
- DuPont, *Hydrogen Cyanide*, Wilmington, Delaware 7/83
- Erik Eckermann, *Alte Technik mit Zukunft: Die Entwicklung des Imbert-Generators*, Oldenbourg, Munich 1986
- Sterling E. Edmunds, *The lawless law of nations*, J. Byrne, Washington, D.C., 1925
- Sterling E. Edmunds, *Das Völkerrecht, ein Pseudorecht*, de Gruyter, Berlin 1933
- Ilya Ehrenburg, V. Grossman (eds.), *The Black Book*, Holocaust Library, New York 1980
- Rolf-Josef Eibicht (ed.), *Hellmut Diwald. Sein Vermächtnis für Deutschland. Sein Mut zur Geschichte*, (ed.), Hohenrain, Tübingen 1994
- Rolf-Josef Eibicht, *Unterdrückung und Verfolgung Deutscher Patrioten. Gesinnungsdiktatur in Deutschland?*, Hutten Verlag, Viöl 1997
- Sergei Einstein, *Eichmann – Chefbuchhalter des Todes*, Röderberg, Frankfurt/Main 1961
- Artur Eisenbach (ed.), *Kronika getta warszawskiego*, Czytelnik, Warsaw 1983
- Wolfgang Eisert, *Die Waldheimer Prozesse*, Bechtle, Munich 1993
- Enciclopedia Europea*, Garzanti, Rome 1976
- Enciclopedia Universal Nautea*, Ediciones Nauta, Madrid 1977
- Encyclopaedia Britannica*, Chicago, editions from 1945 to 1984
- Encyclopaedia Judaica*, Keter Pub. Ltd., Jerusalem, and Macmillan, New York 1971
- Encyclopedia of Ukraine*, University of Toronto Press, Toronto 1988
- Encyclopedia of Ukraine*, Shevchenko Scientific Society, Paris / New York 1955
- Encyklopaedia Judaica*, Jerusalem 1972
- Karl von Engerth, *Die Feuerbestattung*, self-pub. by author, Vienna 1897
- Karl von Engerth, *Fortschritte der Feuerbestattung in Deutschland. Vortrag gehalten in der Hauptversammlung des Vereins der Freunde der Feuerbestattung 'Die Flamme' in Wien am 19. Februar 1892*, Verlag von Moritz Perles, Vienna 1892
- Oberkommando der Wehrmacht (ed.), *Entseuchungs- und Entwesungsvorschrift für die Wehrmacht*, H. Dv. 194, M. Dv. 277, L. Dv. 416, Reichsdruckerei, Berlin 1939

- Alexander E. Epifanow, Hein Mayer, *Die Tragödie der deutschen Kriegsgefangenen in Stalingrad von 1942 bis 1956 nach russischen Archivunterlagen*, Biblio, Osnabrück 1996
- Erhabener Ideengehalt und künstlerische Meisterschaft – Die große Kraft sowjetischer Literatur und Kunst*, Moscow, March 8, 1963
- Helmut Eschwege (ed.), *Kennzeichen 'J'*, Deutscher Verlag der Wissenschaften, Berlin (East) 1981
- Hugo Etzbach, *Der technische Vorgang bei einer Feuerbestattung*, Druck Johannes Friese, Cologne 1935
- Lawrence T. Fairhall, *Industrial Toxicology*, Williams & Wilkins, Baltimore 1957
- Jürgen Falbe, Manfred Regitz (eds.), *Römpp Chemie Lexikon*, v. 5, Thieme, Stuttgart 1992
- Paul Fauchille, *Traité de droit international publique*, Tome II, 8<sup>th</sup> ed., Rousseau, Paris 1921
- Robert Faurisson, *'Es gab keine Gaskammern'*, Deutscher Arbeitskreis Witten, Witten 1978
- Robert Faurisson, *Mémoire en Défense*, La Vieille Taupe, Paris 1980
- Robert Faurisson, *Réponse à Jean-Claude Pressac*, R.H.R., Colombes Cedex 1994
- Robert Faurisson, *Réponse à Pierre Vidal-Naquet*, La Vieille Taupe, Paris 1982
- Jean-Claude Favez, *Das IKRK und das Dritte Reich. War der Holocaust aufzuhalten?*, Verlag Neue Zürcher Zeitung, Zürich 1989
- Wilfried Feldenkirchen, *Siemens 1918-1945*, R. Piper GmbH & Co. KG, Munich 1995
- Ditlieb Felderer, *Anne Frank's Diary a Hoax*, Institute for Historical Review, Torrance, CA, 1979
- Horst Ferch, Hans Schäfer, *Schriftenreihe Pigmente*, 77, Degussa AG, Frankfurt 1990
- G. Ferrari, *Guida all'educazione alimentare* (guide to nutrition education), v. 2, Sovene Editoriale, Rome 1960
- Joachim C. Fest, *Hitler*, Vintage Books, New York 1975
- Heinz Fiebelkorn, *Behandlung und Instandsetzung von Fahrzeug-Gaserzeugeranlagen*, W. Knapp, Halle 1944; 2<sup>nd</sup> ed. *ibid.*, 1948
- Norman G. Finkelstein, *The Holocaust Industry: Reflections on the Exploitation of Jewish Suffering*, Verso, London/New York 2000
- Norman G. Finkelstein, Ruth Bettina Birn, *A Nation on Trial: The Goldhagen Thesis and Historical Truth*, Metropolitan Books, New York 1998
- Jörg Fisch, *Reparationen*, C. H. Beck, Munich 1992
- Egon W. Fleck and Edward A. Tenenbaum, *Buchenwald: A Preliminary Report*, U.S. Army, 12th Army Group, 24 April 1945
- Gerald Fleming, *Hitler und die Endlösung*, Limes, Wiesbaden 1982
- Ferdinand Flury, Franz Zernik, *Schädliche Gase, Dämpfe, Nebel, Rauch- und Staubarten*, Springer, Berlin 1931
- Foreign Relations of the United States, Diplomatic Papers*, US Printing Office, Washington 1963, vol.1 of 1943
- Karl Forster (ed.), *Möglichkeiten und Grenzen für die Bewältigung historischer und politischer Schuld in Strafprozessen*, Studien und Berichte der katholischen Akademie in Bayern, no. 19, Echter-Verlag, Würzburg 1962
- Wolfgang Forth, Dieter Henschler, Werner Rummel, *Allgemeine und spezielle Pharmakologie und Toxikologie*, 5<sup>th</sup> ed., Wissenschaftsverlag, Mannheim 1987
- Wolfgang Forth, Dieter Henschler, Werner Rummel, K. Starke, *Allgemeine und spezielle Pharmakologie und Toxikologie*, 6<sup>th</sup> ed., Wissenschaftsverlag, Mannheim 1992
- Reinhard Frank, *Lastkraftwagen der Wehrmacht*, Podzun-Pallas, Friedberg 1992
- Reinhard Frank, *Strafgesetzbuch*, 18<sup>th</sup> ed., Mohr, Tübingen 1931
- Georg Franz-Willing, *Umerziehung*, Nation Europa, Coburg 1991
- Französisches Büro des Informationsdienstes über Kriegsverbrechen (ed.), *Konzentrationslager Dokument 321*, Reprint 2001, Frankfurt/Main 1993
- Freiheitliche Akademie der FPÖ (ed.), *Freiheit und Verantwortung*, Jahrbuch, publ. by ed., Vienna 1995
- Gerhard Frey (ed.), *Vorsicht Fälschung*, FZ-Verlag, Munich 1991
- Saul Friedländer, *Counterfeit Nazi: The Ambiguity of Good*, Weidenfeld and Nicolson, London 1967
- Saul Friedländer, *Nazi Germany and the Jews*, v. 1: *The Years of Persecution*, Harper & Collins, New York 1997
- Filip Friedman, *This Was Oswiecim. The Story of a Murder Camp*, United Jewish Relief Appeal, London 1946
- Evyatar Friesel, *Atlas of Modern Jewish History*, Oxford Univ. Press, Oxford 1990
- Theodor Fritsch, *Handbuch zur Judenfrage*, 31<sup>st</sup> ed., Hammer-Verlag, Leipzig 1932
- Galasso, [Gaetano?] Sucato, *Codici penali militari di pace e di guerra*, 2<sup>nd</sup> ed., Roma 1941
- Roger Garaudy, *Les mythes fondateurs de la politique israélienne*, La Vieille Taupe, Paris 1995
- Roger Garaudy, *The Founding Myths of Modern Israel*, Institute for Historical Review, Costa Mesa, CA, 2000
- James F. Garner, *Politically Correct Bedtime Stories*, Macmillan, New York/Souvenir Press, London 1994
- Manfred Gärtner, Werner Rademacher, *Zur Entstehungsgeschichte des Kriegsgefangenenlagers Auschwitz-Birkenau*, to be published
- Ernst Gauss (ed.), *Dissecting the Holocaust*. Theses & Dissertations Press, Capshaw, Alabama, 2000

- Ernst Gauss (ed.), *Grundlagen zur Zeitgeschichte*, Grabert, Tübingen 1994
- Ernst Gauss, *Vorlesungen über Zeitgeschichte*, Grabert, Tübingen 1993
- Immanuel Geiss, *Der Hysterikerstreit*, Bouvier, Bonn 1992
- George St. George, *The Road To Baby-Yar*, Spearman, London 1967
- Rüdiger Gerhard (ed.), *Der Fall Gottfried Weise*, 2<sup>nd</sup> ed., Türmer, Berg 1991
- Heinrich B. Gerland, *Deutsches Reichsstrafrecht*, 2<sup>nd</sup> ed., de Gruyter, Berlin and Leipzig 1932
- Gesellschaft für freie Publizistik, *Das Siegertribunal*, Nation Europa, Coburg 1976
- Jon Gheorge, *Automatic Arrest*, Druffel, Leoni 1956
- Martin Gilbert, *The Holocaust*, Holt, Rinehart and Winston, New York 1986
- Richard Glazar, *Die Falle mit dem grünen Zaun*, Fischer, Frankfurt/Main 1992
- Wenzelslaus K. M. M. von Gleispach, *Das Kriegsstrafrecht*, Teil II, Kohlhammer, Berlin/Stuttgart 1940
- Główna Komisja Badania Zbrodni Hitlerowskich w Polsce, *Obozy hitlerowskie na ziemiach polskich 1939-1945. Informator encyklopedyczny*. Państwowe Wydawnictwo Naukowe, Warsaw 1979
- Sheldon Glueck, *War Criminals, Their Prosecution and Punishment*, A. A. Knopf, New York 1944
- Daniel J. Goldhagen, *Hitlers willige Vollstrecker. Ganz gewöhnliche Deutsche und der Holocaust*, Siedler, Berlin 1996
- Daniel J. Goldhagen, *Hitler's Willing Executioners*, Little, Brown & Co., New York 1996
- Doris A. Graber, *The development of the law of belligerent occupation, 1863-1914*, Columbia University Press, New York 1949
- Wigbert Grabert (ed.), *Geschichtsbetrachtung als Wagnis*, Grabert, Tübingen 1984
- Helge Grabitz, *NS-Prozesse – Psychogramme der Beteiligten*, C. F. Müller, Heidelberg 1986
- Jürgen Graf, *Auschwitz. Tätergeständnisse und Augenzeugen des Holocaust*, Verlag Neue Visionen, Würenlos (Switzerland) 1994
- Jürgen Graf, *The Giant With Feet of Clay. Raul Hilberg and his Standard Work on the "Holocaust"*, Theses & Dissertations Press, Capshaw, AL, 2001 (online: [vho.org/GB/Books/Giant](http://vho.org/GB/Books/Giant))
- Jürgen Graf, Carlo Mattogno, *Concentration Camp Majdanek. A Historical and Technical Study*, Theses & Dissertations Press, Chicago, IL, 2003
- Jürgen Graf, Carlo Mattogno, *Concentration Camp Stutthof and its Function in National Socialist Jewish Policy*, Theses & Dissertations Press, Chicago, IL, 2003
- Jürgen Graf, Carlo Mattogno, *Das Konzentrationslager Stutthof und seine Funktion in der nationalsozialistischen Judenpolitik*, Castle Hill Publishers, Hastings 1999
- Jürgen Graf, Carlo Mattogno, *KL Majdanek. Ein historische und technische Studie*, Castle Hill Publisher, Hastings 1998
- James D. P. Graham, *The Diagnosis and Treatment of Acute Poisoning*, Oxford UP, London 1962
- Hermann Graml, *Der 9. November 1938. 'Reichskristallnacht'*, 4<sup>th</sup> ed., Schriftenreihe der Bundeszentrale für Heimatdienst, issue 4, Bundeszentrale für Heimatdienst, Bonn 1956
- Grand Larousse Encyclopédique*, Librairie Larousse, Paris / New York 1960
- Lothar Greil, *Oberst der Waffen-SS Jochen Peiper und der Malmedy-Prozeß*, Schild, Munich 1977
- Pjotr Grigorenko, *Erinnerungen*, Bertelsmann, Munich 1981
- Alfred Grosser, *Ermordung der Menschheit*, Hanser, Munich 1990
- Vassily Grossman, *Die Hölle von Treblinka*, Foreign Language Publication House, Moscow 1947
- Vassily Grossman, *Die Vernichtungslager Majdanek und Treblinka*, Stern Verlag, Vienna 1945
- Elżbeta Grot, *Rejs Śmierci*, Muzeum Stutthof w Sztutowie, Danzig 1993
- Aage Grut, *Chronic Carbon Monoxide Poisoning*, Ejnar Munksgaard, Copenhagen 1949
- Paul Guggenheim, *Lehrbuch des Völkerrechts*, v. 1, Verlag für Recht und Gesellschaft, Basel 1948
- W. Gumz, J. F. Foster (Battelle Memorial Institute), *A Critical Survey of Methods of Making a High BTU Gas from Coal*, *Research Bull. No. 6*, American Gas Association, New York 1953
- Yisrael Gutman, Michael Berenbaum (eds.), *Anatomy of the Auschwitz Death Camp*, Indiana University Press, Bloomington 1994
- G. Gysecke, *Der Fall Priebke*, Verlagsgesellschaft Berg, Berg am Starnberger See 1997
- F. E. Haag, *Lagerhygiene, Taschenbuch des Truppenarztes*, v. VI, F. Lehmanns Verlag, Munich 1943
- Gerd Habermann, *Der Wohlfahrtsstaat. Geschichte eines Irrwegs*, Ullstein, Berlin 1994
- Green H. Hackworth, *Digest of international law*, vol. I, U.S. Government Printing Office, Washington 1940
- Carl Haensel, *Der Nürnberger Prozeß*, Moewig, Munich 1983
- Ernst Hafer, *Die gesetzliche Regelung des Generatoren- und Festkraftstoff-Einsatzes im Großdeutschen Reich*, J. Kasper & Co., Berlin 1943
- John S. Haldane, J. G. Priestley, *Respiration*, Yale UP, New Haven 1935
- Joseph Halow, *Siegerjustiz in Dachau*, Druffel, Leoni 1993
- Hamburger Institut für Sozialforschung (ed.), *Die Auschwitz-Hefte*, Beltz Verlag, Weinheim 1987

- Hamburger Institut für Sozialforschung (ed.), *Vernichtungskrieg. Verbrechen der Wehrmacht 1941 bis 1944*, Hamburger Edition, Hamburg 1996
- Hammer, Salvin, *Taking of hostages*, 1944
- Handbook of Modern Irregular Warfare*, [London?]
- Maurice P. A. Hankey, *Politics, trials and errors*, Pen-in-Hand, Oxford 1950
- Heinrich Härtle, *Freispruch für Deutschland*, Schütz, Göttingen 1965
- Richard Harwood, *Did Six Million Really Die? Historical Fact No. 1*, Samisdat Publishers, Toronto n.d
- Julius Hatschek, *Völkerrecht*, Deichert, Leipzig and Erlangen 1923
- F. A. Hayek, *The Political Ideal of the Rule of Law*, National Bank of Egypt, Cairo 1955
- Wilhelm Heepke, *Die Kadaver-Vernichtungsanlage*, Verlag von Carl Marhold, Halle a. S. 1905
- Wilhelm Heepke, *Die Leichenverbrennungsanstalten (die Krematorien)*, Verlag von Carl Marhold, Halle a.S. 1905
- Johanns Heer, Klaus Naumann (ed.), *Verbrechen der Wehrmacht 1941-1944*, Hamburger Edition, Hamburg 1995
- Kurt Heinze, Karl Schilling, *Die Rechtsprechung der Nürnberger Militärtribunale*, Girardet, Bonn 1952
- Yandell Henderson, Howard W. Haggard, *Noxious Gases*, Reinhold Publishing, New York 1943
- Heinrich Henkel, *Der Notstand nach gegenwärtigem und künftigem Recht*, Beck, Munich 1932
- Reinhard Henkys, *Die NS-Gewaltverbrechen*, Kreuz, Stuttgart 1964
- Georges Hénocque, *Les Antres de la bête*, G. Duraissie, Paris 1947
- Erich Hesse, *Der sowjetrussische Partisanenkrieg 1941-1944 im Spiegel deutscher Kampfanweisungen und Befehle*, 2<sup>nd</sup> ed., Muster-Schmidt, Göttingen 1992
- John B. Heywood, *Internal Combustion Engine Fundamentals*, McGraw-Hill, 1988
- Joseph Hiess, *Glaserbach*, Welsermühl, Wels 1956
- Raul Hilberg, *Die Vernichtung der europäischen Juden*, Olle & Wolter, Berlin 1982 / Fischer Taschenbuch Verlag, Frankfurt 1997
- Raul Hilberg, *The Destruction of the European Jews*, Quadrangle Books, Chicago 1961; 2<sup>nd</sup> ed., *ibid.*, 1967; 3<sup>rd</sup> ed., Holmes & Meier, New York 1973; 4<sup>th</sup> ed., *ibid.*, 1985
- Francis. H. Hinsley, *British Intelligence in the Second World War*, v. II, Her Majesty's Stationary Office, London 1981
- Rudolf Hirsch, *Um die Endlösung*, Greifenverlag, Rudolstadt 1982
- Joachim Hoffmann, *Stalin's War of Extermination 1941 – 1945*, Theses & Dissertations Press, Capshaw, AL, 2001
- David L. Hoggan, *The Myth of the Six Million*, Noontide Press, Los Angeles 1969
- Heinz Höhne, *Der Orden unter dem Totenkopf*, Bertelsmann, Munich 1976
- Heinz Höhne, *Gebt mir vier Jahre Zeit*, Ullstein, Berlin 1996
- John C. Holtz, *Safety with mobile Diesel-powered equipment underground, Report of Investigations No. 5616*, U. S. Department of the Interior, Bureau of Mines, Washington 1960
- John C. Holtze, R. W. Dalzell, "Diesel Exhaust Contamination of Tunnel Air", U. S. Department of the Interior, Bureau of Mines, Washington 1968
- Helmut R. Hoppe, *Die Geiselschaft, ihre Entwicklung und Bedeutung*, dissertation, Göttingen 1953
- Wilhelm Höttl, *Einsatz für das Reich*, S. Bublies, Koblenz 1997
- Walther Hubatsch, *Die deutsche Besetzung von Dänemark und Norwegen 1940*, Musterschmidt, Göttingen 1952
- Ernst R. Huber, *Das Verfassungsrecht des Großdeutschen Reiches*, Hanseatische Verlagsanstalt, Hamburg 1939
- D. Humenna, *Kreshchaty Yar*, Association of Ukrainian Authors and Journalists, New York 1956
- Charles C.Hyde, *International Law*, v. I, Boston 1947 (1<sup>st</sup> ed. Little, Brown & Co., Boston 1922)
- Institut für Zeitgeschichte (ed.), *Gutachten des Instituts für Zeitgeschichte*, v. 1, pub. by ed., Munich 1958
- Institute of Jewish Affairs (ed.), *Hitler's Ten Year War*, New York 1943
- Instytut Technicki Ciepłej, *Ekspertyza dotycząca konstrukcji i przeznaczenia pieców zainstalowanych przy komorach gazowch w Obozie na Majdanku w Lublinie*, Lodz 1968
- International Military Tribunal, *Trial of the Major War Criminals*, IMT, 42 vols., Nuremberg 1947; photomechanical reprint: Delphin, Munich 1984
- Internationale Föderation der Widerstandskämpfer (ed.), *Die SS-Henker und ihre Opfer*, self-pub., Vienna 1965
- David Irving, *Der Nürnberger Prozeß*, 2<sup>nd</sup> ed., Heyne, Munich 1979
- David Irving, *Die geheimen Tagebücher. Der unbekannt Dr. Goebbels*, Focal Point, London 1995
- David Irving, *Goebbels. Mastermind of the Third Reich*, Focal Point, London 1996
- David Irving, *Hitler's War*, Hodder & Stoughton, London 1977
- David Irving, *Hitler's War*, Focal Point, London 1991
- David Irving, *Nuremberg. The Last Battle*, Focal Point, London 1996
- David Irving, *Und Deutschlands Städte starben nicht*, Schweizer Verlagshaus, Zürich 1967; Weltbild Verlag, Augsburg 1989
- A. Izzo, *Guerra Chimica e Difesa Antigas*, Editore Ulrico Hoepli, Milan 1935

- Eberhard Jäckel, Peter Longerich, Julius H. Schoeps (eds.), *Enzyklopädie des Holocaust*, Argon, Berlin 1993
- Eberhard Jäckel, Jürgen Rohwer (eds.), *Der Mord an den Juden im Zweiten Weltkrieg*, Deutsche Verlags-Anstalt, Stuttgart 1985
- Robert H. Jackson, *Staat und Moral*, Nymphenburger Verlagshandlung, Munich 1946
- Hans-Adolf Jacobsen, Hans Dollinger (eds.), *Der Zweite Weltkrieg in Bildern und Dokumenten*, v. I, Desch, Munich 1952
- Peter Schneider, Hermann J. Meyer (eds.), *Rechtliche und politische Aspekte der NS-Verbrecherprozesse*, Johannes Gutenberg-Universität, Mainz 1966
- Herbert Jäger, *Verbrechen unter totalitärer Herrschaft*, Walter-Verlag, Olten 1966
- Jahrbuch des Verbandes der Feuerungsbestattungs-Vereine Deutscher Sprache*, Vol. IV., 1928. Pub. on the occasion of the 22<sup>nd</sup> Association Conference on July 4-8 in Bremen, by the Association Board, Königsberg/Prussia 1928
- Alain Jaubert, *Fotos, die lügen*, Athenäum, Frankfurt/Main 1989
- Sepp Jendryschik, *Zgoda*, Verlag für ganzheitliche Forschung, Viöl 1997
- Hans-Heinrich Jeschek, *Die Verantwortlichkeit der Staatsorgane nach Völkerstrafrecht*, Bonn 1959
- Jewish Community Book Suwalki and Vicinity: Baklerove, Filipove, Krasnopole, Psheroshle, Puns, Ratzk, Vizhan, Yelineve; The Yair – Abraham Stern – Publishing House*, Tel Aviv 1989
- Jüdisches Historisches Institut Warschau [Jewish Historical Institute of Warsaw], *Faschismus, Getto, Massenmord*, Röderberg, Frankfurt/Main 1960
- Franz Kadell, *Die Katyn-Lüge*, Herbig, Munich 1991
- Jürgen Kalthoff, Martin Werner, *Die Händler des Zyklon B*, VSA-Verlag, Hamburg 1998
- Rüdiger Kammerer, Armin Solms (eds.), *Das Rudolf-Gutachten*, Cromwell Press, London 1993
- Heiner Kappel, Alexander von Stahl, *Für die Freiheit*, Ullstein, Berlin 1996
- Benedikt Kautsky, *Teufel und Verdammte*, Büchergilde Gutenberg, Zürich 1946
- Sidney Kaye, *Handbook of Emergency Toxicology*, C. C. Thomas, Springfield 1980
- Keesing's Archiv der Gegenwart*, Rheinisch-westfälisches Verlagskontor, Essen 1941 & 1948
- G. Keller, *Die Elektrizität im Dienste der Feuerbestattung*, Aktiengesellschaft Brown, Boveri & Cie, special offprint from the Brown Boveri "Mitteilungen", no. 6/7, Baden (Switzerland) 1942
- Hans Keller, *Der elektrische Ofen im Krematorium Biel*, Graphische Anstalt Schühler A.G., Biel 1935
- Rupprecht von Keller, *Der Geisel im modernen Völkerrecht*, Forchheim 1932
- Thomas Keneally, *Schindlers Ark*, Hodder & Stoughton, London 1982ff., several editions
- Thomas Keneally, *Schindlers List*, Simon & Schuster, New York 1982ff.
- Thomas Keneally, *Towards Asmara*, Hodder & Stoughton, London 1989
- Józef Kermisz, *Dokumenty i materiały do dziejów okupacji niemieckiej w Polsce*. Vol. II.: *Akce' i 'wysiedlenia'*, Warsaw/Lodz/Krakow 1946
- Erich Kern, *Meineid gegen Deutschland*, Schütz, Göttingen 1968; 2<sup>nd</sup> ed., Schütz, Preußisch Oldendorf 1971
- Richard Kessler, *Rationelle Wärme-Wirtschaft in Krematorien unter besonderer Berücksichtigung der Leuchtgasfeuerung*, V. *Jahrbuch des Verbandes der Feuerbestattungs-Vereine Deutscher Sprache 1930*, Königsberg 1930
- Beate Klarsfeld, S. Klarsfeld (eds.), *Le mémorial de la déportation des Juifs de France*, publ. by eds., Paris 1978
- Serge Klarsfeld, *Memorial to the Jews deported from France 1942-1944*, Beate Klarsfeld Foundation, New York 1983
- Serge Klarsfeld, *The Auschwitz-Album*, Beate Klarsfeld Foundation, New York 1980
- Ernst Klee, *'Euthanasie' im NS-Staat*, Fischer, Frankfurt/Main 1983
- Ernst Klee, Willi Dreßen, Volker Rieß (ed.), *'Schöne Zeiten', Judenmord aus der Sicht der Täter und Gaffer*, S. Fischer, Frankfurt/Main 1988
- Georg Klein, *Pietà*, Stockholm 1989
- Marc Klein, *Observations et Réflexions sur les camps de concentration Nazis*, Caen 1948
- Peter Kleist, *Aufbruch und Sturz des Dritten Reiches*, Schütz, Göttingen 1968
- Heinrich Kliewe, *Leitfaden der Entseuchung und Entwesung*, F. Enke Verlag, Stuttgart 1951
- August von Knieriem, *Nürnberg. Rechtliche und menschliche Probleme*, Klett, Stuttgart 1953
- Heinz Knobloch, *Der beherzte Reviervorsteher. Ungewöhnliche Zivilcourage am Hackeschen Markt*, Morgenbuch-Verlag, Berlin 1990
- Guido Knopp, *Der verdammte Krieg – Unternehmen Barbarossa*, Bertelsmann, Munich 1991
- Hans-Helmut Knütter, *Die Faschismus-Keule*, Ullstein, Frankfurt/Main 1993
- Oskar W. Koch, *Dachau – Landsberg, Justizmord – oder Mord-Justiz?*, Refo-Verlag, Witten 1974
- Arthur Koestler, *Der Yogi und der Kommissar*, Bechtle, Esslingen 1950
- Eugen Kogon, *Der SS-Staat. Das System der deutschen Konzentrationslager*, Karl Alber, München 1946
- Eugen Kogon, Hermann Langbein, Adalbert Rückerl et al. (eds.), *Nationalsozialistische Massentötungen durch Giftgas*, Fischer Taschenbuch, Frankfurt/Main 1985

- Eugen Kogon, Hermann Langbein, Adalbert Rückerl *et al.* (eds.), *Nazi Mass Murder*, Yale University Press, New Haven 1993
- Josef Kohler, *Grundlagen des Völkerrechts*, Enke, Stuttgart 1918
- Manfred Köhler, *Auch Holocaust-Lügen haben kurze Beine*, Cromwell Press, Brighton 1994
- J. Konieczny, *The Soviets, but not the Western Allies, should have bombed the Auschwitz camp*, Polish Historical Society, Stamford, CT April 1993
- Vitaly Korotych, *Lecture in Toronto, Canada, at the Canadian Institute of Internal Affairs*, April 23, 1990
- Rolf Kosiek, *Historikerstreit und Geschichtsrevision*, 2<sup>nd</sup> ed., Grabert, Tübingen 1988
- T. Kotarbinski, *Meczenstwo walka, zagłada żydów W Polsce 1939-1945*, Warsaw 1960
- Arnold Krammer, *Undue Process: The Untold Story of America's German Alien Internees*, Rowman and Littlefield, Lanham, MD, 1997
- Tomasz Kranz (ed.), *Unser Schicksal – eine Mahnung für Euch. Berichte und Erinnerungen der Häftlinge von Majdanek*. Państwowe Muzeum na Majdanku, Lublin 1994
- Hans Kraupner, Franz Puls, *Die chemischen Vorgänge bei einer Einäscherung*, special offprint from *Forum Städtehygiene*, Ulzen 8/1970
- Ota Kraus, Erich Schön-Kulka, *Továrna na Smrt*, Cin, Prague 1946
- Helmut Krausnick, Hans-Heinrich Wilhelm, *Die Truppe des Weltanschauungskrieges. Die Einsatzgruppen der Sicherheitspolizei und des SD 1938-1942*, Deutsche Verlags-Anstalt, Stuttgart 1981
- Ullrich Kröger, *Die Ahndung von NS-Verbrechen vor westdeutschen Gerichten und ihre Rezeption in der deutschen Öffentlichkeit 1958 bis 1965*, diss., Univ. Hamburg, Hamburg 1973
- F. G. Krotkov, *Überka polej crasgenij – opyt sovetskoy mediciny v veli koj otetshestvennoy vojne 1941-1945*, tom 33: "gigiena", Moscow 1955
- Heinrich Kruse, *Leitfaden für die Ausbildung in der Desinfektion und Schädlingsbekämpfung*, Muster-Schmidt, Göttingen 1948
- F. Küchenmeister, *Die Feuerbestattung. Unter allen zur Zeit ausführbaren Bestattungsarten die beste Sanitätspolizei des Bodens und der sicherste Cordon gegen Epidemien*, Verlag von Ferdinand Enke, Stuttgart 1875
- F. Küchenmeister, *Über Leichenverbrennung*, lecture given on April 8, 1874, for the Neustädter Gymnasial-Stipendienfond, Verlag von Ferdinand Enke, Erlangen 1874
- Barbara Kühle, Wolfgang Titz, *Speziallager Nr. 7 Sachsenhausen : 1945 – 1950*, Brandenburgisches Verl.-Haus, Berlin 1990
- Robert Kühn, Karl Birett, *Merkblätter Gefährlicher Arbeitsstoffe*, collection of supplements; Technische Regeln für Gefahrstoffe (TRGS) 554: "Dieselmotoremissionen", ecomed, Landsberg 1993; TRGS 512: "Begasungen", *ibid.* 1990
- Heinz Kühnreich, *Der Partisanenkrieg in Europa 1939-1945*, Dietz, Berlin (East) 1965
- Barbara Kulaszka, *Did Six Million Really Die? Report of the Evidence in the Canadian 'False News' Trial of Ernst Zündel – 1988*, Samisdat Publishers, Toronto 1992
- Anatoly V. Kuznetsov, *Babi Yar*, Farrar Straus and Giroux, New York/Cape, London 1970
- Karl Lackner (ed.), *Strafgesetzbuch*, 21<sup>st</sup> ed., Beck, Munich 1995
- Landesverband der ehemaligen Besatzungsinternierten Baden-Württemberg (ed.), *Die Internierung im Deutschen Südwesten*, pub. by ed., Karlsruhe 1960
- Jochen von Lang, *Das Eichmann-Protokoll*, Severin und Siedler, Berlin 1982
- Jochen von Lang, *Eichmann Interrogated*, Farrar, Strauss & Giroux, New York 1983
- Hermann Langbein, *Der Auschwitz-Prozeß*, Europäische Verlagsanstalt, Frankfurt/Main 1965
- Hermann Langbein, *Menschen in Auschwitz*, Europa-Verlag, Vienna 1987
- Hermann Langbein, *...wir haben es getan*, Europa Verlag, Vienna 1964
- Walter Laqueur, *The Terrible Secret. An Investigation into the Suppression of Information about Hitler's 'Final Solution'*, Weidenfeld and Nicolson, London/Little Brown, Boston 1980
- Walter Laqueur, *Was niemand wissen wollte: Die Unterdrückung der Nachrichten über Hitlers Endlösung*, Ullstein, Frankfurt/Berlin/Vienna 1981
- Hans Laternser, *Die andere Seite im Auschwitzprozeß 1963/65*, Seewald, Stuttgart 1966
- Hans Laternser, *Verteidigung deutscher Soldaten*, Bohnemeier, Bonn 1950
- Heinz Lauber, *Judenpogrom 'Reichskristallnacht' November 1938 in Großdeutschland*, Bleicher, Gerlingen 1981
- John H. Lauck, *Katyn Killings: In the Record*, Kingston Press, Clifton, NJ, 1974; 2<sup>nd</sup> ed. 1988
- Rudolf von Laun, *Haager Landkriegsordnung*, 4<sup>th</sup> ed., Wolfenbüttler Verlagsanstalt, Wolfenbüttel 1948
- Mark Lautern, *Das letzte Wort über Nürnberg*, Dürer, Buenos Aires 1950
- Law Reports of Trials of War Criminals*, v. VIII, London 1948, Case 44 (Kesselring)
- Legge di guerra*, Italy
- Dieter Lehner, *Du sollst nicht falsch Zeugnis geben*, Vowinckel, Berg n.d. [1988]



- Robert Lenski, *The Holocaust on Trial: The Case of Ernst Zündel*, Reporter Press, Decatur, Ala., 1990
- Bruno Leoni, *Freedom and the Law*, Indianapolis, Liberty Fund, 1991, pp. 148-150:
- Frederick A. Leuchter, *An Engineering Report on the alleged execution gas chambers at Auschwitz, Birkenau and Majdanek, Poland*, Samisdat Publishers, Toronto, Ontario, 1988
- Frederick A. Leuchter, *The Leuchter Report*, Focal Point Publications, London 1989
- Frederick A. Leuchter, *The Second Leuchter Report*, Samisdat, Toronto 1989
- Primo Levi, *Si c'est un homme*, Julliard Press, pocket edition, Paris 1993
- Lexikon Institut Bertelsmann (ed.), *Ich sag dir alles*, Bertelsmann, Gütersloh 1968
- Heiner Lichtenstein, *Im Namen des Volkes?*, Bund, Cologne 1984
- Heiner Lichtenstein, *Majdanek. Reportage eines Prozesses*, Europäische Verlagsanstalt, Frankfurt/Main 1979
- Deborah E. Lipstadt, *Denying the Holocaust: The Growing Assault on Truth and Memory*, Free Press, New York 1993
- Franz von Liszt, Max Fleischmann, *Das Völkerrecht*, 12<sup>th</sup> ed., Springer, Berlin 1925
- Franz von Liszt, Schmidt, *Lehrbuch des deutschen Strafrechts*, v. 1, 26<sup>th</sup> ed., de Gruyter, Berlin 1932
- Elisabeth Loftus, Katherine Ketcham, *The Myth of Repressed Memory*, St. Martin's Press, New York 1994
- Elisabeth Loftus, Katherine Ketcham, *Witness for the Defense*, St. Martin's Press, New York 1991
- Peter Longerich (ed.), *Die Ermordung der europäischen Juden*, Piper, Munich 1990
- Josef Loscher, Heinz Schumann (eds.), *Militärhygiene und Feldepidemiologie*, Militärverlag der DDR, Berlin 1987;
- Konrad Löw, *Von 'Hexen' und Hexenjägern*, publ. by author, Baierbrunn 1993
- Luftbild und Luftbildmessung* No. 16, Hansa Luftbild, Berlin 1938
- Günther Lummert, *Die Strafverfahren gegen Deutsche im Ausland wegen Kriegsverbrechens*, Arbeitsgemeinschaft vom Roten Kreuz in Deutschland (British Zone), Hamburg 1949
- L. Maccone, *Storia documentata sulla cremazione presso i popoli antichi e moderni con speciale riferimento alla igiene*, Istituto Italiano d'Arti grafiche, Bergamo 1932
- Kevin MacDonald, *A People That Shall Dwell Alone*, Praeger, Westport (Connecticut) 1994
- Kevin MacDonald, *Separation And Its Discontents*, Praeger, Westport (Connecticut) 1997
- Kevin MacDonald, *The Culture Of Critique*, Praeger, Westport (Connecticut) 1998
- Manassero, *I codici penali militari*, v. 1 + 2, 2<sup>nd</sup> ed., Milano 1951
- Thomas Mann, *Sieben Manifeste zur jüdischen Frage*, Jos. Melzer Verlag, Darmstadt 1966
- Roger Manvell, H. Fraenkel, *The Incomparable Crime*, Putman, New York 1967
- Pierre Marais, *En lisant de près les écrivains chantres de la Shoah – Primo Levi, Georges Wellers, Jean-Claude Pressac*, La Vielle Taupe, Paris 1991
- Pierre Marais, *Les camions à gaz en question*, Polemiques, Paris 1994
- Sonja Margolina, *Das Ende der Lügen*, Siedler, Berlin 1992
- Hans Marsalek, *Die Geschichte des Konzentrationslagers Mauthausen*, Österreichische Lagergemeinschaft Mauthausen, Vienna 1980
- W.F. Marshall, R.W. Hurn, "Hazard from Engines Rebreathing Exhaust in Confined Space", U.S. Department of the Interior, Bureau of Mines, Report of Investigations 7757, 1973
- Józef Marszałek, *Majdanek, the Concentration Camp in Lublin*, Interpress, Warsaw 1986
- James J. Martin, *The Man who invented 'Genocide': The Public Career and Consequences of Raphael Lemkin*, Institute for Historical Review, Torrance 1984
- Hermann Maschke, *Das Krupperteil und das Problem der Plünderung*, Musterschmidt, Göttingen 1951
- Werner Maser, *Der Wortbruch. Hitler, Stalin und der Zweite Weltkrieg*, Olzog Verlag, München 1994
- Werner Maser, *Das Exempel*, Blaue Aktuelle Reihe 9, Mut-Verlag, Asendorf 1986
- Werner Maser, *Nürnberg – Tribunal der Sieger*, Econ, Düsseldorf 1977; later ed.: Droemer Knaur, Munich 1979
- N. Masur, *En jude talar med Himmler*, Stockholm 1945
- Carlo Mattogno, *Auschwitz: La Prima gasazione*, Edizioni di Ar, Padova 1992
- Carlo Mattogno, *Auschwitz: The End of a Legend*, Granata Publishing, Palos Verdes 1994
- Carlo Mattogno, *Il rapporto Gerstein. Anatomia di un falso*, Sentinella d'Italia, Monfalcone 1985
- Carlo Mattogno, *La Soluzione Finale: Probleme e polemiche*, Edizioni di Ar, Padova 1991
- Carlo Mattogno, *La "Zentralbauleitung der Waffen-SS und Polizei Auschwitz"*, Editione di Ar, Padova 1998
- Carlo Mattogno, "Medico ad Auchwitz": *Anatomia di un falso*, Edizioni La Sfinge, Parma 1988
- Carlo Mattogno, "Sonderbehandlung" *ad Auschwitz. Genesi e significato*, Edizioni di Ar, Padova 2001
- Carlo Mattogno, Franco Deana, *The Crematory Ovens of Auschwitz-Birkenau*, Granata Communications, Palos Verdes (CA) 1995
- Carlo Mattogno, Jürgen Graf, *Treblinka. Vernichtungslager oder Durchgangslager?* Castle Hill Publishers, Hastings 2002
- Carlo Mattogno, Jürgen Graf, *Treblinka. Extermination Camp or Transit Camp?* Theses & Dissertations Press, Chicago

- 2003.
- Frederic H. Maugham, *UNO and War Crimes*, Murray, London 1951
- Reinhard Maurach, *Die Kriegsverbrecherprozesse gegen deutsche Gefangene in der Sowjetunion*, Arbeitsgemeinschaft vom Roten Kreuz in Deutschland (British Zone), Hamburg 1950
- Reinhard Maurach, *Kritik der Notstandslehre*, Heymann, Berlin 1935 (reprint: Keip, Goldbach)
- Pierangelo Maurizio, *Via Rasella, cinquant'anni di menzogne*, Maurizio Editione, Roma 1996
- Arno J. Mayer, *Why did the Heavens not Darken? The 'Final Solution' in History*, Pantheon Books, New York 1988; pb 1990
- Ladislav J. Meduna, *Carbon Dioxide Therapy*, C. C. Thomas, Springfield 1958
- Patricia Meehan, *A Strange Enemy People: Germans Under The British 1945-50*, Peter Owen Publishers, 2001
- Günther Meinhardt, *Eduard von Simson*, Habelt, Bonn 1981
- Abraham Melzer, "Iwan der Schreckliche oder John Demjanjuk, Justizirrtum? Justizskandal!", *SemitTimes*, spec. ed., Dreieich, March 1992
- Tadeusz Mencil (ed.), *Majdanek 1941-1944*, Wydawnictwo Lubelskie, Lublin 1991
- John Mendelsohn, *Prologue*, National Archives, Washington, DC, Fall 1983
- John Mendelsohn (ed.), *The Holocaust*, Garland, New York 1982
- Brün Meyer (ed.), *Dienstaltersliste der Waffen-SS, Stand 1.7.1944*, Biblio Verlag, Osnabrück 1987
- Meyers Enzyklopädisches Lexikon*, Bibliographisches Institut Mannheim, Mannheim 1971
- Edmund Mezger, *Strafrecht, I. Allgemeiner Teil. Ein Studienbuch*, 4<sup>th</sup> ed., Beck, Munich 1952 (reprint: Keip, Goldbach)
- Martin Middlebrook, *The Battle of Hamburg*, McMillan, London 1980
- John Milsom, *German Military Transport of World War Two*, Hippocrene Books, New York/Arms & Armour Press, London 1975
- Ministerium für Volksbildung der Deutschen Demokratischen Republik (ed.), *Liste der auszusondernden Literatur. Dritter und letzter Nachtrag...*, Zentralverlag, Berlin (East), 1953, facsimile reprint, Uwe Berg-Verlag, Toppstedt 1984
- Isaak I. Minz, I. M. Rasgon, Arkadij L. Sidorow, *Der Große Vaterländische Krieg der Sowjetunion*, SWA Verlag, Berlin 1947
- Sven Moeschlin, *Klinik und Therapie der Vergiftung*, Georg Thieme Verlag, Stuttgart 1986
- Armin Mohler, *Der Nasenring*, Heitz & Höffkes, Essen 1989
- Vyacheslay M. Molotov, *The Molotov Notes on Nazi Atrocities*, The American Council on Soviet Relations, New York Jan. 6, 1942
- Andreas Molau (ed.), *Opposition für Deutschland*, VGB, Berg am Starnberger See 1995
- Helmuth von Moltke, *Briefe an Freya 1939-1945*, Beck, Munich 1988
- Hans Mommsen, Manfred Grieger, *Das Volkswagenwerk und seine Arbeiter im Dritten Reich*, Econ, Düsseldorf 1996
- Joachim Mrugowsky (ed.), *Arbeitsanweisungen für Klinik und Laboratorium des Hygiene-Instituts der Waffen-SS*, 2nd. and 3rd ed., Urban & Schwarzenberg, Berlin 1943 and 1944
- Filip Müller, *Auschwitz Inferno: Testimony of a Sonderkommando*, Routledge & Kegan Paul, London 1979
- Filip Müller, *Sonderbehandlung*, Steinhausen, Munich 1979
- Ingrid Müller-Münch, *Die Frauen von Majdanek*, Rowohlt, Reinbek 1982
- Michael A. Musmanno, *The Eichmann Kommandos*, Peter Davies, London 1962
- Robert Nagel, *Wege und Ziele der modernen Feuerbestattung*, Verlag Wilhelm Ruppmann, Stuttgart 1922
- Walter Nagl, *Gentechnologie und Grenzen der Biologie*, Wissenschaftliche Buchgesellschaft, Darmstadt 1987
- Bernd Naumann, *Auschwitz*, Athenäum, Frankfurt/Main 1968
- Gert Naumann, *Besiegt und 'befreit'. Ein Tagebuch hinter Stacheldraht in Deutschland 1945-1947*, Druffel, Leoni am Starnberger See 1984
- Nazi Conspiracy and Aggression*, Washington, DC, 1946-1948
- Ernst Neufert, *Bauentwurfslehre*, Ullstein Fachverlag, Frankfurt am Main 1962
- Johann Neuhäusler, *Wie war das im KZ Dachau? Ein Versuch, der Wahrheit näher zu kommen*. Kuratorium für Sühne- mal KZ Dachau, Dachau 1981
- Robert Neumann, *Hitler – Aufstieg und Untergang des Dritten Reiches*, Desch, Munich 1961
- Robert Neumann, H. Koppel, *The Pictorial History of the Third Reich*, Bantam Books, New York 1962
- Francis R. Nicosia, *Hitler und der Zionismus*, Druffel, Leoni 1989
- Friedrich Nietzsche, *Der Antichrist*, Insel-Verlag, Frankfurt/Main 1996
- Thomas Nigel, *Partisan Warfare 1941-1945*, Osprey, London 1983
- Jeremy Noakes, Geoffrey Pridham (ed.), *Nazism: A History in Documents and Eyewitness accounts 1919-1945*, Vol. 2, Schocken Books, New York 1988
- Ernst Nolte, *Das Vergehen der Vergangenheit*, Ullstein, Frankfurt am Main / Berlin 1987

- Ernst Nolte, *Der Europäische Bürgerkrieg 1917-1945*, Ullstein, Frankfurt am Main / Berlin 1987
- Ernst Nolte, *Der Faschismus in seiner Epoche*, Piper, Munich 1963
- Ernst Nolte, *Streitpunkte*, Ullstein, Frankfurt am Main / Berlin 1993
- Claus Nordbruch, *Die europäischen Freiwilligen im Burenkrieg*, Contact, Pretoria 1999
- Claus Nordbruch, *Sind die Gedanken noch frei? Zensur in Deutschland*, Universitäts, München 1998
- Peter Novick, *The Holocaust in American Life*, Houghton Mifflin, Boston 1999
- Nuvolone, *La punizione dei crimini di guerra*, 1945
- Miklos Nyiszli, *Boncolórovása voltam az Auschwitz-i krematóriumban*, Világ, 1946
- Miklos Nyiszli, *Médecin à Auschwitz. Souvenirs d'un médecin déporté, traduit et adapté du hongrois par Tibère Kremer*, Juillard, Paris 1961
- Oberkommando der Wehrmacht, *H.Dv. 194. Entseuchungs- und Entwesungsvorschrift für die Wehrmacht*, (Ents. V.) Verlag der Reichsdruckerei, Berlin 1939
- Oberkommando des Heeres (ed.), *Die Nebeltruppe*, Waffenhefte des Heeres, Deutscher Volksverlag, Munich 1941
- Edward F. Obert, *Internal Combustion Engines and Air Pollution*, Intext Educational Publishers, New York 1973
- Obozy hitlerowskie na ziemiach polskich 1939-1945*, Państwowe Wydawnictwo Naukowe, Warschau 1979 (Encyclopedia)
- Öfen für Krematorien System Topf. J. A. Topf & Söhne Erfurt. Maschinenfabrik und feuerungstechnisches Baugeschäft*, publicity leaflet pub. 1926
- Official Proceedings of the George C. Marshall Research Foundation*. videotape Transcript of interview with Lucius D. Clay, George C. Marshall Research Foundation, 1976
- Lassa F. L. Oppenheim, *International Law*, 4<sup>th</sup> ed., Longman, London 1926
- Lassa F. L. Oppenheim, J. E. Edmonds, *Manual of Military Law*, Her Majesty Stationary Office, London 1929
- Lassa F. L. Oppenheim, Hersch Lauterpacht, *International Law, a Treatise*, v. II, 6<sup>th</sup> ed., Longman, London 1944; 7<sup>th</sup> ed. 1952
- Ulrich-Dieter Oppitz, *Strafverfahren und Strafvollstreckung bei NS-Gewaltverbrechen*, pub. by auth., Ulm 1979
- Hermann Ortloff, *Gleichberechtigung der Feuer- und Erdbestattung*, Felix Dietrich, Leipzig 1907
- Friedrich Oscar, *Über Galgen wächst kein Gras*, Erasmus-Verlag, Braunschweig 1950
- Österreichische Historiker-Arbeitsgemeinschaft für Kärnten und Steiermark (ed.), *Völkermord der Tito-Partisanen 1944-1948*, 2<sup>nd</sup> ed., O. Hartmann Verlag, Sersheim (Germany) 1993
- Walter Ostwald, *Generator-Jahrbuch*, 1942, J. Kasper & Co., Berlin 1943
- Werner Oswald, *Kraftfahrzeuge und Panzer der Reichswehr, Wehrmacht und Bundeswehr*, Motorbuch, Stuttgart 1990
- Reginald T. Paget, *Manstein, seine Feldzüge und sein Prozeß*, Limes, Wiesbaden 1952
- Dieter Pankow, *Toxikologie des Kohlenmonoxids*, VEB Verlag Volk und Gesundheit, Berlin (East) 1981
- Pannain, *Manuale di diritto penale, parte generale*, Roma 1942
- J. Patek, *Memorial Services Commemorating the 50th Anniversary of Babi Yar Could be Attenuated by Aerial Photos Showing Absence of Mass Graves There* (unpub. MS)
- Temple C. Patton (ed.), *Pigment Handbook*, v. 1, Wiley, New York 1973
- Allen Paul, *Katyn, The Untold Story of Stalin's Polish Massacre*, Charles Scribner's Sons, New York 1989; 2<sup>nd</sup> ed. 1991
- Max Pauly, *Die Feuerbestattung*, Verlagsbuchhandlung J. J. Weber, Leipzig 1904
- Robert van Pelt, D. Dwork, *Auschwitz: 1270 to the Present*, Yale, University Press 1996
- Robert Jan van Pelt, *The Case for Auschwitz. Evidence from the Irving Trial*, Indiana University Press, Bloomington/Indianapolis 2002
- Richard Pemsel, *Hitler – Revolutionär, Staatsmann, Verbrecher?*, Grabert, Tübingen 1986
- J. H. Perry, *Chemical Engineer's Handbook*, Wilmington, Delaware, 1949
- Erwin Peter, A. Epifanow, *Stalins Kriegsgefangene*, Stocker, Graz 1997
- Gerhard Peters, *Blausäure zur Schädlingsbekämpfung*, Ferdinand Enke Verlag, Stuttgart 1933
- Gerhard Peters, *Die hochwirksamen Gase und Dämpfe in der Schädlingsbekämpfung*, F. Enke, Stuttgart 1942
- Michael Petzet (ed.), *Holzschädlingsbekämpfung durch Begasung*, Arbeitshefte des Bayerischen Landesamtes für Denkmalpflege, Bd. 75, Lipp-Verlag, München 1995
- Gerd Pfeiffer (ed.), *Karlsruher Kommentar zur Strafprozeßordnung*, 3<sup>rd</sup> ed., Beck, Munich 1993
- Raymond Phillips (ed.), *Trial of Josef Kramer and Forty-Four Others (The Belsen Trial)*, William Hodge, London 1949
- P. de Pietra Santa, *La crémation des morts en France et à l'étranger*, Librairie J.-B. Baillière et Fils, Paris 1874
- P. de Pietra Santa, *Modern Cremation*, Publication de la Société Française d'Hygiène; au bureau de la Société, Paris 1889
- Czeslaw Pilichowski, *No Time Limit for These Crimes*, Interpress, Warsaw 1980
- G. Pini, *La crémation en Italie et à l'étranger de 1774 jusqu'à nos jours*, Ulrich Hoepli Editeur Libraire, Milan 1885

- Franciszek Piper, *Die Zahl der Opfer von Auschwitz*, Verlag Staatliches Museum in Oswiecim, Auschwitz 1993
- Franciszek Piper, *Auschwitz. Wieviele Juden, Polen, Zigeuner... wurden umgebracht*, Universitas, Krakow 1992
- Franciszek Piper, *Estimating the Number of the Deported to and Victims of the Auschwitz-Birkenau Camp*, Yad Vashem Studies XXI, Jerusalem 1991
- Michael Collins Piper, *Best Witness. The Mel Mermelstein Affair and the Triumph of Historical Revisionism*, Center for Historical Review, Washington, D.C., 1994
- Arno Plack, *Hitlers langer Schatten*, Langen Müller, Munich 1993
- Hans Poeppel (ed.), *Die Soldaten der Wehrmacht*, 3<sup>rd</sup> ed., Herbig, München 1999
- Oswald Pohl, *Credo. Mein Weg zu Gott*, A. Girnth, Landshut 1950
- Léon Poliakov, *Breviaire de la haine*, Calmann-Lévy, Paris 1951/1979
- Léon Poliakov, *Harvest of Hate*, Schocken Books (Holocaust Library), New York 1979
- Léon Poliakov, J. Wulf, *Das Dritte Reich und die Juden*, Arani, Berlin 1955
- Cyril J. Polson, R. N. Tattersall, *Clinical Toxicology*, Lippincott, Philadelphia 1969
- Arthur Ponsonby, *Falsehood in Wartime: Propaganda Lies of the First World War*, Institute for Historical Review, Newport Beach, CA 1991
- Karl R. Popper, *Objektive Erkenntnis*, 4<sup>th</sup> ed., Hoffmann und Campe, Hamburg 1984
- Carlos Porter, *Not Guilty at Nuremberg: The German Defense Case*, Historical Review Press, Brighton 1990
- Gerald L. Posner, John Ware, *Mengele. Die Jagd auf den Todesengel*, Aufbau, Berlin 1993
- Vladimir Posner, Helene Keyssar, *Remembering War: a US-Soviet Dialogue*, Oxford University Press, New York 1990
- Walter Post, *Unternehmen Barbarossa*, Mittler, Hamburg 1995
- Walter Post, *Die verleumdete Armee*, Pour le Mérite, Selent 1999
- Jean-Claude Pressac, *Auschwitz: Technique and Operation of the Gas Chambers*, The Beate Klarsfeld Foundation, New York 1989
- Jean-Claude Pressac, *Die Krematorien von Auschwitz. Die Technik des Massenmordes*, Piper-Verlag, München 1994
- Jean-Claude Pressac, *Les Crématoires d'Auschwitz, la Machinerie du meurtre de masse*, CNRS, Paris 1993
- Michael Prinz, Rainer Zitelmann, *Nationalsozialismus und Modernisierung*, Wissenschaftliche Buchgesellschaft, Darmstadt 1991
- Rüdiger Proske, *Vom Marsch durch die Institutionen zum Krieg gegen die Wehrmacht*, Von Hase & Köhler, Mainz 1997
- Rüdiger Proske, *Wider den Mißbrauch der Geschichte deutscher Soldaten zu politischen Zwecken*, Von Hase & Köhler, Mainz 1996
- Franz Puntigam, Hermann Breymesser, Erich Bernfus, *Blausäuregaskammern zur Fleckfieberabwehr*, Sonderveröffentlichung des Reichsarbeitsblattes, Berlin 1943
- B. Rammer, *BBC Elektro-Kremationsöfen im Dienste der Feuerbestattung*, BBC Brown Boveri (explanatory report)
- Paul Rassinier, *Das Drama der Juden Europas*, Pfeiffer, Hannover 1965
- Paul Rassinier, *Debunking the Genocide Myth*, Institute for Historical Review, Torrance 1978
- Paul Rassinier, *Le Mensonge d'Ulysse*, La Librairie française, Paris 1950 / La Vielle Taupe, Paris 1979
- Paul Rassinier, *The Holocaust Story and the Lies of Ulysses*, 2<sup>nd</sup> ed., Institute for Historical Review, New Port Beach 1990
- Paul Rassinier, *Was ist Wahrheit?* Druffel, Leoni 1982
- Paul Rassinier, *Was nun, Odysseus?*, Priester, Wiesbaden 1960
- Gerhard Rauschenbach, *Der Nürnberger Prozeß gegen die Organisationen*, L. Röhrscheid, Bonn 1954
- Franc Rector, *The Nazi Extermination of Homosexuals*, Stern and Day, New York 1981
- A. Frank Reel, *The case of General Yamashita*, University of Chicago Press, Chicago 1949
- Rudolf Reder, *Belzec*, Kraków 1946
- Günther H. Rehak, "Wandlungen des Antifaschismus", *Kommentare zum Zeitgeschehen*, Nr. 33, Vienna August 1997
- Balduin Reichenwallner, *Tod und Bestattung*, Katakomben-Verlag / Balduin Reichenwallner, Munich 1926
- Reichspatentamt (Imperial Patent Office), Patent No. 218581. Class 24d. Issued on February 8, 1910. M.J. Kergel in Beuthen, O.-S., *Leichenverbrennungsofen mit Rekuperator*. Patented in the German Reich as of October 4, 1908
- Gerald Reitlinger, *Die Endlösung*, Colloquium, Berlin 1956; 4<sup>th</sup> ed., *ibid.* 1992
- Gerald Reitlinger, *Die SS. Tragödie einer deutschen Epoche*, Desch, Munich 1957
- Gerald Reitlinger, *The Final Solution*, Mitchell, London 1953; 2<sup>nd</sup> ed.: A. S. Barnes, New York 1961
- Otto E. Remer (ed.), *Die Zeit lügt!*, Verlag Remer-Heipke, Bad Kissingen 1992
- Lothar Rendulic, *Glaserbach – Nürnberg – Landsberg*, Stocker, Graz 1953
- Wilhelm Rentrop, Egmont Hasper (eds.), *Requisitionen, Besatzungsschäden und ihre Bezahlung*, Fachverlag für Wirtschafts- und Steuerrecht, Stuttgart 1950

- Richtlinien für den Bau und Betrieb von Öfen zur Einäscherung menschlicher Leichen, aufgestellt vom Großdeutschen Verbands der Feuerbestattungsvereine e.V.*, Verlag der Verlagsabteilung des Großdeutschen Verbandes der Feuerbestattungsvereine e.V., Berlin 1937
- Richtlinien für die Anwendung von Blausäure (Zyklon) zur Ungeziefervertilgung (Entwesung)*, Gesundheitsanstalt des Protektorats Böhmen und Mähren, Prague n.d.; Doc. NI-9912 (1) in the Nuremberg Trial
- Bryan Mark Rigg, *Hitler's Jewish Soldiers: The Untold Story of Nazi Racial Laws and Men of Jewish Descent in the German Military*, University Press of Kansas, Lawrence, KS, 2002
- F. Rocco, *Sistema di diritto internazionale*, Napoli 1938
- Conrad Roediger, Helmut Strobel, *Völkerrechtliches Gutachten über die strafrechtliche Aburteilung deutscher Kriegsgefangener in der Sowjetunion*, Heidelberg 1950
- Rogowski, *Repressalie*, Dissertation, Göttingen 1950
- Eleanor Roosevelt, Albert Einstein *et al.* (eds.), *The Black Book of Polish Jewry*, Roy Publishers, New York 1943
- Adolf Röpnack, *Die Geschichte der Raketenartillerie von den Chinesen bis zu den Deutschen über ignis volans bis zur V-2*, pub. by author, Bad Aibling 1960
- Henri Roques, *Die 'Geständnisse' des Kurt Gerstein*, Druffel, Leoni 1986
- Henri Roques, *Faut-il fusiller Henri Roques?*, Ogmios Diffusion, Paris 1986
- Henri Roques, *The Confessions of Kurt Gerstein*, Institute for Historical Review, Costa Mesa, CA, 1989
- Ludwig Rosenthal, *'Endlösung der Judenfrage', Massenmord oder 'Gaskammerlüge'?*, Verlag Darmstädter Blätter, Darmstadt 1979
- Alf Ross, *Lehrbuch des Völkerrechts*, Kohlhammer, Stuttgart 1951
- Cecil Roth *et al.* (eds.), *Encyclopaedia Judaica*, Macmillan and Keter, New York and Jerusalem 1971
- Lutz Roth, Max Daunerer, *Giftliste*, collection of supplements, ecomed, Landsberg 1986
- Wolf Dieter Rothe, *Die Endlösung der Judenfrage*, Bierbaum, Frankfurt/Main 1974
- Johannes Rothkranz, *Die kommende Diktatur der Humanität*, v. 2, Pro Fide Catholica, Durach 1990
- Adalbert Rückerl, *Die Strafverfolgung von NS-Verbrechen*, C. F. Müller, Heidelberg 1979
- Adalbert Rückerl, *NS-Verbrechen vor Gericht*, C. F. Müller, Heidelberg 1984
- Adalbert Rückerl, *Nationalsozialistische Vernichtungslager im Spiegel deutscher Strafprozesse*, dtv, Munich 1978
- Adalbert Rückerl (ed.), *NS-Prozesse*, C.F. Müller, Karlsruhe 1972
- Germar Rudolf, *Das Rudolf Gutachten*, Castle Hill Publishers, Hastings 2001
- Germar Rudolf, *The Rudolf Report*, Theses & Dissertations Press, Capshaw, AL, in preparation
- Hans P. Rullmann, *Der Fall Demjanjuk*, Verlag für ganzheitliche Forschung und Kultur, Struckum 1987
- Ernst Rumpf, *Wiedergutmachung*, Kultur- und Zeitgeschichte – Archiv der Zeit, Rosenheim n.d. [1992]
- John Sack, *An Eye for an Eye*, BasicBooks, New York 1993
- John Sack, *Auge um Auge*, Kabel Verlag, Hamburg 1995
- Ingrid Sagel-Grande, H. H. Fuchs, Christiaan F. Rüter (eds.), *Justiz und NS-Verbrechen*, v. XXI, University Press, Amsterdam 1979
- Walter N. Sanning, *The Dissolution of the Eastern European Jewry*, Institute for Historical Review, Newport Beach, CA, 1983
- Walter N. Sanning, *Die Auflösung des osteuropäischen Judentums*, Grabert, Tübingen 1983
- Ernst Sauer, *Grundlehre des Völkerrechts*, Pick, Köln 1947; 2<sup>nd</sup> ed., Heymann, Köln 1955
- Wilhelm Sauer, *System des Völkerrechts*, Röhrscheid, Bonn 1952
- Howe H. Saunders, *Forum der Rache*, Druffel, Leoni 1986
- Horst Scheibert, *Der russische Kampfwagen T-34 und seine Abarten*, Podzun-Pallas Verlag, Friedberg 1988
- Franz J. Scheidl, *Geschichte der Verfemung Deutschlands*, v. 3, pub. by author, Vienna 1968
- Gerhard Schirmer, *Sachsenhausen – Workuta*, Grabert, Tübingen 1992
- Otto von Schjerning, *Handbuch der ärztlichen Erfahrungen im Weltkrieg 1914/1918*, v. VII, *Hygiene*, J. A. Barth, Leipzig 1922
- Schlag nach! Natur*, Bibliographisches Institut, Leipzig 1952
- Paul Schläpfer, *Über den Bau und den Betrieb von Krematoriumsöfen*, separate reprint from *Jahresbericht des Verbandes Schweizerischer Feuerbestattungsvereine*, Zürich 1937
- Wilhelm Schlesiger, *Der Fall Rudolf*, Cromwell Press, Brighton 1994
- Hans Schmidt, *Jailed in 'Democratic' Germany. The Ordeal of an American Writer*, Guderian Books, Milton, FL, 1997
- Robert F. Schmidt, *Biommaschine Mensch*, Piper, Munich 1979
- Raimund Schnabel, *Macht ohne Moral*, Röderberg, Frankfurt/Main 1957
- Egon Schneider, *Beweis und Beweiswürdigung*, 4<sup>th</sup> ed., F. Vahlen, Munich 1987
- Gerhard Schoenberner, *Der gelbe Stern*, Rütten und Loening, Hamburg 1960
- Gerhard Schoenberner, *Wir haben es gesehen*, Fourier, Wiesbaden 1981

- Adolf Schönke, *Strafgesetzbuch*, Kommentar, 6<sup>th</sup> ed., Beck, Munich 1952
- Adolf Schönke, Horst Schröder (eds.), *Strafgesetzbuch*, 25<sup>th</sup> ed., Beck, Munich 1997
- Caspar von Schrenck-Notzing, *Charakterwäusche. Die Politik der amerikanischen Umerziehung in Deutschland*, Ullstein, Berlin 1993
- Regina von Schrenck-Notzing (ed.), *Freiheit braucht Mut*, Kronos, München 1997
- Gerhard Schulz (ed.), *Partisanen und Volkskrieg*, Vandenhoeck & Ruprecht, Göttingen 1985
- Fritz Schumacher, *Die Feuerbestattung*, J. M. Gebhardt's Verlag, Leipzig 1939
- Heinrich A. Schütze, *Die Repressalieunter besonderer Berücksichtigung der Kriegsverbrecherprozesse*, Röhrscheid, Bonn 1950
- Jürgen Schwab, *Die Meinungsdictatur. Wie 'demokratische' Zensoren die Freiheit beschneiden*, Nation Europa Verlag, Coburg 1997
- Alan M. Schwartz, *Hitler's Apologists: The Antisemitic Propaganda of Holocaust 'Revisionism'*, The Anti-Defamation-League, New York 1993
- Georg Schwarzenberger, *Einführung in das Völkerrecht*, Mohr, Tübingen 1951
- Erich Schwinge, *Militärstrafgesetzbuch, Kommentar*, 5<sup>th</sup> ed., Junker & Dünnhaupt, Berlin 1943
- Tom Segev, *The Seventh Million*, Hill and Wang, New York 1993
- Franz W. Seidler, *Die Wehrmacht im Partisanenkrieg*, Pour le Mérite, Selent 1998
- Franz W. Seidler, *Verbrechen an der Wehrmacht*, Pour le Mérite, Selent 1998
- Karl-Heinz Seifert, D. Hömig (ed.), *Grundgesetz für die Bundesrepublik Deutschland*, 2<sup>nd</sup> ed. Nomos Verlagsgesellschaft, Baden Baden 1985
- Gitta Sereny, *Am Abgrund*, Ullstein, Frankfurt/Main 1979
- Robert Servatius, *Verteidigung Adolf Eichmann*, Harrach, Bad Kreuznach 1961
- Israel Shahak, *Jewish History, Jewish Religion*, Pluto Press, London 1994
- S. Z. Shapiro (ed.), *Truth Prevails: Demolishing Holocaust Denial: The End of the Leuchter Report*, Beate Klarsfeld Foundation, New York 1990
- Yoram Sheftel, *The Demjanjuk Affair. The Rise and Fall of the Show Trial*, Victor Gollancz, London 1994
- Eran Sher, *Handbook of Air Pollution from Internal Combustion Engines: Pollutant Formation and Control*, Academic Press, Boston 1998
- Michael Shermer, *Why People Believe Weird Things*, Freeman & Co. New York 1997
- William Shirer, *The Rise and Fall of the Third Reich*, Fawcett Crest, New York 1960
- Marcel Sibert, *Traité de droit international*, v. 1, Dalloz, Paris 1951
- Karl Siegert, *Notstand und Putativnotstand*, Mohr, Tübingen 1931
- Karl Siegert, *Repressalie, Requisition und höherer Befehl*, Göttinger Verlagsanstalt, Göttingen 1953
- Abraham Silberschein, *Die Judenausrottung in Polen*, third and fifth series, Geneva 1944
- Konstantin Simonov, *Il campo dello sterminio*, Foreign Language Publication House, Moscow 1944
- Constantin Simonov, *The Lublin Extermination Camp*, Foreign Languages Publication House, Moscow 1944
- Keith Simpson (ed.), *Taylor's Principles and Practice of Medical Jurisprudence*, J. & A. Churchill, London 1965
- Peter Singer, *Practical Ethics*, Cambridge UP, Cambridge 1979
- Arthur L. Smith, *Die 'Hexe von Buchenwald'*, Böhlau, Cologne 1983
- Herbert A. Smith, *The crisis in the law of nations*, Stevens & Sons, London 1947
- Kazimierz Smoleń, *Auschwitz 1940-1945*, Ullstein, Frankfurt/Main 1961
- Société de crémation de Genève*, Bulletin VIII, Imprimerie Centrale, Geneva 1908
- Wolfgang Sofsky, *Die Ordnung des Terrors: Das Konzentrationslager*, Fischer, Frankfurt 1993
- Klaus Sojka (ed.), *Die Wahrheit über die Wehrmacht. Reemtsmas Fälschungen widerlegt*, FZ-Verlag, Munich 1998
- Staatliches Museum Auschwitz-Birkenau (ed.), *Die Sterbebücher von Auschwitz*, Saur, München 1995
- Karlhans Sonnenburg, *Die französischen Kriegsverbrecherprozesse*, Arbeitsgemeinschaft für Recht und Wirtschaft, München 1951
- Soviet War Documents, Information Bulletin*, Embassy of the Union of Soviet Socialist Republics, Special Supplement, Washington DC, December 1943
- Sowjetski Partisani*, Moscow 1961
- James M. Spaight, *Bombing Vindicated*, Geoffrey Bles, London 1944
- James M. Spaight, *War Rights on Land*, Macmillan, London 1911
- Eli Spanic, H. Factor, V. Struminsky, "Number of Living Holocaust Survivors", Amcha Press Release, Jerusalem 1997
- M. Spataro, *Repressaglia (Reprisal)*, edizione Settimo Sigillo, Roma 1996
- Friedrich Spee von Langenfeld, *Cautio Criminalis oder Rechtliches Bedenken wegen der Hexenprozesse*, dtv, Munich 1982
- Albert Speer, *Der Sklavenstaat*, DVA, Stuttgart 1981

- Walter J. Spielberger, *Die Halbkettenfahrzeuge des deutschen Heeres*, 2<sup>nd</sup> ed., Motorbuch, Stuttgart 1984
- Walter J. Spielberger, *Kraftfahrzeuge und Panzer des österreichischen Heeres 1896 bis heute*, Motorbuch Verlag, Stuttgart 1976
- Walter J. Spielberger, *Spezial-Panzer-Fahrzeuge des deutschen Heeres*, Motorbuch, Stuttgart 1977
- Isabell Sprenger, *Groß-Rosen. Ein Konzentrationslager in Schlesien*, Böhlau Verlag, Köln/Weimar/Wien 1996
- Elisa Springer, *Il silenzio dei vivi. All'ombra di Auschwitz, un racconto di morte e di risurrezione*, Marsilio Editore, Venedig 1997
- Hildegard Springer, *Das Schwert auf der Waage*, Vowinkel, Heidelberg 1953
- Wilhelm Stäglich, *Der Auschwitz-Mythos. Legende oder Wirklichkeit? Eine kritische Bestandsaufnahme*, Grabert-Verlag, Tübingen 1979; 2<sup>nd</sup> ed., Historical Review Press, Brighton 1984
- Wilhelm Stäglich, *Die westdeutsche Justiz und die sogenannten NS-Gewaltverbrechen*, Deutscher Arbeitskreis Witten, Witten 1978
- Wilhelm Stäglich, *The Auschwitz Myth: A Judge Looks at the Evidence*, Institute for Historical Review, Newport Beach, CA 1986
- State Museum of Auschwitz-Birkenau (ed.), *Auschwitz. Il campo nazista della morte*, Auschwitz 1997
- State Museum of Auschwitz-Birkenau (ed.), *Contribution à l'histoire du KL-Auschwitz*, Auschwitz w/o year
- State Museum of Auschwitz-Birkenau (ed.), *Memorial Book. The Gipsies at Auschwitz-Birkenau*. K.G. Sauer, München-London-New York-Paris 1993
- Jean-François Steiner, *Treblinka*, Stalling, Oldenburg 1966
- Jean-François Steiner, *Treblinka, la révolte d'un camp d'extermination*, Fayard, Paris 1966
- Rolf Steininger (ed.), *Der Umgang mit dem Holocaust*, v. 1, Böhlau, Vienna 1994
- Hartmut Stern, *Jüdische Kriegserklärungen an Deutschland*, FZ-Verlag, Munich 2000
- Kenneth S. Stern, *Holocaust Denial*, American Jewish Committee, New York 1993
- Stiftung Topographie des Terrors Berlin (ed.), *Gedenkstätten-Rundbrief* no. 68, Berlin, October 1995
- Ellery C. Stowell, *International Law*, Holt, New York 1931
- Wolfgang Strauss, *Unternehmen Barbarossa und der russische Historikerstreit*, Herbig, München 1998
- Dietrich Strothmann, *Nationalsozialistische Literaturpolitik*, 3<sup>rd</sup> ed., Bouvier, Bonn 1985
- Karl Strupp, *Wörterbuch des Völkerrechts*, v. I + II, de Gruyter, Berlin 1924f.
- Günther Stübiger, *Der Priebke-Prozeß in Italien*, Schriftenreihe zur Geschichte und Entwicklung des Rechts im politischen Bereich, issue 5, Deutscher Rechtsschutzkreis, Bochum 1996
- Günther Stübiger, *Der Schwammbergerprozeß in Stuttgart*, Schriftenreihe zur Geschichte und Entwicklung des Rechts im politischen Bereich, issue 4, Deutscher Rechtsschutzkreis, Bochum May 1992
- Stutthof. *Das Konzentrationslager*, Wydawnictwo Marpress, Danzig 1996
- [Gaetano?] Sucato, *Istituzioni di diritto penale militare*, v. II, [Stella?] Roma 1941
- Anthony Summers, Tom Mangold, *The File on the Tsar*, Victor Gollancz Ltd., London 1976
- Summing Up*, Judge Advocate 3-5-1947 in Venedig, Extract
- Victor Suvorov, *Der Tag M*, Klett-Cotta, Stuttgart 1995
- Victor Suvorov, *Icebreaker: Who Started the Second World War?*, Hamish Hamilton, London 1990
- Stefan Szende, *Der letzte Jude aus Polen*, Europa-Verlag, Zürich 1945
- Telford Taylor, *The Anatomy of the Nuremberg Trials*, Little, Boston 1992
- Nechama Tec, *Defiance, the Bielski Partisans*, Oxford University Press, New York 1993
- Boris S. Telpuchowski, *Die Geschichte des Grossen Vaterländischen Krieges 1941-1945*, Bernard & Graefe Verlag für Wehrwesen, Frankfurt/Main 1961
- The People's Verdict*, Hutchinson & Co., London 1944
- The Trial in the Case of the Atrocities Committed by the German Fascist Invaders and their Accomplices in Krasnodar and Krasnodar Territory, July 14 to 17, 1943*, Foreign Languages Publishing House, Moscow 1943
- Serge Thion, *Vérité Historique ou vérité politique?*, La Vielle Taupe, Paris 1980
- Alfred R. Tidow, *Der Schuldbegriff im englischen und nordamerikanischen Strafrecht*, Röhrscheid, Bonn 1952
- Ralf Tiemann, *Der Malmedy-Prozeß*, Munin, Osnabrück 1990
- Henry Tompson, *Die moderne Leichenverbrennung*, Fischers Medizinische Buchhandlung, Berlin 1899
- Ernst Topitsch, *Stalins Krieg*, 2<sup>nd</sup> & 3<sup>rd</sup> ed., Busse Seewald, Herford 1990/1998
- Ernst Topitsch, *Stalin's War*, Fourth Estate, London 1987
- Hans J. Torke (ed.), *Forschungen zur osteuropäischen Geschichte*, v. 34, Harrassowitz, Wiesbaden 1984
- Trials of War Criminals Before the Nuernberg Military Tribunals*, Washington, DC, 1949-1953
- Ukrainian National Association (ed.), *Ukraine, a Concise Encyclopedia*, University of Toronto Press, Toronto 1971
- Ullmanns Encyklopädie der technischen Chemie*, v. 13, Urban & Schwarzenberg, Munich 1962; v. 18, Verlag Chemie, Weinheim 1979

- United States Strategic Bombing Survey, Morale Division, Medical Branch Report, *The Effect of Bombing on Health and Medical Care in Germany*, War Department, Washington 1945
- United States Strategic Bombing Survey, *Oil Division Final Report*, War Department, Washington 1947
- United States Strategic Bombing Survey, *The German Oil Industry Ministerial Report Team 78*, War Department, Washington 1947
- United States War Department General Staff (ed.), *Rules of Land Warfare*, Govt. Print. Off., Washington 1914-1915; 2<sup>nd</sup> ed., *ibid.*, 1917
- Freda Utley, *The High Cost of Vengeance*, Regnery, Chicago 1949
- Henri D. de Vabres, *Précis de droit criminel*, 2<sup>nd</sup> ed., Dalloz, Paris 1951
- Henri D. de Vabres, *Rechtsgutachten*, June 25, 1949
- Ernst Vanselow, *Völkerrecht*, Mittler, Berlin 1931
- E. Varlin, *Israël souviens toi! Think of it, Israel! Israel denke daran!*, E. Varlin Edition, Paris 1935
- F. J. P. Veale, *Advance to Barbarism*, Institute for Historical Review, Newport Beach, CA, 1983
- Herbert Verbeke (ed.), *Auschwitz: Nackte Fakten*, Vrij Historisch Onderzoek, Berchem 1995
- Herbert Verbeke (ed.), *Kardinalfragen zur Zeitgeschichte*, Vrij Historisch Onderzoek, Berchem 1996
- Verbrecherische Ziele – verbrecherische Mittel!*, Foreign Language Publication House, Moscow 1963
- Alfred Verdross, *Völkerrecht*, 2<sup>nd</sup> ed., Springer, Vienna 1950
- Veröffentlichungen des Großdeutschen Verbandes der Feuerbestattungsvereine*, no. 5, self-pub. by the organization, Königsberg/Prussia 1932
- Rolf Vogel (ed.), *Ein Weg aus der Vergangenheit*, Ullstein, Frankfurt/Main 1969
- Rudolf Vrba, *I Cannot Forgive*, Bantam Books, Toronto 1964
- Hans Wahls, *Zur Authentizität des 'Wannsee-Protokolls'*, Zeitgeschichtliche Forschungsstelle, Ingolstadt 1987
- Jost Walbaum (ed.), *Kampf den Seuchen! Deutscher Ärzte-Einsatz im Osten*, Deutscher Osten, Krakow 1941
- Eduard von Waldkirch, *Das Völkerrecht*, Helbing und Lichtenhahn, Basel 1925
- Udo B. Walendy, *Auschwitz im IG-Farben-Prozeß*, Verlag für Volkstum und Zeitgeschichtsforschung, Vlotho 1981
- Udo B. Walendy, *Bild- 'Dokumente' für die Geschichtsschreibung?*, Verlag für Volkstum und Zeitgeschichtsforschung, Vlotho 1973
- Udo B. Walendy, *Europa in Flammen*, v. II, Verlag für Volkstum und Zeitgeschichtsforschung, Vlotho 1967
- Udo B. Walendy, *Wahrheit für Deutschland*, 3<sup>rd</sup> ed., Verlag für Volkstum und Zeitgeschichtsforschung, Vlotho 1976
- Alfons Waltzog, *Recht der Landkriegsführung*, Vahlen, Berlin 1942
- Joachim F. Weber (ed.), *Armee im Kreuzfeuer*, Universitas, Munich 1997
- Jürgen Weber, Peter Steinbach (eds.), *Vergangenheitsbewältigung durch Strafverfahren?*, Olzog, Munich 1984
- Ingrid Weckert, *Feuerzeichen*, Grabert, Tübingen 1981
- Ingrid Weckert, *Flashpoint: Kristallnacht 1938 – Instigators, Victims and Beneficiaries*, Institute for Historical Review, Newport Beach, CA, 1991
- Wegmann, Ercolani, *Über Leichenverbrennung als rationellste Bestattungsart*, Cäsar Schmidt, Zürich 1874
- Bernd Wegner (ed.), *Zwei Wege nach Moskau*, Piper, Munich 1991
- Karl A. Weigt, *Almanach der Feuerbestattung*, self-pub. by author, Hannover 1909
- Richard von Weizsäcker, *Vier Zeiten. Erinnerungen*, Siedler, Berlin 1997
- Hans-Herbert Wellhöner, *Allgemeine und systematische Pharmakologie und Toxikologie*, Springer Verlag, Berlin 1988
- Heinrich Wendig, *Richtigstellungen zur Zeitgeschichte*, issues 2, 3, 5, 8 & 10, Grabert, Tübingen 1991-1993, 1995, 1997
- Gerhard Werle, Thomas Wandres, *Auschwitz vor Gericht. Völkermord und bundesdeutsche Strafrecht*, Beck, München 1995
- Steffen Werner, *Die 2. babylonische Gefangenschaft*, self-published by author, Pfullingen 1990; 2<sup>nd</sup> ed. Grabert, Tübingen 1991
- Karlhans Wesche, *Baustoffe für tragende Bauteile*, 2 vols., Bauverlag, Wiesbaden 1977
- Erhard R. Wiehn (ed.), *Die Schoah von Babi Yar*, Hartung-Gorre, Constance 1991
- Jankiel Wiernik, *A year in Treblinka*, American Representation of the General Jewish Workers' Union of Poland, New York 1944
- Elie Wiesel, *Die Nacht zu begraben, Elisha*, Ullstein, Berlin 1962
- Elie Wiesel, *La Nuit*, Les Editions de Minuit, Paris 1958
- Elie Wiesel, *Paroles d'Étranger*, Editions du Seuil, Paris 1982
- Elie Wiesel, *The Jews of Silence*, New American Library, New York 1972
- Simon Wiesenthal, *KZ Mauthausen*, Ibis-Verlag, 1946
- Simon Wiesenthal, *Recht, nicht Rache*, Ullstein, Frankfurt/Main 1991
- Hans-Heinrich Wilhelm, Lecture given at the International History Conference at the University of Riga, September 20-



- 22, 1988
- Wolfgang Wirth, Christian Gloxhuber, *Toxikologie*, Georg Thieme Verlag, Stuttgart 1985
- Anna Wiśniewska, Czesław Rajca, *Majdanek Lubelski obóz koncentracyjny*, Państwowe Muzeum na Majdanku, Lublin 1996
- World Jewish Congress (ed.), *Lest we forget*, Spett Printing Co., New York 1943
- World Jewish Congress et al. (eds.), *The Black Book: The Nazi Crime Against the Jewish People*, New York 1946; reprint by Nexus Press, New York 1981
- World Jewish Congress et al. (eds.), *The Black Book of Polish Jewry*, Roy Publishers, New York 1943
- Joseph Wulf, *Aus dem Lexikon der Mörder. 'Sonderbehandlung' und verwandte Worte in nationalsozialistischen Dokumenten*, S. Mohn, Gütersloh 1963
- David P. Wyman (ed.), *America and the Holocaust*, volume 12, Garland, New York/London 1990
- Leni Yahil, *The Holocaust*, Oxford University Press, New York 1990
- Chuck Yeager, *Yeager. An Autobiography*, Bantam Books, New York 1985
- Alfred M. de Zayas, *The German Expellees: Victims in War and Peace*, St. Martin's Press, New York 1993
- Alfred M. de Zayas, *Die Wehrmachtsuntersuchungsstelle*, 4<sup>th</sup> ed., Ullstein, Frankfurt/Main/Berlin 1984
- Zeitgeschichtliche Forschungsstelle Ingolstadt (ed.), *Der Fall Rose. Ein Nürnberger Urteil wird widerlegt*, Mut-Verlag, Asendorf 1988
- Christian Zentner, *Adolf Hitler, Mein Kampf*, Delphin, München 1979
- Central Commission for Investigation of German Crimes in Poland, *German Crimes in Poland*, Howard Fertig, New York 1982
- Kurt Ziesel, *Der rote Rufmord*, Schlichtenmayer, Tübingen 1961
- Günter Zimmermann (ed.), *Bauschäden Sammlung*, Band 4, Forum-Verlag, Stuttgart 1981
- Efraim Zuroff, *Beruf: Nazijäger. Die Suche mit dem langen Atem*, Ahriman, Freiburg 1996

# Index

Individuals only. Entries in footnotes as italics.

## — A —

Adler, Hans G.: *131, 206, 357*  
Adorno, Theodor: *17*  
Agde, Günter: *297*  
Aigner, Dietrich: *567*  
Ainsztein, Reuben: *477*  
Alich, M. Andrew: *353*  
Allen, Andrew: *130, 500*  
Aloshin, Prof.: *506, 519*  
Altmann, Dr.: *472*  
Ambrose, Stephen E.: *48*  
Anders, Wladyslaw: *270*  
Anderson, E. L.: *580*  
Anthon, Gunther: cf. Deckert,  
Günter  
Anstötz, Christoph: *18, 32*  
Anzilotti, Dionisio: *531*  
App, Austin J.: *580, 581*  
Arad, Yitzhak: *272, 438, 455, 457,*  
*477, 480, 484, 487, 489, 491,*  
*492, 494, 496*  
Arena, Jay M.: *450*  
Arendt, Hannah: *107, 108, 111,*  
*121, 128, 181, 443*  
Aretz, Emil: *121, 571*  
Armstrong, John A.: *553*  
Arndt, Ino: *46, 203*  
Aron, Raymond: *135*  
Aschenauer, Rudolf: *92, 93, 94, 95,*  
*96, 99, 100, 101, 130, 181, 529,*  
*545, 546, 548*  
Aschenbrenner, Jupp: *101*  
Auerbach, Hellmuth: *84, 338*  
Auerbach, Rachel: *486, 487, 491*  
Augstein, Rudolf: *48*  
Augustin: *443, 457*  
Aumeier, Hans: *341, 357*  
Auron, Yair: *116*  
Avenarius, Ferdinand: *243*  
Ayaß, Wolfgang: *252*  
Aynat, Enrique: *88, 186, 305, 338,*  
*583*

## — B —

Baader, E. W.: *466*  
Baader, Roland: *18*  
Bacher, G.: *18*  
Bach-Zelewski, Erich von dem: *94*

Bäcker, Knud: *115, 306*  
Backes, Uwe: *18, 21, 199, 338,*  
*374, 554*  
Bacque, James: *48, 91, 97, 248,*  
*309*  
Bader, K. S.: *106, 107*  
Badinter, Robert: *134*  
Baer, Richard: *149*  
Bagh, K. v.: *466*  
Bahners, Patrick: *51*  
Bailar, John C.: *353*  
Bailer, Josef: *338, 339, 359, 365,*  
*435, 468, 560*  
Bailer-Galanda, Brigitte: *69, 339,*  
*435, 560*  
Baldajewa, Dantschik: *217*  
Baldwin: *92*  
Ball, John C.: *37, 44, 56, 73, 87,*  
*150, 163, 191, 199, 237, 254,*  
*259, 270, 272, 277, 344, 346,*  
*348, 362, 364, 411, 412, 477,*  
*478, 504, 553, 570*  
Barbie, Klaus: *139*  
Bardèche, Maurice: *98*  
Barett, David B.: *30*  
Barnes, Harry Elmer: *579, 580*  
Baron, Salo W.: *115*  
Barth, H.: *105*  
Bartholomew, C.H.: *353*  
Barton, Russell: *301*  
Bastian, Till: *35*  
Battisti, Judge: *473*  
Bauck, Erling: *306*  
Bauer, Erich: *118*  
Bauer, Fritz: *121*  
Bauer, Max: *125*  
Bauer, Yehuda: *10, 11, 33, 212,*  
*289*  
Baum, Bruno: *115, 305, 306*  
Baum, Gerhard: *88*  
Baumann, J.: *86*  
Baynac, Jacques: *44, 127*  
Becker, August: *222, 224, 226,*  
*228, 229, 230, 236, 463, 465*  
Becker, Fritz: *47, 197, 552*  
Beer, Mathias: *215, 216, 217, 221,*  
*238*  
Behling, Kurt: *537*

Behrens, Michael: *17, 18*  
Behringer, Wolfgang: *125*  
Beisel, Daniel: *23, 568, 575*  
Bellinger, Joseph: *128*  
Bendel, Charles S.: *136, 356, 357*  
Bender, Rolf: *86, 87, 107, 111,*  
*126, 127, 174, 175*  
Beneš, Edward: *8, 34*  
Benroubi, Maurice: *140*  
Benton, Wilbourn E.: *98*  
Benz, Wolfgang: *29, 30, 46, 69,*  
*130, 131, 181, 182, 183, 184,*  
*185, 186, 187, 188, 189, 190,*  
*191, 192, 193, 194, 195, 196,*  
*197, 198, 199, 200, 201, 202,*  
*203, 204, 205, 211, 212, 339,*  
*435, 437, 482, 519, 560, 565,*  
*566*  
Berben, Paul: *298*  
Berdych, Vaclav: *253*  
Berenbaum, Michael: *11, 38, 55,*  
*409*  
Berendsohn, Walter A.: *182*  
Berg, Friedrich Paul: *42, 55, 56,*  
*83, 195, 199, 217, 218, 219, 228,*  
*229, 239, 265, 351, 361, 435,*  
*450, 467, 485, 528*  
Berg, Isai D.: *217, 465*  
Berg, Uwe: *567*  
Berger, L. B.: *445*  
Bergschicker, Heinz: *247, 261*  
Bergt, Wolfgang: *24*  
Bernadotte: *539*  
Bernfus, Erich: *75, 80, 240, 331,*  
*340*  
Bestic, Alan: *139*  
Bettioli, Guiseppe: *544, 550*  
Beutinger, Emil: *376, 380*  
Beyer, Wilhelm R.: *222*  
Bezwinska, Jadwiga: *411*  
Biedermann, Charles: *172*  
Billig, Joseph: *287*  
Bily, Henry: *140*  
Birett, Karl: *360, 451*  
Birkenmaier, Werner: *24*  
Birn, Ruth Bettina: *44*  
Bischoff, Erich: *555*  
Bischoff, G.: *48*

- Bischoff, Karl: 71, 394, 402  
 Bjorklund, David F.: 90  
 Blaha, Franz: 301  
 Blandy, Admiral: 546  
 Blech, Benjamin: 182  
 Blobel, Paul: 412, 516, 566  
 Bloch, R.: 211  
 Bloch, Sam E.: 270  
 Blum, Léon: 306, 307  
 Bluntschli, Johann C.: 539, 541  
 Boberach, Heinz: 178, 311, 314  
 Bobrenjow, Wladimir: 217  
 Bock, Ludwig: 110  
 Böck, Richard: 131, 357  
 Böckenförde, Prof.: 147, 148, 149, 176  
 Boehlke, Hans-Kurt: 343  
 Bohlinger, Roland: 36  
 Boisdefeu, Jean-Marie: 88, 186, 347  
 Bölke, P.: 190  
 Bonhoeffer, Emmi: 110, 112, 122, 131  
 Bonwetsch, Bernd: 551  
 Boog, Horst: 197, 552  
 Boor, Wolfgang de: 25  
 Borodansky-Knysh, Yelena: 510  
 Botz, Gerhard: 258  
 Bour, Henri: 460  
 Brack, Viktor: 437  
 Braham, Randolph L.: 212  
 Braker, William: 367, 440  
 Brattli: 306  
 Brech, Martin: 91  
 Breitman, Richard D.: 42, 202  
 Breitwieser, Johann A.: 76, 366  
 Brentar, Jerome A.: 476  
 Breymesser, Hermann: 75, 80, 240, 331, 340  
 Brinkley, David: 435, 476  
 Broad, Pery S.: 341, 343, 357, 411, 432  
 Bronder, Dietrich: 13, 32  
 Broszat, Martin: 33, 35, 39, 40, 49, 96, 103, 106, 130, 131, 153, 182, 191, 202, 222, 247, 258, 302, 404  
 Browning, Christopher R.: 10, 33, 212  
 Brugnioni, Dino A.: 275, 277, 279  
 Brunner, Manfred: 23, 569  
 Bruns, Cornelia: 531  
 Buchanan, Patrick: 435, 475, 476  
 Buchheim, Hans: 106, 153  
 Buki, Milton: 371  
 Burg, Josef G.: 11, 105, 117, 187, 195, 524  
 Burger, Adolf: 171  
 Burgess, F.: 450  
 Bush, George sen.: 476  
 Bustamente Sirven, Antonio S. de: 531  
 Buszko, Jozef: 97, 357  
 Butler, Rupert: 96, 341  
 Butz, Arthur R.: 8, 9, 34, 35, 36, 72, 121, 128, 183, 190, 191, 286, 338, 571, 580, 581  
 — C —  
 Caidin, Martin: 270  
 Cain: 285  
 Camon, Ferdinando: 142  
 Camps, Francis E.: 441  
 Caroll, Earl J.: 100  
 Carter, Jimmy: 472  
 Carto, Elisabeth: 581  
 Carto, Willis A.: 58, 579  
 Cavaglieri: 531  
 Cavaré, Louis: 531  
 Chaitkin, A.: 43  
 Challen, Stephen: 207, 208  
 Chamberlin, Brewster S.: 257, 258  
 Charlemagne: 375  
 Chelain, André: 438  
 Chodoff, Paul: 117, 175  
 Chorherr, Thomas: 64  
 Christensen, J.J.: 353  
 Christie, Douglas: 136, 137, 138, 139, 142  
 Christmann, Carl Hermann: 368  
 Christmann, Kurt: 218  
 Christophersen, Thies: 571, 572, 580  
 Churchill, Winston: 7, 8, 34, 532, 536  
 Clair, Bertrand: 339, 360, 365, 560  
 Clarke, Bernard: 96  
 Clarke, Comer: 520  
 Clary, Robert: 140  
 Clay, Lucius D.: 100, 246, 546  
 Cobden, John: 90, 474  
 Cohn-Bendit, Jean-Gabriel: 11  
 Cole, David: 11, 342  
 Colombo, G.: 396  
 Comtesse, F. H.: 548  
 Conan, Eric: 342  
 Connolly, Cyril: 96  
 Conquest, Robert: 34, 528  
 Conway, John S.: 46, 88, 183, 280  
 Corino, Karl: 36  
 Costa, Philippe: 38, 339  
 Countess, Robert H.: 44, 55  
 Courtois, Stéphan: 306  
 Crawford, O. G. S.: 269  
 Cremonini, Cesare: 371  
 Cristoforis, Malachia de: 376  
 Cross, Collin: 35  
 Crowell, Samuel: 80, 87, 331, 340  
 Czech, Danuta: 54, 129, 159, 161, 187, 280, 296, 346, 347, 356, 385, 387, 404, 407, 409, 411, 412  
 Czernin, Wolfgang: 363  
 Czesany, Maximilian: 49, 243, 266  
 Czurda, K.: 354  
 — D —  
 Dahmen-Oberbossel, Ulla: 151  
 Dalzell, R. W.: 445  
 Daniel, Prophet: 476  
 Daniltschenko, H.: 471  
 Dashkevich, Raissa G.: 507  
 Dassié, J.: 269  
 Däubler-Gmelin, Herta: 22  
 Daunderer, Max: 351, 450, 451  
 David, David: 202  
 David, Douglas: 43  
 David, King: 32, 252, 493  
 Davies, W. J. L.: 215, 463  
 Davis, Rogers F.: 444, 446, 451  
 Dawidowicz, Lucy S.: 222  
 Deana, Franco: 55, 72, 73, 280, 339, 373, 431  
 Deckert, Günter: 25, 49, 51, 110, 568, 575  
 Deckert, Walter: 353  
 Dejaco, Walter: 412  
 Demant, Ebbo: 120  
 Demjanjuk, Ivan: 436, 454. cf. Demjanjuk, John  
 Demjanjuk, John: 29, 36, 111, 112, 115, 116, 122, 133, 139, 175, 435, 438, 440, 468, 471, 472, 473, 474, 475, 476, 489, 490, 518, 528  
 Denning, Helmut: 158  
 Desjardins, Daniel D.: 133, 183  
 Detlefs, Gerhard: 18  
 Deuel, Leo: 269  
 Diamond, Denis: 46  
 Diestel, Barbara: 39  
 Diwald, Hellmut: 15, 102, 572  
 Dollinger, Hans: 254, 261

- Dommergue, Roger-Guy: 11  
 Donat, Alexander: 256, 455, 457, 477, 478, 480, 484, 486, 487, 489, 491, 492, 494, 496, 497  
 Dönitz, Karl: 533  
 Doperchuk: 385  
 Dor, Milo: 254, 261  
 Dorf, Eric: 437  
 Dörner, Klaus: 31  
 Dorovius, E.: 376  
 Dötzer, Walter: 314, 316, 351, 415  
 Dower, John W.: 265  
 Draber, Armin: 120  
 Dragan, Myrosław: 45, 121, 411, 469, 502, 503  
 Dreher, Eduard: 23, 568  
 Dreßen, Willi: 262, 477, 512  
 Dreyfus, Alfred: 475  
 Drosihn, Joachim: 136  
 Drost, Heinrich: 531  
 Dürrenmatt, Friedrich: 57  
 Dusek, Peter: 258  
 Dwork, Deborak: 55, 311, 342  
 Dworkin, Ronald: 23, 569, 577
- E —  
 Eckardt: 410  
 Eckermann, Erik: 460, 461  
 Edginton, J.A.G.: 450  
 Edmonds, J. E.: 534, 547  
 Edmunds, Sterling E.: 539  
 Egel, Siegfried: 244  
 Ehrenburg, Ilya: 181, 306, 506, 508, 509, 522, 528, 564, 566  
 Ehrhardt, Arthur: 182  
 Ehrlich, Ernst L.: 203  
 Eibicht, Rolf-Josef: 15, 24, 27, 572  
 Eichmann, Adolf: 107, 108, 110, 113, 118, 122, 128, 129, 130, 137, 140, 181, 255, 256, 443, 462, 472, 520  
 Eicke: 384  
 Eigruber, August: 101  
 Einstein, Albert: 455  
 Einstein, Sergei: 255, 256, 261  
 Eirenschmalz: 75, 81  
 Eisenbach, Artur: 479  
 Eisenhower, Dwight D.: 8, 309  
 Eisenschimmel, Hans: 148, 171  
 Eisert, Wolfgang: 97  
 Eitan, Dov: 473, 474  
 Elgort, Nesya: 509  
 Elinski, C.: 306  
 Elisha: 141, 144
- Elliott, Martin A.: 444, 445, 446, 451  
 Elon, Amos: 116  
 Emmerling, E.: 353, 560  
 Engelking, Barbara: 55  
 Engerth, Karl von: 376  
 Epifanow, Alexander E.: 97, 219, 552  
 Ercolani: 375  
 Ernst, Tilman: 122, 258  
 Eschwege, Helmut: 249, 251, 261  
 Etzbach, Hugo: 379  
 Evenson, Sarra: 515  
 Everett, William M.: 92, 94  
 Exner, Franz: 533, 540  
 Eyrich, Heinz: 172
- F —  
 Fabian: 167  
 Factor, H.: 209  
 Fairhall, L.T.: 450  
 Fajnzylberg, Alter S.: 136, 374  
 Falbe, Jürgen: 451  
 Falkenhausen, General von: 537, 538, 539, 541, 546  
 Fauchille, Paul: 534, 539, 540, 541, 543, 544  
 Faurisson, Robert: 7, 9, 12, 16, 27, 28, 38, 40, 44, 56, 88, 89, 90, 96, 101, 127, 129, 134, 135, 136, 141, 187, 201, 205, 258, 266, 301, 303, 337, 338, 339, 341, 343, 346, 581  
 Favez, Jean-Claude: 287  
 Federmann, Reinhard: 254, 261  
 Fedorenko, Feodor: 471  
 Feinsilber, Alter: 136, 374  
 Feldenkirchen, Wilfried: 318  
 Felderer, Ditlieb: 9, 88, 128, 341, 438, 581  
 Fenchel, E. M.: 218, 220  
 Fénelon, Fania: 140  
 Fenichel: 218  
 Ferch, Horst: 354  
 Ference, Tone: 488  
 Fest, Joachim C.: 35  
 Festge-Weinrother, H.: 25  
 Fichtl, engineer: 381  
 Fiebelkorn, Heinz: 460  
 Finke, Friedrich: 338  
 Finkelstein, Norman G.: 44, 56, 117, 211  
 Firestone, Renée: 55  
 Fisch, Jörg: 208
- Fischer, Horst: 69, 77, 358  
 Fischer, Joschka: 50  
 Fisher, Eugene J.: 55  
 Fitzgibbon, Louis: 581  
 Fleck, Egon W.: 295  
 Fleischhauer, Ingeborg: 47  
 Fleischmann, Max: 534, 539, 543  
 Fleming, Gerald: 38, 216, 238, 311, 344  
 Flore: 539  
 Florstedt, Hermann: 295, 526  
 Floss, Herbert: 490, 492  
 Flury, Ferdinand: 350, 351, 423  
 Folco, Michel: 141  
 Forth, Wolfgang: 76, 350, 439, 450  
 Foster, J. F.: 466  
 Frank, Anne: 581  
 Frank, Hans: 54, 96, 101  
 Frank, R.: 544  
 Frank, Reinhard: 215, 240  
 Frankfurter, Felix: 8  
 Franz, Kurt: 121, 468, 477, 484, 489  
 Franz-Willing, Georg: 17  
 Frei, Norbert: 43, 248  
 Freimark, Jakob: 148, 150, 154, 155, 156, 157, 158, 159, 160, 161, 162, 164, 165, 166, 167, 168, 169, 170, 171, 172, 173, 174, 175, 177, 178  
 Freund, Florian: 38, 83  
 Frey, Gerhard: 245, 246, 247, 249  
 Friedländer, Saul: 33, 35, 468  
 Friedman, Arnold: 138, 142  
 Friedman, Filip: 128, 131  
 Friedman, Tuviah: 474  
 Friesel, Evyatar: 209  
 Fritsch, Theodor: 555  
 Fritzsche, Hans: 101  
 Froeschmann, G.: 92  
 Fromme, Friedrich K.: 51, 146, 147, 176  
 Fuchs, Erich: 440, 455, 467  
 Fuchs, H. H.: 85, 337  
 Furbank, R.A.: 442  
 Furet, François: 135
- G —  
 Gagern, Heinrich von: 13  
 Galasso: 530  
 Galilei, Galileo: 371  
 Galinski, Heinz: 81, 118  
 Gall, Lothar: 264  
 Ganter, W.: 351

- Garaudy, Roger: 55  
 Garner, James F.: 17  
 Gärtner, Michael: 40, 311, 326, 339, 348, 411  
 Gassner, Ludwig: 239, 462  
 Gaulle, Charles de: 8, 34  
 Gaus, Friedrich W.: 94, 99  
 Gauss, Ernst: 39, 52, 56, 59, 61, 81, 88, 213, 249, 257, 284, 338, 369, 373, 413, 450, 563, 564, 565, 566, 576  
 Gauweiler, Peter: 43  
 Geiss, Imanuel: 15  
 George, George St.: 249  
 Gerhard, Rüdiger: 28, 104, 111, 113, 117, 118, 145, 171, 190  
 Gerland, Heinrich B.: 530  
 Gerner, Manfred: 311, 340  
 Gerstein, Kurt: 83, 88, 436, 438, 439, 440, 441, 443, 452, 453, 455, 456, 457, 458, 467, 468, 488, 493, 528, 581  
 Gheorge, Jon: 91  
 Gierlich, H.: 104  
 Gilbert, Martin: 130  
 Gilbert, S.: 453  
 Gillessen, Günter: 24, 116  
 Ginzburg, Josef G.: cf. Burg, Josef G.  
 Glass, Kurt: 129  
 Glazar, Richard: 477, 482, 487, 491, 492  
 Gleispach, Wenzelslaus K. M. M. von: 549  
 Glicksman, Alan: 209  
 Globocnik, Odilio: 437  
 Gloxhuber, Christian: 350  
 Glücks, Richard: 289, 303, 304  
 Glueck, Sheldon: 539, 546  
 Goebbels, Joseph: 32, 54, 564  
 Goebel, Klaus: 21  
 Golczewski, Frank: 437  
 Gold, Trudy: 55  
 Goldfarb, Abraham: 440  
 Goldhagen, Daniel J.: 24, 43, 44, 54  
 Goldhagen, Erich: 33  
 Goldman, Ari L.: 128  
 Goll, Ulrich: 574  
 Gorbacheva, N. T.: 513, 520  
 Göring, Hermann: 101, 461, 462  
 Goshen, Seev: 33  
 Göth, Ammon: 259  
 Graber, Doris A.: 532  
 Grabert, Wigbert: 25, 572, 573, 575, 576, 581  
 Grabitz, Helge: 108, 110, 111, 112, 113, 117, 119, 120, 121, 122, 131  
 Gradovski, Salman: 161  
 Graf, Jürgen: 9, 40, 41, 88, 119, 141, 144, 190, 283, 286, 298, 299, 300, 307, 339, 340, 343, 354, 358, 365, 366, 385, 398, 401, 413, 414, 433, 436, 457, 471, 479, 480, 495, 499, 573  
 Graf, Unterscharführer: 154, 168, 169  
 Graff, Michael: 64, 65, 82  
 Graham, James P.: 450  
 Graml, Hermann: 32, 194  
 Granata, Russell: 413  
 Gray, judge: 367  
 Green, Richard J.: 339, 353, 368, 369, 370, 371  
 Greil, Lothar: 98  
 Grenier, R.: 523  
 Grieb, Conrad: 351, 456  
 Grieger, Manfred: 190  
 Griffiths, Peter: 139  
 Grigorenko, Pjotr: 217  
 Grill, M.: 24  
 Grimm, Georg: 98  
 Grimm, Jakob: 375  
 Gringauz, Samuel: 115  
 Grosser, Alfred: 243  
 Grosser, D.: 559  
 Grossman, Vassily: 130, 440, 480, 490, 491, 492, 493, 494, 497, 506, 508, 509, 528  
 Grot, Elzbeta: 299  
 Grubach, Paul: 338  
 Gruchmann, Lothar: 31, 102  
 Grussendorf, Oscar W.: 240  
 Grut, Aage: 466  
 Gubala, Wojciech: 10, 338, 370, 560  
 Gudehus, G.: 354  
 Guevara, Che: 17  
 Guggenheim, Paul: 531, 534, 543, 545  
 Gumz, W.: 466  
 Gutman, Yisrael: 38, 212, 308, 409, 502, 506  
 Gysecke, G.: 529  
 — **H** —  
 Haag, Friedrich E.: 351  
 Haase, G. B.: 537  
 Häberle, Wolfgang: 338  
 Habermann, Gerd: 18  
 Hackenholt, Lorenz: 438. cf. Heckenholt, Unterscharführer  
 Hackert, Wolfgang: 183  
 Hackmann: 307  
 Hackworth, Green H.: 531, 533, 535, 536, 539  
 Haensel, Carl: 98  
 Hafer, Ernst: 461, 462  
 Hagen, W.: 351  
 Haggard, Howard W.: 441, 448  
 Haidn, Carl: 99  
 hair: 367  
 Haldane, John S.: 440, 448  
 Halow, Joseph: 93  
 Hammer: 538, 539  
 Hammer, Armand: 472  
 Hankey, Maurice P. A.: 532, 546, 547  
 Hankins, Frank H.: 182  
 Hanusiak, Michael: 471  
 Harder, Egon F.C.: 257  
 Hardesty, Michael: 580  
 Hargis, Jonnie A.: 128  
 Hart, Kitty: 55  
 Hartl, Adalbert: 513  
 Härtle H.: 98, 128  
 Harwood, Richard: 128, 182, 580  
 Hase, Professor Dr.: 318  
 Hasper, Egmont: 530  
 Hass, Karl: 530  
 Hatschek, Julius: 541, 544  
 Haulot, Arthur: 248, 297  
 Hausner, Gideon: 146  
 Haworth, D.T.: 353  
 Hayek, F. A.: 60  
 Hayward, Joel Stephen A.: 11  
 Hecht, O.: 351  
 Heckenholt, Unterscharführer: 438, 455  
 Heddeshimer, Don: 182  
 Heepke, Wilhelm: 75, 376, 381, 391, 392, 396, 400  
 Heer, E.: 30  
 Heer, Johannes: 260, 261, 264, 524  
 Hegelmann, Rainer: 18  
 Heidborn, Anton: 512  
 Heide, Hans von der: 91  
 Heinze, Kurt: 532, 533, 546, 547, 550  
 Helfgott, Ben: 55  
 Hellwig, Friedrich: 378, 379

- Helmrich: 147  
 Henderson, Yandell: 440, 441, 448  
 Henkel, Heinrich: 544  
 Henkys, Reinhard: 86, 97, 104, 105, 106, 111, 117, 119, 123  
 Hénocque, Georges: 301  
 Henschler, Dietrich: 76, 350, 439  
 Hepp, Robert: 15, 27, 58  
 Heppel: cf. Soldan, Wilhelm G.  
 Herbricht, Michael: 574  
 Herrmann, Hajo: 43, 66, 124  
 Herzl, Theodor: 13  
 Herzog, Roman: 57, 291  
 Herzogenrath-Amelung, Günther: 51  
 Hesse, Erich: 553  
 Heuser, Luise: 190  
 Hey, Bernd: 122  
 Heydrich, Reinhard: 229, 526, 553  
 Heywood, John B.: 464  
 Hiess, Joseph: 91  
 Hilberg, Raul: 9, 10, 32, 74, 76, 81, 91, 98, 99, 101, 138, 182, 290, 300, 303, 436, 437, 438, 468, 469, 484, 515  
 Hildebrandt, Klaus: 264  
 Hillebrecht, Harald: 56  
 Hillgruber, Andreas: 551  
 Himmler, Heinrich: 7, 54, 206, 207, 248, 289, 292, 294, 296, 388, 412, 474, 489, 490, 496, 564  
 Hinsley, Francis H.: 43  
 Hirsch, Martin: 123  
 Hirsch, Rudolf: 104  
 Hitchens, Christopher: 10, 11  
 Hitler, Adolf: 7, 8, 15, 18, 24, 32, 33, 34, 35, 36, 43, 44, 47, 49, 54, 62, 63, 102, 123, 135, 182, 197, 207, 216, 246, 252, 287, 291, 339, 369, 424, 461, 465, 490, 515, 535, 548, 552, 553, 555, 564  
 Ho Chi Min: 17  
 Höfer: 512  
 Hofer, Walther: 153  
 Hoffmann, H.: 23  
 Hoffmann, Heinrich: 493  
 Hoffmann, Joachim: 23, 24, 25, 37, 56, 102, 181, 182, 197, 263, 552, 564, 566, 574  
 Höfle, Hans: 286  
 Hofmeyer, Hans: 137  
 Hoggan, David: 579, 580  
 Hohenzollern, Friedrich II. von, the Great: 62  
 Hohenzollern, Wilhelm I. von: 13  
 Hohenzollern, Wilhelm II. von: 13  
 Höhne, Heinz: 24, 553  
 Hölbinger, K.: 357  
 Holmar, K. C.: 23  
 Holming, Göran: 190  
 Holtz, John C.: 445  
 Homer: 375  
 Hömig, Dieter: 23, 568  
 Honecker, Erich: 305  
 Honsik, Gerd: 65, 69, 70, 73, 281, 358  
 Hoppe, Helmut R.: 532, 533, 534, 535, 536, 538, 539, 541, 543, 544  
 Horkheimer, Max: 17  
 Höß, Rudolf: 10, 96, 101, 130, 131, 137, 308, 341, 355, 358, 404, 411, 412, 437  
 Hössler, Wilhelm: 412  
 Höttl, Wilhelm: 94, 181, 182, 564  
 Hubatsch, Walther: 532  
 Huber, Ernst R.: 548  
 Hubert, Morris: 128  
 Hull, Cordell: 8  
 Humenna, Dokia: 523  
 Humm, Otto: 88, 116  
 Humphrey, Michael: 60  
 Hurn, R.W.: 458  
 Huster, Stefan: 23, 568  
 Hyde, Charles C.: 531, 533, 534, 535, 540, 541, 544, 546
- I —
- Irmscher, Richard: 352  
 Irving, David: 32, 33, 35, 36, 40, 49, 91, 96, 99, 100, 101, 181, 211, 266, 270, 311, 339, 341, 367  
 Itzkoff, Seymour W.: 56  
 Ivan the Terrible: 455, 471, 472, 473, 474, 487, 518. cf. Demjanjuk, John  
 Iwaszko, Tadeusz: 293  
 Izatt, R.M.: 353  
 Izzo, Attilio: 423
- J —
- Jäckel, Eberhard: 31, 33, 36, 184, 272, 280, 307, 468, 477, 482, 502, 555  
 Jackson, Robert H.: 99, 541, 544  
 Jacob, Simone: 134, 187. cf. Veil, Simone  
 Jacobmeyer, Wolfgang: 195  
 Jacobs: 135  
 Jacobsen, Hans-Adolf: 106, 153, 254, 261, 551  
 Jaeckel, Heinz: 20  
 Jäger, Herbert: 119  
 Jagschitz, Gerhard: 65, 69, 70, 71, 72, 73, 74, 75, 76, 77, 80, 81, 82, 281, 343, 358  
 Jährling, Rudolf: 316, 317, 393, 407  
 Jakobsen, S. Bertrand: 505  
 Jakobskötter, Rudolf: 379, 406  
 Jankowski, Stanislaw: 114, 136, 374  
 Janßen, Karl-Heinz: 50  
 Jaubert, Alain: 243, 244  
 Jaurés, Jean: 501  
 Jendryschik, Sepp: 48  
 Jeschek: 539, 543, 546, 548  
 Jesse, Eckhard: 18, 21, 199, 338, 374, 554, 570, 572  
 Jessup: 539  
 Jesus: 85  
 Jodl, Alfred: 501, 516  
 Joffe, J.: 43  
 Johnson, M.F.: 353  
 Jones, E. W.: 382, 383  
 Jones, Edgar L.: 265  
 Jordan, Claus: 28, 123, 139, 145, 155, 162, 163, 164, 166, 170, 171, 177, 178, 179  
 Joshua: 509
- K —
- Kachacinski, Captain: 173  
 Kadell, Franz: 36, 47, 200, 270, 463, 489, 528  
 Kaduk, Oswald: 120  
 Kaganovich, Lazar M.: 528  
 Kagedan, Ian J.: 471  
 Kaindl, Anton: 304  
 Kaldjian, Lauris C.: 32  
 Kalthoff, Jürgen: 351, 352  
 Kaminski, J.: 260  
 Kammerer, Rüdiger: 10, 338  
 Kammler, Hans: 316, 394  
 Kämper, Hermann: 378  
 Kape, J. M.: 354  
 Kapp, W.: 352  
 Kappel, Heiner: 18  
 Kappler, Herbert: 529, 530, 540  
 Karski, Jan: 8  
 Kaskowiak: 136

- Kater, Hermann: 124  
 Katlynyckyj, Voldymyr: 503  
 Kaufman, Theodor N.: 46  
 Kautsky, Benedikt: 295, 297, 305, 307, 308  
 Kaye, Sidney: 439  
 Kayser, H.: 239  
 Keegan, John: 48  
 Kehrig, Manfred: 24  
 Keller, G.: 379  
 Keller, Hans: 377, 379, 399  
 Keller, Rupprecht von: 534, 535, 536, 539, 544  
 Kelsen: 545, 546  
 Kempner, Robert M. W.: 106, 124  
 Keneally, Thomas: 259  
 Kergel, Max J.: 379  
 Kermisz, Józef: 286  
 Kern, Erich: 39, 40, 109, 191, 202  
 Kerr, Tom: 7  
 Kesselring, Albert: 529, 535, 539, 540  
 Kessler, Richard: 377, 378, 379, 380, 381, 382, 383, 394, 395, 398, 399, 401  
 Ketcham, Katherine: 90, 116, 133, 474, 475  
 Keyssar, Helene: 522  
 Khaldei, Yevgeny A: 261  
 Khrushchev, Nikita: 514, 515, 517, 528  
 Kierski, Kazmierz: 171  
 Kirschbaum, Erik: 208  
 Kirschnek, Hans: 403  
 Kissel, Günther: 176  
 Kitchens, James H.: 275  
 Klarsfeld, Beate: 144  
 Klarsfeld, Serge: 144, 186, 187, 188, 190, 265, 277, 291  
 Klee, Ernst: 238, 262, 477, 512  
 Klehr, Josef: 159, 160, 162  
 Klein, Georg: 115  
 Klein, Marc: 309  
 Klein, Theodor: 417  
 Klein, Wilfried: 150, 151, 171, 172, 178  
 Kleist, Peter: 258  
 Kliemt, Hartmut: 18  
 Kliewe, Heinrich: 351  
 Klippel, S.: 87  
 Kluge, Dankwart: 181  
 Knieriem, August von: 91, 93, 94, 98, 99, 100, 101  
 Knobloch, Heinz: 264  
 Knopp, Guido: 518, 519  
 Knott, Dr.: 169  
 Knütter, Hans-Helmut: 17, 261  
 Koch, Ilse: 93, 95, 129, 245, 246  
 Koch, Karl: 129, 295, 526  
 Koch, Oskar W.: 92, 94, 95  
 Koestler, Arthur: 218  
 Kogon, Eugen: 35, 46, 89, 153, 229, 235, 237, 238, 240, 272, 280, 288, 298, 302, 303, 304, 357, 440, 455, 467, 468, 477, 485  
 Kogut, Riva: 507  
 Kohler, Josef: 539  
 Köhler, Manfred: 15, 27, 28, 40, 52, 145, 167, 181, 246, 358, 468  
 Konieczny, Jan: 191, 282  
 Konrad, Christian: 35  
 Konrich, Friedrich: 239, 313  
 Koppel, Helga: 252  
 Korczak, Janusz: 206  
 Korherr, Richard: 207, 208  
 Kori, H.: 377  
 Korn, Moische: 152  
 Korotych, Vitaly: 522  
 Korzec, Michel: 43  
 Kosiek, Rolf: 15  
 Kosmath, E.: 435  
 Kotarbinski, T.: 252, 261  
 Kozial, Michael S.: 550  
 Krakowski, Shmuel: 11  
 Kramer, Josef: 101, 285, 301  
 Krammer, Arnold: 47, 287  
 Kranz, Tomasz: 305, 306  
 Krauch, Carl: 290  
 Kraupner, Hans: 381  
 Kraus, Ota: 140  
 Krause-Vilmar, Dietfrid: 252  
 Krausnick, Helmut: 44, 106, 153, 182, 212, 553  
 Krauss, Ota: 114  
 Krege, Richard: 499  
 Kreisky, Bruno: 16  
 Kremer, Tibère: 388  
 Kretschmer, Werner: 35, 52  
 Kriele, Martin: 52  
 Kröger, Ullrich: 122  
 Krotkov, F. G.: 494  
 Krupp, Alfried von: 100, 530  
 Kruse, Heinrich: 351  
 Krzepicki, Abraham: 478, 492, 494  
 Kubyiovtych, Prof.: 502  
 Küchenmeister, F.: 375, 376  
 Kühle, Barbara: 297  
 Kuhn: 539  
 Kuhn, A.: 36  
 Kühn, Robert: 360, 451  
 Kühnreich, Heinz: 552  
 Kula, Michal: 76  
 Kulaszka, Barbara: 12, 19, 337, 368, 375  
 Kulka, Erich: 140  
 Kulka, Otto D.: 212  
 Kulling, Ruth: 151  
 Kuras, Jan: 250  
 Kurt, Franz: 121  
 Kuznetsov, Anatoly. V.: 510, 511, 518, 522, 524
- L —
- Labedz, Jerzy: 10, 338, 370, 560  
 Lachout, Emil: 25, 26, 39  
 Lachtman, Dennis S.: 453  
 Lackner, Karl: 23, 569  
 Lagacé, Ivan: 73, 74, 375  
 Lambrecht, Wolfgang: 352  
 Lamker, Hans: 311, 332  
 Lang, Jochen von: 443  
 Lang, R. Clarence: 352  
 Langbein, Hermann: 35, 46, 89, 104, 106, 111, 113, 114, 115, 117, 118, 119, 120, 121, 122, 123, 129, 130, 131, 137, 140, 229, 272, 302, 303, 357, 366, 371, 440, 477, 485  
 Lange, Lawrence L.: 129  
 Lange, Peter: 246  
 Lanzmann, Claude: 115, 133, 144, 249  
 Laprecht, R.K.: 18  
 Laqueur, Walter: 8, 35, 283, 285  
 Laska, Werner: 91  
 Laternser, Hans: 28, 106, 107, 108, 109, 110, 112, 114, 118, 119, 122, 534, 535, 536, 538, 539, 540, 541, 543, 544, 545  
 Lauber, Heinz: 32  
 Lauck, John H.: 270  
 Laun, Rudolf von: 530, 531, 532, 533, 534  
 Lautern, Mark: 91, 92, 93, 94, 95, 96, 99, 100, 101  
 Lauterpacht, Hersch: 533, 535, 540, 543, 546, 547  
 Lawrence, W. H.: 505, 506  
 Lazar, Józsefne: 150, 151, 153, 154, 190  
 Leckner, Theodor: 569

- Leclerq, General: 537  
 Ledingham, Ian McA.: 460  
 Lehner, Dieter: 36, 472, 473  
 Lemercier, General: 536  
 Lemkin, Raphael: 35  
 Lenard, Dionys: 305  
 Lengyel, Olga: 140  
 Lenski, Robert: 301  
 Lenz, Dr.: 147  
 Lenzer, Sturmbannführer: 390, 399, 415, 416  
 Leoni, Bruno: 59  
 Leszcinsky, Jacob: 182  
 Leszyńska, Zofia: 298  
 Lettich, André: 140  
 Leuchter, Frederick A.: 9, 10, 39, 41, 65, 84, 136, 191, 303, 337, 338, 339, 350, 352, 353, 362, 364, 367, 368, 370, 374, 375, 414, 419, 482, 575  
 Leutheusser-Schnarrenberger, Sabine: 22  
 Levi, Primo: 88, 141, 142  
 Levitas, Ilia M.: 523  
 Levitas, L.: 507  
 Lévy, Bernard-Henri: 50  
 Lewis, John L.: 445  
 Lichtenstein, Heiner: 97, 104, 105, 106, 107, 109, 110, 111, 112, 114, 117, 118, 119, 120, 121, 122, 123, 127, 129, 468  
 Lill, K.: 357  
 Lincoln, Abraham: 535  
 Lindsey, William B.: 85, 96, 136, 437, 468  
 Lingens-Reiner, Ella: 131, 357  
 Linnas, Karl: 471  
 Lippert: 532, 539, 546  
 Lipstadt, Deborah E.: 40, 55, 311, 339, 367  
 Liszt, Franz von: 530, 534, 539, 543  
 Liver, Isaac: 152, 167, 171  
 Lo Cascio: 543  
 Loftus, Elisabeth: 90, 111, 115, 116, 133, 474, 475  
 Longrich, Peter: 118, 130, 272, 307, 468, 477, 502, 511, 555  
 Looock, H. D.: 212  
 Loos, Célestin: 199, 497  
 Loscher, Josef: 494  
 Löw, Konrad: 18  
 Lüders, Martin: 567  
 Lüftl, Walter: 10, 26, 61, 63, 64, 65, 66, 67, 68, 69, 70, 81, 82, 83, 84, 107, 343, 359, 435, 559  
 Łukaszewicz, Zdzisław: 481, 497, 498, 499  
 Lummert, Günther: 535, 539, 543, 544, 546, 548, 549  
 Lustiger, Arno: 287  
 Luther, Hans: 526  
 Luther, Martin: 289  
 — **M** —  
 Maccone, Luigi: 376  
 MacDonald, Kevin: 56  
 Maciejewski, J.: 497, 498  
 Mackensen-Maeltzer: 543  
 Madajczyk, Czesław: 212  
 Madarescu, General: 536  
 Mägerle, Anton: 24, 567  
 Maier, D.: 354  
 Maietti: 26  
 Maihofer, Werner: 104, 123, 147  
 Malina, P.: 258  
 Manassero: 541, 542  
 Mangold, Tom: 497  
 Manin, Y.: 469  
 Mann, Thomas: 182  
 Manner: 545  
 Marais, Pierre: 88, 142, 216, 217, 224, 225, 226, 227, 232  
 Marcuse, Herbert: 17  
 Marczevska, Krystyna: 293, 478, 479  
 Margolina, Sonja: 554  
 Markiewicz, Jan: 10, 338, 362, 365, 367, 369, 370, 371, 560  
 Marsalek, Hans: 220, 288, 299, 406  
 Marshall, W.F.: 458  
 Marszałek, Józef: 298, 415, 418, 429, 432  
 Martin, James J.: 35, 580  
 Martin, Victor: 88  
 Maschke, Hermann: 530  
 Maser, Werner: 47, 98, 100, 197, 221, 552  
 Masur, N.: 206  
 Matthes: 440  
 Matthew: 509  
 Matthies: 155, 162, 166, 170  
 Mattogno, Carlo: 34, 36, 41, 55, 56, 57, 72, 73, 75, 80, 88, 127, 130, 141, 190, 207, 208, 280, 283, 286, 292, 296, 298, 299, 300, 301, 303, 304, 307, 311, 312, 316, 325, 338, 339, 340, 341, 342, 352, 354, 359, 365, 366, 373, 374, 401, 411, 413, 422, 423, 427, 429, 433, 436, 438, 457, 471, 479, 480, 481, 495, 499, 560, 561, 579  
 Maurach, Reinhart: 97, 544, 546  
 Maurer, Standartenführer: 101  
 Maurizio, Pierangelo: 529  
 Mayer, Arno J.: 11, 35, 44, 127, 287  
 Mayer, Hein: 97, 219, 552  
 McAfee Brown, Robert: 55  
 McCarthy, Joseph: 92, 93, 94  
 Meduna, Ladislav J.: 450  
 Meehan, Patricia: 96  
 Meier, Horst: 23, 569  
 Meier, Wolfgang: 339  
 Meinecke, Albert: 355  
 Meinhardt, Günther: 13  
 Melen: 539  
 Melnikow: 521  
 Melzer, Abraham: 122, 472, 474  
 Mencil, Tadeusz: 288, 294, 298, 429  
 Mendelsohn, John: 502  
 Mendès-France, Pierre: 206  
 Mengele, Joseph: 123, 159, 160, 169, 170  
 Mermelstein, Mel: 19  
 Merriam, Ray: 93  
 Merrion, David F.: 444  
 Mertes, Alois: 146  
 Messerschmidt, Manfred: 48  
 Messing, Heinrich: 403  
 Metternich, Fürst: 567  
 Meurer, D.: 25  
 Meyer, Brün: 69  
 Meyer, Fritjof: 81, 201, 309, 357, 371, 374  
 Meyer, Hermann J.: 119, 124  
 Meyer, Winfried: 288  
 Meyer-Clason, Kurt: 141, 144  
 Mezger, Edmund: 544, 549  
 Michael, Saint: 177  
 Michailov, Alexander: 217, 465  
 Michalek, Austrian Minister of Justice: 83  
 Middlebrook, Martin: 270  
 Mikhailovic, P.: 306  
 Mikhasev, Tamara: 509  
 Mills, E. C.: 354  
 Milsom, John: 240  
 Minz, Isaak I.: 552  
 Mishkoff, Adina: 209



- Moeschlin, Sven: 350, 560  
 Mohler, Armin: 246  
 Molau, Andreas: 58  
 Moleschott: 375  
 Moll, Otto: 410  
 Molotov, Vyacheslav: 504  
 Moltke, H. von: 130  
 Mommsen, Hans: 190  
 Montgomery, Bernard L.: 537, 546  
 Moog, A.: 352  
 Moorehead, Alan: 96  
 Moran, Tom: 128  
 Morgan, Frederick: 546  
 Morgen, Konrad: 129, 260  
 Morgenthau, Henry: 48  
 Moser, Hans: 84  
 Mossman, Allen L.: 367, 440  
 Mrugowsky, Joachim: 239, 314, 323, 351, 415  
 Müller, Filip: 114, 129, 130, 137, 143, 357, 409, 410, 411  
 Muller, Jerry Z.: 555  
 Müller, Otward: 291  
 Müller, Rudolph: 375  
 Müller-Focken, L.: 354  
 Müller-Münch, Ingrid: 111, 112, 118, 120, 122  
 Müller-Neuglück, H.H.: 452  
 Münch, Hans: 28, 105, 357, 358  
 Murawska, Zofia: 307  
 Musial, Bogdan: 264  
 Musmanno, Michael A.: 128  
 Mußfeldt, Erich: 425  
 Mussolini, Benito: 529  
 Myers, P. S.: 442
- N —  
 Nachtmann, Herwig: 84  
 Nack, Armin: 86, 87, 107, 111, 127, 174, 175  
 Nagel, Robert: 377  
 Nagl, Walter: 6, 13  
 Nansouty, M. de: 376  
 Napoleon: 62  
 Naumann, Bernd: 103, 104, 105, 106, 107, 108, 110, 112, 114, 117, 118, 119, 120, 121, 122, 128, 130, 341, 343, 357  
 Naumann, Gert: 248, 297  
 Naumann, Klaus: 24, 524  
 Nekrasow, V.: 528  
 Neufert, Ernst: 71, 343, 439  
 Neugebauer, Wolfgang: 67, 69, 83, 339, 435, 560
- Neuhäusler, Johann: 298  
 Neumaier, Arnulf: 29, 42, 56, 87, 111, 130, 133, 195, 199, 202, 272, 280, 435, 454, 457, 471, 528  
 Neumann, Robert: 246, 252, 261  
 Neurath, Konstantin von: 100  
 Ney, Johannes P.: 36, 88  
 Nickerson, Natalie: 266  
 Niedereiter, Wilhelm: 581  
 Niefnitz, Admiral: 533  
 Niepel, Andreas: 339  
 Nigel, Tomas: 553  
 Noakes, Jeremy: 35  
 Nolte, Ernst: 15, 16, 19, 23, 25, 27, 29, 31, 32, 36, 38, 45, 46, 85, 102, 127, 201, 217, 554, 555, 569, 574, 576  
 Nordbruch, Claus: 287, 567, 568  
 Nordling, Carl O.: 186, 187, 205  
 Noro, Leo: 466  
 Novick, Peter: 56  
 Nowak, Hans Jürgen: 38, 40, 177, 311, 339, 340, 348  
 Nuvolone: 540, 543  
 Nyiszli, Miklos: 140, 141, 356, 357, 374, 388
- O —  
 O'Keefe, Theodore J.: 19, 128, 339  
 Obenaus, H.: 252  
 Oberländer, Theodor: 247  
 Obert, Edward F.: 448  
 Odi, Josef: 165  
 Oerley, Wolfgang: 460  
 Ogden, S.O.: 446  
 Ohlendorf, Otto: 101, 220, 230  
 Olère, David: 129  
 Olga: 150  
 Oliver, Revilo: 9  
 Oppenheim, Lassa F. L.: 533, 534, 535, 540, 541, 543, 545, 546, 547  
 Oppitz, Ulrich-Dieter: 109, 111, 112, 114, 117, 118, 119, 120, 127  
 Orlow, Dimitri: 508, 509  
 Ortloff, Hermann: 376  
 Oscar, Friedrich: 92, 93, 95, 100, 101  
 Oskar: 167  
 Ostwald, Walter: 461  
 Oswald, Werner: 215, 216, 240  
 Ozerow, L.: 522
- P —  
 Pägert, Martin: 451, 468  
 Paget, Reginalt T.: 536, 545, 546  
 Palitsch, Boriwoje: 390  
 Pallieri: 531  
 Pankow, Dieter: 447  
 Pannain: 530  
 Pappenheim, Erich: 239  
 Paramonov, Boris: 554  
 Patek, J.: 503, 505, 506, 508  
 Pattle, R.E.: 450, 451, 452, 456, 458  
 Patton, Temple C.: 354  
 Paul, Allen: 270  
 Paulinchen: 493  
 Pauly, Max: 375, 412  
 Pawlikowski, John T.: 55  
 Pedersen, Hans: 88, 116  
 Peer, Moshe: 128, 285  
 Peiper, Joachim: 93, 98  
 Pelt, Robert Jan van: 367, 370, 371  
 Pelt, Robert van: 38, 40, 55, 311, 339, 341, 342, 344, 366, 367, 370  
 Pemsel, Richard: 553  
 Perikles: 18  
 Perl, Gisela: 140  
 Perry, J. H.: 410  
 Perz, Bertrand: 38, 83  
 Peter, Erwin: 97  
 Peters, A.: 377, 378  
 Peters, Gerhard: 75, 239, 240, 313, 315, 348, 351  
 Petrenko, N. F.: 520  
 Petri, Gruppenführer: 101  
 Petzet, Michael: 353, 560  
 Pfannenstiel, Wilhelm: 438, 439, 455, 467, 468  
 Pfeiffer, Gerd: 572  
 Pfenniger: 539  
 Pfolz, Heinrich: 25  
 Philipps, Peter: 49  
 Phillips, Raymond: 301  
 Pichler, Hans: 240  
 Pietra Santa, P. de: 375, 376  
 Pilloud: 539  
 Pini, G.: 375, 376  
 Pinson, Koppel S.: 115  
 Pinter, Stephen F.: 579  
 Piper, Franciszek: 201, 280, 295, 298, 342, 374, 409  
 Piper, Michael Collins: 19, 58  
 Pisar, Samuel: 140  
 Plack, Arno: 102

- Platz, Werner E.: 26  
 Poeppel, Hans: 551  
 Pohl, Oswald: 96, 101, 289, 290, 292, 315  
 Poirer, Robert: 275  
 Polevoi, Boris: 305  
 Poliakov, Léon: 9, 35, 182, 438, 440, 481  
 Polischtschuk, Sheila: 518  
 Polson, Cyril J.: 439  
 Ponsonby, Arthur: 127  
 Pope Pius XII: 7  
 Popper, Karl Raimund: 19, 25, 575  
 Porter, Carlos W.: 98, 128, 413  
 Posner, Gerald L.: 123  
 Posner, Vladimir: 522  
 Possony, S. T.: 474  
 Post, Walter: 47, 197, 263, 264, 552  
 Powell, H. M.: 353  
 Pradel, Friedrich: 225, 228, 229  
 Pressac, Jean-Claude: 11, 38, 54, 55, 71, 72, 75, 76, 77, 78, 79, 80, 81, 88, 127, 129, 130, 140, 141, 142, 144, 163, 164, 190, 201, 213, 253, 277, 280, 300, 311, 312, 313, 314, 315, 316, 317, 323, 324, 326, 327, 328, 329, 330, 331, 332, 333, 335, 338, 339, 340, 341, 342, 343, 344, 345, 346, 347, 348, 349, 352, 355, 356, 357, 359, 361, 362, 371, 374, 375, 404, 406, 408, 419, 420, 421, 422, 423, 424, 425, 427, 429, 432, 433, 434  
 Pridham, Geoffrey: 35  
 Priebke, Erich: 529, 530  
 Priestley, J. G.: 448  
 Prinz, Michael: 31  
 Pronitscheva, Dina: 510, 511  
 Proske, Rüdiger: 17, 260  
 Provan, Charles D.: 277, 450  
 Prowazek: 313  
 Prüfer, Kurt: 380, 385, 387, 389, 394  
 Puhl, Emil: 95  
 Puls, Franz: 381  
 Puntigam, Franz: 75, 80, 239, 240, 331, 340, 351  
 Pyš, Edward: 357
- Q —  
 Quehl, Viktor: 378
- R —  
 Rademacher, Werner: 26, 40, 55, 56, 57, 201, 311, 335, 339, 343, 358, 411, 435  
 Radnitzky, Gerard: 16, 17, 18  
 Rajca, Czesław: 298, 429  
 Rasch, W.: 239, 240  
 Rascher: 301  
 Rasgon, I. M.: 552  
 Rassinier, Paul: 8, 9, 88, 140, 181, 182, 295, 304, 305, 439, 579, 580  
 Rau, Johannes: 177  
 Rauff, Walther: 222, 224, 225, 226, 227, 228, 229, 230, 232, 233, 236, 463, 465  
 Rauschenbach, Gerhard: 98  
 Rauschning, Hermann: 36  
 Raven, Greg: 128  
 Rayzman, Samuel: 481, 498, 499  
 Reagan, Ronald: 435, 475  
 Reber, B.: 375  
 Reclam: 375  
 Rector, Franc: 292  
 Redeker, Robert: 144  
 Reder, Rudolf: 130  
 Reel, A. Frank: 542  
 Reemtsma, Jan P.: 260, 261, 262, 264  
 Regitz, Manfred: 451  
 Rehak, Günther H.: 16  
 Rehm, Helmut: 246  
 Reich, Robert: 6  
 Reichel, Peter: 122  
 Reichenwallner, Balduin: 379  
 Reichman, Yechiel: 491  
 Reichmann: 67, 68  
 Reiners, Anton: 137  
 Reitlinger, Gerald: 182, 185, 186, 188, 189, 191, 192, 512, 515, 525, 553  
 Remer, Otto E.: 20, 21  
 Rendulic, Lothar: 91  
 Rentrop, Wilhelm: 530  
 Repky, Dr.: 378  
 Reuter, Fritz: 286  
 Reuth, Ralf Georg: 264  
 Ribbentrop, Joachim von: 99  
 Richter: 375  
 Richthofen, Bolko von: 100  
 Ricketts: 313  
 Rieger, Jürgen: 26, 104, 110  
 Rieß, Volker: 262, 477, 512  
 Rigg, Bryan Mark: 13
- Rimscha, Roberta von: 17, 18  
 Ringelblum, Emmanuel: 479  
 Rivier: 539  
 Rjasanzwe, Waleri: 217  
 Roberts, Jeff: 128  
 Robertson, General: 546  
 Rocco, Francesco: 531  
 Roden, E. Leroy van: 95  
 Röder, Susanne: 86, 87, 107, 111, 127, 174, 175  
 Rodway, Stella: 144  
 Roediger, Conrad: 97  
 Rogerie, André: 140  
 Rogowski: 530  
 Röhl, John C. G.: 13  
 Rohwer, Jürgen: 31, 33  
 Rolin: 540  
 Rolle, R.: 353  
 Roosevelt: 539  
 Roosevelt, Eleanor: 455  
 Roosevelt, Franklin D.: 7, 34, 139  
 Röpneck, Adolf: 240  
 Roques, Henri: 25, 110, 438, 439, 488, 528, 575, 581  
 Rose: 95  
 Rose, Maurice: 550  
 Rosenberg, Eliahu: 440, 473, 474, 484, 488, 489, 490  
 Rosenthal, Ludwig: 358  
 Ross, Alf: 531  
 Roßmann, E.: 559  
 Roth, James: 367, 368  
 Roth, Lutz: 451  
 Rothe, Wolf Dieter: 88  
 Rothfels, Hans: 182, 438  
 Rothkranz, Johannes: 182  
 Rubinstein, W. D.: 183  
 Ruckerl, Adalbert: 35, 46, 87, 89, 92, 96, 97, 98, 99, 101, 102, 103, 104, 105, 106, 107, 108, 109, 111, 114, 117, 118, 119, 120, 121, 123, 128, 131, 218, 219, 229, 232, 248, 272, 302, 303, 357, 440, 468, 477, 485, 486, 513, 520, 526  
 Rudenko, Roman A.: 200  
 Rudolf, Gernar: 10, 15, 19, 20, 23, 28, 33, 37, 38, 41, 55, 57, 58, 59, 65, 66, 69, 76, 88, 105, 110, 113, 145, 181, 257, 299, 301, 309, 311, 326, 338, 339, 340, 347, 353, 355, 357, 359, 361, 362, 363, 364, 365, 368, 370, 413, 414, 427, 435, 436, 437, 467,

- 473, 482, 489, 530, 550, 553,  
554, 555, 577, 560, 563, 572,  
576, 581
- Rudolph, Tiudar: 10
- Rullmann, Hans P.: 440, 471, 472,  
473, 475, 477, 484, 490
- Rummel, Werner: 76, 350, 439
- Rumpf, Ernst: 208
- Rupper, Josef: 240
- Rüter, Christiaan F.: 85, 106, 337
- S —
- S(p)iegel, Dr.: 250, 251
- Sack, John: 48
- Sagel-Grande, Irene: 85, 337
- Sakowski: 304
- Salm, Karl: 21
- Salvin: 538, 539
- Sanning, Walter N.: 29, 30, 181,  
183, 184, 185, 186, 188, 189,  
190, 191, 192, 193, 194, 195,  
196, 197, 200, 201, 203, 204,  
205, 206, 208, 210, 211, 212,  
508, 525, 552, 581
- Sara: 510
- Sartre, Jean-Paul: 141
- Saukel, Fritz: 101
- Sauer, Ernst: 531
- Sauer, Wilhelm: 531
- Saunders, Hrowe H.: 98
- Schäfer, Hans: 354
- Schaller, Herbert: 73
- Schatzker, Chaim: 116, 127
- Schäuble, Wolfgang: 569
- Schechtman, Joseph: 515
- Scheckter, M.: 130
- Scheffler, Wolfgang: 35, 46, 106,  
121, 122, 203, 212
- Scheibert, Horst: 443
- Scheidl, Franz J.: 26, 96, 104, 107,  
109, 110, 112, 114, 118, 129,  
571, 579
- Schickel, Alfred: 250
- Schilling, Karl: 532, 533, 546, 547,  
550
- Schimmelpfennig, Anton: 39
- Schindler, Oskar: 258, 259, 260,  
492, 518
- Schirmer, Gerhart: 202, 304
- Schirmer-Vowinkel, Ilse: 83, 126
- Schittenhelm, A.: 313
- Schjerning, Otto von: 351
- Schläpfer, Paul: 378, 383, 391
- Schlesiger, Wilhelm: 20, 355, 576
- Schleunes, K. A.: 31
- Schluch, Karl A.: 440, 468
- Schmid, Karl: 531
- Schmidbauer, F.: 107
- Schmidt: 530
- Schmidt, Hans: 25, 576
- Schmidt, Helmut: 146
- Schmidt, Robert F.: 350
- Schmidt-Jorzig, Edzard: 569
- Schmidt-Neuhaus, Dieter: 264
- Schmuhl, Hans-Walter: 31
- Schnabel, Raimund: 253, 254, 256,  
257, 261
- Schneeberger: 539, 543, 544
- Schneider, Egon: 85, 86, 87, 107
- Schneider, Peter: 119, 123, 124
- Schneider, Richard: 376
- Schnering, Hans Georg von: 56,  
359
- Schöbener, Burkhard: 48
- Schoenberner, Gerhard: 119, 253,  
256, 261, 357
- Schoeps, Julius H.: 272, 307, 468,  
477, 502, 555
- Scholle, R.: 331
- Scholz, Rainer: 35
- Schönke, Adolf: 544, 549, 569
- Schön-Kulka, Erich: 114
- Schor, Dr.: 169
- Schrenck-Notzing, Caspar von: 17,  
121
- Schrenck-Notzing, Regina von: 16
- Schrenk, H. H.: 445
- Schröder, Horst: 569
- Schröder, Sibylle: 33, 554
- Schübbe, Gustav Wilhelm: 514
- Schuchhardt, Carl: 375
- Schüle, Erwin: 103
- Schultze: 344
- Schulz, Gerhard: 551
- Schulze-Manitius, Hans: 399
- Schumacher, Fritz: 72, 339, 376,  
378, 379, 388
- Schumann, Heinz: 494
- Schuster, Wolfgang: 338
- Schütze, Heinrich A.: 531, 534,  
535, 536, 538, 539, 540, 543
- Schwab, Jürgen: 568
- Schwamberger, Josef: 28, 122
- Schwartz, A.: 250, 251
- Schwartz, Alan M.: 339
- Schwartz, Thomas A.: 95, 96, 101
- Schwarz, Hans-Peter: 264
- Schwarz, L.: 353
- Schwarzenberger, Georg: 531
- Schwarz-Schilling, Christian: 147,  
175
- Schwertfeger, Reinhold: 302
- Schwinge, Erich: 545, 549
- Segev, Tom: 116
- Seidler, Franz W.: 18, 262, 263,  
551, 552, 553, 554
- Seidman, K.: 128
- Seifert, Karl-Heinz: 23, 568
- Selbach, Gerd: 217
- Selmi, Prof.: 412
- Semyda, Ian: 371
- Senteler: 159, 169
- Sereny, Gitta: 31, 120, 477, 489
- Serpico, Tom: 580
- Servatius, Robert: 113, 118, 137,  
181
- Shabecoff, Philip: 510, 511
- Shadek, Michael: 472
- Shahak, Israel: 555
- Shapiro, Chaim: 507
- Shapiro, S. Z.: 338, 339
- Shawcross, Hartley: 284
- Sheftel, Yoram: 474
- Sher, Eran: 454
- Sherman, General: 535
- Shermer, Michael: 37
- Shirer, William: 35
- Sibert, Marcel: 531, 541
- Sidorow, Arkadij L.: 552
- Siegel, Michael: 250, 251
- Siegert, Karl: 45, 56, 530, 544, 549,  
550, 552
- Siegert, Standartenführer: 229
- Siemens, Friedrich: 375, 376
- Silberschein, Abraham: 430, 431,  
480, 481
- Simon, Arnd: 15
- Simonov, Constantin: 256, 257,  
261, 306, 421, 424, 431, 432
- Simpson, Gordon: 95
- Simpson, Keith: 442
- Simson, Eduard von: 13
- Sinclair, K.: 450
- Singer, Peter: 18, 32
- Sistino, B. J. A.: 354
- Skalski, Ernest: 6
- Skowron, T.: 476, 478
- Slepokura, Orest: 128
- Smirnov, A. A.: 200
- Smirnov, L. N.: 519, 523
- Smith, Arthur L.: 93, 95, 97, 128,  
246

- Smith, Bradley R.: 46, 88, 342  
 Smith, Herbert A.: 532, 546  
 Smoleń, Kazimierz: 80, 81, 294  
 Sobran, Joseph: 476  
 Sofair, André N.: 32  
 Sofsky, Wolfgang: 213  
 Sojka, Klaus: 262  
 Soldan, Wilhelm G.: 125  
 Solms, Armin: 10, 338  
 Solzhenitzyn, Alexander: 286  
 Sommerdille, Admiral: 545  
 Sonnenburg, Karlhans: 538  
 Spaight, James M.: 49, 539, 541  
 Spanic, Eli: 209  
 Spanner, Prof.: 491  
 Spataro, Mario: 529  
 Spee von Langenfeld, Friedrich: 175  
 Speer, Albert: 462  
 Spielberg, Steven: 259, 492  
 Spielberger, Walter J.: 216, 461, 463  
 Sprenger, Isabell: 293  
 Springer, Elisa: 285  
 Springer, Hildegard: 95, 99, 100, 101, 102, 258  
 Stadler, Michael: 167  
 Stäglich, Wilhelm: 8, 9, 25, 36, 72, 88, 104, 121, 137, 275, 284, 439, 573, 575, 580, 581  
 Stahl, Alexander von: 18  
 Stalin, Joseph: 7, 23, 24, 34, 47, 97, 102, 182, 197, 200, 210, 217, 261, 263, 270, 465, 508, 514, 515, 517, 518, 528, 551, 552, 555, 564  
 Stangl, Franz P.: 468  
 Stark, Hans: 357  
 Starke, K.: 439  
 Stein, Burkhardt: 566  
 Stein, Edith: 206  
 Stein, Howard F.: 14, 116  
 Stein, Judge: 178  
 Steinbach, Peter: 28, 87, 105, 106, 107, 108, 120, 121, 122, 123  
 Steinberg, S.: 130  
 Steiner, Jean-François: 457, 487, 491, 492, 518  
 Steininger, Rolf: 116  
 Steinmetz: 537  
 Stern, Hartmut: 47  
 Stern, Kenneth S.: 339  
 Stöcker, Hans A.: 23, 569  
 Stockhammer, Peter: 21  
 Stoecker, Wolf: 261  
 Stomper, Herbert: 50  
 Stowell, Ellery C.: 539  
 Strauch: 532  
 Strauß, Wolfgang: 48, 217, 261  
 Streicher, Julius: 101  
 Streim, Alfred: 263  
 Stretch, H.: 450  
 Stromberger, Wilhelm: 36, 313  
 Strothmann, Dietrich: 567  
 Struminsky, V.: 209  
 Strupp, Karl: 534, 540, 544  
 Struwelpeter: 493  
 Strzelecki, Andrzej: 297  
 Stübiger, Günther: 28, 122, 529  
 Stuhlpfarrer, Karl: 38, 83  
 Sucato, Gaetano: 530, 533, 543  
 Sukkel: 225  
 Summers, Anthony: 497  
 Süßmuth, Rita: 524  
 Suvorov, Victor: 47, 48, 197, 552  
 Suzman, Arthur: 46  
 Szende, Stefan: 130, 481
- T —  
 Tarrassevich: 313  
 Tattersall, R. N.: 439  
 Tauber, Henryk: 71, 130  
 Taylor, Telford: 98, 283  
 Tec, Nechama: 555  
 Telpuchowsky, Boris S.: 551  
 Tenenbaum, Edward A.: 295  
 ter Linden, A.J.: 399  
 Tesch, Bruno: 136, 355, 437  
 Thieme, H.: 47  
 Thion, Serge: 38, 187, 339  
 Thomas, Earl W.: 580  
 Tidow, Alfred R.: 549  
 Tiedemann, Herbert: 42, 199, 273, 489, 553  
 Tiemann, Ralf: 91, 92, 93, 94, 95  
 Tilly, H.: 377, 381  
 Tischler, Herbert: 149  
 Tito, Josip B.: 34, 48  
 Titz, Wolfgang: 297  
 Toben, Fredrick: 38, 311, 346, 576  
 Tompson, Henry: 375  
 Toniak, Adela: 433  
 Topf, Ernst: 387  
 Topf, Ludwig: 387  
 Topitsch, Ernst: 47, 48, 197, 552  
 Tor, Malka: 55  
 Torke, Hans J.: 551  
 Toronto: 367
- Townsend, Ralph: 580  
 Traficant, James V.: 475  
 Tregenza, M.: 481  
 Tröndle, Herbert: 23, 568  
 Trusen, J.P.: 375  
 Trzcinska, Beate: 338, 370  
 Tse Tung, Mao: 17  
 Tuchel, Johannes: 28, 106
- U —  
 Udowenko, Genadi: 523  
 Ungváry, Krisztián: 264  
 Untermeyer, Samuel: 46  
 Utley, Freda: 91, 93, 94, 95, 97, 99, 100
- V —  
 Vabres, Henri D. de: 545  
 Vaillant-Couturier, Claude: 357  
 Vanselow, Ernst: 533, 534, 536, 539, 541, 544  
 Varlin, E.: 251  
 Vasili I. Tesslia: 217  
 Veale, F. J. P.: 98  
 Veil, Simone: 134, 135, 140, 143, 187  
 Ventilation  
   crematorium II/III: 368  
 Verbeke, Herbert: 19, 20, 25, 38, 43, 50, 69, 75, 113, 316, 325, 338, 339, 356, 359, 365, 370, 576  
 Verbeke, Siegfried: 43  
 Verdroß, Alfred: 531  
 Vergès, Jacques: 139  
 Verral, Richard: 580  
 Vidal-Naquet, Pierre: 135, 141  
 Vilakis: 507  
 Vogel, Hans-Jochen: 147  
 Vogel, Rolf: 106  
 Vogt, Artur: 21  
 Volckmann, Hans: 378, 379, 380  
 Vrba, Rudolf: 10, 11, 114, 115, 138, 139, 142
- W —  
 Wagner, H. E.: 471  
 Wahls, Hans: 36  
 Walbaum, Jost: 240  
 Waldkirch, Eduard von: 534, 544  
 Walendy, Udo B.: 24, 36, 37, 56, 72, 84, 88, 96, 101, 128, 130, 137, 176, 181, 183, 217, 237, 243, 244, 246, 247, 249, 250,

- 251, 252, 253, 254, 256, 257,  
258, 265, 270, 272, 280, 287,  
291, 338, 355, 357, 412, 439,  
471, 477, 482, 488, 490, 492,  
501, 506, 516, 518, 525, 553,  
570, 576, 581
- Waller, engineer: 390  
Wallus, Frank: 471  
Walter, Bernhard: 118  
Waltzog, Alfons: 539, 541, 543  
Wandres, Thomas: 23  
Ware, John: 123  
Warszawski, Szyja: 490, 492, 493,  
494, 495  
Wassermann, Rudolf: 50  
Wassner: 391  
Waszawski, Szyja: 490  
Watt, G. D.: 353  
Ważniewski, Władysław: 293, 478,  
479  
Weber, Charles E.: 9  
Weber, Dr.: 322  
Weber, Helmut: 557  
Weber, Joachim F.: 261, 263  
Weber, Jürgen: 28, 87, 99, 105,  
106, 107, 108, 120, 121, 122,  
123  
Weber, Mark: 9, 19, 40, 91, 101,  
128, 130, 208, 248, 284, 295,  
338, 348, 500  
Weckert, Ingrid: 32, 37, 56, 88, 93,  
97, 195, 199, 202, 248, 297, 461,  
463, 465, 500, 553, 571  
Wegmann: 375  
Wegner, Bernd: 38, 197, 552  
Wegner, Werner: 338, 374  
Weidner, Herbert: 240  
Weigt, Karl A.: 375  
Weinbacher, Karl: 136  
Weise, Gottfried: 28, 29, 104, 111,  
113, 117, 139, 145, 146, 147,  
148, 149, 150, 151, 152, 155,  
156, 158, 159, 162, 166, 167,  
168, 169, 170, 171, 172, 174,  
176, 177, 178, 179, 190  
Weiser, Rottenführer: 149  
Weiß, H.: 36  
Weiss, Konrad: 379
- Weizmann, Chaim: 46  
Weizsäcker, Ernst von: 99  
Weizsäcker, Richard von: 50, 99  
Wellers, Georges: 46, 88, 142, 182,  
207, 208, 338, 359, 367  
Wellhöner, H.-H.: 350  
Wendig, Heinrich: 39, 191, 550  
Werkmeister, H.: 452  
Werle, Gerhard: 23  
Werner, Dr.: 472  
Werner, Kurt: 512, 513  
Werner, Martin: 351  
Werner, Steffen: 38, 200, 272, 551,  
571  
Wernicke, Kurt: 264  
Wesche, Karlhans: 353, 363  
Wesslerle, Andreas R.: 98  
Westlake: 539, 540  
Westphal, Hans Karl: 35  
Wet, J. F. de: 353  
Wetzels: 167  
Wetzler, Alfred: 114  
Wheaton: 539  
Wickoff, Jack: 292  
Wiehn, Erhard R.: 502, 505, 506,  
507, 508, 509, 510, 511, 512,  
513, 515, 522, 523, 525  
Wiernik, Jankiel: 457, 480, 487,  
491, 494, 497  
Wiesel, Elie: 116, 128, 133, 141,  
142, 144  
Wiesenthal, Simon: 81, 104, 123,  
128, 130, 146, 265, 303  
Wigleb, Unterscharführer: 169  
Wilenchik, Witalij: 551  
Wilhelm, Hans-Heinrich: 21, 44,  
199, 553  
Willenberg, Samuel: 478, 492  
Williamson, R. G.: 382  
Willing, August: 384, 406  
Willing, Dr.: 320  
Willms, Patricia: 13  
Wimmer, Agnes: 141, 144  
Wirth, Christian: 123, 437, 438  
Wirth, Wolfgang: 350  
Wirths, Eduard: 314, 316, 317  
Wisliceny, Dieter: 94, 181  
Wiśniewska, Anna: 296
- With, Hans de: 50  
Wittgenstein, Ludwig J.J.: 65  
Wittkugel, Klaus: 264  
Wohlrab, R.: 240, 351  
Wojtczak, S.: 497  
Wolansky, O.: 175  
Wolfer, H.: 379  
Wolffsohn, Michael: 14, 43, 116  
Wolski, Marek: 503  
Woltersdorf, Hans Werner: 124  
Wright: 541  
Wulf, Joseph: 35, 280  
Wüstinger, Emil: 75, 240, 315, 348  
Wyman, David P.: 114
- **Y** —  
Yahil, Leni: 520  
Yamashita, General: 542  
Yeager, Chuck: 300  
Yevtushenko, Yevgeny: 514, 515,  
523, 528
- **Z** —  
Zacher, Hans F.: 20  
Zaun, Alfred: 355  
Zaverdinos, Costas: 44  
Zayas, Alfred M. de: 49, 263, 552  
Zenkeller, Dr.: 159, 160, 169, 170  
Zentner, Christian: 35  
Zernik, Franz: 350, 351, 423  
Ziereis, Franz: 220, 303, 308  
Ziesel, Kurt: 247  
Zimmerman, John C.: 373  
Zimmermann, Günter: 353, 559  
Zimmermann, Moshe: 14, 56, 116  
Zippel, Dr.: 136  
Zitelmann, Rainer: 18, 21, 31, 199,  
338, 374, 554  
Żłobnicki, A.: 389  
Zmijewska-Wiesniewska, Anna:  
425  
Zornig, Rudi: 110  
Zündel, Ernst: 9, 10, 11, 12, 19, 73,  
133, 136, 138, 139, 142, 337,  
367, 368, 375, 414  
Zuroff, Efraim: 126, 553  
Zwerenz, Winfried: 359  
Zylbersztain, Samuel: 308











# HOLOCAUST HANDBOOKS

This ambitious, growing series addresses various aspects of the “Holocaust” of the WWII era. Most of them are based on decades of research from archives all over the world. They are heavily referenced. In contrast to most other works on this issue, the tomes of this series approach its topic with profound academic scrutiny and a critical attitude. Any Holocaust researcher ignoring this series will remain oblivious to some of the most important research in the field. These books are designed to both convince the common reader as well as academics. The following books have appeared so far, or are about to be released. Compare hardcopy and eBook prices at [www.findbookprices.com](http://www.findbookprices.com).

## SECTION ONE: General Overviews of the Holocaust

### *The First Holocaust. The Surprising Origin of the Six-Million Figure.*

By Don Heddesheimer. This compact but substantive study documents

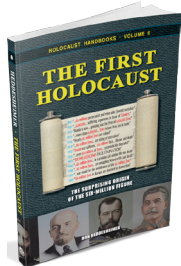

propaganda spread prior to, during and after the FIRST World War that claimed East European Jewry was on the brink of annihilation. The magic number of suffering and dying Jews was 6 million back then as well. The book details how these Jewish fundraising operations in America raised vast sums in the name of feeding

suffering Polish and Russian Jews but actually funneled much of the money to Zionist and Communist groups. 5th ed., 198 pages, b&w illustrations, bibliography, index. (#6)

### *Lectures on the Holocaust. Controversial Issues Cross Examined.*

By Germar Rudolf. This book first explains why “the Holocaust” is an important topic, and that it is well to keep an open mind about it. It then tells how many mainstream scholars expressed doubts and subsequently fell from grace. Next, the physical traces and documents about the various claimed crime scenes and murder weapons are discussed. After that, the reliability of witness testimony is examined. Finally, the author lobbies for a free exchange

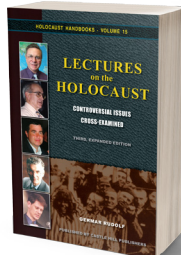

of ideas about this topic. This book gives the most-comprehensive and up-to-date overview of the critical research into the Holocaust. With its dialog style, it is pleasant to read, and it can even be used as an encyclopedic compendium. 3rd ed., 596 pages, b&w illustrations, bibliography, index. (#15)

*Breaking the Spell. The Holocaust, Myth & Reality.* By Nicholas Kollerstrom. In 1941, British Intelligence analysts cracked the German “Enigma” code. Hence, in 1942 and 1943, encrypted radio communications between German concentration camps and the Berlin headquarters were decrypted. The intercepted data



refutes the orthodox “Holocaust” narrative. It reveals that the Germans were desperate to reduce the death rate in their labor camps, which was caused by catastrophic typhus epidemics. Dr. Kollerstrom, a science historian, has taken these intercepts and a wide array of mostly unchallenged corroborating evidence to show that “witness statements” supporting the human gas chamber narrative clearly clash with the available scientific data. Kollerstrom concludes that the history of the Nazi “Holocaust” has been written by the victors with ulterior motives. It is distorted, exaggerated and largely wrong. With a foreword by Prof. Dr. James Fetzter. 4th ed., 261 pages, b&w ill., bibl., index. (#31)

*Debating the Holocaust. A New Look at Both Sides.* By Thomas Dalton. Mainstream historians insist that there cannot be, may not be a debate about the Holocaust. But ignoring it does not make this controversy go away. Traditional scholars admit that there was neither a budget, a plan, nor an order for the Holocaust; that the key camps have all but vanished, and so have any human remains; that material and unequivocal documentary evidence is absent; and that there are serious problems with survivor testimonies. Dalton juxtaposes the traditional Holocaust narrative with revisionist challenges and then analyzes the mainstream’s responses to them. He reveals the weak-

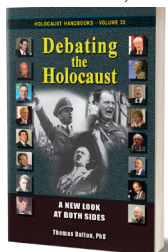
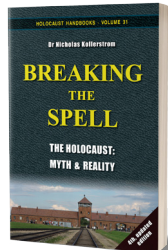

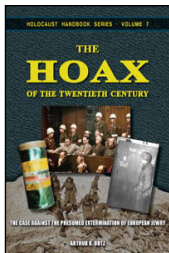

nesses of both sides, while declaring revisionism the winner of the current state of the debate. 2nd ed., 332 pages, b&w illustrations, bibliography, index. (#32)

**The Hoax of the Twentieth Century. The Case against the Presumed Extermination of European Jewry.** By Arthur R. Butz. The first writer to analyze the entire Holocaust complex in a precise scientific manner. This book exhibits the overwhelming force of arguments accumulated by the mid-1970s. Butz's two main arguments are: 1. All major entities hostile to Germany must have known what was happening to the Jews under German authority. They acted during the war as if no mass slaughter was occurring. 2. All the evidence adduced to prove any mass slaughter has a dual interpretation, while only the innocuous one can be proven to be correct. This book continues to be a major historical reference work, frequently cited by prominent personalities. This edition has numerous supplements with new information gathered over the last 35 years. 4th ed., 524 pages, b&w illustrations, bibliography, index. (#7)

**Dissecting the Holocaust. The Growing Critique of "Truth" and "Memory."** Edited by Germar Rudolf. *Dissecting the Holocaust* applies state-of-the-art scientific technique and classic methods of detection to investigate the alleged murder of millions of Jews by Germans during World War II. In 22 contributions—each of some 30 pages—the 17 authors dissect generally accepted paradigms of the “Holocaust.” It reads as exciting as a crime novel: so many lies, forgeries and deceptions by politicians, historians and scientists are proven. This is the intellectual adventure of the 21st century. Be part of it! 2nd ed. 620 pages, b&w illustrations, bibliography, index. (#1)

**The Dissolution of Eastern European Jewry.** By Walter N. Sanning. Six Million Jews died in the Holocaust. Sanning did not take that number at face value, but thoroughly explored European population developments and shifts mainly caused by emigration as well as deportations and evacuations conducted by both Nazis and the Soviets, among other things. The book is based mainly on Jewish, Zionist and mainstream sources. It concludes that a sizeable share of the Jews found missing during local censuses after the Second World War, which were so far counted as “Holocaust victims,” had either emigrated (mainly to Israel or the U.S.) or had been deported by Stalin to Siberian labor camps. 2nd

ed., foreword by A.R. Butz, epilogue by Germar Rudolf containing important updates; 224 pages, b&w illustrations, bibliography (#29).

**Air Photo Evidence: World War Two Photos of Alleged Mass Murder Sites Analyzed.** By Germar Rudolf (editor). During World War Two both German and Allied reconnaissance aircraft took countless air photos of places of tactical and strategic interest in Europe. These photos are prime evidence for the investigation of the Holocaust. Air photos of locations like Auschwitz, Majdanek, Treblinka, Babi Yar etc. permit an insight into what did or did not happen there. The author has unearthed many pertinent photos and has thoroughly analyzed them. This book is full of air photo reproductions and schematic drawings explaining them. According to the author, these images refute many of the atrocity claims made by witnesses in connection with events in the German sphere of influence. 5th edition; with a contribution by Carlo Mattogno. 168 pages, 8.5”x11”, b&w illustrations, bibliography, index (#27).

**The Leuchter Reports: Critical Edition.** By Fred Leuchter, Robert Faurisson and Germar Rudolf. Between 1988 and 1991, U.S. expert on execution technologies Fred Leuchter wrote four detailed reports addressing whether the Third Reich operated homicidal gas chambers. The first report on Auschwitz and Majdanek became world famous. Based on chemical analyses and various technical arguments, Leuchter concluded that the locations investigated “could not have then been, or now be, utilized or seriously considered to function as execution gas chambers.” The second report deals with gas-chamber claims for the camps Dachau, Mauthausen and Hartheim, while the third reviews design criteria and operation procedures of execution gas chambers in the U.S. The fourth report reviews Pressac's 1989 tome *Auschwitz*. 4th ed., 252 pages, b&w illustrations. (#16)

**The Giant with Feet of Clay: Raul Hilberg and His Standard Work on the "Holocaust."** By Jürgen Graf. Raul Hilberg's major work *The Destruction of European Jewry* is an orthodox standard work on the Holocaust. But what evidence does Hilberg provide to back his thesis that there was a German plan to exterminate Jews, carried out mainly in gas chambers? Jürgen Graf applies the methods of critical analysis to Hilberg's evidence and examines the results in light of modern historiography. The results of Graf's critical

analysis are devastating for Hilberg. 2nd, corrected edition, 139 pages, b&w illustrations, bibliography, index. (#3)

**Jewish Emigration from the Third Reich.** By Ingrid Weckert. Current historical writings about the Third Reich claim state it was difficult for Jews to flee from Nazi persecution. The truth is that Jewish emigration was welcomed by the German authorities. Emigration was not some kind of wild flight, but rather a lawfully determined and regulated matter. Weckert's booklet elucidates the emigration process in law and policy. She shows that German and Jewish authorities worked closely together. Jews interested in emigrating received detailed advice and offers of help from both sides. 2nd ed., 130 pages, index. (#12)

**Inside the Gas Chambers: The Extermination of Mainstream Holocaust Historiography.** By Carlo Mattogno. Neither increased media propaganda or political pressure nor judicial persecution can stifle revisionism. Hence, in early 2011, the Holocaust Orthodoxy published a 400 pp. book (in German) claiming to refute “revisionist propaganda,” trying again to prove “once and for all” that there were homicidal gas chambers at the camps of Dachau, Natzweiler, Sachsenhausen, Mauthausen, Ravensbrück, Neuengamme, Stutthof... you name them. Mattogno shows with his detailed analysis of this work of propaganda that mainstream Holocaust historiography is beating around the bush rather than addressing revisionist research results. He exposes their myths, distortions and lies. 2nd ed., 280 pages, b&w illustrations, bibliography, index. (#25)

## SECTION TWO: Specific non-Auschwitz Studies

**Treblinka: Extermination Camp or Transit Camp?** By Carlo Mattogno and Jürgen Graf. It is alleged that at Treblinka in East Poland between 700,000 and 3,000,000 persons were murdered in 1942 and 1943. The weapons used were said to have been stationary and/or mobile gas chambers, fast-acting or slow-acting poison gas, unslaked lime, superheated steam, electricity, diesel exhaust fumes etc. Holocaust historians alleged that bodies were piled as high as multi-storied buildings and burned without a trace, using little or no fuel at all. Graf and Mattogno have now analyzed the origins, logic and technical feasibility of the official version of Treblinka. On the basis of numerous documents they reveal Treblinka's true identity as a mere transit

camp. 2nd ed., 372 pages, b&w illustrations, bibliography, index. (#8)

**Belzec in Propaganda, Testimonies, Archeological Research and History.** By Carlo Mattogno. Witnesses report that between 600,000 and 3 million Jews were murdered in the Belzec camp, located in Poland. Various murder weapons are claimed to have been used: diesel gas; unslaked lime in trains; high voltage; vacuum chambers; etc. The corpses were incinerated on huge pyres without leaving a trace. For those who know the stories about Treblinka this sounds familiar. Thus the author has restricted this study to the aspects which are new compared to Treblinka. In contrast to Treblinka, forensic drillings and excavations were performed at Belzec, the results of which are critically reviewed. 142 pages, b&w illustrations, bibliography, index. (#9)

**Sobibor: Holocaust Propaganda and Reality.** By Jürgen Graf, Thomas Kues and Carlo Mattogno. Between 25,000 and 2 million Jews are said to have been killed in gas chambers in the Sobibór camp in Poland. The corpses were allegedly buried in mass graves and later incinerated on pyres. This book investigates these claims and shows that they are based on the selective use of contradictory eyewitness testimony. Archeological surveys of the camp in 2000-2001 are analyzed, with fatal results for the extermination camp hypothesis. The book also documents the general National Socialist policy toward Jews, which never included a genocidal “final solution.” 442 pages, b&w illustrations, bibliography, index. (#19)

**The "Extermination Camps" of "Aktion Reinhardt".** By Jürgen Graf, Thomas Kues and Carlo Mattogno. In late 2011, several members of the exterminationist *Holocaust Controversies* blog posted a study online which claims to refute three of our authors' monographs on the camps Belzec, Sobibor and Treblinka (see previous three entries). This tome is their point-by-point response, which makes “mincemeat” out of the bloggers' attempt at refutation. **Caution:** The two volumes of this work are an intellectual overkill for most people. They are recommended only for collectors, connoisseurs and professionals. These two books require familiarity with the above-mentioned books, of which they are a comprehensive update and expansion. 2nd ed., two volumes, total of 1396 pages, illustrations, bibliography. (#28)

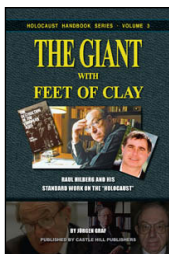
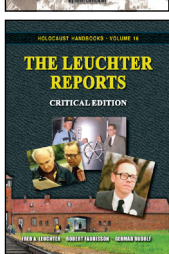
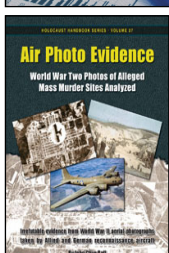
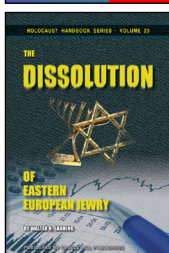
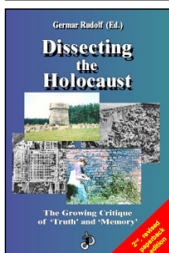
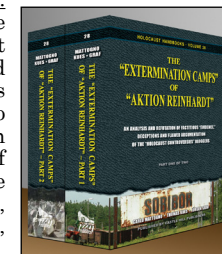
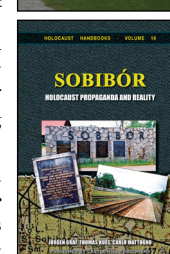
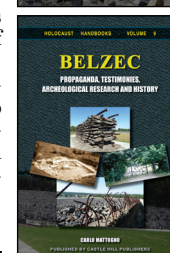
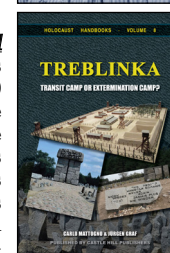
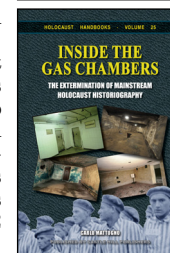

**Chelmno: A Camp in History & Propaganda.** By Carlo Mattogno. At Chelmno, huge masses of Jewish prisoners are said to have been rounded up and mercilessly gassed in “gas vans” or shot (claims vary from 10,000 to 1.3 million victims). Mattogno has examined reams of wartime documents and conducted on-site investigations at the Chelmno camp site and the neighboring countryside. The results challenge the conventional wisdom about Chelmno. Mattogno covers the subject from every angle, undermining the orthodox claims about the camp with an overwhelmingly effective body of evidence. Eyewitness statements, gas wagons as extermination weapons, forensics reports, coroners’ reports, archaeological excavations, the crematoria, building plans, official U.S. reports, German documents, evacuation efforts—all come under Mattogno’s scrutiny. Here are the uncensored facts about Chelmno, not the propaganda. 2nd ed., 188 pages, indexed, illustrated, bibliography. (#23)

**The Gas Vans: A Critical Investigation.** (A perfect companion to the Chelmno book.) By Santiago Alvarez and Pierre Marais. It is alleged that the Nazis used mobile gas chambers to exterminate 700,000 people. Up until 2011, no thorough monograph had appeared on the topic. Santiago Alvarez has remedied the situation. Are witness statements reliable? Are documents genuine? Where are the murder weapons? Could they have operated as claimed? Where are the corpses? In order to get to the truth of the matter, Alvarez has scrutinized all known wartime documents and photos about this topic; he has analyzed a huge amount of witness statements as published in the literature and as presented in more than 30 trials held over the decades in Germany, Poland and Israel; and he has examined the claims made in the pertinent mainstream literature. The result of his research is mind-boggling. Note: This book and Mattogno’s book on Chelmno were edited in parallel to make sure they are consistent and not repetitive. 398 pages, b&w illustrations, bibliography, index. (#26)

**The Einsatzgruppen in the Occupied Eastern Territories: Genesis, Responsibilities and Activities.** By C. Mattogno. Before invading the Soviet Union, the German authorities set up special units meant to secure the area behind the German front. Orthodox historians claim that these units called *Einsatzgruppen* primarily engaged in rounding up and mass-murdering

Jews. This study tries to shed a critical light into this topic by reviewing all the pertinent sources as well as material traces. Ca. 850 pp., b&w illustrations, bibliography, index. (Scheduled for late 2018; #39)

**Concentration Camp Majdanek. A Historical and Technical Study.** By Carlo Mattogno and Jürgen Graf. At war’s end, the Soviets claimed that up to two million Jews were murdered at the Majdanek Camp in seven gas chambers. Over the decades, however, the Majdanek Museum reduced the death toll three times to currently 78,000, and admitted that there were “only” two gas chambers. By exhaustively researching primary sources, the authors expertly dissect and repudiate the myth of homicidal gas chambers at that camp. They also critically investigated the legend of mass executions of Jews in tank trenches and prove them groundless. Again they have produced a standard work of methodical investigation which authentic historiography cannot ignore. 3rd ed., 358 pages, b&w illustrations, bibliography, index. (#5)

**Concentration Camp Stutthof and Its Function in National Socialist Jewish Policy.** By Carlo Mattogno and Jürgen Graf. Orthodox historians claim that the Stutthof Camp served as a “make-shift” extermination camp in 1944. Based mainly on archival resources, this study thoroughly debunks this view and shows that Stutthof was in fact a center for the organization of German forced labor toward the end of World War II. 4th ed., 170 pages, b&w illustrations, bibliography, index. (#4)

### SECTION THREE: Auschwitz Studies

**The Making of the Auschwitz Myth: Auschwitz in British Intercepts, Polish Underground Reports and Post-war Testimonies (1941-1947).** By Carlo Mattogno. Using messages sent by the Polish underground to London, SS radio messages sent to and from Auschwitz that were intercepted and decrypted by the British, and a plethora of witness statements made during the war and in the immediate postwar period, the author shows how exactly the myth of mass murder in Auschwitz gas chambers was created, and how it was turned subsequently into “history” by intellectually corrupt scholars who cherry-picked claims that fit into their agenda and ignored or actively covered up literally thousands of lies of “witnesses” to make their narrative look credible. Ca. 300

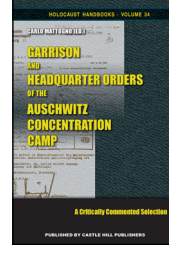
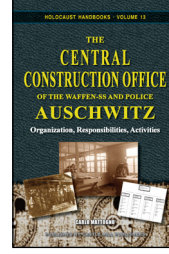
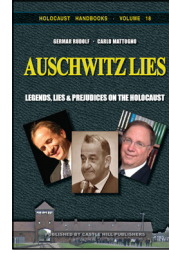
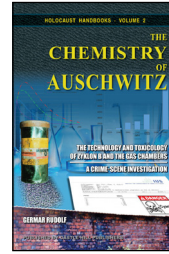
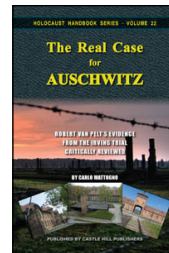
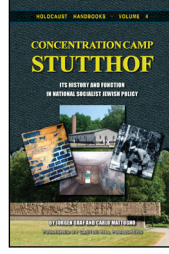
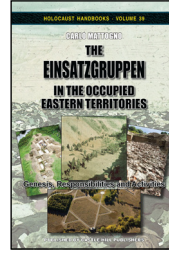
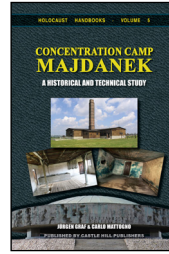
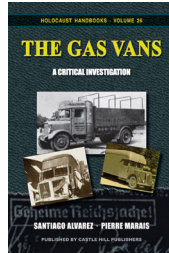
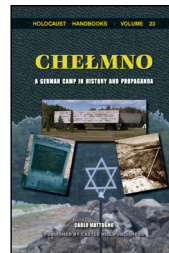

pp., b&w illustrations, bibliography, index. (Scheduled for mid-2018; #41)

**The Real Case of Auschwitz: Robert van Pelt’s Evidence from the Irving Trial Critically Reviewed.** By Carlo Mattogno. Prof. Robert van Pelt is considered one of the best mainstream experts on Auschwitz. He became famous when appearing as an expert during the London libel trial of David Irving against Deborah Lipstadt. From it resulted a book titled *The Case for Auschwitz*, in which van Pelt laid out his case for the existence of homicidal gas chambers at that camp. This book is a scholarly response to Prof. van Pelt—and Jean-Claude Pressac, upon whose books van Pelt’s study is largely based. Mattogno lists all the evidence van Pelt adduces, and shows one by one that van Pelt misrepresented and misinterpreted each single one of them. This is a book of prime political and scholarly importance to those looking for the truth about Auschwitz. 2nd ed., 758 pages, b&w illustrations, glossary, bibliography, index. (#22)

**Auschwitz: Plain Facts: A Response to Jean-Claude Pressac.** Edited by Germar Rudolf, with contributions by Serge Thion, Robert Faurisson and Carlo Mattogno. French pharmacist Jean-Claude Pressac tried to refute revisionist findings with the “technical” method. For this he was praised by the mainstream, and they proclaimed victory over the “revisionists.” In his book, Pressac’s works and claims are shown to be unscientific in nature, as he never substantiated what he claims, and historically false, because he systematically misrepresents, misinterprets and misunderstands German wartime documents. 2nd ed., 226 pages, b&w illustrations, glossary bibliography, index. (#14)

**The Chemistry of Auschwitz: The Technology and Toxicology of Zyklon B and the Gas Chambers – A Crime Scene Investigation.** By Germar Rudolf. While respecting the victims, whether of foul play or of circumstance, this study nonetheless tries to conduct Auschwitz research on the basis of the forensic sciences, where material traces of the crime and their interpretation reign supreme. Although it is generally agreed that no autopsy of any victim has ever been performed, most of the claimed crime scenes – the chemical slaughterhouses called gas chambers – are still accessible to forensic examination to a greater or lesser degree. This book addresses questions such as: How did these gas chambers of Auschwitz look like? How

did they operate? What were they used for? In addition, the infamous Zyklon B can also be examined. What exactly hides behind this ominous name? How does it kill? And what effect has it on masonry? Does it leave traces that can be found still today? By thoroughly examining these issues, the horror of Auschwitz is meticulously dissected, and thus, for the first time, it really becomes comprehensible. 3rd ed., 442 pages, more than 120 color and almost 100 b&w illustrations, bibliography, index. (#2)

**Auschwitz Lies: Legends, Lies and Prejudices on the Holocaust.** By C. Mattogno and G. Rudolf. The fallacious research and alleged “refutation” of Revisionist scholars by French biochemist G. Wellers (attacking Leuchter’s famous report), Polish chemist Dr. J. Markiewicz and U.S. chemist Dr. Richard Green (taking on Rudolf’s chemical research), Dr. John Zimmerman (tackling Mattogno on cremation issues), Michael Shermer and Alex Grobman (trying to prove it all), as well as researchers Keren, McCarthy and Mazal (how turned cracks into architectural features), are exposed for what they are: blatant and easily exposed political lies created to ostracize dissident historians. 3rd ed., 398 pages, b&w illustrations, index. (#18)

**Auschwitz: The Central Construction Office.** By C. Mattogno. Based upon mostly unpublished German wartime documents, this study describes the history, organization, tasks and procedures of the one office which was responsible for the planning and construction of the Auschwitz camp complex, including the crematories which are said to have contained the “gas chambers.” 2nd ed., 188 pages, b&w illustrations, glossary, index. (#13)

**Garrison and Headquarters Orders of the Auschwitz Camp.** By C. Mattogno. A large number of all the orders ever issued by the various commanders of the infamous Auschwitz camp have been preserved. They reveal the true nature of the camp with all its daily events. There is not a trace in these orders pointing at anything sinister going on in this camp. Quite to the contrary, many orders are in clear and insurmountable contradiction to claims that prisoners were mass murdered. This is a selection of the most pertinent of these orders together with comments putting them into their proper historical context. (Scheduled for late 2018; #34)

**Special Treatment in Auschwitz: Origin and Meaning of a Term.** By C. Mattogno. When appearing in German wartime documents, terms like “special treatment,” “special action,” and others have been interpreted as code words for mass murder. But that is not always true. This study focuses on documents about Auschwitz, showing that, while “special” had many different meanings, not a single one meant “execution.” Hence the practice of deciphering an alleged “code language” by assigning homicidal meaning to harmless documents – a key component of mainstream historiography – is untenable. 2nd ed., 166 pages, b&w illustrations, bibliography, index. (#10)

**Healthcare at Auschwitz.** By C. Mattogno. In extension of the above study on *Special Treatment in Auschwitz*, this study proves the extent to which the German authorities at Auschwitz tried to provide appropriate health care for the inmates. In the first part of this book, the author analyzes the inmates’ living conditions as well as the various sanitary and medical measures implemented to maintain or restore the inmates’ health. The second part explores what happened in particular to those inmates registered at Auschwitz who were “selected” or subject to “special treatment” while disabled or sick. The comprehensive documentation presented shows clearly that everything was tried to cure these inmates, especially under the aegis of Garrison Physician Dr. Wirths. The last part of this book is dedicated to the remarkable personality of Dr. Wirths, the Auschwitz garrison physician since 1942. His reality refutes the current stereotype of SS officers. 398 pages, b&w illustrations, bibliography, index. (#33)

**Debunking the Bunkers of Auschwitz: Black Propaganda vs. History.** By Carlo Mattogno. The bunkers at Auschwitz, two former farmhouses just outside the camp’s perimeter, are claimed to have been the first homicidal gas chambers at Auschwitz specifically equipped for this purpose. With the help of original German wartime files as well as revealing air photos taken by Allied reconnaissance aircraft in 1944, this study shows that these homicidal “bunkers” never existed, how the rumors about them evolved as black propaganda created by resistance groups in the camp, and how this propaganda was transformed into a false reality. 2nd ed., 292 pages, b&w illustrations, bibliography, index. (#11)

**Auschwitz: The First Gassing. Rumor and Reality.** By C. Mattogno. The first gassing in Auschwitz is claimed to have occurred on Sept. 3, 1941, in a basement room. The accounts reporting it are the archetypes for all later gassing accounts. This study analyzes all available sources about this alleged event. It shows that these sources contradict each other in location, date, victims etc, rendering it impossible to extract a consistent story. Original wartime documents inflict a final blow to this legend and prove without a shadow of a doubt that this legendary event never happened. 3rd ed., 190 pages, b&w illustrations, bibliography, index. (#20)

**Auschwitz: Crematorium I and the Alleged Homicidal Gassings.** By C. Mattogno. The morgue of Crematorium I in Auschwitz is said to be the first homicidal gas chamber there. This study investigates all statements by witnesses and analyzes hundreds of wartime documents to accurately write a history of that building. Where witnesses speak of gassings, they are either very vague or, if specific, contradict one another and are refuted by documented and material facts. The author also exposes the fraudulent attempts of mainstream historians to convert the witnesses’ black propaganda into “truth” by means of selective quotes, omissions, and distortions. Mattogno proves that this building’s morgue was never a homicidal gas chamber, nor could it have worked as such. 2nd ed., 152 pages, b&w illustrations, bibliography, index. (#21)

**Auschwitz: Open Air Incinerations.** By C. Mattogno. In spring and summer of 1944, 400,000 Hungarian Jews were deported to Auschwitz and allegedly murdered there in gas chambers. The Auschwitz crematoria are said to have been unable to cope with so many corpses. Therefore, every single day thousands of corpses are claimed to have been incinerated on huge pyres lit in deep trenches. The sky over Auschwitz was covered in thick smoke. This is what some witnesses want us to believe. This book examines the many testimonies regarding these incinerations and establishes whether these claims were even possible. Using air photos, physical evidence and wartime documents, the author shows that these claims are fiction. A new Appendix contains 3 papers on groundwater levels and cattle mass burnings. 2nd ed., 202 pages, b&w illustrations, bibliography, index. (#17)

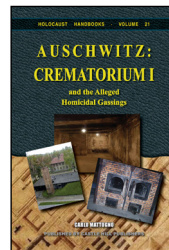
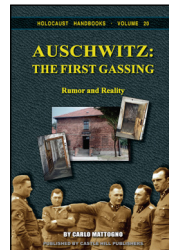
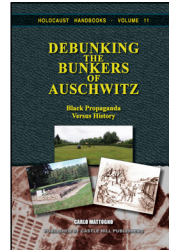
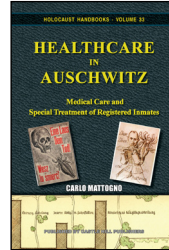
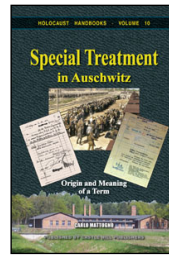

**The Cremation Furnaces of Auschwitz.** By Carlo Mattogno & Franco Deana. An exhaustive study of the history and technology of cremation in general and of the cremation furnaces of Auschwitz in particular. On a vast base of technical literature, extant wartime documents and material traces, the authors can establish the true nature and capacity of the Auschwitz cremation furnaces. They show that these devices were inferior make-shift versions of what was usually produced, and that their capacity to cremate corpses was lower than normal, too. 3 vols., 1198 pages, b&w and color illustrations (vols 2 & 3), bibliography, index, glossary. (#24)

**Curated Lies: The Auschwitz Museum's Misrepresentations, Distortions and Deceptions.** By Carlo Mattogno. Revisionist research results have put the Polish Auschwitz Museum under pressure to answer this challenge. They’ve answered. This book analyzes their answer and reveals the appallingly mendacious attitude of the Auschwitz Museum authorities when presenting documents from their archives. 248 pages, b&w illustrations, bibliography, index. (#38)

**Deliveries of Coke, Wood and Zyklon B to Auschwitz: Neither Proof Nor Trace for the Holocaust.** By Carlo Mattogno. Researchers from the Auschwitz Museum tried to prove the reality of mass extermination by pointing to documents about deliveries of wood and coke as well as Zyklon B to the Auschwitz Camp. If put into the actual historical and technical context, however, these documents prove the exact opposite of what these orthodox researchers claim. Ca. 250 pages, b&w illustrations, bibliography, index. (Scheduled for early 2019; #40)

## SECTION FOUR: Witness Critique

**Holocaust High Priest: Elie Wiesel, Night, the Memory Cult, and the Rise of Revisionism.** By Warren B. Routledge. The first unauthorized biography of Wiesel exposes both his personal deceptions and the whole myth of “the six million.” It shows how Zi-

onist control has allowed Wiesel and his fellow extremists to force leaders of many nations, the U.N. and even popes to genuflect before Wiesel as symbolic acts of subordination to World Jewry, while at the same time forcing school children to submit to Holocaust brainwashing. 468 pages, b&w illust., bibliography, index. (#30)

**Auschwitz: Confessions and Testimonies.** By Jürgen Graf. The traditional narrative of what transpired at the infamous Auschwitz Camp during WWII rests almost exclusively on witness testimony. This study critically scrutinizes the 40 most important of them by checking them for internal coherence, and by comparing them with one another as well as with other evidence such as wartime documents, air photos, forensic research results, and material traces. The result is devastating for the traditional narrative. (Scheduled for late-2018; #36)

**Commandant of Auschwitz: Rudolf Höss, His Torture and His Forced Confessions.** By Carlo Mattogno & Rudolf Höss. From 1940 to 1943, Rudolf Höss was the commandant of the infamous Auschwitz Camp. After the war, he was captured by the British. In the following 13 months until his execution, he made 85 depositions of various kinds in which he confessed his involvement in the “Holocaust.” This study first reveals how the British tortured him to extract various “confessions.” Next, all of Höss’s depositions are analyzed by checking his claims for internal consistency and comparing them with established historical facts. The results are eye-opening... 402 pages, b&w illust., bibliography, index. (#35)

**An Auschwitz Doctor's Eyewitness Account: The Tall Tales of Dr. Mengele's Assistant Analyzed.** By Miklos Nyiszli & Carlo Mattogno. Nyiszli, a Hungarian physician, ended up at Auschwitz in 1944 as Dr. Mengele’s assistant. After the war he wrote a book and several other writings describing what he claimed to have experienced. To this day some traditional historians take his accounts seriously, while others reject them as grotesque lies and exaggerations. This study presents and analyzes Nyiszli’s writings and skillfully separates truth from fabulous fabrication. 484 pages, b&w illust., bibliography, index. (#37)

FOR CURRENT PRICES AND AVAILABILITY SEE BOOK FINDER SITES SUCH AS [BOOKFINDER.COM](http://BOOKFINDER.COM), [ADDALL.COM](http://ADDALL.COM), [BOOKFINDER4U.COM](http://BOOKFINDER4U.COM) OR [FINDBOOKPRICES.COM](http://FINDBOOKPRICES.COM); LEARN MORE AT [WWW.HOLOCAUSTHANDBOOKS.COM](http://WWW.HOLOCAUSTHANDBOOKS.COM) PUBLISHED BY CASTLE HILL PUBLISHERS, PO Box 243, UCKFIELD, TN22 9AW, UK

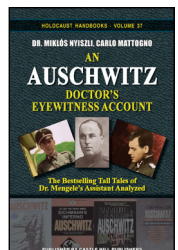
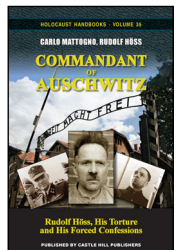
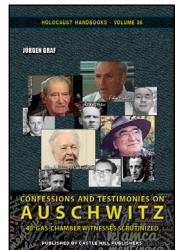
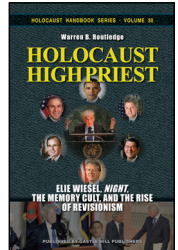
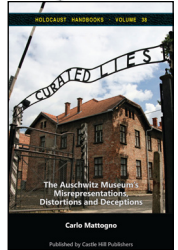

# BOOKS BY AND FROM CASTLE HILL PUBLISHERS

Below please find some of the books published or distributed by Castle Hill Publishers in the United Kingdom. For our current and complete range of products visit our web store at [shop.codoh.com](http://shop.codoh.com).

## Thomas Dalton, *The Holocaust: An Introduction*

The Holocaust was perhaps the greatest crime of the 20th century. Six million Jews, we are told, died by gassing, shooting, and deprivation. But: Where did the six million figure come from? How, exactly, did the gas chambers work? Why do we have so little physical evidence from major death camps? Why haven't we found even a fraction of the six million bodies, or their ashes? Why has there been so much media suppression and governmental censorship on this topic? In a sense, the Holocaust is the greatest murder mystery in history. It is a topic of greatest importance for the present day. Let's explore the evidence, and see where it leads.

128 pp. pb, 5"×8", ill., bibl., index

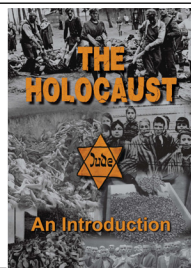

## Carlo Mattogno, *Auschwitz: A Three-Quarter Century of*

### *Propaganda: Origins, Development and Decline of the "Gas Chamber" Propaganda Lie*

During the war, wild rumors were circulating about Auschwitz: that the Germans were testing new war gases; that inmates were murdered in electrocution chambers, with gas showers or pneumatic hammer systems; that living people were sent on conveyor belts directly into cremation furnaces; that oils, grease and soap were made of the mass-murder victims. Nothing of it was true. When the Soviets captured Auschwitz in early 1945, they reported that 4 million inmates were killed on electrocution conveyor belts discharging their load directly into furnaces. That wasn't true either. After the war, "witnesses" and "experts" repeated these things and added more fantasies: mass murder with gas bombs, gas chambers made of canvas; carts driving living people into furnaces; that the crematoria of Auschwitz could have cremated 400 million victims... Again, none of it was true. This book gives an overview of the many rumors, myths and lies about Auschwitz which mainstream historians today reject as untrue. It then explains by which ridiculous methods some claims about Auschwitz were accepted as true and turned into "history," although they are just as untrue.

125 pp. pb, 5"×8", ill., bibl., index, b&w ill.

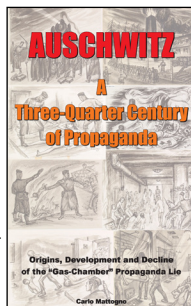

## Wilhelm Stäglich, *Auschwitz: A Judge Looks at the Evidence*

Auschwitz is the epicenter of the Holocaust, where more people are said to have been murdered than anywhere else. At this detention camp the industrialized Nazi mass murder is said to have reached its demonic pinnacle. This narrative is based on a wide range of evidence, the most important of which was presented during two trials: the International Military Tribunal of 1945/46, and the German Auschwitz Trial of 1963-1965 in Frankfurt.

The late Wilhelm Stäglich, until the mid-1970s a German judge, has so far been the only *legal* expert to critically analyze this evidence. His research reveals the incredibly scandalous way in which the Allied victors and later the German judicial authorities bent and broke the law in order to come to politically foregone conclusions. Stäglich also exposes the shockingly superficial way in which historians are dealing with the many incongruities and discrepancies of the historical record.

3rd edition 2015, 422 pp., 6"×9", pb, b&w ill.

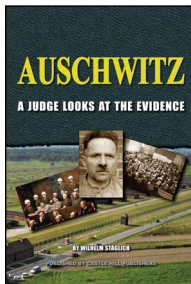

## Gerard Menuhin: *Tell the Truth & Shame the Devil*

A prominent Jew from a famous family says the "Holocaust" is a wartime propaganda myth which has turned into an extortion racket. Far from bearing the sole guilt for starting WWII as alleged at Nuremberg (for which many of the surviving German leaders were hanged) Germany is mostly innocent in this respect and made numerous attempts to avoid and later to end the confrontation. During the 1930s Germany was confronted by a powerful Jewish-dominated world plutocracy out to destroy it... Yes, a prominent Jew says all this. Accept it or reject it, but be sure to read it and judge for yourself!

The author is the son of the great American-born violinist Yehudi Menuhin, who, though from a long line of rabbinical ancestors, fiercely criticized the foreign policy of the state of Israel and its repression of the Palestinians in the Holy Land.

4th edition 2017, 432 pp. pb, 6"×9", b&w ill.

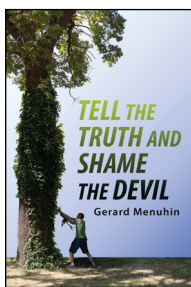

**Germar Rudolf, *Bungled: “Denying the Holocaust”* How Deborah Lipstadt Botched Her Attempt to Demonstrate the Growing Assault on Truth and Memory**

With her book *Denying the Holocaust*, Deborah Lipstadt tried to show the flawed methods and extremist motives of “Holocaust deniers.” This book demonstrates that Dr. Lipstadt clearly has neither understood the principles of science and scholarship, nor has she any clue about the historical topics she is writing about. She misquotes, mistranslates, misrepresents, misinterprets, and makes a plethora of wild claims without backing them up with anything. Rather than dealing thoroughly with factual arguments, Lipstadt’s book is full of *ad hominem* attacks on her opponents. It is an exercise in anti-intellectual pseudo-scientific arguments, an exhibition of ideological radicalism that rejects anything which contradicts its preset conclusions. **F for FAIL**

2nd ed., 224 pp., 5”x8”, pb, bibl., index, b&w ill.

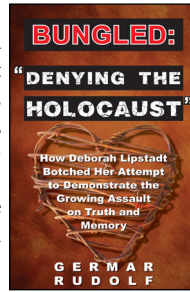

**Carolus Magnus, *Bungled: “Denying History”*. How Michael Shermer and Alex Grobman Botched Their Attempt to Refute Those Who Say the Holocaust Never Happened**

*Skeptic Magazine* editor Michael Shermer and Alex Grobman from the Simon Wiesenthal Center wrote a book in 2000 which they claim is “a thorough and thoughtful answer to all the claims of the Holocaust deniers.” In 2009, a new “updated” edition appeared with the same ambitious goal. In the meantime, revisionists had published some 10,000 pages of archival and forensic research results. Would their updated edition indeed answer all the revisionist claims? In fact, Shermer and Grobman completely ignored the vast amount of recent scholarly studies and piled up a heap of falsifications, contortions, omissions, and fallacious interpretations of the evidence. Finally, what the authors claim to have demolished is not revisionism but a ridiculous parody of it. They ignored the known unreliability of their cherry-picked selection of evidence, utilizing unverified and incestuous sources, and obscuring the massive body of research and all the evidence that dooms their project to failure. **F for FAIL**

162 pp., 5”x8”, pb, bibl., index, b&w ill.



**Carolus Magnus, *Bungled: “Debunking Holocaust Denial Theories”*. How James and Lance Morcan Botched Their Attempt to Affirm the Historicity of the Nazi Genocide**

The novelists and movie-makers James and Lance Morcan have produced a book “to end [Holocaust] denial once and for all.” To do this, “no stone was left unturned” to verify historical assertions by presenting “a wide array of sources” meant “to shut down the debate deniers wish to create. One by one, the various arguments Holocaust deniers use to try to discredit wartime records are carefully scrutinized and then systematically disproven.” It’s a lie. First, the Morcans completely ignored the vast amount of recent scholarly studies published by revisionists; they didn’t even identify them. Instead, they engaged in shadowboxing, creating some imaginary, bogus “revisionist” scarecrow which they then tore to pieces. In addition, their knowledge even of their own side’s source material was dismal, and the way they backed up their misleading or false claims was pitifully inadequate. **F for FAIL**

144 pp., 5”x8”, pb, bibl., index, b&w ill.

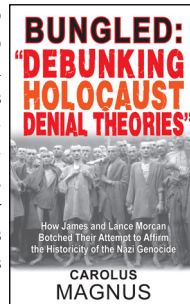

**Joachim Hoffmann, *Stalin’s War of Extermination 1941-1945***

A German government historian documents Stalin’s murderous war against the German army and the German people. Based on the author’s lifelong study of German and Russian military records, this book reveals the Red Army’s grisly record of atrocities against soldiers and civilians, as ordered by Stalin. Since the 1920s, Stalin planned to invade Western Europe to initiate the “World Revolution.” He prepared an attack which was unparalleled in history. The Germans noticed Stalin’s aggressive intentions, but they underestimated the strength of the Red Army. What unfolded was the most-cruel war in history. This book shows how Stalin and his Bolshevik henchman used unimaginable violence and atrocities to break any resistance in the Red Army and to force their unwilling soldiers to fight against the Germans. The book explains how Soviet propagandists incited their soldiers to unlimited hatred against everything German, and he gives the reader a short but extremely unpleasant glimpse into what happened when these Soviet soldiers finally reached German soil in 1945: A gigantic wave of looting, arson, rape, torture, and mass murder...

428 pp. pb, 6”x9”, bibl., index, b&w ill.

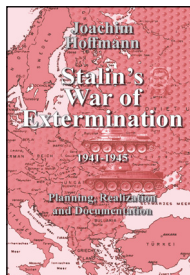

For prices and availability see [www.shop.codoh.com](http://www.shop.codoh.com) or write to: CHP, PO Box 243, Uckfield, TN22 9AW, UK

**Udo Walendy, *Who Started World War II: Truth for a War-Torn World***

For seven decades, mainstream historians have insisted that Germany was the main, if not the sole culprit for unleashing World War II in Europe. In the present book this myth is refuted. There is available to the public today a great number of documents on the foreign policies of the Great Powers before September 1939 as well as a wealth of literature in the form of memoirs of the persons directly involved in the decisions that led to the outbreak of World War II. Together, they made possible Walendy’s present mosaic-like reconstruction of the events before the outbreak of the war in 1939. This book has been published only after an intensive study of sources, taking the greatest care to minimize speculation and inference. The present edition has been translated completely anew from the German original and has been slightly revised.

500 pp. pb, 6”x9”, index, bibl., b&w ill.

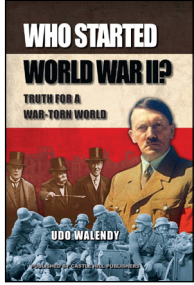

**Germar Rudolf: *Resistance is Obligatory!***

In 2005 Rudolf, a peaceful dissident and publisher of revisionist literature, was kidnapped by the U.S. government and deported to Germany. There the local lackey regime staged a show trial against him for his historical writings. Rudolf was not permitted to defend his historical opinions, as the German penal law prohibits this. Yet he defended himself anyway: 7 days long Rudolf held a speech in the court room, during which he proved systematically that only the revisionists are scholarly in their attitude, whereas the Holocaust orthodoxy is merely pseudo-scientific. He then explained in detail why it is everyone’s obligation to resist, without violence, a government which throws peaceful dissident into dungeons. When Rudolf tried to publish his public defence speech as a book from his prison cell, the public prosecutor initiated a new criminal investigation against him. After his probation time ended in 2011, he dared publish this speech anyway...

2nd ed. 2016, 378 pp., 6”x9”, pb, b&w ill.

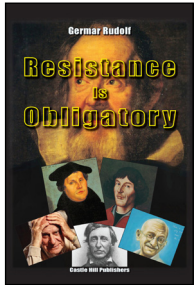

**Germar Rudolf, *Hunting Germar Rudolf: Essays on a Modern-Day Witch Hunt***

German-born revisionist activist, author and publisher Germar Rudolf describes which events made him convert from a Holocaust believer to a Holocaust skeptic, quickly rising to a leading personality within the revisionist movement. This in turn unleashed a tsunami of persecution against him: loss of his job, denied PhD exam, destruction of his family, driven into exile, slandered by the mass media, literally hunted, caught, put on a show trial where filing motions to introduce evidence is illegal under the threat of further prosecution, and finally locked up in prison for years for nothing else than his peaceful yet controversial scholarly writings. In several essays, Rudolf takes the reader on a journey through an absurd world of government and societal persecution which most of us could never even fathom actually exists...

304 pp., 6”x9”, pb, bibl., index, b&w ill.



**Germar Rudolf, *The Day Amazon Murdered History***

Amazon is the world’s biggest book retailer. They dominate the U.S. and several foreign markets. Pursuant to the 1998 declaration of Amazon’s founder Jeff Bezos to offer “the good, the bad and the ugly,” customers once could buy every book that was in print and was legal to sell. However, in early 2017, a series of anonymous bomb threats against Jewish community centers occurred in the U.S., fueling a campaign by Jewish groups to coax Amazon into banning revisionist writings, false portraying them as anti-Semitic. On March 6, 2017, Amazon caved in and banned more than 100 books with dissenting viewpoints on the Holocaust. In April 2017, an Israeli Jew was arrested for having placed the fake bomb threats, a paid “service” he had offered for years. But that did not change Amazon’s mind. Its stores remain closed for history books Jewish lobby groups disapprove of. This book accompanies the documentary of the same title. Both reveal how revisionist publications had become so powerfully convincing that the powers that be resorted to what looks like a dirty false-flag operation in order to get these books banned from Amazon...

128 pp. pb, 5”x8”, bibl., b&w ill.



FOR CURRENT PRICES AND AVAILABILITY SEE BOOK FINDER SITES SUCH AS [WWW.BOOKFINDER.COM](http://WWW.BOOKFINDER.COM), [WWW.ADDALL.COM](http://WWW.ADDALL.COM), [WWW.BOOKFINDER4U.COM](http://WWW.BOOKFINDER4U.COM) OR [WWW.FINDBOOKPRICES.COM](http://WWW.FINDBOOKPRICES.COM); LEARN MORE AT [SHOP.CODOH.COM](http://SHOP.CODOH.COM). PUBLISHED BY CASTLE HILL PUBLISHERS, PO Box 243, UCKFIELD, TN22 9AW, UK