

Boris Mouravieff

GNOSIS

BOOK TWO

The Mesoteric Cycle

Offered by VenerabilisOpus.org

Dedicated to preserving the rich cultural
and spiritual heritage of humanity.

STUDY AND COMMENTARIES
ON THE ESOTERIC TRADITION
OF EASTERN ORTHODOXY

*Translated by S. A. Wissa,
Mmtek d'Onciesi and Robin Amis,
and (dittd) by Robin Amis.*

PRAXIS INSTITUTE PRESS

Praxis Institute Press,
275 High Road, Newbury,
MA 01951, USA "
and
China Hill, Brighting Road,
Robertsbridge, East Sussex,
TN32 5EH, UK

Printed in Great Britain by
BPCC Whearons Ltd., Exeter

Cover design by Lance Hidy, typesetting
and drawings by Martin Gordon.

We gratefully acknowledge the contributions of
a supporting team of translators and editors
including S and L.K., D.A.B.L., T.N., S.\X'
and L.G.A., and contributions towards
production costs by D.A.B.L. and others.

Original text © L. MouravierT and heir 1992
Translation © Praxis Research Institute 1992

No part of this book may be reproduced in any form
without permission from the publisher, except for
the quotation of brief passages in criticism.

First published in French by
les Editions du Vieux Colombier,
collection La Colombe, Paris, 1961,
then by les Editions de La Baconniere,
Neuchatel, Switzerland, 1972
English edition first published 1992

British Library Cataloguing-in-Publication Data: A
catalogue record for this book is available from the
British Library

Library of Congress catalogue card number:
91-226573

ISBN 1-872292-U-9

AND HE SAITH UNTO ME, SEAL NOT THE SAYINGS OF
THE PROPHECY OF THIS BOOK: FOR THE TIME IS AT
HAND. HE THAT IS UNJUST, LET HIM BE UNJUST STILL:
AND HE THAT IS FILTHY, LET HIM BE FILTHY STILL: AND
HE THAT IS RIGHTEOUS, LET HIM BE RIGHTEOUS STILL:
AND HE THAT IS HOLY LET HIM BE HOLY STILL

AND, BEHOLD, I COME QUICKLY; AND MY REWARD IS
WITH ME. TO GIVE EVERY MAN ACCORDING AS HIS
WORK SHALL BE.

I AM ALPHA AND OMEGA, THE BEGINNING AND THE END,
THE FIRST AND THE LAST.

I JESUS HAVE SENT MINE ANGEL TO TESTIFY UNTO
YOU THESE THINGS IN THE CHURCHES. I AM THE
ROOT AND THE OFFSPRING OF DAVID, AND THE
BRIGHT AND MORNING STAR.

AND THE SPIRIT AND THE BRIDE SAY, COME. AND LET
HIM THAT HEARETH SAY, COME. AND LET HIM THAT
IS AT FIRST COME. AND WHOSOEVER WILL, LET HIM
TAKE THE WATER OF LIFE FREELY.

(Revelation xxii: 10-17)

1. In the Greek text: *fijuf*; in Slavonic: *HEBECTA* (*fincee*); in the Vulgate: *spoma*.

CONTENTS

PUBLISHER'S INTRODUCTION	
Relation to the Church	xiii
Relation to the Fourth Way	xiv
Esotericism is just inner science	xvi
EDITOR'S NOTES	
The question of translation	xix
Words in question	xx
PREFACE	xxiii
AUTHOR'S INTRODUCTION	xxv

FIRST PART: MAN

CHAPTER I	3
Plan of the mesoteric studies in Volume II of <i>Gnosis</i> . The meaning of the evolution of <i>organic life on Earth</i> . Its growth and its development. The notes LA, SOL and FA of the <i>lateral octave</i> : Man and the Fauna and Flora. The process of creation follows, in the most general sense, a descending scale. Three consecutive stages. Process of creation of a human prototype. The formation of the lower intellectual centre. The problem of Man goes incommensurably beyond his immediate interests here below and even in the hereafter.	
CHAPTERn	15
The place occupied by the human being in the context of <i>organic life</i> . The unity of <i>organic life</i> expressed by a common factor — respiration. Connections of <i>organic life</i> with the sun and the moon. Growth and development of man in relation to fauna and flora; quantitative and qualitative aspects of the energy required by the <i>transmission station</i> to meet cosmic needs. The necessity for man to modify his attitude towards the higher planes of Love.	
CHAPTER III	27
Manifestations of Love, the noumenal basis of the Macrocos-mos. Mechanisms and forms through which the Earth transmits solar energy to its satellite. Process of development of the Ray of creation so as to vivify this satellite, by the refinement of <i>organic life on Earth</i> . The role of man in these transformations. To make the MI of the lateral octave	

resonate at the full, new abilities must be developed in man, leading to a renewal of intelligence (St Paul). Then a transition is possible to the level of *Homo/aber*.

CHAPTER IV 37

The importance of the conscious efforts that man must deploy to attain this higher level of being. To put on the new man he must put off the old man (St Paul). The question of the Resurrection from many different points of view. Coming of the Son of Man. The end of the 'World' coincides with the Coming of the Cycle of the Holy Spirit, What does the general Resurrection signify? This problem examined in relation to reincarnation.

CHAPTER V 47

The general Resurrection represents the Accomplishment for adamic man, approving his active and conscious participation in the development of our *Ray of Creation*. The principle periods in the evolution of man and of humanity. The passage from the Cycle of the Father to the Cycle of the Son. Refusal of the chosen people to receive the *Light*, with all the consequences that have followed that refusal. Golgotha: the fall of the chosen people when faced with the test of the passage of the second Threshold. Analogy of the political solution adopted by the Sanhedrin concerning the Saviour with the situation of man, faced with the dilemma of the *Tree of the Knowledge of good and evil*. The mystical considerations which influenced the Sanhedrin's decision; in particular, an examination of the inevitable consequences of a massive conversion of the Chosen People to Christianity. Result: humanity was saved only *is hope* (St Paul).

CHAPTER VI 61

The general condition for Salvation: humanity must take the path that leads from *the fallen* state to the original state. Because of the check met with at the moment of passing from the Cycle of the Father to the Cycle of the Son, mankind has become the victim of psychisms, placing these at the top of the scale of values. This has progressively accentuated the gap between moral progress and material progress. Analogy between the present epoch and that of the Forerunner. Before he can attain to *Lone, Faith* and *Hope* must animate a Man, for only these will allow him access to *Knowledge*, the forerunner of *Love*.

CHAPTER VII 71

Man is placed at a junction in the cosmic scale of values. The ditch between science and religion. Human traditions. The passage to the new cycle demands from man a collective planetary consciousness.

International organizations and the embryo of a Federation of all Nations. The forum of international relations finds itself more and more swamped by social and economic concerns which exercise an increasing influence over political affairs. Federalism appears, from the esoteric point of view, as the only method that will allow the establishment of unity at aplanetary level. The influence of modern life on the Personality of man. The passage of public life to a higher level of consciousness.

SECOND PART: THE UNIVERSE PREFACE TO

PART TWO

CHAPTER Vm 89

Working of the *lateral* cosmic octave. The Absolute and the conception of corporeal life. The two aspects of Imagination. The system of the Mrs? *cosmic octaves*. A progressive double contraction allows passage from the *Law of seven* to the *Law of Three*. The feminine force and the masculine force in the second and third *cosmic octaves*. Revelation is not fixed: it is always measured out to meet the needs of the time and the cause.

CHAPTER IX 99

Relative ideas of the Absolutes I, II and III. The Divine Trinity as it appears in certain pre-christian religions. In its manifestation the Holy Trinity takes on the appearances of three *hypostases*: the Father, the Son, and the Holy Spirit. The creative properties of ZERO. The numbers ONE and TWO and their divine attributes. The interpretation of the entity Absolute II to which the number FOUR is symbolically assigned. The number Three attributed to the feminine Principle of Creation. Boundaries of the domain ruled by the Absolute III.

CHAPTER X 111

Octaves of radiation from the supporting points of the skeleton of the universe, represented by the Absolute, the stellar World, the planetary World, and the World of satellites. The table of Hydrogens, representing the scale of values of substance-types throughout the whole *Macrocosmos*. The scale as applied to Man.

CHAPTER XI 119

The nourishment of the Universe. The nourishment of the physical organism and the psychological organism of man achieved by using three interdependent scales. The transmutation of Hydrogens by means of octaves of food, respiration and impressions. Filling the intervals. Possibility of two uses for sex energy. Man must make conscious efforts to obtain fine hydrogens.

CHAPTER XII 129
The Era of the Holy Spirit demands that everything be revealed. The system of three cosmic octaves explains the meaning of Evil as it is seen in the whole structure of the Universe. The significance of original sin. Its repetition by the identification of man with the T of his personality. Regeneration by means of identification with the real T involves a struggle. The basis of sin is error. The doctrine of Evil according to pre-Christian Slavic theology, Aspects of the problem of initiation examined in the light of the system of *three cosmic octaves*. The meaning and effect of that initiation that can properly be called esoteric.

CHAPTER XIII 141
Civilizing historical types after Danilevsky. Recognizing them allows us to grasp the inner meaning of the historical process and to reject the classical idea of *the thread of history*. The classic subdivision of general history is not natural. Progress consists in every field of historical activity of mankind being crossed in all possible directions, Historical civilizing types. Definition *at culture* and *civilisation* in their esoteric sense. Only the appearance of the New Man among the historical civilizing types will allow a new organization of human society to be put in place. Displacement of efforts accomplished from the level of 'A' influences to that of 'B' influences.

CHAPTER XIV 153
The four fundamental particularities of Christianity. The unification of the world, not only on the material plane but on the psychological, is happening before our eyes, A tendency to unity on the spiritual plane is manifesting in Christianity at the present time. The problem of the union of the Churches. The *Third Testament*.

THIRD PART: THE WAY

CHAPTER XV 163
The esoteric meaning of the symbol of the *Chimera*: an impossible being possessing a motor centre and an intellectual centre, but lacking an emotional centre. The state of the human Personality of the cultivated man of the *present* time, its danger. The mechanism of human morality.

CHAPTER XVI 173
The six proto-types of the imbalance of the Personality of *exterior* men. They are examined. Practical indications.

CHAPTER XVn 185
The *Decalogue* regarded as a working instrument in the Orthodox Tradition, based on the maxim: *look at yourself in the ten commandments as in a mirror*. The *living mirror*. The four castes into which all humanity is divided. Their characteristics from the esoteric point of view. The impossibility of a man's changing his type: his task is to perfect it. *Individuality*. In the *Individuality* the 987 little I's of the Personality are reduced to 72. Balance (*Eau libre*). The sublimation of sex.

CHAPTER XVm 195
Negative emotions. Faith, Hope and Knowledge (Gnosis) form successive stages in the revelation of Love. The *triple edged sword*. The destructive effects of negative emotions. The emotions are in fact no more than different admixtures to Love. Possible treatments of negative emotions that can release pure Love. Negative emotions as a source of fine positive energies. One who is involved in esoteric work should not flee from negative emotions. Texts and commentaries. Joy and Victory. The possibility and usefulness of loving one's enemies.

CHAPTER XIX 209
Introspection, the doubling of interior constataions leading to self-knowledge, that is, knowledge of the content of the Personality. Only yesterday a slave to his instincts and his passions, the *faithful* begins to understand that negative emotions, an effect of the *General law*, seek to keep him in that state and in his place, to the benefit of the whole but to the detriment of his personal interests as properly understood. Through *experience*, this first knowledge brings him a new *power*. Inner peace, the necessary condition for working. *The Invisible Combat*. Partial victories. Sincerity towards oneself. Purity of Faith. Help that comes from outside and from within. The generally positive role of negative emotions. *Fusion*. Five stages: 1. Introspection; 2. Active calm; 3. Warmth; 4. Fire; 5. Fusion.

CHAPTER XX 221
Study of the relationship between the 7' of the Personality and the real T on the one hand, and on the other hand between the 7' of the Personality and the T of the body. Their interdependence looked at in different ways. The eight disciplines which tie the developed and born Personality to the real 7': eight others which tie it to the T of the body. The *Androgyne* and the *Microcosmos*. The bipolar nature of the real 7'. Explanatory diagrams.

The meaning of human life. Sentences from Pushkin and Lermontov. The Golden Book. *The end of life is to attain Love*. The text of the Golden Book referring to polar beings. The polarity of their sexual centres. The three baptisms: the Baptism of Water, the Baptism of Fire, and the Baptism of the Spirit.

Bibliography

259

PUBLISHER'S INTRODUCTION

In the French edition of this book, the author's introduction (included in this translation) attempted to answer some of the more persistent questions raised with him after the publication of Volume I. These questions and their answers are most interesting to serious students of these ideas, and particularly to those who are trying to put the ideas in the book into practice, so that we have included the whole of that introduction in this translation (See p. xxv below). But times have now changed, and at the present time —since the translation of Volume I into English and its final release a little over a year ago — we have found new questions and new misunderstandings coming from the difference in time and place from those which presided over the birth of the original French edition thirty years ago.

In spite of the belief in progress that is still held by some people, some things that were clear to readers when the French edition was published are no longer so clear to us today. In some ways the background against which things must be understood has changed, so that today we must perhaps explain more about the nature and purpose of this book —and even about the form of its translation— than would have been necessary thirty years ago. In particular it seems necessary to clarify the relation of this work to two things: to the Orthodox church itself, and to something apparently quite different— to what has become known in the past thirty years or so as *The Gurdjieff work* or the *Fourth Way*. To answer both of these questions we must in turn address a third: the question of an alternative to monasticism for those devout Christians drawn to true spirituality but whose inner or outer commitments to the everyday world are too binding to allow them to withdraw from the world.

Relation to the Church

Among other things it must be made clear that Boris Mouravieff's *Gnosis* is an attempt to recover and describe, in terms understandable to modern man, a particular Tradition handed down over the centuries, in a sometimes perhaps broken line¹ but one that still exists today in the Orthodox church as that continues amongst the hundreds of millions of Christians in the Orthodox Christian world. This tradition could be said to be the Christian equivalent of Yoga, Zen and the other inner traditions of the far Eastern religions, disciplines which have each existed

1. There is evidence of this line's having been reconstructed or reconstituted several times in the past fifteen hundred years. (Ed.)

as specializations *within* the religion of* which they are part — and which have now become accepted parts of those faiths, something that cannot always be said of their Christian equivalent. Like Yoga and similar traditions, or like specific sciences such as physics in a different context, it is not one man's system or invention, but has its roots far back in the history of our religion—according to the text itself of this work, those roots in fact lie in certain statements of Saint Paul, perhaps even of Christ himself, and their development can be traced first through formative figures of the early churches, including key figures who have given shape to the modern Orthodox church, such as Saint Basil the Great, Gregory of Nyssa, and Saint Symeon the New Theologian. It clearly relates to the doctrines expressed in key texts of Eastern spirituality such as the *Philokalia*, although these tend to emphasize ideas more applicable in a monastic context. Its later form can be traced particularly in the Russian church, which has ever been more willing to speak openly about such things, although it clearly relates to the oral tradition known as the *Royal Way* that survives to this day in the main centres of monasticism in the Eastern church. But its specialist character means that it does not claim to be a work of Orthodox theology, nor to reinterpret Orthodox doctrine per se so much as to express ways of applying that doctrine to specific questions of human spirituality, although in certain places, particularly in this Volume II, it does raise sometimes challenging interpretations of Theological doctrines.

Mouravieff himself admits that the survival of this tradition within the church is tenuous, that the doctrine does not appear to survive in full or has not been collected together in full, although the point is made by students of this tradition that it must be known to a certain degree of completeness before it will serve its proper purpose. Monks on Athos admit the existence of the Tradition but say that it has never been fully spelled out in writing. To be more precise still, the monastic form does appear to survive in certain places, but the additional knowledge needed to progress in everyday life appears to be more dispersed and the importance of this book, in this sense, is the efforts it has made to collect that dispersed information and make it accessible *in practical form*.

Relation to the Fourth Way

Both Gurdjieff and Ouspensky stated at different times that the practical teachings and methods they taught were a form *oiesoteric Christianity*. This does not conflict with the idea that many of G's methods were learned from Sufi (i.e. Islamic) sources. Even the Old Testament says that: 'The Lord thy God is one God.' And Mouravieff more than once quotes within

this work the maxim that 'The Tradition is one.' Mouravieff several times refers to the Fourth Way within this book, although placing this in context with other related 'ways'. But the real point of this is that in-depth study of the text of his Gnosis does produce practical solutions in this context as well as in that of 'purely' Christian spirituality. To be more exact, the book opens up to provide exactly what it claims, to provide — for those who study it in sufficient depth—what Mouravieff called a *truzgt/osis* or true *self-knowkdgt* which does four things in particular.

It transforms our relation to ourselves — and makes it possible, for example, for us to understand this statement. And this leads into an understanding of what has often been described in terms such as: '*the way to God is through oneself*.'

This forms within us a new ability to control the different parts of the mind that until now control us.

This in turn gives us sufficient knowledge of our 'organism' to develop methods for remedying its weaknesses and to understand and properly apply methods previously developed for this purpose.

And this then gives us ways that can be confirmed in practice of waking the heart or, for those who already possess such ways — new or more complete ways of understanding this and putting it into practice.

What then are the sources of Mouravieff's knowledge, and what makes it possible to distinguish what in so much of his text is clearly knowledge of a high order from the opinions which, in obedience to his humanity, still do creep in here or there, particularly where he is concerned with ideas about his lost but still beloved Russia? This distinction between knowledge and opinion, so well expressed in Clement of Alexandria's *Stromaia*, one of Mouravieff's primary sources, was obviously important to him, so that he gives gentle clues both about the nature of the higher knowledge he conveys, and about the ways in which he did introduce new knowledge where needed, as well as the reasons why he did so. There are in fact several ways in which the accuracy of such a text can be verified, and surprisingly, Mouravieff's Gnosis stands up under all these methods of 'assay'. It fits the Orthodox '*docis*' or tradition as expressed by those who still possess the Royal Way described earlier. It evokes the confirmation of inspiration described in Plato's seventh letter. It predicts, in what appears at first to be mere theory, the actual events of the life in the study of *Gnosis*. It stands the test of *oipractice*, and in doing so it remains internally consistent. When it does introduce ideas from other traditions, such as the concept of *karma*> it does so in ways that, properly understood, remain consistent to

the overall statement of the doctrine with a degree of precision equal to that of the mature external sciences.

Those who can discriminate between different levels of knowledge will find in this book an almost inexhaustible treasury of knowledge that can lead to true spiritual transformation. But it is necessary first to work for this discrimination. Without it, not only will you be unable to differentiate between *gnosis* and its imitations, but even this book will not release its *gnosis* to you in trust.

Esotericism is just inner science

Boris Mouravieff's *Gnosis* is described on the cover of each volume as a 'study and commentaries on the Esoteric Tradition of Eastern Orthodoxy'. It is important to be clear what this means, as the idea of esotericism is often misunderstood. The clue can be found in the words of the Gospel of Saint John. *I am the vine, ye are the branches: he that abideth in me, and I in him, the same bringeth forth much fruit: for without me ye can do nothing.*

We have translated this 'without' as "*exterior*" because of the fact that in English the word 'without' has two meanings: it can in fact mean 'outside', or it can equally mean 'lacking'. The early British scholar Duns Scotus makes the point that the Greek word used here, which is normally translated 'without*', was '*choris*',³ which quite definitely means 'outside'. What this means is that in those times there was an inner knowledge, based on "*assenting to*" traditional knowledge⁴ — '*gnosis*' — which is then confirmed experimentally through techniques of inner observation, and a purely external kind of knowledge, gained through the ordinary senses. A Greek scholar in Boston confirmed this when he wrote recently that there is an external or exoteric Christianity and an internal or esoteric Christianity:

*The first kind of philosophy, external philosophy, comprises for them ancient Greek philosophy and the pagan philosophy of early Christian centuries. The second kind, "internal philosophy", is identical with the Christian religion. This term is used to denote Orthodox Christian teaching in its totality; lived Christian teaching in general; some interior practice, particularly inner attention and inner stillness, and the monastic life.*⁵

Over the years, this esotericism has formed a Tradition, a science or discipline of knowledge which may have existed before the time of Christ,

2. John xv: 5.

3. Duns Scotus Eriugena *Thi Vokioftkt E^j/e* — Tr. Christopher Bamford. Lindisfarne Press, Hudson, NY, 1990.

4. Cf. Pement of Alexandria, '*Strdmania*', Book VIII.

5. Constantine Cavaros — '*The Hillmic Christian Phiksopiifal Tradition*', Institute for Byzantine and Modern Greek Studies, Belmont, MA, 1989, p. 109.

but which has since been totally assimilated to the inner meaning of Christianity. Boris Mouravieff says in his own introduction to the present volume that: 'This Tradition, which in Antiquity was only revealed in the Mysteries under the seal of absolute secrecy, passed from Egypt to Judaea with Moses, and to Greece with Orpheus and Pythagoras. The preaching of the Apostles fused these two currents in the Empire of the East, from which the Tradition scattered at that time towards Russia.'

Time after time, people try to interpret the whole of this inner teaching in terms of external experience. But knowledge is in the meaning, not in the words, and all that happens then is that the esoteric knowledge is lost or distorted. This was why John Tauler, the German mystic, had to say about his teacher, Meister Eckhart, that: '*He spoke from the point of view of eternity, and you understood him from the point of view of time.*'

Time after time the esoteric Tradition is misunderstood in this way, and so it dies. Then, when the time is ripe, it must be either restored or rephrased. In the meantime the meaning is kept alive in communities or schools symbolized by the name 'ark', of which Noah's ark was one.

A clear sign that this inner knowledge has been understood in a merely outward way, and that its inner meaning has *been forgotten*, is the idea that the inner knowledge is 'secret knowledge*'. This misunderstanding comes from misreading the term 'inner' or its equivalents. This gives the impression that these ideas are the possession of an 'inner group', and will not be given to others. This misunderstanding of the term 'inner' is because the psychological context is not known or is not noticed, so that it is interpreted in an external, purely physical way. At the beginning of this volume certain effects of this 'exteriorization*' of esoteric ideas become very clear as the author writes of the crucifixion, and of the part played by the chosen people in this mystery. To understand this correctly, one has to remember the heading to the first part of this book, which describes it as a study of **man**. Forgetting this fact, it would be easy to question the purpose of this passage, or see it as merely a historical comment about things long past so that it were better left unsaid. To understand its value one has to see it as it applies to us now, today, and as it describes things which can happen within and between serious students of these things today. It is not concerned to comment on history but to learn the lessons of this history. And once one is clear about its objective, one can see it as true Gospel commentary, drawing from the sacred text a clear analogy for problems and events now in train and which urgently require study, a living parable for the way that today's 'chosen people', the modern students of esotericism, taking it in a purely outward way or clinging to the past, miss the living tradition in defending the dead.

For, said Jesus, we must *let the dead bury the dead*,

Other chapters in this book should be read in a similar way. They exist to tell us about ourselves, and not for any other reason,

In fact, the inner knowledge is freely available to all those who are willing to look into themselves and face the pain this brings.

The other factor is that the Tradition is one beyond even the bounds of Christendom, but within Christendom, as the Author makes clear, it takes very different form from that of other versions adapted to other places and times, so that without knowing how to separate local factors from universal elements it is often difficult to make valid comparisons.

EDITOR'S NOTES

The question of translation

The ideas in Boris Mouravieff's '*Gnosis*' are difficult to translate and already, within months of the publication of Volume I, two different schools of thought exist, both of them making valid points. There are those who, correctly filled with respect for the subtle use of language in the French original, believe that the translation should render this original virtually word for word. Others say (equally correctly) that the result of this will be unclear not only to the average reader but even to the above-average. Faced with the question of putting this work into print, what are we to do? The answer is to try to please all the people, but not perhaps all the time. First, we have laboured to produce the book in the clearest possible English: not the most modern nor the most literary, as we agree with Clement of Alexandria that style is not as important as content, and because we have had to use words in English which possess a precision that many neologisms lack.

But this is not enough. We can and do say that those who wish to get closer to the French should study the French. To make this possible we shall endeavour to provide copies of the French to those who wish, and have even acted to encourage a reprinting of the French edition during the present year (1992). We should also comment that in certain cases the French original intentionally incorporates what appear to be grammatical errors, for example the use of an improper tense, and it has gradually become clear that these apparent errors actually convey additional information. In these cases we have endeavoured to follow the same special structure in English, but at the same time we must apologize because we have almost certainly not identified every complex hint by which this masterly author has conveyed additional information, so that some of them will not have come across into the English edition.

In the meantime we enclose notes on how certain of these words have been treated in the existing text. We should also mention a slight change in conventions from the First English Edition of Volume I, specifically:

Parentheses: A slightly different convention for the use of textual notes is used in Volume II from that in the First Edition of Volume I. In this present volume, a note printed in *italics* within parentheses is the French word which has been translated into the English word immediately to its left. A word or words in roman type within parentheses, on the other hand, is an addition by the editor or translators made to improve the clarity of the English text but not clearly present or implied in the French. Very

occasionally, we will include in parentheses a literal rendering of a phrase, in which case it will be headed '(lit: ...)'■

Words in question

The French word will be printed in *bold italics*, the preferred English meaning immediately after it in *italics*.

actuel—*present* or *current*. This generally refers to time, and is commonly used in this text to refer to the present or to something as current.

Advent—used for Christ's coming and 'second advent'. From the Latin to 'come to'.

Ame — *soul*: with capital A, often translated 'Immortal Soul',

time—*soul*: without the capital, 'soul' as equivalent to psyche or Personality.

amour courtois — *courtly love*: definition of undemanding love in the context of the age of chivalry, of the knight and the *dame de sa penset*.

fa hue — *inner peace*,

cas typique—*stereotype*: prototype or case-type in the science of types, see Chapter 16. Varying usage makes it difficult to translate this consistently.

centres psychique — *centres of the psyche*. See also *psychique*.

ckaleut—*warmth*: In a physical context this is correctly translated 'heat', but in the emotional context it equates to the English use in 'warmth of heart'.

comprendre—*to understand* and derivatives describing 'understanding' etc.

conception — *conception* — used here with implications of imagination or self-originated concept. See idea of 'Sin As An Error Of Conception', in the Appendix to Volume I.

conflit — *conflict* — but see also *tiraillement*.

Connaissance — *Knowledge*: from French roots 'co-naitre' which together imply knowledge born within us, knowledge arising within us in response to *savoir*, as a union between inner and outer elements, as in Plato. With the capital C it is higher Knowledge in its final stages.

constatation and related words — *constate*, *constatation*: observation of a specific kind, without judgment, with attention, and specifically clear seeing. Inner sight: to see directly with the eye of the mind, to confirm for oneself, to verify evidence. These English forms are uncommon but do exist.

dame de sa pensee — *Lady of his dreams*. In English usage this is more familiar than the literal 'Lady of his thoughts'.

donnee—*data, facts*: sometimes the latter translation as necessitated by the context and the need for clarity.

echee—*check*: a halt, a stoppage, a check: 'check' normally fits the different usages best.

echelon—*level*: *rung*, a level that is static, already there, step of a stair, rank in a hierarchy, a note on a scale (*e'chelle*).

enseignement — *teaching/education*: Vol. 2 introduction — at first translated as teaching but afterwards as 'education', in keeping with usage in the English speaking world.

equilibree and derivatives — *balance, balanced*.

escaHer — *staircase*: to Mouravieff, specifically the intervening stage between the first Threshold and the Way (which begins at the second Threshold).

esprit—*mind/spirit*: sometimes rendered mind, sometimes spirit, depending on context.

etre sur le qui-vive — *to be watchful*: equivalent of the Greek *nepsis*.

fidele—*faithful*: an ancient Traditional term for one who has Faith and so is between the first and second thresholds. Opposite of 'infidel'.

foi — *faith*: faith is blind; says Mouravieff, since it is as certain of the invisible as of the visible.¹

gamme — *gamut*: old term for a musical scale.

Gnosis—*Gnosis*: higher Knowledge that reconnects man to God.

homme exterieur—*exterior man*: 'those without' of the Gospels. The term exterior man was established in Vol. I.

integral — *complete*: integral in the sense of mathematical integration or chemical compound as distinguished from a mixture, in Vol. I translated as integral, in Vol. II normally translated according to context as complete, whole, total etc. but occasionally used in its mathematical sense where this is obviously significant.

'*monde*' — '*world*': when in quotation marks, the inner activities or content of impressions reflecting the external world of 'A' influences. According to Mouravieff, a Traditional Orthodox term.

moyens — *means*: normally translated 'means' but sometime implied in a wider sense than is normal in English, although this can be made clear by context.

niveau — *level*: always translated 'level*': *niveaux* — *levels*.

octave — *octave*: simply translated.

L Cf. Gnosis Voi. II, chapter 19.

plan—plant: must sometimes be rendered 'level', sometimes translated 'plan', as French usage makes clear the forgotten English link: a plan is a representation of something on a particular plane.

psychique—of the psyche, wherever possible, which is not always, otherwise as translated in Vol. I, 'mental' with a footnote, or 'psychological', to avoid the recurrent association of 'psychic*' with what Mouravieff called 'mystical phenomenalism*.

savoir — knowledge: (with a small k), information as knowledge that is outside ourselves and can be communicated unchanged in its existing form. 'Objective knowledge' in the form defined by philosopher of science Karl Popper, in which it can exist as read or unread text.

savoir-faire — savoir-faire: knowing how to do something.

soudure—fusion—lir: soldering, welding or fusion—we prefer the latter as soldering and welding are less appropriate in terms of the form taken by the process.

station de transmission—transmitter station: used to describe the function of organic life as a means of transforming and re-radiating cosmic energies.

tare—tare: karmic burden, the use of karmic tare would be clearer to more people if replaced by 'burden'... but 'tare' was used in the original to link it to the parable of the tares.

technique—techniques|technology: clearly used in broader context than English equivalents, so sometimes translated 'technology' and sometimes techniques or even methods.

tiraillement — conflict of intention: used in Chapter 20 of a specific type of inner conflict—the pull between the real ¥ and the *T* of the body. Has probable implications of pain or discomfort.

vigilance — watchfulness.

Vote-Way.

Following the publication of Volume I of Gnosis, a correspondence began between the author and the readers, partly direct and partly through the Centre for Christian Esoteric Studies.

From this correspondence emerged a certain number of questions of general interest. In categorizing these questions in groups he endeavoured to answer them in the following introduction to the present volume, the second of the series.

Geneva, 24th June 1962

1. Closed some time after the death of its founder, the Author of this book.

AUTHOR'S INTRODUCTION

W

The first volume of *Gnosis* is dedicated to the exoteric cycle of the traditional teaching. The present volume deals with the mesoteric cycle. The third will consider the esoteric cycle in the full sense of this term.

In *systematic* teaching of the tradition, each of these cycles has a task analogous to that of one of the three main stages of public education. Thus:

1. The exoteric cycle corresponds to the *elementary* esoteric teaching. As such, it seeks to provide the student with *basic information* he needs for his work. It is in a sense the ABC of the Doctrine;
2. The mesoteric cycle, like secondary education, seeks to communicate the elements of a *general culture* to the student, and to teach him a method;
3. The esoteric cycle corresponds to higher or university education.

(2)

It should be noted that in all *serious* esoteric teaching, as in ordinary education, elementary education is naturally almost uniform, The secondary teaching of the tradition, as in its secular equivalent, offers the opportunity of a first specialization: classical or modern in the everyday world, *monastic* or *lay* in the esoteric field. Higher education is specialized in both cases.

(V

It is generally accepted that nobody can go on to secondary school without having completed an elementary education, nor begin at university without having assimilated the content of a secondary education. These graduations automatically select those able to become active members of the cultural elite of human society. Exactly the same is true in the esoteric sphere, at least in theory. But in practice we often run into a curious phenomenon. For example we would not seek to discuss Newton's binomial theorem without having studied algebra, for without this every opinion we expressed on the subject would be worthless, yet in the esoteric field we are too often inclined to judge without previously learn-^mg even the rudiments of this kind of knowledge.

In the same vein, we often demand *simplicity* from esoteric teaching on the generally accepted principle that Truth itself must be simple. We conclude from this that access to this Truth should also be simple, and so the method which leads to it must be easily assimilable. This argument is perfectly correct on condition that we ourselves are *simple*^ that is, *just*, in the sense used in the Gospel. Sadly, this is not so, because of the anarchy that reigns among our 987 little *I*'s. There is along path to travel from our distorted state of inner disorder to our original simplicity. This is the *Way* that leads the seeker from the *wilderness* of ignorance to the Light of Tabor.

Experience shows that in practice this doctrine of 'simplicity', if it is regarded as an axiom, turns the student aside from the strait gate and the narrow way that leads to Life.¹ Impelled by this counter-truth, he believes he stands before this door, when he is in reality—although undoubtedly in perfectly good faith—walking on the wide path that leads to perdition²: *ad majorem Diaboli gkriam*, of course.

This *doctrine of simplicity*, correct in itself but wrongly interpreted, becomes a snare for our hearts that are already too corrupt; a danger which should be recognized and avoided.

W

We have already said the first volume of *Gnosis* forms a manual of the elementary esoteric teaching according to the Tradition of Oriental Orthodoxy. That it is in fact no more than the ABC of this *Knowledge*. Yet it has sometimes been alleged that *Gnosis* was a difficult book to read. Although the text does not employ special terminology, this comment is in some sense well founded. The fact is that its subject matter is not simple, and we cannot logically expect to learn a difficult subject without taking pains. Other correspondents have commented on the clarity of the text, This apparent contradiction is explained by the fact :hat the book is addressed to a necessarily limited public; to readers who are predisposed to esoteric culture by their nature, formation⁴ or personal experience. However, the spread of *Gnosis* has greatly exceeded expectations. The elite among whom this work has found a response has proved to be quite large.

1. Matthew vii: 13-14; Luke xiiii: 24.

2. Matthew vii: 13.

3. In fact, this demand for simplicity is typical of the present era, where teachers are valued according to their television presentation and their ability to explain. The effect of our seeking explications that are 'immediately clear' is that this limits our knowledge to that which can be put in ways that we regard as dear which, in actual fact, limits us to knowledge that lies within the boundaries of what we already know. To seek immediate clarity is to turn away from knowledge that is really new to us. ^Ed.)

4. e.g. Their 'formative years'. (Ed.)

The present *Introduction* is addressed in particular to correspondents who have raised problems of a general nature, more particularly questions •which concern our *Aim* and our *vork*. These two points are intimately linked and form two sides of a single question.

A very ancient maxim quoted in Saint Luke's Gospel places the problem in its proper context. He writes: '*the labourer is worthy of his hire*'.⁵ This maxim is given in the context of sending the seventy disciples 'as lambs among wolves'⁶ to announce to the people that 'The kingdom of God is come nigh unto you'.⁷

This means that in the esoteric field, as in everyday life, man earns a salary for the service he provides. Nevertheless, *exterior* life, that of *A' influences, makes it possible for man to acquire wealth without working; for example by speculation, by all sorts of unpunishable abuses, and by other means that are more or less fraudulent but do not exceed the limits fixed by human law. The *General Law* leaves a fairly wide margin of tolerance to humans working in the domain of 'A' influences. Of them it is said that '*the children of this world in their generation are wiser than the children of light*' We must not forget that Jesus said this at the conclusion of His well known parable about the *mjusi steward*. On the other hand, in the esoteric field we can gain nothing *pure* or *true* and thus nothing *beautiful* without making efforts whose sum and importance are equivalent to the result to which the worker aspires. Conversely, the value of the results we obtain for ourselves is always equivalent, quantitatively and qualitatively, to the measure of the services rendered on the esoteric level.

We emphasize: *pure* and *true* and *thus permanent*. It is possible to obtain so-called esoteric results that are *impure*, but they are *false* and thus *transitory*.

Here we refer to the vast realm of occultism, where the children of this century, more capable than the children of light, seek to apply their abilities beyond the visible world. This occurs in what we call '*mysticism of phenomena*'. We shall return to this later.

W

So if the seeker starts with a negative approach and a feeling of inferiority and dissatisfaction—approaching the esoteric domain driven by the desire to find in it *personal* and thus *impure* satisfaction for himself, he will not be able to advance very far along this way. If he persists, he will

5. Luke x: 7; Matthew x: 10.

6. Luke x: 3.

7. Luke x: 9.

8- Luke xvi: 8. (from the Slavonic text)

meet with failure. The error of conception made at the start will imperceptibly lead him towards this 'mysticism of phenomena.' In its active form this has already been mentioned in the first volume of this book.⁹

As for the true satisfaction, the *reward* spoken of in the gospels, the student will find this only by serving an esoteric cause.

The attentive reader will draw a practical conclusion from the above: one must find a genuine esoteric task being carried out in the world, make oneself useful in that work, and take an active part in it.

That is the meaning of the parable of the reapers, where it is said:

*'He that reapeth receiveth wages, and gathereth fruit unto life eternal: that both he that soweth and he that reapeth may rejoice together. I sent you to reap that whereon you bestowed no labour: other men laboured, and ye are entered into their labours.'*¹⁰

(*)

In chapter V of this volume we will give a general view of the historical evolution of adamic humanity from the esoteric point of view.

Organic life on Earth, with adamic man at its head, evolves under the aegis of the Absolute II, Christ, the Son of God, who acts among us through those humans capable of being useful, that is, those who are able to take an active part in this work.

It is by distinguishing between 'A' and 'B' influences that the seeker can make contact with one or more people who are 'reaping'. Then, *if he really understands what this is about*, he can try to play a part in their work. The express condition for this —and we have insisted on this many times, but will repeat it once more—is that he can be *useful*. In esoteric matters there is neither nepotism nor exaggerated tolerance. Even less are there charitable institutions. These are attitudes which do not extend outside the 'A' influences. In esotericism even more than elsewhere — and this is understandable — man is worth what he is worth. He is employed according to need, and paid for his efforts.

If he can already be useful in his ordinary state, he is made to pass through an esoteric apprenticeship. He will then advance according to the measure of his 'talents', in other words his innate predispositions, and by the conscious efforts that he makes. Devotion and faithfulness count for more than anything else. Jesus said: 'No man, having put his hand to the plough, and looking back, is fit for the kingdom of God.'¹¹

The kiss of Judas Iscariot, the intellectual among the Twelve, must remain in the seeker's mind since the components of this mentality are

9. *Giusti* Volume I, pp. 51, 52.

10. John iv: 36-38

11. Luke ix: 62.

peculiar in various degrees to every incomplete Personality. To take an active part in esoteric work —in our epoch even more than two thousand years ago —man must be reliable (*sur*). We should be able to rely on him whatever happens. Otherwise, under certain circumstances, he risks following in Judas' footsteps.

He must have no illusion: to betray Jesus is to betray His work, whose object is the salvation of mankind. By betraying Christ's work, above all we betray ourselves.

This happens infallibly to seekers who, after crossing the first Threshold, approach esoteric work while continuing to deify their Personality.

II

(V)

Let us now examine the case of what the Gospel calls *ravenswolves*. Jesus said:

'Beware of false prophets which come to you in sheep's clothing, but inwardly they are ravening wolves.'

And He adds:

*'Ye shall know them by their fruits.'*¹²

It is difficult, if not impossible, for an esoterically unevolved person to discern false prophets spontaneously.¹³ He will recognize them more easily by their 'fruits', by the observable results of their works, which serve as *signs (indices)*. The Tradition knows and teaches a whole *Science of signs*.

Jesus says:

*'It is impossible but that scandals will come: but woe unto him through whom they come! It were better for him that a millstone were hanged about his neck, and he cast into the sea ...'*¹⁴

For the time being let us not try to understand the reasons why, as Jesus said, it is impossible that there should not be scandals in the world. We should take this text as a warning, and never forget that it has a twofold significance, as the Lord concluded: *'take heed to yourselves'*

This warning is disturbing. But its value is real, A thief can carry off our wealth; a 'ravening wolf' can deprive us of salvation.

That 'ravening wolves' appear in sheep's clothing we shall learn from the following text, well phrased to frighten us:

12. Matthew vii: 15-16. Cf. *ibid.* fig. 21, vol. I.

13. Matthew vii: 15.

14. Luke xvii: 1.

15. Luke xvii: 3.

'It is not every one that saith unto me: Lord, Lord, who shall enter into the kingdom of heaven, but he that accomplishes the will of my Father which is in Heaven. 'Many will say to me in that day, Lord, Lord, have we not prophesied in thy name? and in thy name have cast out devils? and in thy name done many wonderful works? 'And then I shall declare unto them, I never knew you: depart from Me, ye who work iniquity'*

The conclusion is that neither prophecies that are fulfilled nor the occurrence of miracles give us any surety against 'ravens wolves'. It is important to know this, since the information given is so precise.

Jesus says that the end will come when the Gospel will be preached throughout the world.¹⁷ Today this is an accomplished fact. And in this time — in our times:

'There shall arise false Christs, and false prophets, and shall show great signs and wonders; insomuch that, if it were possible, they shall deceive the very elect.'^{18*}

(2)

In the present volume we shall speak at length of our era, straddled between the Cycle of the Son and that of the Holy Spirit. We will call it the *Time of transition*.

We are in the heart of this period, which is relatively short — perhaps a century. It began with the first Hague conference and the Russo-Japanese war — followed by the first Russian revolution and the first world war, which saw the collapse of the old political and social equilibrium of the planet, and parallel to this the vertiginous progress of technology.

Yet it is impossible to measure the exact duration of this time. It is said: *'But of that day and hour knoweth no man, no, not the angels of heaven, neither the Son, but the Father only.'*¹⁹ With this reservation; we can assert that the Time of transition will probably not last beyond the end of this century. All the *signs* show that the necessary conditions for the *End* are emerging before our very eyes.

This time brings with it a great preparatory task for the transition to the approaching third Cycle, that of the Holy Spirit. This task has already been partially accomplished in relation to the outer conditions of *organic life on Earth* as a whole, particularly those conditions which affect: the material conditions of human life.

In this realm, however, we are obviously approaching a limit in this sense, that the progress of *means* tends to destroy established ways of

16. Matthew vij: 21-23 (from the Slavonic text)

17. Matthew xxiv: 14.

18. Matthew xxiv: 24.

19. Matthew xiv: 36; Mark iii: 32.

life which nevertheless remain unchanged or, more often, lag behind with a dangerous delay.

The progress of technology frees man at an accelerated pace from his servitude to work, imposed upon him since the *Fall* by the necessity of *'gaining one's bread by the sweat of his brow.'*²⁰ This constituted a sort of 'safety valve', more or less smothering the bestial instincts of man by the fatigue of the day's work.

(V)

As the material conditions for the new era will soon be fulfilled, it is now necessary to establish suitable conditions on the moral plane. But we generally do not conceive what these conditions might be. Here as elsewhere, the *new* always remains *unknown* and so in some way is *inconceivable*. On this plane today, as long ago, man walks blindfold unless he is enlightened — as in the past — by Revelations transmitted orally by *true* Prophets.

Yet as in former times, the inertia of human thought and man's old-established habit of giving a fixed scale of values the force of a categorical imperative still render the task of the Prophet hard, thankless and dangerous.

Comfort, the prevailing word for *Progress* in its many different aspects and to varying degrees, forms a sufficient *aim* for the majority of civilized men of our era. Under these conditions of our times, man is only open to divine values in carefully measured doses, kept within limits so that they do not trouble his bourgeois or socio-communist conscience or threaten the material well-being he has acquired.

The danger of such an attitude is that it is *natural*, and so it is supported by an elemental force. The law is explicit: *'No man also having drunk old wine straightway desireth new: for he saith, the old is better.'*

(V)

As indicated above, on the moral plane the preparatory task fundamental to the Time of transition can and must be accomplished, under the aegis of the Absolute II, *for human beings and by human beings*.

20. Genesis iii: 19.

21. Luke v: 39.

III

IV

This is therefore a question of the New Man, a subject discussed at length in the first volume of *Gnosis* and elsewhere.

In practice, this problem can be reduced to the need to form a new elite, called on to replace the intellectuals who have formed our elite since the Renaissance, just as these replaced the feudal aristocracy who ruled at the end of the Middle Ages.

This postulate leads us directly to the question of the aim of the esoteric work now being carried out in the world, the question posed at the beginning of this *Introduction*.

At the beginning of 1962, in a message in the *Information Bulletin of the Centre*, the author reminded us that he had divulged the traditional Doctrine in depth in the three volumes of *Gnosis*—as well as creating the *Centre*—with a precise aim: to contribute to the formation of the *New Man*. In the time of transition between our civilization which has now reached its end and the new era into which humanity is now moving in its historical evolution, success depends on the emergence in the near future of a sufficient number of people belonging to this new human type.

This message also reminded us that the youth of our time needs more attention. It is from their ranks—and those of the following generations — that the torch-bearers who have an innate predisposition for esoteric work will emerge. This is provided that, in addition to a highly advanced professional training, these predispositions are properly developed by esoteric teaching taken even further than the most advanced professional training. These men will then be called on to form the active elements of a new elite.

Vigilance, added this text, is also necessary to avoid misunderstanding by those around them, and sometimes even by parents.²³ To give esoteric help to these young brothers and sisters is a task as noble as it is delicate. The author calls on his readers to take this essential problem to heart.

He added that particular attention was to be paid to young girls as well as young women. Even if the *Fall* was provoked by Eve, we must not forget that it was by the Virgin Mary that our Lord came into the world to show humanity the Way to Salvation, And today it is Woman, the daughter of Eve who, because of her refined sensibility, must play the inspirational role in this difficult time of transition leading to the promised era of Redemption.

22. Boris Mouravieff, *Le Protime et l'Homme Nomade* in *Syntaxis* review nos, 126-127,

23. Cf. Matthew x: 36.

To fix these ideas in our minds better, let us recapitulate what was said earlier.

- 1) The final aim that man can hope to achieve by esoteric work is to attain the second Birth and so overcome Death. This aim is explicitly defined in the Scriptures and has been abundantly commented on in the Tradition and the Doctrine. This is Salvation.
- 2) With rare exceptions, this aim can only be attained by the student through hard and methodical work. The sum of the conscious efforts required is proportional to the degeneracy of the Personality. It is generally great, much greater than that required for example from the student from the time when he starts his elementary education until he obtains his doctorate by successfully sustaining a thesis.
- 3) The particular character of these efforts—as we have seen in the first volume and will perceive even more clearly here — is that all the work done by the student on himself must be characterized by (Lit: *placed under the sign of*) waking the emotional functions that are generally deeply asleep, especially in cultured people of our time. This awakening, this flame, is the express condition and the point of departure leading to success: *to advance, one must burn*. A fire that smoulders under the ashes is not enough,

A special method is provided to allow students to rekindle an inadequate fire and to fan it when it is fading.

- 4) This work on oneself, although its aim is the evolution of the individual, cannot be accomplished in a vacuum, that is, in isolation. The law is clear: the desired result cannot be gained in practice except in the form of *wages* according to the stated principle that: *'the labourer is worthy of his hire.'*

Another way of saying this is that the accumulation of esoteric values cannot be realized by ways used in the everyday world; by egoistical means. All true esoteric work is oriented in a direction diametrically opposite to egoism.

- 5) Thus the student must not let himself be deluded by the mirages which await him on the track (*stintier*), but must arm himself with a strong faith and a firm courage which will allow him to find a *practical* means of entering some Esoteric work which is being carried out in the world,

6) For this, *desire* in the loins *2nd fire* in the heart are not yet enough. If it remains without any *specific practical esoteric* application, the force of this tension that has been kindled will dissipate in smoke. Every force demands a definite point of application, and without this it will decompose and disperse. Before this force can be *applied*, the student who seeks esoteric work must also *be useful*. His task begins with this, that is, when he moves on from words and aspirations to actions. To the degree that he completes this work, his 'salary' will automatically increase.

7) *The seeker is free to choose*. The discipline is accepted voluntarily, but it is of iron. The student can abandon the work at any moment to return to worldly interests. However, he will remain 'intoxicated', since participation in esoteric work will progressively open his eyes, make the colours of *exterior* life fade for him, and shake his old scale of values. The freedom of choice and the initiative demanded of the seeker bring a danger: that of taking the false for the true; the impure for the pure, allowing himself to become subject to the scandal of 'powers' etc. When such mistakes are committed by a pure and ardent heart as the result of a sincere error, they do not in themselves hold mortal danger. He will be warned in time even if he persists in his error. The case of Saint Paul's conversion on the road to Damascus gives us a convincing example.

The real danger, which can lead to *mortal sin*, to a definite check, occurs when an impure heart seeks to be served by higher psychic" forces for its own egoistic ends. This is a quagmire.

(2)

This last point requires comment.

A curious phenomenon often occurs in the human mind when it considers the generally hermetized theories and facts of the esoteric realm, We have already mentioned this, but it is worthwhile to return to it once again from a slightly different viewpoint because the question is so important.

In positive science, pure, moral or applied, it is generally accepted that we must be well versed in a subject before we can give a valid opinion, To speak seriously, one must speak of what one *knows*, which presupposes previous studies,

It is entirely different in the esoteric domain. Here we believe ourselves competent without even completing an elementary education. We *judge* before we have developed in ourselves the correct instrument with which

24. In the occult sense (Ed.),

to judge. Yet we know that like can only be conceived, understood and judged by something similar or higher. Without this, all judgements, discussions and advice about esoteric facts remain comparable to evaluations and opinions about the shade of a colour by someone born blind.

Just as the world we live in is closed off, *invisible* to the foetus in its mother's womb until the awakening of its birth, even so the higher planes of Life, the *astral* and *spiritual*, are similarly closed and *invisible* to us until the second Birth. Until then, man can only form hypotheses or refer to the testimony of authors who have themselves been twice born. As forpassing *validjudgements* of these facts, authors, and people, he will not be able to do this until he has himself crossed the second Threshold. Then, having become spiritual in the meaning given by Saint Paul — and only then — *'man ...judges all, and himself is judged by nobody.'*²⁵ Then the Apostle in explanation says: *'But we have the mind {intelligence, Gr.: nous} of Christ'*²⁶

In effect, by identifying with his real T, the monad of Christ, the *Individuality* enters a direct relation with His intelligence, just as Saint Paul said.

(V

That seems quite clear. Nevertheless, the curious phenomenon already mentioned is commonplace these days, and even people of perfectly good faith — not to mention others — persist in their attitude.

This phenomenon is due to two principle causes. One is the general tendency of humans to claim qualities which in the *exterior* man exist only in potential; and the other, a consequence of this, is the subconscious deification of the Personality, regarded as if it were omnipotent in every realm.

Humility is necessary for *true* esoteric work, but its lack is further aggravated in many people who possess, at least in theory, the possibility of penetrating into the supersensory realm.

We are not speaking here of people of bad faith; this subject has been amply treated in the first volume of this work.²⁷ We shall only examine the case of sincere people who stray—*because this is of interest to the Work*. Their case is precisely that of *the sick in need of a physician*^ small *Sauls* who could be converted to small *Pauls*, to become useful labourers and earn their reward, but who wander in their search beyond the place where they could receive this *compensation* for work done.

25.1 Corinthians ii: 15. (Ed. Normally rendered: *'butbat it spiritualjudgtih all ikings,ytt be himstif is judged of no man.'*)

26- I Corinthians ii: 16.

27- Volume I chapter VI, p. 50.

28, Matthew ix: 12; Mark ii: 17; Luke v: 31.

The *Philokalia* recommends seekers to *put God in their debt*. Then those who stray in perfectly good faith — that was the case of die *Galatians deprived of their senses* — can draw on divine *credit* without being concerned with the need for repayment. The result is known.

The mind of our civilization is hungry for phenomena, and this is the principal cause of this straying. Creator of marvels of technical progress, this mind — when it does apply itself to supersensory facts and ideas — applies itself instinctively, */w/ as it is*.

But the supersensible world is not one indivisible unit like the material world. On the contrary, we can distinguish there many different *planes* and *heavens*. Saint Paul the apostle brings us testimony of a man who was transported (*ravi*) to the *third heaven*. Mohammed said that, mounted on his mystical horse *Bouraq*, he visited the heavens and conversed with Moses and Jesus. Other testimonies are known.

Let us not forget that every *Cosmos* is full of life. If we follow *the lateral octave* parallel to the *Great Octave*, we will discover two higher planes above our own plane of *organic life* on our planet. Going from the lower to the higher, we find the lateral SI which corresponds to the FA of the *Great Octave* and to the *Mesocosmos*; then the lateral DO that corresponds to the SOL of the *Great Octave*, to the *Deuterocosmos*, that of the Absolute II, of Christ.

For terrestrial man this is the highest possible level, the *spiritual* plane, Saint Paul's third heaven, while the intermediate plane is the plane of the *psyche*.

This ensemble, shown in the diagram, forms a triangle containing six factors; five notes, and the interval between DO and SI filled by the will of the Absolute II, which is Love.

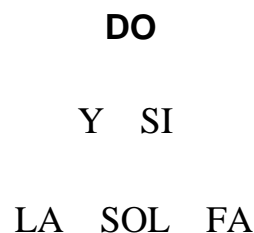

FIG. 1

29. Galatians iii: 1.

30. II Corinthians xJi: 2.

31. Koran, the Sun *Nocturnal voyage*, 111 *vcrses.no.* 17, tr. Edouard Montet, Paris, Payot, 1954, p. 385.

Seen from above, the intermediate level includes elements which ensure the appearance, then the existence of the psyche, and the psycho-physical existence of *organic life on Earth*. (The appearance and the physical and psycho-physical existence come from elsewhere, and we shall return to this later). This level is filled by the will of the Absolute II, and it includes the *atmosphere* in the broadest sense of the term: the *Mesocosmos*. This realm contains several psychic planes, going from the coarsest (in SI) to the finest (in +).

In esoteric work the phenomenalist mentality seeks *facts*. (It looks) for *manifestations* that confirm that its work is well founded, or which simply satisfy its curiosity. This is where the above-mentioned scandals and the greatest dangers lie. For it is often possible to obtain the desired 'facts' quite easily from the domain of SI, to which the human Personality also belongs. When it is solidly anchored in the physical body it is generally incapable of making direct connection with this level. However certain persons, known as *sensitives*, have the innate or acquired faculty of momentarily weakening the ties of the Personality to the physical body so that, with no esoteric evolution whatever, they are able to connect with this level — with the *coarsest* layers of SI.

"Facts" obtained in this way are often regarded by people who seek them as coming from the spiritual level, or at least from the fine layers of level \f which express the will of the Absolute II, because this is in direct contact with Him and is filled by His Love. The realm of \f is that of Individualities, Saints and entities of that order, charged with missions on different levels. By contrast, the realm of level SI is a vast reservoir of psychic (*psjehique*) entities that have no contact with the higher plane, including amongst them disincarnate Personalities, who normally remain there to await their second Death³²—the negative equivalent of the second Birth. This usually occurs on the fortieth day after death of the physical body.

Orthodox Tradition expressly warns seekers against contacts with this realm which is so dangerous and full of the worst illusions. In monastic esoteric practice, special prayers are said toward off influences of this kind, particularly those visions that so often result from researches into certain teachings, even if well intentioned. These prayers are meant to avoid a fall into a mystical trap which manifests in the following way.

It often happens that entities belonging to the SI domain seek contact with humans — more particularly with those who wish to establish a contact with the beyond. The aim of these entities is to interfere in terrestrial life; to draw on vitality and so gratify unsatisfied desires that they have carried beyond their physical life.

32. Revelation me 6.

33. John iii: 8.

34. Cf. I Corinthians vii: 28.

The power of intervention of these entities is a function of the credulity they meet. The Orthodox Tradition classifies them in the category of little devils or imps (*diablotins*). The yearning to experience 'miracles', 'visions' etc., creates an atmosphere favourable for their appearance, which can assume various forms, sometimes perceptible to the senses. To give themselves importance, these apparitions take the names of illustrious men as well as those of Saints and Archangels; they even go so far as to borrow the names and even the appearance of the Virgin Mary or of Christ Himself. The *Philokalia* and the *Doctrine* contain many descriptions of this kind of case.

Through the *Science of Signs (indices)*, the Tradition teaches a method which allows us to discern this category of psychic phenomena that are too often taken for facts that genuinely come from higher levels,

For this purpose it is appropriate to stress that in the materialist (*phenomenalist*) mind of the cultured man of our era, the true and the false in esoteric research easily become mixed together. This confusion is generally increased by the environment in which man is placed, the *Mixtus Orbis*. This entanglement shows above all in the domain of our affections, which are generally unbalanced in us because the habit of flying has become our true second nature. The innate faculty of immediate discernment of the true from the false is thus lost, and man, even the most cultured and learned, becomes singularly credulous, particularly in the 'mystical* realm. This imbalance affects us according to a law: *credulity is inversely proportional to faith*. In other words, the weaker is our true faith and thus our pure emotions, the more our credulity grows, often taking grotesque forms.

In this mechanism we can perceive the familiar action of the *General Law: to inspire the man who seeks the Way with the idea that he is already on the way*. This is the best and the most common means used by the DeW/to turn away the seeker who has had insufficient warning'from the narrow way which leads to Life.

Jesus, the Master of the esoteric Tradition, said:

*'How can ye believe which receive glory from one another, and seek not the glory that cometh from God only?'*³⁵

When we accept the 'glory of men' yet still believe that we are on or walking on the *Way*, we fall directly under the law of Equilibrium. Jesus alluded to this when he quoted the Pharisees who prayed in the streets, saying that *'they have already received their reward.'*³⁶

35. John v; 44

36. Cf. Matthew vi: 2.

(*)

The ideas expressed in this *Introduction* have been grouped together to answer various questions from readers of the first volume of *Gnosis*.

In conclusion we would like to draw their attention to the unique value of their Personality, a value which is inestimable in spite of all its faults and weaknesses, even when it appears to be poor, miserable, and sometimes grotesque,

It must be well understood that the human Personality, in the unfinished state in which we find it, forms our only *instrument* for esoteric work. Better still, it is a gift; it is the *talent* the Master has given us so that we may make it bear fruit.

Woe to the servant who buries it in the earth of his body! *'cast ye the unprofitable servant into outer darkness: there shall be weeping and gnashing of teeth.'*³⁷ And here this is no metaphor.

We must therefore work with love—and with all our strength—since we do not know at what hour the Master will come and demand a reckoning.

37. Cf. Matthew xxv: 30.

GNOSIS

Volume Two

FIRST PART

MAN

CHAPTER ONE

(V)

In the first volume we endeavoured to give the reader who thirsts for knowledge a working method that would allow him to start the search for the *Way* which leads to Truth, and from there to Life. The elements of knowledge (*savoir*) found there form, in effect, the tools with which man can work on himself.

Our studies will continue in the same framework: *Man, the Universe, and the Way*, and will have the same aim: to help the persevering seeker continue his evolution until he finally reaches the point where he can overcome Death. But while our studies in the first volume centred on man as an isolated entity, we will now consider him in the larger context of *organic life* on Earth, whose evolution ensures the development of our *Ray of Creation*.

This method will allow us to organize our studies in the framework of a natural scientific order in which *the syllabus corresponds to the structure of the object studied*.

(2)

Let us now examine and try to understand the general meaning of the evolution of *organic life*, considering it in its ensemble as an organ of our planet. At the same time we will try to determine man's place in this organ, and the mission with which he has been charged.

Organic life on Earth was conceived and has appeared in particular cosmic conditions. Modern science gives us a general view of its *growth and development*,

We will remember that the notes LA, SOL, FA of the *lateral octave* correspond to the whole of *organic life*, and that each of them represents one of the three elements: man; fauna; and flora. Together they form a *transmitter station* for cosmic energies filling the interval between FA and MI of the *Great Octave* and so playing a part in the normal development of our *Ray of Creation*.

The reader has grasped the importance of distinguishing between the notions of growth and development. The moment has come to give a precise definition to these two terms.

In the most general sense, the process of creation follows a descending gamut: in it we must distinguish three consecutive stages:

- All creation is conceived in the note DO. It receives its first impulse from the will and power of the Creator, which fills the interval between DO and SI: thus It is born.
- The process of growth begins at this moment. It normally passes through four consecutive stages following the notes SI, LA, SOL and FA. Growth ends in the note FA.
- Creation then faces the following alternative: either it must develop through the notes MI and RE, or it will degenerate. Its fate therefore depends on the possibility of filling the second interval between FA and ML. Once this interval is passed, development continues through two further stages in the notes MI and RE. The success of this work appears in the note DO of the following octave.

The notions of growth and development are often confused. Although they are distinguished in some disciplines of biology, for example, the dividing line is not always clearly defined. What was just mentioned will allow the reader to rethink the examples given in the first volume, beginning from Creation down to the general diagram of *The Way*. In this last case he will better grasp the difference in nature which exist; between the two parts of *The Way*: the *Staircase*, which corresponds to the notion of growth, and the *Way proper*, which symbolizes development.

We must still describe in general terms the nature and significance of the force that fills the interval between notes FA and MI. We have seen that this force is born from a *lateral octave* which arises from the note SOL of the first octave, and that the joint effort of the three notes LA, SOL and FA fills the interval.

If we return to the definition given above, we can now say that *growth of the lateral octave* makes possible the *development* of creation according to the *principal Octave*.

This law applies to *every* form of Creation, from the *Great cosmic Octave* to the most rudimentary beginnings of human activity. Properly understood, it includes the neophyte's journey from the *first Threshold* to the end of the *Way*.

We will now return to *organic life on Earth*. It is through the growth of this organ that the development of our *Kay of Creation*, an element of the *Great cosmic Octave*, can and must be completed. But what stage has the

growth of *organic life on Earth* reached today, and what prospects does it offer for the development of our *Kay of Creation*?

The body of information provided by natural history and anthropology allows us to follow the evolution of the growth of *organic life* from very early times. If we do not know how it began, we can at least represent to ourselves the stages in the growth of the different components of *organic life*. As with all growth, this has two aspects: qualitative and quantitative.

We have seen that the life-giving (*vivifiant*) effect of the energy from the Absolute I is the result of the flow and counterflow of waves diffused along *The Kay of Creation*. The same phenomenon occurs all along the *lateral octave*: the growth of *organic life* is realized in gradual stages and as the energy from the Absolute II provokes a response. In the same way, the potential energy accumulated in a seed takes kinetic form as growth when the seed is sown and provokes a reaction from the soil.

As in all descending octaves, the energy from the Absolute II takes on a masculine character; it penetrates within (*dans le milieu*), where the action occurs as in a kind of womb (*matrice*); and it is to the degree that the reaction of the latter spreads upward along the *lateral octave* that *organic life* makes its appearance. This is always the manifestation of the same *Law of Realisation* — to which allusion is made in the formula of Revelation: '*Behold, I stand at the door and knock: if any man hear my voice and open the door, I will come into him, and will sup with him, and he with me.*'²

The Love from the Absolute II, a vivifying masculine energy, is projected in superabundance downward along the *lateral octave*. But the concrete result of this, the birth of *organic life*, appears only as a response to this call, a kind of reflux of feminine energy. Progressing upwards to the interval, this energy re-establishes the primal equilibrium — which had been broken in the heart of the void by the perturbing action of Love from the Absolute II — through a living realization. The feminine energy first reaches the note FA, then rises towards SOL, and finally reaches LA.³ In other words, *organic life on Earth* appears in the opposite direction to the action of Love; at first in the form of flora; then as fauna, and lastly as man, though this may at first seem paradoxical.

Within each of these notes we can see the same complex process of growth and development. In each of the three cases this process follows a descending inner gamut. It is triggered by the reflux impulse, which then serves as the active force that ensures the general growth of *organic life*. To move on to development, a complementary voluntary effort is required. In

1.Cf. Vol I, figure 47, p. 135.

2. Revelation iii: 20.

^■WeshaU not stop for the moment at the question of how the interval between FA and MI of the *IfUralOctave* is filled, which is analogous to the way by which the same interval of the *Great Octave* is filled. We shall return to this question in the second part of this volume.

the gamut of vegetable life this manifests as agricultural -work. It is this conscious, voluntary effort of the cultivator which fills the interval between FA and MI of this gamut,⁴ so that the Earth multiplies its fruits. If this effort were to cease, the farmlands and orchards would return to the primitive state and the rose again become the wild eglantine. Exactly the same is true for animals and for man himself, as we shall see further on.

The process of development, as we have defined it, represents the *refinement of organic life on Earth*: through this the *transmitter station* responds with increased sensitivity to the impact of the energy from the Absolute I directed towards it by the Absolute II. During the process of development, the *station* also acts as a transformer that emits finer and then still finer waves.

This is the qualitative aspect. From the quantitative point of view, the multiplication of the elements of *organic life* renders our planet's *transmitter station* more and more powerful and at the same time more and more sensitive. Thus, step by step, the necessary conditions to fill the interval between FA and MI of the *Great Octave* are progressively assembled (*rami*). By the note MI, the flow along our *Raj of Creation* would be capable of transforming life on our planet, and consequently the life of the planet itself; it would men produce transformations in our satellite that would take it on to the next stage of its evolution.

W

Man's ingenious and conscious intervention stimulates the development of fauna and flora in a certain direction at a certain pace, and so gives them certain qualities. But how does the development of man himself occur? By what influence —necessarily exterior — is the interval between FA and MI of humanity's gamut of *evolution* filled so that it allows man to go beyond the growth stage and reach the stage of development?

By the human measure of Time, the complete process (*ensemble*) of human growth and development seems particularly long. Yet since growth takes up four notes of the gamut, and development only two, the latter is much shorter than the former. This difference is further accentuated by the fact that any creative process, if it evolves normally, always goes on accelerating. Although the growth of the human species has lasted from the tertiary epoch, sixty or perhaps a hundred million years,⁵ the contemporary physical human type, *homo sapiensfossi/is*, still a primitive type, appeared only forty thousand years ago in the later paleolithic era, and man with the

4. The causes and effects that manifest the succession of gamuts that form the ladder of the cosmos occur in cycles. The three great motivating powers (*moteurs*) of man; hunger, sex and fear, oblige him to take the initiative and to play a part in constructive or productive work.

5. Cf. Volume 1, chapter VIII, section 6, pp. 71-72,

modern type of psyche, *exterior man*, *homo sapiens re cms*, goes back approximately fourteen thousand years.⁷

Were we to represent the whole (*ensemble*) of man's growth and development graphically, with time as the x-axis, we should attribute to growth two thousand times the duration of development. The rise of this curve along the y axis, insignificant during growth, becomes very fast during development, as shown by figure 2, p. 48.

This view corresponds integrally to the biblical account of Genesis, in which the creation of man took place in two distinct stages. In the first or pre-adamic humanity both men and women were created in the image and likeness of the Creator;⁹ then comes the creation of Adam followed by that of Eve, *bone of his bone and flesh of his flesh*.¹⁰

It is since Adam that man has received the capacity to pass from growth to development in his evolution, and only part of the humanity of those times received this gift. The Bible speaks of a long period of coexistence of the first humanity alongside adamic humanity. It later refers to the latter as passing through a period of recession following mixed marriages¹¹ which were considered by God as evidence of *great perversity*, and which led this mixed humanity to the catastrophe of the Flood.

It is to be noted that the first hominid, having by that time reached the limit of its growth, still retained animal characteristics: it did not possess speech. Genesis alluded to this by indicating that it was to Adam and not to pre-adamic man that God brought the species of fauna to be named. The account went on: *and Adam gave names to all the beasts, to the birds of the air, and to every animal of the field.*'

Adam became a *living Soul (dme vivant)* after a *complementary impulse* given to him by God. The Bible's symbolic language expresses this by the following image: *'the Lord God formed man of the dust of the ground and breathed into his nostrils the breath of life; and man became a living Soul.'*

This is the esoteric meaning of this metaphor: man, formed from the dust of the ground, appeared very like his counterpart of the animal world: he would have reminded us of the anthropoids as we know them at present,

6. Mark iv: 11.

7. Cf. Volume 1, chapter XIII.

8. Genesis i: 27.

9. Genesis ii: 7.

10. Genesis ii: 21-23.

11. Genesis vi: 1-4.

12. Genesis vi: 5

13. Genesis ii: 19.

14. Genesis ii: 20. (The small departures from the Biblical text are the author's.)

15. Genesis ii: 7.

16. Genesis, *ibid*,

even though, according to the Bible, he was beautiful. In addition he possessed in latent state a potential that the purely animal world does not possess, that of passing on to *human* and even *superhuman* stages of development. But this development was only possible if man had received this *complementary impulse* which would allow him to pass, in the individual gamut, from the note FA where the most evolved of this humanity had arrived to the note MI, which represents the first stage of development. In the sacred text, the image of God breathing the breath of life into Adam's nostrils — which gave the latter a living Soul — represents this new impulse. We should also note that the creation of this second humanity, adamic humanity, is a response to the divine will to use man for the transformation of the flora and the cultivation of the soil {sol})*

The Breath of life is an image of the implantation in adamic man of a divine spark taking the form of two coupled higher centres. Until then man, formed from the dust of the ground, had only two lower centres, the motor and emotional centres that had been formed with the physical body by the creative energy of the sexual centre; from this time on he also had a higher emotional centre and a higher intellectual centre. But he still lacked the lower intellectual centre, of which he had a most urgent need for the transformation of matter, and particularly to cultivate the soil,

This was the state of the psyche of Adam and Eve before the fall, in the terrestrial Paradise of the Garden of Eden. They live constantly in direct contact with God, since the purity of their lower emotional centre allowed them to maintain permanent contact with the higher emotional centre and through this with the higher intellectual centre. In this way they could participate, although only passively, in life on a higher, divine plane.

It is at this time that man finally broke away from the purely animal life. In the vertical position his hands were freed for many different tasks. And it was by work that adamic man began on his long path of progress.

Until then, he was only a consumer; from then on he became a producer,

Adam was wise, with a divine wisdom which penetrated through his higher centres and through the lower emotional centre, which still retained its original purity. This state of innocent simplicity was of a higher quality, although unconscious in the sense that Adam drew upon the highest planes in a passive way. It is described in Genesis in a way which may seem odd at first glance. The text says: *'they were both naked, the man and his wife, and were not ashamed?'**

Creative work, primitive as it was then, faced adamic man with the need to formulate aims and determine the best means for attaining them. It was under this pressure that the need for judgement arose, in other words, the

17. Genesis vi: 2

IS, Genesis ii: 5.

19. Genesis ii: 25.

critical mind (*I'esprit critique*). The state of unconscious beatitude of life in Eden corresponds to the passage of Adam and Eve from the interval of FA to the MI of their evolutionary octave. But the further the couple advanced across the moat filled by the divine grace breathed into them, the more clearly the notion of economy of effort, which accompanies productive work, was presented to their minds. Then appeared the idea of advantage, then that of gain, which first attacked Eve's heart, penetrating and wounding her. This is the mark of the Serpent who, says the Bible, *was more subtle than any beast of the field*.

This increasingly intimate perception of the material world was translated in man by the formation of the lower intellectual centre, which Genesis calls *the Tree of Knowledge of Good and Evil*.^{2^} This completed the formation of the human personality as we know it.

Meanwhile, with the birth of the critical mind which accompanied the notion and desire for acquisition, the original purity of the lower emotional centre in the hearts of Adam and Eve was disturbed. As Jesus says later: *for where your treasure is, there will your heart be also?*² Pursuing the mirage of temporal goods, Adam and Eve's lower emotional centre hardened. In this way it lost direct contact with the higher emotional centre, that is, with the real T, the contact which made Adam and Eve the *children of God*. The beauty of the daughters of man did the rest.²⁴ Adam turned away from his real T and identified with his Personality.

Thus he became mortal.²⁵

The emergence of the critical mind in man is described in Genesis by the symbol that has already been mentioned. It is said that: *after having tasted of the fruit of the Tree of Knowledge of Good and Evil, Adam and Eve knew that they were naked, and they felt ashamed*.

Let us now examine the process of the creation of the human prototype, As with the birth of any animal or vegetable species, the interaction of the divine, creative masculine force and the corresponding feminine force was necessary: the masculine energy came from our Sun as an emanation of the Absolute II, and the feminine energy from the Moon, matrix of our

20. Genesis iii: 1.

21. Genesis ii: 9.

22. Matthew vi: 21; Luke xii: 34.

23. Genesis vi: 1.

24. Genesis vi: 1.

25. Genesis ii: 7.

26. Genesis iii: 7.

Ray of Creation. As a result of the conscious intervention of these two forces, Mother Earth engendered man from the *dust of the Earth*"

This is simply a specific example of the creative action of the complementary forces in the Universe, where all the suns together form the body of the cosmic Christ, the Absolute!!, and all the satellites form the body of the Mother, the Queen of Heaven, *Regina Astris*.

We should again point out that this description will allow the reader to rethink certain passages of the first volume about the structure of the Universe.

It was with this reflux of feminine energy in response to the divine / masculine energy that the growth of the creature began. At the start, the sexual centre and the motor centre emerged simultaneously; then came the creation of the lower emotional centre. Once a mental (*psychtque*) body had been formed in this way, the process of growth could continue and reach completion. But this was not yet adamic man, separated from the heaven which was previously accessible to him and tied to the earth yet having left his animal nature behind. The divine spark, which takes the form of linked higher centres, represents the link with Heaven in man, while the lower intellectual centre binds him to the earth at the same time as it separates him from the animal. It is as if adamic man is suspended between Earth and Heaven. He has the capacity for regaining Paradise through conscious efforts, by building a bridge to the divine spark which he carries within him. But he is generally unaware of this.

(V) |

The joint action of the creative energy of the sexual centre and the faculties of intuition and discernment of the lower intellectual centre caused imagination to arise in man. After this, his development, the fruit of bis conscious efforts, takes on a so to say epicyclic form:

- 1) Man *explores* the unknown: this operation, fruit of this creative imagination, is characteristic of every project;
- 2) Then, by the *return path* his ideas become concrete, he accumulates the necessary data to establish a plan of action and assembles the elements needed to put it into execution;
- 3) Lastly, thus enriched, he acts on this plan.

This is the scheme of every human enterprise which puts into play all the factors in this activity.

27. Genesis ii: 7,

Man's acquisition of the higher centres led to the formation of the lower intellectual centre in him, and its appearance completed the T of the Personality: in its turn, this completion allows a man who follows the gamut of his evolution to cross the interval between FA and MI of that gamut and so reach the note MI, where his development begins.

In all the descending gamuts of creation, particularly in those which have a positive nature, the note MI has analogous characteristics. It corresponds to the Earth in the *Great cosmic Octave*. We may also remember that the esoteric meaning of this syllable (MI) is: *Mixtosorbis*, mixed world. In the octave of human evolution, when growth has been completed and the interval crossed, man's inner life takes on this same character of a *Mixtus orbis*. This means that he then ceases to be oriented in only one direction as is an animal or plant that lacks the capacity for individual development. Animal and vegetable evolution ends when it bears fruit. Animals, and even more certainly plants, do not and cannot have inner conflicts: they only have one goal, the preservation of life with the aim of procreation, and all their efforts are centred on this goal. Man, on the contrary, lives in a kingdom of doubts and inner conflicts which sometimes truly tear him apart.

It is rare that the escape to the shelter of bourgeois life, with its mediocre passions, its voluntarily limited interests, and its slow pace, can guarantee freedom from shocks all through life. There comes a day when the scaffolding of tricks towards God and oneself falls into ruin: the hurricane of an unexpected passion sweeps it away, and nothing remains but a poor overwhelmed being faced with the insoluble or apparently insoluble problem of building a new life.

Man has a double aim in his personal evolution: survival and procreation on the one hand, a continuation of his animal life, and on the other hand his esoteric development which will allow him to achieve *Individuality*, by awakening to consciousness of his real 'I' at the second Birth — possibly in this life.

Naturally the second aim is much more important than the first; their value is incommensurable. But *exterior* man does not know this. He perishes for bronze, mistaking it for gold.

(?)

This picture of the evolution of the human species through the process of *growth-development*, a picture left to us by the Bible in symbolic form,

28. *Supra*, pp. 8, 9.

has been preserved since time immemorial by the esoteric Tradition: to confirm this we can quote certain texts from the mysteries and from Greek philosophy. After the coming of Christ, when traditions until then hermetic were partially released from secrecy, some of them were incorporated in the doctrines of schools which were attempting to synthesize a Greco-Judaeo-Christian gnosis. A powerful movement of thought was launched by Simon Magus, a Samaritan whose personality remains shrouded in legend, a few fragments of the doctrine he elaborated with Menander's help were passed down to us by Saturnil, a disciple of the latter. After an absurd and complicated account of the events which preceded Creation, he relates that the first man crawled. He said that later the Virtue from above had pity on him because he was created in His image; that He gave him a spark of Life which allowed him to stand upright and enabled him to live. This spark of Life —so Saturnil taught—reascends after death towards the higher beings to whom it is related.²⁹

This fragment, which on the whole agrees with canonical Tradition, was placed in a most fanciful framework. The error of the heretical gnostics, as we know them from criticisms by the Fathers of the Church, their adversaries — among whom we can quote Saint Irenaeus and Saint Clement of Alexandria—took the form of intellectually detaching man from the Cosmos in which he lived. The problem was thus reduced to the personal fate of the individual. On the other hand the imperfection of the phenomenal world was naively explained either by a celestial catastrophe or as an error of God or as a result of His wickedness. This error of conception has already been described in the first volume of *Gnosis*. We recognize here the influence of Hellenistic thought which, after the time of Homer, attributed human motives to the Gods. Neither was this tendency foreign to the Jewish mind, which went as far as making God repent of having created Man, and attributed fear and vengeance to him.

The more important the question studied, the more it should be considered in all its aspects; otherwise synthesis, the only thing that can resolve it, becomes impossible since the value of elements analysed in isolation is always debatable — because they have then been arbitrarily detached from other elements which must be considered to obtain a complete picture. This represents them in a faulty way.

29. *PhilouiphiHmew*, vii, 28. Quoted by J. Doressc, *l'tsiivrts secrtti its Gttesiiques d'Egyptt*, Paris, Plon, 1958, pp. 20-21.

30. Genesis vi: 6.

31. Genesis iii: 22.

32. Nahum i: 2.

The problem of man immeasurably exceeds his immediate interests here below and even in the hereafter. To understand this problem, we must turn to the source of the Tradition, to: *the wisdom of Cod in a mystery, even the hidden wisdom which God ordained before the world unto our glory, wisdom*, as St Paul said, *which none of the princes of this world knew*.

This is the only way to avoid falling into heresy when studying these matters.

33. I Corinthians ii: 6-8.

CHAPTER II

The views on man and on the structure of the Universe that were expressed in the first volume of *Gnosis* can help us to define — in the terms used by the Tradition — the place a human being occupies in the context of *organic life*. By specifying the nature of the bonds that join them, we shall be better able to perceive the full extent of man's mission on the planet and in the Cosmos.

Before life was born on Earth, it was first necessary to realize the conditions for this birth. Note SI of the *lateral octave* represents this preliminary stage, in which Earth was first enveloped by an atmosphere and a magnetic field, the one inseparable from the other. Before the atmosphere came to have the complex structure it has today, it evolved through a descending gamut which, following the rule, included a period of growth and a period of development. But from its first appearance it vivified the planet which, from that time on, became a sensitive organ active in the body of the *Mesocosmos* and, through the latter, from level to level through the whole *Macrocosmos*.

The appearance of cellular life followed the birth of the atmosphere and Earth's magnetic field. Since this appearance, and long before the atmosphere had reached the complex forms reported by modern science, cellular life allowed the *transmitter station* to function, its role being to fill the interval between FA and MI of the *Great Octave* of the *Ray of Creation* by transforming the energies that emanate from the Absolute II.

That it was necessary for it to be filled in contact with the planet is shown by its position in the *Great Octave*. This position also reflects one aspect of the character of the *Mixtus Orbis*—Earth — which although it is shown at the level of MI in the Octave, is also an element of the planetary cohort and participates in FA through the links it has with the latter. *Organic life* is therefore properly placed at the level of the interval between those two notes.

Today, positive science confirms the traditional concept in which the atmosphere of a planet is the result of a concentration of the ETHER under the influence of subtle energies. This is a symbolic way of saying that diffused interstellar matter can condense around a planet once solar action has allowed the formation of a magnetic field, as this tends to collect matter passing through space. The Tradition recognizes the interaction between the atmosphere, the magnetic field, and solar radiation. Once it has been formed the atmosphere resists solar radiation, and this resistance rein-

forces the Earth's magnetic field. Amongst other functions, this collects certain influences directed by the sun towards our planet for the benefit of *organic life*, and particularly for man, its most sensitive organism. Reception is uniformly distributed by Earth's daily rotation. To this direct reception is added indirect reception through reflection by the Moon, the intensity and quality of which varies according to its phases. Graphically, its intensity can be shown by a sine curve.

The twin roles of the atmosphere and the earth's magnetism, which condition life on Earth and fill the interval between FA and MI of the *Great Octave*, form one particular instance of the means by which the second interval of the *Rays of Creation*, the interval DO-SI, is filled for the whole *Macrocosmos*: in this way, life can develop without discontinuity through all the levels of a Universe, so that its functioning manifests an organic unity.

If certain astronomical representations of the Universe in positive science have sometimes seemed to contradict the theory of this fundamental unity, the most recent information, especially that concerning cosmic rays and exchanges of energy, seems to show progress toward the confirmation of traditional Knowledge.

W

In flora, fauna and man, the principal common feature by which the unity of life is expressed is respiration, the essential characteristic of all living beings. Immersed in the atmosphere, which penetrates even into the soil, the rivers and the oceans, everything that lives *breathes*. Respiration has functions in addition to the chemical transformation in which oxygen and carbon dioxide are exchanged. It allows living matter to draw from radiation — as it is when it reaches the level of *organic life* after passing through the atmosphere — certain elements or certain influences coming from our solar system and from beyond, from the galactic world.

According to the Tradition, each of these elements bears the qualitative mark of the source from which it originated. Depending on its state of *being*, every living body can absorb and assimilate all kinds of material influences originating anywhere in the Universe. When several persons are gathered in a particular place, for example, the same air is inhaled (by all). Yet everyone exhales a different air. This is because of the unequal power of absorption of the people present, a power which is a function of their respective levels of *being* on the physical level, the level of the psyche, and

i. The interchangeability of mass and energy according 10 Einstein. And the lack of finite position in certain observations of quantum physics reinforce this even more strongly, (Ed.) 2. Cf. Psalms cil (cJ): 6. Numbers between brackets are those of the Louis Segond translation.

the spiritual level. This shows *in* the working of the three gamuts of nutrition of which we shall speak further in chapter XI.

(V

Let us now examine the relationship between *organic life* on Earth and the Sun. The Tradition has always considered the Sun as the Absolute for this life; that is to say, as the Being who conditions it entirely. It refuses to consider it as no more than a laboratory where chemical reactions and physical, magnetic or electrical phenomena take place at a temperature of several million degrees yet are ultimately reducible simply to mechanical combinations.

Apart from its action in the physical domain, it is generally recognized today that the Sun exercises an important influence on man's psychology. This action can be observed particularly following the appearance of sun-spots, as, apart from the magnetic storms they provoke, these frequently bring on social disorders and even wars.

Until recent times, positive science has only been able to observe the Sun through the *Tritocosmos* and *Mesocosmos*. It is only in the very last few years, since probes have allowed us to photograph the Sun free of the filtering of radiations by the atmosphere, that we have become aware of the importance of the deformations that are due to this screen: the appearance of the sun, especially its colour, changes as soon as we reach the stratosphere. But the possibility of launching satellites equipped with scientific instruments should allow us to collect new information about the outer aspect of our Absolute under conditions if not identical to, at least similar to those under which we have collected scientific data relative to the Earth: to observe the Sun as it appears from within its own cosmos, and no longer through two successive screens.

(4)

Though of a different nature, the relations which link the Earth to the Moon, and the influence these two cosmoses exert over each other, are of considerable importance for *organic life* on our planet.

The Moon is RE at one and the same time both for our *lateral octave* and for the *Great Octave*. It is a member of the *Tessarocosmos* since it is a planetary satellite and a particle of the body of the Cosmic Mother. It represents the feminine cosmic energy in our *Way of Creation*, and, like Isis and Aphrodite-Urania, it personifies Love in its passive, feminine or reflected form. It is the last note of the gamut descending from the Sun, which is the DO of our *lateral octave*, a star of the *Macrocosmos*, and thus a particle of the cosmic

Christ. The Sun personifies the Absolute II for our *Ray of Creation*, while the lunar energy propagates by ascending along both the *Great Octave* and *lateral octave* at the same time: it is described in the former as the *Mother of God* and in the *lateral octave* as *OnzQueen of Heaven, Regina Astrir*. the liturgy attributes these titles to the Virgin Mary.

The Moon is therefore the receptacle, the matrix which, in response to the energy of the Absolute II, gives birth all along the *Kay of Creation*, to the different elements of cosmic life, the beings belonging to the three kingdoms of *organic life*, so that the latter falls under the influence of the Sun-Moon polarization. The Moon's passive energy arises from solar energy. It reflects this, but not without a transformation as its own nature interferes to polarize the reflected rays relative to their initial character.

The as yet unfinished nature of the *Tessarocosmos* has already been mentioned in the first volume of *Gnosis*, with the consequences to which this incompleteness leads for *organic life*, and particularly for man. The Moon, regarded as a living cosmic being, is not yet born. This is betrayed particularly by the absence of an atmosphere and magnetic field. Unlike the Earth, the Moon does not have a direct organic link with the Sun. Being a satellite, it depends directly on its planet, and it is only through the latter's mediation that it enters into relation with the Sun. One of its essential roles is to reflect solar energy onto the Earth's surface in a form modified by reflection as described above. This also leads to qualitative and quantitative variations that depend on its phases. These changes do not prevent continual reverberation, due to the fact that the Moon always presents the same face to Earth, as the duration of its rotation around itself and around our planet are both the same.

The *Ray of Creation* to which the human species belongs therefore remains uncompleted. Neither *organic life*, nor man in particular, have reached the point in their growth and development which would perfectly fill the interval between FA and MI of the *Great Octave*—with the two consequences which would then occur: the vivification of the Earth at stage MI, and the animation of the Moon at note RE by the energy that comes from the Absolute I. We must clearly perceive in this final operation the combined play of the octaves at the level of the interval, the flux, union, reflux and, in the creative process, the synergy between the forces arising from the *Protocosmos* and the *Deuteroscosmos*. According to St John, to the degree that this crossing is accomplished, Earth receives *grace upon grace*,³ since the energy appearing within it will then come simultaneously from

3. John 1: 16.

both the *Great Octave* and the *lateral octave*, that is to say, both from the Absolute I and the Absolute II. In addition, the Moon profits from energy coming from the ensemble of *organic life on Earth*. Here, man appears to have a prominent role.

jw

The voluntary, conscious nature of human actions in the transformation of *organic life* has already been noted. This intervention becomes more and more noticeable, and more and more widespread. Were we to represent its results by a graph this would approximate that of a geometric progression. The pace of production continues to accelerate. If we cannot go so far as to state that this coincides absolutely with the growth of the population considered sector by sector, we can constate that, seen as a whole, it varies in similar proportions. One could regard this as a response to the apparent compression of Time of which we have spoken elsewhere. From the qualitative point of view we must stress how important is man's selective role in these operations of the transformation and elimination of fauna and flora: this selection conditions not only the growth but, above all, the development, that is to say, the refinement of *organic life*.

It would be useful to examine in a little more detail the history of these transformations of *organic life* so as to understand better how they are linked to the completion of our *Ray of Creation*.

When *organic life* first appeared on our planet, only the note FA of the *Lateral Octave* was resonating. The transmission of energy was then carried out only by the flora, in a way that was coarse and incomplete. The entry into play of the note SOL changed this situation very little. The existence of giant specimens of fauna and then the emergence of pre-adamic man certainly influenced the volume of activity of the *transmitter station*, but still lacked the qualitative element which alone could cause the note LA to resonate: that is to say, man's reaching the stage of development, a stage required as catalyst in the expansion of the two other notes. It was the actions of man that led to the appearance of plants of high nutritive value, to the domestication of certain species of animals, and to the application of selective methods to livestock. These were the first steps towards the domestication of Nature, which sometimes appears in the form of an amplification of the play of natural phenomena and sometimes restricts their action. In essence this domestication tends to create potential usefulness to man. The immediate effect is an increase in the flora and fauna that serve man.

The ability to use more and more extensive sources of energy has direct repercussions on the opposed cycles of general nutrition, repercussions

which tend to produce what we can all constate nowadays: the geometric development of those elements which provide the *transmitter nation* with its power,

(V)

I

If growth and development are visible and regular as far as fauna and flora are concerned, we can also say that during the historical period the quality of *exterior* man has not undergone modification except in an unbalanced form: the intellectual hypertrophy of the governing classes has occurred at the expense of their emotional functions and, in certain cases, of their motor functions.

This is because man works harder and harder to better the conditions of life without caring about life itself. Certainly this last concern seems to have remained conscious within certain circles in the Orient —and this doubtless explains the attraction they exercise — but what has become in the West of the active tendencies which once manifested in the thoughts of a Socrates or a Plato, and the teaching of schools which, even in if in aberrant forms, claimed to solve the problem of life not only in theory but in practice; that is to say the problem of Salvation, the object of the Christian Tradition?

This preoccupation now troubles only a reduced number of personalities who wish to apply their efforts to the esoteric domain of traditional knowledge, and who more often than not remain isolated. What we observe is a general deviation of the point of application of human energies. If this is Paradoxical, it yet has its *raison d'etre*. The increasing force of illusion is the intensified effect of the *Genera/Law* adapted to this compression of Time.

(8)

The life of *exterior* man's psyche has hardly changed since the cycle of the Father: it is still ruled by fear, hunger and sex, the three principal drives of the *GeneralLaw*. It continues to be a picture of misery and chaos. Here, pictured by Thucydides (460-395 BC), is a report of conditions of life transmitted orally to his generation:

'The country today known as Greece was not formerly inhabited in a permanent manner, but was the scene of frequent migrations. People abandoned their homes without grief to make place for waves of newcomers.

'Since there was neither commerce, nor reliable communication, either by land or sea; everyone exploited the land individually to the measure of his needs without thinking of becoming wealthy, without even establishing plantations (since with open towns they never knew when harvests would have been taken by marauding

strangers); and lastly, because they expected to find their daily sustenance wherever they were, people migrated without difficulty⁴

The situation had hardly changed thirteen centuries later, as Masoudi (900—956), a learned Arab author, notes. He explained the mass movement of a certain population by its desire to escape from the twin calamities of pestilence and war.

The cruelty of wars and revolutions during the XXth century demonstrates that *exterior* man has made little progress morally: it would even be possible to find arguments in favour of regression on that plane.

(9)

In historical times the quality of fauna and flora has been considerably transformed through man's influence. The significance of this is that these two kingdoms have placed finer and finer energies at the disposal of the *transmitter station*. This does not apply to man: *Individualities* aside, the evolution of the human species, in the esoteric sense of the term, is a most debatable phenomenon. Conversely, the considerable growth of the human population plays an appreciable role in the evolution of the increased power of the *transmitter station*. This is a recent phenomenon, as can be seen from the examples quoted above.

In the Xth century of our era Earth was still sparsely populated. Seven Hungarian tribes and one Khazar tribe were then able to settle in the territory which now constitutes Hungary, which the Slavs had abandoned to emigrate northwards. In the same way, conquerors found the Americas and Siberia almost empty in the XVIth century. It seems that the population of the world maintained itself for many centuries at a figure that did not exceed a few hundred million inhabitants. Then, during the contemporary period, it started to increase rapidly. The annual rate of growth nowadays is of the order of 1.6%. Demographers estimated that in 1955 the world's population amounted to approximately 2,700 million souls, that it will exceed three billion by 1962 and will double again before the end of the century.

4. Thucydides: *Histoirt it U gutrrt PiUponttiie*, translated by E.-A. Betant, Paris, Hachette, 1873,1.2.

5. Masoudi: Aboul-Hassan Ali: El- *Let Prairiei d'Or*, original text followed by a translation by C.Barbier de Meynard and Pavet de Courtelle. in 9 vols., Paris, Asiatic Society, 1861-1877, Vol. 11, p. t0.

6. These estimates for the growth of world population arc generally consistent with events and demographic estimates between 1955 and the date of the English edition (1992). (Trans.)

Earlier considerations assume their full value when we try to measure their consequences for the evolution of Earth's *transmitter station* for cosmic energy.

Though the global intensity of transmission has grown considerably during contemporary history, the spectrum of energies transmitted down to the end of the *Kay of Creation* remains incomplete. In fact, it lacks massive amounts of the finest energies of the psyche: particularly emotional and spiritual energies. Only the evolution of man would be able to ensure their transmission in sufficient quality and quantity. As the growth of the human being is in fact complete, his evolution is now dependent on his development. The latter is essentially a process of refinement allowing him to pass from *knowledge* to *understanding*. Let us take an example. Recent scientific discoveries have enabled us to send instruments into space which, depending on their positioning, form for the Earth a new link either with the *lessarocosmos* or with the *Mesocosmos*. This is an important step which not only contributes to the full realization of the *Ray of Creation* but will also help to bring our *Mixtus Orbis* considerably closer to the *Deuterocosmos*.

Have the far reaching consequences of these events been fully understood? Here we should make a distinction between their significance on the esoteric plane and the scientific. Yet even about the latter uncertainty exists, despite widespread publicity for this penetration of other worlds. For the great majority, interest in it does not go beyond intellectual curiosity and even this has become blunted because of the growth of man's incapacity to be *astonished*: the loss of his *sense of wonder*. Instead, a feeling of vanity is aroused in most people, a feeling which reinforces their sense of self-satisfaction, that servant of the *General Law* whose efforts tend to obstruct moral evolution. This same *General Law* makes man react against unpredictable novelty and makes him sceptical of miracles, those signs from higher planes, and instills in him a hatred for those who try to awake him: *O Jerusalem, Jerusalem, thou that killest the prophets, and stonest those that are sent to thee*, said Jesus. In modern man particularly the overtraining of the intellectual centre aggravates the critical sense⁸ which at the same time facilitates his access to knowledge while limiting his ability to understand.

Knowledge (*savoir*) is compatible with sleep, but to understand (*comprendre*) requires an awakened curiosity guided by intuition, and as it grows deeper it leads to a desire for liberation. It is understanding that

7. Matthew xxiii: 37; Luke xiii: 34.

8. The intellectual sector of the negative pan of the intellectual centre. See Vol. I, pp. 24-25.

makes us act; being a positive emotion, it transcends the immobility implicit in the contradictory tendencies of intelligence.

When it compares the warnings given in the scriptures with the signs that advances in technology have inscribed in the firmament, it is understanding that becomes anxious:

So likewise ye, when ye shall see all these things, know that it is near, even at the doors.

Also*.

For as in the days that were before the flood they were eating and drinking, marrying and giving in marriage, until the day that Noe entered into the ark; and knew not until the flood came and took them all away.

And again:

Likewise also as it was in the days of Lot; they did eat, they drank, they bought, they sold, they planted, they builded; but the same day that Lot went out of Sodom it rained fire and brimstone from heaven, and destroyed them all.

The warning is clear. However, the source of the danger exists in man himself rather than in the circumstances, as is clearly shown in St Peter's text commented on in the first volume¹ where an alternative is offered, which says on the one hand:

But the heavens and the earth, which are now, by the same word are kept in store, reserved unto fire against the day of judgement and perdition of ungodly men... But the day of the Lord will come as a thief in the night; in that day the heavens shall pass away with a great noise, and the elements shall melt with fervent heat, the earth also and the works that are therein shall be burned up.

But on the other hand:

The Lord is not slack concerning his promise ...but is longsuffering to us-ward, not willing that any should perish, but that all should come to repentance... Nevertheless we, according to His promise, look for new heavens and a new earth, wherein dwelleth Righteousness.

The gap between man's moral weakness and his strength in the technical domain is striking: he marks time on the moral plane but leaps ahead in the technological field, This growing gulf is the outer proof of contemporary

9. Matthew xxiv: 33; Mark xiii: 29. This quotation is from the King James Bible (t611) text, which in this case agrees with the French text translated from the Slavonic text, which itself conforms to both Greek and Vulgate texts: *Ita et non turn vidtrith batt omsfa, icitote qui prapt tsl intuit.*

Contemporary texts, especially that of Louis Segond, translate the phrase 'it is near' loosely, replacing the pronoun 'it' by the expression 'Son of man*'. The Slavonic, Greek and Latin texts do not support this change. Cf, also: II Peter iii: 10 already quoted.

10. Matthew xxiv: 38-39; Luke xvii: 27.

11. Luke xvii: 28-29,

12. Cf. Vol. I, pp. 188-189 and pp. 226-227.

13. II Peter iii: 7, 10; also 11-12. Slavonic text. H.

II Peter iii: 9, 13.

man's inner inability to pass from *Knowledge* to *Understanding*: to cross the moat that separates them.

As far back as the beginnings of recorded history we find evidence that the Tradition taught the -way to cross this moat by knowledge (*connaissance*) of *oneself* and by working *on oneself*.

If we wish to achieve sufficient mastery of ourselves to ward off a catastrophe similar to those which the Holy Scriptures have recorded, it is urgent that we should direct all our forces in order to know ourselves.

(W. |

To better understand the creative meaning of man's work on himself, we must put it in context with the creative forces at work in the Universe.

We have seen that the essential principle¹⁵ of the creative energy from the Absolute I is *Love*. In our present state of being we are unable to perceive, conceive or even imagine the nature, magnificence and power of this *absolute spiritual Love* which, as it reaches the *Deutercosmos*, receives the *emotional and mental (psychique)* support of the Absolute II, the DO of the *Lateral Octave*, whose force reaches the whole planetary world, causing this *mental*, this *celestial Love* to resonate, penetrating and exalting *organic life* and so vivifying the whole Earth. To this is added the Love coming from the Absolute III, *carnal or Terrestrial Love*. In the form of sexual energy in all the variety of its manifestations, this rules the *Tritocosmos* and ensures the reproduction of the species.

Love, in these three forms, reaches, bathes and brings life to the whole Universe. A *Noumenon*, a direct and independent emanation of the Absolute, Love gives itself without restriction. Yet man constantly tends to subordinate this noumenal force to the ends of the Personality, which belong to the category of phenomena. How many unions are dictated by ambition or by social and similar considerations. This attitude is sacrilegious for—as the Creation is founded on Love—every offence against Love is an offence against God. And the Tradition says: *God loves to the point of jealousy*. We can say that the exploitation of love for practical ends breaks the universal equilibrium at this point and drags down to an egotistical level that which belongs in essence to higher planes. It is not surprising in these conditions to see that blasphemy against Love, who is Spirit, leads to monstrous situations, to moral bankruptcy and even to crime. Let us summarize what has just been said:

15. 1 John jv: 8. 24

The three currents of Lwt are: spiritual Love emanating from the Absolute I, mental (psychique) Love emanating from the Absolute II, and carnal Love emanating from the Absolute III; they permeate all organic life on Earth,

Meanwhile, man alone has the ability to capture and live them all. But to grasp and fully (*integrally*) experience the psyche's Love, the giving, the courteous, the love of Christ, is given to man only to the degree that a *magnetic centre* has been formed within him and this has then been absorbed by his higher emotional centre. As for spiritual Love, that of the Holy Spirit, to reach this he must have reached through the higher emotional centre to the higher intellectual centre. For *exterior* man, dominated by his incomplete Personality, Love is only accessible to him on the plane of the Absolute III: for although he is penetrated through and through by the other two currents, he generally remains unable to capture them, so that they remain essentially inconceivable to him. He only captures and so only experiences Love on the plane of the Absolute III, because on this level the sexual centre allows him to absorb and re-radiate the creative energy which ensures procreation. In addition, this Love includes a promise, an Ariadne's thread: by modifying his attitude to it, by evading its animal aspects, man can stem the current. This transformation is only possible with the sublimation of sex following esoteric evolution, when the man who today is an *exterior* man ceases to be so.

We must nevertheless constate that *exterior* man feels the transcendent character of the Love arising from the Absolute I and Absolute II. The first in essence reaches his consciousness in the form of a perception of existence. But he considers the beauty of the Universe and its life as mere information, instead of as a marvellous gift capable of constantly stimulating his sense of wonder and kindling his gratitude.

In relation to the Absolute II his attitude differs, at least in appearance. Human intelligence pays homage to the greatness of Jesus' sacrifice on the Cross, Yet man above all wants to consider himself as the beneficiary of the sacrifice of his Lord, who appears to him essentially as his Saviour: salvation seems to him an acquired right, a reward for the divine sacrifice.

For the 7th of the Personality these manifestations of Love on a higher plane therefore remain outside its sense of reality.

1&■ A reminder: man is only saved *in/act* after the second Birth (John iii: 5), when, his Personality having reached the end of its growth (man 4) is promoted by its identification with its real *I* to the tank of *Individuality* (man 5) and starts upon the **J?ay* properly speaking; the stage of *development* (men 6 & 7). For *exterior* men 1, 2 or 3, the advantage of the Saviour's sacrifice consists in the *possibility of 't/olt/ing*: he is only *saved in hope* (Romans viii: 24). [Ed.; This idea of 3. *second birth* was widespread in the early Church; one can find it as far afield as 9th century Britain, where Duns *^lu^iotii'* Rather it must refer to those *mho, bj tie SpiritualngenerationthroitghrMe* which is given in baptism, ruler the invisible world. Rejecting the birth according to the corruptible body, they chose the second birth, milch It spiritual.' Duns Scotus Eriugenst: 'The Flight of Eagle', Lindisfarn Press, Hudson N.Y., USA. 1991.]

Pursuing its own aims, the human Personality neglects the divine side of human nature and the complete and absolute gift it can make of itself, crucifying the Saviour every day by attempting to force Love to serve its own egotistical ends. All this is in vain, as such efforts inevitably lead first to moral bankruptcy and then to Death.

fty

J

In the following chapters we shall examine in more detail some aspects of the manifestations of Love: the noumenal base upon which the entire phenomenal edifice of the *Macrocosmos* rests, and the force which penetrates down to the last organism of the *Micro-microcosms*, the virus in the human spermatozoon.

CHAPTER III

The creative force emanating from the Absolute I is transmitted down to the limits of the Universe on the all-penetrating current of Love. In this diffusion, starting from its centre, we have seen that Love changes, if not in nature at least in intensity, so that it loses more and more of its refinement. If we consider our *Ray of Creation*, we observe a whole scale (raW/e) of values in radiations emitted by the Central Sun, by our Sun, then by the Earth and finally by the Moon.

W

We have seen the attitude *exterior* man takes to Love. It reflects his level of *beingind* also his *subjectivity*: the hold his Personality has over him. The splendour of the Love of the Absolute I is inconceivable to him. He can catch a glimpse of what the Love of the Absolute II, of Christ, could be, and can recognize its nobility and effective nature, but as long as man remains as he is he cannot practice it, since Christ's Love is *objective* love, and to experience it man has to pass beyond stage 4, balanced man, and come through the second Birth to the level of *being* of man 5, that of *Individuality*. In the Sermon on the Mount, Christ called on his disciples to break through the barrier of subjectivity:

' *Ye have learned that it hath been said, thou shalt love thine neighbour and hate thine enemy. But I say unto you, love your enemies, bless them that curse you, do good to them that hate you, and pray for them which abuse you and persecute you; that ye may be the children of your Father which is in Heaven: for he maketh his sun to rise on the evil and on the good, and sendeth rain on the just and on the unjust. For if ye love them which love you, what reward do you deserve? do not even the publicans the same? And if ye salute your brethren only, what do ye more than the usual? do not even the pagans so? Be ye therefore perfect, even as your heavenly Father is perfect.*'¹

As long as we cannot love in this way, with *zpure heart*, we shall remain outside the gate of the Kingdom of Heaven, among *the publicans* and the *gentiles*. Only true *Christians, Saints*, in the meaning given by the early Church, beings who having reached *Individuality*, who obey the imperatives of the divine spark within us: our real', have the gift of radiating Christ's objective Love.

¹• Matthew vi 43-48; also Luke vi: 27-35. 2. I Peter i: 22.

(3)

The only love which *exterior* man is capable of conceiving and offering, this pagan love, this remnant of divine Love, although it is subjective and passionate in substance, retains some quality from its origin. Because it comes from a noumenal force, it cannot be totally subordinated to the demands of the Personality, that reflection of the 'World', as it is called in the scriptures.

Man implicitly recognizes this fact by his profound sympathy towards the sincere passions, Art and literature abound in hymns to human love. When some work has as theme a conflict between a passion and social imperatives, the triumph of duty receives the approval of our thoughts but does not win the assent of our hearts. When a jury acquits the author of a crime of passion, it means that over and above the case submitted to them they want to recognize the transcendent character of passionate love. Esotericism reveals the source of this error committed by jurors. They attribute the characteristics of human Love to passionate love, through which man binds himself to the animal world by his fall from LA to the SOL of the *lateral octave*. But an animal has control neither over its actions nor over its attitude toward these actions. *Exterior* man has no more control over his actions: for example over adultery which has been the motive for crime and yet, participating in the LA of the *lateral octave* and endowed with an intellectual centre and so with a critical mind, he remains responsible for his attitude to his actions. This responsibility is the basis of the doctrine of sin.

Apart from the general ends it is called on to serve, for the human being animal love is a means and not an end. In particular, it must allow him to pass from the stage of *procreation* to the stage of *creation*. The respective roles of woman and man in this operation of transcendence, which still remains within the human domain, have already been revealed. Woman, the passive force in conception becomes the active force in the act of creation. In both cases, fertilization always has its source in the working of the sexual centre, whose nature shares in that of the higher centres so that it is capable of building a bridge between our two natures. The passage from animal love to truly human Love is on the way towards the objective Love in which the Sermon on the Mount invites us to participate. This objective Love gives us a new enlarged and refined vision of more subtle qualities of Love which come close to the first impulse of Creation.

Let us again consider the propagation of the creative force along our *Ray of Creation*, starting from the Sun. We have seen that the quality of this force is transformed as it moves further from the Absolute I: as it is put in the Scriptures:

*Different is the glory of the sun, and that of the moon and that of the stars: each differs from the other in glory.**

Placed between the Sun and the Moon the Earth, as we know, plays the role of a *transmitter station*; this is an instance of the universal law by which the active force—from which life in a particular cosmos proceeds — has its source in the next higher cosmos. Earth thus receives life from the Sun, and the Sun maintains that life. In the case of the Earth and the Moon the Absolute III, who ensures the procreation of species on earth, is also charged with the vivification of the satellite. If we correct for the time factor these mechanisms are comparable from one stage to another, although the analogy should not be stretched too far because of the roles assigned to each step in the larger context.

What, in broad outline, is the mechanism and form by which the *transmitter station*, Earth, communicates solar energy to its satellite? How can energies produced by human activity, particularly the energy produced by sexual life in its widest sense, reach the Moon and bring it to life?

To simplify the explanation⁵ we shall only consider two of the many movements of the terrestrial world; its gravitation around the Sun and its rotation about its axis.

In the first of these movements the inclination of the ecliptic produces a seasonal rhythm that becomes more and more distinct the further we move away from the equator. Obedient to this rhythm, floral life passes through four phases: sowing, growth, development, which ends by its bearing fruit —and rest. The unfolding of these phases is far less apparent for fauna, and even less for man in whom the normal rhythms of city life mask them without entirely eliminating them. In its natural course this produces a pulsation in *organic life*. The inversion of the curve from one hemisphere to the other does not produce total compensation: the extent of cultivated lands and the density of population show a net balance in favour of the Northern hemisphere, which consequently captures and emits much more radiation.

4, I Corinthians xv: 40-41. According to the Slavonic and Greek texts: glory = Sofia. The Vulgate uses the word *gloria* in verse 40 and replaces it by *daritai* in verse 41. The use of the word is uniform in both the Slavonic and Greek texts. The meaning of *glory* is dearly much more than just *brightness*, which risks being understood in its restrictive sense of luminous intensity.

5- Cf. volume I, pp. 97-98.

3. Cf. Vol. I, pp. 176-177, 28

It is easy to see that the alternation of days and nights also plays a role, particularly relating to the quality of radiations. The day is devoted, above all, to mundane life, to actions which so often entail negative emotions; the night to private life where positive emotions tend to dominate.

These two movements create a special mode for the absorption of those solar energies which, after all the transformations they have undergone in the atmosphere, reach *organic life* at its bottom. In addition, solar energies emitted intentionally for Earth follow a specific rhythm of their own. In this the rotation of the Sun around its axis plays a primary role. Among the energies received from the Sun we must not forget those which reach our planet after they have been reflected from its satellite. Here, the complexity of rhythms is even more evident, as are the shades of influence they exert on *organic life*. This influence is so striking that men who live in contact with nature seem always to have taken it into consideration,

These brief indications can only give a rough idea of the complexity of the bundles of energy that *organic life* receives and to which it constantly responds. Nevertheless, they can give us a glimpse of the complexity and variety of energy levels to which it is subjected. All of this concerns the quantitative aspect, but the qualitative element is no less important. In this domain the variations are even greater: beyond our book knowledge we know by experience the different influences that solar rays have on the human organism that is directly exposed to them, as well as the same rays reflected by the Moon.

With regard to the bundle of energies it receives, *organic life* acts like a vast laboratory. The range of transformations that solar energies are subjected to on our planet is considerable. This becomes ever more extensive as life assumes ever more complex forms, and as the interaction between the elements of the psyche and physical elements becomes more marked. These transformations then combine to elaborate finer and finer energies. This qualitative aspect has important repercussions on the general expansion of the *Ray of Creation* as much as on the personal evolution of human beings, and from that on the rest of *organic life*. We shall have occasion to consider one aspect of this in the chapter devoted to nutrition.

Once *organic life* has transformed these solar—or cosmic—radiations, the latter are re-transmitted to our satellite, and it is essentially that part of Earth not lit by the Sun which is the transmitter. Here is a new application of the law of analogy. The Tradition considers that each cosmos rigorously directs its radiations in the direction of the following cosmos which it is charged with vivifying: and in the same way, that solar energies are not mechanically projected in every direction of space, but directed individually to each planet of the system; so the energies emanating from Earth are directly oriented towards its satellite. This is the mechanism of transmission. The major function at *organic life*, regarded as a laboratory, consists of

the transformation of the energies that reach it, a transformation that is essentially carried out under the driving force of the Absolute III. Among the species living on Earth only man, by moving towards objective love, can in an appreciable way refine the energies received from this force. These fine energies have very great power, and play the role of a *catalyst* in the process of development of the *Ray of Creation*.

m

We must repeat that in essence this development contributes to the vivification of our satellite by refining *organic life on Earth*. The scriptures give certain indications concerning the duration of this transformation. One exegesis of Psalm 71 (72 of the Vulgate and Louis Segond versions) allows us to interpret its first seven verses as King David's vision of life on Earth during the era of the Holy-Spirit, when *the just shall flourish*. The end of this joyous era is shown in a precise way: *great will be the peace until the moon is removed?* Elsewhere, texts have alluded many times to a future metamorphosis of the Sun and Moon seen from the Earth. It is said that: *the sun shall be turned into darkness and the moon into blood?* These references clearly have a symbolic meaning; esoteric language often signifies life when it speaks of *blood*.^t According to the Tradition, the whole solar system, SOL-FA-MI-RE of the *Great Octave* and the whole of the *lateral octave*, serves as a nursery within the *Ray of Creation* and produces new suns complete with their planetary worlds. Today's planets will become suns, their satellites planets, and their asteroids will form the satellites of these new systems.

The Moon will cease to be a satellite and will become a living planet when the notes RE of the *Great Octave* and the *lateral octave* both resonate in full. This can only happen when our satellite has absorbed a sufficient quantity of solar energy transformed by the *Trifocosmos* and of such a quality that it creates an atmosphere,

We have already seen one reason why the Moon always presents the same face to the Earth. Here is another. Due to its rotation around its axis, a rotation lasting approximately a terrestrial month, the whole (*integrale*) of the Moon's surface is regularly illumined by the Sun. Conversely, radiations from the Earth only reach approximately one hemisphere. They fill the space from the Earth to the Moon in direct proportion to the power of the *transmitter station*. The growth of this power tends to create a greater

^{o-} *Removed* is a literal translation of the Slavonic: fIOHfleace OTfeHMeTCH ayua. In the Louis Segond Bible we find: *until the moon is no more*. It is puzzling to see the psalm in question ending thus: *The prayers of David the son of Jesse are ended*.

^t Acts ii: 20. Quoted from the Slavonic, which conforms to the Greek and Vulgate texts: *Sol Mitwrtttur tit tnebras et Luna in sanguineus*.

and greater potential difference between the radiations constantly received from the Sun, and the variable radiations emitted by our planet which favour a single lunar hemisphere. It is this difference in potential which tends to create an atmosphere and a magnetic field around the Moon. The existence of this *envelope* will allow the Sun's radiation to exert a direct influence over the Moon just as it does over the Earth. This will correspond to the entry into the world and the birth of the cosmic foetus when it has come to the term of its pregnancy.

The increase in this potential difference will also accelerate the moon's rotation round its axis: the cosmic newborn will take its position as a living planet: this is the conversion into blood of which king David spoke. It will then leave its orbit around Earth: in the Words of the Scriptures, it will be *taken away*.

The Earth itself, having accomplished its task of bringing life to the Moon, will also pass on to a new stage in its evolution: it will leave the *Mesocosmos*, entering the *Deuteroscosmos* as a new Sun. It will shine with its own light, and so our Sun will not illumine it as it does at present. It will be directly illumined by the ineffable light that comes from the high places of the *Protocosmos*. This explains king David's vision in which he saw the Sun *turned into darkness*,

Now that we have gone further in the study of the process by which the *Ray of Creation* is transformed and grows, it would be useful to emphasize certain aspects of the role that *organic life*, and man in particular, play in those transformations.

At all levels throughout the Universe, life passes through the stages of conception, birth, growth, and finally development. As far as *organic life on Earth* is concerned, the first two stages can be considered as completed although life is constantly being renewed. The emphasis is clearly on growth and development, Yet in the role our planet must play in the verification of its satellite, these two factors differ widely in their importance to the effectiveness of the *transmitter station*.

These transformations to which flora and fauna are subject are to a considerable degree the result of important qualitative changes made to them by man. From this point of view, although growth still continues, we can talk of development within the notes FA and SOL of the *lateral octave*. This growth and development are the conditions for an expansion of the human race which is now proceeding at a pace no human will seems capable of controlling. The theses of historians on demographic pressure as a source of armed conflicts, the warnings of

Malthusians, the restlessness of organizations responsible for the increase of natural resources, the propaganda of some governments in favour of birth control, have all remained without response, or at least with no real effect.

The geometrical progression in the growth of the population will ultimately place the accent on the LA of the *lateral octave*.

But we must insist on another point. The keyboard of energies at man's disposal has been considerably enlarged during the contemporary period, at a pace which also follows a geometric progression. The classification of natural resources should soon be extended to include energies drawn directly from the atmosphere, perhaps from even further out. The methods positive science puts at man's disposal greatly enlarge the field of his activity. With progress in electronics he will from now on not only have natural tools and mechanical devices at his disposal, but also 'intellectual' tools. The exact range of these means and their effect on *the power of the transmitter station* is as yet incalculable.

When we examine this problem of man's role from the angle which most concerns us, we should never forget that beside the quantitative element of which we have spoken, there is an element of transformation which plays an essential role in determining the quality of these energies in their final form. The multiplication of human activities from underground to outer space not only calls on new energies but, through the transformations to which they are subjected, modifies the quality of radiations our planet is able to emit. We recognize the role that man plays indirectly in harnessing and manipulating an ever wider spectrum of energies. But we must also regard man himself as a machine for transforming energies. The length of human life has greatly increased during the last century. Since the beginning of the XIXth century, the activities of the human person in all domains, among them that of sexual life, are prolonged beyond limits once considered normal. In this, as we have seen, there is a constantly increased source of energies of a quite specific nature which can play an essential role in the development of our *Ray of Creation*.

(6)

Without any false conceit we constate that man's responsibility has increased considerably during the contemporary period. And this responsibility continues to grow. The industrial revolution of the XIXth century marked the beginning of the transition between the periods of growth and development of *organic life*. Although this transition still continues, we may consider that properly speaking the development stage started with the use of atomic energy.

Even if the interval between FA and MI of the *Great Octave* has not yet been entirely filled, the note MI of the *lateral octave* has already started to resonate. According to the law of analogy which applies to all development, the full resonance of this note must be marked by the appearance and development of new abilities in man, the primary element in *organic life*. The *Mixtus Orbis* character of the environment in which man lives — a reflection of his level of *being*—curbs this blossoming. In terms of the end in view, the crossing of the interval of the *Great Octave* and the amplification of the MI in the *lateral octave* should occur concurrently. Interdependent, they both depend on the moral evolution of man. From this we can grasp the importance of the conscious efforts which will lead to the formation of a true elite, transformed by the *renewal of intelligence?* and capable of ensuring the full development of *organic life* with all the consequences this development must have. On the human scale these consequences are enormous. They involve not only passing through a stage in the expansion *of our Ray of Creation*, but also the possibility for the whole of humanity to reach what the scriptures call the *Accomplishment*.

m

It is probable that the perspectives of cosmic evolution revealed here will be received with reservations by some minds. Yet one may see in this a new hypothesis for the birth of stars, planets and their satellites, a hypothesis which may be added to those which already exist, since none of them has yet received unanimous agreement. This position could be described as positive scepticism, a position in which the scientist keeps an open mind towards theories that experience has so far been unable to disprove.

In fact, positive science admits it knows very few things about the life of the cosmos, about what might be called its physiology if we think about it as if its totality represents a living being or a collection of living beings.

This domain of life in the Universe is undoubtedly one of those in which the *ignorabimus* of Virchow most clearly defines the limits of human intelligence.

True scientists are humble, They know these limits. Their vision is not dazzled by the tinsel progress of technology. They readily admit that positive science has run into or is about to run into walls that are probably impassable.

8. Romans xii: 2 and also Ephesians iv. 23.

The most recent probes into the cosmos bring us face to face with unforeseeable novelty which sometimes contradict the calculations and theories of our science.

The previous explanation of the development of our *Ray of Creation* is not based on human experience. Its source is Revelation.

As man's intelligence is enclosed within the limits that his level of *being* imposes on him, it would probably be wise to give up the proud divorce between science and religion, a divorce which simply cuts us off from the unlimited resources of our Spirit.

Today there is no doubt that we can constate a change of attitude towards this problem. This fact is encouraging. The recognition and knowledge of our limits are the proper conditions for transcending them.

To surpass these limits is possible. The level of the cultured man of our times considerably surpasses that of *homo sapiens fossilis*. His knowledge is incomparably more extensive. If he now passes on to the stage of development as esotericism conceives it, if from *exterior* man he becomes *interior*¹¹ man, he will pass through the stage that leads to *savoir faire*. By doing so, he will truly become *homo faber*. His level of *being* and his condition will be as different from his present state as the latter differs from that of his ancestor of the ice age. He must certainly not refuse this offer although it demands conscious superefforts in working on himself. This refusal would trigger the principle of Equilibrium, which burns the branches of the vine and fells the tree which bears no fruit.

9. We can quote the theory of variation of temperatures in interplanetary space. As to conjectures it does not seem that inversion of the solar magnetic field had been envisaged by science. That phenomenon seems to have occurred during 1957-1958, according to Dr D. Bibcock of Mount Palomar.

10. Not the Apocalypse, but the process of Revelation. (Ed.)

11- Romans vii: 22.

*

CHAPTER IV

(V)

The previous chapters, keeping their description as simple as possible, have indicated man's position in the cosmos. More especially they have shown his place in *organic life* and the way he contributes to the execution of the plan of development for our *Kay of Creation*.

In relation to this we must emphasize the importance of conscious efforts, the only thing which can rescue man from his state as *exterior* man. As already explained in Volume I,¹ these efforts ensure the growth of the Personality. There is a close correlation between this *growth* and the *development of organic life* as a whole: the two processes interact with each other to form cycles whose aims coincide.

On this route the work demanded of a man is considerable. It is accessible only to those strong Spirits who are determined to obtain Life by constant self conquest in that invisible warfare which pits them against all the tendencies which dominate *exterior* man.

The Holy Scriptures meanwhile give certain encouraging indications for the future of this possible evolution. They let us hope that in the new era, the Cycle of the Holy Spirit, all conditions will be arranged so as to help the *exterior* man to come more easily to esoteric work so that he can become the *new man* who is master of himself.

St Paul says, *to put on the new man we must put off the old man*. And this must be done fully.⁵ We must be initiated not merely symbolically, but by a total inner communion with the mystery of Golgotha: the human heart crucified, first to die and then to rise again.

The resurrection thus appears as the final goal for man if he wholly commits himself and consciously plays the role for which he is destined.

This means we must search the Scriptures to discover what they say about the question of the Resurrection.

1- Chapter XX especially.

— Pp. 214-216: examination of the general diagram of the *Way*.

3- Cf. Vol. I, pp. 189-150

4. Ephesians iv: 21-24, also Colossians iii: 9.

5. Ed. 'In this way the bride opened her soul to the Word by removing the veil before her heart, that is, her flesh. 2» '#*«* of the flesh, I mean the old man, which the divine Apostle bids us to strip off and lay aside (Col. iii: 9) who are about to wash away in the laver of the Word the dirt that clings to the soul's feet.' Gregory of Nyssa: 'On the Canticles' -quoted in 'From Glory to dor', SVS PRESS, Crest wood, NY, 1979.



(2)

By the resurrection, the Bible understands the reconstitution of human bodies before the last Judgement in order to reunite them with the Spirits they once clothed.

We find allusions to this in various texts of the Old Testament.⁷ The sacred painters often drew from this. Men appear body and soul before the Sovereign Judge to be weighed, so that their fate can be finally determined. This vision perfectly harmonizes with other statements that tend to give us a more exact picture. This kind of conception is perfectly logical in itself. An immortal soul (*dme*), a divine spark, would need no resurrection. Conversely, a return to life is at least conceivable for the flesh as it appears to our senses. The Jews had differing attitudes to this problem. We know that the Sadducees did not believe in the resurrection: for these rationalists the soul (*dme*) perished with the body. It is important to stress that for orthodox Jews this point of view did not constitute a heresy. Sadducees were not only admitted to the Synagogue but were even raised to the Priesthood.¹¹

For those who did not share the Sadducean conception, the resurrection was a consequence of the immortality of the soul. But even this belief was not anchored firmly enough to give it the force of dogma.

We can say that at the time of the coming of Christ, the question of the resurrection was considered by the Jews more as the object of scholastic debate than as a problem having practical significance.

m

It was in this climate of thought that the Sadducees, in the hope of embarrassing him, asked Jesus the question mentioned in the Gospels: What, after the resurrection, would be the fate of the widow of

6. *Dictionnaire de la Bible*, published by F. Vigoureux, a priest of Saint-Sulpice with a great number of collaborators, Paris, Letouzey & Ane, 5 vols. 4to, 1895-1912, vol. V, p. 1063.

7. Job xix: 25-27 and also Ezekiel xxxvii: 1-14.

8. *Diithnitairt de la Bible*, op. cit. Vol. V, p. 1070.

9. *Ibid.* Vol. V, p. 1063.

10. Joseph Flavius, *Btll.jud.*, II, vm, 14; *Ant.jud.*, XVIII, 1,4. The reader will easily understand that controversy between the Sadducees and the Pharisees on the question of the immortality of the soul came from the confusion between notions that were almost certainly badly defined and badly understood at that epoch. To summarize MouraviePs view, the Personality-Soul, when it does not reach the second Birth during life, will perish with the body; the living or immortal Soul, man's divine spark, his real *T*, which forms the basis of his *Individuality*, remains unchanged after physical death, being immortal.

11. *Dictionnaire de la Bible*, op. cit., Vol. V, p. 1070.

six brothers, married to the seventh? In his answer, Christ stresses two aspects of the one reality;

'*Ye do err, for you neither understand the scriptures, nor the power of God. For at the resurrection men neither marry, nor are women given in marriage but will be as angels of God in heaven. But as touching the resurrection of the dead have ye not read thai which was spoken unto you by God saying:*

*'lawtheGodof Abraham and the God of Isaac and the God of Jacob?'*God is not the God of the dead but of the living. And when the multitude heard this they were astonished by his teaching.*¹²

This effectively put the question in a new light.

Although the Gospels contain numerous references to the general Resurrection which have been accepted and confirmed, they introduce the notion of an individual resurrection of the dead which was totally unknown to the Old Testament. The most ancient texts do not even mention it, and the opposite idea was commonly expressed: *man will lie and will be raised no more.*

Against this, we read in the text of St John that Jesus said to her; *lam the resurrection and the life: he that believeth in me, though he were dead,yet shall he live: and whosoever liveth and believeth in me shall never die.*

We can see that this concerns an individual resurrection, a return to life by a reunion of the spirit with the body from which it had been separated by death.

In Jesus Christ, the resurrection extends to a return of life to the same flesh from which life had fled. The resurrected Saviour was able to say to his Apostles: *touch me and see; for a spirit hath not flesh and bones as ye see me have*TM He invited Thomas to touch his pierced hands and his torn side. His flesh had regained life by its reunion with the soul, According to Saint Paul, *Christ is the first fruits of those who are asleep.* He is the prototype of the resurrected, as Adam is that of the victims of death. Man's flesh will one day meet the fate met by the flesh of Christ.¹⁸

12. Matthew xxii: 23-33; Mark xii: 18-27; Luke xx: 27—10. Saint Jerome notes, Jesus could have quoted more convincing texts, for example, Isaiah xxvi: 19 and Daniel xii: 2. He claims that our Lord chose that text from Exodus iii: 6 because the Sadducees only accepted the *Pentateuch* (Matthew iv: 22, Vol. XXVI, col. 165).

Quoted according to the *Dictionnaire de la Bible*, op. cit., Vol. V, p. 1070.

That assertion, borrowed from Origen, was reported in *Philosophoumeaa*: IX: 29; Paris, Cruice, 1860, p. 469.

13. Matthew xxiv: 31; xxv: 32,33,46; Mark xiii: 27; Lukexiv: 14; John v: 28-29; vi: 39-40,44.

14. *Dictionnaire de la Bible*, op. cit., Vol. V, pp. 1064-1069. Job xiv; 12; Psalms xl (xli): 9; xlii W"i): 17; Amos viii: 14,

15. John xi: 25.

16. Luke xxiv: 39. (Greatly altered in the King James bible as: '*Behold my hands and my feet, that it is I myself: touch me, and self*)

17. John xx: 27.

18. I Corinthians xv: 20-28.

If, as we have seen above, the Jews did not have the least idea of that mode of resurrection, Christians, on the contrary, had no doubt whatever in this respect. They knew that *God giveth life to the dead and ealieth those things which art not as though they were*. They were sure that *the one that raised Jesus from the dead also restores life to our mortal bodies because of His Spirit who dwells in us*.

On the basis of these texts, Theology advances the following theory. We know that during its earthly existence the elements of the human body are constantly renewed. It is quite possible that no particle would exist in the body of an old man that had remained in him since he was a child. Nevertheless it is the same body, because it is the same soul which animates it and keeps its elements together." Whatever elements compose the resurrected body, its identity will be maintained by the presence of the soul (*ante*), and the body, transfigured in the way described by St Paul, will be the same as that of the terrestrial life just as truly as the body of the old man was the one he had as a child. St Paul postulates this kind of identity when he writes, *sown in corruption; the body is raised incorruptible*

This is just what H. Lesetre, author of the article from the *Dictionnaire de la Bible* quoted above, concludes, saying that this body will have some of the nature of the spiritual, its incorruptibility and its mobility,^{23,24}

(4)

I

Let us re-examine the information given by the sacred texts and by theology about different aspects of the resurrection,

During the *Cycle of the Father* this problem never had the force of immediacy. In the Old Testament it is only treated on a theoretical plane. It is projected into an immeasurable future in a vague image of the *last judgement*. What then seemed certain about the body was that *man slept and was raised no more*, as in the quotation already given.

For the *Cycle of the Son* Jesus placed the question of the resurrection on a practical plane by bringing Lazarus back to life. He showed that individual

19. Romans iv: 17.

20. Romans viii: 11.

21. Cf the complex agümenis put forward by Athenagoras, first head of the Platonic Academy in the second century AD, and then a teacher of Christian Paidia in Alexandria, in the early parts of the text '*De Rtsttrreioit'*'. Athenagoras: '*Ltgatio and Dt Resurrection*', Clarendon Press. Oxford, 1972. (Ed.)

22. I Corinthians xv: 42-44.

23. I Corinthians xv: 36-44.

24. Ed. St Irenaeus says: If now, having received the promise of the Spirit, we cry; Abba, Father, what will it be like when, after we are resurrected, we see him face to face — when all the members, coming together in a great throng, chant the hymn of triumph in honour of him who resunected them from death and endowed rtwm with life eternal.' {Vladimir Lossky: '*Tit vision o/God*' p. 31.)

resurrection was possible by his own resurrection. St John also alludes to this mode of resurrection elsewhere, but this still did not concern the general resurrection. As this is not an immediate problem in the *Cycle of the Son*, it was treated in the Gospels in terms of the broadest generality. The Old Testament theme of the *last Judgement* is sometimes raised again in the New. At an undetermined time the dead will be resurrected: all *the Just*, or again, *all those who are in their sepulchres*, will be clothed again in their bodies to *be summoned before the Tribunal of God*. But a new theme emerges here. This collective resurrection is sometimes associated with Christ's Coming; Therefore, this advent would coincide in time with the *Cycle of the Holy Spirit*.

Before it can be fully understood, this theme of the Coming of the Son of Man, abundantly described in the New Testament, requires comment. Let us take several examples from the Gospels.

The 24th chapter of St Matthew is entirely devoted to this subject. There, certain indications are particularly exact, as in the following words of Christ:

The good News of the Kingdom shall be preached in all the world for a testimony unto all nations; and then shall the end come?!

This deals with the end of the 'World'. We are in general agreement in thinking that humanity has reached a decisive turning point of its history today and that we are now at the end of one of the chapters of the evolution of our planet, *oforganic life*, and of human society. This opinion is based on many considerations, several of which have been examined during our study. The evolution of positive science and the pace of that evolution tend to confirm it. From the point of view which most concerns us we observe that the preaching of the gospel has now become universal. Having spread lirtle by lirtle, in the XXth century it has truly reached every nation. Practically no cultured man exists on Earth who remains ignorant of Christ and his works. This condition having been fulfilled, we can take it for granted now that, in the Gospel sense, we have reached the end of the old world and that the *Son of Man is near, at the door*.

Now let us see how Jesus described his second Coming, which characterizes the New era, the *Cycle of the Holy Spirit*. Here is the majestic description given by St Matthew, a description to which we have already referred.

'The Sun shall be darkened and the Moon shall not give her light, the stars shall fall from heaven and the powers of the heavens shall be shaken.

25. Matthew xxiv: 14.

26- Matthew xxiv: 33.

And then shall appear the sign of the Son of Man in heaven: and then shall all the tribes of the earth mourn⁷ and they shall set the Son of Man coming in the clouds of heaven with power and great glory.

And he shall send his angels with a great sound of a trumpet, and they shall gather together his elect from the four winds, from one end of heaven to the other.

How should this text be understood? It is of course presented in symbolic form. By examining it in the light of the Doctrine described in this work it can easily be transcribed into modern language. The poetic image of angels with sounding trumpets to gather the *elect* from the four winds, from one extremity of the heavens to the other, is a message hurled by Jesus across the millennia so that it can be understood and deciphered at the end of the *Cycle of the Son*, twenty centuries after His incarnation.

We must first understand who are these elect. The reader will easily understand that this concerns men who have crossed the second Threshold, new men who, by their second Birth will be confirmed as *Individualities* by identifying themselves with their real T, a particle of Christ.

They will be gathered from the four winds, from one end of heaven to die other, to form the ruling elite of the coming era. The reference to the four winds and the extremities of heaven indicates that the *elect* will come from every part of the world, whatever race and belief they belong to: as St Paul explicitly says, in Christ there is neither Jew nor Greek. That elite will have to govern human affairs as well as ail *organic life on Earth*. This centralization of power for the whole planet between hands of *supermen* is the essential characteristic which must define the new order in the *Cycle of the Holy Spirit*.³⁰

Conscious of his real 'V through a direct and indissoluble union of his Personality with his higher emotional centre, the new man will be in direct and permanent contact with higher levels of Consciousness and with the Covenant of Love presided over by Christ in which, according to St Paul, He is *as the firstborn of many brothers*. *

This permanent, direct contact of the new men with higher planes explains why the second Coming does not require a new incarnation of the Son of God, The mediation of human language will no longer be necessary, as it was twenty centuries ago when Christ lived. That is the reason why he cast into the times to come the following warning to the faithful:

27. The use of the word 'mourn' here links to the footnote in Chapter. 1 quoting Gregory of Nyssa on the spiritual significance of this word in the Sermon on the Mount. (Ed.)

28. Matthew xxjv: 29-31.

29. Romans x: 12.

30. Romans viii: 29.

31. *Ibid*.

' Then if any man shall say unto you. Lo, here is Christ or there; believe it not. For there shall arise false Christs and false prophets and shall shew great prodigies and miracles; insomuch that, if it were possible, they shall seduce the very elect.^{3,2}

(5)

This new society ruled by the *elect*, the new earth where justice will abide, according to St Peter, has not yet emerged. Yet the idea of a world government capable of ensuring the peace of the world has taken root and is growing. It was already well defined by the Holy Alliance during the XIXth century. It has been expressed in rudimentary form by the emergence and expansion of international organizations. Certainly these organizations are still weak and devoid of real power. Yet they testify to an irreversible progress, Their disappearance is inconceivable. As they are now they represent the embryo of what could be considered as the *anima* of society during the *Cycle of the Holy Spirit*. Their imperfection does nothing to weaken their political importance or their esoteric significance. For in the course of development all these organisms seen as a whole will attain a true new birth and this will be animated by the breath of spirituality. Thus will it be made into a *living spirit capable* of ruling both humanity and *organic life on Earth*. In this way the Era of the Holy Spirit will finally be established, with all the consequences that this fact implies,

Let us now return to the question of the general Resurrection as described in the biblical texts. We have seen that the latter offers us symbols which can serve seekers as a thread of Ariadne from the moment when the problem acquires the nature of a reality for them. It is easy to perceive to what conclusions we would be drawn if we took literally the idea of a general Resurrection of the bodies of all human beings of the adamic period. The bases on which it is possible to establish an estimate of the number of men who have lived on Earth during that period may be imprecise, but they can give us an order of magnitude. If we admit that the appearance of adamic humanity coincides with that of *homo sapiens recens*, we can trace it back about fourteen thousand years on the basis of recent anthropological data. That represents about five hundred and sixty generations on the basis of four generations per century. By estimating the population of the world at a mean of about a hundred million inhabitants

32. Matthew xxiv: 23-24.

33. Cf. Vol. I, p. 192 ff., also Boris Mouravieff, *Le probiemi it l'AutoriM tuptraiique*,¹» Baconniere, Paris. NeuchStel, 1950.

for the whole adamic period, we reach the figure of 56 billion human beings, which seems unthinkable.

When we speak of a general resurrection, then, this does not mean the reawakening of every human body which has perished since God made Adam a living soul.

But why did Jesus give no precise answer to this question in his teaching? One explanation could be that during His era and that of the preaching of his Apostles, just as in Old Testament times, the problem of the general Resurrection was of no particular urgency. The great problem, the actual object of Christ's mission, was to open the gate to the *Cycle of the Son*; to help the most evolved part of the human society of that epoch to cross the threshold which materially and spiritually separated the domain of the Father from that of the Son, whose kingdom, as Jesus explicitly said, is not of this world.

We must give this statement its full significance. Let us repeat: Christ's kingdom is opened to man with the second Birth, that of *Individuality* when he has reached the consciousness of his real T and, through his higher centres, has come into contact with the Covenant of Love, that is, with the Great Esoteric Centre, and through that with the Kingdom of God, with the *Deuterocosm* life which is in fact not of this world.

Given the immense problem which faced Christ with His divine mission, it was inappropriate to raise theoretical problems that could only complicate an already difficult task. Above all, it was necessary to avoid offending orthodox Jews by theoretical criticism of ancient texts when Jesus's work was essentially practical in its significance. We find the Master constantly preoccupied with appeasing psychological resistances of the kind demonstrated by St Paul before his conversion. That is why Jesus took care to tell those who felt they were bound by the letter of the Scriptures and by the past that He came, *not to abolish the Law but to accomplish it*.³⁴

(?)

■

In spite of reaching the conclusion that the general resurrection could not be of the bodies of all those who had died during the adamic period, the problem of this resurrection cannot be ignored. The thesis of the resurrection of the flesh is in fact accepted by the Old Testament and upheld by the Gospels. It is an article of the *Creed*, and an object of liturgical prayers in the Canon of Easter.

34. The French is '*milliard*'—the same as a 'US billion'—or one thousand million—so that the total here would be 56,000,000,000.

35. Matthew v: 17,

The question is how to interpret this doctrine in terms of the esoteric Tradition. For it seems a natural culmination to the dramatic evolution of the human species on Earth.

This subject cannot be usefully raised without considering another age old problem, debated for millennia, the problem of reincarnation.

The two questions of resurrection and reincarnation are intimately linked. It is not necessary to return to what was considered in the first volume concerning reincarnation in the true sense of the term and pseudo-reincarnation. Yet we should add the following information.

To admit that man is endowed with an immortal Soul (*Ame*) as well as a body is to admit that this Soul has incarnated. If we consider the Soul to be immortal, it is not illogical to think that this faculty of incarnation can be used by it again, once or many times: we do not see why we should discard the argument of recurrence that is applicable to so many natural phenomena. Once we accept, with all Christian Churches, the principle of the immortality of the Soul, it would be difficult to understand why we have only one single terrestrial life which, in the great majority of cases, simply wanders from one error to another before ending in moral bankruptcy and then physical death. How can we believe in the silence and inaction of this Soul before and after its ephemeral terrestrial life—and this in a Cosmos where everything vibrates in perpetual pulsation, caught up in movement that consciously strains towards a goal? This immobilization of energy, whether it occurs in an empyrean heaven or among the flames of hell, will always appear paradoxical in a Universe where everything is based on the interdependence of the elements and on economy of energy.

We can therefore interpret the indications given in the Tradition in the following way: the general resurrection at the time of the *last Judgement* is not the resumption of a body by billions of Souls, each of which have incarnated only once, *but the incarnation in a single generation of all the Souls attached to our planet*. If we consider that billions of Souls are incarnated and periodically return to Earth, we will see the concept of the general Resurrection in a new light. We should then be capable of understanding, for example, that from the esoteric point of view the progressive growth of the population of the Earth represents a progression towards this general Resurrection. When the billions of Souls attached to the Earth all incarnate at the same time, the era of the Holy Spirit will be finally established. That will be the coming of the celestial Jerusalem, the Kingdom which is not of the 'World' that we know today, the world whose face will pass away,³⁷

M. Cf. Vol. I, pp. 241 ff.

³⁷-1 Cor. vii: 31; also I John iir 17.

One stage will have run its course. From the prediction of a general Resurrection in the Biblical texts, we have moved on to the possibility of individual resurrection during the *Cycle of the Son*. By a continuous process the latter will rapidly extend during the *Cycle of the Holy Spirit* and so become a general Resurrection in which all the adamic humanity of our planet will participate.

In the *Deuteroscosmos* this humanity will have new tasks and a new mission.

CHAPTER V

(*)

The general Resurrection represents adamic man's Accomplishment, a key element in the evolution of the *Tritocosmos*. It must set the seal on the conscious participation of humanity in the development of our *Kay of Creation*, in particular in the Earth's attainment of the level of the *Deuteroscosmos*. These two developments fuse in the notes MI and RE of the *lateral octave*, where man plays the leading role, serving to support the same notes in the *Great Octave*. This is the divine plan if man does not refuse his task, We know what will happen should humanity resign it. The alternative facing us today was described by St Peter in his second epistle, and we have already commented on that text.²

The history of man shows how, while leading man towards the Accomplishment, the divine Power intended to restore him to the level at which Adam was before the fall, although not quite identical as communication with higher planes will now be carried out not in a passive but an active way.

We have already been able to identify three cycles in the period of fourteen thousand years at the beginning of which the reascent of adamic humanity began. The contemporary period marks our entry into a fourth cycle. The compression of Time, to which we have alluded several times, emerges clearly as a decreasing geometrical progression with a 2:1 ratio, which defines the duration of the cycles shown in the following diagram.

This diagram reviews the levels of being of humanity *as a whole* from the fall of Adam and Eve to the moment when, according to St Peter, if man's conscious efforts prove adequate, *the new heaven and the new earth* will appear — *where justice abides*,

1. *Supra*, p. 32.

2. *Supra*, p. 23.

3. *Supra*, p. 8.

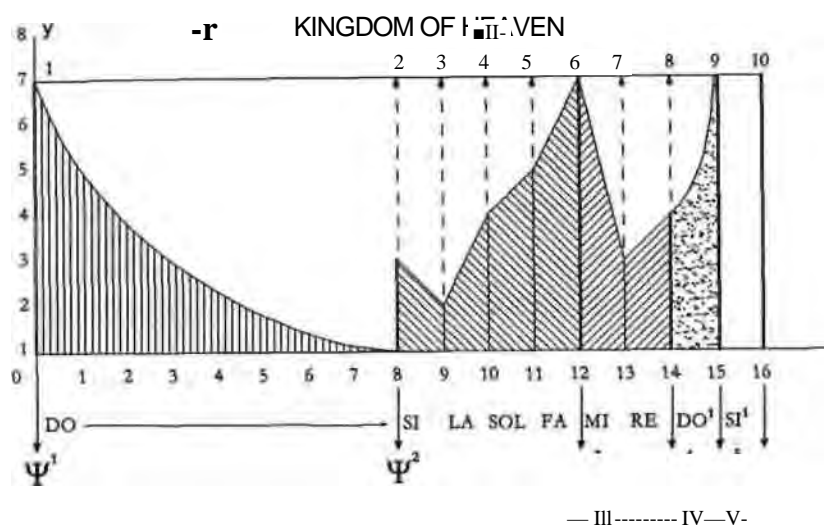

FIG. 2

OX = the scale of Time in 1000 year periods from the fall of Adam until the last judgement; Oy = the scale of Man following his evolution on Earth from one to 7 and from 7 over the third Threshold, T¹ = the fall of Adam, DO, DO¹, SI¹ = a descending scale: the action of God's will to regenerate adamic humanity, T² = The Flood, *F³ = The Destruction of the Temple, *F⁴ = Hiroshima, *P⁵ = The Accomplishment: either the Deluge of Fire or a New Heaven and a New Earth (II Peter iii: 13), Q = The Last Judgement, I. — Prehistoric cycle, II. — Cycle of the Father, III. — Cycle of the Son, IV. — Cycle of the Holy Spirit, V. — 1000 year without war (Revelation jut: 2-4).

About, horizontally:

1. — Adam and Eve,
2. — Noah and Norca,
3. — The Tower of Babel; the confusion of tongues,
4. — Moses,
5. — David,
6. — Jesus,
7. — The schism of the churches,
8. — Beginning of the Atomic Era: the UN, and decolonization,
9. — The return to the rule of the real T: the abolition of Illusion, of False hood and of Bondage. The reign of the Androgyn. 10. — Final separation of the tares from the good seed. (Matthew xiii: 24-30).

On the horizontal or X axis each unit represents a period of a thousand years. On the vertical or Y axis each unit refers to man's level of being according to his degree of esoteric and general evolution.

We should note that this diagram represents not only the three completed cycles but also the fourth, the cycle of the Holy Spirit, with the alternative with which this faces humanity: either to reach the *Accomplishment* or go down in a deluge of fire.

The prehistoric period is characterized by the coexistence of two humanities: pre-adamic, *homo sapiens Jossilis*, and adamic, *homo sapiens recens*. For reasons already expressed,⁴ pre-adamic humanity was not able to evolve like the new type. Mixed unions risked a regression in which the tares would smother the good seed so that the possible growth of the human species would come to a halt. The Flood was a practical suppression of that risk. Animal tendencies had a much less strong hold on *homo sapiens recens*. A new start was possible, traces of it evident in every tradition. Man, son both of Heaven and Earth, could now look up towards his heavenly Father. But this humanity always needed firm guidance. Left to itself, it could only go towards Babel, where the confusion of tongues reigns. The need was for strict directives: a Law. The latter was given to Moses. The covenant of the *Old Testament* was a response to a precise intention of the Creator: to carry out within humanity the selection of a *chosen people* who would then be the beaters of the Good News.

Heaven became accessible again. Man, by his own efforts, could rediscover the path to Paradise; the way so well symbolized by Jacob's ladder. Yet, despite the warnings of the prophets, the chosen people, particularly their ruling class, tended to lose sight of the spirit of the Law and to be attached more and more to its letter. This was a persistence of the primitive idea by which man connects himself to God through ritual.

So St John, speaking of Christ in his Gospel, was able to trace a picture whose tragic character cannot be escaped:

...The light shineth in the darkness; and the darkness comprehended it not.

... the true 'Light which lightsevery man... The Light of the world, and the world had been made by Him, and the world did not know Him, He came to His own, and His own received Him not?

This is the foundation of the tragedy lived out by the Saviour. If the reaction of those around had been different, the Message he brought would have established, at least in part, the reign of justice which King

⁴ *Supra*, p. 8.

⁵ Matthew xiii: 24-30.

■ John i: 5-11. Louis Segond gives: '... and the darkness never received it...'; the Slavonic text says: Be o6Mjiaero which means *understood* in the sense of *embracing, engulfing*. This compares with *« warcAa^cv (sometimes lit. translated as *ovtriook*, but the same root is used in modern Greek to speak of understanding. Ed.) of die Greek tent or the *comprehendtrux*t of the Vulgate.

David celebrated a thousand years before.⁷ The Mystery of the Revelation was in fact received at Golgotha. The victory of Darkness meanwhile was an illusion, since in the Easter Hymn this is still chanted:

Christ is resurrected from the dead
By His death He has overcome Death. ^s

Nevertheless, it was only a divine victory, as man's rejection drove the Light from him. The Cycle of the Son has been marked by a confusion of wars and revolutions, by genocide, by a massive return to primitive paganism, by extreme materialism, by the restoration of the Golden Calf and the degradation of Love, which has too often been reduced to a voluptuous sensuality.

If humanity, especially its esoteric vanguard, its *chosen people*, had not rebelled against the teachings from the divine plane, Christ's Coming would have led to totally different consequences. Under the guidance of the Master, human society could have progressed smoothly towards the end to which the divine Will had predestined it, the eschatological dawn of the invisible Sun which shines in the Cycle of the Holy Spirit.

But this is not the reality. The *chosen people*, often rebelling against their prophets, also proved rebellious to Him that sent them. John the Baptist, the Forerunner, a *Voice crying in the wilderness*, was decapitated, and Jesus was crucified, His Apostles persecuted, and humanity rejected the gift which — at the end of the Cycle of the Father — would have allowed everyone to start on the path of evolution.

We must take care to understand that the significance of this error with its tragic consequences did not lie in the refusal by the Jewish people in itself. Peoples can cease to play a role; they may even disappear, yet the task of humanity remains. The gravity of that resignation was due to the fact that it came from the *chosen people*, the esoteric pioneers who were to lead all the nations on the path which Revelation had traced for them,

On the divine side everything possible was done so that man could hear the call. But he remained deaf. We can measure the force of the catastrophe of Golgotha by sounding¹⁰ those terrible words of Jesus, already quoted in part:

O Jerusalem, Jerusalem, thou that kilhst the prophets, and stonest them which are sent unto thee, how often would I have gathered thy children together, even as a httt gathereth her chicks under her wings, and ye would not.

7. Psalm lxxi (lxxii).

8. A well-known hymn of the Orthodox church. (Ed.)

9. Isaiah xfc 5; Matthew iii: 2; Mirk i: 3; Luke iii: 4; John i: 23.

10. I.e. by speaking them aloud or hearing the full sound of them in our minds. (Ed.)

11. Matthew xxiii: 37; Luke xiii: 34.

Let us examine the possibilities for the Cycle of the Son, which allowed the divine Father to make this offering to man by sending His *beloved Son, in whom He is well-pleased*.¹² Christ's Coming was additional divine help, which filled the interval between FA and MI, This help had become necessary because of man's inadequate efforts and his chronic delay in executing the divine plan. Without this help, the process of filling the interval between FA and MI of the *lateral octave* would have been delayed so long that it would have led to the rupture of our *Ray of Creation* at the same interval. This would have meant the collapse of our world. However, *God so loved the world that he gave his only begotten Son, that whosoever believeth in him should not perish, but have everlasting life. For God sent not his Son into the world to condemn the world; hut that the world through Him might be saved*}³

There was, then, more than a mere promise in the Incarnation. We must fully understand that without this powerful help from above to compensate for human shortcomings, the world in which we live would *no longer exist*. That is the true meaning of *Salvation*, which justifies the words of St Paul that *we are saved only in hope*.^{1*}

According to the divine plan, the two thousand year Cycle of the Son represent the notes MI and RE of the octave. They should have corresponded to two stages of man's further development, that is, to the acquisition of new faculties of psyche and spirit by the most evolved elements, which would afterwards have spread to the whole of mankind. The latter would then be ready for the Accomplishment that would become the DO of the following octave, the thousand year Cycle of the Holy Spirit.

To better grasp the tragedy that resulted from this attitude of man when he was faced with the Mystery of the Incarnation, we must again consider the conditions in which the neophyte can and must pass, one after the other, through the different stages of the Way, which are arranged in a descending octave in which creation is the result of persistent efforts.¹⁵

The symbols, we may remember, were the following. Once having crossed the *first Threshold* the *Faithful* is called upon to climb the *Staircase* of four stages, symbolized by four steps one above the other, When these have all been climbed the neophyte, his Personality completed, will find himself before the *second Threshold*. Here he must himself make an extra effort to pass this new obstacle and enter the *Way*—in the

12. Matthew iii: 17, & John iii: 16-17. «*■ Romans viii: 24. "• a Vol. I. pp. 216 ff.

true sense of the term—where he must pass through the essential stage of his evolution by consolidating his development and pursuing it to its limit.

On the *Staircase*, each step represents one note of the gamut, and each note represents a task that must be fulfilled before growth is achieved. Only the just can accomplish each task fully. Others, the vast majority of those who seek the *Way*, climb the steps without liquidating their karmic tare at each step, so that a remnant of this accumulates. Yet the rule is that when they reach the *second Threshold* they cannot cross it without completely eliminating this tare, since only the pure can cross this *Threshold*. Now, face to face with himself, the disciple, with faith and courage, must vanquish the guardian of the *Threshold*, that is to say, the monster of the Personality he himself created. He must first judge, weigh, and separate the good seed from the tares, so that once his Personality has been purified it can unite with the divine spark, which will then confer its resplendent beauty on him.

On the eve of Christ's Coming, the elite of the chosen people were placed *in corpore*¹⁶ before the *second Threshold*. Their situation was totally analogous to that of the isolated disciple of whom we have just spoken.

The coming of the Forerunner and the Coming of Christ placed the *chosen people*, responsible for the whole of humanity, *face to face with themselves* just as they had become by that epoch, after all their exploits, their faults and their errors. They should have had the courage to accept themselves just as they were, to crush their own pride: to repent, to listen with humility to the Voice crying in the wilderness and courageously obey the teachings of the Saviour.

The *chosen people* did not triumph in this trial. They proved far too weak to admit their own weaknesses and transcend them, They preferred to suppress the testimony and signs from above. King Herod had the head of the Forerunner cut off for the price of a dance, and Caiaphas, the chief Priest, after attempting to exploit the preaching of Jesus for political ends, pronounced the fatal sentence: *consider that it is expedient for us that one man should die for the people and that the whole nation perish not.*¹⁷

W

3

The tasks which awaited humanity in notes MI and RE, tasks whose execution would have led by a normal transition to the DO of the Era of the Holy Spirit, were thus accomplished only in a very incomplete way by the efforts of a few isolated *Individualities*. Today, having come to the end of the Cycle of the Son, humanity is again faced, at the moment when the

16. 'As a body' (Ed.).

17. John xi: 50-51 and also xviii: 14.

irreversible passing of Time has drawn it towards the DO of its octave, with a choice; an *ultimate option*. Either it rapidly liquidates a karmic tare grown heavier during twenty centuries and makes itself the servant of the *Accomplishment* during the Era of the Holy Spirit, or else it repeats the error of the *chosen people* and dooms itself to the fire. This is the choice offered by St Peter in his second epistle. These are the consequences of the catastrophe of Golgotha.

m

To obtain a complete picture of all the implications of the tragedy of Golgotha, we must always remember the inability of *exterior* man to discriminate between 'A' and 'B' influences. He is therefore unable to establish a scale of values which corresponds to Reality. This is the essential reason why humanity is still ruled by the *Law of Accident*.

However, the prophet Isaiah, evoking the image of the Forerunner, had announced what was to be the Mystery of Revelation and its consequences:

A voice crying:
Prepare ye the way of the Eternal in the desert,
Level out the dry places
A highway for our God
For all the valleys shall be lifted up
Every mountain and hill shall be made low
That every hillside will be changed into a plain
And the narrow gorges into little valleys.

This was how the prophet saw humanity's normal evolution during the Cycle of the Son, if the *Voice crying in the wilderness* had been heard: normal evolution because it corresponded to the divine plan. But the active participation of the *chosen people* was indispensable. This evolution was compromised by the resistance of the Sanhedrin, at first passive, then active, leading in the end to the crucifixion of Jesus.

Thus the *chosen people*, instead of crossing the *second Threshold* together as was foreseen, suffered a fall in which the whole of humanity was involved. About forty years after the death of the Saviour the temple of Solomon was destroyed and the diaspora commenced. Due to the fall of its esoteric pathfinders, the whole of humanity was dragged along and has been marking time throughout the Cycle of the Son.

18. Isaiah xl: 3-4. (Slavonic text).

The policy followed by the Sanhedrin clearly illustrates the inner conflict in man, who finds himself at the crossroad where the *Tree of Knowledge of Good and Evil* is found, torn between the attraction of Heaven and that of Earth and almost incapable of fighting the inertia which leads him to choose Illusion and dooms him to obedience to the "*Law of Hazard*."

The Gospels clarify for us the meaning of a drama acted out in the time of and surrounded by a particularly tormented people. Before trying to penetrate the meaning of an event which, from the esoteric point of view, was the most important since the Flood, we must lift into view the thread of events in the New Testament which are explained in purely human terms. It was for purely human motives, which reveal an *exterior* reaction to the Coming of Christ and to His work, that the Sanhedrin demand that the Roman procurator deliver Jesus up to them to be crucified.

We shall first note again the constation of St John the Theologian that spoke of the incarnate Word: *'The Light of the world, and the world had been made by Him, and the world did not know Him. He came to His own, and His own received Him not.'*¹⁹

Who were His own? They formed the spiritual line which, starting from Noah, came via Moses and David to the presumptive heirs of the Tradition assembled in the great sanctuary and presiding over the Sanhedrin. The Sanhedrin's assembly room represented the Alliance of Heaven and Earth: it was in the form of a circle, half fitted into the Temple and the other half outside. The seventy two members of that high Assembly symbolized the seventy two *languages* from the time which followed the Tower of Babel, so that the whole of a divided and dispersed humanity were symbolically assembled there.

We must emphasize that the Saviour's mission could only produce its effects if the *chosen people* adhered completely to His teaching and put its principles to work. Here we touch on the deepest meaning of man's destiny. In the *Accomplishment* he must become a perfect man just as Adam was perfect before the fall, but differently. Adam was in a state of passive communion with the divine plane, Man, having tasted the fruit of knowledge, may not be united to God except by choice, by conscious adhesion to the divine Will through an *Act of Love*. This act was expected from the *chosen people* in the presence of the Mystery of the Incarnation, and should have led humanity into the Way of participation in the divine work. The true destiny of man is based on this need to pass from the passive to the

19. John i: 10-11.

active state. This conversion also marks the passage from mysticism to esotericism.

The *chosen people*, then, should have received the Saviour, recognized him, and accepted him as such.

That is what the Samaritans did, as shown in the Gospel of St John where it refers to the episode of Jacob's well and to Jesus' stay in Samaria.

The Samaritan woman recognized the Messiah in Jesus: *'Come, see a man, which told me all things that I ever did: is not this the Christ?'*²⁰ And at the request of the Samaritans Jesus, accepted as the Messiah, remained in Samaria for two days. There a great multitude believed on Him and said to the Samaritan woman: *'Now we believe, not because of thy saying: for we have heard Him ourselves, and know that this is indeed the Christ, the Saviour of the world.'*

Why did Jesus not remain permanently in Samaria? Why did He not abandon Zion and the vaulting of Solomon's temple to broadcast his message at Mount Garizim in the sanctuary built by the Samaritans? Even more, what was the reason why He never returned to Samaria and also, when he sent his disciples to spread the Good News, why did he command them: *'Go not into the way of the Gentiles and into any city of the Samaritan/ enter ye not: but go rather to the lost sheep of the house of Israel. And as ye go, preach saying, The Kingdom of God is at hand.'*

We must constate that Jesus, abandoning the line of least resistance, deliberately chose to confront the esoteric incomprehension of the Jewish elite even though he knew how difficult this would be, the very minimal chance of success and the great risk to which that choice exposed him.

The text in the Gospel of St John indicates the reasons for this attitude on Jesus' part:

'Woman, said Jesus to the Samaritan woman, believe me, the hour cometh, whenye shall neither in this mountain, nor yet at Jerusalem worship the Father. Ye worship ye know not what; we know what we worship: for salvation is of the Jews.'

The text is clear. As the last words of that quotation clearly indicate, the active participation of the Jews was needed for Jesus' work to yield its full benefits to human society.

It was towards the Jews that he had to go, since, being the *chosen people*, they were the sole trustees of the Covenant with God. Only this attitude of the Saviour would correspond with the plan that He had established and to

20. There appears to be a connection here with the writings of Vladimir Soloviev (Ed.).

21. John iv: 1-12.

22. John iv: 29.

23. John iv: 39,

24. John iv: 42,

25. In the Slavonic text: in the city of the Samaritans.

26. Matthew x: 5-7.

27- John iv: 21-22.

execute which He had come in to the world when humanity had been marking time for more than half a century in front of the interval it had to cross before entering its development phase.

The beauty and the power of the Word — which gives power to those who receive it to become children of God — should have found an echo in the hearts of the doctors and the Pharisees. But they were above all attached to the letter of the Law and their zeal was directed rather to the external practices of their faith.

Are these the characteristics of those who receive the Light, of whom the Apostle said: that they *were born, not of blood, nor of the will of the flesh, nor of the will of man, but of God?*²⁹ It is by the gift of the Spirit, not by the letter, that it is possible to reach the Kingdom of God, to enter the *Covenant of Love*, the Great esoteric Brotherhood, through the second Birth.

Two conditions had to be fulfilled before the *chosen people* could understand the work of Jesus: that they must number among their leaders a few men already started on the *Way*; then that the advice of those men should prevail with the Sanhedrin. Now there were in the Senate a few personalities meeting the first condition: such as Gamaliel, Joseph of Arimathaea, Nicodemus, Simon³¹ and others, yet their views were not adopted. The three years of the Saviour's teaching had provoked various reactions and divisions without any one opinion predominating: *And there was much murmuring among the crowd concerning him: for some said, He is a good man: others said Nay; but others still say, he deceiveth the people.* St John adds: *Howbeit no man spake openly of him for fear of the Jews.*³² Did not Jesus say: *Believe not that I am come to send peace on earth: I came not to send peace, but the sword.*

Meanwhile, one tendency gained more and more favour with the leaders of the Jewish nation. This was based on political considerations. Above all, for Judaea to be freed from the Roman yoke, dissension among the people had to be suppressed. They had to be unanimous when they gathered around the Temple backed by the priesthood, the princes and the scholars. They must unite in the struggle against domination by Gentiles. From the 'worldly' point of view, this was the logical argument.

28. John i: 12.

29. John t: 13.

30. John iii: 3; Romans x: 12.

31. According to the Tradition, Nicodemus and Joseph were Christ's disciples, whom they met while hiding from the Jews, whereas Gamaliel, Saul's [earned rabbi and teacher of the future St Paul, was baptized in secret either by St John or St Peter.

32. John vii: 12-13.

33. Marthew *: 34-35; Lulte xiii 51.

Certainly it is easy so long after the event to condemn the conduct of those responsible for the behaviour of Jewish people, yet we should ask ourselves what attitude these harsh judges would have adopted if they themselves faced the responsibilities faced by the members of the Sanhedrin. The difficulties in maintaining unity were considerable. Some elements favoured compromise with the conqueror—if only Herod the Great had not gone as far as placing the Roman eagle on the portal of the Temple. It was from the point of view of the purely human interests of the Jewish nation, not of the duties of the *chosen people*, that the rulers tended to evaluate the activities of Jesus. He was a prophet, and contributed to the glory of the community. The most spiritualized elements were becoming more and more attached to His doctrine. Yet this would lead to schisms weakening the State of Judaea on the political plane.

On studying the situation it seems that the Sanhedrin decided to use Jesus to head the resistance against the Romans, going as far as to incite the people to make Him king. Yet that plan ran on the rocks. Logically, Jesus then had to be eliminated. For His Kingdom being 'not of this world', He could only be an obstacle to the unity of the nation and to the sacred political aim of the Sanhedrin — the abolition of the Roman yoke. St John reports this attempt to make Jesus the instrument of national policy:

*Those people, when they had seen the miracle that Jesus did, said, This is of a truth that prophet that should come into the world. When Jesus therefore perceived that they would come and take him by force to make him a king, he departed again into a mountain himself alone?**

Jesus therefore refused. Did he not repeat incessantly that His Kingdom was not of this world?

In the Sanhedrin's eyes, He must therefore be removed, since the Senate judged according to this world.

(?)

Although political considerations finally prevailed, they were not the only ones debated. Mystical preoccupations, we could even say *magical*, still existed. The cup overflowed in this sense with the resurrection of Lazarus. St John tells us:

Many of the Jews who had come to Mary, and had seen the things which Jesus did, believed in him. But some of them went their ways to the Pharisees and told them what things Jesus had done.

*Then gathered the chief priests and the Pharisees the Sanhedrin and said: what do we? For this mandoeth many miracles. If we let him thus alone all will believe in him: wdjhe^Kotfigns shall come and destroy both our place and nation. **■ John vi: 14-15.*

That was after the miracle of the loaves.

And one of them named Caiaphas, being the high priest that same year, said unto them, Ye know nothing at all, nor consider that it is expedient for us, that one man should die for the people, and that the whole nation perish not.

St John, talking of Caiaphas, adds the following:

And this spake he not of him self: but being high priest that year, he prophesied that Jesus should die for that nation; and not for that nation only, but that also he should gather together in one the children of God that were scattered abroad.

Here we enter the mystical realm to which we have already alluded.

m

|

What, then, is the exact significance of Caiaphas's sentence: *It is expedient for us that one man should die for the people and that the whole nation perish not?* Did he share the fear expressed by the Sanhedrin of a total extermination of the Jews by the Romans? Certainly not, since he bluntly told the assembly that they did not understand the situation. If he had reached the same conclusions as the majority, it was in fact for totally different reasons. St John said that his answer was inspired. That is what leads us to maintain that it was based on mystical considerations.

Let us place this answer in the general context of the mission of the *chosen people*. Certainly this mission did not simply aim at establishing the superiority of a single nation, nor was it just to maintain the national pride, for *the pride of life is not of the Father*. As we have already seen, the aim was to establish a human nucleus that, by intensive spiritual culture, would prepare the field ready for the Coming of the Lord. This was necessary to allow an esoteric vanguard to cross the *second Threshold* and, as Isaiah prophesied, *to make straight the way* leading to a Christian era for the whole Earth. As one of the initiated, the High Priest could not have ignored the aim of Christ's mission. Yet he would also have known that when their glorious mission was achieved, the *chosen people* would disappear as a national entity, just as the leaven entirely disappears in the dough. This danger definitely existed: the people could have followed Jesus without caring about the purposes of the Sanhedrin. For Caiaphas, that danger was much more real than the Roman danger.

St Paul gives a clear indication of how the Jewish people would have disappeared when he accomplished his task as one of the *chosen people* by passing on to another plane. *In Christ Jesus*, he says, *there is neither Jew nor Greek*. One of the meanings of this sentence is that in a *Christianized*³⁸ humanity the nations, a result of Babel, were called on

35. John xi: 45-52.

36.1 John i: 16. In the King James Bible this is given as: *'For all that is in the world, the lust of the*

to disappear by fusion: the Jewish nation would be first to undergo this loss of identity. History gives us many other testimonies of this prevalence of faith over race. And we know now that those of the *chosen people* who accepted the New Testament and received baptism have disappeared as a national entity. This phenomenon of the assimilation of the Jews by Baptism has continued to the present time. As St John said, Caiaphas must, by inspiration, have been conscious of the inevitable consequences of a massive conversion of his people. He was led to conclude that if baptism threatened the whole nation it was necessary to kill Jesus. That meeting of the Sanhedrin was quite decisive. *From that day*, reports St John, *they resolved to put him to death.*³⁹

These were the considerations which led to the crucifixion of the Saviour. If they differed in their inspiration, they led to the same end. This was to prefer blood to the way of Salvation and to reject, in favour of this world the Kingdom which does not belong to it.

(9)

If the *chosen people* had fused with the nations this would have allowed them to play their role of mystical fecundation in the very heart of them all. From the esoteric point of view, this task represented the summit of the activity of a people dedicated to the service of the Divine.

By refusing baptism, the Jewish people preserved their identity in the face of the 'World', just like the Gentile nations. Yet for this they had to pay a heavy tribute; Caiaphas' calculation proved false. This was because Jesus' warning had not been fully understood even by the sages of Israel: *Have you never read in the scriptures: the stone which the builders refused is become the headstone of the corner.*⁴⁰ *Therefore I say unto you, the Kingdom of God shall be taken from you and given to a nation bringing forth the fruits thereof*⁺

³⁹^ John xi: 53.

*■ Psalms cxvii (cxviii): 22.

+1- Matthew xxJ: 43; Mark xii: 10; Luke xx: 17; Acts iv: 11.

The Jewish people ceased to be first and became last. Vanquished, decimated and dispersed, they became a wandering people who have been persecuted incessantly throughout the twenty centuries of the Cycle of the Son.⁴²

(10)

The choice made by the Sanhedrin prevented the Mystery of Revelation from producing its full effect: to lead humanity across the *frit Threshold* and place it on the Ladder of esoteric evolution. That would have been the way of its Salvation. But it was saved only in hope, as St Paul said.

Meanwhile this hope, a faint echo, represents the confirmation of the Promise. It was a *substitution formula*, the fruit of the terrible sacrifice to which His Love had led Jesus. The threat of *zgeneral Death* was overcome, compensated by the fact that, voluntarily and with love, Jesus had offered himself as a sacrifice for the rebel *chosen people*. This is the true meaning of the Easter hymn, where it is said that by His Death the Saviour has overcome Death.

This is why man can still face with hope the test he must undergo at the beginning of the Cycle of the Holy Spirit.

This test is dreadful because it is *final*. If it is failed there will be no further 'substitution formula'.

That is why we must not think that the analysis presented in this chapter tends to judge either the *chosen people* or their leaders; they will be judged by Moses, just as Jesus said.

The great question today is to know whether we are capable of learning the lesson from that precedent.

42. This voluntary passage from Earth's plane to a higher plane, refused by the mass of people, can always be (and is) carried out by individuals. The consequences are the same; on the terrestrial plane there was the loss of Jewish identity by the baptized, who fuse with the group in which they live. On the spiritual plane, it seems that these conversions have kept an extraordinary force of radiance in many cases, a reflection of that force which would have come from the adhesion of the *choitit peopk* to the New Testament.

43. John v: 45.

CHAPTER VI

(V)

If there are still grounds for hope, is it not possible to determine the conditions for realizing our hope?

In the first epistle to the Corinthians, St Paul indicates the *best Way* and the *best gifts: Faith, Hope and love*

(2)

The path that human beings and, finally, adamic humanity as a whole must follow on this Earth, is that which leads from the Love of the Absolute III, *that residue of celestial Love*, to the Love of the Absolute II.⁴ This is the general requirement for Salvation.

This concerns the *Way* which leads to the resurrection⁵ or second Birth. But to be reborn the final test that man must pass is that of true Love.⁶ Only he who has mastered his Personality and burns with this Love can cross the *second Threshold*. And before he reaches this point the *faithful*, upheld by the ardent desire for Salvation, must pass through the intermediate stages. He must give proof of his Faith, then of Strength nourished by Hope. Before he attains Love, the novice must first acquire Discernment, and he cannot do this without having attained Knowledge. It is to this *gnosis* that St Paul refers when he describes the process in which each stage envelops and absorbs the stage or stages which precede it, and when he specifies that the passage from Hope to Love is marked by the renewal of the mind (*intelligence*)? that is to say, by Knowledge.⁸

This stage *oi~gnosis* would have been fully attained today, at the end of the Cycle of the Son, if Christ's mission, as it was first conceived and without the substitution formula, had not failed for the reasons explained in the previous chapter.

1- I Corinthians xii: 31 and xiii: 13.

2. The word '*debris*' is used colloq. in French to describe people who are 'old and past it'. (Ed.)

3- The expression is used in the *Pbibkaia*.

⁴. *Supra*, p. 25.

5. *Supra*, p. 44

6-Cf. Vol.1, pp. 231-232.

* Romans xii: 2 and Ephesians iv: 23. (Intelligence here renders the Greek '*vo£\$*' used in both texts—Ed.)

» I Cor^oth' am xiii: 2 (Gr: '*yv&aiv'* -*gnorin*) and 9 (Gr: '*yy/iiQKay.t^* -*gitoskomin*) and xiv: 6 (Gr: '*yraiOiv'* - *gitalin* again).

(V)

Jesus' message had been timed for the beginning of the Cycle to which it was adapted. The Old Testament only spoke of Hope in terms of the Mystery of the Promise, revealed only to the initiated. Jesus, repeating the words of the Forerunner, announced the approach of the Kingdom of Heaven and addressed the *Gospel of the Kingdom* to the whole world.

The spread of the Word had the aim of facilitating the selection of *interior*¹ men, to whom it was said; *to you it is given to know the mystery of the kingdom of God, but for the others, the exterior men, all is in parables*. These *interior* men were to open the ways of the New Era. It is certainly true that the *exterior* men did not grasp the profound meaning of the parables Jesus propounded to them and that, *loving the praise*¹ *of men more than the praise of God*,¹⁴ they prevailed over the small nucleus of the new elite.

The hostility of the public authorities forced the Apostles and disciples to make unheard-of sacrifices, which they willingly accepted following in the steps of their Master, and at this cost the Word was propagated so that *the darkness was not able to engulf it*^h But the obstacles and delays to the spread of the Message created a particularly dangerous situation for humanity, because all that must be accomplished by terrestrial man in the Universe must be done within a specific time-limit. The irreversibility of Time applies even in the esoteric domain.

Instead of marching on from one spiritual victory to another on the way mapped out by Jesus, humanity underwent a fall. It became the victim of lower types of human mentality: of the calculation and (self-)interest which it eventually placed at the top of the scale of human values. Thus the gulf between moral and material progress gradually widened, a gulf which was to become a grave obstacle to the practical application of the Gospel principles.

(*)

We can judge the greatness of the divine Love in reminding ourselves that *it is not the will of the Father ... that one of these little ones should perish*. This divine pardon extends even to crime. Cain, who in the Bible

9. Matthew iii: 2.

10. Matthew xxiv: 14, in Greek: *tiayyt'Xioy TTJS fiaaiXtlat*.

11. Romans vii: 22, ('Interior men' tends the Greek: *low avBptunov*, (Ed,))

12. Mark iv: 11. This translation is from the Slavonic text. (Here the Greek has *TOIS i(ai, 'those outside')*).

13. Ed. — Gr. &6(av).

14. John xii: 43 (Fr. 'gfaire').

15. John i: 5.

16. Matthew xviii: 14.

symbolizes the first murderer and the first fratricide, was marked with a *sign of the Eternal lest any finding him should kill him*, and it was added: *and whosoever slayeth Cain, vengeance shall be taken on him sevenfold*¹

All this happened after the first fall, that of Adam and Eve. Subsequently, before the Saviour came, divine Grace—symbolized by the Covenant with the *chosen people*—gave humanity the opportunity to escape perdition many times.

Yet the second fall, as we have already seen, was much more serious than the first. The Cycle of the Son, which should have been the Cycle of triumph for man, became a Cycle of Repentance. Yet even in this form it remains marked by divine Grace which, in Christ's own words, pardons sin and blasphemy against the Father and the Son.

There is only one sin which will not be forgiven, *neither in this world neither in the world to come: it is blasphemy against the Holy Spirit*.¹⁹ In our times, this warning acquires a burning immediacy and we must pause to consider it attentively. If we glance backwards we will see that at the end of the Cycle of the Father, man had not redeemed the consequences of the first fall to the required measure, since the Son of Man came to save *that which was lost*. It is only too evident that the Cycle of the Son has not been a Christian cycle: the basic principles of Christianity: the love of God and the love of God in man, including our enemies, have never been applied except in a very limited way. This cycle is a tragic testimony of the unequal struggle in each of us between light and darkness. Yet with the passage of time, cycle by cycle, the degree of truth demanded of man continues to increase. We will soon return to this point. But even now we should ask the question: is humanity ready to face the passage to the Cycle of the Holy Spirit? Is there a ruling class and an elite—the distinction is essential — capable of leading it through this passage?

This is an agonizing question for all who are conscious of its urgency. Many of us can feel its urgency yet prefer to turn back towards the past. Basing our judgement on what has gone before, we continue to count on the forbearance God showed us on the occasion of the two previous falls. This is an error. Humanity has exhausted its credit. Its actions today must fulfil divine expectations.²¹

17. Genesis iv: 15. Quoted according to the Slavonic text,

18. Matthew xii: 31.

19. Matthew xxi: 32.

20. Matthew xviii: 11.

21. CF. Vol. I, pp. 191 & 229-230 and Vol. II, Chapter IV, section 4.

(V)

Humanity—as we have repeatedly emphasized—is today at the threshold of the Cycle of the Holy Spirit, just as two thousand years ago it stood on the threshold of the Cycle of the Son. More precisely, there is an analogy between the present era and that of the Forerunner. That is why it is important to examine the reasons that prevented John the Baptist from fulfilling his task. That task was to *make strait the ways of the Lord*, to prepare the Jewish society and people to receive the Gospel of the Kingdom. The captivity and death of John the Baptist, charged with this preparatory mission, increased the difficulties of Jesus' mission.

The atmosphere in which the Forerunner had begun his work was not unfavourable. Herod's dynasty was not imbued with the spirit of Jewish conservatism. Its members had been converted to Judaism but because of their Idumean origins they kept some independence from their milieu. This position particularly explains the policy that they followed towards the Sanhedrin on the one hand and the Roman authorities on the other.

Now Herod Antipas, who reigned at the time of Forerunner's ministry was well disposed towards John the Baptist, whom he took for a just and saintly man.

But Saint John found fault in him for his marriage to Herodias, his niece, the former wife of Herod-Philip, his brother. Herodias first managed to bring about John the Baptist's arrest, then his execution.

From the point of view of esoteric work it is important, as far as the scriptures permit, to analyse the causes of the Forerunner's elimination, Did Herodias act on her own behalf, for revenge, or was she an instrument of powers of darkness who used her for their own ends? And were not these powers already at work when Herod the Great tried to eliminate the infant Jesus by ordering the massacre of the innocents? We can say that the birth of the King of the Jews foretold by the Magi did not represent a personal threat to Herod, but a danger that existed in the far future. After a troubled reign, Herod the Great had by then reached the age of seventy two years" and would die one year after Christ's birth. Nevertheless, St Matthew tells us that he had been disturbed—and all Jerusalem with him. In fact, the king did not take his decision until he had *gathered all the high priests and scribes of the people*.

Certainly the work of preparation now takes a form that differs greatly from that which it assumed in the time of John the Baptist. Yet hostile

22. Matthew iii: i.

23. Idumaea was the Greek name for the land that in the Bible is named Edom. (Ed.)

24. Herod the Great, called the Ascalonite, son of Antipater, prime minister of Hyrcan II, last of the Macchabees, was born in 72 BC.

25. Matthew ii: 1-4.

powers can emerge at any moment. It is essential that all those who are preoccupied with the evolution of humanity, in the esoteric meaning of the word evolution, be vigilant. For it is from amongst them that the new elite must be recruited, collectively able to play a preparatory role analogous to that of the Forerunner. They must therefore watch to frustrate the actions of those who, consciously or unconsciously, serve the forces which wish to set back the progress of man. The Scriptures draw our attention to the need for such vigilance. We will have noticed that the Gospels of St Matthew and St Mark relate with precision the circumstances which led to the execution of John the Baptist. No detail in these reports is superfluous. Every detail is meant to show the powerful effects that human passions can have on esoteric work, and show how hidden forces know how to use, for their own ends, the full keyboard from the ambition of a Herodias to the charm of a Salome and the concupiscence she awakens. These texts are simultaneously a tale, a teaching, and a warning that we cannot afford to neglect.

(6)

John the Baptist was due to announce the approach of the Kingdom of Heaven, a new notion for the majority of people. Today it is no longer a question of opening up the ways to Hope, but to ensure the passage to the reign of Love and Truth. The Cycle of the Holy Spirit will be that of the Kingdom of God; otherwise, according to the prophecy of St Peter, Fire will be the penalty for humanity's refusal.

Now, according to Origen, if every thing that exists proceeds from the Father and is part of Him, and if everything that is endowed with reason participates in the Son, it is only the *saints*, in the meaning given by the early Church, who participate in the Holy Spirit. This is equivalent to saying that in the next Cycle *exterior* man must lose the preeminence he has held until today in favour of *interior* man.

In addition, the Holy Spirit being the spirit of Truth, the next Cycle will be characterized by the elimination of the lies which until now have kept their hold over man. ⁷ To free himself from that slavery in which the *exterior* man lives is a difficult task for him as he has not recovered from the first or second fall. Dominated by the A' influences, which he obstinately takes for Reality, he confuses the T of his Personality with his real J ■ The Personality, which in fact clings to the T of the body, is most often ruled by the latter, particularly in the sexual domain. Those who must lead others do not generally escape from the rule of subjection to an undeve-

26. *De Prindpii, passim*.

27- Cf. Vol. I, Chapter XVII.

loped Personality. That is why one of the most urgent tasks is the formation of an elite capable of overturning the false scale of values established by the deified Personality.

On the other hand we must note that humanity today is in a situation even more critical than on the eve of the first or second fall. We have already specified that a decisive test awaits: the complete elimination of lying. The Era of the Holy Spirit excludes all compromise with Anti-Truth. Lying, in any form whatever, would be an unforgivable blasphemy which would automatically bring about a third fall. The outcome would be fatal, as already indicated in our analysis of the second epistle of the Apostle Peter, of which the following verse should be quoted once again:

The day of the hard will come as a thief in the night; in which the heavens shall pass away with a great noise, and the elements shall melt with fervent heat, the earth also and the works that are therein shall be burned up.

We will still have reason for hope only if the forerunners of the coming Era are in a position to accomplish their work. As we said, the danger is greater today than it was on the eve of the second fall; on the other hand, the risks of a check to the forerunners seem to be less than those that threatened John the Baptist, for he had to fulfil his task alone. Today the work of the forerunners is a collective work, and this very fact allows us to think that it might lead to a successful outcome. But we cannot deny that it will be an arduous task. It must be carried out in a milieu where conditions are, so to say, inverted with regard to what they were at the time of the first Coming: the *chosen people* then refused to render unto Gesar what they thought belonged to God. Today, man does not want to render unto God what he thinks belongs to the Caesar of our times, that is to say, to the deified human Personality. The deification of the Personality has acquired, one might also say, a universal character that is still more dangerous in its unacknowledged forms. Whether they belong to the capitalist or communist world, people today are unanimous in glorifying the human Personality. This is the major obstacle that the forerunners of today must surmount.

28. Certain individuals may recall in earlier years the use of the principle: *'No compromise m& Truth: (Ed.)*.

29. Cf. *Supra*, p. 23.

30. II Peter iii: 10.

According to St Paul, before reaching the stage of Love, the very nature of the Cycle of the Holy Spirit, Faith, the essence of the Cycle of the Father, and Hope, the sign of the Cycle of the Son, must dissolve in *gnosis*, in Knowledge (*Connaissance*): the gateway to Love. Knowledge reestablishes the true scale of values, and the result is that it subordinates the Personality to the real T.

At the same time, the acquisition of Knowledge is not without danger. It can make pride swell in the feeble heart of man, and this pride makes all esoteric evolution impossible. The track leading to Knowledge is narrow and runs along a precipice. Only Personalities magnetized by a sufficiently developed *magnetic centre* can start forward on this way without great risk, because here the law expressed by Jesus applies in its full force: *For he that hath, to him shall be given: and he that hath not, from him shall be taken even that which he hath.*²

Knowledge is only a temporary or intermediate stage: it cannot be deified. Only Love reveals the divine nature: it springs from God, for God is Love. *Gnosis* is an outer staircase that leads the faithful to Christ's Palace: to the Kingdom of God. In that sense, it is the Forerunner-Spirit which presides over the esoteric work of the faithful, the work which must open the gates to the Era of the Holy Spirit just as John the Baptist's work should have made strait the ways leading to Cycle of the Son.

These efforts accomplished under the sign of Knowledge must fulfil two essential conditions.

The first is that they must be correctly oriented. For this esoteric work must lead to a liberation from lying. Without this there is no possible access to the Era of the Holy Spirit. The forerunners should not fail in that area, where the rule formulated by Jesus is applied in all its severity: *whoever puts his hand to the plough and looks back is not fit for the kingdom of God.*⁴ If this condition is not fulfilled, if the forerunners allow themselves once again to be attracted by the illusions of the 'World' and the Personality, they would not be true precursors, and their efforts would necessarily be doomed to failure.

The second condition is that the preparatory work must be fertilized by the gifts of Faith and Hope so that it can develop to the accomplishment of Knowledge. It is easy to understand that Faith and Hope must animate those who now devote themselves to or will devote themselves to this

31. Cf. also Vol. I, Author's Introduction.

32. Matthew xii: 12, 25, 29; Mark iv: 25; Luke viii: 18-19, 26.

33.1 John iv: 7-8.

34. Luke ix: 62.

work of preparation. But for their work to be crowned with success within the *allotted time*, each of these workers and all of them together must be impregnated with Hope and burning with Love. Only in such a state is it possible for them to come to this Knowledge (*Connaisance*) and to give it the disinterested character which opens the ways of Love as it expresses Itself on a higher plane. For Faith and Hope are the first fruits and qualities of Love, which *believeth all things and hopeth all things*,

In the third part of this Volume we shall specify exactly the esoteric meaning of both these words, Faith and Hope, in their positive aspect. From a negative point of view the absence of faith generates suspicion and cuts off any zeal; while a lack of hope chains us to the present and prevents any expansion of thought and heart.

A lack of Faith among the ruling class of the *chosen people* led to the failure of both John and Jesus. Their sufferings, and the martyrdom of the saints and apostles were needed to surmount this failure.⁶ In their sacrifice they were moved by the Hope that men were not ail bad, and that the seed could *fall on good earth* and so bring forth much fruit.³⁷ Today, a lack of both Faith and Hope would provoke the third fall: for the fullness of Hope must be accomplished at the moment when the Cycle of the Son comes to its end.

This means that the fullness of Faith and Hope must be realized by those who prepare the ways for the Era of the Holy Spirit. By living out this fullness, each forerunner must clothe it within himself with a Knowledge which would allow him to enter into the Kingdom of Heaven even while being begotten by it.

W

We may hope that this development of Knowledge, if it occurs, will pass beyond limited esoteric circles and have an influence on man's major decisions, decisions oriented toward cosmic interests. To be more exact, let us say that esoteric work tends to facilitate the task of humanity in two essential aspects: in the first place, the *Accomplishment* in the Cycle of the Holy Spirit, by attaining the deuterocosmic form of Love; in the second place, the conscious participation of humanity — it first limited to an elite but then extended to everyone — in developing the *Way of Creation*.

The divine action favours the attainment of these aims: it works in the depths at certain points from which it radiates to reach the whole of

35. I Corinthians xiii: 7.

36. I Corinthians vi: 20.

37. John xii: 24; Matthew xiii: 8; Mark iv: 8.

38. See I Corinthians iv: IS.

humanity. For this it uses Revelation, which gives man the possibility of penetrating further and further into himself, towards the Real, by developing his Personality to the second Birth. History testifies that the Word is spread by the mediation of those who have reached the level of *interior* man. From Palestine, the Gospel spread to the Greek world, to Asia Minor, then to the Gentiles of the Roman Empire and through them to Europe and North Africa. No matter what judgement we may bring on the hegemony of Europe during recent centuries, the expansion which accompanied it has allowed Christ's message to be spread over all the earth, The techniques it has introduced or developed have realized many of the conditions necessary for the Accomplishment, such as the newborn planetary consciousness, the growth of population, etc. The Divinity uses man's ambitions and passions for His own aims, but the realization of His ends often seems to be merely a *by-product* of the most un-idealistic human actions.

Yet once they cease to be useful in one way or other to divine ends, human actions lose their *raison d'etre*. It is in this way that the European hegemony has lost all meaning in our century. But before falling into Lethe it has begotten those international institutions which contain the germs of the organisms that must gradually lead humanity to full consciousness of its unity, and so enable it to endow itself with institudons that conform to this notion.

(10)

We must again emphasize the fact that the passage to the Cycle of the Holy Spirit cannot be realized unless the interval between FA and MI of our *Kay of Creation* has been almost filled, and unless notes MI and RE of both the *Great Octave* and the *lateral octave* resonate together. The crossing of the interval between FA and MI in the former is realized, as we have already seen, by the development of *organic life on Earth*, particularly of its note LA. But man's efforts have created an unbalance at that level: technical progress and the rapid development of population have enormously accentuated the biological and material elements in the bundle³⁹ of influences emitted, at the expense of the energies of the psyche, and even more of the spiritual energies. This bundle is thus incomplete, and the delay in the domains of Faith and Hope urgently demands the formation and then the action of the Forerunners, On the value of their work and on their access to Knowledge (*Connaisance*), depends the fate of humanity and of our *Ray of Creation*,

[■ The French *ixoidfiiixtsu* — translated 'btiiuiU'—is taken from the Latin *facinut*, the bundle rods carried by the Lictors to signify their power of punishment. (Ed.)

We must add a few words on the conditions in which this work should be carried out. Esoteric action occurs not in a void, but in a context where the attitude of the public authorities, in the widest sense of this term, plays a decisive role. We have already seen this when discussing Christ's mission. The nucleus who wanted to follow him could not overcome the resistance, the hostility of the forces that invoked traditions established by man, nor the call of the blood. A similar situation could well happen again. The time in which we live is a time of transition, highly unstable, which tends to break with the imperatives of the past on political, economical and social planes, but has neither adopted nor even discovered those of the century to come.

All today's problems are on a planetary scale. There is no human action at any point of the globe, that does not have world-wide repercussions. Things that only recently would have been considered as a serious attitude in political or social domains now seem to be dangerously frivolous. In relations between peoples, it has become criminal — the word is not too strong — to use formulae that were appropriate during the Cycle of the Father or even that of the Son. To continue obstinately in this way would lead humanity to the third fall with its disastrous consequences.

The responsibility of those in public authority is great since, as in Jesus' time, their attitude will be decisive. When the day of the Lord will come as a thief in the night, the intermediate period in which we live will come to an end and we will have to choose. For the time being we can only say that the great controversies of our time, whether in political, economic or social realms, are imperceptibly losing their significance. These are already the quarrels of the *old order*, the notions of 'right' and 'left', of capitalism and communism, are already outmoded in principle. Soon they will be History.

We cannot predict what decision will be taken by the men in office at that dreadful hour. But that decision cannot ensure the salvation of humanity unless those responsible are at that moment conscious of the cosmic role the human being is called upon to play in the divine plan.

(1)

Today, mankind can no longer evade the issue. Saved in hope by the ineffable sacrifice of Him whom it crucified and continues to crucify, it has already received in abundance all the divine grace which could be given it, as everything in the Universe has its limits, determined by the *principle of Equilibrium*. The refusal to receive the Life¹ which is Light, and the twenty centuries of anarchy resulting from that refusal, have led humanity to the point where it can no longer hesitate. It was able to reject a Christ whose first Advent represented an intermediate stage, yet it cannot reject the Holy Spirit, nor the second Coming, for that would be to refuse the Accomplishment.

So we are now facing a final settlement of terrestrial man's fate. And since, in the process of creation, man represents an essential factor in the expansion of the Ray which terminates in the Earth and the Moon, his fate has inevitable repercussions on the life — organic or otherwise — of our planet and its satellite. Despite his extremely small size in personal terms, man is located at a particularly important point in the scale of cosmic values — at what we could call a major turning point — as shown on the following page²:

This position of man is a result of his double nature: through his higher centres he has a divine spark within him; through his lower centres he is attached to the earth; he thus forms a *link* in our *Kay of Creation* between the Kingdom of Heaven, represented in the figure by the uppermost 'squares', and the Kingdom below, shown by the lowest squares.

These observations will allow us to understand better why his development so closely governs the expansion of the *Kay of Creation*. Entry into the Cycle of the Holy Spirit should not have led to a crisis like the one we are witnessing today, because the passage from RE to DO does not involve the crossing of any interval. This crisis is the result of the fact that, although Time has brought humanity today to face tasks linked to the

!• John i: 4.

In the search of the Miraculous' *Fragment: of an Unknown Teaching* (Rou-UeQEe & KeganPaul, 1950) we will find a similar drawing (p. 323) which contains several errors. Most important is the place of man in that diagram, which in fact contradicts the theme of man's nullity — it would have been better to say his infinite smallness — that is expressed throughout that book, a theme which is fully in agreement with the Doctrine. (Cf. Foreword in the first volume of Gnosis.) We note that the nullity or at most the negligible importance of exterior man, who dings 10 his list! of being is not incompatible with the relatively important role which can be entrusted to mankind on the functional plane, that of the functioning of the *Kay of Creation*.

40. Cf. Paul Vslery, *Regirdr sur It monde actttet*.

GOD

ARCH-
ANGEL

		SUPER- MAN	SAINT	ANG]
		MAN		
MINERAL	PLANT	ANIMAL		
METAL	FIG. 3			
STONE				

resonance of the note DO,³ as a whole it still remains in an unstable position, suspended between the notes FA and MI because it has only partially crossed the interval, although the Mystery of the Revelation should have led it all the way across.

3. *Supra*, p. 48, figure 2.

In the diagram, man represents a man who has not evolved esoterically, a man living by the functioning of his underdeveloped lower centres, man 1, 2 or 3; *exterior man*.

Evolution, always taken in the esoteric meaning of the term, must (first) make a *superman* of him, then a *Christian*, then a *saint*... in the accepted meaning the early Church gave to those words. In the diagram, the difficulty of passing to the *evolved* state is symbolized by the fact that the *superman* is placed vertically above man: this passage represents an *ascent* which in another diagram is represented by a *Staircase*.⁴ The line that separates man from *superman* is the *second Threshold*, and man 4 is placed in contact with it. The square marked *superman* is reserved for men 5 and 6. We shall measure the magnitude of the work this evolution requires by remembering that the disciple who has reached that level of being is not yet immune from falling, as shown by the example of the denial of St Peter. But such a fall is usually a temporary deviation, and the being who has reached this degree of evolution will sooner or later find the *Way* again. The more he has already progressed on the path, the less prolonged will be the consequences of a fall. The latter is to be feared above all immediately after the passage of the *second Threshold*, if the man does not keep watch but lets himself be overcome by self satisfaction. He still does not possess *Consciousness*, the characteristic of man 6, nor above all *Witt*, proper to man 7. Only the latter, having received the baptism of the Holy Spirit, having become a *saint*, *perfect* in the terminology of St Paul, is entirely sheltered from straying, for the will he receives has an absolute character.

We will note that in the diagram *superman* and *saint* are placed on the same horizontal branch: this signifies that the transition from one state to the other is not carried out by an ascent, by growth, as in the case of passage from the state of *exterior man* (1,2,3) to that of the balanced man (4), but by development.

4. Cf. Volume I, p. 216.

5. Certain texts from the first centuries of our era give a wider meaning to the word *saw/*, applying it to all those who have crossed the *second Threshold*: in this broader conception, the *saint* himself is able to stray. Also in the *Dtdache*, an arrangement placed between years ³⁰ and GO of our era (Cf. *La Doctrine des dou'e apotres*, Paris, Auguste Picard, 1926, Introduction P. xxxiv), we read the following verse at the end of the prayer which follows the Love-Feast (*»d., X: 6, p. 21):

*Let tht grate come and this world pass away
Hesania to the Cod of David
If anybody is a saint agbios in the Greek text) let htm come.
If ht is not a saint, let him make eeitance
Maran Atha
Amen.*

Only these men — evolved, in the esoteric sense — can make it possible for humanity to compensate for the consequences of the delay on the moral plane and so avoid the deluge of Fire and enter the Era of Accomplishment. In the same way, the members of the Sanhedrin could have ensured that the whole of humanity would pass onto the stage of development at the beginning of the Cycle of the Son.

(3)

These considerations should not make us too pessimistic. Without daring to say that the danger is remote, we can constate that the situation is better than it was at the end of the second world war. We are still in the midst of the tempest, yet a few gleams of light are breaking through the clouds to light up the obscurity.

If modern man is sunk in darkness because he has neglected the cultivation of his Personality, if he has the imprudence to taste all the fruits of the *Tree of Knowledgeoj'Goodand'Evil*, by the constancy of his intellectual efforts he has at least achieved the most spectacular progress in technology. Contrary to the opinion of certain philosophers, religious and lay, because it provides man with more resources which can eliminate many recurrent problems on the material plane, this progress can help the harmonious development of man intended to occur in Cycle of the Holy Spirit.

m

But *material progress* must be considered as a means and not an end. It must not go beyond its role, which is to support moral progress in ways appropriate to it. It is only by meeting this condition imposed by Divinity that man, fleeing from the curse pronounced at the time of the fall of Adam and Eve,⁶ will be free to employ his talents⁷ working for the Accomplishment, instead of simply wasting them.

We have repeatedly emphasized the fact that the moat between science and religion is the main obstacle to the achievement of this aim. It is mainly to this that we must attribute the gulf which today separates man's material condition from his moral state. Yet the idea that the isolation of science has been the condition of its success, and that material progress remains linked to the preservation of working methods which must be completely different for scientific disciplines than for those proceeding from Revelation, remains fixed in every mind, at least in the West. For the Westerner there is almost no doubt that the scientist has nothing to learn from Revelation and

6. Genesis iii: 19.

7. Matthew xxv: 25.

that the traditional sciences by their very nature would give his researches a dangerous orientation,

There is certainly nothing new in man substituting a tradition of his own for the Tradition that has a divine origin ... and then becoming enslaved by his own invention. Jesus reproached the *chosen people* of having emptied the divine word of its essence of which they were the trustees and replacing it with rituals and human verbosity,⁸ For it is a fact that human traditions create true conditioned reflexes which then prevent the exertion of the critical mind necessary for adaptation to circumstance.

The apostle Peter analyses this problem in the second chapter of his second Epistle: he tells how when those who had *eyes to see and ears to hear* crossed the *threshold* which separates the Cycle of the Father from Cycle of the Son, false doctors, obsessed by the past, were somerimes able to lead them back to the ancient beliefs. St Peter tells us concerning those doctors:

They are wells without water, clouds carried away by a whirlwind; the fog of darkness is reserved for them. By speeches swollen with vanity, they allure through the lusts of the flesh, through much wantonness, those who were clean escaped from them who live in error: While they promise them liberty, they themselves are the slaves of corruption: for each is a slave of what has overcome him.

For if, after they have escaped the pollutions of the world through the knowledge¹⁰ of the Lord and Saviour Jesus Christ, they are again entangled therein and overcome, the latter state is worse than the beginning. For it had been better for them not to have known the way of righteousness, than, after they have known it, to turn from the holy commandment delivered unto them.

But it is happened unto them according to the true proverb, The dog is turned to his own vomit again; and the sow that was washed to her wallowing in the mire.¹¹

v

The establishment of *human traditions* of this kind leads to true crystallization of thought. We can constate this again in our own times, and the danger is considerable whenever Statesmen endorse them. The appeals which such men project invoke *human traditions* whose contents have Quired the power of an axiom for the collectivity to which they are 8. Mark vii: 13.

9- Matthew xi, 15 and xiti: 9, 45; Mark iv: 9; Luke *iv: 35. 10. Gr. *epigmsis*, recognition (Ed.). U- II Peter ii: 17-22. (Slightly paraphrased with reference to the Greek. Ed.)

addressed—so that they are always accepted. Today we again find reflexes manifesting that have been created in this way. Certain aspects of this question were examined in another work more than ten years ago.

From the point of view that concerns us, we cannot afford to neglect this force from the past as a cause of inertia. It not only forms a permanent risk of conflict but, since it has already created obstacles to the possible effects of the Mystery of Revelation, it is also one of the major barriers obstructing the way to the esoteric evolution of humanity. By leading to inaction, it hinders the broadening of our *scale of values*, which is a necessary condition for human evolution. Meanwhile, we must not lose sight of the forces which, consciously or unconsciously, work to oppose the formation of a planetary *mind {esprit}* in man. These tendencies are betrayed by those crises in the course of which humanity as a whole has until now paid dearly for its passage to broadened states of *collective consciousness*. If there was not in man this state of confusion between values, this broadening of consciousness would have been continuous. But the passage from clan or tribe to nation has required a series of convulsions. Survivals of tribal consciousness, when they have manifested in certain Statesmen, have led to catastrophes right up to modern times. The example of Charles XII of Sweden is typical in that way. That medieval knight, *iron bead*, as the Turks called him, belonged to an earlier age in contrast to Peter the Great, pioneer of the renaissance of Russia and therefore of the entire Orient. We can also attribute the origins of the second world war to an eruption of tribal mentality,

We must stress that the concept of the national entity is itself recent. It crystallized at the time of the French Revolution, which crushed the autonomy of the provinces to establish the *one and indivisible Republic*. Since then, vendettas between clan and clan or province and province have seemed odious. Yet vendetta remains the same whatever its boundaries, and nationalism in no way changes it by extending its borders to the dimensions of a country. But to shed one's own blood or that of the enemy for the glory of one's country is always considered to be the sacred duty of all loyal citizens, and the majority consider that to refuse to do so is supreme cowardice.

m

The need to pass to the new Cycle now requires of man, and particularly of Statesmen, a *collective consciousness* which extends far beyond the boundaries of nations or States. In the domain of public affairs what from the viewpoint of the Personality's level of consciousness seemed normal or

12. Cf. *Le probUmt it Vatttaritt sttpr-ttatiqttt*, op. cit., *passim*.

even laudable during the XIXth century, is blameworthy today. Tomorrow it could be catastrophic. As we have seen, the widening gap between the technical and moral abilities of contemporary man is the major obstacle to the broadening of our *collective consciousness*. This first demands victory over that mechanical behaviour which teaches what we call the lessons of the past. To produce its full effect, this victory also requires that certain understanding of human relations taught by the Saviour. It is not enough to know (*savoir*) that these relations must be formed on new bases; this must also be understood and lived by conscious effort.

It is reassuring to constate that humanity is pushed towards that broadening of its *collective consciousness*, towards unity, through technical progress. We have already indicated that this unity of the world is being realized under our eyes, but not as the result of human efforts consciously directed towards that end. It appears, one might say, as a *by-product* of the activity exerted by man when he empirically follows that ill-defined aim: *Progress*. By that term we most generally understand *material progress*. Man eagerly devotes his labours to this end and applies almost all the forces of his intelligence to it, Public education is essentially directed towards this one end, and political aims, together with the rationalization of the economy in all its forms and the organization of the armed forces, all aim at immediate profit and *comfort*. Yet — and we see there a gentle aspect of divine irony — without being conscious of it, man forges the substance from which the world must be built anew.

Greed is not the only factor which unconsciously incites man to create the conditions necessary for the establishment of the era of the Holy Spirit. The spirit of domination and fear also contribute indirectly. The perfection of the engines of destruction that they have helped to create has turned against their authors —leaving them no further possibility of drawing any profit from them. In an atomic war there would be no great difference between victor and vanquished. Ashes leave no place for victory. 'War', said Clausewitz, 'is politics continued with different tools.' That formula has lost its meaning today. Force is paralysed by the excessive power now available to it. The reduction of war to absurdity helps to ensure peace. The facts of the international situation are thus totally changed, and principles which only yesterday seemed axiomatic are now out of date. The maxim by which *every international treaty is only an expression of the relation between the forces in confrontation* loses its meaning now that treaties take the form of treaties of conciliation. The *right of conquest*, still accepted in the last century, has not withstood the test of two world wars: in the international consciousness, the notions of right and of conquest now appear to be mutually exclusive. The notion of the equilibrium of forces, of a *balance of power*, has changed in its content. These transformations arise from the same cause: with the progress of technology, understood in its widest

meaning, local or regional interests, whether grouped or expressed on a political or on some other plane tend more and more to be commingled with the interests of the whole, at least on the material plane. If certain goals arise in man's mind when under the thrall of ambition, greed and fear, these at the same time also put into his hands the technical means which force on him what one might call *planetary* consciousness.

(V)

The causes of this evolution are not only those that have just been described. In certain men, who rarely belong to political circles, they arise from a higher level of consciousness. Together, they have stimulated the institution of international organisms. From the esoteric point of view, these represent the embryo of that political and social body whose structure must respond to the needs of the new era. That body is called on, unless catastrophe intervenes, to become the ruling organ of a *federation* of all nations and all peoples.

True, the weakness of present institutions, in particular the United Nations Organization, creates doubt and impatience. Yet we must allow time to do its work, to form that organ of federation whose coming we hope will not be threatened and will occur in good time. For it seems that peace must be preserved, if not by the moral progress of humanity or by a superior level of consciousness in Statesmen, then at least by the fear of releasing forces that nobody on earth can control.

m

Touching on the philosophy of History, these considerations lead us to envisage a superhuman will which, beyond the aims pursued by man, leads us toward to its own ends. Certain minds which are capable of sensing this kind of action have referred to it in their works. In a work which appeared a century ago, Nicolas Daniicvsky, talking about the Oriental Question, put it thus:

"The question of the Orient is not one of those which can be solved in a diplomatic way. History leaves to diplomats only the arrangement of current affairs. As far as the great decisions of the world are concerned, those which form the laws in peoples' lives for centuries to come, it promulgates them by itself without intermediaries, amid lightning and thunder, like Sabaoth dictating the law from the top of mount Sinai. It is useless to look for proofs. The importance attached to the question of the Orient in everyone's consciousness is such that nobody has ever attempted to confine it to the narrow bounds of diplomacy. Nor has anyone ever had the idea of proposing a conference to resolve it. Diplomacy, which dares much, sometimes much too much, is itself aware that the task exceeds its means. And it lives only to discard that question from the order of the day, so as to enjoy the present times until the coming of the dreadful historical crisis which will absorb all the attention and all the forces of

the peoples for a long time, relegating all other problems and worries to the background.*¹³

One year after he had written those lines, the Franco-Prussian war of 1870 began the dreadful crisis of which Danilevsky had spoken. It lasted right up to the second world war. Since then, revolutions and wars of liberation have flared up here and there against the background of the cold war.

Those aspects of international politics which led peoples into these conflicts have been the object of a great number of studies; but as far as we know, nobody has attempted a synthesis. Now, if we compare the situation in Europe and the world on the eve of the Franco-Prussian war with that which followed the second world war we can perceive that in the last analysis the political fights and the wars that followed have not served the causes for which they were begun. Yet taken as a whole, they have changed the face of the world. Danilevsky talked about the question of the Orient; in fact his *dreadful crisis* greatly exceeded in scale the problems posed in 1453 by the fall of the empire of the East. The wars and revolutions shaking the world for the past century are only — as we can now see — the 'thunder and lightning' from within which the divine will dictates the statute of the new Era.

What are the basic principles of that statute? We find them laid down in the United Nations' charter. They transcend the principle of the balance of power, and despite concessions made to the principle of the sovereignty of States, they also transcend the notion of national identity. The Charter reflects tendencies manifesting in the evolution of international life, of which the most important is the growing interpenetration of affairs within states and between them, together with the growing influence of economic and social factors on what are properly political questions. In this way it becomes more and more difficult to separate the latter from the general entanglement of factors and influences which make up *public life* today, nationally and internationally,

It is difficult to determine the epoch in which this process started. We can, however, find a trace of it as far back as the French Revolution of 1789 or even earlier; its contemporary aspect started taking shape about half a century ago.

In 1898, Russia posed the problem of the limitation of arms on the international plane by inviting the powers to a conference at The Hague. We know that then this idea seemed so revolutionary in the eyes of the invited powers that it was finally rejected.

Here is an extract from that invitation, worth re-reading now that more than sixty years have passed, and taking into account the evolution which was to occur since then in the international consciousness:

13. Danilevsky, N. J. *La Rixxit cll'Europe*, St Petersburg, Obstchesvonnaya Polska, 1869, p. 319.

In the current situation throughout the world the maintenance of universal peace and the possible reduction of the excessive armaments of every nation are the ideal towards which the efforts of all governments should be directed ...

In its conviction that this noble aim fulfils the most essential interests and most legitimate wishes of all the powers, the Imperial Government believes that the present time would be very favourable for the exploration through international debate of the most efficient means of ensuring [the blessings of a real and enduring peace and above all of limiting the present escalation of armaments.

During the last twenty years, hopes for a general initiative for peace have been greatly reinforced in the consciousness of civilized nations. To keep the peace has been defined as the aim of international politics; in its name the great States have concluded powerful alliances between themselves; it is to better ensure peace that they have developed their military forces on a scale previously unknown and continue to increase them regardless of the sacrifice required.

Yet all these efforts have not yet led to the beneficial result of peace that was hoped for.

The growing financial burdens have attacked public prosperity at its source; the intellectual and physical forces of the peoples. Work and capital are, in major part, diverted from their natural application and unproductively consumed. Hundreds of millions of people are employed to acquire engines of fearful destructiveness which — considered today as the last word of science — are fated tomorrow to lose all their value following new discoveries. National culture, economic progress, and the generation of wealth are paralysed or warped in their development.

Yet the more the armaments of each power increase, the less they fulfil the goal at which these governments had aimed. Economic crises, due in great part to the excessive production of arms and the continual danger that lies in this accumulation of war materials, transform the armed peace of our days into a crushing burden that the people find more and more difficult to bear. It seems clear therefore that, were that situation to be prolonged, it would fatally lead to that same cataclysm which we originally strove to avoid, whose horrors make all human thought shudder.

To set a limit to these arms, and to discover means for preventing these calamities which threaten the whole world, this is the supreme duty which today imposes itself on all the nations.¹⁴

After the first world war, another breach was opened in the concept of the absolute sovereignty of States by the vast problem of labour which erupted onto the international plane. Now, we will immediately notice the difference in principle which exists between the two quoted facts. On the internal plane the problem of the limitation of armaments is solely the responsibility of the State, but it was raised on the international plane within the traditional framework for inter-state control. Approached in this way, although the problem shocked some people as an unacceptable attack on sovereignty, the proposed method did not bring any innovation in international relations. The situation was completely different where the problem of labour was concerned. It is enough simply to remember the

14. A note from Count Mouravieff, Russian minister of Foreign Affairs, to the accredited representatives of the powers at St Petersburg, 12-24th August 1898. *Document: Diplomatiques*, Conférence internationale de la paix de 1895, Ministry of Foreign Affairs, Paris, Imprimerie Nationale, 1900, pp. 1-2.

terms with which the Constitution of the International Labour Organization begins:

'Since a universal and lasting peace can only be founded on the basis of social justice;

Since there exist working conditions that burden a great number of people with injustice, misery and privation, which create such great discontent that they permanently endanger peace and harmony etc'

Since the creation of the ILO, the international field is not the exclusive preserve of (individual) States, as it was before; the social factor has now taken its place beside the political, which is only the concern of the states.

Those two examples taken from the many available, as they multiply at an ever accelerating rate, lead us to the following constataions:

— Although the sovereignty of the State always subsists and is not subject to restriction, certain categories of problems, (such as that of disarmament), can no longer be technically solved on a national plane, so that they have emerged into the domain of international relations;

— ■ Certain social problems (such as that of the protection of labour), have taken on greater and greater dimension and become more clearly defined in character and can only be resolved satisfactorily on the international plane.

Thus, since the beginning of the century the public arena of international relations, which was formerly exclusively reserved for political affairs and inter-state negotiations, has been, by force of circumstance, more and more invaded not only by economic and social affairs concerning States and the organizations of national governments but also by non-governmental organizations.

(10)

We can appreciate the distance travelled between the invitation made by Russia in 1898 and the signing of the UN Charter in San Francisco. Yet this great step forward has been dearly paid for: wars and revolutions in the same period have cost the lives of more than seventy five million human beings. While the new international law has been dictated by History amid lightning and thunder, factors analogous to those which transformed the feudal States into national States have ensured the continuing broadening of boundaries and of the collective consciousness in spite of all the crises. This progress has accelerated over the centuries, allowing us to extrapolate that the world is rapidly evolving towards the birth of a planetary consciousness not only in political, but in economic and social domains.¹⁵

15. It must be noted that here the word consciousness (*toútiéict*) is not used in the same sense as in the definitions of consciousness in "Volume I. (Ed.)

We must nevertheless emphasize that until now this evolution has not taken place consciously: it is in great part a by-product of technical development and of the holy terror aroused in humans by the destructive power of modern war machines.

The still imperfect state of consciousness leaves a choice between two ways of realizing unity on the international plane: the first is violence, *imperialism*, the other is consent, *federalism*. Only the latter is valid from the esoteric point of view, which is that of Consciousness, for only this fulfils the divine requirement which demands Love.

For the choice to be made in favour of federalism, it is necessary that the decisions taken on the political plane be inspired in the world by a higher level than that of waking consciousness. We are brought back once again to the problem of the new man. It is urgent to understand that isolationism, whatever its nature, is a decisive obstacle to our entry into the Cycle of the Holy Spirit. The Kingdom of God is not open to the *rich*, in the esoteric sense of the word. We cannot colonize it in a bourgeois way.

(W)

Since the passage of public life to a higher level of consciousness is linked to the formation of the new man, can we observe in human beings signs of evolution in the sense in which we understand that term? We are not thinking here of those for whom that evolution — the acquisition of consciousness — has become the aim of life, but of humanity in general.

Our civilization is incontrovertibly beginning to develop certain faculties which should make it much easier for us to enter the path of evolution.

In the first volume, while studying the *Way*, we said that the most important stage is that which leads *exterior* man to the level of man 4. The characteristic of the latter is that his lower centres have been developed and balanced. Let us examine the influence of modern life on the lower centres, first considering the motor and intellectual functions.

Our motor centre is subject to incomparably more varied and more refined efforts than those which must have applied only fifty years ago. *Speed* rules today's world. The considerably greater volume of travel, movement, and exercise to which the motor functions are constantly subjected by the general use of machines which have become more and more complex, has led to faster reflexes in man, and a greater and greater ability to execute precise movements in very short times. It is particularly the quality of efforts made in this domain that ensures the development of the motor centre.

16. Cf. Boris Mouravieff, *Lsbirti, Egaliti, Fraterniti* issue 129 of *Syntheses*, February 1957.

Since the turn of the century considerable efforts have also been made in the field of education. This effort is growing everywhere. The extension of school curricula must clearly keep pace with man's acquisitions in the intellectual domain. This pace is accelerating more and more. The child's intellectual centre is subjected to intensive training which reaches a higher and higher proportion of the country's youth and in some countries its totality, due to a general tendency to make education compulsory. Furthermore, certain States have already made secondary education compulsory. Access to positive knowledge is thus open to wider and wider strata of the population. In spite of numerous deficiencies, we can say that development of the intellectual centre tends to follow that of the motor centre.

The acquisition of these new abilities by the motor centre and the intellectual centre is no more than a *by-product* of an adaptation to the conditions of life in the modern world. This acquisition does not in fact result from conscious action directed towards man's esoteric development.

The moral progress necessary for the passage to the Cycle of the Holy Spirit requires much more effort in the intellectual field: everyone must be able *to give* the full measure of his ability in this domain. Man must make his *talents* produce all their fruits. He can only do that if he gets access to the higher teaching by which the highest forms of intelligence are developed. Governments have the sacred duty of opening the doors of the Universities to everyone as rapidly as possible.

(12)

To take a full view of the fundamental conditions necessary for the moral evolution of humanity, we have still to examine the most important, the emotional centre — the life of the heart: the emotions and the noble passions. We intend to do this in the part of this volume devoted to the *Way*. Meanwhile, we should point out that if the culture of the intellect and the training of the instinctive and motor functions of the Personality have created the conditions necessary for active existence in the new era, they are still insufficient. Conscious participation in the realization of the Cycle of the Holy Spirit also above all requires intensive culture of the faculties of the heart, so that man becomes fully open to positive emotions and closed to negative. If he also fulfils this requirement, man will drink from *the water of the Lord which shall be in him a well of water springing up into everlasting life*.

17- John iv: 14.

SECOND PART
THE UNIVERSE

PREFACE

(V)

It is with the fear of God that we approach the task of describing the *Doctrine* concerning the Universe on the mesoteric scale.

That fear is inspired not by the fact that we divulge the mysteries of Cosmogony, as this forms part of our Mission, but by our concern for finding language which will be clearly heard and understood.

Although the old law was not entirely replaced¹ by Jesus' teaching, it was superseded by it. However, the prestige of the Holy Tradition continued to weigh heavily on the society of those times. Even in our times this phenomenon remains, but now in different form. Anything old weighs heavily on the weak mentality of humanity. This leads us to create *taboos*, and then we are able to go ahead with a light heart, our eyes fixed obstinately on the past,

This is the major obstacle met by Jesus and his Apostles: an obstacle placed by people who, thinking they were pious, put ancient customs above the word of God.

Our fear is not inspired by people of bad faith, but from those of goodwill who are attached beyond measure to ancient traditions and for this reason think they are faithful and dwell in the truth.

This phenomenon is of great importance in the history of esoteric doctrines, People of good faith are too often the servants—in fact the most zealous of servants— of the *General Law*. So, when the word of God allows us to deepen our knowledge of the Truth, these pious and very sincere people, 'having drunk the old wine, do not desire the new, for they say: the old is better.'

Often we shall have to evoke this thesis of those of good faith who serve the *General Law*. Without this, it would be impossible to understand the historical meaning of the great controversies, the anathemas, the fire and the flames and the merciless struggles which have caused rivers of blood to flow in the Name of Him who preached Love.

*■ Cf. Hebrews vii: 18 and context; Romans vii: 3; Galatians iv: 9-11. ²- Mark vii: 13. ³. Luke v: 39.

Nevertheless, it is to these men of good faith that we seek to reveal this mystery of Cosmogony, so as to make them understand — with the help of higher knowledge — the role man plays — or could play — at three different degrees in this eternal process of Creation.

Yet to succeed we must first obtain some idea of God's Work of creation in its entirety and in its dynamic aspect. We can then move on from the general to the particular.

This requires courage and humility. With the approach of the era of the Holy Spirit, *everything* must be gradually brought to the light of day, not only the secrets of the laboratory but the deepest meanings of esotericism. The same must happen with illusions, errors and lies, which must also be revealed so that they can later be rectified. This process is already happening. It is this which to a large extent explains the political and social difficulties which characterize our time of transition. Yet only a few people know how to interpret the signs of our times. For it is now possible for open, cultured and courageous minds, inspired by that of the Forerunner of our Lord, to approach the light of the *Mind {intelligence} of Christ* and even to enter it.

It is in this spirit that we describe the Universe, *organic life on Earth*, and various aspects of the life of human society today as seen on the mesoteric scale.

To study this description will demand a special effort of the psyche on the part of the reader. To profit from it, he must stifle within him all personal reactions of disapproval or even of approval of these advanced theses. First, he must assimilate the various elements of the subject that he can understand, and make them his own. Criticism will come later.

In the *mesoteric* cycle of our studies of the Universe, we shall first consider the way in which the cosmic *lateral octave* actually works — a subject already introduced in the first volume of this work. Then, we gave the following warning: 'we will notice that while its action fills the interval between FA and MI of the *Great Octave*, the *lateral octave* must also be subject to a slowing down or deviation in the interval between its own notes FA and MI. How is that filled?' We added: 'We shall return to that important question when we have acquired certain background notions which will allow us to approach the problem in a more useful way.*¹ The time for this has come.

This question is of the utmost importance. If it did not in fact indicate how the interval between FA and MI of the *lateral octave* is filled, the account of this cosmogonic system would have remained fragmentary and so its value would have been incomplete.

In order for this system to be fully functional, a source of complementary energy had to be provided — from which corporeal terrestrial life would spring in its three forms.

That source exists. Yet we should note that it does not directly fill the interval between FA and MI of the *Great Octave*. This interval is filled by the notes LA, SOL and FA of the *lateral octave*, representing *organic life on Earth*; the autonomous human, animal and vegetable organisms.

Since the system exists in Time, where everything must come to an end, its continued operation requires the continual renewal of the constituents of *organic life* on the planet. This life, with all its elements, was conceived in the form of an alternation of births and deaths (*ijeu de naissances et de marts*), ruled by the alternation of the seasons so as to meet the need for a rhythmic transmission of creative energy along the *Kay of Creation* towards the notes MI and RE of the *Great Octave*. This ceaseless reproduction of the elements of *organic life* on our planet is the keystone of the whole *Kay of Creation*.

This diagram from the first volume of this work² is not sufficient to explain the working of the Universe as it manifests life. As we said earlier, the question is: how is the interval between the notes FA and MI of the *lateral octave* filled. That problem is solved in the way used for the *Great Octave*: by introducing a *second lateral octave*, which plays an analogous role in relation to the first to that which the *first lateral octave* plays in relation to the *Great cosmic Octave*.

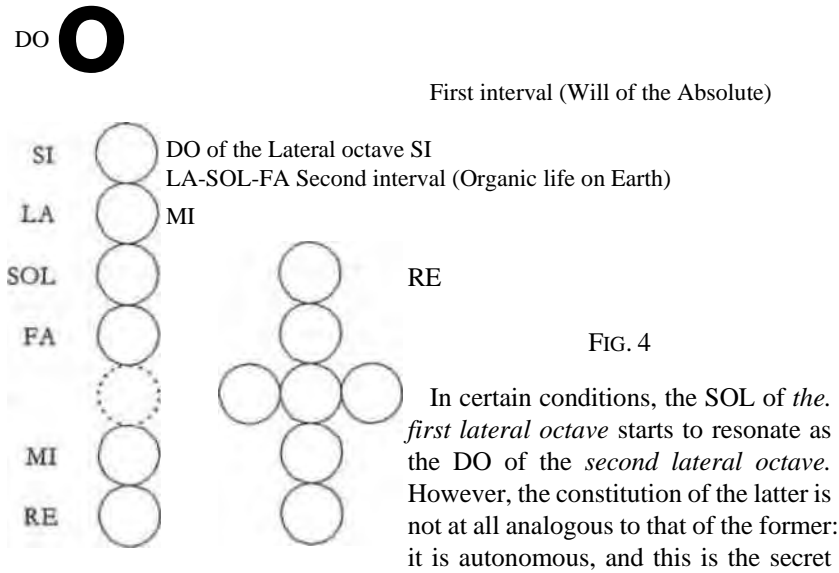

of its action and thus of the whole *Kay of Creation*.

This secret is of the first importance. Some aspects of it are at the same time amazingly upsetting, so much so that they had never been divulged. The system by which the Universe works has never been the object of a complete teaching; it has been given in symbolic form, but now it is brought out into the open.

2. Volume 1, fig. 41, p. 101.

As we have said, the DO of the *second lateral octave* comes from the SOL of the *first lateral octave*. It emerges as the Absolute III, the *absolute of the conception of corporeal life*; or in a more general way; of the process of incarnation in its psychological and physiological aspects.

If, in our *Ray of Creation*, the field of action of the Absolute II is limited to our solar system, that of the Absolute III does not extend beyond our planet. His action is exercised only on the elements of *organic life*. He is the Absolute for everything that governs the creation of conditions necessary to ensure the reproduction of corporeal life: those that allow the *conception* and then the *birth* of the elements which constitute the notes LA, SOL and FA of the *first lateral octave*. Becoming autonomous from birth until death, these organisms enter the *first lateral octave* as an integral part of it, and they remain under the authority of the laws which rule it.

The Absolute III maintains his authority over the notes SOL and FA. In what concerns LA — man — his authority, while concrete and great, is not after all absolute. In principle, *exterior* man is offered a choice. If he crosses the first Threshold by devoting himself to esoteric work, he can progressively escape the hold of the Absolute HE,

(*)

The direct intervention of Absolute III in human life generally occurs at the time of puberty; he perturbs the organism by various manifestations, from sexual attraction to a vivid upsurge of imagination which is the source of all sorts of romantic and other illusions.

The hold of the Absolute III over man and woman ends progressively from the menopause in women, and from the time of analogous troubles in men.

Normally, the surplus of sexual energy in excess of that needed for reproduction in humans is provided not simply for the pleasures of carnal love—wasting it for nothing—but to give these sad beings (*malheureux*) the chance to escape from their otherwise inescapable condition. This surplus of energy, once mastered and utilized in an appropriate way, can assist in the growth and development of the Personality. It is in this that man has a choice: by beginning to climb the *Staircase* he places himself progressively under the authority of the Absolute II, to whom he will finally become subject after the second Birth.

■ In the picturesque language of the Tradition, those are the 'dreams of the sleeping yesxg.

Sexual attraction and the pleasure of carnal love continue to exert a decisive influence over those who still remain on the wrong side of the first Threshold. They actually seek this attraction, and it takes many forms because of the unlimited possibilities of the imagination.

W

;

The attentive reader will already have made a distinction between the two kinds of imagination accessible to man. We shall fix them by definition:

1. *Creative imagination*, coming from the Absolute II, is awake and constructive. It is this divine force which distinguishes men from beasts: it is an active force.

2. *Drumlikt imagination*, which is somnolent, comes from the Absolute III, and is also found to a certain degree in animals: it is a passive force.

The latter form of imagination, the 'dream of the sleeping *serpent*', produces a hypnotic effect on man, keeping him in the state in which the vast majority of humans pass their lives.

A great part of the Doctrine is dedicated to methods which allow us to struggle against this dreamlike imagination, sometimes by calling on the creative imagination.

ffl

j

We should observe that the distance which separates the intervals between DO and SI and between FA and MI of the *Great Octave* is much greater than that which exists between the same intervals in the *first lateral octave*. In the first case it extends over four notes: SI, LA, SOL and FA, while in the second there are only two notes. This is because the triad: LA, SOL, FA of the *first lateral octave*, which forms a whole, has the value of only one note, destined to fill the interval between FA and MI of the *Great Octave*. In fact, the distance between the two intervals of the *second lateral octave* disappears completely. The four notes: SI, LA, SOL, FA in their turn form a whole which in itself has no material value: it is a *procedure*. It represents the neutralizing force that intimately binds the active force, the male will of the Absolute ITI, to the passive force, the female will of the flesh, which itself comes to meet it from the note RE of the same octave.

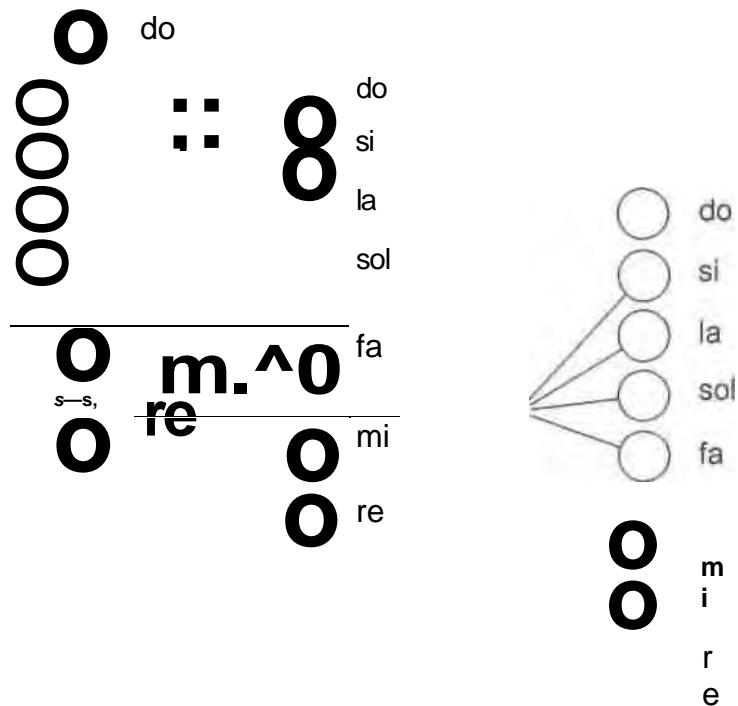

FIG. 5

As a neutralizing force, this combination of four notes SI, LA, SOL and FA constitutes a *technique* of the psyche by which the process of union of the two wills operates: the masculine will and the feminine will unite for the act of *conception*, which is realized in note MI and forms the foetus in note RE. After *ihcphysical* birth the fruit of this union, becoming autonomous, will enter the interval between FA and MI of the *first lateral octave* to fulfil its assigned cosmic role.

(6)

This process reveals a *second divine artifice*. We will remember that the first introduced the *Law of Seven*, so *curving the line of Time* to preserve Creation from annihilation at birth.⁵ The second artifice is realized by progressively shortening the second and third cosmic octaves — that is, the *first and second lateral octaves*—in order to evade the effect at *Law of Seven*, contracting the gamut to three notes, and so gathering together the three forces of the *Law of Three* which govern the techniques of creation.

We may remember that, having voluntarily limited Himself by the three *conditions* of Creation,⁶ the Absolute I conceived the Universe and its system of *Cosmoses* according to the *Law of Seven*. The *Ray of Creation*, which forms an octave, consists of the seven notes of this gamut.

The *first lateral octave* (or second cosmic octave) — as we have seen — contains in practice only five notes, so that the two intervals are already considerably closer together.

In the *second lateral octave* (or third cosmic octave) this distance disappears, since the notes SI, LA, SOL and FA together form a single *procedure* in which the two conjoined intervals merge.

It is important to have a good grasp of this divine mechanism. The will of the Absolute I, when it goes through a progressive double contraction and takes the form of the Absolute III, no longer acts according to the *Law of Seven* following the scale of the third cosmic octave (or *second lateral octave*), but now acts according to *Law of Three*, a productive law spontaneously and directly oriented towards corporeal creation.

Meditating on this system we are overcome by a sense of wonder; in awe we repeat the words of St John: *Great and marvellous are thy works, Lord God, Almighty; Just and true are thy ways, thou King of Saints!*

(S)

In this shortened form, the third cosmic octave allows the will of the flesh, the feminine will from the note RE, to enter into direct contact with the male will of the Absolute III. This contact is realized, as we said, by *procedure* sustained by the four intermediate notes:

SI	: A general atmosphere of sexual attraction
LA	: The particular sexual attraction of a couple
SOL	: Sexual union
FA	: Orgasm

6. Ibid.

7. Revelation xv: 3. We note that the system of three cosmic octaves which embraces the whole Universe includes *fifteen units* in all to reach, *in put*, the direct application of the *LOP ejThrtt*.

We find the quoted verse by referring to the same numbers, 15 and 3. This is not the effect of chance. The *CanihhefMoiei*, to which this verse of Revelation refers, contains numbers XV and 1 in *Exodus* = a hidden reference to the First cosmic Octave. The *Canthtt of the Lamb*, mentioned after that of Moses by St John, author of Revelations, contains numbers XV and 2 = a hidden reference to the Second cosmic Octave, represented in the parable by the *Sum* and *Branches* of the *Vim*. The complete symbol is only given in Revelation = projection of the New Era of the Holy Spirit.

The system of *Numbrs* plays a large role in the Tradition, particularly in study of the sacred symbolic texts.

Verse xv: 3 of Revelation is quoted according to the Slavonic text.

Fertilized in this way, the feminine force accomplishes its cosmic mission of reproduction by means of the *ovule* in note MI and in note RE the womb *{matrice}* the seat of feminine desire.

Now we can understand better why the *Microcosmos*, whose nature is androgynous and whose T is one but bipolar, undergoes a separation on incarnation, forming opposite sexes that are mental (*psychiaue*) as well as physical.

In the second cosmic octave, the distance which separates the intervals hinders direct reproduction; again, this is why the series of notes LA, SOL and FA, which consists of every aspect of *organic life on Earth*, has been formed, and why it is perpetually renewed *from below* by the third cosmic octave.

Thus human birth emerges as the highest possible birth in the whole Universe. Amongst other things, this is the reason for the Traditional statement that even the angels, if they wish to evolve, are obliged to pass through a human incarnation. For despite all its inconveniences, this is the only opportunity for evolution towards and through the second Birth.

In the second cosmic octave, the feminine will acts on a higher plane. Its encounter with the will arising from the Absolute II only takes place gradually and occurs in the interval between FA and MI of that octave. This encounter is only possible through the esoteric evolution of humanity in its two aspects: individually through the second Birth, and collectively through the general Resurrection. In both cases the process is an answer to the call of Grace and Truth emanating from the Absolute II.⁸

It continues *until the number is accomplished*.⁹

Then, when the notes LA, SOL and FA of the second cosmic octave have begun to resonate in full as a result of a successfully accomplished general Resurrection, the energy of the Absolute III will change its point of application: it will then manifest in the sublimation of sex, and human beings will then be liberated from their servitude to reproduction.

Everything depends on man's attitude at the approach of the Era of the Holy Spirit. If all goes well, the interval between FA and MI of our *Ray of Creation* should be completely filled by that time. If this is so, the energy of the Absolute II would then be progressively able to invade notes MI and RE of the second cosmic octave and in turn the energy emanating from the Absolute I would be able to penetrate the notes MI and RE of the *Great Octave*.

⁸- Cf. John i: 17.

⁹. Revelation vi: 11.

[y]. By the general Resurrection all adamic humanity will have passed beyond the second threshold. Until then, the sublimation of sex is only, and will only be possible to polar beings *ho accomplish their cosmic union here on earth in the act of the second Birth.

Thus, in spite of all the difficulties created by Man since the fall of Adam, the Work of the Absolute will be accomplished. Then *the days of the voice of the seventh angel will come, when he shall begin to sound, the mystery of God having been accomplished, as he hath declared to his servants the prophets.*

The Polar Man and Woman, who will then form an accomplished *Microcosmos*, will be received in the heart of Absolute Love, which is without beginning and so without end; This is the *Pleroma* of Orthodox Tradition. Paradise lost will be found again.

Unless there is a failure.

III

(1)

Before going any further, we must introduce a digression.

The Tradition is One. We said this in the first pages of the present work.¹³ We have also indicated that this one Tradition has been revealed and is always revealed in different forms, each minutely adapted to the mind and psyche of the human group to which its Word is addressed, as well as *to* the mission with which it is charged,

With time, the revealed Word, sometimes handed down from extinct civilizations, is subject to damage due to human forgetfulness: it becomes fragmentary. Then it receives arbitrary additions from purely human sources. With time, those conjectures are generally taken as realities.

Apart from these mutilations, we should not lose sight of a phenomenon of a totally different order. Divine Revelation, the source of all true Tradition, does not crystallize into immobility through the course of millennia. Even though this may seem odd, Revelation is given in stages: metered out each time in a necessary and sufficient way in answer to the needs of the epoch and of the Cause.

We can conclude that the study of traditional Knowledge faces us with three kinds of difficulties:

- a) Deformation with time, due to a forgetfulness that has rendered the original Revelation fragmentary;
- b) Additions by human sources;
- c) The insufficiency of the old Revelation because of the evolution of life in Time.

The traditionalist spirit in human nature demands that once the Revelation is delivered it should remain the same forever. In this way, as we said earlier, mere antiquity is in the end taken for truth.

11. Revelation x: 7,
12. Volume I, p.131.
13. Volume I, p. xvii.
14. Ibid.

To convince ourselves that this kind of mentality exists, it is enough for us to open the Gospel and read that glorious yet sorrowful history of divine intervention in the affairs of men, of events that actually happened among the *chosen people*.

We should keep this ever-present in our minds as we advance in our studies viewing the Universe in terms of the three cosmic octaves.

Let us repeat: the way the Universe works is no longer expressed here in veiled or symbolic form, but openly. This disclosure is to meet the needs of the time of transition in which we now find ourselves.

This is also so that we need not repeat the error of our predecessors of two thousand years ago, who did not have the courage to confront the naked truth brought to them by Jesus.

Today, the time for parables is long past; the hidden meaning of the symbols must be gradually revealed. But for this one must have courage or even audacity.

(2)

After studying the system of three cosmic octaves of which we have just given a schematic account, the reader should ponder the precise significance given to the Absolute I, II and III by the esoteric Tradition of Eastern Orthodoxy.

To answer this, we consider it our duty *to* refer to the sacred texts, as we have done all through our work, although we are conscious that we will be spared neither bitter criticism, nor blame, not even anathema. Our Lord and his Apostles, when they used the method which we are trying to follow, were not only criticized but even executed ...

The world in which we live and act is made up of 'A' influences under the aegis of the Absolute III. The 'B' influences come from the Absolute II. The first is the *Kingdom of this World: Caesar's Kingdom*. The second is *The Kingdom which is not of this world, the Kingdom of Heaven*. The Absolute II is Christ, the Son of God who incarnated as the Son of Man, *Ben-Adam*. The Absolute I is therefore God the Father.

Here the difficulties and dangers of interpretation begin.

We must nevertheless repeat that access to *Knowledge* on the mesoteric plane requires courage, as it demands a special psychological effort from the reader: he has to accept the postulates expressed, although it may be only temporarily, at the same time as disregarding his own ideas and personal beliefs. The critique, as we said, can come later.

CHAPTER IX

(1)

To make it easier to interpret these ideas about the Absolutes, we will try to give a detailed classification of current notions on this subject as given in the catechism on the Old and New Testaments, and as presented in the first volume of this work, which was dedicated to the *exoteric* cycle of the Doctrine,

We will try to do so within a stricdy canonical framework, keeping in mind the system of the three cosmic octaves explained in the previous chapter.

Our study will begin with the Absolute II. We have already said that He is the Christ, Son of God, begotten *not created*, that is to say, *eternal* and *consubstantial with the Father*.

As we have seen, the note SOL of the *Great Octave*, corresponding at this point to the *Deuterocosmos*, the Absolute II, causes the DO of the second cosmic octave to resonate. We have already constated that the term *Deuterocosmos* is perfectly justified, as although it only occupies the fourth place in the *Great Octave* and in the system of Cosmoses, there is no intermediary of a substantially different nature between the *Protocosmos* or first cosmos and the latter — in other words between the Absolute I and the Absolute n.

It is interesting to mention here an indication given by Jesus, found in the recently discovered *Gospel according to Thomas*, in which the Christ gives his position in the Universe. He said: *I took my stand in the middle of the Cosmos*.² In fact, the note SOL, equivalent to the *Deuterocosmos*, is in the middle of the *Great Octave* and of the *Macrocosmos*.

If we make the effort to represent the whole *Deuterocosmos* to ourselves as an Integral of all the suns of the stellar world, with their planetary systems and their satellites, we can perceive this ensemble which contains the whole Creation as the *Body of the cosmic Christ*. We shall then understand better the Gospel statement that *all things that the Father hath are the Son's*. This is also the underlying meaning of Jesus* words when He said: *land my Father art one**

!■ Vol. I, pp. 97,109 ff.

2. *The Gospil according to Thomas*, Coptic text established and translated by A. Guillemmnt, H.-Ch. Puech, G.Quispel, W.Till and t Yassah 'Abd Al Masih. Collins, London, 19S9; E. J.Brill, Leiden, 19S9.log. 28, p. 15.

3. John xvi: 15, also xvii: 10.

*■ John x: 10. As rendered in the French this is awkward to translate!

This is, if we dare to say it, the general appearance of Christ, or in other words, the nature of the cosmic Christ, the Son of the *living God*, himself *Alive* since he lives by the Father.

The system of the three cosmic Octaves also allows us to better grasp the real meaning of the many statements by Jesus concerning God the Father. The reader will find it very profitable to study the relation between the Father and the Son described in the Gospel in the light of the system of three cosmic Octaves. This will particularly help him to recognize in the Absolute II, Christ the Son of God, Lord of the Second cosmic Octave, of the *Deutercosmos* which — as already said — contains and animates the whole *body* of the created Universe.

The solar nature of Christ's cosmic body was shown to the three apostles during the *Transfiguration* on Mount *Tabor*.

By now, we can consider the identity of the Absolute II as Christ to be established, so that this point will need no further commentary.

m

]

It is not so easy to identify the Absolute I in canonical terms although at first analysis there seems no difficulty. In fact, the Absolute I, Creator of the Great Universe, cannot be other than God the Father. This assertion appears as simple as it is self-evident. Yet the evidence dissolves when we examine the problem more precisely. Many questions arise on reflection. Before anything else, let us constate that the idea of God the Father, as found in the Gospel, does not appear in the Old Testament, although it is expressed ninety-six times in the New,⁷ This cannot be the effect of chance, nor is the fact that Jesus did not talk of God the Father as the God of Israel. In general, the Old Testament provides a quite confused image of God, a fact which is explained partly by the level of the audience to whom Moses and the prophets addressed themselves, partly by deliberate hermetization, partly too by different notions attributed to the divinity. Yet Christian theology — Jesus in the first instance, followed by the apostle Paul — has not only identified God the Father in that confused notion of the God of the Old Testament, but also the Son and even the Holy Spirit. Even then there remain a considerable number of mentions of God which do not agree with Christian notions of the divinity, for example that of the God

5. John vi: 57.

6. Matthew xvii: 2; to those familiar with Hindu Tradition, we recall description of Krishna's transfiguration when he showed himself in the form of a multitude of suns in perpetual movement (Bhagavad Gita)

7. *Concordance dt Sainits Err/Vam*, Paris, L.-D. Delay, 1844, pp. 429-430 & p. 159 (for Dieu d'Israel).

who *repents* of having created man ... To find a reference to the Son in the Old Testament, Christian theology often quotes King David's Psalm CX:

The Eternal said unto my Lord:

Sit thou at my right hand

Until I make of thine enemies thy footstool.⁹

Here we recognize the Father as the *Eternal*, and the Son as *my Lord*. This question has been debated and examined in all its aspects throughout the nineteen centuries of the Christian era in such a way as to reconcile the higher notion of the Holy Trinity with traditional monotheism; this is due to the fact that the Trinity is only expressly referred to in the New Testament, yet it is the essential dogma of Christianity. In the course of its search for that reconciliation, Christian theology refers to the Hebrew plural *Elobim* amongst others, as well as the passage from *Genesis* which says: *Behold, Adam is become as one of us, to know Good and Evil etc.*

An abundant literature dating from the first centuries has firmly established that the notion of the Trinity already exists in the Old Testament, although in disguised form, and that this notion, since it recognized in the Trinity a consubstantial and indivisible nature, did not conflict with either the idea or the practice of monotheism.

On this point, we refer the reader who is more particularly interested in this question to specialist works."

It may be a matter of interest that the Divine Trinity is found in some pre-Christian religions. The Trinity of Hinduism: Brahma, Vishnu and Shiva, is too well known to require comment. Less well known is that of the pre-Christian Slavic religion, which recognizes a Trinity that is purely consubstantial and indivisible. The one God, creator of the Universe and of man, is called *Tri-Bog*(= Tri-God) or *Tri-Glav* (= Tri-Head), and is represented in human form with three heads on a single body.

God also is called *Svarog*, whose etymology has so far not been determined. Some aspects of that supreme God of the rigorously monotheistic Slavic religion bring them nearer to the Christian concept. We shall return to them later; let us only mention here that the Slavonic theogony also

8. Genesis vi: 6, 7.

9. The French has: 'Parole de l'Eternel i mon Seigneur;'

10. *Ibid.*, HI, 22.

11. See amongst others the *Bibliography* in Volume 1 of this work, and *Dirtoitaria of the Bibie*. ~-. In India diere exist sculptures of Trimurti, the three headed God, while on Mount Athos Mists a naive fresco of the Trinity from the 18th Century that has three heads and sixarms. (Ed.)

knew of the Son of God, called *Svarogtch* (= Son of Svarog) and also, *Sviatovit* (= Radiating Light) to indicate his sonship to *TriBog-Svarog*

m

This said, we are logically led to ask the question: who is the Father of Jesus Christ? Who is this father of whom Jesus said to Mary Magdalene after His resurrection: *Go to my brethren and say unto them, I ascend to my Father, and your Father; and to my God, and your God.*

If we refer to the text of the Gospel, the answer to this question will leave no place for doubt: Jesus is born of the Virgin Mary and the Holy Spirit, who is His true Father. St Luke, on the other hand, talking of the baptism of Jesus, relates:

'Now when all the people were baptized, it came to pass that Jesus also being baptized, and praying, the heaven was opened, and the Holy Spirit descended in bodily shape like a dove upon him, and a voice came from heaven, which said, Thou art my beloved Son; in thee I am well pleased.'

The scene of the *Transfiguration* on Mount Tabor also gives us an indication which should hold our attention. Peter, who was therewith James and John, began to speak, saying to Jesus:

'Lord it is good for us to be here: if Thou wilt, let us make here three tabernacles; one for thee, one for Moses and one for Elijah ...

'While he yet spake, behold a *luminous cloud* overshadowed them: and behold a voice out of the cloud said, This is my beloved Son in whom I am well pleased; hear ye him.*

This phenomenon of the *cloud* is mentioned more than once in both Old and New Testaments. The testimony St Symeon the New Theologian left us of his personal experience contains a precious indication in the following passage from his work:

"... I heard from a priest-monk who came to trust me that he had never proceeded with liturgical acts without having seen the Holy Spirit, in the same way that he had seen it when the Metropolitan had pronounced the prayer of initiation over him and the sacred book had been placed on his head.

I asked him how he had seen it and in what form? He said: "Primitive and without form, but like a light."

'And when I myself saw what I had never seen before, I was surprised and started to reason within myself saying: "what can that be?" Then, mysteriously but in a clear

13. For details on Slav theologian Boris Mouravieff, *DesCroyaittes slantsprishHtimnts*, in issue no. 161 of *Synthesis*, October 1959.

14. John xx: 17.

15. Matthew i: 18; Luke i: 27-35.

16. Luke iii: 21-22; Matthew iii: 16-17; Mark i: tl.

17. Matthew xvii: 4-5; Mark ix: 2; Luke ix: 34-35,

voice, He told me: 'I descend in this way on all prophets and Apostles, as on all the present elect and saints of God, for I am the Holy Spirit.'

From this it follows in a sufficiently clear way that God the Father, the Father of Jesus Christ, the Living God, Omnipresent, All replenishing and all vivifying, our common heavenly Father, First issued from the unmanifested Absolute before Creation, is most certainly the Holy Spirit.

So to clarify our ideas of the Holy Trinity, the basis of all Christian belief, we propose the following interpretation:

A — The real Father of the created *Macrocosmos* is God the unmanifest, who contains in unmanifested form the entire Holy Trinity.

B — His absolute creative Love appears as the Holy Spirit, Omnipresent and All replenishing, All vivifying and *Perfect*, He is the Father of Christ, who was incarnated by Him and of the Virgin Mary (cf. the *Creed*). He is also our own Father, as Jesus said more than once while exhorting humans: *Be ye therefore perfect even as your heavenly Father is perfect.*

In other words, He is the *Absolute I*, Head of the First cosmic Octave.

C — The Son, the cosmic Christ, Jesus Christ incarnated amongst humans, being One with his Father who is the Holy Spirit, from whom he is inseparable. Nevertheless, nobody can come to the Father except through the Son.²⁰

The organs for reception of divine Grace are our two higher centres: by the higher emotional Centre we come to identify ourselves with our real T, a monad of Christ; *through this* — and in no other way — man establishes contact with his higher intellectual Centre, which allows him to receive the messages of our heavenly Father. Thus crossing the third Threshold, he enters the *Pleroma* of His absolute Love, the supreme Beatitude.

The Son, as we have said already, is the *Absolute II*, Head of the Second cosmic octave.

(2)

In strictly canonical form, this is the way in which the image of the Holy Trinity appears in its three Hypostases which are consubstantial and indivisible; the Trinity that is One, *TriBog*, the *TriGod* of the Slavs, the Creator and only Master of the Universe — the *Macrocosmos*.

We must add two further points to the preceding. First, we want to dissipate any doubt which may arise in the reader's mind if he thinks we are making an innovation in dogma. Certainly not. We have already said in the

18. *Saint Symeon the New Theologian, Sermons*, Translated from the Greek by Bishop Theophan the Recluse in 2 vols. Moscow, C. St-P., 1890, Vol. II. Sermon 184, pp. 569-570.

19. Matthew v: 48.

20. Matthew xi: 27.

first volume of this work — and we repeat it here — that the Universe is created by the will and self-limiting sacrifice of unmanifest God; that is to say by means of the three conditions of Manifestation.²¹ By all the evidence he is the only true *Absolute*, who became the one and only true Father of the *Macrocosmos* by that act of self-limitation.

It cannot be doubted that in the esoteric theogony of primitive Christianity this notion of God the Father became part of the definition of the Holy Trinity, which later became dogmatic without always including the precise details on which it was based and which have been described above. Yet it would be absurd to suppose that this reality could have passed unnoticed or have been neglected by the Apostles and their disciples. But this subtle notion, like so many others which had no practical religious application in that era, remained hermetized until the time was opportune for its unveiling.

The second point to which we wish to draw attention is the famous XI th century controversy which led to the Great Schism between the Western and Eastern Churches.

The genesis of that unhappy split generated by His Church in the earthly Body of Christ goes back to the beginning of the IXth century. Political considerations then dominated the controversy. But the East, which does not admit the evolution of Dogma, clung to the formula of the *Apostles Creed* just as it had been consecrated in the seven oecumenical Councils. These are the only Councils recognized in Orthodox Tradition, while the Roman Tradition counts thirteen more Councils.

According to the definition we have proposed, it is certainly easier to admit that the Holy Spirit proceeded *from the Father*, which is the Orthodox dogma, than to assume that He *came from the Father and the Son* (the 'filioque'), which is the Roman Catholic dogma adopted at Emperor Charlemagne's initiative at the beginning of the IXth century, during the Council of Aix-la-Chapelle and then at Frankfurt.

And if we refer to St John the Apostle we find a formal indication that the Holy Spirit comes from the Father,²²

W

We should not be astonished that when it talks of God the Father, *the Apostles Creed* does not explicitly describe the Absolute in His pre-Creative state that preceded Creation. Nevertheless, the formula: *Omnipotent, Creator of heaven and earth and of all that is visible and invisible* covers

21. Volume I. p, 70 ff.

22. John xv: 26.

everything—including the interpretation given with the aid of the system of three cosmic octaves.

The Fathers of the CEcumenical Councils knew perfectly well that *Revelation* is not fixed but is always measured out so that it moves with the times, divulging the *Mysteries of the Kingdom of God*²³ gradually according to the needs arising in a particular epoch and for a particular cause,²⁴ and they were certainly responsible for that veiled formula.

III

(V

In the previous pages, in correlation with the system of three cosmic octaves, we have given an interpretation of the symbolic meaning of the canonical notion of the Holy Trinity, consubstantial and indivisible. We did this starting from the idea of the unmanifest God as the uncontested Father of manifestation, '... *one God almighty, Creator of heaven and earth and of all that is visible and invisible*'.

He contains in Himself, in the state of pre-creation, as already said, the whole Holy Trinity in an unmanifested state. By its manifestation the Holy Trinity takes on the appearance of the three canonical *Hypostases*, Father, Son and Holy Spirit.

Symbolically we attribute the term *Absolute 0* to God the Father. At the same time, in the system we are just-now revealing, we recognize the Holy Trinity in the following taken together: *Absolute 0*; *Absolute 7*; and *Absolute II*.

The symbolic attribution of the number 0 to God the Father has a real meaning. Let us remember the well known traditional maxim: *Everything comes from Zero to return to it at the end*. We should note that this sentence is not a simple image. Zero is not in fact *Emptiness*, it occupies a definite place among the numbers, and it possesses clearly defined properties. Therefore, from attentive examination of the series:

23, Mark iv: 11. »■ Cf.

John xxi: 25.

25- The first article of *the Apostles Creed* according to the Slavonic text. The French text is somewhat different; it talks at'... *aU beings visible and invisible*' whereas the Slavonic text does not include the word *beings* which implies restrictive meaning in human language. The Slavonic "t, as we indicated, *covers everything* including what cannot be expressed in words. ■*■ We will note that the canonical term *hypostasis*, of Greek origin, is a word composed of prefix W"0, English form of the Greek *bsipii* (under) and *siasis*(ta hold oneself). This is to say that by the ^rrn hypostases the Holy Trinity was placed by the Fathers of the oecumenical Councils below "self in its undifferentiated state, that of God unmanifest.

-oo -4; -3; -2; -1; 0; +1j + 2; +3; +4; + co
 the following conclusions can be drawn:

IV

(1)

1. *Zero* occupies a central place between two series of numbers, positive and negative, which progress to infinity in both directions;
2. Those two series originate from *Zero* in opposite directions and in strict equilibrium; consequently they cancel out, *finaliy (infiat)* returning to *Zero* since the two infinities converge at the limit;
3. Lastly, *Zero* belongs mathematically to the *even numbers*. Philosophically this means that it contains the two polar centres of the one *Consciousness* within itself in a static, unmanifest state which binds them intimately to each other. This is because the nature of *Consciousness* itself is androgynous, the 7th and the THOU in it being fused by a LOVE which vibrates at infinitely high frequencies. The word itself, *Consciousness (ton-stiowness)* indicates that we do not deal here with a dry notion — a monolith — but with a monolithic *whole*.

This vibrant Love is the *neutralising* force which fuses the I (+) to the THOU (-) in the static state of pre-creation. In manifestation it becomes an *active* force. It is the principle of life, filling all and bringing life to all, the basis of all that exists at every level from the highest planes of the invisible world down to 'stone', the most inert matter of ail Creation; from *Protocosmos* to *Micro-Microcosmos* in all its complexity.

That fundamental Love emerges in the created Universe as the Holy Spirit, the *Absolute I*, Head of the first cosmic octave who contains the second octave, who in turn embraces the third.

The number ONE attributed to Him symbolizes the *basic unity of His action*, which is nevertheless clothed with an infinite variety of forms.

Talking of Him, St John speaks categorically: *God is Love²* and also *God is a SpiritTM*

The *Absolute II*, Lord of the second cosmic octave, is the cosmic Christ whose Body is formed by the Integrality of all Suns. He emerges in the Tradition as the *Sun of Truth*, as *Light*, as the *Light that shineth in the darkness and the darkness comprehended it not*.

The number TWO, attributed to the *Absolute II*, symbolizes the duality of Creation emanating from *Zero* by the power of manifested Love, on a basis of perfect equilibrium.

This is the commentary which can be given on the mesoteric plane concerning the traditional Cosmogony, and on the mysterious action of the Holy Trinity which passes from the unmanifest state into manifestation in order to uplift Creation.

27. I John iv; 8.

28. John iv; 24.

29. Malichi iv; 2

30. I John i; 5.

31. John i; 5. Instead of the word 'comprehended' the Slavonic text quo-es 'enveloped'.

We now come to the most sensitive point: to the interpretation of the entity which is the Absolute m.

Firstly, we should note that the number *three* attributed to him in the system of three cosmic octaves is only his ordinal number. The symbolic number which is truly his own is not *three* but FOUR.

That traditional attribution is based on several reasons and has several meanings. The position he occupies in the system described above not only implies that he presides over the application of the *Law of Three* in the frame of the *Law of Seven* — with the purpose of the procreation of the species of *organic life on Earth* as created by God —but he also ensures the continuity of the autonomous manifestations of life: plants, animals and humans.

Thus the Absolute III is responsible for maintaining the procreation, *by themselves* and in the order defined by the Creator, of those elements whose species, in course of time and according to the needs of the times, undergo certain modifications realized by the Absolute II according to principles established by the Absolute I. With this reservation we shall understand the importance of the role of the Absolute III as Master of the third octave which we have defined as the keystone of the whole system.

The number FOUR, symbol of the Absolute m, also signifies that he himself is the fruit of creation, as are all the species which reproduce under his Kgis.

(2)

T n the system of three cosmic octaves of this Tradition, the number -* - THREE is attributed to the feminine principle of Creation. It symbolizes the *mill of the flesh?*²

This *will of the flesh*, referred to by St John the Apostle on the human plane, is spread across ail three cosmic octaves and throughout the *Macrocosmos*. It animates the *feminine desire* concentrated in all the three notes RE which represent in three linked forms the triple cosmic uterus &^at is at the same time spiritual, mental (*psychiauc*) and physical, and which in some way represents a *reflection*, a double-image of the Holy Trinity that, hke the latter, is consubstantial and indivisible. As a reflection of the Trinity, the higher feminine Intelligence is outside it, but at the same time, like it, it is ONE.

■ John i: 13. Sathanael, first engendered.

In the Orthodox Tradition it is personified as *thtQueen of the Heavens* and in prayers is mistaken for the *Virgin Mary*. The hymns say that she cherishes the whole Universe in her womb (*matriee*). Understood as incarnated, she is also venerated as the *Mother of God*, that is, as the Mother of Jesus Christ.

The Absolute III, like the *Queen of the Heavens*, is outside the Holy Trinity. But while we do not find any precise or symbolic references in the Tradition for the origin of *thtQueen of the Heavens*—except for an image of the 'Reflection in the waters'—for the Absolute III the indications are clear: He is Sathanael, first begotten at the highest level of the *Archistrategi*, the immutable entities. He emerges as *Satan*, in Hebrew simply 'the thwar-ter' (*'en travers'*), the adversary or enemy. We shall return to that Absolute shortly so as to identify his name and his titles as they appear in the Gospel and in the Tradition.

(V

j

While the three hypostases of the Holy Trinity, together with the *Queen of the Heavens*, embrace the whole *Macrocosmos*, the Absolute III only presides over the birth of the outer layer of the Universe. In our *Ray of Creation*—z\$ we have seen—he is the Regent of *organic life on Earth* within the limits of the mental and physical life of the three kingdoms of nature: flora, fauna and man. He dominates them by the action of sexual energy in the four phases of life: conception, birth, growth and finally reproduction. This sexual energy is the dynamic expression of his Love, which is carnal Love, while the spiritual life, which is accessible to man through the mediation of his higher centres, remains outside the sphere of the Absolute III.

His task is thus limited and he carries it out, as we said, by the sexual Love which emanates from him, by the force of attraction between the sexes, and by Illusion, 'the dreams of the sleeping young Serpent'. The current of his Love acts like a drug on both man and woman and, in its different forms, keeps them in a hypnotic state from puberty to the end of their days.

(*)

J

Although he may believe that he is 'awake' and 'objective' [*re'aliste*], *exterior* man lives in an Illusion that is inseparable from the influence by which his sexual centre governs his Personality. When not fulfilling its primary function,

the call of love by *xhc* Absolute ITI takes many different forms, differing in appearance and sometimes very different from or even

contrary to what can be defined in current language as sexuality. Examples are exaggerated ambition, conceit, intransigence, a domineering attitude, tyranny, and an exaggerated possessiveness, especially towards another person, when it may include jealousy. We can also add to this list incredulity, susceptibility, and a policemanlike attitude applied to private life.

Illusion, fuelled in man by sexual attraction or by its many mental derivatives, is the source from which the *General haw* draws its power, the Absolute III being responsible for its application. The absolute power of Illusion ends at the boundaries of the *Mixtus Orbis*, outside which the 'A' influences no longer rule. Yet as long as they identify themselves with their Personality, the creatures of *organic life on Earth*: flora, fauna and humans, are all subject to the incontestable and uncontested empire of carnal Love and the Great Illusion, *Maya*, which everyone takes for Reality.

For flora and fauna—on their own planes of relativity—*Maya* represents the Truth, since 'B' influences are inaccessible to them, but man has a choice. By his choice he determines his attitude towards the Absolute III, as well as that of the Absolute III towards him. The love of the Absolute III is favourable, agreeable and beneficial for anyone who is not interested in 'B*' influences, and who does not burn with the desire for liberation. Within the limits of 'bourgeois happiness', it even contributes to man's success. On the other hand, for one who has tasted *B' influences, who is crossing or who has already crossed the first Threshold to start climbing the *Ladder*, the influence of the Absolute III becomes harmful and he must fight it by all means and on all planes.

Yet according to legend, the Absolute ni is simply carrying out an assigned mission in which he takes the role of the Devil, and he feels sad when a Knight of Christ, entering the path, does not offer enough resistance to emerge victorious from this *invisible Combat*,

(V

In the Gospel, Jesus gives the name of the *Prince of this world* to the Absolute III. This is the common name for this entity, and embraces all his functions, beneficial and harmful. It is specifically in carrying out the latter that he bears the name of Satan, that is, the *enemy or adversary* of man. Some people also believe that Satan is God's adversary, a rival entity independent of God. This is an error, a sacrilege that amounts to blasphemy against the Holy Spirit. For *nothing* exists outside the Holy Trinity, which comprehends *everything* within itself, including Satan, with all the means allowed him for the accomplishment of his mission. Being engendered, he is a serving spirit. When the task of the Absolute ni has been achieved, his mission will end. It was from these traditional notions that

Origen taught the redemption of the Devil. Satan will then re-emerge in his primitive aspect as Sathanael.

It is clear that the *General Law* has for its field of action all the planets and all the satellites of the whole Universe; but what primarily concerns us is the action of the Absolute III on man, and in particular on someone who starts to climb the *Ladder* burning with the desire to reach the second Birth. After the second Threshold, as we already know, he will pass from the jurisdiction of the Absolute III under that of the Absolute II. But to reach this result he must fight and overcome the harmful influence of the *General Law* over him, mastering the sexual centre by awakening the intoxicated and sleeping *young Serpent*.

CHAPTER X

(I)

We have seen that the *Kay of Creation*, progressing from the Absolute down to the satellites of planets—the Moon in our case—necessarily follows the sequence of the octave that the Tradition calls the *Great Octave* or the *cosmic Octave*.



FIG. 6

This is the skeleton (*ossature*) of the Universe. We have also seen that this structure is, so to speak, clothed in living matter, and that in ensemble these form the *Macrocosmos*, which encloses within itself a succession of seven *Cosmoses*"

We have already examined the meaning of the notions of the *Protocosmos*, *Deuteroscosmos*, *Tritocosmos* and *Tessarocosmos*. These four *Cosmoses* correspond to the four following levels of the *Kay of Creation*, the supporting points of the system in its ensemble:

- I. — The Absolute;
- EL — The Stellar world, including the Sun;
- HI. — The planetary world, including the Earth;
- IV. — The world of satellites, including the Moon.

We have seen that, in the created Universe, the radiation of the original creative force from the Absolute penetrates our *Ray of Creation* down to the lowest level, the Moon.

■ Cf. vol. i, p. ea ff.

^z - *Mid*, p. 106 ff.

3- *ibid*.

J PROTOCOSMOS
 j AGHIOCOSMOS
 S M O J MEGALOCOSMOS
 8 C J DEUTEROCOSMOS
 A C R V J MESOCOSMOS
 3 A J TRITOCOSMOS
 J TESSARACOSMOS

FIG. 7

At each relay station the radiating forces belonging to the level of the Sun and the Earth blend with this primary force, which meanwhile suffers a loss of charge en route. Considered as centres of radiation, these four points we have called supporting points would each resonate as a DO. And between these four DOs are the three octaves of their cosmic radiations.

In their action they are *descending*, and their development takes place according to the *Law of Seven*. There are three intervals between the three pairs of notes DO and SI, and three more between the notes FA and MI.

The intervals between the notes DO and SI of these octaves of radiation are filled from within, since they are found in the Absolute himself, in the Sun, and in the Earth:

While descending through the three octaves of radiation down to the limit of the Universe, represented in our *Kay of Creation* by the Moon, the creative force from the Absolute is aided, in the lower octaves, by radiations from the Sun and the Earth. This force thus creates a whole scale of values of *substance types*, ranging from the atom of the Absolute to the dense matter we have designated symbolically by the word *stone** (See fig. 8 on following page).

The creation and perpetual renewal of its substances continues throughout the scale of three octaves following the *Law of Three* in the following way:

	<i>substance</i>	<i>action</i>	<i>density</i>
Active force	DO = C	= 1 — 1	(
Passive force	S I = O	= 2 — 3	< H 6
Neutralizing force	LA = N	= 3 — 2	I

4. Cf. Volume I, pp. 91-94.

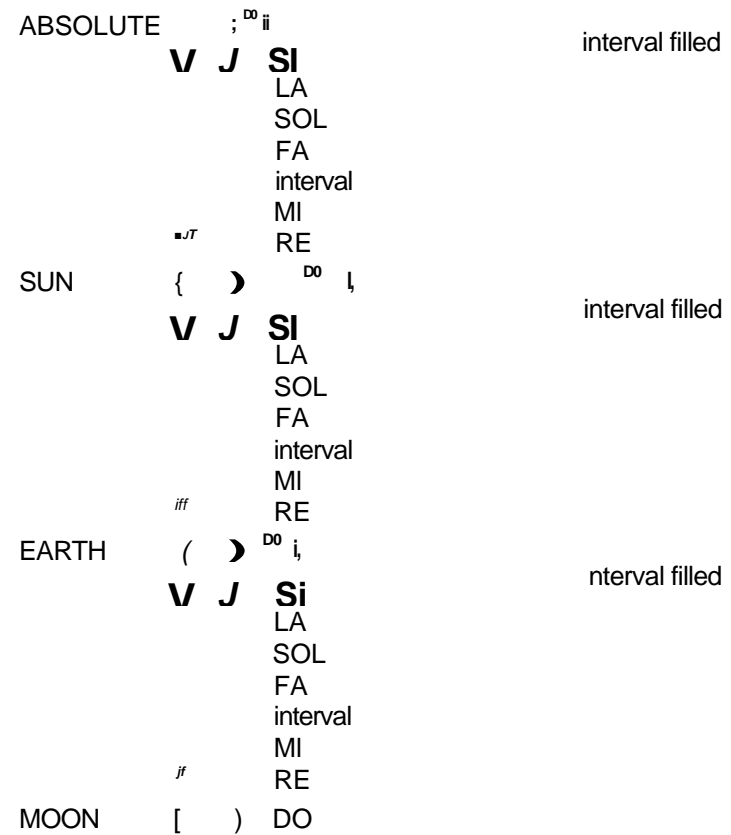

FIG. 8

The neutralizing force of the first triad enters the second triad as an active force with the density of 2:

Active force	LA - C =	2 — 2	
Passive force	SOL = O =	4 — 6	H 12
Neutralizing force	FA = N =	6 — 4	!

Then in the same way we obtain:

Active force	FA = C =	4 — 4	}	H 24
Passive force	Int. = O =	8 — 12		
Neutralizing force	MI = N =	12 — 8		

Then,

Active force	MI = C =	8 — 8	
Passive force	RE = O =	16 — 24	H48
Neutralizing force	DO = N =	24 — 16	

If we continue to calculate in an analogous way throughout the second and third octaves of radiation, we will obtain a scale of substance-types that have definite values which extend from the *Absolute to tht Moon*, starting from the Hydrogen 1 proper to the unmanifest Absolute, including twelve consecutive degrees from H 6 down to H 12288 , and which pass through the Sun and the Earth.

(2)

This is the complete or absolute scale of substances; it covers the whole of the *Macrocosmos*, more particularly the *First cosmic Octave* we wrote about in previous chapters.

The scale of substances in the *Second cosmic Octave* begins from the Hydrogen 3 proper to the *Aghiocosmos*,⁵ which is the emanation of the manifested Trinity in matter. Its limits are different: The Hydrogen 6 of the first scale is not found in this. In this scale the finest matter is H 12.

For reasons which will be given later, the H 12 of the *First Octave* of radiations appears in the form of H 6 in the Second. The second scale is shortened and includes only eleven Hydrogens instead of the twelve in the first.

The scale of substances of *Third cosmic Octave* begins from Hydrogen 6, symbol of the perpetual rebirth, which corresponds to H 24 on the first scale and to H 12 on the second.

For reasons analogous to those which led to the shortening of the second scale, the third is still shorter: the first two qualities of Hydrogens are missing from it. In addition, because of the special character of the *Third cosmic Octave*, the H 6 of the third scale is, in certain characteristics, the actual substance of the Absolute III. In effect, the Absolute II as well as the Absolute I, when they act as *Creators*, do so from outside their respective scales, which should be considered as emanating from them but foreign to their substance. But it is the very substance of the Absolute III, in its role as a *Creature*, which forms the elements of the higher level Limited to the third scale of Hydrogens, which is thus reduced to ten types of substance.

This third scale in itself includes all the substances of which *organic life on Earth* is formed.

5. Cf. Vol. I, Figures 37 & 38.

Here then is the complete table of Hydrogens with its three scales, as just explained:

<i>1st. scale</i>	<i>lind. scale</i>	<i>fflrd. scale</i>
H6	—	—
H12	H6	—
H 24	H 12	H 6
H 48	H 24	H 12
H 96	H 48	H 24
H 192	H 96	H 48
H 384	H 192	H 96
H768	H384	H 192
H 1536	H768	H 384
H 3072	H 1536	H 768
H6144	H3072	H 1536
H 12288	H 6144	H 3072

(V)

We have seen that it is the third scale which concerns *organic life on Earth*. Meanwhile, only man among all the many the elements which constitute that life, with the complete development of his Personality, uses or, to be more precise, can make full (*dans leur integralite*) use of all the Hydrogens of the third scale, in all their overtones, although the first two Hydrogens of the initial scale will still remain inaccessible to him. As they are not part of the planetary substance, they are necessarily missing from the human organism of *exterior* men and even of *interior* men.

The scale applicable to man for his study and development is as follows:

H 6 : Substance used by the higher intellectual centre;
H 12 : Substance used by the higher emotional centre and the sexual centre; partially by the positive part of the lower emotional centre and lastly by the magnetic centre; H 24 : Substance used by the motor centre; frequently used by the negative part of the lower emotional centre; » 48 : Substance used by the lower intellectual centre; " 6 : Animal magnetism, rarefied air of high mountains, and in the terminology of certain *schools fire of the blood*; N 192 : ordinary *Air*, heavy gases, volatile liquids, blood without *Fire*; " 384 : *Water*, heavy liquids; H 768 : *Earth*, solid foods; fj !536 : Lignite, hard woods etc.; H 3072 : Metals, minerals, stone.

m

It will be apparent in the next chapter that the work of the human organism, physical and psychological, incorporates a double action of the transmutation of elements, one action going in the opposite direction to the other. In this way they balance one another, one moving from the fine toward the coarse and the other from the coarse toward the fine.

The whole possibility for the esoteric evolution of man lies in the integration of the latter movement. The other runs automatically. Beginning from a certain stage which depends on the person, the transmutation of elements from the coarser plane towards the fine demands conscious efforts, or sometimes even superefforts; the reverse movement, as we said, will automatically follow the first without any effort. We find an analogous process in the opposite direction in the action of the psychological part of the gamut which ensures physical conception.

We should not assume that this equilibrated double movement is gen-crated in each case and in each direction by a single process. It acts in the two directions through a *bundle* of parallel processes. In an immature man, this bundle is thin although generally very firm: to the degree that the Personality grows and develops this bundle becomes complicated and gains in subtlety. In *exterior* man, as long as his Personality remains incompletely developed and is still disequilibratcd, this bundle is stricken with a weakness that is inversely proportional so that at the end it allows him to understand everything but gives him no power. After the second Threshold, following the birth of the *Individuality*, the equilibrated double bundle forms a complete instrument of a sensitivity and power incomparable to those the *exterior* man can enjoy,

(5)

There are also two lower scales of Hydrogens, one applicable to fauna, and the other to flora—where fauna and flora represent the notes SOL and FA of *organic life on "Earth"*.

(6)

While simultaneously studying the system of *Three cosmic Octaves* and the *Table of Hydrogens* in their corresponding scales, we should always remember that each of the Hydrogens shown represents, so to say, the central or if we wish the essential characteristic of an almost infinitely graduated ensemble of related substances. Each of these can be distin-

guished from the other Hydrogens by the specific character of its chemical, physical, psychological and cosmic properties, all of which are of the same functional order although they act on very different planes.

Among other things this remark explains why it is impossible to establish precise equivalences between the *Table of Hydrogens* and Mendeleyev's *periodic Table of chemical elements*, which only considers the physico-chemical properties of matter. But current research into the structure of the atom is bringing our positive science ever nearer to traditional knowledge, so that today we can observe a convergence tending to reconcile the two disciplines on that particular point of Knowledge. The same can be said of a fine part of the scale of Hydrogens which had evaded direct scientific observation until now, that which constitutes the matter-energy of the life of our psyche. In that domain too, evolution can be observed. Thus it is now possible to envisage that physics, biology and medicine, as they continue to move forward in their researches, are approaching a limit beyond which the finest Hydrogens — H 12 and even H 6 — will be detected, so that they will then gain the right of recognition in those branches of positive science.

CHAPTER XI

if}

When we think of the Universe as a living Being, composed of living matter and filled with living organisms, we face the question of its *nutrition*.

The common characteristic of all living matter, wherever it is, is its need for and ability to assimilate and eliminate animal, vegetable and mineral aliments.

As the *Macrocosms* cannot find food outside itself, since there is nothing outside it, we must conclude that it finds its food *within itself*. We can also say that if the Universe as a whole remains in a perfect state of equilibrium, its nutrition must be conceived as a cyclic scheme of gamuts linked so that in every situation they compensate each other.

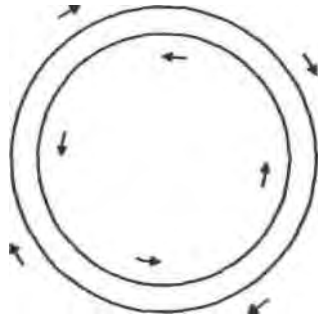

FIG. 9

This scheme is universal. The nutrition of every cosmos is conceived on the same principle. In *organic life on Earth* we can observe that the nutrition of vegetable, animal and human creatures is all carried out according to different cyclic systems.¹ Man and animals absorb oxygen and reject carbonic acid; plants at a certain stage of their metabolism absorb carbonic acid and give out oxygen. Man and animals feed on plants which in turn feed on their waste products. In these examples—as in others that are more difficult to observe — we find ourselves confronted with the action of ascending and descending gamuts whose linked activity, seen as a **holc*, is perfectly balanced.

■ 'Ecosystems' form one example. (Tr.)

In the final analysis, nutrition is the absorption of solar energy by means of a complex process of metabolism of which several factors are still unknown. Let us examine this process as it occurs in the human organism, where it follows the *Law of Three*, which acts within the framework of *Law of Seven*. The nutrition of man's physical and psychological organism is organized in three parallel gamuts:

1. the gamut of solid and liquid food;
2. the gamut of respiration;
3. the gamut of impressions.

We know that man can live without food for a month or even longer; he can live without breathing for several minutes, but he cannot live at all without receiving impressions, as the ending of impressions means death. These three kinds of nourishment are the three contributions that the organism 'pumps' from the Universe in which it lives;

ff.

Food absorbed through the mouth passes through the digestive tract; going first to the oesophagus, then the stomach, afterwards passing into the intestines. Absorption of nutritive elements has already occurred by the time the food passes from the mouth to the oesophagus. Proteins are treated in the stomach, then the peristaltic movement conducts the alimentary bolus along the intestines where the last stages of digestion and the first of assimilation occur. Once the organism has drawn all the nutritive elements from the absorbed food, the residue is evacuated.

We shall note that the complete digestive tract can be conceived as an octave in the following way:

- DO : Mouth;
- RE : Oesophagus;
- MI : Stomach;
- 1st.Int. : Intervention of bile and pancreatic juices;
- FA : Small intestines;
- SOL : Carcum;
- LA : Colon;
- SI : Rectum;
- 2nd Int. : The start of reflexes for the evacuation of residues occurs naturally. When this is lacking from various causes they must be artificially induced.

2. We continually receive impressions, even though we ate not conscious of them when our attention is distracted (*MtounUi*) or when we ate asleep or lose awareness.

3. Cf. Volume I, p. 135 ff.

Now let us see how the transmutation of Hydrogens occurs in our organism, starting from the food introduced through the mouth — which is composed of H 763.

This transmutation follows an ascending octave that starts from DO 768, which represents a vast group, the complete series of elements which form our nourishment in the form of different foods. This DO is passive.

Starting from this, the transmutation follows a complete octave in our organism. Yet it does not develop spontaneously.

We already know that if it is to continue without interruption, the development of a process along a gamut requires two complementary shocks to fill the intervals which, in the case of an ascending gamut, are placed so that one lies between MI and FA and the other between SI and DO.

As far as we are concerned, the food H 768 introduced into the mouth as DO 768, is then regarded as *oxygen*, that is to say, as a *passive* force. In our organism it is subject to the action of an *active* force, *carbon*, of density C 192. During the complex processes which occur at that point, the *neutralising* force, *nitrogen* N 384, emerges. According to the *Law of Three* this appears in our organism as Hydrogen RE 384. Transmutation proceeds in an analogous way in the following stage, where RE 384 gives birth to MI 192.

To be precise, let us repeat that the ascending gamut of the transmutation of energies drawn from food —like any evolving gamut—is balanced by another gamut, this a descending one that corresponds to the formation of metabolic wastes. This selective (*trriage*) process is carried out at each note.

What first interests us are the energies that the organism can draw by transmutation of the elements from foods when they are treated progressively at each note of the ascending gamut.

Hydrogen MI 192 is already a relatively refined energy. Yet like the previous notes it first appears as *passive* force,

To avoid a misunderstanding which always occurs at this point of our study, we will once again warn that we must not confuse the vehicle of an energy with the energy itself.

As a *passive* force, MI 192 does not encounter an *active* force in the organism to activate it, as happens to DO 768 and RE 384. So when it reaches the interval that separates MI from the FA of this gamut, the process of transmutation must stop. If it is to continue to progress, the naturally passive MI 192 must receive a complementary shock.

This shock is supplied by the breath. Air penetrates into the lungs as DO 192—*active*. There it comes into direct contact with the MI 192, activating it by imparting part of its energy to it. Thus it fills the interval and allows the process of transmutation to reach the note FA 96.

By this transmutation, therefore, we reach H 96, the first of the substances which evade physico-chemical analysis at the present state of science.

In fact, FA 96 is the first of a series of four substances considered by positive science to be undetectable. But their presence is felt. Common language testifies to this: when the note FA 96 resonates strongly and clearly, we say somebody 'radiates health*. This is referred to as *animal magnetism*.

Once we have accumulated substantial reserves of that energy within ourselves we will remain strong, with good humour and cheerfulness towards others.

From these statements we can draw the first important lesson concerning our nutrition. Whatever may be our type, our temperament, our state of health, the accumulation of energy FA 96 will always be highly beneficial to us. Within the limits possible from the esoteric point of view, it will allow us to put into practice the maxim: *Mens sana in corpore sano*.

The strong and clear resonance of FA 96 remains the indispensable basis for developing the life of the psyche and the moral life under the best possible conditions.

m

After FA 96 there is no interval to be filled before we can pass to SOL 48; neither is there one between SOL 48 and LA 24, nor between LA 24 and SI 12.

This last energy, SI 12, is produced in great quantities within us provided that our food follows the principles of a healthy diet and is rich in nutritive substances without being over-abundant. Excess delays transmutation, especially at the level of LA 24, and brings on disorders of very different types, obesity being one of them.

For this process to pass through the development of the gamut easily and fully, the food must meet psychological criteria which make it attractive; from the material point of view, it must be balanced in its composition, prepared with care, and presented in a logical way. The planning of the 'menu' should reflect a gamut which corresponds to the physiological stages of digestion. All these requirements are most often neglected.

Deep and strong respiration is the second indispensable condition for abundant production of a satisfactory quality of FA 96. This necessity is the

reason for breathing exercises which, when well conducted, can double the effectiveness of the instinctive reflex of respiration, although they are full of dangers when practiced without the advice of an experienced person.

in

Now we will examine the significance of each note of the first food octave in a more detailed way:

DO 768 corresponds to the pleasures of the table, the delicacy of the ingredients, to the way the meal is prepared; these latter factors predispose our organism to assimilate the food in the best conditions; in addition, this DO corresponds to the transformation and even to the direct absorption of foods through the mouth (sublingual absorption),

RE 384 corresponds to the absorption of energies during digestion in the digestive tract.

MI 192 corresponds to the level of the heart.

FA 96—%% we have already said—is 'animal magnetism'. It results from oxidization of venous blood. The blood which leaves the lungs must be brilliant red because of perfect oxygenation. *One'i blood must be on fire*, says the Tradition.

SOL 48 is one of the energies normal to the lower intellectual centre. If the food is of bad quality, intellectual work suffers. This is the basis and mainstay of our capacity to think. We know that the first effect of lack of food is the weakening of the capacity for concentrating our thoughts on a determined object and of our ability to create ideas.

LA 24 ensures the vigour of our organism. The latter's capacity for movement at all levels, both interior and exterior, is ensured by the motor centre and depends primarily on the quality of our food. We must therefore insist again on the quality of food. There is an observable difference between meat and vegetarian diets; between hot and cold food etc.

SI 12. The production of sexual energy in SI 12 crowns the evolution of this gamut.

m

The energy SI 12 is polyvalent, that is to say that it can be utilized in three different modes.

The first is what one might call its basic or natural use. SI 12 energy serves as food for the sexual centre, is meant for the sexual act, and through this it ensures the reproduction of the species.

This reproduction begins from DO 6, and follows a descending gamut as explained where Chapter VITI describes the nature and role of the Absolute m in the Third cosmic octave.

However, the passage from SI 12 to DO 6 runs up against the second interval. This is precisely rilled by the notes SI, LA, SOL and FA of the Third cosmic octave. As we have already seen, these notes in their ensemble form the neutralizing force which, *in fine*, provides the link between the active masculine SI 12 and the passive, feminine SI 12.

The other two uses of the energies of SI 12 are very different. Yet those two represent an internal consumption of that energy irrespective of whether the organism is masculine or feminine.

One is unnatural. Usurped by the motor centre, SI 12 serves as the 'fuel' that feeds the negative parts of the lower emotional and intellectual centres and forms negative emotions. This question is treated in detail in the third part of this volume. There we will describe methods by which it is possible to struggle against such tendencies and even draw a profit from them.

Let us repeat that this use, which is now very common among humans, is not only against nature but is particularly harmful; in effect it destroys the organism of the psyche and through that of the body.

The other use of SI 12 energy is equally unnatural or rather 'against nature'. But it differs profoundly from the preceding one. While the consumption of SI 12 by negative emotions was mechanical, in the latter case its use is the result of conscious and sustained efforts.

The theory of this mode of use of SI 12 is that instead of ejecting this energy outside the organism during the sexual act the *exterior* man should store it to accelerate the formation of the astral body, that is, for the growth and development of his under-developed Personality.

Several methods exist for using SI 12 energy for that purpose. All of them lead to a recognizable acceleration of the esoteric development of Personality. In general they involve sexual abstinence accompanied by emotional and intellectual concentration. At the same time, during the whole operation and each time it is undertaken, the motor centre is kept occupied in an appropriate way so as to avoid its interference in the process, interference by which that centre tends to usurp SI 12 energy and channel it towards orgasm,

This, by the way, is the method generally used in monastic practice.

III

The development of the gamut of respiration — the second octave of nutrition — starts in the lungs with contact between DO 192 and the MI 192 to which it communicates part of its active energy.

From there, by a process analogous to that which we observed at the beginning of the first octave, DO 192 passes without hindrance to RE 96, then to MI 48, where evolution of the gamut runs into the interval.

In most of mankind, the transmutation of the elements stops there: for nature itself does not provide a complementary shock, as in the case of first octave. Yet this shock can be introduced in a way analogous to the preceding example; although no longer mechanically but by conscious effort.

Under certain conditions, the nature of which we shall describe, when the DO of the third octave of nutrition, impressions, is activated, it can communicate part of its energy to MI 48, which is of passive nature. This will allow the latter to fill the interval and to pass to FA 24 following the same system of transmutations,

At the same time, if the contribution of complementary energy is sufficient, the FA 24 passes without hindrance to SOL 12 and, even from there to LA 6. Transmutation along that octave stops there in all cases.

IV

(V

The third octave—impressions—begins with DO 48. This DO 48 is the totality of all the impressions which penetrate us from the exterior through our senses, and all those which arise from within us as a mechanical reaction to internal or external impressions — either in a direct line or transformed by associations.

This DO 48 is passive. As we have said, it ensures the continued existence of the organism, and the transmission of all the different signals the motor centre sends to the intellectual and emotional centres. We register the impressions which reach us passively in the way just described.

DO 48 is also the *material* of thought, which is elaborated by means of a basic element provided by the first octave of nutrition in the form of the energy MI 48. However, thought of the order of DO 48 is limited to the mechanics of formal logic, and it cannot transcend what philosophy knows as *pure reason*.

This situation changes in a radical way if we apply the right conscious effort to this DO 48, that of *constating* the received impressions. The effort of constation described at length in the first volume of this work, if it is not applied after the event but at the instant when the impression is received, communicates an active quality to the DO 48. In this event the DO 48 communicates part of its energy to the naturally passive MI 48 in the octave of respiration and, as already mentioned, this ensures that the transmutation of Hydrogens is continued right along the octave of Aspiration,

Applied to of our proper impressions at the exact moment that they are received, this effort of conscious constataion also allows a certain development of the process of transmutation along the third octave. The latter then passes from DO 48 to RE 24 and so to MI 12, where it in turn runs into the interval.

As in the case of DO 48, this interval too can be filled by a conscious effort, but this effort will be of a higher order and will demand the simultaneous application of several elements.

We will find more than one allusion to this second and complementary conscious effort in specialized literature; yet knowingly or unknowingly— we cannot determine which — this key question is always treated in an incomplete way. The indications given, although never dangerous, remain unusable.

In reality, several conditions must be brought together beforehand during appropriate exercises completed in advance, to create, at the precise place in the organism and at the most opportune moment, three united forces — C, O and N — of the specific quality and of sufficient power necessary to give birth to an active H 12 capable of making MI 12 cross over to FA 6.

This operation — as we can well imagine — requires a complete special training that acts equally on the three octaves of nutrition: training in the constataion of certain exterior and interior impressions; training in breathing and finally, training in the *lateral* transmutation of SI 12 into SOL 12.

We shall analyse the practical application of that process in a more detailed way in the next volume, when we examine the physical and mental conditions of esoteric work as carried out in the world outsid monastic life.

m

Below we show the complete food diagram of the human organism, with its three octaves of the transmutation of absorbed Hydrogens: the foods of digestion, respiration, and impressions, By meditating on this diagram, the attentive reader will be able to draw on his own experience to complete the descriptions given in the present chapter.

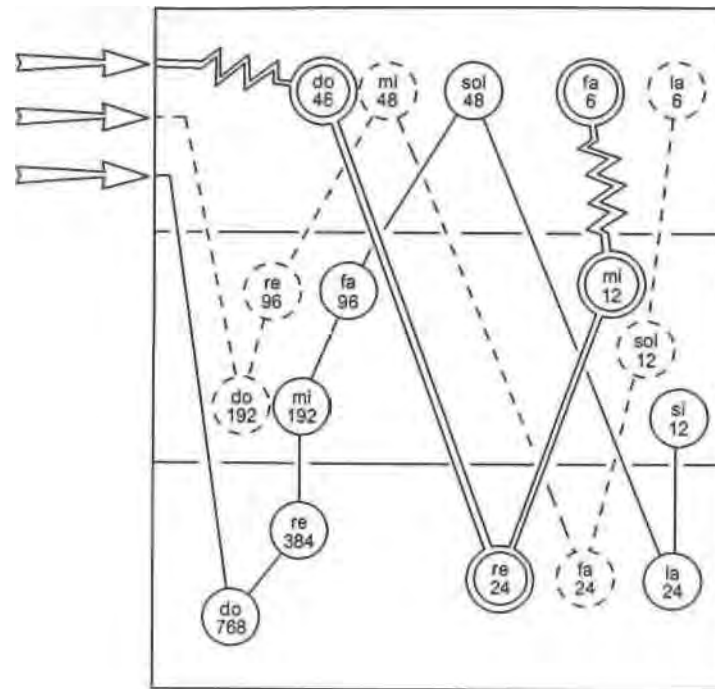

FIG. 10

To conclude, for all individuals who try through practice to improve the way their organism transmutes the Hydrogens from these three foods, we should like to point out that they should always keep in their minds the fact that lack, of success in these exercises is habitually related to two general causes: the first is impatience and haste; the second is ignoring the need to maintain equilibrium between these coupled gamuts. Power introduced in a particular direction at any point in a cycle must be compensated in the opposite direction by a contribution to the cycle that forms the other element of the couple.

CHAPTER XII

(V)

In the Preface to the second part of this volume we said that, now that the era of Holy Spirit is rapidly approaching, *everything* must be brought to light. Everything, scientific secrets as well as the deepest esoteric Knowledge whose complete Revelation has been promised, This will reveal all the deviations of man's fundamentally enquiring spirit, eager to fill the gaps of his *Knowledge* at any price. This desire is stronger than himself and leads him to seek solutions for major cosmic and human problems when he only possesses a tiny part of the data that would solve them.

As a result, his efforts are often marked by errors of conception that sometimes reach the point of heresy. He nevertheless continues to build his mental houses of cards when these problems cannot even be approached without *Revelation*. If he constates the inanity of his propositions he then resorts to collective thought and calls on public opinion, seeking a majority in all manner of assemblies and councils as a way of resolving obscure or sensitive questions. But is not *Vox populi "Vox Del?*

Yet the time is near when everything — including all the errors, heresies and lies — must be recognized and corrected.

It will be obvious to the reader that ignorance of the system of the *Three (osmk Octavethzs* been the root of our failure to find a valid solution to the great questions of life which have always disturbed the human mind that hungers for higher Knowledge —and which continue to trouble it today.

It is only at the present stage of Revelation, on the basis of the data now available, that we can consider these questions of life without the risk of being overwhelmed in the attempt because we lack sufficient means.

(2)

Central to all the great unanswerable questions since the earliest times has been that of Evil.

Without any knowledge of the *General Law*, of its meaning and its organic necessity, it is impossible to solve that problem or to decipher the symbolism of Genesis which is its key. So let us attack the question by a still more attentive examination of the Biblical symbols.

We do not generally take account of the fundamental fact that the *Tree of Knowledge of Good and Evil* is one single tree which bears both kinds of fruit ^{at} the same time—so that they neutralize each other. Still more paradoxical is the fact that the branches bearing these fruits that have opposite tastes

stem from the same trunk, are nourished by the same sap, and this trunk grows from a common root. In real esoteric symbolism all these details are significant. We do not generally ponder the fact that according to Genesis the *Tree of Life* grows in the same Garden of Eden—and thus not far from the *Tree of Knowledge of Good and Evil*. The two trees plunge their roots into the same soil, drawing on the same waters and the same earthly food.

The system of the *Three cosmic Octaves* reveals the deepest meaning of these symbols. Yet some might argue that if, in the Biblical account, the *Tree of Knowledge of Good and Evil* can be regarded as a symbolic expression of the *Third cosmic Octave*, and the *Tree of Life* as a representation of the *Second*, why is there no symbol of the *First cosmic Octave*, since Genesis does not speak of a third Tree?

In researching this analogy, the reader must concentrate his attention on the system of *Three cosmic Octaves*. He will then constate that if the Third and Second octaves are born respectively from the Second and the First, the latter cannot emanate from a preceding octave since it does not exist. According to the rules of esoteric symbolism, since it originates from itself it could not be represented by a third Tree, that is to say, by a subordinate existence. So we find it symbolically expressed in Genesis as the very soil of the Paradise that God planted in the East.¹

(3)

I

Continuing to study the symbolic meaning of this story in terms of the system of *Three cosmic Octaves*, we can consider the question of Evil in the context of the whole structure of the Universe.

It will then become clear that, on a cosmic scale, absolute Evil does not exist. The relative Evil that we observe and in which we are both artisans and victims, as well as suffering, sadness, sickness and death, are direct results of original sin. This is original not only in the historic and academic sense, but above all because it is repeated and lived out by each one of us from the moment in infancy when the *T* of our Personality wakes to consciousness. In each one of us, man's identification with his underdeveloped Personality is a complete recapitulation — on 2 purely personal contemporary basis — of Adam's fall,

This identification is a major error. Yet if we get to the root of the problem we will constate that this error is willingly accepted by us. From this point on, the real *T*, when we finally accept the idea of its existence, appears to us as 'another', as a being different from ourselves. Another' whom we fear, and towards whom we take a defensive attitude if not actually hostile.

1. Genesis ii: S.

Even when we finally and definitely admit his existence within us, at least theoretically, and when we begin to understand the technique of *Salvation*, we do not in general feel any natural attraction towards this *T* even though it is our own self. In most cases, having reached this point we will hesitate to renounce our habitual identification which muddles our Personality with the consciousness of our body. This is the sense of so-called reality that, inspired by the *T* of the body, uses fear, hunger and sex as the great motivators that express themselves through an infinity of masks to distract our Personality from the '*V*' that is truly real. In this situation, the Personality finds that *the old wine is best*.

To get out of this zone of hypnosis we must begin an *Invisible Combat* against the hold of the *General Law* which, using Illusion and the common idea of what may be considered as 'evidence', dissuades us from going any further towards crossing the first Threshold, and instead invites us to return to the things we know and to again assume our responsibilities as active members of human society. As a general rule, the Prince of this World does not act brutally. Mephistopheles rather prefers to put forward arguments, to give his advice, to obtain a decision by the seeker to abandon the path and return to a reasonable and normal 'life' as his own preference...

Truly it is difficult to begin this *Invisible Combat*. It not only opposes the disciple of esotericism to everything and everyone, but above all it sets him against himself, against his own Personality. This enterprise is certainly difficult, yet it is always possible. For this is submission to the will of God, a will which stretches out a helping hand from our own depths. This explains the sadness of Mephistopheles when he is faced with human weakness, when we do not know how to oppose his counsels with firm resistance ... And when, deliberately using his arguments as if they were our own, we give him our talents of pure gold in exchange for his false coin.

m

There is no waste in the economy of the cosmos. The Great Universe is organized on the principle of full utilization and *fullemployment*. Evil, suffering, negative emotions and Death are utilized as a kind of 'manure' on the lower planes of growth or existence.

Yet as it emanates from the working of the *Three cosmic Octaves* the range of Evil and its derivatives is limited. It is exactly defined by the boundaries of the *Third cosmic Octave*, and by the extent of the responsibility of the Absolute III, the Prince of this World, overseer of the *Mixtus Orbis* and of *organic life on Earth* within the limits of the *A'* influences.

From this point of view we can say that the meaning of all esoteric work, the very meaning of *Salvation*, of the call made by John the Baptist and the

teaching of Jesus and his apostles, is to recognize the relative and subordinate value of *A* influences, and to recognize the 'B' influences as the only real value, since they are the imperishable sources of permanence and of Salvation.

When the disciple finally realizes his identification with the real *T*, this will turn his whole scale of values upside down progressively all along the *Staircase*, and completely with the second birth. The great Doctors of the oecumenical Church say this explicidy.²

(5)

i

If we ponder it deeply, we may perceive a new meaning in the phrase '*they glorify God by their death*', which in Orthodox literature is currently applied to the torture and execution of certain martyrs, starting with the Apostles. The underlying meaning of that strange expression is much more than a simple recognition of the courage with which they faced death in the name of their Faith, St Symeon said that, having completely broken his identification with his Personality and, *ipso facto*, with the *T* of his body—a fact which becomes intelligible in the light of what we explained previously—man bears misfortunes, pain, death, and even martyrdom as if these events were not happening to him.⁴

So glorification does not consist of courage shown at the time of martyrdom, but in the victory in God's favour that man wins over himself during this very life.

The Second Birth progressively brings to man a power which finally becomes absolute, first over his Personality, then over his body. For twice-born man the body only has the value of an instrument of expression and action, an instrument that he abandons at will, which he can repair, and whose use he can prolong at will. His death, which will only occur by his consent, will no longer result in any suffering for him, and this is even true of martyrdom or crucifixion.

This is the true meaning of *the glorification o(God*; it marks the victory of man over himself, inspired and awaited by Christ.

2. Cf. amongst others, Symeon the New Theologian, *Sermons*, op. cit., volume II, pp. 544 and elsewhere, Cf. also, the death of Socrates in Plato.

3. That being so.

4. The familiar phrase, 'unmoved hjr it, as if it were happening to someone else' translates this idea better than the more exact rendering given. (Ed.)

(6)

But we should not conclude that the passion and death of Jesus on the cross were of that kind.

The Son of God, incarnated on Earth as the Son of Man, appearing here below as *Adam before the fall*, the perfect Man, without blemish and with all his powers, Jesus accepted suffering and death willingly and substantially, as if he were a common sinner like the rest of us who crucify Christ daily in our hearts.

So great was that sacrifice—a *substitution formula*, as we said elsewhere—that it allowed humanity to subsist and so pass on, for good or ill, from the *Cycle of the Father* to the *Cycle of the Son*, and to do so if not in joy, at least in suffering.

(?)

We are now led logically to consider another fundamental problem, that of *sin*. We have already broadly defined it in the first volume of this work.

Original sin should be envisaged as an error of conception, to which man has given assent, which distorts his underlying consciousness of *T*. Everything else follows logically from this. This is why we refuse to recognize that sin has any substantial significance.

Sin is only the expression of an error of conception translated into action, that is to say, of an entirely false attitude to the problems or questions which, in general or in particular, rise before us daily. This is a subject where we often confuse cause and effect. Sin is simply the effect of a causal attitude which necessarily leads to deviation and straying with all their consequences.

Thus the basis of sin is *error*. That is why sin can and must be redeemed. The way of redemption is simple, but how difficult it is to put into practice! The method is *repentance*.

To repent is to become conscious of the error which led to the act of sin. The Tradition says '*there is no unforgivable sin except sin without repentance*'.

It is important to thoroughly grasp the meaning of what we have just explained. It is not sufficient to balance the *act* of sin by means of a diametrically opposed *act*, whose effect cancels the karmic tare but cannot wipe out the sin.⁶ To wipe it out, the opposed act must not simply be the result of a consideration emanating from the intellectual or motor centre.

5- Cf. Volume I. pp. 133-134.

6. As the restitution of an amount stolen still does not cancel the offence committed.

Repentance, as we have said, is to become conscious on the plane of the real T; in other words, true repentance always has an *emotional* character.

The traditional maxim for wiping out sin applies to every case except that quoted by Jesus: 'the blasphemy against the Holy Spirit'.

This is understandable. Since the Holy Spirit is the essence of Consciousness, He is the last instance to whom the penitent can resort for repentance. But whoever blasphemes against the Holy Spirit denies the very existence of Consciousness, of the Holy Spirit, and from that he falls into what the scriptures call *outer darkness*.

This is why it has been said:

All manner of sin and blasphemy shall be forgiven unto men; but blasphemy against the Holy Spirit shall not be forgiven unto men. Whosoever speaketh a word against the Son of man it shall be forgiven him; but whosoever speaketh against the Holy Spirit, it shall not be forgiven him, neither in this world, nor in the world to come?

It is an eternal sin,

H

(V

;

We have already mentioned the pre-Christian religion of the Slavs. We will return to it to explain how they expressed the doctrine of Evil in their theogony.

The idea of Evil was conceived by them not in the abstract but in concrete and empirical form. Not finding a place for Evil in a providential theogony, yet seeing Evil act in life side by side with the Good, the Slavs recognized its divine origin and nature and personified it with the name of *Tchernobog* (the black God).

It is curious to see how the Slavs reconciled this notion of *Tchernobog* with that of an omnipotent and good God who was the Creator and the one absolute Master of the Universe.⁹ In this thorny problem of the connection of Evil with God, they neither adopted the Iranian dualist conception, based on the equal power of Ormuzd and Ahriman, nor the Judaeo-Christian position, monistic in principle but somewhat lame, since it admits — as far as the origin of Evil is concerned — a deviation from the precepts of a God Who always tends towards the Good; in other words, it admits a transgression of the divine Will which after this fact appears somewhat *limited*. In fact, the name *Satan* — which comes to us

from the Old Testament, signifies one who *'thwarts\ the adversary, the enemy* who is no longer Sathanael, the First begotten.

Yet the Slavs attributed to *Tchernobog* a field of action precisely limited to the domain placed under the authority of *Svarogitch*, the Son of God. They also said that the supreme God does not allow Evil nor recognize it. Since Evil in fact exists, *God does not look at it and does not talk of it* for, according to them, the direct radiation of the supreme God does not reach Earth.

Thus, the statue placed in the temple of Stchetine (Stettin), with three heads on one body — symbolizing the supreme God called *Triglav* (Tri-head), or *Tribog* (*Tri-God*) — had its eyes and mouths covered by bands of gold. According to the interpretation of the divines and priests, the bands of *Triglav* signified *that the supreme God does not will to see human sins, and passes by them in silence as if He did not know of their existence*¹⁰

This conception certainly harmonizes well with the Slavs* initial postulate, according to which the supreme God deals only with the celestial, and his direct radiation does not reach as far as the Earth.

Certainly traditional, this conception represents a remarkable attempt in the history of human thought to reconcile the principle of divine goodness with the presence of Evil in the world.

(V

The ancient Slav religion, which was rigorously monotheist, is little known and has been little studied despite its interesting character. We can affirm that in more than one way it is nearer to Christianity than any other ancient religion. Its theogony also knows a Son of God. Its conception of Evil, *Tchernobog*, allows us to suppose that an esoteric Tradition existed with them at that time, and that it included elements of Gnosis in one form or another—a knowledge of the system of *Three cosmic Octaves*— masked from the exterior world by images and symbols.

m

Many minds, at the very heart of Christianity but tormented by the problem of Evil, evidently had a presentiment of the presence and power of the Absolute III. Having no correct idea about his origin or his mission, nor of the limits to his authority, they went as far as to speculate that the world had been created by the *Devil*. We have already alluded to these theses, a variant of which taught that, if the world had been created by a God, that God, if not wicked, was at least limited in his power or even incompetent,

10. Ebbo, 64; Helmold, Lib. I, *passim*.

7. Manheviit 31-32.

8. Mark iii: 28.

9. Procopius of Gcsarea, *Dt btlh Gstt'm*, III, 14.

This was the origin of numerous heresies during the first centuries of our era, an echo of which we find again in the Middle Ages. The degree of Revelation by that epoch did not allow the elements making it possible to solve that problem to be brought together: in particular, knowledge of the system of *Three cosmic Octaves* was lacking. A dangerous imagination filled the gaps.

III
(V)

I

The complete disclosure of the system of the *Three cosmic Octaves* also allows us to deal with an important question whose meaning has always remained obscure: that of *Initiation*. The contemporary notion of Initiation can be defined as follows:

Ceremonies by which men were introduced to the knowledge of certain mysteries in the ancient religions and which, today, accompany admission into different secret societies.

This definition combines two distinct meanings. One refers to initiation into the mysteries of antiquity; the other to ceremonies of admission into contemporary secret societies which are claimed to be *Initiatory*.

We know nothing for certain about initiation into the mysteries of antiquity. The works of the most erudite authors only give us an approximate view of them; they talk of the role that the mysteries played in the public and private life of the ancient world; yet about the mysteries themselves and their esoteric content, we are very badly informed. When ancient authors mentioned the mysteries in their works, they went no further. Some of them explained their silence by saying that an oath of absolute secrecy had been imposed on them during the initiation ceremony itself.

A few pictures, monuments, myths, and fragments of certain cults, allow us to form the hypotheses that the essential content of the different mysteries of antiquity included a common theme. The language of our Tradition defines this as *the Mystery of the Promise*: that is, as a disclosure throughout the ancient world, which was then in the middle of the *Cycle of the Father*, of the Redemption promised in the future Cycle, that of the Son.

Let us not insist on these terms. We have simply borrowed them from the vocabulary of our own Tradition. They are just labels: neither the exact terms used at the time, nor their precise significance, has come down to us.

11. *Ptiti Larohsstt 1560, IVth impression, p.552.*

During the *Cycle of the Father*, the divine Gnosis was revealed to Initiates in this form as the *Mystery of the Promise*, which found its justification in the *Mystery of Realisation* of Jesus Christ. It is clear that the *raison d'être* of the *Mystery of the Promise*, which was a mystery of Hope, was Realized and then disappeared with the realization of its hope. It is therefore useless to regret the disappearance of the ancient mysteries whose esoteric content is superseded by Christianity. Researches aiming at their restoration are now of merely academic interest. This is even more so since Christianity, at least in its original form, itself represents a disclosure that brought into the light of day the truths and the techniques of work on oneself that had been taught in the *Mystery of the Promise*, which then allowed the spiritual elite at the time of Christ's Advent to establish vanguard teams for the newborn Christianity by adapting to the facts of the *Mystery of Realisation*.

We can thus understand without difficulty that during the history of Christianity the Mysteries no longer had the Promise as their theme, since this had already been realized by Jesus. The emphasis was now on the realization by *ourselves and within ourselves of the New Man, the true Christian according to the model given us by Our Lord*. We are now concerned not only with Faith and Hope as in the past, but in addition, as we have already stated several times, with the true *Gnosis* and true *Love*. These are given in a new initiation into the *Mystery of Accomplishment* which aims for a general Resurrection during the *Cycle of the Holy Spirit*?²

Because of this, ancient mysteries such as those of the *Old Testament*TM are superseded. Their time has been fulfilled and the esoteric Revelation has passed on to a higher level. The mystical reality of the times requires seekers athirst for Truth, for whom one step forward will allow them to become initiated into the *Mystery of the Accomplishment* itself, so that together they may form the vanguard of the new human society forming the heart of the *Cycle of the Holy Spirit*. This is the teaching in the *Gnosis* series, which provides minds enraptured by Gnosis and by Love with necessary and sufficient indications — by means of planned and effective work — to reach *Initiation* into the final mystery, the Accomplishment.

(2)

We must pause here to define the meaning and effect of esoteric Initiation in the proper sense of that term,

The attentive reader of this book will have little need for this. All through this series we have returned time and again, concerning the

- See Volume I, pp. 161, 176 (note) and 253.

■ Clemm of Alexandria brought Greek philosophy nearer to the Old Testament of Jews. Cf. *rontata, puttim*.

esoteric plane, to the necessity for and the effect of man's work on himself. It is clear that this demands work on the *consciousness of the T*.

Out of the mysteries of antiquity came a New Man, capable of actively contributing to the coining of the Era of the Son. At a higher level, the *Mystery of the Accomplishment* will cause the emergence of New Men — and they are already emerging — as the indispensable condition for the proper beginning of the Era of the Holy Spirit. Today we are somewhere in the time of transition to this new Era.

The cultivation of pure reason and practical reason were the objectives of the transformation of ancient man by means of initiation, as evidenced by the works of the great philosophers of the epoch. Today that step has been passed, and the objective of initiation now consists of establishing direct and *certain* contact with *Divine inspiration* through the mediation of the real T.

In both cases, although at different and successive levels, Initiation required and requires long and assiduous preparatory work from the seeker and an effective and profound modification of his whole being whose aim is to transform his consciousness of his own T.

The Apostles of Jesus, and later the great doctors of the ecumenical Church, were certainly Initiates of the *Mystery of the Accomplishment*, as were the saints of historical Christianity. Today a new elite of such *Initiates* is being formed to assume responsibility for receiving and establishing the Era of the Holy Spirit on Earth in the near future. This elite will be formed of *twice born* men, *interior* men, in other words of prophets and apostles.

This should not surprise the reader. Even taken alone, the amazing progress of technology locks human society into a *deadlock of power*. It proves beyond doubt the powerlessness of the Intellectual — who still holds the power — to organize life in conditions that are beyond his capacities. And true Peace, desired by everyone instead of a *balance a Fear*— eludes him. Only the New Men, with a higher level of consciousness, that of the real T for the divine essence, can successfully face life's problems, which will become increasingly insoluble in today's conditions and will be able to put the new things in their new places.

m

I

After the explanation above it is unnecessary to emphasize the fact that *Initiation*, in the esoteric meaning of the word, is not simply 'ceremony'. The *Initiation* ceremony no longer occurs as of old on the human plane and with human rituals — and this is understandable. The modern Initiate, forerunner of the citizen of the *Cycle of the Holy Spirit*, is liberated from obedience to the Absolute III by the second Birth, and —

like the prodigal son—he is then received into the *Alliance of Love* of which Jesus is Firstborn and Head.

Yet the ceremony still exists in modern Initiation, but it is conducted on the super-sensory plane. Nevertheless, it is real. It confirms the Initiate in a new dignity earned by his *Work*, and carries him towards the divine *Grace* which keeps him under pressure from within his own depths.

This Initiation ceremony does not occur visibly on the material plane for a reason which is very clear: it is because with it the Initiate crosses over in spirit from the kingdom of this world to the Kingdom which is not of this world. From then on he plays a part in the higher notes of the *Second cosmic Octave*, the Kingdom of Christ.

m

We have a few more words to say about the second definition of Initiation given above, which referred to the admission ceremonies of different contemporary secret societies.

We will leave the analysis of their esoteric value to specialists. The Tradition of Eastern Orthodoxy knows no initiatory secret societies like those described, which are found in the West.

Yet for some time now literature about them has been widespread, produced not only by their adversaries but by these societies themselves.

We only wish to put remark on one point which has particularly held our attention. In everything disclosed about these traditions and rituals, the accent is always put not on the New but on the Old Testament, and within the latter not on the tradition that came from King David, but on that transmitted by his son, King Solomon.

The historical causes of this phenomenon could undoubtedly be established, but they are outside the scope of our work.

CHAPTER XIII

(1)

In esoteric science, the doctrine of the *Three cosmic Octaves* plays a role analogous to that played by *D.Mendeltyev's Periodic table of the elements* in chemistry and physics, to that played by the *Heliocentric system* of Nicolas Copernicus in astronomy, and finally, to N. j.Danilevsky's doctrine of the *civilizing historical types* in historical science.

In other words, the system of the *Three cosmic Octaves* allows the introduction of a *natural* classification into Gnosis as an alternative to ordering facts and ideas artificially and so at random, or at the whim of the author, This ensures that the essential condition for positive scientific study is fulfilled: *that the curriculum should correspond to the structure of the object studied.*'

Danilevsky's doctrine—the essentials of which we are about to outline—is capable of transforming History by substituting a logical and orderly system for a mass of apparently incoherent facts. Only such a system will allow us to grasp the true meaning of the historical process taken as a whole, as well as of every branch of history. It then becomes possible to study isolated Historical phenomena in relation to the whole evolution of History; in other words to consider the facts not only in isolation but in their organic historical context.

By putting things in their place, the system of Danilevsky, like those of Copernicus and Mendeleev, automatically nullifies false theories which so often persist in the present state of historical science and prevents the emergence of theses that have no relation to the general context of History.

In the domain of History, as in Religion, the introduction of false theories is particularly dangerous; introduced into the consciousness of the masses by skilful adepts, these theories are capable of creating veritable epidemics of the psyche which lead to catastrophe. One example of this danger was the racist theory which, evolving from Gobineau to Hitler, became one of the principal motivating forces of the second world war.

(2)

Mendeleev theoretically demonstrated the possibility of releasing the energy within the atom a century before the experimental disintegration occurred. Three centuries passed between the publication by Copernicus of his treatise *De revolutionibus orbium caelestium* in 1543 and

1- This is the correct understanding of this idea. On this point, incorrect understandings are possible. (Ed.)

the discovery of *Neptune* in 1843-1845 by Le Verrier and Adams after they calculated its position without directly observing it. These examples—and it would be possible to find many more — show how slowly the human mind works.

When studying this question of pace, we should keep in mind that Mendeleev had a whole series of brilliant successors both in chemistry and physics. Copernicus was also followed by great minds such as Giordano Bruno, who generalized his system, Johannes Kepler, who codified it and made it more precise in terms of its three laws, and Isaac Newton, who completed it by the discovery of universal gravitation.

But the historical theories of Danilevsky, a biologist to whom Russia owes its regulations controlling sea fishing, were not followed up by anyone, although his ideas are found here and there among modern authors such as Oswald Spengler and Arnold Toynbee.

Yet Danilevsky's doctrine offers a basis for logical classification and so opens the way to an understanding of historical phenomena, just as the systems of Copernicus and Mendeleev opened up new visions in their respective domains.

It is on this point that Danilevsky's doctrine is of interest to esoteric science. By placing it alongside our study of die *Three cosmic Octaves*, we will be better able to grasp the whole sweep of the evolution of terrestrial humanity. This is of great interest to us as we face the rapid approach of die Era of the Holy Spirit during which, we reiterate, *everything* must be brought to light, not only to be grasped and registered but then to be *understood*. During this time of transition we are called on to abandon our chaotic, fragmentary and often blatantly false pictures of the evolution of *organic life on Earth*. Clear ideas about this are indispensable if we are ever to be able to orient our conscious efforts towards the harmonization of the inner contents of the notes LA, SOL and FA of the *Second cosmic Octave*, which represent this *organic life*. And as the planned evolution of the ensemble of those three notes depends directly on that of Humanity as a whole, we must clarify this point from the beginning. Once this point is known, it will allow us to determine which direction this evolution must take now, if it is to bring the new Era and lead on to the general Resurrection, its crowning.

Thus the theme of the present chapter is to clarify the present position. In the next chapter we will try to indicate practical ways of orienting our efforts in the direction of this goal we wish to attain,

II

(1)

Danilevsky published his doctrine about a century ago. There were six editions in twenty five years. Then the author was forgotten because nobody continued his work. Today, we are rediscovering him.

Danilevsky starts by stating that the classical way of subdividing history as a whole into periods: ancient, medieval, modern etc. is not natural. This is because different peoples do not evolve synchronously. The same epoch can be seen as early history for some, the middle ages of others, and the modern history of a third group. To be natural a system of historical classification should first group the peoples belonging to the same civilization, and only then should it study history within each group in terms of the different phases of their development. As a universal civilization does not exist, the usual subdivisions of a general history do not seem logical. Unless we distinguish clearly between the degrees of historical evolution on one hand, and the types participating in that evolution on the other, the natural classification of historical phenomena is impossible.

Danilevsky especially says:

"The different forms of humanity's historical life, like the various forms of flora and fauna, like the forms of Art and languages, and like the manifestation of spirit itself, tend independently to create different various types of the good, the true and the beautiful which cannot be looked at as if they all came from one another. These are modified and perfected with time, but they can also be distinguished by the different human types who carry the different civilizations. For that reason, it is only within the limits of the same type of culture, that is to say, within the framework of the same civilization,⁵ that it is possible to distinguish the stages of historical evolution defined by these terms: ancient history, the history of the middle ages and contemporary or modern times. This last classification seems to be

2. Danilevsky N. J., 'La Russie et l'Europe', a survey of the cultural and political connections which existed between the Germano-Roman world and the Slav world, 5th. edition, with posthumous notes by the author, a preface by the editor, an article by professor C. N. Bestoujeff-Riouraine and an index, 629 pp., Saint Petersburg, Strakhov, 1895. The manuscript of that work was completed towards the end of 1867. Published for first time in *Zaria (Aurora)* review in 1869.

That work, only translated into German, appeared in Berlin in 1920, with the title of *Russland und Europa*, with a preface by Kail Notzel. (And see more recently: 'Danilevsky, A Russian Totalitarian Philosopher', Robert E. McMaster, Harvard, p. 105. - Ed.)

3. Styles in architecture, schools of painting etc.

4. Monosyllables, inflectional etc.

5. We draw the reader's attention to this fact: that Danilevsky did not always use those two terms in the same sense we adopt them in our present work.

functional: the essential is to distinguish the various *civilizing historical types*, in other words, to recognize different original and independent developments on every plane: political, social, religious, the plane of customs, the scientific, artistic, industrial etc.

For example, despite the very great influence exercised by Rome on the Germano-Roman or purely Germanic States which sprang from her ruins, can we truly say that the history of Europe was only the continuation and progressive development of elements of the vanished Roman world? If we examine any domain of life, we will find new elements everywhere: the Christian religion took on a papal character, and while the bishop of Rome already held the title of pope, the papacy as we know it was only established in that Germano-Roman era, and at that time it abandoned its original meaning; the relationship between the social classes was then completely changed, as society had adopted feudalism which was unknown in the ancient world; the manners, customs, clothes, the way of life, and public and private leisure activities were no longer those of Roman times. When the Western empire was restored three centuries after its fall, the new Roman emperor, although he appeared to resemble his predecessors, actually acquired an entirely new character, that of a feudal sovereign. The feudal heads of the new society owed allegiance to him in lay affairs just as they were obedient to the pope in religious affairs. Yet even this ideal was never realized after Charlemagne, and the German emperors, in spite of their pretensions, were only feudal monarchs like any other—like the kings of France and England who soon exceeded them in power.

Science adopted the scholastic form, which can never be considered as a continuation either of ancient philosophy or of the theological systems of the great doctors of the oecumenical Church; European science passed on after that to positive experimental methods that were most uncommon in the ancient world. Most branches of Art, especially architecture, poetry and music, took on a totally different character from that of antiquity; painting in the Middle ages followed its own aims, distinguishing itself by its idealistic character and generally neglected the beauty of form too much. Only sculpture kept its imitative character and tried to follow the ancient ways, and this is probably why this branch of the Arts not only did not make any progress, but its productions proved inferior to those of its masters.

Viewed from every angle, the elements of the Roman way of life had completed their cycle of development. Having produced all the results of which they were capable, they were finally exhausted so that nothing remained which could still be developed. The civilization that followed

6. Dwiilevsky means by feudalism the form of government arising from the conquest of one people by another, the conquerors from then on forming a ruling class in the form of a hierarchic landowning aristocracy.

was thus obliged to start not from the point where Rome had stopped — which in its own way had already reached the absolute limit—but to begin anew in a direction that would allow evolution to continue.

Nor is this new way without an end and the new step forward is fated to reach its own limit.

It has always been thus, and it will always be the same. The people called on to found a new civilization must in their turn be well able to find a new start and step off in a new direction. *Progress therefore does not consist in moving always in the same direction, but in traversing the whole field of the historical activity of mankind in every possible direction.* This is what has been happening in actual fact until the present time.⁷

At the time when Danilevsky wrote this work, people were still dominated by certain 'cliches' generally accepted by science. It was estimated, for instance, that the Chinese civilization, and to a great measure the Indian civilization, had fallen into a kind of coma, the outcome of which seemed to be fatal. Yet today not only China and India but the whole of the Orient is now on the road to renaissance and progressing on that road at an accelerating pace. The renaissance of the Orient was begun by the Reforms of Peter the Great in his own country, Russia, a century and a half before the publication of Danilevsky's doctrine. Under his direction, Russia, foremost of the sleeping nations of the Orient, awoke and pointed the way to others. In the next century, Japan adopted and realized Peter's program on its own soil and for its own reasons. In the XXth century the whole of the Orient gradually began moving in the same direction. The revolution of the *Young Turks*, started in 1908, culminated under Kamal Ataturk in the establishment of a lay national State. In 1911, the Chinese revolution succeeded before our eyes in establishing a central government in China that had real power— something unknown in that country for centuries. At the end of the two world wars, after the Russian revolution and the fall of the Hapsburg monarchy and the Ottoman empire, came the emancipation of the Slav countries from the Arab world. Then decolonization led to the independence of India, Indonesia, Indo-China etc. not to mention Morocco. The awakening of national consciousness has entirely changed the face of the Orient. The situation, although different, is also recurring in depth in Africa.

7. Danilevsky, op. cit.

W

Danilevsky's system was based on an analysis of the sequence of the ages. He says:

'Research into and classification of the *civilizing historical types* presents no difficulty, as they are known to everyone. Yet people do not give them their true importance. Contrary to the rules of natural systems —and in spite of good sense — they are subjected to a general subdivision that is totally arbitrary and even irrational. Classified in chronological order, these *civilizing historical types*, in other words, the original civilizations, are as follows:⁸

1. — Egyptian
2. — Chinese
3. — Assyrio-Babylonian-Phoenician, Chaldaean or ancient Semitic
4. — ■ Indian
5. — Iranian
6. — Hebraic
7. — Hellenic
8. — Roman
9. — Neo-Semitic or Arab
10. — Germano-roman or European.

We can also add two American types to this list: the Mexican and the Peruvian, which disappeared without having had time to complete their development.

Only the people who create these civilizations can be considered as *constructive agents* in the history of humanity.

Each them has developed the original talent of its genius by leading its own life, under its own conditions, finally contributing it to the common cultural treasure of humanity... Yet *the civilizing historical types* that we have just designated as the positive agents of history cannot account for all phenomena of this kind, As we find in the solar system, besides the planets there are comets that emerge only to lose themselves again for centuries in the abyss of space, and cosmic matter that manifests in the form of shooting stars, aerolites and zodiacal light; it is the same in the *human universe*, beside the civilizing, positive and originating agents, there are others who only intervene to bring trouble. This was the case with the Huns, the Mongols and the Turks. Having fulfilled their destructive role in relation to dying civilizations they returned to their primitive state where they were of little significance, We call them the *negative agents* of humanity-

8. The quotation marks at the end of this reference are missing not only in the French text, but also in the only translation which could have placed them correctly, that of Mme d'Oncieu who worked alongside M. Mouravieff. (Ed.)

We must say right away that this has sometimes also been the role of the Germans and the Arabs. The same peoples can therefore play a constructive or a destructive role equally well. Lastly, there exist peoples... who are neither given to greatness in construction nor greatness in destruction, who were not called on to play a historical role at the first level, either positive or negative. Those people provide ethnographic material. In other words, they participate in forming the organisms of the *civilizing historical types* as a non-organic element. Without doubt they enrich and augment the variety, but for themselves they do not reach the status of historical or cultural individuality. These include for example certain Finnish tribes and a number of other elements of lesser importance.

Conversely, we also see peoples among the *civilizing historical types* who recede into this state and become ethnographical material when they are in a state of decomposition, waiting for a new formative principle to incorporate them into a new civilizing type by mixing them with other elements. This was the case of the people who had previously formed the Occidental empire.

Thus a single people can play out three different historical roles: the constructive role of the *civilizing historical types*, the destructive role of the 'calamities of God' who bring down old and dying civilizations, or lastly, the role of a group that contributes 'ethnographic material' to the aims of other peoples — and we may add, sometimes act as *catalysts*.

W

Danilevsky's system proceeds from an analysis of the succession of the ages, following which he immediately rejects what he calls the *single thread* of the evolution of humanity. But it is possible to systematize the results he obtained by this analysis in a different order. It now seems more natural to first recognize the differing *civilizing historical types* which together form *today's* humanity, and after that to make parallel studies of the history of each of these types according to Danilevsky's method. Taking the analogy he used, we shall envisage humanity *in its ensemble* as composed of various civilizing types at various degrees of development, decadence, or lethargy, just as in the family of planets each follows its own orbit although forming a coherent whole and so constantly influencing each other, as well as the whole planetary world. Analogy is not identity; but it will help us to grasp the general meaning of the historical evolution of the different civilizing types, and we shall see by this that the

■ The Western Roman Empire (Ed.). 10. Danilevsky, op. cit.

distinction made by Danilevsky between *traditional* and *isolated* civilizations (China and India) does not correspond to the facts.

The life of one civilizing type is not made up of a single cycle reaching only one peak, as Danilevsky believed, specifically referring to China. That life, like the rotation of planets around the sun, can include many cycles which pass through successive periods of lethargy, renewal, fruitful expansion and finally of decadence and slumber ... On the whole the evolution of each civilization-forming type follows a kind of sine wave, repeating through successive phases from one renaissance after another.

We should not lose sight of the fact that the nature of humanity and its groups, classified in this way, does not belong to celestial mechanics but to terrestrial biology. That is why Danilevsky correctly predicted a fatal outcome for civilizations that prove incapable of renaissance.

To apply this method the first field of study is as follows: for the whole of humanity on every part of the earth's surface, to identify the sources of all the original civilizations, whether in formation, fully fledged, in decline, in a state of lethargy or even extinct. After this, we shall group the greater and lesser peoples belonging to each of these civilizations in order to study the history of each type that has been identified in this way, not only to examine its vicissitudes—as is normally done—but also its *present age*, its chances for a new renaissance in one case, and the pace of its decline in another. In the analogy we have adopted, the civilization forming types would be similar to planets, given that the majority of the great planets of the solar system have one or more satellites while the small planets, whose number is considerable, have none, As an example — but not exhaustive — we can give a list of the major originating types that exist today.

1. From the black race — one or several emerging from lethargy;
2. From the brown race — Mexican and Peruvian — making their first movement towards renaissance; Arab
3. Chinese
4. Hebraic -at the start of their new renaissance;
5. Indian renaissance; Slaṽo-Hellenistic }
 |— in full
6. Iranian Romano-Getman — in full development and already showing
7. Hellenic many signs of decadence;
8. 11. North American — on the way to forming a new original
9. civilizing type, etc,
10. One advantage of this kind of classification is that it allows us to establish precise meanings for *culture* and *civilisation*, two different things which are often confused. By *culture* we mean everything on the psychological and moral planes that belongs properly to all the members of one civilizing

type. It is accepted that within this group each associated people is the carrier of a *specific* culture. Between them they form the components of the cultural content of that *civilizing historical type*. This way of looking at it attributes its proper historical value to each people, greater or lesser, recognizing the irreplaceable character of its cultural genius.

The conclusion from this is that moral progress necessarily depends on the cultural evolution of humanity.

By *civilisation*, we mean the ensemble of results obtained by the progress of technology, taking that notion in its widest sense.

It follows from the above that the unique elements of a culture always remain *national*. International culture' does not and cannot exist; conversely civilization, in the meaning defined above, has a natural tendency to become international during its development, and *in the end* to embrace the whole world.

III

(V

This said, it is easy to understand that any policy of forced assimilation is only an attempt to violate nature.

Yet we must not believe that the originality of *civilizing historical types* sets them in opposition to one another. On the contrary, in the same way that the specific characteristics of every nationality enrich the civilizing type to which it belongs, the originality of these types should *in principle* combine to form a harmonious and coherent cultural whole that belongs to all humanity. The proof of the former is that, without impoverishing the cultural wealth of humanity we cannot dispense with the gift brought — or to be brought — by each of these *civilizing historical types*, despite the hostility which *in fact* too often rules relations between them.

We can add that the account given in this chapter confirms our previous definitions of *culture* and *civilisation* from a different angle.

Considered from that angle and from the esoteric point of view, civilization — which tends to become universal — signifies the container of the mental (*psychiaue*) body of humanity, while culture in its variety represents its *content*.

At the present time, the container is not yet complete, while the content appears like the *filings* in the image we used to explain the true inner condition of *exterior* man.

This analogy can be pushed a very long way. If we take humanity as a whole, in its ensemble, as a *living* being, we would recognize without difficulty the anarchistic and impulsive character of its existence to which the words of St Paul would apply: *or what I would, that I do not; but what I*

hate, that I do." The rule of unstable equilibrium between opposing forces —the classic formula of international politics —is an accurate reflection of the inner existence almost universal to men.

m

Aided by Danilevsky's doctrine—now adapted to our needs—we shall return to the idea that there are correspondences between the conscious efforts that the *exterior* man must accomplish to create a magnetic centre within himself and those necessary for the formation of a *United Nations Organisation* within human society.

Those two processes are long and difficult. In both cases they only begin when 'B' influences are grasped and retained.

We have said enough about this process in man in the first volume of the present work, so that we need not return to it. But we must add that 'B' influences play a decisive role in the rational organization of the *container* of the mental (*psychique*) body of humanity.

If *consciousness (conscience)*, strongly reinforced by the catastrophe of the second world war, had not penetrated our minds, the Charter in its present form could never have been born. True, it is imperfect and very far from being consistently applied. If we study the sixteen volumes of the *Documents of the Conference of United Nations on International Organisation*, we will perceive without difficulty that its coming into the world was painful. 'A' influences then played a major role in international politics, as they still do today, acting as a brake. Yet these 'A' influences are no longer decisive as they were in the last century. Alongside decolonization; the principle of *Liberty, Equality, Fraternity gum* ground daily and will soon be accepted all over the globe. It is easy to perceive the constant and profound transformations that the international Organization is undergoing as a result.

From the esoteric point of view, the organic flaw in the Charter is that, although proclaimed in the name of the *Nations*, it has in fact created an inter-governmental organization of *States*, in which delegates are necessarily bound by the instructions they are given. Thus the UN does not at present reflect true *world opinion*, since this would express a planetary consciousness which in fact remains unknown to it.

To achieve this expression of the planetary consciousness, it would be necessary to modify the Charter to make the Organization's statutes more democratic. The formula that seems most appropriate would be the establishment of a bicameral system which would place another assembly, an

11. Romans vii: 15.

12. San Francisco, 1945, 16 volumes plus index, in collaboration with the Library of Congress, London. New York. 1946.

assembly of peoples with equal authority, alongside the current assembly of States. Sitting at the same place on the same dates, these two Assemblies would combine to form one supreme Assembly. While each Chamber could only make recommendations, the vote of the supreme Assembly would be decisive.¹³

w

It is clear that this consciousness — and the acceptance of the supreme value of 'B' influences not only by Statesmen but by governments as organisms — have not yet reached a sufficiently high level for the proposed system to take shape. Yet it would not be rash to say that in spite of all the difficulties and successive crises, clear indications exist of evolution in the direction indicated. This evolution is indispensable if this time of transition is to end in success and not in a deluge of Fire.

m

The reader must understand that this only sketches in the broad outlines of the conditions essential for establishing an esoterically meaningful *container* for humanity's psychological body, taking that as a living being in the way described above. This is a *substantial* problem, which must necessarily be solved during the decades immediately ahead of us.

Parallel efforts will have to be made in the domain of *content*. On this *essential* point, only the emergence of the New Man from within all the present *civilizing historical types outlined* above will allow us to achieve this necessary task successfully. It should be noted that this new type of Man has already started to emerge among the young generations who succeed that which emerged from the psychic anarchy engendered by the second world war.

Time and conscious efforts are necessary for new dough (*pain*) to rise. Within two or three generations the problems of the *container* and its *content* must already have been solved, at least in broad outline.

(5)

Danilevsky's vision was true. With singular foresight, by rejecting the *single thread of historical* evolution from the first, he grasped the true meaning — we would say the esoteric meaning — that Progress does not

lo'.^{see} Botis Mouravieff. *LtProbljxt dt t'AtJ<>ritfsiper. Etat!qit*, La Baconniere. Paris-Neuchitel,

consist of a constant movement in a single direction to infinity, but in humanity going over its field of historical activity in every possible direction.

Today, a century after that vision of genius, we can add something that will introduce it in a valid way to the present esoteric situation.

Danilevsky conceived the evolution of civilizing types as a panorama (*fresque*) of the past; we must try to transpose his conceptions to provide a projection of the future. For that, we must discover exactly what is the present situation.

The process is already in train. We can foresee the awakening in the near future of all the *civilizing historical types*, together forming the note LA of *organic life on Earth*, which itself consists of a principal octave and two lateral octaves. The Statesmen of tomorrow, by their unbending (*suivis*), synergic and conscious efforts, will form a *College of Precursors* drawn from the ensemble of all the civilizing types which will be capable—and must be capable—of creating the conditions necessary if the Era of the Holy Spirit is to be effectively established among humans and on the Earth.

As the shape of this possible future emerges more and more clearly from the fog of the next century, we must indicate practical measures which will allow it to become reality.

It is important to decide on the first step to be taken in this direction; then the remaining steps will be easier to accomplish.

This will certainly demand widespread action on the plane of the 'B' influences. To achieve this, we will need to change the direction of our present efforts. To place the emphasis on 'B' influences instead of on 'A' influences, those who are conscious of the urgency of this problem must adopt an invariable rule no longer to study what separates humans, individually and collectively, but to investigate what links them organically, SO that it can unite us all.

This is the theme of the next chapter.

In the *Preface* to the second part of this volume, we said that in the *mesoieric* cycle the study of the Universe should deal mainly with the question of cosmic and terrestrial *organic life*, and particularly with the role of Man, his possibilities and his capabilities.

In this chapter we will look at contemporary man in the framework in which he lives, to examine his 'historical context' more closely and show the direction of his possible evolution more clearly. This examination is indispensable as man has always fallen behind in his general evolution, and now, with the rapid approach of the era of the Holy Spirit, he must make haste to catch up or must face the danger of the 'Deluge of Fire*'. The new Era is full of marvellous promise, but it also it presents immense demands which mankind must now face.

It is within this framework that we shall briefly outline in esoteric terms the broad sweep of the historical evolution that we are now witnessing. We shall try to emphasize the demands as well as the possibilities of the time, so that we can learn whether we may be not only witnesses to but even the artisans of the near future, and if so, how we can achieve this in a positive way.

(2)

The theme of this chapter is *Christianity*, which forged our civilization and is the cradle of the next. We shall try to condense this vast subject by discarding everything that is not directly relevant.

We have said more than once in this work that the esoteric Tradition, like the Truth itself, is One—but that the Revelation of this Truth, the source of this Tradition, was not divulged all at once. The Tradition is not petrified but moving, progressively enriched by the divulgence of new Truths that are continually metered out by Revelation to meet the needs of our time and situation (*cause*). In this way, the Revelation of the New Testament enriched that of the Old, and the Testament of the new era of the Holy Spirit will enrich the two that preceded it. We rightly say: *enriched*, not *replaced*. Replacement (*abolition*) will nevertheless occur, as it did at the time of the passage from the Cycle of the Father to that of the Son, though this replacement will happen only if man's growth occurs as it should, following the principle expressed by St Paul the Apostle: *When I*

was a child, I spake as a child, I thought as a child, I reasoned as a child: but when I became a man, I put away childish things.

It is from this angle that we shall examine the situation in which we now find ourselves, to grasp the problems of tomorrow so as to find the right way to solve them.

In effect, the Tradition is One, And whoever succeeds in reaching the Truth will gain access to the same singular Truth whether he is Christian or non Christian, believer or atheist. The Way to Salvation is One, and it is open to all; but many are the tracks and varied are the paths of access which lead to it. Christ is cosmic, and whoever is united to him becomes a *Christian*, whatever the faith he confesses. King David had reached Christ, and Christ incarnated in Jesus was called the *Son of David*.

Yet when we speak of Christianity we generally mean the Christian confession, the early or historic Christian Church, the Christian Tradition and civilization.

Within the framework of this necessarily summary definition, and without speaking of the mysteries of Initiation, it is important for our study to distinguish the features which differentiate Christianity from other religions and philosophico-religious systems. The essential particularities are four in number. We shall examine them one by one.

m

I. — We should first remark that no other religion or philosophical system apart from Christianity has ever aimed at ecumenism. Even the fierce proselytism of Islam has stabilized, and that religion has suffered a set-back. The same fate is occurring to all the great religions of the world, living or dead.

Christianity in its historical evolution presents quite a different picture. It is true that Christianity also suffered certain losses in the Middle Ages, from which Islam was the main beneficiary, but it opposed the latter in the Crusades, an act of faith without precedence in the history of religions, Christianity has also suffered losses in modern times, occult losses which are impossible to estimate and which are a result of the propagation of the materialist and atheist doctrines that have accompanied the progress of science and technology. In this case we are dealing with a general phenomenon, as *progressives* regard all religions as an 'opium of the people'.

Yet there is one undeniably objective fact. Almost two thousand years ago, in a remote corner of Roman Empire, somebody taught a new

1.1 Corinthians xiii: 11. (Author's text).

2. This was true at the time, in the mid 1960's, when this book was written, and may still be true of 'inner Islam' (Ed.).

doctrine. His preaching lasted only three years and ended in defeat: the preacher was executed. But on the eve of His death, He prophesied that the Good News he had brought *would be preached in all the world for a witness unto all nations*.

If somebody were to be placed in the atmosphere of that time, taking the point of view of a cultured man of the Greco-Roman society of the day—if we suppose that this prophecy had reached his ears, then these pretensions would simply have made him smile. Today, nevertheless, it is an accomplished fact: the Gospel has been translated into more than six hundred languages, and in every part of the world everybody is able to acquire it at a modest price if not free of charge, even in the places furthest from Palestine, so far that they were unknown to the ancient Mediterranean world.

This is a miracle. And it is a miracle which we can verify (*constater*) and recognize as such, for it is a *material* realization.

This is the first particularity of Christianity.

W

II. — The importance of this fact is enormous, although it passes almost unnoticed. The progress of the Gospels across the world has been accompanied by another phenomenon which is the second particularity — one which is not given as much attention as it deserves.

The hegemony and 'colonialism' that Europe has exercised over the whole world for more than a century have spread the European civilization all over the globe. In this way any cultured person, whatever race, social class, sex or religion he belongs to, *shares* in that civilization, and education everywhere is modelled on European lines. We can also say without losing all sense of proportion that ways of thinking if not of living throughout the world are increasingly adopting the scale of values elaborated by the European mind over the centuries.

And the European civilization is essentially *Christian*. Yet nobody among us can constate just how much our ways of seeing, of thinking, of judging, are dominated and even impregnated by the maxims of the Gospel.

On the planetary plane, this universal participation in a civilization that is in essence Christian, and the extensive adoption of the moral criteria introduced by that same civilization, form a kind of underlying moral common denominator. This has been expressed on the one hand by the appearance of what we call today 'world opinion', and on the other hand, after several fruitless attempts during past and present centuries, by agreement on and by the signing of the UN Charter in San Francisco in

3. Matthew jxiv: 14.

1945. Gathering forty five signatories at the start, that organization today⁴ numbers more than a hundred, and tomorrow it will be called on to include the whole population of the earth. Despite all the imperfections of the young organism, the idea that the United Nations might be dissolved has become unthinkable.

(5)

III. —The oecumenical character in the psychological and material form of Christianity does not stop there. On the spiritual level, its distinctive feature is that it is the only religion that teaches the *General Resurrection*, one of the basic principles of its esoteric Tradition that is never mentioned in the Old Testament.

(6)

J

TV. — Lastly, the fourth distinguishing characteristic of Christianity, the most beautiful and the most important, is *Love*, the Alpha and Omega of the Christian Doctrine: *Should I speak*, said the Apostle, *with the tongues of men and of angels, if I have not love I am as sounding brass, or a tinkling cymbal. And though I have the gift of prophecy, and understand ail mysteries and all knowledge; and though I have all faith, so that I could remove mountains, and have not love, I am nothing?*

These are the principle characteristics of Christianity, Together they form a true universal common denominator, tending towards world unity and helping to achieve it We are now playing a part in a curious phenomenon: the overwhelming progress of a science and a technology that are agnostic in their essence but are the products of this European civilization and are largely responsible for its diffusion. Indirectly yet powerfully, these also serve to implant ways of study and thought throughout the world, and with these to implant a mentality and language nourished on Christian maxims, whose origin is often overlooked.

4. In the early 1060's.

5. I Corinthians xiii: 1. From the Slavonic text: *hmt* not *Charity*. Cf. Vol. I, note 2, p. xxiv.

TJ

(V

Today the world moves towards unification on the material plane as well as on the plane of the psyche, especially in its intellectual mode.

We are left with the spiritual plane. On this level, man's attitude is manifested by his *profession of Faith*.

Although somewhat late, a tendency to unity has also appeared on this plane. This is essentially religious. Little by little, religious tolerance gains ground in men's minds. The fires and flames of the inquisition, as well as the *sword or Islam*, have been relegated to History. Yet we cannot say that *religious intolerance* has disappeared from the surface of the earth; it exists; it smoulders under the ashes; sometimes it breaks out again. But today the idea of igniting a religious war would be chimerical.

In spite of this marked fraternal tendency, the problem is very difficult to solve since, in this domain, the inflexible nature of the *profession of Faith* precludes any agreement based on compromise.

The trend towards unity on the basis of mutual agreement, not of exclusive domination, has already been manifested in Christianity for more than half a century on the initiative of its Protestant branch. This idea has slowly progressed to the point where to study the possibility of a union of Christian Churches is now the order of the day.

It is known that this union has been a hope of the whole Christian world since the great schism of 1054, despite the fact that—one after the other—all attempts to realize it in practice have systematically failed. The underlying spiritual cause of this repeated failure — all political and other considerations aside—has its source in the very nature *oi the profession of Faith*.

The Orthodox Church does not admit the evolution of dogma, regarding it to have been determined by the seven CEcumenical Councils which it strictly conforms to, conserving the Apostolic *Creed* unchanged. On the contrary, the Roman Church does admit the evolution of dogma; inspired by the Emperor Charlemagne, it introduced the famous addition of the '*Filioque*' in the eighth article of the *Creed*, which concerns the Holy Spirit. In addition to the seven truly oecumenical Councils — recognized by all — it acknowledges thirteen more to bring the total number to twenty.

Other differences exist that are substantial if not essential, so that what has just been said is enough to make us understand how difficult it will be to achieve a union of Western and Eastern Churches *by means o£ entente*— that is to say, of *compromise*, and this is to say nothing of the reformed Churches derived from the Roman Church. In fact, a 'deal' concluded

6. This was written in the mid 1960's. (Ed.)

7. i.e. those recognized and accepted by both Eastern and Western churches. (Ed.)

between the two Churches on a formula such as, for example: 'We will cede to you on the "*Filioque*" if in return you give us the *Immaculate Conception*' is unthinkable, What is involved here is the *profession of Faith*, not intellectual reasoning; we either *believe* or *we do not believe*. In this context, negotiation would simply be a glaring demonstration of the fact that *we believed in nothing*.

W

I

But the problem of the unity of the world on the spiritual plane now no longer depends on the isolated or collective initiatives from enlightened minds, but on the historical movement towards material and psycho-intellectual unification. This unification is happening now as a fruit of our essentially Christian European civilization, and it necessitates a union on the spiritual plane on that same *Christian* basis — and in the direction described in this chapter. Failure to achieve this unity would lead to a rending of the collective soul of the whole of humanity in the same fashion as the partial divisions that occur in different parts of the world, of which we have become witnesses, victims or artisans since the first world war. These conflicts carry with them a real threat of a general conflagration.

This assertion may surprise more than one reader, although if we were to proceed to a full analysis it is not difficult to understand that the key to real peace — and the prosperity which depends on it, must be found on the moral and spiritual planes, and can no longer be based on the *balance of power*. This formula, which was unquestioned in the XIXth century, is already obsolete in the XXth.

It certainly seems a little odd to say that today the key to Peace is to be found in the union of the Churches. Yet if that union were to be realized on a healthy basis, *without compromise*, its influence would not be slow in spreading to other levels of human consciousness in a chain reaction like that we described in the first part of this chapter.

A sound basis without compromise: these are the indispensable conditions of success. The neglect of these conditions would unfailingly lead to an interior rending of the Churches on the day the act of union was signed. The majority of the faithful would not follow the prelates.

This being so, it is easy to understand that ail attempts to achieve unity between the Churches by means of a 'round table' would be doomed to failure in advance and might even aggravate the situation. This procedure could be compared to the addition of fractions in which only the numerators are totalled without having previously having reduced all the fractions to a common denominator. The problem is to find the necessary common denominator.

m

The main difficulty results from the rigidity of the profession of Faith. To circumvent this we should search for a solution that does not affect the *dogmas* of the different Churches. This can be done without making union impossible. The early Churches did not all profess their Faith in the same way, yet the same sacred Fire burned strongly in them all. We must therefore direct our research towards a *new point, outside the dogmas*, on which Churches can reach sincere agreement without questioning each other's profession of Faith⁸

This idea is not new. Late in the XIXth century the Russian philosopher Nicolas Fedorov, in his *Philosophy of the Common Cause?* had already presented the idea of a *Third Testament* in the Christian East, and it is worth returning to this idea now that we are faced with the rapid approach of the era of the Holy Spirit.

That *Third Testament* can be defined as including a higher degree of the Revelation — the third and last — precisely that of the Holy Spirit.

Let us repeat: we speak here of the Revelation of that *Gnosis* which Jesus transmitted to James the Just, John, and Peter after His resurrection. 'The latter gave it to the other Apostles; and the other apostles gave it to the seventy, one of whom was Barnabas'.¹⁰

This *Gnosis*, transmitted orally from one to the other down to Clement of Alexandria, Origen's master, was then hermetized because there were too many lawsuits and dissensions, to be divulged and taught once again today with the approach of the era of the Holy Spirit—the time when *all* that has been hidden must be brought to light, especially the *Gnosis* that was conserved in the esoteric Tradition of Orthodoxy. This must now be formulated in terms quite intelligible to the cultured reader, using the Cartesian mind and language.

This is the mission of *Gnosis*, of which the third and last volume will mark the achievement, laying a stone in the foundations of the sublime Temple of the *Third Testament, which must* be built by the collective efforts of the *Initiated* to serve as a common *denominator* for the Churches of Christ.

8, The[^]spiritual unification of the peoples forming the Hellenistic world was achieved in the same way: the preaching of the Apostles was the *mw point* which induced the progressive rallying of

n?P^{OTav}- Nicolas Fed., director of Roumiantzeff Library (Lenin Library since the Revolution) fMosapbit dt la Casat cammt, Moscow, Verny, 1906-1912, 2 vols.

K>. Clemen of Alexandria, TbrStromata, 1,1 -11,3; Hypostases, fragments, quoted by Eusebius, EfdtsiaittiatHistory, Greek text, translation and annotation by Gvis\ivz~&iTAy, Sources chrititMitu fans, Ed. du Cerf. 1952-1960. II, 1-4. The Apostle Barnabas was St Paul's companion.

THIRD PART
THE WAY

CHAPTER XV

(1)

This work is planned as a cycle of successively closer approaches to the centre. That is why in this second volume we return to the question of the *Way*. At this point we believe that it is necessary to discover the exact place of the cultured man of our civilization and era in the light of the esoteric doctrine. This is a partial recapitulation of our acquired knowledge of the human Personality as it is shaped by the conditions of contemporary life of this milieu as we now understand it. This takes the form of an analysis of *exterior* man, belonging — we repeat — to the cultivated stratum of society.

The data obtained by this analysis cannot of course be applied to every member of this elite which, taken as a whole, forms the ruling class and plays the role of a moral guide for human society. Let us avoid generalizations: enforced equality is a misleading formula, it ignores the fact that a basic principle of Nature is unity in variety. It simply describes common stereotypes that form useful bases for analysis; we can leave the many and varied exceptions on one side until later.

(2)

To make the proposed psychological study easier we believe that it will be useful to introduce an idea that goes back to Greek Mythology, where it appears in the guise of a fabulous monster: the *Chimera*.

In mythology, it appears to have the head of a lion, the body of a goat, the tail of a dragon, and it spews out vortexes of flame and fire. It was said that the Chimera's father was Typhon, the principle of evil and sterility, and his mother was Echidna, half woman and half serpent who was fathered by Chrysaor, born from the blood of Medusa. From Greek Mythology, the image of the Chimera passed into Christianity. We find it as an ornamental motif on certain Gothic cathedrals. For example, the gargoyles of Notre-Dame in Paris were sculptured in the form of Chimerae with stylized lion's heads and only the upper part of the body. In certain orthodox cathedrals chimerae form the ornament of the bishop's throne. Sculptured in wood, they are shown complete, crouching on each side of the seat, where they serve as armrests.

1. They are also used in similar ways in Orthodox monasteries such as those on Mount Athos. (Ed.)

The original esoteric significance of this monster has been lost, although its symbolic meaning is known and its name has passed into current language: by *chimera* we mean a false idea or a vain imagining. A *chimeric mind* sustains itself on illusions, and a *chimeric project* collapses when tested against facts, being groundless or unrealizable.

Let us try to rediscover the esoteric significance of the Chimera, hidden in Myth by initiatory tradition. We know that all beings in Nature are divided into three categories depending on the number of centres in their psyche. The first category is of beings having a psyche of only one centre: obviously the motor centre. Beings belonging to the second category have two centres: motor and emotional. Lastly, as beings possessing three centres, humans alone have a motor centre, an emotional centre, and an intellectual centre.

The fabulous Chimera is an animal of a higher type; with its lion's head and the body of a goat, it incontestably ranks in the second category, that of beings possessing two centres in the psyche. If it was a living being, because of this fact it would have motor and emotional centres. It does actually have two centres in the psyche, but these are the motor and the intellectual. Thus it can only have an unreal existence, chimeric in the true meaning of that word, as no bi-centred beings exist in Nature other than those with motor and emotional centres.

For what reason was this monster introduced into the Mythology of remote Antiquity which goes back to the very sources of Initiation?

The symbolism of the Chimera must be studied in both its aspects, and this will help us to better understand the condition of *exterior* man, who is dominated by the provisional T of the incomplete Personality as well as by the times in which he spends his life, that is to say, (in which we spend) *our*

(*)

Let us return to the original diagram of the three centres of the psyche and the positive and negative duality of their normal functioning: We have seen that the motor centre is the most developed and the best organized of these three centres. When man is born, the latter centre is already functioning in a very complex way. The spermatozoa has a motor centre whose essential role is expressed by the motor function, while the instinctive function is ensured by the ovule and, starting from the moment of conception, by the instinctive part of the mother's motor centre. The motor centre presides over the constitution of the foetal body and regulates its growth and then its development until the pregnancy comes to term. After the birth of the child, the individualized motor centre ensures the

growth of the human body and, with the help of the intellectual centre—or sometimes guided by it, its development, which includes a physical and psycho-physical apprenticeship. This means that in man, from day of his birth the motor centre works fully in its positive, instinctive as well as its negative motor parts. It is also the bearer of all the predispositions, those of the body as well as the psyche, that man gets through the blood of his heredity, as well as from his own early experiences.



FIG. 11

If, in the case of motor centre, a certain amount of education and instruction are necessary to complete its development, in the case of intellectual centre the opposite is true, and everything must be done anew, for it is born virgin: a *tabula rasa*. It must learn everything, and its entire formation must yet be carried out.

(4)

One might say that the whole modern system of public education — primary, secondary and higher — is oriented almost exclusively towards the growth and development of the intellectual centre. Our culture is intellectual par excellence; the title of *Intellectual* signifies that a man of our times, whatever his social class, is able to play an active part in the evolution of contemporary culture.

Alongside the exaggerated development of the motor and intellectual centres, the emotional centre in cultured contemporary man looks like a poor relation. In effect human society—now mediated by public authorities —has little concern for its development. Not only is religious instruction

2. It is the same for the lower emotional centre in the newborn. It is a *tabula rasa*, and this allows it to receive certain energies from the higher emotional centre, since this is ever pure. But it still needs to be completely educated, just like the lower intellectual centre.

no longer obligatory in civilized countries, but it is influenced by the prevailing mood; it is, one might say, 'intellectualized'. It is therefore not surprising that, left to its own fate, man's emotional centre degenerates even further with age. For the law is explicit: that which does not grow and develop will degenerate as a result. This state goes unnoticed. On the one hand it is universal, and on the other the *circumstances* in which we now live *never demand of man the development of his emotional centre*, as occurs with the other two centres. By the intensive development of his motor or his intellectual centre, the man of our times can build a brilliant career with no need to turn to the essential functions of the emotional centre. The opposite is true. Man sometimes fears its interference, as it can 'shuffle the cards' of his cold and realist calculations and hinder a career pursued under the guidance of the two other centres, and in this way it can considerably complicate the efforts he makes to reach the only ends that seem real to him.

In general, the emotional centre is more active in very young children before they become conscious of the *T* of their Personality, because it is then appreciably more pure. If the child's motor centre does not include too many innate predispositions, nor are they too negative, and as long as his intellectual centre is not yet sufficiently developed to dominate, the emotional centre will act and the motor centre will often back down and follow in its footsteps, particularly if the type of the child is man 2. Due to education and training, oriented in our civilization towards the intensive training of the negative part of the motor centre and towards an intellectual culture, in cultured circles of the life of the psyche the activity of the emotional centre is forced even further into the background, to fall into a sleep bordering on lethargy.

This is the principle cause of the obviously unbalanced development of the human Personality: highly intelligent, and skilful enough as far as the negative part of his motor centre is concerned, man is dynamic in these two domains yet reveals weakness and a striking passivity on the emotional plane.

W

I

The life of our times imposes a very great but one sided tension on the functions of man's psyche—especially on his *attention* in all its aspects, as well as on his intellectual capacities. This fact creates a reaction in man and leads to a need for *relaxation* in order to restore equilibrium.

If the development of the centres of his psyche had been balanced, this *relaxation* would have found its normal expression in his positive

3. Fi: *brouiikr Its cartes*

emotional life, which would then be adequate to his intellectual culture, and had that been the case, man's instinctive and motor life, in times of *relaxation*, would have been synchronized with the vibration of the emotional centre, enveloping that of the intellectual centre. This would give access to the path towards the *sublimation of sex*. Moments of *relaxation* conceived in this way would then lead to *creative inspiration*, which is analogous on the plane of the psyche to *conception* on the physical plane.

All the opportunities for man's esoteric evolution while working in the world lie in this. Nevertheless, several preliminary conditions must be fulfilled before he can reach this possibility. This is a possibility (*apanage*) for man 4, who is approaching the *second Threshold* and ready to pass through the Gate of the Kingdom of Heaven with his body and soul united to those of his polar being.

It is obvious that this is not the case for someone who has just crossed the *first Threshold* and struggles to climb the *Staircase*. But the neophyte must never lose sight of this possible result of his efforts, the first tangible result to which he must ardently aspire. It is by keeping the image of this divine state constantly present in mind, while *at the same time* constating his *actual state* in its naked truth, that he will be able to create within himself a 'difference of potential' capable of producing a high tension current of energy sufficiently strong to allow him to pursue his esoteric work with some chance of success.

(*)

In order to be better aware of the *true state* of the Personality of the contemporary cultured man, we shall recapitulate what we know about all this. Let us observe that generally even if the positive part of the emotional centre is in an almost uninterrupted state of lethargy, if not actually paralysed, its negative part acts frequently. It reacts particularly to disagreeable shocks either from the outside or from within. These are the *negative emotions* we have already mentioned, remarking on their destructive effects.⁴ In that respect, man largely follows the habits of animals: at the least unpleasantness the machinery of negative emodons begins to act. In general, the effect of this negative reaction greatly exceeds the importance of its cause. Having said this, we can represent the Personality of cultured contemporary man by amending the previous diagram as follows:

4. Cf. Volume I, p. 23; p. 175.

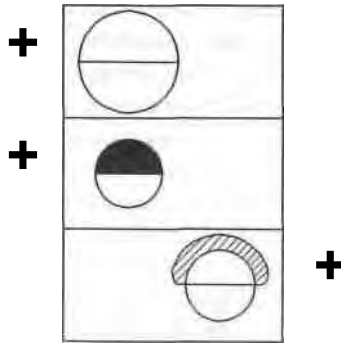

FIG. 12

If we had wanted to draw this diagram in zoomorphic form, we would logically have done so by using the Chimera: the head of a lion, the body of a goat, and the tail of a dragon. This is a *chimerical* being, vomiting vortexes of flame and fire on every occasion.

In his march towards death, a man whose psyche is formed in this way can in fact, like the Chimera, lay claim to the paternity of Typhon, the principle of evil and esoteric sterility. This is the hellenic image of the Devil in his aspect of liar and father of lies, of whom Jesus spoke.⁵ In the Greek text of that passage of the gospel according to St John we read, *to pseudos (TO tpeCBos)*, a word that has passed into the European languages and has come to signify false. We can now better penetrate the meaning of Christ's words to the Pharisees: *you have the Devu'for a father and'you want to accomplish the covetousness of your father.*

In such a being, the intellectual centre is generally very developed. Although this phenomenon is positive in itself, yet the result is that the intellectual centre weighs heavily on the remainder of the Personality. This imbalance is exaggerated even further by the fact, explained above, that the positive part of the emotional centre — the most precious organ in the whole organism of man's psyche — is semi-paralysed. From then on the negative part, left to itself, is deprived of all possibility of fulfilling its useful or constructive role of supporting the other in its work, It only comes into movement to allow man to express his *negative emotions*, so he does so over and over again in spite of their destructive effects.

Let us note once again that this state of man's emotional centre is analogous to that of wild animals, in which the positive part of this centre generally remains unawakened. In cultured man it falls into lethargy

5. John vtii: 44.

6 .Ibid. The more norma] leading is: 'Ye art of'yourfather the devil, and the lusts ojyourfatheryouwill do.' (King James version)

because it is neglected. The difference is that an animal cannot awaken it except by ceasing to be an animal, whereas man can do this at any time by conscious efforts made in appropriate exercises,

As the diagram above shows, in the majority of cultured men of our times the positive part of the emotional centre is practically paralysed after the highly intensive development of an intellectual culture: feelings too easily give way to calculation.

As for the motor centre, in the case that concerns us this works at full capacity. Responsible for the natural instinctive and motor functions that ensure the life of the organism and the movements of the body, it has always been the object of special training: military, sporting, artistic etc. But in addition, because of the state of lethargy of the positive part of the emotional centre in contemporary man, for good or ill the motor centre also replaces it in its functions. The motor centre replaces the positive tenderness of *affection*, which the dormant emotional centre is incapable of providing, by the *passionate* tenderness of sensations dominated by a spirit of possession. In this domain too, the life of man's psyche is then lowered to the level of that of an animal.

All this allows us to better understand the structure of man's Personality, which is then practically reduced to bicentrism, the very characteristic of the *chimera*: a lion's head to represent intelligence and an animal's body with the tail of a dragon to symbolize passions deprived of all feeling. The fire and flames vomited from its mouth are the fire of discord and the flame of intellectualized passions stimulated by usurped sexual energy.

(7)

That is a schematic but realistic representation of the Personality of a cultivated man of our times, whose emotional centre is neglected. That state is full of danger. For without the compass represented by the positive part of that centre, man, although inheritor of a great intellectual culture which can be of considerable value to him and those around him and finally for human society, remains entirely weaponless when faced with his own passions, especially if those are induced by or even associated with a sexual inclination that is deformed in one way or another. This can even bar his path to esoteric evolution. The danger of this situation becomes obvious when we compare the two figures that represent the psyche's instrument of *morality* in the two cases: — the *normal case*, that of a Personality which is developed and equilibrated;

7. Refer to I Corinthians vi: 10.

— the *abnormal case* that is far too frequent, that of the bicentric or chimeric Personality.

To get to a technically true representation of how morality functions in *exterior* man, we should know that the 'links' between the three centres of the psyche, of which we spoke in the first volume, are in reality much more complex than we previously described.⁸ These links are realized by means of the sectors in each centre that represent the two others in their positive as well as their negative expressions. The diagram of a normal case may be as shown as follows;

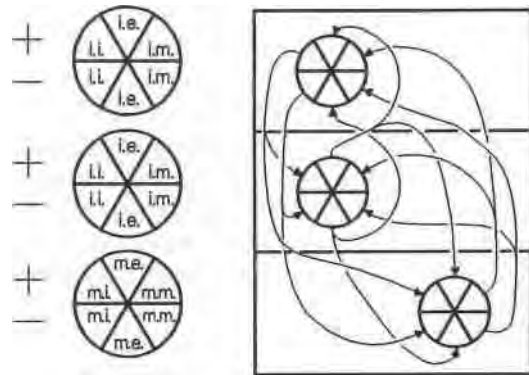

FIG. 13

We find twelve links in that figure, four of which begin from each of the three centres. This represents the complete instrument of human morality[^] an instrument that is in itself very sensitive, and whose twelve chords correspond exactly with the structure of this phenomenon.

In the case we examined above, however, because the positive part of the emotional centre is practically paralysed, the negative part cannot exercise its positive role. The only thing left to it is to make the centre vibrate with negative activity in the form of negative emotions, But negative emotions of this composite nature take coarse/orwj, ruled by sensations and passions that belong to the motor centre. This allows us to constate yet again that in this unbalanced or *chimeric* aspect of the human Personality the emotional centre must be considered as an almost negligible quantity. On this basis the previous diagram must be modified as shown in figure 14 (overleaf).

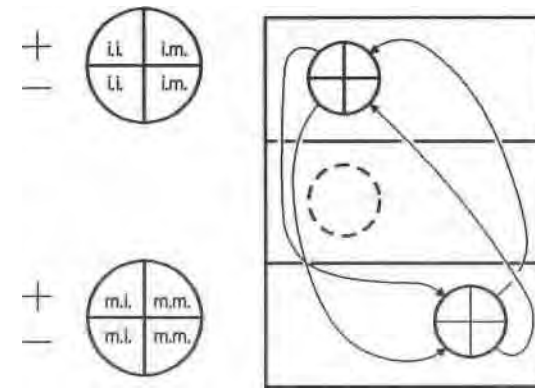

FIG. 14

When the emotional centre is deprived of its normal functions, the number of links between centres is reduced from twelve to four. The eight chords which correspond to the finest and most subtle components of human *morality* are eliminated. This is due to the changes that occur in the structure of both the intellectual and motor centres; changes that lead to the impoverishment of both as the emotional sectors of these two centres practically disappear, due to the disappearance of their source since the emotional centre is in a state of lethargy. Because of this, the intellectual as well as the motor centre is left with only four active sectors instead of six.

Psychologically, this means that, having reached this state of disequilibrium in his Personality, man is from then on governed only by *intellectual* and *instinctive-motor* considerations. This human rype — the chimeric — is often found among the cultured classes of our time. It can produce people of great intellectual ability, but since intelligence is agnostic by nature and they are not oriented by the compass⁹ of the emotional centre, such people become *amoral*. For them *everything is permissible except what is forbidden*: or rather, what is not *punishable*,

When man of this psychological type feels the need for *relaxation*—which is legitimate in itself—he falls under sway of his bodily instincts. His *T* of the body then takes the place of the *T* of the unbalanced Personality. However, the *T* of the body only has the use of the motor centre, which is equally mutilated. Since this is reduced to four sectors instead of six it too is deprived of a compass. Man then turns towards 'small pleasures' or 'grand passions' in which he satisfies all his senses, driven by an inventive intellectual imagination while the two centres, motor and intellectual, are fed by energy stolen from the sexual centre.

8. Cf. Volume I, Fig. 22.

5. The lack of this is felt is a lack of purpose. (Ed.)

If we have given this whole chapter to this analysis it is because the phenomenon it reveals is much more frequent than one would believe. True, we have discussed an extreme case so that it is more clearly impressed on the reader's mind; but there exist other cases that are less extreme and more subtle.

To put a final point to this, we have only to answer the question that confronts those who wish to pass from words to acts: how can we awaken the emotional centre and then develop it? The answer is simple: by mastering negative emotions and transmuting them into positive emotions.

(V)

We have pointed out more than once that the majority of people belonging to the cultured stratum of our society who are seriously interested in esoteric studies have in one way or another undergone an inner collapse in their lives. This collapse often floors them. However, after going through this bankruptcy, many of them recover. These are the people suitable for esoteric work.

From this point of view, the value of moral bankruptcy lies in the fact that someone who has been through this can recognize not only theoretically, but through experience and with a broken heart, the futility of chimerical happiness, 'bourgeois' self-satisfaction, and human pride. Such a bankruptcy is therefore an excellent starting point from which to search for the *Way* which leads to *Lift*,

Sometimes, however, a man endeavours to 'start his life' all over again. He believes that by taking into account and lucidly analysing his experiences he can do better in spite of his previous failure. But this is nothing but a new illusion which generally leads to a new bankruptcy, something that is extremely logical as long as the new experience contains nothing which is really new: in a different form he simply repeats the same 'adventure' again and again. Carried away by the psychological pressure that the *Genera/Law* exercises over him, he does not pause to reflect that the old path can only lead him to the old result.

There are always frenzied people who start all over again in spite of everything, sometimes several times over. They are happy enough with the adventure itself, taking its unwinding as the goal, as they do not know that this romance can have a *real goal*, one that is even higher and more beautiful than the flirtation or marriage that so often proves the tomb of love. Side by side with these 'enthusiasts' we meet people who, after one or more negative experiences, end by perceiving the diabolical element in the snare they are caught in.

Having no faith in their hearts, they confine themselves to a scepticism which they describe as realism, sheltering behind the classic opinion that happiness only lasts as long as the Illusion is maintained. But there is a third category of people who are awakened by recurring bankruptcy. Stimulated instead of subdued by failure, they do not consent to lay down their arms. With hearts full of faith, they seek a way out from this vicious circle like the prisoner who, shut in a dark cell, searches blindly for an exit.

Everything can be straightened out if it is not too late; if man is not morally crushed or physically spent and if, even after having gone through one or more moral bankruptcies, he has not yet lost the faculty for burning with enthusiasm. Otherwise, it is useless to break those lances.

The human being who analyses, in the light of the esoteric doctrine, the circumstances that have provoked his moral bankruptcy is bound to conclude that this failure is directly due to the neglected state into which his emotional centre has fallen. If he goes back to the causes and the events that have been lived, he will see that his partner is not to blame. We must never forget that intelligence is agnostic by nature, so that it is only through the correct and intense functioning of his emotional centre that the *exterior* man can feel the 'B' influences in life without confusing them with the 'A' influences. It is thanks to this discernment, stimulated by a keen interest in the work and by the ardent desire to reach the Real, that a *magnetic centre* begins to form in the neophyte. Only then can he come out of the darkness as he desires. The reader may remember that the *magnetic centre* is formed starting from the lower emotional centre, which it progressively absorbs before it is finally integrated into the higher emotional centre, the doorway to Light and real Life.

Leaving out some details, this is the technique of esoteric evolution. In other words, the development of the Personality — the astral fcetus —and the equilibrium of its organs, the lower centres, which leads to the second Birth, *cannot be envisaged without the previous complete development of the lower emotional centre*. This is the first key and the real beginning of esoteric evolution.

Let us now study a few typical cases of unbalanced Personality in *exterior* men, as this unbalanced character is responsible for the moral bankruptcy described above. This should make it easier for us to recognize our own case and, having analysed it in the light of esoteric science, to correct the situation through conscious efforts.

First case.

To begin with, let us take the case of imbalance we described in the previous chapter: that of the cultured man of our times, man 3, who has received extensive intellectual training (*formation*) and is successfully exercising an intellectual profession. We have already sufficiently examined the working of the Personality of this type of man, and the characteristic

interdependence of the centres of his psyche, which automatically leads to a limping equilibrium, so that we need never return to it again.

We shall try to recognize one or more human psychological types to which this kind of deformation gives birth. To do this, let us add details to the previous figure (fig.14) as follows:

FIG. 15

We can see from this that this highly developed intellectual centre is deformed in such a way that the hypertrophied pure intellectual and intellectual-motor sectors, have almost entirely smothered the emotional sectors. For reasons given in the previous chapter, this smothering often goes so far that, to pick out the resulting situation in relief, we have shown the emotional sectors in figure 14 in the background. These sectors are in a lethargic state like that of their source; if they are not non-existent in practical terms they are at the least always *inoperative*.

In the motor centre of the human type we are studying, the smothering of the emotional sectors has a different character. Although the functioning of those sectors is almost nonexistent—just as in the intellectual centre, and again due to the lethargic state of the emotional centre—because of the *principle of Equilibrium* there appears little by little a kind of tumour of the psyche. This tumour of hypersensitivity builds up over the positive part of the motor centre; it is shown in the diagram by a *cap* in the shape of a half-moon. It covers the higher semicircle of the motor centre.

This tumour, which is formed and kept working by sexual energy and is connected to the three sectors of the positive part of the motor centre, possesses its own tripartite structure in which the proportions (of the centres in the Personality as a whole) are inverted: the emotional part of the tumour is much more developed than the intellectual and motor parts. The following diagram gives details of the motor centre with its *cap*:

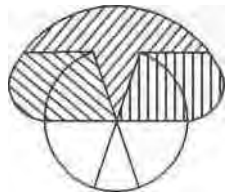

Emotional ¥////,
 Intellectual ^N^ Motor

FIG. 16

Let us remember that in the organism of this type of human *psyche*, this Ctf^[^]-tumour *stands in for* the emotional centre. It does this as best it can, substituting sensations impregnated with usurped sexual energy for true feelings: this carnal tenderness replaces the noble tenderness of the heart. In this type of man the influence of the Absolute III eliminates and replaces that of the Absolute II. A man like this, whose hypertrophied intellectual centre outweighs his Personality as a whole, only takes into account his own reasons so that, to use the language of the tradition, he never stops *crucifying Christ*.

Sexual energy, SI-12, is not of same nature as the pure feeling of SOL-12, although it possesses the same fineness. The latter (energy) is missing in a man of this type. That is why he falls under the domination of the former. As long as this situation prevails, such a man proves incapable of opposing an effective resistance to this dominion, and as long as the positive part of his emotive centre is lethargic, man has no reason to resist, and indeed does not resist the calls of sex that result from this condition of his centres. Conversely, in moments of *relaxation*, with the tacit agreement of the T of the Personality, which desires a change of impressions, the T of the body dictates its will to man instead of his real T.

This situation explains the paradoxes of our life. In spite of all appearances it slips away, guided by the general principle expressed in the formula: *cherche^ lafemme ...*

From behind the scenes of waking consciousness, and under the influence of the Moon's soporific rays, the Absolute ITI exercises a despotic power over man. To him man joyfully brings his offerings. Moreover, this is according to the *GeneralLaw*, because without procreation to ensure the incarnation of Souls, the human species would have ceased to exist and the result would be the collapse of our *Ray of Creation*.

To complete this description, and to place the type we have just analysed in its proper context, let us add that man 3, formed— or rather deformed —

in this way, now lives and works in an *ambiance* 3, which has been shaped in our civilization by the attitude of an elite composed of various intellectual types who share a common characteristic, which is their desire to taste the well-being that the aristocrat and then the bourgeois enjoyed before them: The power that money confers to obtain comfort and distractions to balance the considerable and sometimes exhausting efforts the Intellectual has to make in his profession,

In the esoteric sense, however, Intellectual does not only mean people involved in the sphere of university life. In the meaning used by the Doctrine, the term Intellectual refers to all men 3. In the more restricted meaning of the present analysis, we mean every man 3 who works in some branch of human activity which enables them to use their intellectual capacities to the maximum: a domain which extends from the most simple calculations and combinations directly concerned with material gains, to research leading to discoveries in the different branches of the pure or applied sciences.

Scholars, diplomats, engineers, lawyers and politicians are found here alongside civil servants, financiers, merchants and industrialists etc. Promoters, negotiators and journalists belong to the same category. The Doctrine also includes all kinds of doubtful people: business manipulators, knights of industry, cheats etc, people of little scruples in their activities who yet do not transgress the limits fixed by legality. Their major concern is the search for large and easy gains while keeping up appearances. This category also includes all kinds of prostitutes and social climbers. It is true that the intelligence of these people is far from being as developed and subtle as that of scholars. Yet it is sharp enough to analyse the terms of legislation or contract and discover loopholes which allow them to suggest a false interpretation by which they can profit.

One may say that in our days, this kind of deformation is quite common in the average type of man 3.

(4)

Second case.

This kind of imbalance in the Personality of man 3 may also be found in the equally chimerical Personality of a certain type of man 1. But in the latter case this Personality imbalance makes a criminal. Here is the diagram of this case:

Details of cap

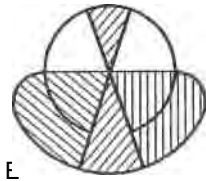

E
 motional /////
 Intellectual VS^;
 Motor Mill

FIG. 17 FIG. 18

We will constate a certain analogy between this figure and the one shown in fig. 15, In both cases, the emotional centre is asleep. But in this diagram the relative development of the intellectual and motor centres is inverted and the *cap* is in a different place, so that it now covers the negative semicircle of the intellectual centre, This *cap* is the instrument that allows this type of man 1 to place his intellectual centre, sometimes highly developed, at the service of a malevolent spirit which expresses his bestial instincts. When his criminal projects succeed, it is through this *cap* that the man experiences the savage joy that his hypertrophied motor centre manifests.

While the man 3 who has deceitful or amoral tendencies is careful not to transgress the limits of those acts that fall within the law, this type of man 1 runs headlong into that risk. This comes from the fact that the *cap*, although facilitating his use of the intellectual centre to elaborate his criminal projects, nevertheless prevents him from extending his reasoning to foresee the almost inevitable consequences of the crimes he commits.

From one point of view, this particularity distinguishes an unscrupulous cheat of type 3 from the man of type 1 we have just analysed. It is also this particularity which makes of the latter an inveterate offender.

However, we should not confuse this classic type of criminal with the honest man who commits a crime because of fatal circumstances or who is blinded by momentary weakness. People of this category are not true criminals, but unhappy wretches.

(5)

Third case.

We can now study the type of man 2 who occupied the leading place in European society from the early Middle Ages until the Renaissance: the *Knight*. In the Intellectual all efforts are directed towards the development and exploitation of the faculties acquired by the intellectual centre, while the neglected emotional centre falls into almost lethargic mental sleep. In the *Knight*, we observe the opposite phenomenon: a great development of the lower emotional centre that relegates the intellectual centre to the background of waking consciousness. However, the intellectual centre of this type of man cannot, and has never, attained the degree of lethargy which characterizes the emotional centre of man 3. Indeed, although the idea seems difficult to accept, man can do without emotion in his personal life: professional, family, social or political. Even though, from the esoteric point of view, this life has only chimerical value, it is nevertheless a real possibility, especially if the environment is favourable like that which prevails in our times and our civilization But man cannot abolish his intelligence to the same measure. In that situation he would lower himself purely and simply to the level of the beast, with all the consequences that follow. He would become an idiot in the eyes of men. Such cases exist: a healthy, sometimes quite strong body with a tendency to obesity, very developed sexual functions, a highly emotional life but coarse and uses primitive language. These are pathological cases, which may be represented by the diagram in Fig. 19.

The diagram of the *Knight* is quite different (see fig. 20):

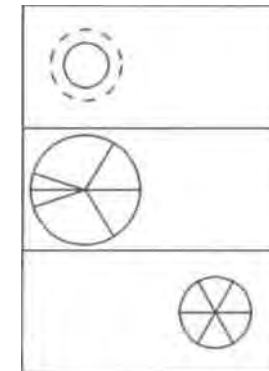

FIG. 20

FIG. 19

The main characteristics of the *Knighly* type are his sense of equity and his devotion to duty. He aspires to accomplish deeds which may even lead him to sacrifice his life, and he will take any risk gladly for a beautiful ideal. One must not think that this type of *Knighly* only belongs to bygone ages and that he is extinct today. This type always exists. However, he seldom comes to power in the environment 3 that characterizes our epoch. For modern methods of selection demand a certain suppleness, an elasticity of character on the part of those who aspire to leading roles and which for the *Knighly* is completely foreign to his nature. If he competes in the race towards the summit of the human hierarchy, he soon gives up the struggle, either by his own action or because the circumstances eliminate him automatically. We can come across this type of human being in all strata of society; but in our intellectualized environment he is unlucky in business as well as in politics. On the other hand, he may make a military career or find a post in the magistracy or devote himself to social work. The different degree of development, and the particular nature of his intellectual and motor centres, lead to a whole series of psychic and psychological shadings in this type of man 2. Besides this classical type of *Knighly*, there are others who fall into the same general category, like the hermit-monk, the Prophet, and the Apostle. One may also include artists of all kinds.

(*)

Fourth case,

There exists another type of deformation of the Personality of the man 2. But it is to be found only in a few rare cases, above all in the Christian Orthodox, Muslim or Hindu Orient. It is *the man who is mad for the glory of God*, This case may be represented as follows:

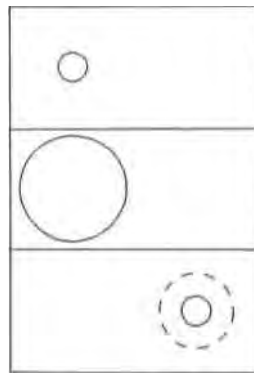

FIG. 21

These *madmen* mortify their body in all kinds of ways; dressed in rags, they spurn money, sexual pleasure, power, the rulers of this world, and death. Such a *madman* is afraid of nothing, he is even less afraid than the common type of *Knighly*, for nothing is important to him, neither 'considerations' nor respect for conventions. In Russia, in times past, these *madmen* enjoyed a certain esteem. Seated in the outer sanctuary of a cathedral, they would tell the powerful men who came there a few home-truths. Even the Czars did not escape criticism, and often altered their decisions if the latter were subject to the disapproval of these men. They were highly venerated by all, as they were believed to be 'men of God', and were supposed to possess the faculty of *thought-reading*. So the *man mad for the glory of God* is also a man 2, just like the *Knighly*, the army officer, the hermit-monk or the magistrate, each type representing the characteristic shadings of his type.

Fifth case.

Another typical deformation of human Personality also exists. This case is rather rare in its extreme form but today as in the past weaker forms can be met in all eras and strata of society, especially in the Orient. Three or four hundred years ago this human type became widespread in the West: this was the *sorcerer*. A ferocious fight was waged against them.

The case we are to study is that of a man 1 whose highly developed motor centre entirely dominates his emotional centre. In this type of man the latter is awake and even quite developed, but it is under the sway of the motor centre and as a result it is richly nourished by usurped sexual energy. As in the fourth case, the intellectual centre is not entirely asleep: the negative part of this centre is paralysed but the positive part is completely under the domination of the motor centre. That is why this type of man feels no doubt. This fact provides him with extraordinary strength and endows his psyche with a suggestive, hypnotic dynamism.

This type of man 1 includes fakirs, sorcerers, magicians: *volkhvy* in Slavonic. Though unbalanced in its development, this Personality has lost all its anarchistic characteristics: it is subjected to an iron discipline exercised by the motor centre in the place of the *magnetic centre*, with the *T* of the body predominant. This kind of man can acquire certain powers, but their nature differs from that of the *gifts of the Holy Spirit* which *interior* men acquire.

A magician's power —that of a Cagliostro, Rasputin and their like —is based, as we said, on excessive development of the motor centre, which dominates the other two. The working of the intellectual centre is reduced

to what is strictly necessary to ensure vital needs and to elaborate projects; its negative part is smothered, and this is what leads to the absence of doubt. The emotional centre is not only not smothered but is rather well developed. However, this development is unbalanced, as it is not the result of correct discernment of 'B' from 'A' influences, but of the accumulation of those of the latter whose action, although different in quality, *lks parallel to the 'B' influences*. Lastly, an overgrowth on the psyche is formed on the right side of the emotional centre of this type of man 1, which shows all the characteristics of an impure or *black magnetic centre*. While the *magnetic centre* formed of 'B' influences is a subsidiary organ enabling esoteric development, this *black magnetic centre* formed by 'A' influences can clearly not be oriented towards esoteric goals. Shaped by 'A' influences whose action runs parallel to the 'B' influences, the orientation of this *black magnetic centre* is automatically directed towards objectives limited to within the perimeter of *exterior* life. These objectives are well known; money, women, and power in all their forms.

This type of unbalanced development of Personality, which gives birth to the *sorcerer* in all its aspects, is shown below:



FIG. 22

The reader will remember the diagram in chapter VI of the first volume (fig. 21), accompanied there by a brief explanation. Evidently the *black magnetic centre*, instead of sending man forward towards the second Birth and so towards the union of his Personality with his real T, emphasizes and crystallizes the T of the Personality and inspires it with the strength it needs to impose itself on other Personalities who are in an unstable inner state.

It is important to know that this human type exists, especially for those who have an inclination for esoteric research and who begin by looking for the 'marvellous.* While awaiting an encounter with a guide, their Person-

ality is wide open to the influences emanating from this type of man, and they may easily fall under his sway. Such a 'guide'¹ may be represented by the diagram from the first volume we have just described. We reproduce it here because of its great importance:

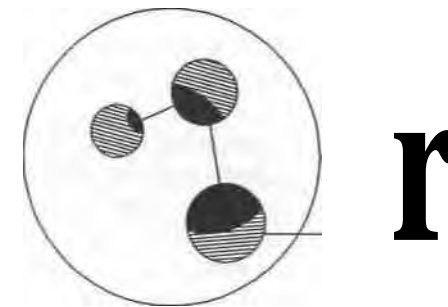

FIG. 23

The scriptures and authorized commentaries have drawn seekers' attention to this danger many times. This is why it is written that *the children of this world are more cunning than the children of light*.¹ Beginning long ago, many warnings have been given about this.²

Besides giving birth to magicians, this type of man gives rise to false prophets,³ false Christs, and even the Antichrist.⁴

It is curious to see how much these false prophets, magicians and 'christs', impressed themselves on the imagination of the men —and even more of the women of the past. It is the same today.

For there is a type of human being who declines all moral responsibility for himself or for those to whom he is in duty bound. One comes across this type quite often, always trying to find someone else to shoulder his responsibilities as long as this someone else possesses some kind of authority, earned or otherwise. These people are open to any form of hypnotic suggestion and practically ask to be hypnotized. They are of good faith, but they search for the 'marvellous' because they are too weak or too lazy to undertake esoteric work successfully. And the 'wolves'⁵ devour them finding justification in the fact that they are only the 'scourings of humanity.' But this is not true; for 'scourings' who are converted can become key figures on the esoteric chess-board. Mental apathy and emotional inertia are responsible for tipping man down the slope of least

1. Luke xvi: 8. From the Slavonic text.

2. Acts xx: 29.

3. Matthew vii: 15; xxiv: 24; Mart xiii: 22; Luke vi: 26; Acts xiii: 6; II Corinthians ix: 13; U Peter ii: 1; I John iv: 1; Revelation xvi: 13; xix: 20; xx: 10.

4. I John ii: 18-22; iv: 3; II John 7. 5-

Matthew vii: 15.

CHAPTER XVII

(V)

resistance even when armed with the best intentions, especially if he justifies himself for his human frailties by finding them normal, particularly on the sexual plane. The error of conception committed in this case lies in the fact that an important esoteric rule has been overlooked: that it is imperative for the seeker to be constantly *active*. He must always keep the initiative, beginning with the search for and choice of a guide and later in the work he accomplishes under the latter's guidance. In a word, when participating in this work, he must be a *subject*, and not an *object*.

This is a necessary condition for this kind of work. If it is not sufficient to provide the whole effort the neophyte must accomplish in his search on the *Way*, it is always enough to allow him to escape from the claws of the 'wolves'. Initiative, vigilance, a critical mind, observation and discernment ... these different aspects of the seeker's active state, are diametrically opposed to the passive drowsiness of one who plunges head down into the jaws of the 'wolf full of condescending compassion towards sceptics because: *thus spake Zarathustra*.

(8)

|

Sixth case.

Although these stereotypes or deformations pushed to the extreme are rare, we must mention yet another variation of the case we have just analyzed. We more commonly observe the deformations we have described in such a milder or partial form that a man of good faith cannot recognize to which case his own deformation belongs. This is normal, considering that we do not know ourselves.

However, there is a case which merits our special attention. It is the deformation which, pushed to the extreme, makes the man a black magician or false prophet, enabling him to acquire certain psychic powers. The Personality's partial deformation in this sense also plays a role in life. Constituted in this way, a man unknowingly acquires a certain influence over those around him; hypnotic influences of the 'A' kind emanate from him. And this can happen not only to the man of type 1, but equally to types 2 and 3.

Someone who undertakes esoteric work seriously must guard against these hypnotic influences which can emanate from him without his knowledge, and which create new karmic burdens for him which he must later neutralize by conscious efforts. There is yet another valid reason for distrusting one's own hypnotic influences. The latter automatically look for fertile ground: weak natures, generally not very deep, are open to them, especially in women subject to a morbid mysticism sometimes accompanied by certain sexual inclinations. When one gives in to them, these influences only accentuate the degeneration of such natures.

Now we must get down to the essential problem that faces the *faithful* throughout his individual work, the working of the emotional centre, its tuning, its development, and the practices which allow this development. But before doing this we must emphasize a certain point.

The first task of someone who seeks the *Way* is to identify his basic type among the fundamental types of *exterior mm*. Having done this, he must try to recognize and determine the nature of the deformation and the character of the imbalance in his Personality.

For the seeker, the tabulation of types of these deformations outlined in the preceding chapter is the instrument with which he can work: the Tradition calls it the *Mirror* — and gives it this name because it helps the neophyte to recognize himself.

The Tradition knows of other *Mirrors*: this term is applied to the *Decalogue*, as well as to the commandments of the New Testament. And the following recommendation, quoted earlier, is given to students: *look at yourself with the Commandments as you would with a mirror*.

A group of disciples containing all three basic types of men and, within these three types, representatives of the six variations corresponding to the six sectors of the lower centres, when they are already quite advanced, forms what is called a *living Mirror*. In effect, taken as *whole* a group constituted in this way possesses every chord natural to the human psyche; as a result, it is capable of every reaction that only the fully developed Personality of man 4 can experience when, in all his fullness, he is ready to cross the *second Threshold*. Directed by an elder and faced with this *living Mirror* during a meeting, the neophyte becomes *transparent*, to use a well-used expression. He *is seen* in every aspect or facet of his psyche. Before such a group, he is incapable of dissembling his thoughts, his feelings or his passions behind a mask of lies. Although socially speaking this may be a disagreeable trial, from the esoteric point of view it is a most useful opportunity, where he can try and gather precious information about himself, information that he sorely needs at the beginning of his work.

We will say again that the man 4, who has a fully developed and disciplined Personality, sees in the common run of men what the disciples who are on the steps of the *Staircase* see only collectively in a meeting that combines the elements we have just described. We should know that *everything is written* on the human face; but one must know how to read it. The same goes for the human body; its attitudes, its behaviour, its walk,

of the poses it strikes in different situations, all betray the inner content of the man. Having learned to know himself, man 4 can decipher others.

A room full of spectators to a certain extent resembles the gathering of disciples we described. Indeed, it should contain representatives of all eighteen sectors of the lower centres of the human Personality. And it is common knowledge that if an audience is not influenced by some intervention from outside, by propaganda or by passion, its reactions are usually very sound.

The seeker will come across other *Mirrors* on his path. They will appear in the form of problems from the domain of the 'A' influences, problems which have a karmic origin which he must solve in the spirit of the 'B' influences that conform to the practical demands of the esoteric work in which he participates. Sometimes, a *Mirror* of this kind may take the form of a *test*. According to the way in which he surmounts it, something which becomes clear only after the event, the seeker can judge the progress he has made on the *Staircase*.

The scriptures and the writings *oiunblinded* men are also *Mirrors* because they have depth. After having read them once and put them aside for a certain time, if he has made some progress in the esoteric sense the disciple who takes them up again will discover new insights.

The depth of a given text corresponds to the depth of its author. For the reader to fully understand the contents of a document, the depth of his *being* must be or become equal to that which the author displays in his work.

The depth of Jesus' words is very great. This is why we said that the Gospel is still very little 'exploited', perhaps up to 5% or 10% of its depth. Doubtless even this estimate is highly optimistic.

At regular intervals, frequent readings of the Gospel, the Apostles, the Masters of the oecumenical Church, and certain authors who have rid themselves of *blindness* will enable the seeker to recognize the progress he has made on the path of esoteric studies.

(2)

These *Mirrors* in their different forms help the seeker to know himself. However, they have to be used with great care if they are to yield good results, because one finds many fine shadings between different human types. Besides the variety of *simple* cases, one may come across *double* cases. This happens when two semi-autonomous nuclei of waking consciousness are formed in the unfinished Personality of the subject. Previously we called them *lumps*,

1. Ref. Vol. I. pp. 36-37

Let us take for example the case of a man who has the nature of a *Knight*, but has been born in our epoch, in our civilization, and is engaged in a career which does not correspond to his human type. Let us suppose that he has become an industrialist, merchant or a financier instead of joining the army or entering the magistrature. Generally, he will not succeed in this kind of activity, nor will he gain any satisfaction from it. Not being very business-minded, he will be imprudent, and he will be cheated and even crushed by the shrewdness of the 'children of this world'.² The success obtained by those who are born for business — whether men 3 or 1 with all their different variations — will seem will-o-the-wispish and illusory to him. And if ever he lets himself get ensnared in the game, it can only lead him to the brink of a quagmire disguised as a flower bed ... An old Hindu Tradition warns one against these errors of orientation by proclaiming that: *another person's dharmt? is full of danger*. And this is one of the main reasons why the Aryan sages and leaders divided the race into four castes, right from the beginning. Each caste was ascribed special duties which corresponded to the aptitudes of the human types it was supposed to include. Mixed marriages were forbidden. This system, which took the principle of reincarnation into consideration, appeared even more sound and logical because at the time when it was established, the human types were still almost unmixed and had very few graduations. In modern language these four castes could be *roughly* defined as follows:

First caste : sages, ministers of religion, leading scientists.

Second caste : Knights, magistrates, Kings.

Third caste : Industrialists and merchants.

Fourth caste : Servants and employees. Whether one likes it or not, one has to admit that despite the confusion resulting from mixed marriages, the whole of humanity is naturally divided into these four castes even today. Though the democratization of our society makes the boundaries between castes appear nebulous, this is only a superficial impression. And although the leaders of revolutionary movements have always ignored it, the democratization which started in 1798, and grew more and more after 1848, has given rise to new caste-divisions which correspond to the demands of the approaching Era of the Holy Ghost. In 1722, Peter the Great had already given the signal for the abolition of all sorts of feudal, political, social and economic privileges through his famous ukase of the *hierarchy of Ranks*. From then on, he organized Russian society on the basis of a principle which was new at

2. Luke xvi: 8.

3. This term means *duty at*, in a wider sense, *servile at career*,

that time, and which he defined thus: *merit takes precedence over ancestry*—no longer an aristocracy of blood or wealth, but of *service*.

Originally, the division of the Aryan race into four castes had a double aim: to orient men from the time of their birth, and because of their birth, towards a career which was by definition right for them, and to facilitate esoteric work for those who were drawn to it. Based on the idea of metempsychosis, it was believed that this caste system would bring souls to incarnate in environments which were the most suitable for the *experience* they would hold.

Circumstances have changed since then. The present boundaries between castes are no longer so rigid. This is because births are no longer 'canalized' by absolute rules as they once were, and also because the human Personality no longer corresponds exactly to the determined types: in the best cases the Personality is shaded, otherwise it is unbalanced or even anarchistic. The four castes still exist today, but only in potential. They are a projection into the still vague future of the four well-defined castes between which men 5, 6, and 7, who have acquired their *Individuality*, will be divided.

It must be understood that *man cannot organically change his type*. He can maim it, which is what he generally does with ardour. Maimed like everyone else, the principal aim of the man who undertakes esoteric work is to know himself and to pull himself together. This final straightening out takes place after the man 4 has crossed the *second Threshold*; and the Tradition says that it is within the framework of *a man's own type* that the real *T* can lead the Individuality to perfection and even to radiant beauty.

m

Let us come back to the type of the *Knight* which we took as an example. If he surveys his failures and tries to get to the root of them, he will understand the main cause: the scale of values that exists in the environment in which he works does not correspond to his own. While everyone around him hankers after worldly power, he is an anachronism who feels lost in these modern times, searching only for Truth ...

Generally speaking, even though the man 2, who is born in the environment 3 of our epoch, is inept for the practical struggle of everyday life, he has considerable potential for esoteric evolution, due to the constitution of his psyche. By consciously working on the development of his intellectual centre—his emotional centre being already awake, and perhaps even somewhat developed—he more easily balances his Personality. This is an important thing to know. For the people destined to be the forerunners of the New Era (which is that of the Holy Spirit) will be chosen

from this group of highly cultivated men 2 who have attained a certain equilibrium by taking their intellectual development as far as possible.

The position of the man 3 in ambience 3 does not give him the same advantages from the esoteric point of view. Of course, he has more opportunities in practical everyday life than the man 2, but he does not have the same aptitude for balancing his Personality. He has to begin by developing an emotional centre which is partially or entirely dormant. So he first has to awaken it. This awakening is naturally more difficult for the man 3 in ambience 3 than it is for the man 2 to develop his intellectual centre in the same environment. For neither in its form nor in its content does Religion offer anything constructive to the intellectual type, who is agnostic by nature. Besides, until now no institution has made provision for schools or universities where emotional aptitudes may be formed or scientifically developed.

If a man 3 feels the need for emotional development, for lack of anything better he will be forced to work empirically.

However, we can give him a valuable hint: human nature has an aptitude for being trained, and this can be profitably used to awaken the torpid emotional centre. With subtle and highly refined reasoning, the man 3 must in every circumstance imagine the reaction of the man 2 who is obedient to the call of his emotional centre. And he must by conscious effort react in the same way when not driven by emotion. It is a game. He will make mistakes and stumble many times, especially at the beginning. But if he takes the game seriously and makes it a permanent methodical exercise for all occasions, he will succeed in liberating his emotional centre from its state of torpor. He will then notice its spontaneous reactions and this first success will encourage him to continue this work. He must tirelessly persevere in this exercise of *awakening* until the emotional centre is completely aroused and quite ready for development.

The man 3 can find that this condition is an advantage. Except for negative emotions, his emotional centre is not greatly sullied, as it is so often asleep. If afterwards during the course of these *awakening* exercises he takes care that this centre does not become stained by all sorts of *considerations* and, above all, is not used for false aims, the man can become *like a little child* whose emotional centre is awake although undeveloped and is neither deformed nor tarnished,

m

This brief analysis and the disclosure of certain rules are, of course, insufficient to tackle the vast and extremely complex problem posed

4. Matthew xviii: 3

at the beginning of this chapter. The way the emotional centre works and the possibilities for its development are unknown to *exterior* man. We can see this clearly in certain circumstances, during the course of criminal trials for example; the best juries never manage to penetrate the depths of the human heart. The same thing happens during confession: even when the penitent is inspired by a sincere desire to tell the truth he does not manage to express all that is weighing on his heart. How can he lay bare his acts and find a motive for them when his under-developed and unbalanced Personality with its 987 Ts' is such a madhouse?

When, after patient and sustained introspection, we penetrate further and further into the interior of our Personality, we discover little Ts' which are very different from each other in appearance and nature. Firstly, we observe that they are not all of the same age. In the *legion* of the 987 elements of the Personality there exist feminine TV in the men and masculine Ts' in the women: often these are numerous and sometimes even preponderant. During someone's life each little *T* has its character and its role to play within the group. But in the majority of cases, these Ts' do not in fact carry out their duty: a great number of them have fallen into a sleep bordering on lethargy; then the more active ones try to command the others without caring about their own assignments nor those of the Ts' they wish to dominate, nor the responsibilities to which the entire man is committed as a result of their actions. Lastly, happy events or unforeseen misfortunes, exterior shocks like bolts from the blue, further complicate an already tangled inner condition. This is when the *autotranquillizing* mechanism comes into action and, with its help, man discovers a new unstable equilibrium — which will be broken again by new exterior or interior shocks, like a house of cards that topples over at the breath of a child.

To tell the truth, as it is, the existence within us of this heterogeneous society of little Ts' is absurd. Logically, it can only lead man to bankruptcy. The practice of introspection enables us to perceive the foreign elements in the composition of the human Personality; in a young man, for instance, it may lay bare little Ts' impregnated with the scepticism of old men; conversely, in an older person it may reveal the Ts' of an enthusiastic adolescent with a heart overflowing with faith, hope and love. We may also observe within ourselves the coexistence of diametrically opposed faults and qualities which normally should compensate each other or, at least mitigate each other. But this is not always the case, and one may find the cohabitation in the very same person of an avaricious T when facing an insignificant expenditure and a prodigal T when it is a question of spending large amounts. Although this existence of such contradictory Ts' at the same time is absurd, one comes across cases of this type more often than is commonly imagined.

However, we must not draw hasty conclusions from this situation that we may observe in ourself by practicing introspection. Still less should one try to establish a false harmony in oneself by some direct or violent action. The result of such an act can only be the mutilation of the Personality, not its harmonization. It is necessary to look on the Personality as being mentally ill and, in order to obtain a positive result, we must act gradually, methodically, circumspectly and, we repeat, with love and great patience. The Personality is a Divine *gift* to us —the *talent* for which we are responsible.

(5)

In order that these ideas may be firmly anchored in the reader's mind, it is not superfluous to take another quick look at the theory and practice that are attached to the process of the evolution of the Personality.

Following conscious efforts of observation, of non-confluence, of inner non-considering, of outer considering, and of being permanently present in the self, etc, man begins to discern the 'B' influences. With the accumulation of the impressions that emanate from these influences, a *magnetic centre* begins to take shape within him. Once formed, this centre is situated between the lower emotional centre and the higher emotional centre: it is a new centre of consciousness. As it grows, it plays the role of an intermediary which little by little absorbs the lower emotional centre and is itself later absorbed by the higher emotional centre. At the same time, it progressively affirms its authority over the three lower centres of the Personality and, by that, over the 987 little Ts': at this point it identifies itself with the higher emotional centre situated in the middle of the organism of our psyche. Man thus attains the inner condition represented in the figure 24 (overleaf) which we discussed at greater length in the first volume of this work.

This is the diagram of the Individuality, the fruit of the second birth. As we can see, the sectors of the old lower emotional centre which are integrated into the higher emotional centre do not totally disappear. The survival of the sectors of the lower emotional centre is represented by dotted lines, because the higher emotional centre, like the higher intellectual centre and the sexual centre, is indivisible. But these sectors are transfigured. According to an old initiatory formula: *at the touch of the philosopher's stone, the sword of steel becomes a sword of gold. It retains its form but can no longer serve as a fighting weapon.* Transfigured and absorbed by the higher emotional centre, the six sectors of the lower emotional centre now

5. Matthew xxv: 25.

6. Ref. Vol.1, pp. 59-61.



FIG. 24

represent the heart of the newborn Individuality. Under the absolute authority of the higher emotional centre, which contains the real *T*, they together ensure the direct and autonomous link with the lower intellectual centre on the one hand, and with the motor centre on the other. This is how the character of the Individuality is formed, which, after its birth, passes through successive stages of growth and development. One must note that the Individuality retains its essential innately positive traits — the predispositions⁷ — of the personality of the man 1, 2, or 3, purified in man 4, and born again for a new life in the man 5, 6, and 7.

In the Individuality, as in the Personality of the *exterior* man, the link with the higher intellectual centre is established directly through the higher emotional centre. But the sexual centre, which enjoyed its independence when in the Personality, is now directly linked with the higher emotional centre. The sexual centre does not act autonomously in the Individuality as it did in the Personality, so that its energy can no longer be usurped by the two lower centres that survive, the intellectual and the motor centre. Here, Love is unadulterated. This modification radically transforms man's sexual life after his second Birth, raising it to the level of the emotional life that from this time on is ruled by the real *T*.

This is the sublimation of sex.

To complete our picture, it is useful to give some indication of the changes that take place in the Personality when it becomes an Individuality through union with the real *T*.

We have already seen that the Personality is made up of 987 little *T*s—a figure that results from all the possible combinations of the eighteen

7. These pre dispositions (Gr. '*prolipsis*') are referred to in *xhtPbiinkslia* and in a slightly different sense in, for example, Stoic philosophy. (Ed.)

sectors of the three lower centres. Now, in the Individuality, only two of these centres still have a certain degree of autonomy. Thus the number of possible combinations is now based on twelve sectors, which are no longer multiplied by three but by two, enabling us to obtain the following formula:

$$\frac{12 \times 11}{1 \times 2} = 66$$

To these sixty-six developed, balanced and disciplined little *IV* of the Individuality, we must also add the six sectors of the lower emotional centre that are enveloped by the higher emotional centre. In this way, we reach the number seventy-two. This is a sacred number, and plays an important part in initiatory practices. After the tower of Babel, when humanity was no longer united, it was divided into seventy-two linguistic groups which comprised the totality of the peoples who inhabited the earth. None of them was mixed; they were all of pure stock and, among them, six races had a messianic vocation.

The number seventy-two includes all possible shadings of the human types that reach the level of the Individuality. This is a simplification compared to the 987 little '7's' of the Personality but, in the sectors of the intellectual and motor centres, it is compensated by the penetration of radiation that comes from the higher emotional centre. Each little '7' of the Individuality benefits from the harmonious co-operation of all the others; this simplification of the system of the psyche is a result of its being raised to a higher plane.

The sublimation of sex, so that its expression is in complete harmony with that of the real *T*, transforms the emotional life of the Individuality to such an extent that it cannot be described in human language. In the Tradition, this state is called *Beatitude*.

CHAPTER XVIII

(V)

On the basis of the analysis of different types of deformation of the Personality we made in chapter XVI, in this chapter we will outline the ways of re-establishing a degree of equilibrium in the latter. An energetic readjustment is indispensable for the one who wishes to take a serious part in esoteric work, the aim of which — as we know — is the complete growth and development of the Personality taken all the way to the second Birth. This leads us to consider the major problem of esoteric practice, one that is as important in the outer life as in the inner: this concerns *negative emotions*.

We have pointed out more than once that these emotions are the means by which the great destructive force acts in man. It is not an exaggeration to say that negative emotions are mainly responsible for the fact that human beings age and die prematurely. To combat old age and death, one must combat the negative emotions in oneself. This postulate may surprise some; it may be even more surprising if we add that, when treated according to precise rules founded on a strenuous psychical discipline, these very same emotions, though harmful, can become an abundant source of the fine, active energies whose presence is necessary for the development of the Personality.

(2)

Preparatory theoretical and practical study of esoteric science is absolutely essential before the reader will be able to grasp the Doctrine of negative emotions we are about to expound.

First one must firmly grasp the fundamental idea that Faith, Hope and Knowledge (Gnosis) are consecutive stages in the progressive Revelation of hove, and that a deficiency or lack of revelation at the preceding stage prevents access to the revelation of the following stage. This means that without Faith in one's heart it is impossible to attain Hope in the esoteric sense of this word. And without one or the other one can never attain Gnosis, the living knowledge that makes hove accessible,

In the Tradition's metaphorical language, the triad of Faith, Hope and Knowledge is called the *triple-edged Sword*, or the *triangular ra^pr*.

The scriptures and the commentators of the first centuries of our era insist on the importance of negative emotions and on the attitude we

1. Luke vi: 28-32; Matthew v: 44-46

should take to them. They recommend a positive reaction and a joyful attitude towards people who are malicious towards us. For example, one reads:

Bless those who curse you, pray for your enemies, fast for those who persecute you. Love those who hate you³ and you will not have any enemies. If someone smite thee on thy right cheek, turn to him the other also⁵ and you will be perfect.

We might quote many other similar texts. The commentaries of the doctors of the (Ecumenical Church also abound in exhortations of a similar nature.

However, these are generally seen simply as dogmatic precepts, so that we do not try to fathom their underlying meaning. It is in one way reasonable to react in this way: the patient swallows the medicine without bothering to learn its chemical content: what interests him is the effect it is known to produce.

We also acknowledge in theory the beauty of the attitude preached in the Gospel, which is not to resist evil at the same time as rejecting it in practice as a political and social danger.

Some consider the gospel teaching to which we have just referred as evidence of a religious exaltation that transgresses the limits of common sense. For them, the latter instruction seems to be pure madness. Yet the precepts to love one's enemies and not to resist evil have their justification. We will see that they lead quite naturally to our recommendation not to flee from negative emotions.

It is easy to find a reason for the confusion that usually takes place. Most of the time when dealing with facts and maxims concerning the *esoteric* domain, we pronounce judgments which can only be applied to *external* life. In other words, we apply arguments and maxims that apply to 'A' influences to the domain of the 'B' influences. This confusion is a result of the false belief that Jesus' words are 'simple' and so must be accessible to everyone. In consequence, everybody is supposed to be able to understand and even to criticize them. This misunderstanding has survived for centuries in spite of the warnings that authorities such as Origen, St Isaac the Syrian and others have handed down to us. It is true that, in order to respect the principle of hermetism adopted by the Tradition, especially

2. *Didacbi*, I, 3.

3. Luke vi: 27, 35.

4. Clement of Alexandria, *Stromata*, VII

5. Matthew v: 39; Luke vi: 29

6. *Drd&cbtt* loc. cit

7. *PhHokalia*, *passim*.

8. Matthew v: 39; Slavonic text: He nпoTMBLCs ЗИOMV; Vulgate: *m« rtsistrt male*; Greek text: \L?\avTiCTT^vac ?w Trovrjp&

in Oriental Orthodoxy, these warnings were given in a sibylline form. This is why St Isaac the Syrian points out that:

The Holy Scriptures say many things by using words in a different sense from their original meaning. Sometimes bodily attributes are applied to the soul, and conversely, attributes of the soul are applied to the body. The Scriptures do not make any distinction here. However, enlightened men understand.⁹

(V

In order to grasp the exact meaning of the Gospel commandments we have just quoted, one must first try to understand the exact nature of negative emotions such as: anger, jealousy, hate, slander, envy, insolence etc., which are expressed by violence.

Now all human emotions, whatever their nature, negative or positive, and whether they are born of different movements in the psyche, *have one single movement of the soul as their basis*. However paradoxical it may seem, it is *Ltme* which forms the one unique basis of all the variations of positive or negative emotions. To be more precise, let us say that there is, in fact, only one *pure emotion*; and this emotion, in its limpid purity, is *Love*.

All the different emotions and feelings that man feels are composites; in mixing with pure Love their elements trouble it: in effect, the latter has the capacity of absorbing and dissolving considerations, attitudes, passions, impulses, etc., in itself, just as chemically pure water has the faculty of absorbing and dissolving salts of different natures. One result of this is that the variety of human feelings depends, in each particular case, quantitatively and qualitatively, on what is admixed into the pure Love in which they are dissolved,

The higher emotional centre is the organ which enables man to feel this pure and unique emotion called Love, This is why, when addressing the Disciples and not the masses, St Paul gave them this precept which is famous in the esoteric Tradition: *try to attain Love*. The reader may now better understand of which Love the Apostle spoke, and the meaning of the context of this maxim, and why he crosses over to the problem of *spiritual gifts* immediately afterwards,

It is obvious that the *exterior* man does not know and cannot have even an approximate idea of Love in its Divine purity. Even advanced disciples who are already on the *Staircase* are far from knowing this emotion in all its fullness, for the '7' of the Personality, with its three lower centres, does not possess the organ which will enable them to feel it. To be able to feel this emotion is the attribute of the real *T*, which expresses itself through the Individuality formed at the second Birth, This situation may be compared

9, St Isaac the Syrian: Sermon IV, 83.

10, I Corinthians xiv: I. Literal trans, from the Slavonic text,

to that of the child: the latter becomes attached to his mother only after his physical birth, once he has been separated from her.

It is to the foremost Disciples, those who are on the *Staircase*, that St Paul's sentence is addressed; if they cannot attain Love before crossing the *second Threshold*, how can the *exterior* man have any idea of this Love, when he has not even crossed *the. first Threshold*.

(4)

In the feelings accessible to *the. faithful* who are on the *Staircase* to the *Way*, Love is still mixed. Human nature itself is mixed; it faithfully reflects the content of the *Mixtus Orbis* of which it is a product and a part, Thus the complex structure of the personality — with the centres of the psyche subdivided into positive and negative parts — reflects the mixed nature of the outer and inner worlds of terrestrial man and enables him to perceive them in all their parts, a possibility which would be denied him without this. This is the deep meaning of the *sacrifice* through which Love, which is God, created the world: he allowed the defilement, but only in order to transmute it into an image of dazzling beauty.

If, as we have seen, the atrophy of the negative part of the intellectual centre prevents man from having any doubts, it also partially blinds his intelligence and takes away his capacity for appreciation, criticism and comparison, etc.

The same may be said for the emotional centre. Its negative semicircle is necessary to ensure its complete functioning: while the positive part responds to agreeable impressions coming from the outside or the inside, the negative part responds in the same way to disagreeable impressions. This is the normal role of the negative semicircle, which might be called its *positive* role. If the awakened and pure emotional centre were deprived of its negative part, the affective life would be impoverished and disoriented. This situation could be compared to one in which we would be able to feel heat without being able to feel cold, or see light without being able to distinguish shadows. When it is awake and functioning normally, the negative part of the emotional centre is an organ in the psychological structure of the Personality which is just as indispensable as the positive part.

When the emotional centre is plunged into deep sleep, as it is in the first stereotype described in chapter XVI, *it dreams*. It dreams in the daytime, in the midst of activity, as well as at night. The emotional centre conceives dreams by using its innate capacity for creating images. By elaborating these while inspired by ideas from the intellectual centre, it can create images of grandeur to compensate for the failures or half-failures of

life. If inspired by impulses from the motor centre, it imagines itself moving on the ground, on the seas or in the air. Under the influence of innate elements rising from preceding films it can relive these films in fragments. With the aid of impulses proceeding from the sexual centre via the motor centre, the emotional centre has erotic dreams which can seem entirely true. On the other hand, if it dreams with the pure and direct aid of the sexual centre it creates ideal images of its polar being, founded on the experience of its present life *at previous experiences*. With the sexual centre's direct intervention the emotional centre can also create idealized images of living beings that the man has met, or who resemble his polar being.

In the two latter cases, the positive part of the emotional centre functions fully and enables a man to meet in his dreams a pure and elevated feeling which he is incapable of experiencing in his life as an *exterior* man. According to their different planes, these dreams can proclaim, predict or even be prophetic.

This process explains the meaning of the prayer that is recommended to disciples in which they ask God to permit *sleep to becomeawakeningin "Life*. In the two cases where the emotional centre calls on the energy of the sexual centre in dreams without going through the motor centre, the intellectual centre, being asleep, does not interfere with the work of the emotional centre with doubt or criticism. As it enters the emotional centre the energy SI-12 accelerates its vibrations, and this enables it to transform this sexual energy into SOL-12, following a momentary intervention by the higher emotional centre.

These few indications give a brief glimpse of the work of the lower emotional centre while it is still under-developed — but which the unbalanced contemporary life of man can no longer anaesthetize or degrade, particularly when, as a faithful, he climbs the steps of the *Staircase*,

(5)

Let us return to the problem of *negative emotions*. The special vibratory current that carries this sort of emotion passes through the negative part of the emotional centre.

As we have already emphasized, negative emotions are born, grow and develop on a base of Love. This may seem paradoxical. It is easy to conceive that positive emotions are born of Love but it seems difficult to admit that, when one analyses the elements which compose it as in chemical analysis, Love is revealed as the constant foundation of negative emotions.

Negative emotions are complex. They are a mixture of different psychic elements which are alien to Love's simple yet subtle nature, yet are added to it.

The coarseness of these elements is responsible for the negative nature of this kind of emotion. The added elements may proceed from the intellectual centre, when they take the form of considerations, combinations or calculations, etc., or from the motor centre, when they take the form of passions, attractions or antipathies that come from the T of the body.

A special movement of the motor centre usurps sexual energy and this feeds the intransigence and dynamism which together form one of the main characteristics of every negative emotion.

II (V)

Normally the sexual centre acts under the effect of Love. Let us see what happens in the three centres of the psyche, that is, in the whole Personality, in the *normal case*, where the sexual centre begins to move. As an example, we will take the case of *ideal* and *complete* love between two polar beings who have not progressed from an esoteric point of view, that is, a man and woman 1, 2 or 3.

Life offers a whole scale of anomalies relating to this normal case that we are about to study. These are ascribable to two general causes:

- The first corresponds to equal participation of the husband and wife in the process; but the intensity of this participation only partially involves the organism of their psyche;
- The second involves a difference in their participation, when the psyche is totally involved in one partner and only partially involved in the other.

In other words, one *loves* and the other *lets himself or herself be loved*.

There are an almost infinite variety of special cases, for there is no other sector in man's mental (*psychique*) and physical life where he is exposed to so many real, and above all, imaginary influences, as in the domain of sexual life, which demands commitment and unreserved response before it can blossom fully. But in the average sexual life, one comes across a multitude of unhealthy deviations such as the call of blood, the preservation of the species, physical attraction, possessiveness, and consideration, all of which play an important role in our society — sufficient to explain the rarity of the only cases which may be considered truly normal, the union of polar beings.

11. John i: 13.

(2)

Sexual energy is SI-12, the finest energy that our organism can draw from food. When the sexual centre begins to act to accomplish its main function, which is carnal love, it first makes use of the motor centre. Flooded by the extremely powerful energy SI-12, the motor centre reacts. However it is not completely impregnated by this in a single instant. The energy SI-12 first penetrates its positive part by provoking a strong instinctive attraction towards the opposite sex. The condition of the psyche that results *orients* the whole Personality: as long as the energy SI-12 acts normally, the 987 little *I's* unite and are directed towards the same goal. This phenomenon may be compared to the orientation of the molecules in the core of an electro-magnet when a current passes through it. Then the energy SI-12 penetrates the negative part of the motor centre and awakens it. This centre then leads the T of the body to the carnal act. Up to this point the process is common to men and animals. It develops no further in the latter, and the same goes for the majority of human beings. The effects of the carnal act are then limited to physical pleasure and procreation. These limitations in men are due to the intervention of the *General law*, which sees to it that the first impulse given to the sexual centre at the call of Love is measured and does not exceed a *necessary* and *sufficient* level to satisfy the ends that it is its task to fulfil. The motor centre then begins to act not always having sufficient energy at its disposal to produce the tension that would reorient the organism of the psyche *in its totality*.

P)

On the contrary, in the case of a total love or the love of polar beings, the call of Love makes the sexual centre vibrate incomparably more powerfully and produces a much larger quantity of energy SI-12 than the motor centre can contain. When it is saturated, this energy overflows. The excess then spreads into the two other centres, the intellectual and the emotional, where the energy SI-12 penetrates the motor sectors and imprints on them a vibratory movement corresponding to its own rhythm.

As long as the energy SI-12 lasts, the very rapid vibration of the two motor sectors of the intellectual centre deeply transforms the condition and functional characteristics of the four other sectors of this centre.

One may remember that this normally works with energy 48, which imprints a relatively slow rhythm on it. Drawn by the extremely rapid frequency of the energy SI-12, the intellectual centre vibrates much more rapidly than normally, and as long as this energy makes itself felt this centre loses its thoughtful, reflective, calculating and agnostic nature: worries, doubts and other preoccupations are temporarily relegated to the background of waking consciousness. Such a radical transformation can, however, take place only in the case of polar beings, when Love's call and the impulse from the sexual centre are strong and pure. If this is not the case, the transformation will only be partial; the critical spirit, always the last to be effaced, will survive. Men and women commonly fall into moral prostitution in its infinitely varied shadings because their worries and calculations, emanating from the intellectual centre, are not stifled. When the call of Love is limited, the intellectual centre is not involved in the amorous process, and then the head remains cool. Instead of completely dominating the Personality, the sexual centre remains partly subject to its normal tendencies. This happens much more often than one might think. Indeed, it is no exaggeration to state that the great majority of human beings do not for a moment imagine that higher levels of carnal love exist.

In the *tormalcs.se* that we have taken as an example, the vibration SI-12 awakens a vivid erotic imagination in the intellectual centre, freeing it of all worries. For one moment, it concentrates only on the game of love, in which its positive and negative parts vibrate together in harmony with the motor centre and with its own rhythm accelerated by the inflow of sexual energy.

(V

Let us now see what happens in the motor sectors of the emotional centre following this abundant production of fine, pure energy SI-12. It reacts quite differently from the intellectual centre. We must remember that in the *exterior* man the emotional centre does not work with the Hydrogen 12 which should normally nourish it, but with the Hydrogen 24 proper to the motor centre. The overflow of the energy SI-12 into the motor sectors of the emotional centre provokes a strong resonance in the other sectors of this centre — a resonance which can produce the two following phenomena:

- the intellectual sectors of the emotional centre engage in a love-game led by the intellectual centre in harmony with the motor centre; the heart is then flooded by an influx of tenderness which is of an incomparably higher level than that to which it is used when it is only nourished with energy 24;

- if the call of the energy SI-12 coming from the motor sectors of the emotional centre is sufficiently intense and pure, a momentary flash of the consciousness of the real *T may* be felt. This is produced in the following manner: the influx of tenderness due to the energy SI-12 opens up communication with the higher emotional centre, from where a wave of energy SOL-12 from the higher octave flows to meet the SI-12 with which the motor sectors of the lower emotional centre are infused. Then, by induction, the energy SI-12 is subject to transmutation and can become SOL-12. When this happens, the organism receives an abundant influx of new energy. Even if only for a few moments, the couple *taste* this higher Divine condition which is *Beatitude*, a taste which leaves a feeling of relaxation and ineffable peace in its wake.

The possibility of acceding to a higher plane in the act of carnal love explains why marriage — in which *the twain shall be but one flesh*¹² — is included among the seven sacraments (*mysteria* in Orthodoxy) of the Christian Canon. This act carries in it the germ of the pure emotion that is Divine Love. If the couple reach this state under the impulses of the Absolute III, through this mystery they attain the radiation of the Absolute II. Then one step will be made in the direction of the great Return.

W

Schematically, this shows the working of the three psychic centres in *their positive and normal reaction* to the call of the sexual centre, whose activity involves the couple in an act of total and harmonious love, which is the case for *polar beings*. Indeed, the energy SI-12 has the faculty of enveloping and dissolving the energies that come from the three centres of the Personality, and this will for an instant communicate a strong and harmonious vibration to the whole of the latter. This harmonious participation of the three centres in the accomplishment of the love-game can be compared to the playing of an orchestra composed of competent musicians and led by a talented conductor.

12. Matthew xix: 5; Genesis ii: 24; Mark x: 8; I Corinthians vi: 16; Ephesiansv; 31; Slavonic text: H6yAyTjiBoeBonjiOTbeanHy;GrcekText: *Kaitaovrat ol \$6o fl\$ aapxa piay*; Vulgate: *trust Aie in carnt una*. It is the indispensable condition for the appearance of the *Androgyne*.

III
ft)

Yet if this orchestra lacks direction, it will only produce a cacophony with its instruments. This is the case with couples who are not in harmony, and with whom the process functions the other way round: the sexual centre then turns in the opposite direction to normal and provokes abnormal sexuality and the birth of negative emotions.

Thus, as we have said already, negative emotion has Love as a basis; otherwise it would not be an emotion. To this base are added, in varying proportions, elements which, although they are oriented in the opposite direction, are analogous to those which exist in the case of a normal love. Consequently, negative emotions have the effect of inducing a repulsion instead of provoking an attraction as in the case of positive emotions. Furthermore, their dynamic nature makes even the most phlegmatic man, when he is under their influence, want to act and thus express his agitated condition by violent words or deeds.

The impressions that give rise to the negative emotions in us are only too well-known for us to enter into a detailed description of them. Our own experience enables us to fill in the gaps. The important thing is to grasp the process of their formation in us. This knowledge should enable us to reverse the effects and to transform their destructiveness into an esoteric benefit. This is expressed in the proverb that says: 'There is only one step between hate and love.'

We have said that every negative emotion is composite. *Pure negative emotion does not exist.* But this mixture can only be produced and endure if it is being stirred up by some passion. It is like water which dissolves certain salts only when brought to a high temperature. The negative emotion is born of a violent fit of passion, when one can be overcome by hate, jealousy, anger, etc. By the reversal of the mechanism of the psyche we described in the case of harmonious love-game, the negative emotion usurps the energy SI-12 of the sexual centre, that is, the energy of carnal love, in order to manifest itself. The more violent the negative emotion expressed or suffered, the greater the quantity of energy SI-12 utilized. As in the positive case, this energy spreads over the whole of the motor centre and in the same way, penetrates the motor sectors of the intellectual and emotional centres by impregnating them. As long as the vibration from the motor centre, or from man's animal instinct, continues, the motor sectors of the two other centres vibrate negatively: a state of profound *confluence* is the result. Here we are dealing with an essential point: *the mechanism of negative emotions can function only in this state of deep confluence.* Driven by a shock or a passion, man loses his inner peace and falls immediately into the

state of *confluence* that favours the birth and development of negative emotions.

Generally, after a certain time, the negative emotion progressively loses its energy and is finally extinguished without conscious effort. We must add that once he has fallen into a state of *confluence*, man can get rid of the negative emotion only by exhausting the energies that it has brought to the surface. And the commotion that results does not disappear immediately. Negative emotions disturb the whole organism of the psyche, upset the Personality, and cause considerable loss of the finest and most precious energies which will be dragged into the movement. Man then needs time to rebuild these reserves of fine energies.

(2)

A diametrically opposite effect is produced if at the moment when negative emotions arise in him, the subject remains calm and does not mechanically fall into a state of *confluence*.

Let us study the case of negative emotions that arise in us. Although irritation may build up over weeks, months or sometimes years, its explosion is always instantaneous. In other words, the negative emotion erupts and takes dynamic form in a very short time; in one or two seconds it rises in someone and overflows, putting them into a state of profound mechanical *confluence*. Finally, it will be exteriorized in words or actions.

Here we are brought back to the *Doctrine of the Present*. If, by persistent introspection, the subject manages to *observe* the rise of the negative emotion in himself immediately after its birth, that is, *while the limits of the slot in his individual Present have not been crossed in the passing of time*, it is possible for him to disassociate the components of this emotion. Introspective observation brightens our inner being just like a streetlamp, and negative emotions can only be formed and begin to act in the inner darkness which characterizes the state of *confluence*. The light projected by constation within the *limits of the Present* disassociates the negative emotions, and the passions which gave rise to them then fall back into a latent state.

But constation has yet another effect that is of primary importance: the immediate disassociation of the components which constitute the negative emotion liberates the energy SI-12 which the passions had drawn into the motor centre; a result of constation is that this is automatically concentrated in the emotional centre which it then sets in motion. We know that normally the intensive work of this centre is carried out with the aid of fine energy of the 12th degree. A victory over negative emotion brings an inflow of joy into the lower emotional centre. This joy is an expression of the abundance of the energy SI-12 released by constation. This latter

makes the lower emotional centre vibrate at the rapid rhythm that is normal to it, and this enables the establishment of instantaneous contact with the higher emotional centre and triggers the release of a current of energy SOL-12 from the latter. This indicates that, correctly practised through introspection and effective within the limits of the *individual Present*, constataion enables man to win a *total* victory. The inflow of higher joy that the current of energy SOL-12 liberates can then transmute the energy SI-12 freed from the mixture into SOL-12 by *induction*. The duration of the contact between the lower and higher emotional centres established by this can then be prolonged.

It is obvious that this possibility only exists for the disciple who, after having crossed the *first Threshold*, perseveres in climbing the *Staircase*, when he possesses a *magnetic centre* in formation. Each victory over a negative emotion accelerates the formation of this centre. Jesus' redoubtable words;/or *to him that hath, to him shall be given; and he that hath not, from him shall be taken even that which he hath*¹³ refer to this possibility of victory, to the efforts that it calls forth, and to its effects.

m

|

The factors we have just described explain the attitude towards negative emotions adopted in the scriptures and by the Tradition. This attitude emphasizes the two following points:

- without the appearance of the negative emotion, the energy SI-12 is not drawn in by the motor centre. It remains in the sexual centre to be used for the latter's needs;
- without a victory over this very same emotion, man cannot feel the joy that is provoked by a current of energy SOL-12 coming from the higher emotional centre; and without this current, the energy SI-12 cannot be transmuted into SOL-12 as it is first drawn in by the appearance of the negative emotion, then liberated by introspective constataion within the limits of the *individual's resent*. The more violent the negative emotion, the greater the quantity of energy SI-12 drawn in, which can be transmuted into SOL-12 in case of victory.

By carrying out this work with all the sincerity of which he is capable, the neophyte can reach *Xhtpath of Access* which will lead him towards the *Way*. In this way he will put off the old man, the slave of his passions, and will put on the new man *which is renewed in Knowledge after the image of Him that created him*¹⁴

We have just studied the negative emotions which are born in us. But as he advances up the *Staircase*, the neophyte will find that the times when he feels a negative emotion arising within him become more and more rare. The energy SI-12 then remains asleep in the sexual centre, since the absence of passions no longer calls it towards the lower centres where it may be used.

It is at this point of his evolution that the neophyte will find the obvious utility of those who are hostile to him. As long as he is on the *Staircase* it is in insults, hate, jealousy, treachery and the contempt of other men that the *faithful* finds the elements which are necessary for him to awaken his emotional centre. By dominating the mechanical reactions that the reproaches and attacks of others may produce in him, someone who struggles between the two Thresholds separates and rejects the elements which are parasites on the fine energy mobilized by negative emotions. We repeat: it is this energy which, having become available, allows the establishment of a contact with the higher emotional centre and accelerates the growth and the development of the *magnetic centre*. The *faithful* finds in this struggle the source of energy that is indispensable to him in order to progress.

He will then understand that he can and must love his enemies and bless those who curse him,

13. Mark iv: 25; cf. also Matthew xiii: 12; xxv: 29; Luke viii: 18; xix: 26.

14. Colossians iii: 9-10.

15. Matthew v: 44; Luke vi: 22.

CHAPTER XIX

(V)

In the previous chapter we pointed out that the higher *the faithful* climbs on the *Staircase*, the more rare are the occasions on which negative emotions arise in him by his own initiative. This is comprehensible. With regular introspection and inner constation he will progressively gain knowledge of himself, that is, of the structure of his Personality and the way it functions. The opinion that '*Knowledge is Strength*', expressed at the time of the first industrial revolution, is wholly applicable to the inner revolution which takes place in man after introspection. A slave of his passions, of his instincts, and so of his negative emotions, he had until yesterday always managed to justify himself by using commonly accepted slogans as well as by remarking that his behaviour was simply human and normal. Now *thefairful* begins to disapprove of these emotions; he begins to realize that he is a slave and to understand that the negative emotions, which are an effect of the *General Law*, seek to keep him in his primitive state and to hold him in his place, for the good of the whole, but to the detriment of his personal interests. This attitude becomes firmer in spite of all the seductive or frightening appearances that the mirage of life, con-stituted of all the 'A' influences, faces him with.

This first knowledge—the beginning of the higher knowledge which is the *Gnosis* of St Paul, Clement of Alexandria and the other authors of the early centuries — brings *Power to the faithful*. Above all it appears to him in the form of a mastery of the movements of his psyche. Of course this does not happen immediately; he has to pay a high ransom in order to be freed from this slavery. And the ransom can be raised only at the price of sustained labour that is generally long and hard. However, with conscious and prolonged efforts of introspective constation, *the faithful* who burns with *Faith* and perseveres in climbing the *Staircase* will find that he is more and more detached from the negative emotions which, under the dominion of the *General Law*, have always tended to appear in him.

The first rudiments of *gnosis*, the higher knowledge and *practice* which give one mastery of oneself, progressively bring the *inner peace* which is the first serious result of the efforts made.

This inner peace, which the *faithful* should cultivate by any means, is the indispensable condition that will enable him to collect all his energies so

that he will be able to progress on the *Staircase*, and it is this same inner peace that will save him from falling.

However, when we cultivate this inner peace, our opportunities for profitably exploiting the negative emotions born in us, so as to obtain fine energies, become very scarce. Then there remains only one other source, that of negative emotions aroused by shocks from outside us.

This kind of shock will never be lacking for those who work in the world. Indeed, to the *General Law* someone who 'moves' looks like a fugitive from collective work, and nature takes immediate steps—a whole series of appropriate measures — to make the rebel fall back into line.

Then begins the struggle, the great struggle, the *Invisible Combat* on whose outcome the fate of the *Knight of Christ*² depends. This uninterrupted combat lasts the whole length of the *Staircase*, and *the faithful* does not obtain his final victory until after the last trials, when he finds himself in front of the *second Threshold*.

All along the way, however, progress is ensured by *partial victories* over this or that passion, over the tendency to sleep, over violent shocks or *scandals* coming from outside or even from inside him. The struggle is painful, especially because one does not recognize the *enemy* until after one has been hit; his approach is always masked in infinitely varied ways: considerations, seductions, a desire to be useful or agreeable, condescensions, noble attitudes, etc. Often the *Knight* is defeated because he was serving the *Devil* with all his heart while sincerely but mistakenly believing that he was serving Christ.

But whoever commits himself on this field of battle will still find help. It comes to him from two sides: from the depths of his being, and from outside him. In the first case, it is his absolute sincerity towards himself and the purity of the faith with which his heart is aflame. By definition, faith is blind, *since it is as certain of the invisible as of the visible*. As the *invisible* is unknown by definition, the most ardent faith can be sincerely mistaken. The example of St Paul is sufficient proof of this. But this same example shows that, just by its existence, the sincerity of faith calls forth *Love*, and so it draws out a correction of what is admittedly in error from the deepest depths of the one who feels it. This is the meaning of the revelation that the future prince of Apostles received on the road to Damascus.

As for outside aid, this comes from the effects of the law which applies to every action. We have defined this law more than once by this formula: *tendencies accentuate*. It is popularly known, and in many countries it appears in common parlance in the maxim: *only the first step counts*. These two formulae express the same law, and apply algebraically, that is, in a positive or negative sense. In terms of the moral effort that must be made, it is no

1. It is quite different in monastic practice.
2. Traditional term.

less difficult to steal for the first time, for example, than to practice an unaccustomed virtue. Repeated action (in this instance, partial victories over negative emotions of the same nature) creates a habit, a force of inertia. Even then, before crossing the *second Threshold* we can never be sure we will not fall into the same snare again, for one's watchfulness is quickly exhausted when faced with simultaneous and reiterated attacks. But the fall will be less and less painful and the erasure of its effects less and less difficult.

What is more, each partial victory augments the reserve of fine energies and so strengthens the *Knight's* strength in the battle. But here again, he must be particularly vigilant not to spend the reserve as fast as he accumulates it. After each victory, he must remember that the *General Lao'* automatically acts in varied ways to steal from him the surplus—relative to the 'bourgeois' level — of the fine energies he has won, and which, if rationally utilized, will allow him to make one more step forward out of the zone of influence of this fundamental law which, in this situation, is hostile to him.

In the course of this *Invisible Combat*, a particular passion, the same mirage, loses its power over the victor once he has overcome it once, twice or more times. So while the *Knight* advances on the *Staircase* his inner peace becomes more and more complete and unalterable. He will see his 'assailants' waver and retreat, one by one.

At this rime the second source of fine energies that the *faithful* needs so much in order to advance is cut off. This source is the result of the transmutation of negative emotions aroused by shocks from outside him. Again, in someone who has crossed the *first Threshold* and struggles to climb the *Staircase* with his heart burning with faith, the source of energies from the negative emotions forming inside him dries up at the same time.

It then becomes a question of knowing how and where *Christ's Knight* can find new sources of fine energies, once he has established a steady and permanent peace within himself and has thus become unmovable by inner or outer shocks.

These sources will open up for him but, we must repeat, only on condition that the inner peace he has obtained becomes firm and unshakeable.

Having reached this point in our study, the enlightened reader will understand that this inner peace can be obtained only by the *fusion* to which we referred in the first volume. This logically leads us on to examine this phenomenon and technique which can enable us to carry out this fusion in ourselves in greater depth.

(3)

Here we will digress a little in order to clear up an important question which must have arisen in the reader's mind. To postulate of the mastery of the negative emotions is well founded, as has been demonstrated above, and this gives rise to the following question: in these conditions, what is their usefulness in the general economy of our *Mixtus Orbis*?

From what has been said, the reader may have the impression that negative emotions are simply one of the instruments by which the *General Law* keeps man in his place.

Here, it is necessary to make a distinction, because the action of negative emotions has not one role but two. Their action becomes destructive for those who are close to the *first Threshold*, and even more for those who, having crossed it, are progressing on the *Staircase*. We have already mentioned that as far as the *General Law* is concerned they are potential or confirmed 'fugitives.' For them, negative emotions represent one of the factors that can make them lose ground, and this is a danger against which the *faithful* should fight with all his strength.

But this is the special case of someone who takes part in esoteric work, and it is rather uncommon. So the question is to learn the significance of these negative emotions when they invade people who are satisfied with themselves and perhaps even with their fate, who not only do not dream of any esoteric evolution, but who have no idea of the *General Law*, of its action, or that it is possible to escape from its clutches. These are docile, perfect subjects of the *General Law*, and their kind forms the greater part of the human species.

Negative emotions have numerous meanings and play countless roles that largely extend beyond the boundaries of our *Mixtus Orbis*. We will try to determine their place within the framework of the note LA of *organiclife on Earth*, especially in its two principal aspects: the *personal* aspect and the *collective* one.

In both these cases the role of negative emotions is not really *negative*, although their direct effects are always destructive: damaging the individual's health, provoking discord in families, and giving the human masses impulses that push them to excesses: to revolts, wars or revolutions.

In the individual case, *the positive* effects of negative emotions lies in the fact that they serve as *awakening* alarms. Their dynamism communicates impulses to the individual which force him to act. It is the energy SI-12 stored up by the motor centre which mixes with the energy of one or more passions—which have the heavier density of 24—to give birth to negative emotions. Afterwards, in this mixed state, it penetrates the motor sectors

of the two other centres and makes them vibrate. The emotional centre then vibrates in a violent way. The same mixture of energies gives the intellectual centre an inventive but always calculating orientation, rendering it cunning and capable of all kinds of lies.

In this way the organism of man's psyche comes out of its somnolent mental state but, uncultured from the esoteric point of view, it automatically or even *voluntarily* falls back into the same state whenever there is a lack of external impulses. It takes life in a spirit of an eternal holiday.

(V)

Negative emotions could be said to form a valid common denominator for all human beings and human groups without distinction of race, caste, sex or religion. They give birth to a common language which can be understood by all, even by animals.

Wars and revolutions are certainly calamities for the generations that suffer them, but ancient and modern History show us that they provoke a recrudescence of human activity not only on the battlefields but also in the chancelleries and in the silent studies of philosophers and men of letters, as well as in the laboratories and factories. And it is from that activity, provoked if not imposed by the calamities of wars, that marvels are born for the following generations. This is one indirect but clearly positive effect of negative emotions. We may even add that, without negative emotions, the door onto the path of access to evolution would be closed to individuals as well as to human groups.

This digression having come to an end, let us continue our examination of the phenomenon of *fusion*.

II

(V)

The process which leads to fusion must be attentively observed during its development and subjected *at every moment* to the practice of con-station in a state of lucid *presence in oneself*. The whole process may take many years. It includes *five* successive stages:

THE FIVE STAGES OF FUSION

FIRST STAGE. — *Introspection. Constataion,*

This consists of sustained introspective observation having as its object all the little *I's* forming the Personality, which are the *filings* of which we spoke in the first volume of this work. This observation faces us with different kinds of representation: abstract ideas, animated ideas, colourless or coloured images, vegetable and animal living beings, human images. All this is in a cold, temperate or hot atmosphere.

In this work, the essential thing is to observe the elements which together form our provisional *T*, that of our unfinished personality. Then we must *constate* that each of these is in fact a particle of our *T* as we are before the *first Threshold*.

We repeat that if it is to prove fruitful, this entire process must be subjected to sustained constataion from the first stage right up to its happy ending.

Once *the faithful* has become familiar with the spectacle of his Personality during persistent introspection, he must try to discover which little *I's* or groups of little *I's* have a tendency to wish to occupy the foreground of the scene. It is important to know them. It is also useful to know that these little *I's* which always tend to play the main role and which, because of this, serve as guides in the whole of the Personality, are sometimes masked from the observer as a result of lying to oneself and of hypocrisy.

Generally speaking, every Personality is deformed; the sense and the degree of the deformation are individual, but the greater the deformation the more of the little *I's* are behind the mask. It is important to know this, as *they must be unmasked* in the first stage of the work. Otherwise the fusion can never take place properly and completely, which is a necessary condition for it to be effective.

SECOND STAGE. — *Active inner peace.*

Outer or inner circumstances provoke conflicts in us between *I's* of divergent tendencies — faithfully reflecting the world of A' influences. Each conflict produces a disagreeable sensation of inner friction. At this moment it is necessary to be *watchful*. Knowing that feeble, partial or intermittent constataion is not sufficient to give results, one must be *actively* present in oneself and observe the process while, at the same time resolutely detaching oneself from it. Otherwise, if we *merge* into or take part in the conflict, even momentarily or partially, the friction cannot be turned to our advantage. On the contrary, when we are dissolved in it we lose our energies instead of preserving and accumulating them.

One of John Qimacus' maxims may be applied to this work in particular; it says that: *the true wise man is he who knows how to turn everything to his advantage*. For this, it is necessary to *be present* at the very moment when the friction is born; the result is then positive, and fine energies are produced.

Their quantity depends on the intensity of the friction, that is, on the inward conflict or conflicts, as well as on the degree of one's *presence in oneself*. Their quality depends on the centre which is acting.

When properly treated with the aid of constataion *whilcpresent in oneself*, the friction can liberate fine energies of a valency between indexes 96 and 12. We are generally lacking in all these energies. The group of energies 96 acts on the complex process of respiration whose rhythm, in its turn, depends on the impressions that provoke positive or negative *emotions* in us. Positive emotions provoke the acceleration of the heartbeat and, more important, of the breath. Conversely, negative emotions act directly on the respiration and, through it, on the heart. This is why one quite rightly says: *he breathes anger, hate, etc.*

When angry, we consume a great deal of energy 96 in one stroke: it takes our breath away. If we master our anger on the spot, we liberate the energy SI-12 which, as already explained, enters the emotional and intellectual centres in abundance. A flood of well-being and sweetness spreads through us then; the breath becomes normal and deep, the vibration of the centres is accelerated and this in turn provokes increased activity of the energies belonging to group 96, which leads to intensified transmutation of energies on all three scales of nutrition.

A Practical Pointer.

The *faithful* who commits himself to esoteric work while continuing to live in the world invariably provokes the animosity of those around him. Several texts in the Gospel refer to this law. It is sufficient to know the verse where it is said that man's greatest foes are those of his own household.⁵ However, an even greater enemy of man is certainly himself, precisely because of his unconditional attachment to those 'of his own household,' This is why Jesus said: *if any man come to me and hate not his father and mother and wife and children and brethren and sisters, yea, and his own soul also, he cannot be my disciple*.

3. Or profit. (Ed.)

4. At the same time certain positive emotions, such as awe, have an opposite effect of slowing the breathing and in prayer this effect leads to what is known as 'secret breathing'. (Ed.)

5. Matthew x: 36.

6. After the Slavonic text; *Piycht*, in the Greek text; *animnat* the Vulgate; *life'm*. the Louis Segond version (French) and in the King James' revised version. Here it is a reference to the Personality. — (and hence is consistent with the translated use of 'soul' throughout Gnosis, (Ed.))

7. Luke xiv: 26

This is the meaning of the other words Jesus pronounced: *think not that I am come to send peace on earth; I came not to send peace, but a sword,*

One can feel that here it is a question of the disciple's *inner* attitude towards the people that surround him, that is, *inner non-consideration*. On the other hand, we are generally deficient in *outer consideration*. Thus, when we manage to transform negative emotions into positive, acquiring inner peace and joy in the process, we must not show this victory over ourselves to the person who provoked the wave of anger in us, as it will only increase the offender's rage.

THIRD STAGE. — *Warmth*.

We must not take this word as merely symbolic. Real heat is born in us when the inward friction becomes sufficiently intense and is used rationally. It happens in exactly the same way as where heat is produced when two bits of dry wood are rubbed together. Of course, for this one must have *dry wood*. The attentive reader will understand the esoteric meaning of these words.

When we feel this heat we can be sure that we are on the right track. The sweetness it brings never satiates us.

We have seen that this heat can come from the proper use of circumstances; but it can also be provoked by certain prayers. The friction then comes in the middle of an act of *presence*, of the confrontation of the *T* of our Personality, in its lowliness and its weakness, with the *Thou* of God's infinity. The power of the prayer depends on the intensity of feeling which is born of this opposition and which is felt as a result of the double nature of the emotional centre. Pride, even the smallest trace of it, renders this confrontation inoperative. The well-known traditional maxim says: *God resisteth the proud*,

The heat is produced by the *feeling* which is born of this confrontation, and not by the *words* of the prayer. Besides, in this case, the prayer must be short so that the heart can recite it unceasingly, inwardly, and can then preserve its inmost meaning while abandoning its form and the words of which it is composed. If one succeeds in this, the heart experiences an ineffable transport of joy, which is something we should try very hard to obtain.

A Practical Pointer.

We reach this progressively. Firstly, we must recite the prayer aloud; then we form the words with our lips without producing any sound and, lastly, we say it in spirit. The alert reader will understand the meaning of

8. Matthew x: 34

9. Proverbs ii: 34; James, iv: 6; Luke xiv: 11; I Peter 5: 5.

this method. Its application is individual and is one of the group of daily exercises which form the *Pravilo* (Rule).

In Orthodox monastic practice they use the *Jesus Prayer* to this end. It is repeated as follows:

Lord Jesus Christ, Son of God Have
mercy on me, a sinner!

In monasteries and convents it is repeated ten or even twenty thousand times a day. Those who work in the "world are recommended to recite this prayer in series each of twelve times, that is, three times as written above, then repeated four times. We should repeat from one to four recitations a day in this way.

FOURTH STAGE, — *Fire*.

The first three stages *offusion* require sustained effort. The last two are of a spontaneous nature. The heart sets *itself* aflame when the friction liberates sufficiently strong heat, as is the case with two pieces of dry wood.

This is the *mystical Fire*. From there, it spreads through the veins. A traditional maxim refers to this subject in the following words: *When the fire burns in the blood, the very composition of the nervous system changes in essence*. And the blood becomes 'blue'.

At this stage, the wonder-struck seeker will see in his own depths the image of his real 'I', a brilliant ray of the *T* of his Lord.

In the Gospel according to St Thomas, which was discovered recently, the following allusion is made to this:

Let him who seeks, not cease seeking until he finds, and when he finds, he will be troubled, and when he has been troubled, he will marvel and he will reign over All.

To reign over All. The reader will understand that this means identification with one's real *T*, which is a fragment of the Lord's *T* which reigns over the Universe.

FIFTH STAGE. — *Fusion*.

The fusion takes place in different ways but always begins from the emotional centre, under the influence of an intense emotion cultivated through continuous efforts,¹¹ or of a sudden emotion as in the case of the good thief on the cross, or following a long accumulation of diverse emotions oriented in the same direction. The nature of the *fusion* is, therefore, strictly individual. It can be the result of a *sacrifice*: that of the soldier who sacrifices himself for his country, for example. Did not Jesus say that there was no greater love than that of someone who sacrifices his soul for

10. *Gospel according to St. Thomas*, op. cit., Log. 2, p. 3.

11. For this, the Tradition says that it is necessary *to/one oneself*.

12. After the Slavonic text; *psyche* in Greek. It refers to the Personality.

his friends. It can also happen in the wake of any other intense manifestation of true Love.

Love, therefore, is the common element in all the processes which lead to *positive fusion*. In reality it is Love, and Love alone, which sets the heart aflame while it leaves the head cool. *The fusion* effected in this way has a definite nature.

Fusion can also take place under the influence of a strong negative emotion, the fear of sin, for example. But in this case it is not and cannot be total. Its quality is hybrid and its effect is insufficient.

If, later on, the man becomes conscious of this insufficiency, and if he persists in his desire to attain a correct and perfect total *fusion*, he is first called upon to destroy his partial *fusion* and then to start all over again from nothing. But this destruction can only be made at the price of considerable suffering. Once he is conscious of the fact that *the fusion* is defective, the man must force himself to destroy it as soon as possible. This is all the more difficult because the *imperfect fusion* is the result of a long accumulation of emotions oriented in a wrong direction.

If the defective *fusion* is destroyed, at the very moment of its destruction the man can appropriate and turn to his profit all the power of the emotions with the effects of which he had managed to create a partial or negative *fusion*. In this case, as in the struggle against negative emotions, the positive effect remains when the pernicious effects of the negative *fusion* have been effaced. However, there is one condition for this: the destruction must be accompanied by the practice of constation while in an active state of *presence in oneself*.

We should also note that besides all kinds of partial or negative *fusion* there also exist *crystallisations*. These are always incomplete and localized. But one must not confuse them with what is, in the esoteric sense, human *nature*. The latter could be compared to a viscous mass in a liquid; it can show one or several points of crystallization which have been obtained mechanically. Often, this comes and grows with age, especially in people who are hardly interested in what oversteps the limits of the immediate in space and time. Then the prudent become avaricious and the dictatorial become intractable. Mental sloth augments with age, so that man becomes incapable of having an original thought; from then on he lives with the thoughts of others which, in their turn, become progressively crystallized in him, losing all their healthy versatility. These phenomena are sometimes also to be found in the young. They are signs of premature aging.

13. John xv: 13.

(2)

These are the different aspects of the process of *fusion* that we have briefly studied during the five stages of its realization. Once it is attained, the *T* of the Personality becomes monolithic and is no longer a conglomeration of filings or little '7', but a stable entity. At that moment, the seeker finds himself on the fourth step of the *Staircase*, in front of the *second Threshold* and ready to cross it,

CHAPTER XX

(V)

Let us go back a little to study the complex problem of the 'I am' as it appears before *fusion* takes place.

We have already studied the transformations which take place in the relationship between man's Personality and his real T once he acquires esoteric knowledge or *gnosis*. But this time we will also take the *T* of the body into consideration and follow the combined evolution of the three *I's*: of the body, of the Personality, and the real T, before and after the second Birth, the birth of the *Individuality*,

At the outset the situation can be represented by the following diagram :

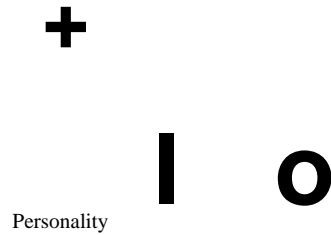
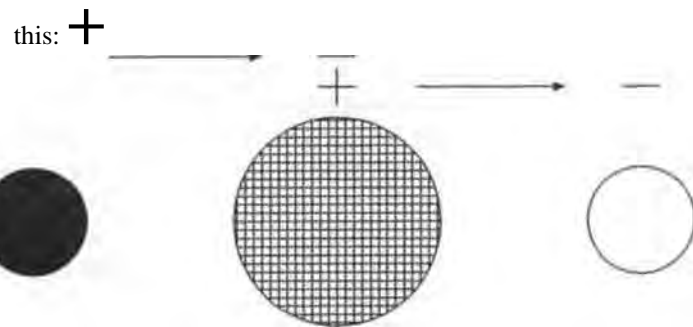

FIG. 25

With the introduction of the T of the body, the Real T diagram looks like



T of the body

Personality

Real V

(The arrows indicate the direction in which authority is exercised in the normal daily life of human beings.)

FIG. 26

1. Cf. Vol 1 pp. 42 ff.
2. Cf. Vol. I, fig. 13.

We know that in *exterior* man the real *T* manifests only rarely and waits to be consulted. In other words, the *T* of the Personality is active in relation to the real '*T*'. However, in certain grave situations the real *T* imposes itself on the generally dormant positive part of the lower emotional centre, awakens it momentarily, and then sends warnings through it to the Personality. But very often these alarms are not heeded. As for the '*F*' of the body, in the average healthy adult this is strongly developed. Except in relatively rare cases of shock or from sudden unexpected impressions, the body knows perfectly well what it needs for its sustenance, as well as for its rest, for pleasure, and for all its desires.

The Personality lives in the body and expresses itself through its organs. Because of this, the *T* of the Personality depends on the *T* of the body for the greater part of its manifestations. In its turn, the real *T* reveals itself through the Personality. This is why in life the *exterior* man largely depends on it. Through it, to a second degree, he also depends on the *T* of the body. Indeed, a wave of fever or a toothache can make the *exterior* man momentarily lose his generous ideas and all his spirituality.

As the previous diagram shows, everything is interdependent.

However, each of these three '*I*'s has its rules and its own aims and, to attain these latter, each employs the good offices of the Personality. Thus, when the *T* of the body finds that the moment has arrived for it to eat, the Personality, at its instance, takes all the necessary measures: the purchase, preparation and absorption of food. In this example, the *T* of the body and the *T* of the Personality change their respective positions several times, becoming dominant or subordinate by turns. If we take the trouble to note the whole procedure that ends with dinner, we will see that this reversal of (+) and (-) signs intervenes dozens of times, and that on the whole the Personality serves the *T* of the body.

Though in a much less varied manner, the signs also change in the relationship between the Personality of the *exterior* man and his real *T*. Generally, the *T* of the Personality is active in comparison with the real *T*, in the sense that it follows the latter's advice only when it thinks fit and except in very rare cases it fails to heed warnings. Of course, here we are not referring to the *Just*. But this does not mean that the *T* of the Personality is not conscious of the imperatives and indications of the real '*T*'. He certainly is aware of them, at least in all instances when the man is placed before an important alternative and must choose.

If at that moment the *T* of the Personality is not exposed to strong outward or inward influences: fascinating views and calculations for the intellectual centre; likes or dislikes for the emotional centre, and if, at least momentarily, it is not under the sway of the desires of the '*T*' of the body, it can hear and take into consideration the messages of the real *T*. The latter are adapted to the unfinished Personality's capabilities in

perception and to its level of comprehension as, for example, in the case of the *Decalogue*. But generally these conditions are not realized, and then man takes no notice of the warnings of the real *T*. Yet, the *T* of the Personality knows perfectly well that the messages it receives from the real *T* are correct and clear. So much is this so that in ignoring them the *T* of the Personality suffers the bitter after-taste of the false moves it has taken. This is why acts that are prompted by hypocrisy, cowardice, perfidy, jealousy, vengeance and other expressions of human baseness, not to mention lies, never pass without leaving a certain bitterness at the bottom of one's heart. The bestial joy of acquiring domination by violence or crime, even one that goes undiscovered and unpunished, will never compensate for the affliction of remorse that follows.

The result is that in spite of its apparently domineering attitude towards the real *T*, the *T* of the Personality is drawn to it. The situation is even more complicated by the fact that the impressions left by these conflicts of intention are obliterated from the individual's memory only with great difficulty, if ever. With time and with the accumulation of decisions taken arbitrarily by the *T* of the Personality without caring in the least about the inmost heart, these conflicts increase in strength and in proportion,

But then, the human Personality is also too often drawn towards the other side, towards the *T* of the body,

If the real *T* reveals no trace of doubt, in the majority of cases nor are any to be found in the *T* of the body. This is why, when the latter raises its voice, its imperatives are almost always categorical. It is in this way that the Personality or, in other words, the *exterior* man who is identified with it, is pulled in opposite directions by imperatives proceeding from the Soul⁵ — from the real *T*—and by others proceeding from the flesh... from the *T* of the body.

If, for better or for worse, the Personality manages to ignore the imperatives of the real *T*, its evasive tactics and suppleness are only rarely successful when it is opposed by the imperatives of the *T* of the body. This struggle between the Personality, which is composite and is therefore weak, and the *T* of the body, which takes clear decisions, generally results in a defeat for the Personality, preceded by manoeuvres, cheating, and by lies to itself and to others. In the majority of cases, when the Personality succumbs to the *T* of the body, the latter is acting under the direct or indirect influence of sexual energy. Then the Voice of the real '*V*', the supreme Judge, will speak to the man from the depths of his heart, and its verdict is always firm and just,

3. 'conflicts of intention*' is used to express the single French word '*tirailkmtiits*'. (Ed.)

4. Fr. '*for intricur*' — the voice of the inmost heart or conscience. (Ed.)

5. Fr, '*Am'*' often translated Immortal Soul¹.

But although his Personality is unfinished, contrary to certain modern theories, the *exterior* man is responsible for his acts. This fact is confirmed by all Religions.

(2)

Romantic literature in all its variations is based on the diagram reproduced above (fig. 26), which faithfully reflects the realities of the life of the psyche of the *exterior* man. This represents the interdependence of man's three *I*'s, from which arise the continual inner dissensions that take place in the consciousness of the *T* of the Personality whenever it comes out of its mental somnolence. This happens as the effect of conflicts of intention provoked by shocks, whether they come from without or from within.

St Paul describes this very real situation with singular force when he says: *for that which I do allow not; for what I would, that do I not, but what I hate, that do I.*⁶

This is also the theme of *the free romance*, as already defined, which is the characteristic of the moral relationship between man and woman during the *Cycle of the Son*. This romance is based on reciprocal free choice in love, duly crowned by marriage, and built around the principle of monogamy. Of course, this is not an ideal formula since in practice it is nearly always a failure; it is an intermediate solution between the patriarchal *polygamy* of the *Cycle of the Father* and the infallible *unique romance* of the *Cycle of the Holy Spirit*, which is based on the reciprocal recognition and union of polar beings.

We repeat that the three *I*'s represented in this diagram form the basis of every romance experienced by *exterior* man, especially in the more dramatic forms. But the free romance holds an almost irresistible attraction for these men, because its romantic side is reinforced by the sexual influence. For the representations that lovers make to one another are coloured by Illusion, begin their action under the sexual influence, and never correspond with reality. But even if they are objectively false, these sublime representations can provoke ideal visions in the lovers simply through the inflow of fine energies; energies that come in the first place from the Hydrogen SI-12. Once the marriage is consummated, these visions progressively come up against implacable reality; disillusion and dissatisfaction result and generally lead one or both of the ex-lovers into the arms of a 'prince charming' or a 'wonder woman'.

On the whole, this is the plan of the *free romance* experienced by *exterior* people, whether this romance is lived or written, read, or seen in a film.

6. Romans vii: 15. From the King James Version.

Circumstances such as place and time, as well as the direct and indirect additions, only serve to pad it out.

In practice, this is an unresolvable situation — except for the union of polar beings, of course. But the latter, which is the only real union, seems an unrealizable dream to the *exterior* man. So he becomes resigned to his lot, saying that if marriage is an imperfect formula, every other solution is equally doomed. Turning away from the higher plane, he descends to the lower plane to discover adultery.

W

Where the partners are of a romantic nature, their reciprocal representations and the visions which can flow from them, although illusory in *nature*, reflect the *image* for each of them of his or her *real love* or ideal *polar* type. This is why the engagement period sometimes gives two people who are betrothed the delusion that their love is the true and *unique love*, and this illusion gives birth to a temporary inflow of refined energies.

The free romance is platonic at first, but a struggle takes place afterwards which nearly always ends with the victory of the body. This is the end of the first act. Then another struggle begins against circumstances which are often unfavourable; but properly speaking, this is no longer a question of romance.

The main characteristic of the free romance as revealed during the *Cycle of the Son* is that, although it begins with a knot and follows this with intrigue, *this romance as such remains unfinished*, as with the fig tree in the Gospel which brought forth only leaves.⁷ Here we must avoid confusion: marriage as we know it — that of *exterior* men who are imperfect by definition — is hardly the *fruit* of love. It is, on the contrary, its ending. It really has no organic link with what could be real love. Only true Love can bring forth fruit. But first we must *attain* it.

II

(V)

The position of the Personality may be compared to that of a weak man flanked on either side by strong men in different situations: though the real *T* is invincible, it is also, one might say, ignored. The *T* of the body varies in its desires, but it is in direct and permanent contact with the Personality which lives in the body, it depends on it, and it manifests

7. Ref. Matthew xxi: 19.

8. Ref. I Corinthians xiv: 1

through it. One may therefore say that the Personality does not enjoy much autonomy in relation to it.

The situation changes entirely when the *magnetic centre* opens the 'front door' of the Personality to the real *T*, after it takes over the direction of the lower centres once it has assured their co-ordinated working. This is when the complete and perfect *fusion* takes place in which the 'V' of the Personality identifies itself with the real *T*. This is the second Birth, that of *Individuality*. After this, the *T* of the body can no longer offer any resistance to, nor can ever impose its will on, the *T* of the *Individuality*. This is a state of ecstasy, which the *Individuality* can in principle enter at will, it can even suspend the normal functioning of the five senses, as we have been shown by the martyrs supported with joy by the Saints.⁹

The following figure shows the new relationship between the three *F*s after the second Birth:

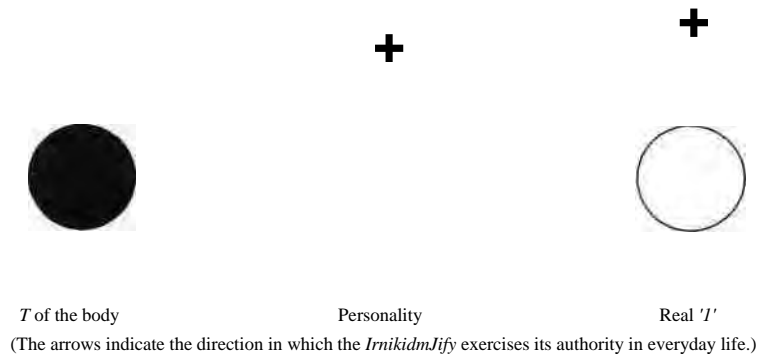

FIG. 27

The body is glorified and sublimated by this second Birth. With the completion of his Personality, man becomes perfect although still belonging to the same fundamental type: 1,2 or 3. In this new condition, *the filters* function perfectly, only letting pure elements pass into each of the three scales of nutrition.

For the man who has crossed the *second Threshold*, the above diagram should be presented differently in order to better correspond to the reality; it is no longer the real *T* who lives within the Personality and the latter in the body, as in the *externalman*, but instead it is the real *T* which envelops

9. Ecstasy has several degrees, of which the lowest can be attained without any spiritual culture. This is what those who search for the mystical 'initiation' we have called *mystical phenomenalism*, try to attain. The Orthodox Tradition is resolutely against it. In the Orient for thousands of years, certain people have used narcotics to try and reach this phenomenistic plane. After the XIXth century, this method penetrated into the Occident. It is superfluous to state that these experiments lead to the degeneration of the individual and prevent his esoteric evolution.

the Personality and gives birth to the *Individuality* which, in its turn, includes the body.

The two diagrams that follow, figs. 28 and 29, reflect man's condition before and after his second Birth.

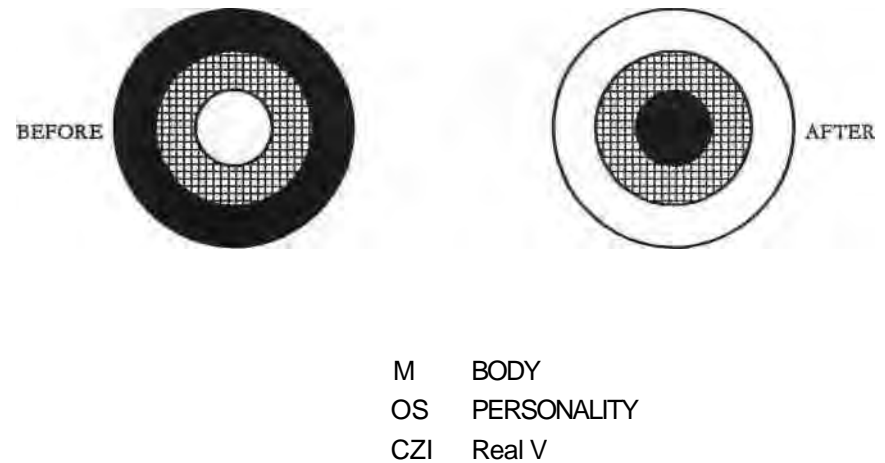

FIG. 28

FIG. 29

(2)

Now let us go back to the figure which represents the typical case of a Personality that is beginning to learn and understand esoteric Knowledge.¹⁰

We have pointed out that the permanent fink that is introduced between the Personality and the real *T* (represented in this diagram by a dotted line) is *esoteric Knowledge*.

We added that the knowledge and savoir-faire that this Knowledge — *Gnosis*—enables one to acquire, represent the *philosopher's stone* of medieval mysticism, and that they can cause the desired transmutation in the disciple. This transmutation chiefly consists of a change in the direction of the authority that acts between these different *V*s.

10. Vol!, fig. 14.

11. Vol 1, pp. 60-61.

It is for this reason that, in the preceding volume as in this, we placed the (+) sign on the side of the real 'V' and the (-) sign on the side of the Personality. But the effects of this transmutation do not end here.

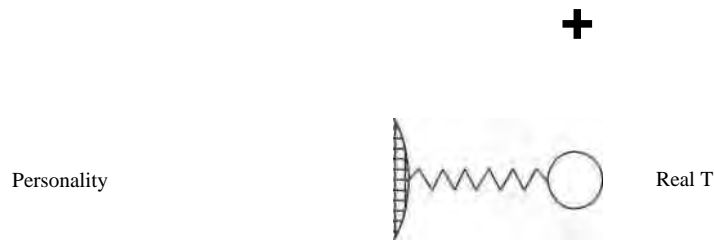

FIG. 30

We will now complete the last figure by a circle representing the *T* of the body:

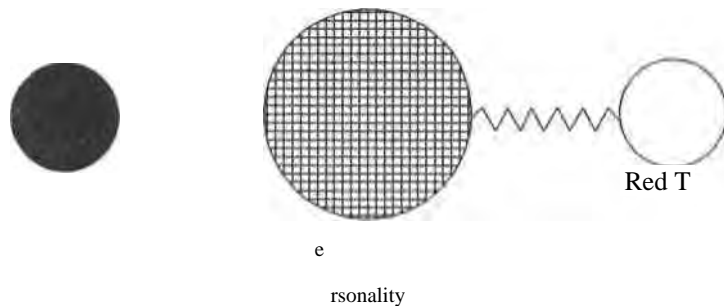
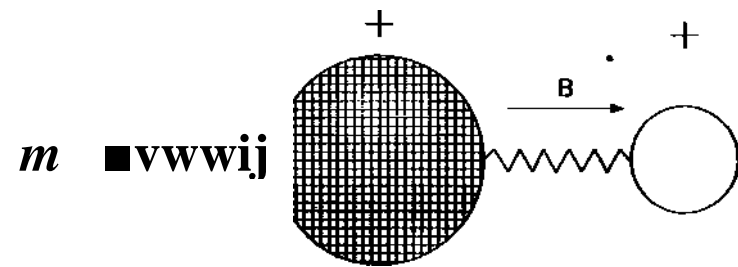

FIG. 31

Let us remember the old esoteric maxim which says: *the way that leads to the top leads to the bottom at the same time.*

If we apply this to the present case, this means that *gnosis*, conquered by conscious efforts, establishes a *link* between the Personality and the real *T* of the disciple, a comparable link is *automatically* and effortlessly established between the Personality and the body. Our schema then takes the following aspect:



Body	Soul = Personality	SOUL = Spirit
<i>T</i> of the body	<i>T</i> of the Personality	Real <i>T</i>

FIG. 32

As long as the Personality lives immersed in the 'A' influences to which it is attached by the interests of its ordinary life, it is generally passive in its relationship to the body which, for it, constitutes the supreme value, and it remains ignorant of the 'B' influences. In this extreme example the Personality falls, more willingly than not, under the authority of the *T* of the body, which in turn is dominated by sex in its direct and indirect manifestations. The feeble human heart too often approves of this state of things. We may recall Jesus' words: *where your treasure is, there will your heart be also.*

(3)

Here it is necessary to give a few more particulars. We are told in the catechism that the *exterior* man, man as we know him, is in a *corrupt* state as a result of the *Fall*. Now, it is not the whole man that fell, but the Personality which, tempted by the relative autonomy of the lower intellectual centre, turned away from the *Tree of Life*. It was dazzled by the fruits of the *Tree of knowledge of Good and Evil*; the faculty of being able to gauge its own situation, the faculty of calculating and comparing, by the attributes of the *T* of the Personality, and by the 'clear consciousness' of wakefulness. Unlimited horizons then opened up before this *T*, horizons which are in fact inaccessible since they ceaselessly flee before the explorations of the human spirit, but their pursuit has continued from those days right up to our own time.

The fruits of the Tree of the knowledge of Good and Evil are relative. In time, man understood this. But by the time he was able to grasp the truth he had already forgotten everything permanent, unalterable and, therefore, *real*. And in the magnificent race of *Progress*—progress only in means of doing

things — he forgot himself. For him, the *Tree of Life* became a legend. Having forgotten the real 'T', the Personality was progressively deified as the supreme value in an observable, knowable, sensory world where man knows full well that *all is relative*.

This situation persists today and is even getting worse. The 'conquest of Space', which is the latest watchword of intellectual progress, does not change the human condition.

All that remains of what existed before the fall has been handed down to us thanks to Seth—Eve's son—who was mysteriously conceived and who is the father of the esoteric Tradition. But only a thin thread¹⁴ of this Tradition has been preserved in Eastern Orthodoxy and elsewhere.

The fall of the Personality did not entail the fall of the real T, nor of the T of the body. The former seems obvious, but the latter seems more difficult to understand. The surprising thing is that the body dies. But the body became mortal precisely because of the corruption of the Personality: the motor centre, which is the physiological motor of the body, suffers the same fate as the Personality, as it is part of it, and as a result is closely linked to it. Thus, contrary to general belief, the body does not die because of its own deficiency, but because of that of the Personality. When the latter is no longer in this situation the body is governed by the sexual centre which, like the higher emotional and intellectual centres, is *immortal*. In man, this is the monad which expresses the Absolute III, just as the higher emotional Centre expresses the Absolute II and the higher intellectual Centre the Absolute I.

By looking at things from this angle we can better understand the indication given us in the Book of *Genesis*, which says that man was made into a *living soul*. Commenting on this text, St Paul said: *there is a natural body and there is a spiritual body. And so it is written, the first man Adam was made a living soul*}¹⁵

Now, the corrupted man, especially the cultured man 1, 2, or 3, thinks that he has come into the world not to *live*, but to *die*.

We have seen that with complete regeneration, man obtains T, *Consciousness* and *Will*¹⁶ in absolute form. To be more precise: the organ of the real T in man is the higher emotional Centre; the organ of *Consciousness* is the higher intellectual Centre; the organ of *Will* is the sexual Centre.

It seems clear now that, in spite of its deficiency, its illnesses and even its death, the T of the body, governed by the sexual Centre, is infinitely

stronger than the human Personality as it functions in the *exterior* man, in whom it takes the form of 'shifting sands'.

m

We spoke earlier about *the first* link that should be established between the Personality and the real T. This is a relationship established between them through the disciple's conscious efforts during his initiation into *esoteric Knowledge*, and it is neither sketchy nor nebulous. Just like positive science, *this gnosis is systematic*; and it is just like other knowledge because of the systematic structure of the Cosmos, whether it is taken as a whole or in its smallest details.

The relationship between the human Personality and man's real 'I' which forms the object of esoteric science and is comprehended in certain different kinds of *discipline* which form a complete cycle. This cycle comprises *eight* disciplines in all, each of which leads to a clearly defined result. The first should be learned and assimilated before the second Threshold, while climbing the *Staircase*. If correctly taught, studied and digested in *theory* and in *practice*, it enables the student to mount the fourth step of the *Staircase* and appear before the second Threshold with a good chance of crossing it. It is useless and even dangerous to appear before this Threshold before acquiring this Knowledge.

Gnosis, when it is studied and practised like this, leads to *courtly love*, which rules the fourth step.

Courtly Love is in fact the love that Jesus preached in the New Testament. It forms a higher revelation relative to the *carnal Love* which is animal in nature and which one finds in the Old Testament. It is the Key to the Kingdom of God, that Paradise lost.

III

(V

In practice, from the viewpoint of man's interest in life, this Paradise appears in the form of an indivisible and indissoluble union of polar beings.

The reader may recall the words of St Paul which we already quoted and which are so rarely understood: *nevertheless neither is the man without the woman, nor the woman without the man, in the Lord*.

18. Lit. 'vital interest'

19. I Corinthians xi: II.

14. Fr. 'mince filierf.

15. Genesis ii: 7.

16. I Corinthians xv: 44-45

17. Vol. I, pp. 82-82.

We must refrain from giving this text a symbolic meaning: it refers to a real event, a *reintegration*, in other words to the *Androgyne*.

We will continue the theme of this chapter by taking one more step towards the reality of what is taught by the Tradition in the form of *gnosis* or higher Knowledge, which is the first discipline of *absolute Knowledge*,

Before working our way from the bottom towards the top, we started with the *individual*, as we know him in life and as we are ourselves, *man born of blood, of the mill²⁰ of the flesh¹¹ and of the will of man¹²* who identifies himself alternately with his unfinished Personality and his finished body, and who is either on the road to growth or to degeneration.

At first, the idea of the real 'V' seems a wild fancy to him. It seems *foolishness to men*. It is only much later, if at all, that he understands that the *teal foolishness to God²⁴* is to identify himself with his own Personality.

But if he admits the existence of another centre of consciousness in himself, or of another *T* than the one to which he is accustomed ... of a real, permanent, supersensory *T*, a Divine monad which as a *Microcosmos* possesses the attributes of the *Macrocosmos*, his conception of this can only be theoretical, in the form of an intellectual representation, a postulate proposed but not so far demonstrated. It follows that this conception will fall within the usual framework of his representations: *individual* or even *personal*. And this will seem perfectly logical and natural to him.

But it is not the reality.

We discussed the problem of the *Androgyne* at length in the first volume of this work. We pointed out that the *Microcosmos*, properly speaking, cannot be constituted of only one 'person', however highly evolved, The *Microcosmos* can only be formed by the *union of polar beings who have reached the term of their growth and development*. In the diagram which represents them we have shown this *complete being* as a whole. And we have added that, as such, it reflects the *manifested Absolute* in the created Universe integrally, in all its aspects.

20. 'Desire', in the Slavonic text.

21. Woman.

22. Cf. Johni: 13.

23. Cf. 1 Corinthians ii: 14.

24. 1 Corinthians iii: 15,

25. Vol. I, p. 247. fig. 61.

(2)

However, it is difficult to conceive —this concept being too far from our usual representations—that anybody's real *T*, as a monad of the *manifested Absolute*, must be and is in fact androgynous in essence, in other words, that it is polarized or *bi-polar*.

At first, this idea seems so unbelievable that one has to get used to it.

Yet, is not our Personality also bi-polar in a certain measure? Of course. Through introspection, every man can find certain feminine traits in himself, just as every woman can find some masculine traits in herself. In certain extreme cases, this polarization produces the abnormal but well-known phenomenon of effeminate men and masculine women.

In the unfinished Personality of the *exterior* man, which is shifting sand, this polarity is not yet, and cannot yet be either clearly defined or properly formed. These are qualities only of the fully developed and *born* Personality. However, we can glimpse this polarization as it appears in us. This may be obtained without any difficulty through a succession of introspective efforts which will pass almost the whole of our inner content in review.

In fact, this polarization of the elements of our Personality is nothing but the faithful reflection of the world. This explains why the Orthodox Tradition applies the term 'world' to the whole life of the content of man's psyche.

Without this polarity, any understanding between persons of the opposite sex would be absolutely impossible. It is generally difficult anyway, because of our unfinished nature and because we have individual deformations. It is the presence of common elements in the two sexes that bridges between their Personalities and, to the measure of their evolution, renders mutual comprehension possible.

Now, if we pass from the Personality to the body, we will observe without any difficulty that our bodies are also polarized. Embryology and anatomy show us that all the organs that are characteristic of the man are found in rudimentary form in the woman, and vice versa. In the working of the human organism, and especially in that of sexual life, the hormones play a role of polarization which reminds one of the analogous phenomenon encountered in the life of the psyche. Indeed, we know that a certain percentage of feminine hormones is to be found in man and that the woman's organism secretes a certain proportion of masculine hormones. And just as the polarization of the psyche allows mutual comprehension between people of the opposite sex, so polarization of the hormones ensures sexual attraction.

This phenomenon is complex, and the present level of our knowledge does not throw any light on it. But from what has already been said we can

state that a decline or complete lack of the hormones proper to the opposite sex leads to a decline of sexual attraction due to the lack of this 'bridge',

From whichever point of view one considers the problem one comes to the conclusion that, man or woman, *the whole human being is polarised within.*

(V)

It is only when this observation has become evident to us that we can make the assertion that every human being carries the image of his polar being in the depths of his heart, and that we *can feel it*. In certain conditions it is even possible to objectify it. However, this is not the case for the great majority of human beings. Firstly, the idea of a polar being is unknown to us. Secondly, when we are told about this it generally leaves us indifferent, as we prefer the system of free romance.

Only an infinitely small minority of human beings feel the anguish caused by their inward isolation and ardently aspire to find the *Lady of their dreams*. Before one can aspire (to something) one must at least *think* (about it). This thought must literally devour the Knight's heart, forcing him to accomplish the most perilous feats with the aim of finding the object of his aspirations.

Those who live anchored to their unfinished Personalities, dominated at all times by their bodily desires, and who participate enthusiastically in a life ruled by 'A' influences, are satisfied with their lot and feel neither the need for nor any interest in such a search. The 'free romance' suits and satisfies them, and they find the idea of the singular romance chimerical.

Naturally, this does not change anything in the objective state of things.

(4)

Although its significance was forgotten, a very ancient symbol of the real *T*, the divine monad of the manifested Absolute, has been preserved by the Tradition in the Orient. It has now re-appeared in the West, and is now utilized by certain authors, who have written various commentaries on it. This is it:

WMP | colour GOLD M |
 | colour SILVER W

FIG. 33

When applied to the relationship between the *I*'s which we studied earlier, it gives the following figure:

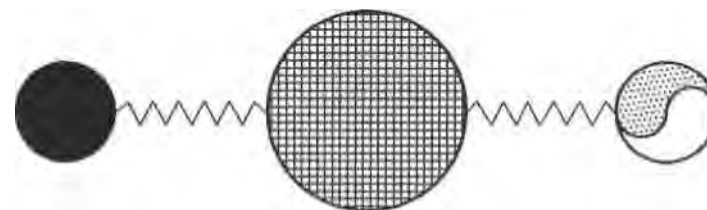

FIG. 34

The great mystery lies in the fact that *the real T of polar beings is one and indivisible*. One for the two of them.

Not only this, and here again it seems mad in the eyes of men, but it lives simultaneously in the two Personalities and, naturally, in the two separate but polarized bodies.

By changing the direction of the preceding diagram for sheer convenience, we can represent this situation in the following manner:

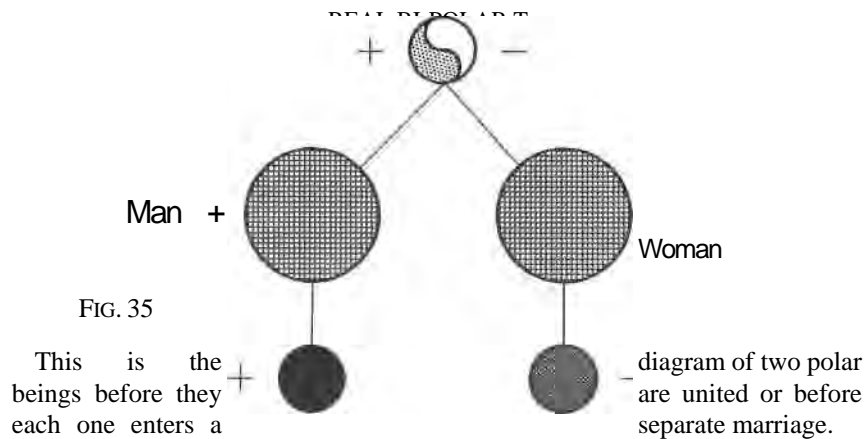

FIG. 35

This is the diagram of two polar beings before they are united or before each one enters a separate marriage.

The union of two polar beings who as yet do not realize their polarity may be represented as follows:

REAL BI-POLAR T

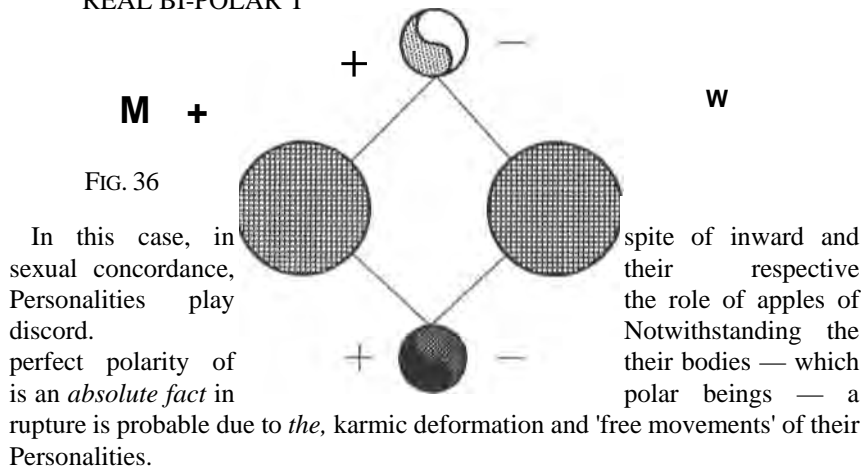

FIG. 36

In this case, in spite of inward and sexual concordance, their respective Personalities play the role of apples of discord. Notwithstanding the perfect polarity of their bodies — which is an *absolute fact* in polar beings — a rupture is probable due to *the*, karmic deformation and 'free movements' of their Personalities.

W

Whether it happens only once or repeatedly, the case of adultery is represented in the following schema. Like polygamy or polyandry, adultery produces a union only on the physical level. The following is the diagram of a classic case — the eternal triangle as it is called:

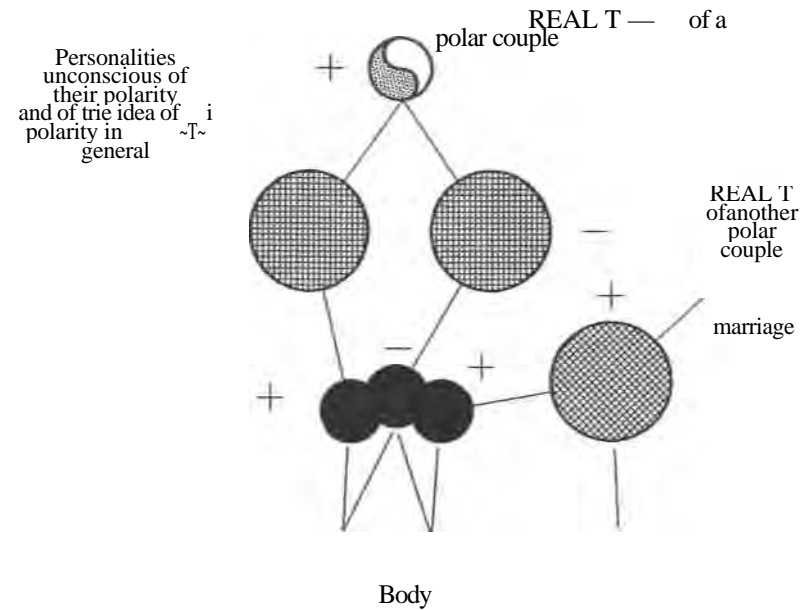

FIG. 37

The multiplication of *incomplete* physical unions, contracted in most cases by both partners, can be represented by a very complex figure. This would be the image of the real life of *exterior* men on the wrong side of the first Threshold, and more flirtatious than emotional.

W

Now we will represent the case of polar beings who are conscious of their polarity and who aspire to moral union: that of the Knight and the Lady of his Thoughts (Fig. 38).

As a prelude to their complete union this aspiration, after it penetrates into their waking consciousness, will gradually impregnate the *I's* of their Personalities, thus creating an amorous or *courtly* 'Love' which is quite different from that experienced by the normal run of human beings. This sets their hearts aflame and inspires them with the courage to look for the

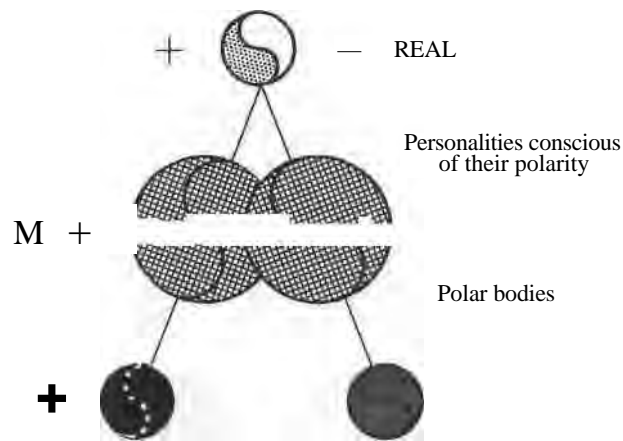

FIG. 38

means, especially those of the inward way, which will enable them to overcome all the karmic obstacles that appear on their road. This is only possible through *conscious efforts* by acquiring theoretical and practical *gnosis*.

In the case of success, the diagram above will look like that reproduced in fig. 39. This is the diagram of the legitimate betrothal of two polar beings.

If the union of their Personalities becomes so perfect and intimate that they do not even need words to communicate with each other, then the *first link* of which we spoke earlier, the acquired *wjw* integrated by two strictly polarized Personalities, *being practically ONE*, will place the polar beings on the fourth step of the *Staircase* immediately in front of the second Threshold.

The birth of the *Individuality* takes place after crossing the second Threshold, (the door to the Kingdom of Heaven), through the indissoluble fusion of the polarized Personalities which at that moment become ONE with the Divine monad, their unique and real T.

If both partners are alive, this fusion *automatically* entails the polarized union of their bodies. If not, after the survivor's decease the two beings, still united and forming only ONE, will be reincarnated, but this time consciously, with the aim of fulfilling a mission within humanity.

In the latter case, one must note that in olden days, when the *Wheel of Destiny* turned slowly, this reincarnation could sometimes take place only after centuries of waiting. Now, on the eve of the Era of the Holy Spirit, everything on this plane takes place at the rhythm of contemporary life on the earth.

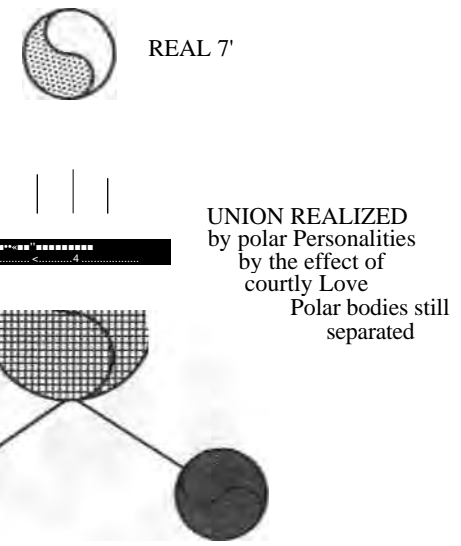

FIG. 39

(7)

The perfect and therefore complete union of polar beings brings to birth the *Individuality*, the New *Microcosmos* that is the realization of the *Androgyne*. Taken to the limit of its development, this *Individuality* is represented symbolically in fig. 40,

This is Paradise, rediscovered by the Grace of God through *Love* attained by conscious efforts, and through the courage the polar beings have manifested in die course of their uninterrupted *invisible Combat*.

This union is Sacred.

On reaching this point and looking back on the road they have covered, the polar beings will understand the meaning of the words that Jesus addressed to his Disciples a few moments after his arrest:

".. *Andye now therefore have sorrow; but I will seejou again, and jour heart shall rejoice; and your joy no man taketh from you.*"

26

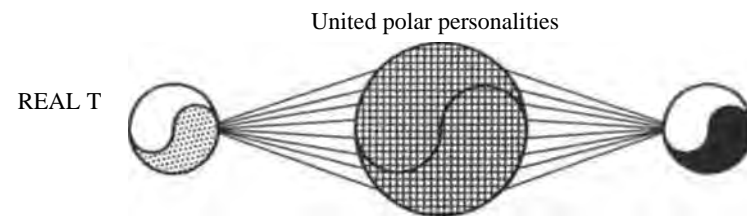

FIG. 40

UNITED
POLAR
BODIES

(8)

This state of the polar beings, when they are united in their completed *Individuality*, is accompanied by Redemption in a glorified body, traditionally represented in the following way:



FIG. 41

We have said that, as soon as the links between the Personality and the real *T* are established through conscious efforts, similar links are automatically formed between the Personality and the physical body.

The number is sixteen, eight in each direction. Thus, by following a normal esoteric evolution, the bi-polar Personality becomes an *Individuality* and obtains absolute mastery over the body. Once the eight links with the body are firmly established, the *Individuality* can exercise this mastery in the form of eight^{xawr} which have been considered marvellous by human beings from time immemorial.

Jesus showed them all, but their real significance was not understood. Yet He said: ... *Be of good cheer, I have overcome the world.*²¹

27. johnxvi: 33.

CHAPTER XXI

(1)

Now that we are reaching the end of the *mesoteric* cycle of *Gnosis*, it is time to raise the question of the AIM of our life.

We have viewed this problem many times from different aspects: cosmic, planetary, social, etc. But now we will try to study it more closely and, if possible, to find a solution on the individual or egocentric scale while keeping it within the framework of the complete Doctrine as this is now known to the reader.

This problem has been studied from the earliest times by the most talented of men. Philosophy, ancient and modern, religious and secular, offers a number of solutions, but these solutions cannot generally be taken into consideration by science since they define the unknown through intermediate steps involving one or many other unknown factors. This is why, in the absence of objective elements which constitute the usual premises of a problem, we resort to factors deriving from beliefs, traditions, etc. From whatever angle one looks at it, this method will not stand up to scientific examination nor to critical analysis. What is more, whenever this problem is posed, each philosopher or poet marks it with his personal touch, which, in most cases, is pessimistic.

Pushkin, who was passionately in love with life, had a very keen sense of truth and was incapable of lying to himself. Yet he was content to *ask* himself the question without trying to find a solution to it:

Marvellous gift, *useless gift*,
Life, to what end were you given to us?

This great poet, whose lyricism was dedicated to beauty and truth, did not develop his contradictory observation of the uselessness of a marvellous but factitious existence. When he was thirty-seven years old he was killed in a duel because of a woman — his wife,

Though younger than he, Pushkin's contemporary, Lermontov, was a poet of the same stature, and at the age of twenty-eight he was also killed in a duel. He wrote in the same pessimistic vein:

Life without love is the tomb. Love
eternally? — Impossible!

Here are two constataions, two *visions* of things that the prophetic spirit of these two great poets grasped and poured out in their moments of inspiration when they were under the dominion of *Maya*, the Great

Illusion, the sovereign power of the *General Law* that is enforced by the Absolute HT.

These are constataions regarding the state of things existing in our *Mixtus Orhis*, in a worldly life predominantly influenced by the 'A' factors. Even though both of them were bound, nay anchored, to this 'life' by all the force of their ardent temperaments, they were nevertheless capable of contemplating it from the elevated point of view of the 'B' influences; perhaps even 'C' if not 'D' influences. This dialectical position created an inward anguish in them both: they lived in a world that was submerged in lies when they themselves were incapable of lying. It was a situation without any solution on our plane. And the *General Law* wiped them off the face of the earth, letting their tumultuous souls enter into the Peace of the Lord, their celestial Home.

However, in spite of his pessimism, Lermontov went even further than Pushkin, and announced the great truth about which everybody was generally silent. For, though the poets versified it in different ways, they alluded to it only in symbolic form. He proclaimed it aloud, which was positive.

(2)

Let us now study this problem from the point of view of the Tradition.

The reply to this great question is to be found in certain esoteric monuments.

In the Orthodox Tradition, one is taught that a book exists which is *The Golden Book*- The maxims and texts which figure in it are revealed to disciples gradually, as they progress on the *Way*. These fragments are read to them only once, but the disciple must remember them word for word and learn them by heart.

This is not a *Book of the Dead*, but a *Book of the Living*,

And this is what is inscribed in the book regarding the question we have just raised;

*To live means to love;
He who loves not, hardly lives,
He leads a mournful existence
Whose only meaning lies in the hope of loving.*

The remainder of this text is aimed at polar beings. We have already commented on it without having divulged it, and we will return to this subject later.

This principle which is so strongly stated in Lermontov's couplet had already been pronounced by St Paul nearly two thousand years ago. He said: the aim of life is *to attain Love*.

To attain *Love* is indeed to attain *Light*, to attain the *Spirit*, to finally attain *God*. For:

*God is Love God is
Light,² God is
Spirit.*

And St John adds:

*For Love is of God ... and
He that does not love has not known God.*

Our ideas of the *temporal* and the *spiritual* are generally opposed. This opposition is expressed as an alternative, a dualistic formula which, as such, remains incomplete because it is faulty in its reasoning and consequently leans towards the two extremes. Nevertheless it seems convincing to our intellect, since this is also of a binary nature. But although it is admitted by the mind, it does not explain or resolve anything. On the contrary we find it as the basis of innumerable divisions, conflicts, anathemas and wars,

In order to make this formula applicable in practice it is necessary to harmonize it with the objectively real state of things as it was revealed in the second part of this volume: with the system of the three cosmic octaves.

Then we can easily understand that the complete formula is of a *threefold* nature. Balanced and harmonious, it covers the whole scale of man's possible evolution, as well as that of human society — without discontinuity. And whereas the dualistic formula *spiritual-temporal* engenders only doubt, divisions, and death, the threefold formula, which is complete and vivifying, leads from death to life,

Inserting *eternity* as an intermediate term between these two extremes represented by the terms *spiritual* and *temporal*, the formula then appears in complete form as:

Spiritual- Eternal- Temporal

It is easy to understand that each of these terms represents the attributes of the Absolute I, the Absolute II, or the Absolute m, respectively.

1. I Corinthians xiv: 1.
2. I John iv: 1.
3. I John i: 5.
4. John iv: 24
5. I John iv: 7.

On the plane of human love, the real antinomy, which is the object of esoteric work and studies, arises from the opposition of the *temporal* to the *eternal* 2nd not of the temporal to the spiritual which, for the *exterior* man, is confined to the domain of pure theory.

The key to the question of polar beings is to be found here. It is a crucial one for those who aspire to follow the fifth Way, which is that of the Knight and of the Lady of his Dreams,

For the real *T*, which is ONE for polar beings but lives in two Personalities in two different bodies, belongs to the *Eternal* and thus belongs indirectly to the *Spiritual*.

While the *T* of the body belongs to the *Temporal*.

W

In a manner of speaking the *T* of the Personality, which is situated between the two other *I*'s, is the great *question-mark* of our lives. The Personality can perish if it identifies itself with the *T* of the body, or it can gain eternal life by identifying with the real *T*.

So everything depends on the attitude that a man adopts towards himself and his life: on whether he builds directly on the sand or digs first until he reaches the *rock*.

In fact, the human Personality is a *talent*, a marvellous Divine loan given to man so that he can make it germinate through Work; it is not given to him so that he can bury it. If he does so, he is only establishing himself in the *Temporal* illusion which he obstinately takes for the real in spite of all the evidence to the contrary, evidence that is confirmed by death.

This idea, or rather this fact of an *existence loaned* to us with the opportunity to make it permanent through Work, should be ever-present in the seeker's mind if he aspires to the *Way*, the *Truth* and the *Life*. And he should not forget for one instant the maxim which is inscribed in the *Golden Book*, that *anyone who does not develop his talent loses it*.

(V

We have said that Love, like the personality, is also a Divine *talent* which is loaned to man, and we will repeat this more than once. Everybody shouts: *I love, you love, he loves*, etc. But first of all we need to be aware of just what can be objectively true in this assertion. This is the problem.

The nature of Love cannot be defined precisely in scientific language. We can only judge from its known manifestations.

6. Matthew vii: 24-26.

7. John xiv: 6.

St Paul gives us an objective and complete description of it in the following lines:

Love is patient and full of kindness; love envieth not; love vaunteth not itself, is not puffed up with pride; does nothing dishonest; seeketh not her own, is not easily provoked, thinketh not evil, rejoiceth not in iniquity, but rejoiceth in the truth; beareth all things, believeth all things, hopeth all things, endureth all things.

These are the manifestations of Love, that is, of true, objective Love. By reversing the terms of St Paul's formula one may recognize without any difficulty the manifestations of negative emotions like jealousy, that sentiment of ownership that is stretched to include the one whom one qualifies as the 'beloved'. Thus when one says: 'I love you and, since I love you, you should do whatever I please', it is obvious that there is no question of Love here, but of something totally different.

However, to know Love in itself one must feel it—must live it. And one cannot feel it *except in confluence with it*.

We must never lose sight of this reality: Love, being of the Divine essence, reveals an absolute power in its manifestations. The result is that one cannot *command love* any more than one can *forbid love*. We know this in our heart of hearts, whatever we may say and however we may plead for ourselves or moralize for others.

II

(I)

We have just said that *the Aim of life is to attain Love*. This principle calls for commentary.

After having said: *Seek for the attainment of Love*, St Paul continues: *And also aspire to spiritual gifts*. Then he goes on to classify them.

After due reflection it is easy to deduce that the public to whom the Apostle addressed his Epistle was prepared to receive his word. It becomes even more evident on rereading the end of the passage, where St Paul makes the following remark: *If any man think himself to be a prophet, or spiritual let him acknowledge that the things that I write unto you are the Commandments of the Lord*.

By this, we are given to understand that there were certain esoterically developed people among the Corinthians who received this Epistle: some *men 4*, ready to cross the second Threshold, and some *men 5*, or '*Prophets*', in

8. I Corinthians xiii: 4-7, Literally translated from the Slavonic text.

9. I Corinthians xiv: 1.

10. I Corinthians xiv: 2.

11. Inspired, **pntimatiko?*

12. I Corinthians xiv: 37.

the words of St Paul, who were capable of understanding it. Referring to the others, he adds: *But if any man be ignorant, let him be ignorant.*⁴

The degree of Love that enables the acquisition of *spiritual gifts*—what we have called *the acquisition of new faculties*—is an attribute of the man⁵ who has passed through the second Birth. In other words, it belongs to the newborn *Individuality* which has acquired the consciousness of the real T in its sublime androgynous manifestations. It is the fruit of Love, of the Divine Grace which is accorded to one who *works* in the Lord's field, that is, who works esoterically.

However, Love always remains the *Aim of life*, even for someone *who is ignorant*, according to the Apostle's expression, one who does not participate in this Work. Better still, Love is the *Aim of life* on the whole cosmic scale, right down to the most primitive organisms.

As far as human beings are concerned, three characteristic levels appear,

(2)

When we speak about human beings here, we envisage different cases, but always of normal people moving amongst equally normal fellow-beings and in the normal circumstances of life in our *Mixtus Orbis*. But present day life, with the enormous gap between the technical progress which is its essential characteristic, and moral progress which marks time, leads to abnormal conditions on all planes in the domain of 'A' influences, and in all the layers of society. These conditions tend to provoke pathological deformations in human beings. This delay in our evolution provokes a moral sclerosis, so that in the second half of the XXth century, at the very door of the *Cycle of the Holy Spirit*, contemporary man lives without yet having fully emerged from the domain of the Old Testament. These absurd circumstances, coming from the difference in levels mentioned above, may be an advantage to the man who is strong and wide awake: they provide a *resistance*. This obstacle offers an excellent point of application for his strength and, through it, even a possibility of rapidly acquiring the *Victory* that he desires. As for the weakling, he yields and gets lost in the crowd who follow the broad way leading to destruction.¹⁵ Our epoch offers us the spectacle of a massive application of the law pointed out in the Gospel, according to which whosoever hath, to him shall be given, but whosoever hath not, from him shall be taken away even that which he hath.¹⁶

13. Ibid.

14. Ibid., 38. After the Slavonic text.

15. Matthew vii: 13.

16. Matthew xiii: 12.

This human weakness is expressed in a characteristic manner by the attitude of men and women towards Love.

Avant-garde' philosophy reduces the problem of Love to monstrous formulas which are oversimplified in the extreme, but which pass as 'realism'. The following is a good example of this:

— Love? It is simply the contact of two epidermis!

One must admit that this is the bottom of the ladder, even lower than that of animals, for whom the 'contact of the epidermis*' is enriched by the instinct of preservation of the species and often even by true love on the level at which it arises.¹⁷

One cannot try to justify Love's profanation by slogans such as 'after all, it has always been like this.' The hold of the Absolute III is certainly great and is generally decisive. But can one liken this more or less skilful 'contact' to cases like that of Menelaus, King of Sparta? Menelaus acquitted himself notably and was known for his heroic deeds in war; he took on the traitor Paris in single combat and caused him to flee. After the fall of Troy, like a good Spartan, he rushed to the palace, sword in hand, to punish his unfaithful wife, Helen, the cause of ten years of war. Yet, when he entered her chamber and saw the profile of her beautiful breast he forgot everything, threw away his sword, and took Helen in his arms!

If Menelaus' defeat in surrendering to the current of love from the Absolute III was able to arouse the mockery of Euripides (*Andromeda*, 629), the triumph of the 'contact of two epidermis' can only give rise to pity,

So let us put aside ancient Fables and modern cynicism to examine again the typical basic stereotypes of Love.

(V)

Here, we will reintroduce the old terminology which defines the three great categories into which the whole of humanity is divided: *hylic*, *psychic* and *pneumatic*.

By *hylic*, we mean the man who lives below the first Threshold, by *psychic* we indicate psychological man, one who has crossed the first Threshold, and who has started on the *Staircase* leading to the second Threshold; by *pneumatic*, we refer to one who, having crossed the second Threshold and reached his second Birth, is making progress towards the third Threshold.

As we have seen, everything that lives, lives by Love, and aspires to Love. And by changing its appearance, Love manifests itself as a whole scale of values. It is, however, important to understand that this whole scale of values corresponds to several different levels of Consciousness. And in the case of Love as in that of Consciousness, the acquisition of the

17. Cf. '*L'Amour et la Petitesse des Usages des Bêtes et des Choses Usées*'—Serge Voronoff, Paris, Fasquelle, 1936.

higher level does not automatically exclude or annihilate the lower level that has been transcended, but *transform! it*.

One often speaks of the *sublimation of sex* which follows the passage to higher levels of Consciousness. In fact, this sublimation takes place continuously on the whole Great Ladder of the evolution of living beings. For mankind it involves three steps which correspond to the three categories, already described, into which humanity is sub-divided.

The *hylie* man is satisfied with life below the first Threshold, whether he is a 'success' or not, whether he is rich or poor, happy or unhappy. As a result his aspirations and his desires, like his loves, are also kept below the first Threshold.

The *pneumatic* man, that is, one who has crossed the second Threshold and has been born again, aspires to attain and cross the third Threshold, which will open up the Way leading to the *Pleroma*, the ineffable Love in the bosom of the Absolute.

The *psychic* (psychological) man also aspires to this state; but before it becomes possible for him to work effectively in this sense, he must be regenerated and come to the second Birth. In the first volume of our work, we studied the elements of the Way in detail and pointed out that access to what is properly called the Way demands assiduous work which may be divided into four stages. This forms a *Staircase* of four 'steps' of which the last is Love—the level that the man of the psyche must attain to appear before the second Threshold and to cross it. We indicated the traditional virtues which correspond to these four stages: *Faith — Hope — Knowledge* (Gnosis) and, lastly *hove*. The execution of this successive programme of work depends on the continuity of the *faithful's* efforts. The latter are often super-human, and must be made in the framework of one of the *four Ways*, which must correspond to the neophyte's type of psyche.

In this second volume we have also seriously studied the *fifth Way*, which offers the possibility of rapidly attaining and triumphantly crossing the second Threshold. This way is only possible to two polar beings in a united and conscious effort. This is the way of the Knight and the Lady of his Dreams.

In the previous chapters we studied different examples of evolution and of the checks that occur on its way. We will now try to delve deeper into the question and see in practical terms how the question of polar beings arises in life. We will study the possibilities and the obstacles of the fifth way—for it is important to know this—and finally examine the fate that is reserved for polar beings after their meeting here below in the *Mixtus Orbis* in which we live.

18. Greek word meaning 'fullness'. (Ed.)

III

(V)

Let us re-examine the general diagram of the Way as it appears in the first volume of our work, reproduced here as Fig. 42. We are now going to add to the interpretation already given.

The essential thing is to understand that someone who climbs the *Staircase* by following one of the four ways faces a twofold task: the acquisition of *Gnosis* in order to attain Love and, at the same time, the liquidation of the karmic burden accumulated in the previous and current films. This work must be accomplished with all the Faith and Hope one can muster if one wishes to reach a result during the course of this life or during the film or films to come. The task is great and always difficult, but the risk is relatively small as the demands are less than those made on the fifth way. The reason for this is that the latter is much more rapid than the fourth way, just as the fourth way is more rapid than the other three. The rapidity of the fifth way is the logical consequence of the fact that one covers it, so to speak, in the opposite direction. In following the first four ways the mutual recognition between polar beings only happens after the second Threshold, but in the case of the fifth way it takes place *intuitively* before the second Threshold and even before the first for one partner, or sometimes for both.

do \// si la sol fa \J/ mi re do \J/

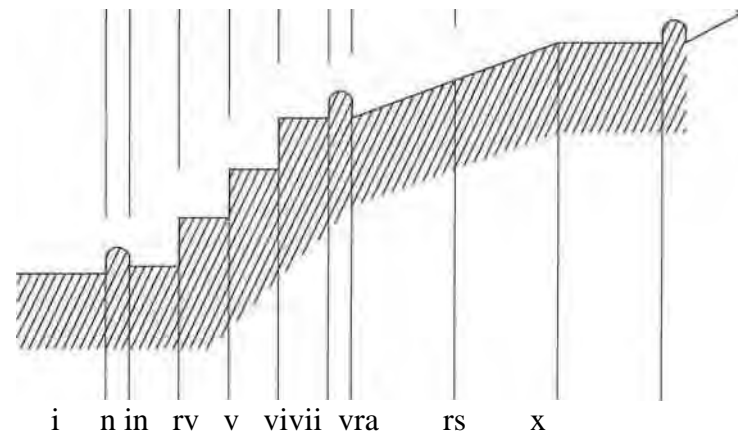

FIG. 42

This may be explained by the fact that the karmic burden never appears as an amorphous whole, but as the result of a certain number of positive and negative components, each on an appropriate plane, which when they are taken together form what is called the individual's *Karma*.

As we have just said, polar beings may recognize each other even before the first Threshold since, seen from the angle of their profound attitude towards Love, their karmic burden may be of no account or insignificant. In other words, they live with a deep aspiration towards true Love within themselves, whether or not this is recognized and formulared. They will not be capable of lying to themselves in this domain.

This inward attitude immediately places the polar beings on the fourth step of the *Staircase*, but they are then forced to quickly liquidate their karmic burden on the other planes of human consciousness. This burden may be light, medium or heavy, but it is different in each of the polar beings who form a couple.

The mutual recognition of polar beings before the second or even before the first Threshold presupposes that they have already acquired the minimum Faith and Hope that is demanded of them. Thus, already having Faith and Hope in large measure, and since they are on the step of Love, they only have to cultivate these in order to acquire *Gnosis*, and then liquidate the remainder of their *Karma* to give them access to the second Threshold.

The method that applies to them is a little special. Their case is an exception to the normal. In the picturesque language of the Tradition we say that the method consists in *emptying the bags of Karma by repelling it with Gnosis*. This is the imperative rule given to them. The reader who is committed to follow the fifth way must remember this maxim and meditate on its profound significance.

But this undertaking is not easy. Efforts and superefforts are both necessary if it is to be completed quickly enough, as it is not possible to remain indefinitely on the fourth step. As we have already indicated, the steps of the *Staircase* are made in such a way that they bear the aspirant only for a certain time, after which they collapse.¹⁹

These are the data of the problem that faces two polar beings the day they meet, when, through an indescribable inward movement, they spontaneously feel the objective and absolute feeling that together they form only one being.

This sudden revelation of the androgynous consciousness is marvellous. It in no way resembles anything that the poor human intellect can imagine, nor anything that the motor centre can imitate, although the latter tries to create something similar by usurping an abundant quantity of energy SI-12 from the sexual centre. The androgynous consciousness is established 19. Cf. Volume I, p.218.

following the inflow of the energy SOL-12 which spontaneously floods the human heart. This energy, which comes from the higher emotional centre, has an effect that is totally unknown to even the most refined human Personality, with its 987 little *I's*, as long as it is only moved by the three lower centres.

In this ideal case they are *truly betrothed*. For them, the nuptial benediction or marriage takes on the significance of a true sacrament—a *mystery* in Orthodoxy—by which *the twain shall be one flesh*, being already ONE in the consciousness of their real²⁰/. Thus they cross the second Threshold and the second Birth, that of the *Individuality*, becomes an accomplished fact.

These cases are most uncommon. Yet, it is obligatory that polar beings meet, and sometimes they do recognize each other. Yet they generally do not realize the treasure that each represents for the other, nor the marvellous vista which opens before them because of this encounter.

Even when it is unconscious, the mutual attraction of polar beings is strong because of their androgynous nature, and when they become conscious of it, it is enormous. Then, the *General Law* intervenes and immediately lays a trap for them. Wonderstruck by their Love, they insensibly let themselves get caught in this trap and always, of their own free will and with the blessings of the Absolute III, they become lovers without caring too much about the consequences of their act. For those who are caught in this pitfall, the situation creates problems which, if not insoluble, are certainly difficult to resolve.

We have said over and over again and will now repeat that polar beings are bound to meet at least once in their lives. But this encounter takes place in very different circumstances which are precisely determined by the nature and weight of their karmic load. This latter is an *old* burden with which they are born, which is applied to the present film, multiplied by that which the two partners have accumulated in their present life before their encounter. Also, from the time they meet, by falling into the trap that is laid for them by the *General Law*, the polar beings create a new common karmic burden which is then added to the preceding ones. They act in this way instead of trying, through joint conscious efforts, to progressively liquidate the old burdens until they are free at last and able to unite forever in the conditions required for the union of polar beings.

These conditions are rigorous and hard. *For them, if they really are polar beings, this is the passage for them from the free romance to their singular romance,*

20. The Greek word is *'mysUrktC*. (Ed.)

21. Matthew *xix*: 5.

The conditions vary according to cases. Generally, the desired result is attained only after a hard struggle, because of the accumulated weight of the triple karmic burden.

(2)

In the domain of the free romance the partners think seriously of nothing apart from their desire to be united, and everything is subordinated to this imperative desire that is intensified by the will of the Absolute III. So much is this so that when one or even both of them are already bound elsewhere at the time of their meeting, they overlook it. In order to calm their consciences in this classical situation, they find its justification in their so-called 'great love.'

Whether the formula is *husband-wife-lover* or *wife-husband-mistress*, both at the same time, or still more complex cases, the result is always identical: with this 'great love' they either commit themselves to the path of the wholesale lie, or else, which is even worse—they shut themselves up in a cold cynicism. Or, lastly, they break the links which unite them with their family, their partner and their children by imposing their will violently.

All these actions invariably lead to more or less rapid exhaustion of the original force of their Love. Apart from lying to others, they then begin to lie to themselves.

Love is the Divine expression of the Truth; the introduction of the lie ruins the happiness of the lovers. Their Love gives them a certain amount of credit, but this credit is short-lived. A honeymoon lasts only a month!

m

For polar beings, to fall into this trap is equivalent to a capitulation of consciousness; a shameful capitulation without any attempt to resist the *General Law*.

Even if the couple is composed of truly polar beings, if the lovers do not adhere to the supreme conditions demanded by Love, once their credit is exhausted, Love disappears.

The sequel is well-known: one finds oneself left with the broken pieces.

This is the destiny of *the free romance*, whether it is crowned by marriage or not, and even, we repeat, in the case of polar beings, if the gravity of their situation escapes them.

This is the experience that life offers us if we have the courage to see things as they are. Classic and modern literature provide us with proof of this. From the angle of the A' influences this situation is only too normal, Everything comes to an end, and one says to oneself: 'Polar beings? It is

wonderful, of course, but only for day-dreamers!' And one buries oneself in the mire.

Yet the Love of polar beings is the only reality in life. They can and should sacrifice *everything* to attain this union in the purity and dignity of the *Androgynous* state.

But we must be careful: they should *sacrifice everything which is theirs*. For if, esoterically speaking, man has the right to *make* sacrifices, he has no right to *accept* them. An agreed sacrifice abolishes *karma*; a sacrifice that is accepted multiplies it.

In the great majority of cases the paths of polar beings cross without any sign of real recognition. It may be an affair that is a little more agreeable and more durable than others, or it may even be 'unforgettable', but that is all. This is because the conscious union of polar beings occurs only with those who have already reached a certain level of spiritual culture. For the common run of men, the question does not even arise. The rule of the free romance meets all their needs: intellectual, moral and sexual.

By the way, the reader must note that we are not passing any judgment. For they also contribute their mite towards the common cause but in a different way, within the framework of the *General Law*. In this way they ensure the continuous functioning of the third cosmic octave and furnish the cadres which are necessary for the functioning of the second and, through it, of the First cosmic octave. They too will have their reward, but after aeons of pleasure, voluptuousness, and suffering ...

The following does not apply to *the just*; but those polar beings who recognize each other are generally, at the moment of their encounter, tied hand and foot by old and new *karma* that is created before their meeting and, all too often, created after it as well.

Theirs is a distressing situation. This is no longer a question of an affair, for the *Kingdom of Heaven has drawn nigh to them*.

Then, through an instantaneous awakening of consciousness, all the threads of their millennial past which lives in them, after having penetrated into the most minute cells of their skin, converge as in a focus, and from this focus are projected glittering rays of the cosmic future which is open to them, and which fades away into the shadowless light of the *Pleroma* (Fullness).

From the very moment of their encounter the responsibility that still weighs on the two polar beings is that of the prodigal son who is still hesitating before deciding to give up his wanderings and return to his father's house.

(5)

— What shall we do, then? says the Knight to himself. I looked into her eyes and my gaze was drowned in the unsuspected depths of her, and I saw *everything*. In return, her look, overflowing with tenderness, made my whole being throb and filled it with ineffable joy ...

— But how can I be sure that she is really the Lady of my Dreams? The one for whom I yearn and for whom I seek on all the paths of my Way? Will I have the strength to conquer doubt and to believe in the perfect, everlasting happiness that all my lost illusions cannot efface?

Here we return to the *Golden Book* and to the text that was previously quoted in part. This is what follows:

*Every man is born bearing within him the image of his polar being.
As he grows, this image grows within him;
It takes form and is filled with life and colour.
Man is not conscious of it. Yet it is his Alter Ego,
The Lady of his dreams, his Princess of the vision.
If quest of her he must eternally go.
In Her alone, he will find a perfect echo of himself;
Of the most intimate, inexpressible movements of his soul,
For in their union, the limit between the I and the Thou is obliterated.
Since she is his Singular, his legitimate Spouse.
And Silence will then be the depositary of the fullness of their Love.*

(*)

The polarity of two human beings is strictly determined by that of their higher centres.

In polar *Individualities* the polarity of the higher emotional centre entails and determines that of their sexual centres. However, this process is not reversible. The polarity of the sexual centres in two human beings does not determine that of their whole beings, and it is not necessarily an indication of their polarity.

The sexual centre, which is an attribute of every living being, *necessarily* involves with it only the motor centre. Thus for the human Personality, just as for the animals, the polarity of the *T* of the body is not exclusive and can be found again in a certain limited number of cases. This is found from the following formula, given that two beings of the opposite sex together possess twelve sectors for their motor centres, and that we are naturally speaking of combination in pairs:

$$\begin{array}{r} 12 \times 11 \ 1 \\ \times 2 \\ \hline = 66 \end{array}$$

The conclusion is that the *exterior* man, whose Personality is not completely developed, may in principle have in his life sixty-six women of sexual polarity, of whom sixty-five would be his so-called 'legitimate' mistresses and only one would be his *Wife*, his polar Being, the Singular Lady of his Dreams.

Sixty-five of these cases can give rise to *free romances*; only one amongst the sixty-six can be the object of the *singular romance*.

For no *singularpolarity* exists for the *T* of the body nor, of course, for that of the under-developed Personality — it is only found in the *Individuality*.

We must note that due to the instability of the underdeveloped Personality, the free romance generally begins at the call of the sexual centre. And because of this instability, once the *honeymoon* is over the free romance begins to decline.

Of course, under the dominion of the Absolute III, after the failure of the first romance, there still remain sixty-five other possibilities. To this one must add a few liaisons such as 'arranged' marriages in their countless variations, but they are no part of the free romance: they belong to the vast domain of prostitution.

This is the fictitious sentimental framework in which the lives *oiexterior* men unfurl and mark time. Since they do not feel the need for it, they cannot distinguish the 'sixty-sixth' possibility which could be their salvation.

(?)

We still have to consider the question of the criteria by which one can *objectively* recognize one's polar being or be convinced that someone who appears to be the one really is so.

It will help us in our analysis to return to the diagram of the Way (page 249) once more in order to introduce certain additional ideas.

This diagram includes four main stages separated by three Thresholds. Before the first, life comes under the dominion of the 'A' influences, but arrows from the domain of the 'B¹' influences are projected into it; these *calls* are addressed to those few who are capable of intercepting them. Generally, a 'life' that is lived without a vivifying and permanent *Aim* is subject to physical and moral exhaustion. In the metaphorical language

22. The French phrase used here, '*pkxchids salut*', combines ideas of a drowning man saved by catching hold of a plant with the Christian idea of salvation, a combination which cannot be so nicely achieved in English. (Ed.)

of the Tradition, it is a *Valley of flowers, but under each flower a serpent lies coiled*. In less poetic terms, this 'life' is defined as *Hell*.

It is possible to imagine that if Adam had not fallen, then, (instead of) the first and second Thresholds there would, in fact, only be one. In that case, the first Threshold would have filled the role now filled by the second, that of a door opening directly to *Paradise*, with view of the third Threshold, the door to the *Pleroma*.

However, *fallen* humanity is now below the first Threshold. And after crossing this the *seeker* is still forced to climb the *Staircase* before reaching the second Threshold,

We must remember that the work demanded can only be accomplished through the *conscious efforts* of the seeker, and that it must be carried out *during his life on earth*. This is *Purgatory*.

Thus, for fallen man to have access to *Paradise* it is absolutely compulsory for him to pass through *Purgatory*, and to do so *while it is day, for the night cometh, when no man can work*.²¹

(8)

The great didactical principle of *Savoir-Faire* lies in the fact that someone who wishes to *learn* must begin by acting as though he had already acquired the Knowledge. For example, one cannot learn drawing without starting to sketch, nor can one learn how to type without sitting in front of a machine and starting to type.

This is our reply to the Knight who asks: *What can I do?* It will help him to recognize his Lady objectively without any risk of making a mistake. It involves the *Baptism by Fire*.

(?)

The Baptism of Water, the baptism of repentance, is given before the first Threshold. This is the consecration in *Hope of Salvation*.

The *Baptism of Fire*, which is the ultimate proof of purification, is given before the *second Thresholding*, preceding the *second Birth*, It is the baptism of Life, the consecration of *Salvation*, although it is not final as the possibility of another fall is not yet excluded.

The *Baptism of the Spirit* is given before the *third Threshold*; it is the baptism of eternal Life, the consecration of *final Salvation* by the Holy Spirit, the Comforter. From that point on a fall will no longer be possible.

23. John bu 4

(10)

We must remember that whoever crosses the second Threshold and teaches the second Birth is liberated from the authority of the Absolute HI. They then enter the dominion of the Absolute II and so fall under the authority of the laws which rule the second cosmic octave.

According to the didactic principle that we have just described, one who aspires to reach the second Threshold and finds himself beneath it must force himself to behave always *as though he* has already crossed.

This rule must be applied to all branches of his work on the *Staircase*. But there is one which is most important in this sense.

The power of the Absolute III over the *exterior* man is exercised by means of the sexual centre in its direct and indirect manifestation. Sexual attraction and the pleasure of the act ensure the necessary reproduction, which fills in the interval between the notes FA and MI of the second cosmic octave. Now, we must remember that within this octave the reproduction of the species no longer occurs, so that the sexual act, as we know it in the third cosmic octave, is absent.

The *Baptism of Fire* has a double meaning: a moral test and an objective effect.

The two lovers, conscious of their presumably integral polarity, are called upon to straightway renounce carnal love. They must do this consciously and of a common accord, at the same time cultivating the Sacred fire of their Love, which then takes the form of *courtly love*. In this way they will tune themselves until they are in harmony with the laws which rule sexual life in the second cosmic octave. On the other hand, the Sacred fire of this Love will progressively burn away their karmic burden. In this way, says the Tradition, *the foreign faces in the film will be eliminated from the game of their own accord*.

Circumstances will change and the obstacles will be removed. Having gone through this test of Fire, the two lovers will appear before the second Threshold purified and ready to receive the *Baptism of Fire*. They will then be united forever in the permanent consciousness of their *integral and indissoluble* unity by the act of the second Birth, the birth of their *Individuality*,

For this it is necessary to withstand the test. This is hard, but the stakes are high.

If the supposedly polar beings fall, this either signifies that they were not polar, or that they were not yet ripe enough for such an exploit. For them in that case, the *Great Chance* will be turned into a commonplace experience only a little more rich in meaning and colour than those before and after it.

Perhaps, after having rejected the divine hand stretched out towards them to unite them forever in the Light, and after the passage of time, they may bitterly regret the weakness which they then took for strength of character.

This is why it is written:

... Thou art wretched, and miserable, and poor, and blind, and naked. I counsel thee to buy of me gold tried in the fire, that thou mayest be rich; and white raiment, that thou mayest be clothed, and that the shame of thy nakedness do not appear; and anoint thine eyes with eyesalve, that thou mayest see. As many as I love, I rebuke and chasten: be jealous therefore, and repent.

Behold, I stand at the door, and knock: if any man hear my voice, and open the door, I will come in to him, and will sup with him, and he with me.

To him that overcometh will I grant to sit with me in my throne, even as I also overcame, and am set down with my Father in His throne.

*He that hath an ear, let him hear what the Spirit saith unto the Churches?**

(11)

The question is, simply, to know what to *listen* to. Christ offers us *his pure Gold* against payment in our false currency which He burns in the fire. In other words:

the *ETERNAL* against the *TEMPORAL*

24. Revelation lit: 17-22.

BIBLIOGRAPHY Original
prepared 'with the collaboration of
Dr. Albert-Jean LUCAS additions with
the help of L.G.A. and D.L.

Supplementary to the Bibliography in Volume One.

Legend: St-P — published by the Monastery of Saint Panteleimon on Mount Athos.
For Russian titles, the modern orthography has been used.

ENGLISH LANGUAGE¹ and
languages other than French

I The BIBLE: OLD and
NEW TESTAMENT.

GOSPEL OF JOHN, Chap. XIV-XXI. Bodmer Papyrus, II. Bibl. bodmeriana, H suppl. With complete photographic reproduction of the manuscript, chapters I-XXI. Published by Prof. Victor Martin. Geneva, 1962.

GOSPEL OF LUKE, Chap. HI-XXIV. Bodmer Papyrus, XIV. Bibl. bodmeriana. Published by Prof. Victor Martin and Rodolphe Kasser. Geneva, 1961, fasc.

n

CONCORDANCES, DICTIONARIES, ENCYCLOPEDIAS

GESENIUS'S HEBREW AND CHALDEE LEXICON TO THE OLD TESTAMENT SCRIPTURES. Translated with additions and corrections from the author's thesaurus and other works, by Samuel Prideaux Tregelles. London, Samuel Bagster and Son, 1846.

SREZNEVSKY, I.I. Material for the Old Russian Dictionary (CPE3HEB-CKHfl, H,H., Marepaajifj ana cnoBaps flpesnepycckKoro ssuKa). 3 vols. fol. Academy of Sciences, St Petersburg, 1893, photo, reprint 1958.

MIGNE, Jacques-Paul, Abbe. *Patrologiae aairsus, sett bibliothua omnium Patrttm, doctor-um scriptorumqm uclesiasthorum. Series graeca, grectm textum una cum versions latina completem*, 161 books in 164 vols. Paris, 1839—1894.

III APOCRYPHA

BOOK OF ENOCH (The), R.H.Charles, D.Litt. with an introduction by the Rev. W. O. E. Oesterley, D. D. London, SPCK, 1960.

GOSPEL OF PEACE OF JESUS CHRIST BY THE DISCIPLE JOHN (The). The Aramaic and old Slavonic texts compared. Edmund Szekeley and Furcell Weaver. Rochford, Essex, The C. W. Daniel Co. Ltd., 1937. §

1. To aid the English reader, the original order of this bibliography has been changed. Titles in the French language have been placed in a separate section on < Some of the titles shown in the English language section of this bibliography have been added for this English edition. These are marked §. (Ed.)

IV
VARIOUS

- BENNET, J. G. *The Dramatic Universe*:
— Vol. I. *The foundation of natural philosophy*.
— Vol. II. *The foundation of moral philosophy*.
London, Hodder and Stoughton, I, 1956; II, 1961.
- BOOK OF PRAYER (MOJIHTBOCJIIOB) with the benediction of S. S. Alexis, Patriarch of Moscow and all Russia. Moscow, Patriarchate, 1956.
- CABASILAS, Nicolas. *The life in Christ*. Crestwood, N.Y., St Vladimir's Seminary Press, 1974. §
- JUNG, C. G. *Modern man in search of a soul*. London, Routledge & Kegan Paul, 1953. §
- MEYENDORFF, John. *St Gregory Palamas and Orthodox Spirituality*. Crestwood, N.Y., St Vladimir's Seminary Press, 1974. §
- ORIGEN. *On Prayer and Exhortation to martyrdom*. In *Stromata*, Clement of Alexandria, pp. 167-455. London, SCM Press, 1954. §
- SAKHAROV, Nicholas, archpriest. *The Christian faith*, (CAXAΠOБ, Hmcojiafi, FLpo-Tonepfi, XpKCTHaickfls Bepa). Paris, 1939.
- SCHWALLER DE LUBICZ, R. A. *Symbol and the Symbolic*. Vermont, Inner Traditions International, 1983. §
- SERVICES FOR HOLY WEEK (nocjieaoBamie BO cBaTyio ms&mo nacxa). Jor-danville, New York, Holy Trinity Monastery, 1949.
- SORSKY, Nil. *Life and works* QKKTUCH TBopeHHS npeno,aobnoro Onia Hamero Hans. CopcKOro). Montreal, Ed. de la Confrerie orthodoxe an Canada, 1958.
- SUARES, Carlo. *The Cypher of Genesis*, The Original Code of the Quabalah as applied to the Scriptures. London, Stuart & Watkins, 1970. §
- SYMEON THE NEW THEOLOGIAN. *Sermons* (CHMEOH HOBMfl EOro-CJIIOB, C.noBa npenoAoGHoro ...). Moscow, St-P, 1890-1892, 2 vols.
- SYMEON THE NEW THEOLOGIAN. *The Discourses*. Classics of Western Spirituality. London, SPCK; U.S., Paulist Press, 1980. §
- TEILHARD DE CHARDIN. *Hymn of the Universe*. London, Collins, 1965. §

FRENCH LANGUAGE

II CONCORDANCES,

DICTIONARIES, ENCYCLOPAEDIAS

- DICTIONNAIRE D'ARCHEOLOGIE CHRETIENNE ET DE LITURGIE, in 30 vols. Paris, Letouzey et Ane, 1907-1953.
- HEFERLE, Charles-Joseph. *Histoire des Conciles*, d'apres les documents originaux; contrinuee jusqu'en 1536 par le cardinal J. Hergenroeter. Trad, en francais sur la 2^c ed. allem. avec des notes critiques et bibliographic par Dom Leclercq, et continues jusqu'a nos jours, en 9 vol, Paris, Letouzey et Ane, 1907-1931.

III
APOCRYPHA

- EVANGILE DE LA PAIX DE JESUS-CHRIST PAR LE DISCIPLE JEAN. D'apres les anciens textes arameen et slavon. Compare et publie par Edmond Szekely, trad, franchise par le Dr Ed. Bertholet d'apres le teste anglais de Szekely et Purcell Weaver. Lausanne, Pierre Genillard, et Paris, Aryana, s.d.
- TESTAMENT DES DOUZE PATRIARCHES (Le pietisme juif dans les ...), par Robert Epal. Paris, Librairie Felix Alcan, Gall. *Etudes d'histoire et de philosophie religieuse*, publiees par la Faculte de theologie protestante de l'Universite de Strasbourg, 1930.
- TESTAMENT DES DOUZE PATRIARCHES ET LES MANUSCRITS DE QUMRAN (Les interpolations chretiennes des ...), par Marc Philonenko. Paris, Presses Universitaire de France, coll. *Cahiers de la Kevue d'histoire et de philosophie religieuses*, publics par la Faculte de theologie protestante de l'Universite de Strasbourg, 1960.

IV
VARIOUS

- ALBERTI, Angelo R. P. *Le Message des Evangiles*. Paris, Robert Laffont, 1961.
- AUGER, Pierre. *Tendances actmlles de la recherche scientifique*. Paris, UNESCO, 1961.
- BREHIER, Emile. *Les ide-es philosophiques et religieuses de Philon d'Alexandrie*. Paris, Librairie philosophique J. Vrin, 1950,
- CABASILAS, Nicolas. *La vie en Jisus-Cbrist*. Traduction par S. Brussaieux (Cheve-togne). Paris, Societe de diffusion d'editions catholiques, 1960, 2^e ed.
- CARREL, Alexis. *La Priere*. Paris, Plon, 1944.
- CHARPENTIER, Georges. *L'Ordre des Templiers*. Paris, La Colombe, 1962.
- DANIELOU, Jean. *Origene. Le genie du christianisme*. Paris, La Table Ronde, Coll. publiee sous la direction de Francois Mauriac, 1948.
- DECHANET, j. M. (Ordre Sublime des Benedictins). *La Voix du Silence*. Bruxelles, Ed. Desclee de Brouwer, 1960.
- GORCE, Maxime. *Les bases du christianisme*. Saint-Imier, P. Grossniklaus, 1953.
- JUNG, C. G. *Problemes de l'dme moderne*. Preface du docteur Roland Cahen. Trad, par Yves Le Lay. Paris, Buchet-Chastel-Correa, 1961.
- LAVELLE, Louis. *Conduite a l'e'gard d'autrui*. Paris, Albin Michel, 1957.
- MARIEL, Pierre. *Rituel des socie'te's secretes*. Paris, La Colombe, 1961.
- MARTIN, Victor. *Sur la condamnation des athe'es par Platon au X" livres des Lois*. Basel, s.d. (extrait de *Studia philosophica*, 11, 1951, pp. 103-154).
- MATHIS, Georges A, *La science des symboies*. Paris, Imp. Marcel Speath, 1961.