

# DRAWING





111 111 111  
111 111 111



**BERSERKER**

---

**BOOKS**

---



ALL DRAWING STEMS FROM ONE OR MORE OF THESE FORMS

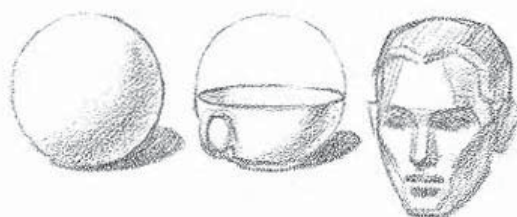

ROUND



SQUARE



CYLINDRICAL



CONICAL

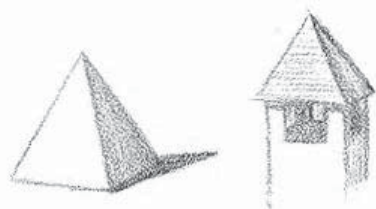

PYRAMIDAL

# The Fundamentals

Art is really having its chance. The urge to draw seems to have taken hold of many more thousands today than ever before. It has spread across the nation. While many are interested in art as a pastime or hobby, others would gladly choose it as a means of livelihood if they were convinced that their ability was sufficient to provide any real hope of success.

There will always be a certain amount of confusion about what is talent or native ability in drawing and what is knowledge of the craft. Too often, knowledge is construed as talent. On the other hand, drawing that lacks constructive knowledge is seldom successful as drawing. The truth is that we do not see the talent until the means of bringing it forth has been developed. That means is a reasonably accurate analysis and understanding of the laws of nature as they apply to man's vision.

Drawing is vision on paper. More than that, it is individual vision, tied up with individual perception, interest, observation, character, philosophy, and a host of other qualities all coming from one source. It cannot, and to be successful should not, be anything else. Drawing is very closely related to the other creative arts, all of which are outcroppings of a desire to express individual emotion, to make the other fellow conscious of our inner feelings. We want him to listen or look, and we want his appreciation of what we have to offer. Perhaps we wish to receive admiration for our particular accomplishments. Perhaps we have a message we deem worthy of others' attention. Perhaps we see in such an effort an enjoyable means of making ourselves useful, or providing ourselves with the livelihood that we must achieve in some way.

We who choose art as our medium of expression should realize that it has certain fundamentals from which we progress, just as there are fundamentals of literature, drama, or music.

Unfortunately, the fundamentals of an approach to art have not usually been so clearly defined for practical study as have those of some other creative activities. Commercial art is a comparatively new profession. However, the leaders in the field are beginning to contribute time and thought to its teaching.

Success in the creative fields is always accompanied by distinctiveness, something that singles one out as an individual and sets him apart from the crowd. One artist can be as successful as another in his use of basic knowledge, without repeating another artist's performance. If there is any way that one man in the craft can really help another, it is by increasing his knowledge of the craft itself, not in the particular qualities of the man's own work. The knowledge of our craft must be pooled, as it is in the sciences and other professions, each of us absorbing and in turn contributing. It is difficult for a man to teach without presenting his own work as an example. But I am certain that in this book, for example, there is much material which the student can apply to his own work without reference to any particular style or technique of mine.

Suppose we have two drawings before us. One appeals; the other does not. This one is good, the other bad. Why? I believe I can point out underlying reasons that are perfectly understandable. Strangely enough, the reasons are usually not found in art books or taught in classes. The response to drawing is related to the emotions and experience of the individual, and is wholly apart, so far as I know, from the teaching of art. Yet I do not believe art can go very far unless the artist has some sort of an understanding of this response. An artist can go all his life without realizing why his work does not appeal. Even successful artists may not really know why their work does appeal, though they thank heaven it does.

## THE FUNDAMENTALS

To understand why a drawing does or does not appeal, we must recognize a certain ability that is developed in every normal individual from early childhood through adult life. The term "intelligent perception" I think comes as close as any to describing this faculty. It is vision coordinated with the brain. It is a sense of rightness developed by contact. At some time or other, our brains accept certain effects or appearances as truth, and abide by these decisions. We learn to distinguish one appearance from another, in size or proportion, in color, and in texture. All the senses combine to give us intelligent perception. We have a sense of space or depth, even if we know nothing of the science of perspective. We are quickly aware of distortion or deformity, since the appearance does not coincide with what experience has taught us is normal or truthful. Form is registered in the mind, even if we know nothing of anatomy and proportion, so that we recognize a face immediately, though we could not even give a good verbal description of it. Our sense of proportion tells us that this is a child and that a midget, or this a puppy and that a small dog. Intelligent perception includes a feeling for bulk and contour. We know a swan from a goose, or a goose from a duck. This trait is as well developed in those who look at art as it is in artists. We all as individuals have subconsciously accepted certain effects of light. We know when appearances are consistent with daylight, artificial light, twilight, or bright sunlight. Such perception is part of nature.

The minute the spectator sees change of proportion, distortion, change of form, color, or texture, he realizes that something is wrong. The cleverest imitation will not fool him. The dummy in the department store window is a dummy to everyone. We know flesh from wax by the effects that have previously been registered in our minds.

We artists cannot ignore this intelligent perception and expect to secure intelligent response, or even favorable response, to our work. Make up your mind that your audience will react to

your work just as it does to life itself. Intelligent perception finds only truth convincing. *The layman does not need to know anything of art to know whether he likes your work or not.* We can use all the arguments, alibis, and defenses in the world; we can explain ourselves hoarse; but we cannot affect something so deeply imbedded in human consciousness. If what we say in paint is untrue, in color values or effect, the spectator feels it, and there is nothing we can do to convince him otherwise.

Psychological response goes still further. Every picture should have some reason for existence, some purpose behind it. If we can make the spectator feel that purpose we have succeeded further in capturing his interest. Not only is every man living among nature's effects, he is also living experiences. Life is not only what he sees but what he feels. Supplementing in our drawing an emotion that is already within him secures further response. You can feel emotion only within yourself, and any emotion that is in your work must come from you. You can be sure that most of the emotions you feel are also present in others. That is why we live through a movie or a play with the characters. To a considerable degree, we like or dislike a performance insofar as it has appealed to our individual emotions. For the same reason we like or dislike a piece of art.

When drawing is convincing to the intelligent perception of the spectator because of its rightness of form, texture, space, and lighting, and at the same time appeals to his emotions, the artist can depend upon a favorable response.

Drawing should not be taught by teaching specialized or individual techniques. What should be taught is the way to get the form, the contours, and the values, regardless of mannerisms. How Jim Jones handles a pencil has little to do with your main problem. How he handles light on form and contours is what to look for, in case he interests you. However, if Jim Jones is good, you can be quite certain he goes for his information to the one best source — life itself. He has

## THE FUNDAMENTALS

probably employed a model or used a camera to secure intelligent information. He keeps faking to a minimum, using his imagination only when he has no other way of getting a result.

There are certain basic elements of good drawing without which no drawing can really be successful. I believe these elements can be taught. So far, I have been unable to find a textbook of drawing which defines the relationship of proportion and perspective to the study of light and shadow. Since these elements are so thoroughly interdependent, this book, which presents them that way, should meet a real need.

For those who have an understanding of nature's laws, plus vision, the greatest teacher is nature itself. If the artist has the technique of depicting the construction and contours of an object set in space, plus the knowledge of how light operates on the forms we consider basic, he has acquired the springboard to his own individual expression, which, after all, is of greater value than anything else.

Suppose we ask ourselves what a good drawing is? Let us think first of the qualities that make up a good drawing; these point out the departments of our craft. Anything we draw is dimensional. It has height, breadth, and thickness. There is a ratio between the three dimensions, which we call proportion. Then all the parts within the subject have ratios to one another, and if these are correct they add up to make the over-all dimensions correct. A drawing cannot be good if it is not in proportion, so let us call *proportion* the number one element.

Since the proportions exist in the thing we wish to draw even before we have drawn it, let us consider how we shall place it within the boundaries of our paper surface. Let us think of the paper as representing open space, within which we wish to place the subject. We want it to settle nicely within the area in which it is most pleasing and at the same time most convincing. We look carefully at the subject to select a viewpoint. We may cut a finder—a rectangular opening in a card that is in propor-

tion to our drawing area—to see just where the subject should go. How big or small should it be, how close or far away, and where? Let us call this element *placement*.

When a viewpoint has been selected and a placement decided upon, we start to draw. The third element pops up. We cannot draw an object without *perspective*. Since perspective is the first main problem that arises, it is the first thing the artist should learn. An understanding of it should precede or be a part of every art-school training. No drawing is real drawing unless it is related to an eye level or horizon, with the relationship understood by the artist. The subject of perspective cannot be covered completely in this book, but I shall attempt to give the stock-in-trade knowledge of it that I believe is indispensable. I suggest, however, that you get other books, and, while you are learning, learn as much about it as possible, since it is one of the most important elements of successful drawing.

Suppose we understand the perspective and get it correct. What now? In order to set up convincing form in the effect of light, halftone, and shadow, we must separate the three into *planes*. Through the effect of light on planes we arrive at the solid appearance of the form. We look first for areas or planes of full light, then, as the form turns away from the light, we find the halftone areas or planes. Beyond the halftone planes we find the areas that are in shadow, the shadow planes. Within the shadow we find reflected light, which, though a part of the shadow, still defines form.

After defining the planes, we come to another element of good drawing, which we may call *pattern*. When we deal with values, we become involved in the tonal arrangement of a drawing. Pattern is another aspect of composition. Placement relates to composition in terms of line; pattern relates to it in terms of tonal areas.

Here is where creativeness gets its first chance. We can arrange the patterns of a subject, not simply accept all patterns as the camera does. Nature's patterns may be good or bad in our

## THE FUNDAMENTALS

opinion and within our particular space limits. Every drawing is an artist's problem in spacing and arrangement of the patterns of tone.

Composition is an abstract element. Only a little of composition can be taught. There are books on the subject worthy of hard study. Add some to your library. However, composition seems to be more or less instinctive. Most of us would rather make our own arrangements than be told how to make them.

The best way to arrive at pattern or composition is to make small sketches, which we call thumbnail sketches. Make them up of three or four tones, until you get the feel of the subject. These may well precede any actual drawing. Drawing is essentially design, and design is drawing. One will always be the outgrowth of the other.

Now, if you have not already noticed it, we have listed five elements of good drawing, all starting with the letter P. These are: proportion, placement, perspective, planes, and pattern. Let us call them the five P's.

But these are not the only considerations of good drawing. A while back we were considering the emotional qualities which every good drawing should have. If the subject is inanimate, the emotional qualities will lie in the way it is presented. If it is a landscape, it may be the mood of the day, or the freshness and charm of handling. In a still life it may be the appeal of the subject matter, the beauty of the objects themselves. In a figure subject, the emotion may be revealed in the action or expression of the figures, or in the story they tell.

Before beginning to draw, close your eyes and try to see the subject. Think of what would be happening. Think of the basic idea or purpose of the effort. All this may be called the *conception* of the subject. Again we need to make thumbnail sketches, even scribbles, until our subject begins to take shape.

Remembering that sense of rightness which we may expect in those who will look at or judge our efforts, we now need information in order to

do the thing convincingly. We have an idea, we have made sketches, and we must now proceed with our drawing. The next important element is *construction*. Now we must collect photographs, make sketches and studies, hunt up clippings, go to any available source for correct information. If we can afford it, we get a model for photographs or studies.

There is another element so closely related to construction that it must be considered at the same time, since we cannot achieve the one without the other. This is *contour*. Construction is concerned with the bulk or the mass from the inside out. Contour is the outer edge of the mass in space. Construction is based on viewpoint and perspective. The appearance of an object may be different from every angle. Therefore we must establish an eye level to which we relate all construction and contour. No subject can be drawn correctly to more than one eye level. This is because it is impossible to look at any object from two positions at the same time. For this reason, the information we have must be adjusted to fit the problem. Two clippings or two photographs of the same subject will seldom have the same eye level, or — and this is vitally important — the same source or kind of light. The ideal information, of course, is secured by having all parts of the subject before you at once, in the same lighting, from one viewpoint of eye or camera. Beginners especially should work this way. That is why still life, art-school poses, and outdoor scenes are the best subjects from which to learn to see and to draw. But we still need the fundamental information on how to draw them. The student who goes to an art class knowing something of proportion and perspective and how to achieve them will pass his fellow students by leaps and bounds, and when he leaves school his work will gain acceptance much faster than theirs will.

Without a knowledge of perspective and the lighting of the basic forms, or some idea of measuring and proportion, the artist becomes a slave to photostats, projectors, or any other



Think of your paper as representing open space, not as a two-dimensional surface, but as if its edges were the boundaries of an open window. You look at all of life and nature through this paper window.



Attempt either to set forms into this space that exists before you or to give a feeling of actuality to forms which you create from a knowledge of the laws of nature. We study nature for effects and set them down.

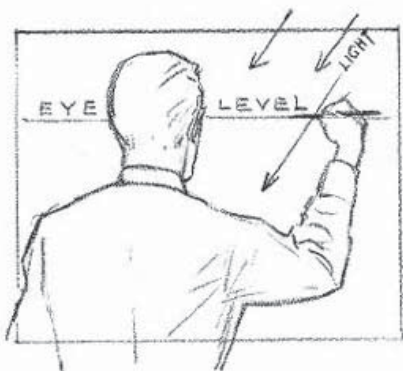

This involves dimension, contour, viewpoint (meaning perspective), and lighting. Only through light, which produces all tone, color, and appearance, can we produce a true image of life.

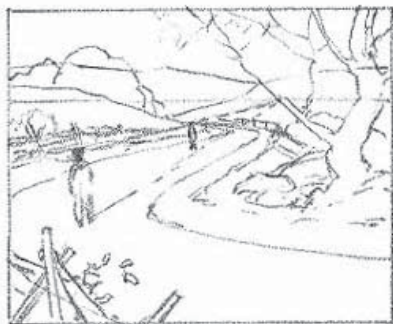

Really to draw, we cannot think only of any single aspect of drawing, such as contour, without the other essentials, but must seek to unify all aspects into a complete and organized whole.





## THUMBNAIL ROUGHS



The habit of setting down your mental conception of a subject in miniature roughs can play a most important part in your development as an artist. The best way is to shut your eyes

and try to visualize what is taking place, as it would be in life. You have no detail to go by, so just suggest the material. Think of some kind of light. It will come.

## THE FUNDAMENTALS

mechanical means that will substitute for the knowledge he lacks. If he traces or projects photographs instead of drawing his subject, the result will show up in his work. Such an artist will seldom reach the front rank, unless his work has other qualities that somehow make it better than the work of other photograph copyists. If a drawing is to be individual and dynamic, the artist must use the camera only to provide something to draw from, as he would draw from a model. The camera does not see in the same perspective or proportion as do the two human eyes. Being a slave to the camera usually leaves the stamp of the photographic on a man's work. If you use photographs, square them off and draw, but always draw, don't trace.

I once knew of an artist who was asked to do a subject away from home, when all his copying paraphernalia was back in his studio. For once he was forced to draw. He went through torture before he had finished. The drawing never was good. He had never realized how much he depended upon his crutches. He went back home and started drawing in earnest. The slave to the camera never really knows how bad he really is or what his work lacks, until he can see the difference of real drawing on his own drawing board. The way he works is a man's own business, but it should be pounded into the novice that his greatest hope lies in his own good free-hand drawing.

When, by dint of hard effort, we succeed in getting construction and contour, there is something else, closely related to both, which we must be constantly thinking of. That is *character*. Character is the thing that distinguishes one object or person from any other. Usage brings character to an object; experience brings it to man. Character is always a singularity. Pictorially, character is a form that belongs to this subject and no other. It is form in a particular place, under particular lighting conditions, from a particular viewpoint, with particular effect. It is something immediate, caught as if at a glance — the set of the features at that moment, the look

of the eyes, the mouth, the planes of the face in that lighting, all having to do with circumstances then and there. Here is where the camera can catch valuable information. But before the camera clicks, the emotion and appearances all must be present—felt within the artist and transposed to the model, or existing in the model and recognized and caught by the artist. Then, through the whole effort, the artist feels the thing he wants to express, the thing that makes him want to say something with his pencil or brush. Such feeling has a way of getting into the technical expression, the handling of the medium. Sometimes the artist is not even conscious of it, but it still contributes to the success of the work, simply because the feeling is also conveyed to the spectator.

The study of clothing and drapery does much to add character, the hands, the shoes. The gesture, in correct spacing and drawing, does its part. And yet gesture is really construction and contour, planes and values. A portrait sketch is about one hundred per cent character, which means accurate spacing of features, planes, and contour. Character cannot be achieved without all the elements of good drawing. *Real presentation of character lifts the artist to the top of his profession.*

Finally we have the most important element of all, which is *consistency*. Consistency embraces much. Consistency is really truth, as recognized by that intelligent perception we all have, artist and layman alike. Consistency, technically, means that lighting, proportion, perspective are so handled that all elements belong to one particular subject and no other. There is a consistency of purpose, when all things press home that purpose. There is a technical consistency of treatment, so that all parts of the subject seem to be done by the same hand, in the same individual way. I do not mean that all surfaces should be handled as if made of the same material, or with the same kind of strokes, but that all parts have a unity of approach and vision which organizes the subject into a single



## THE FIVE P'S

1

**PROPORTION**  
The three dimensions

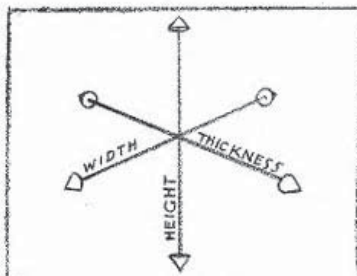

2

**PLACEMENT**  
A position in space

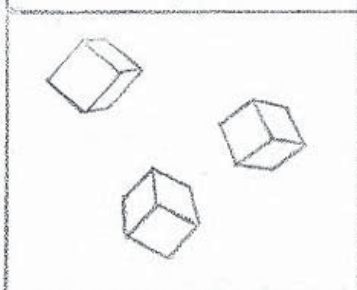

3

**PERSPECTIVE**  
Relationship of viewpoint to subject

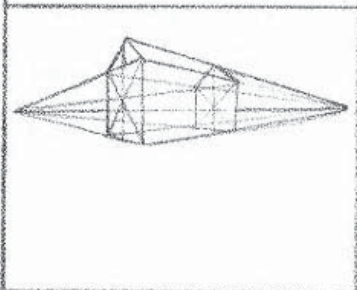

4

**PLANES**  
Surface appearance as defined by light and shadow

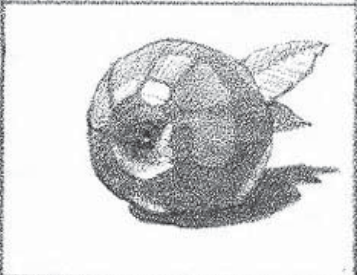

5

**PATTERN**  
The deliberate arrangement of the tones of the subject



## THE FIVE C'S



### CONCEPTION

A rough indication of an idea

1

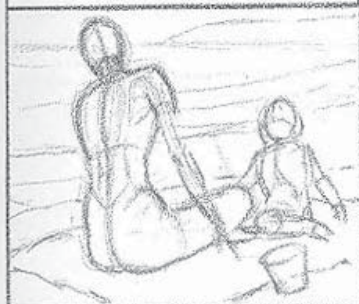

### CONSTRUCTION

An attempt to establish the forms from life or from basic knowledge

2



### CONTOUR

The limits of forms in space, according to viewpoint

3



### CHARACTER

The specific qualities of individual units of your subject in light

4



### CONSISTENCY

All the essentials of construction, lighting, and pattern, organized as a unit

5

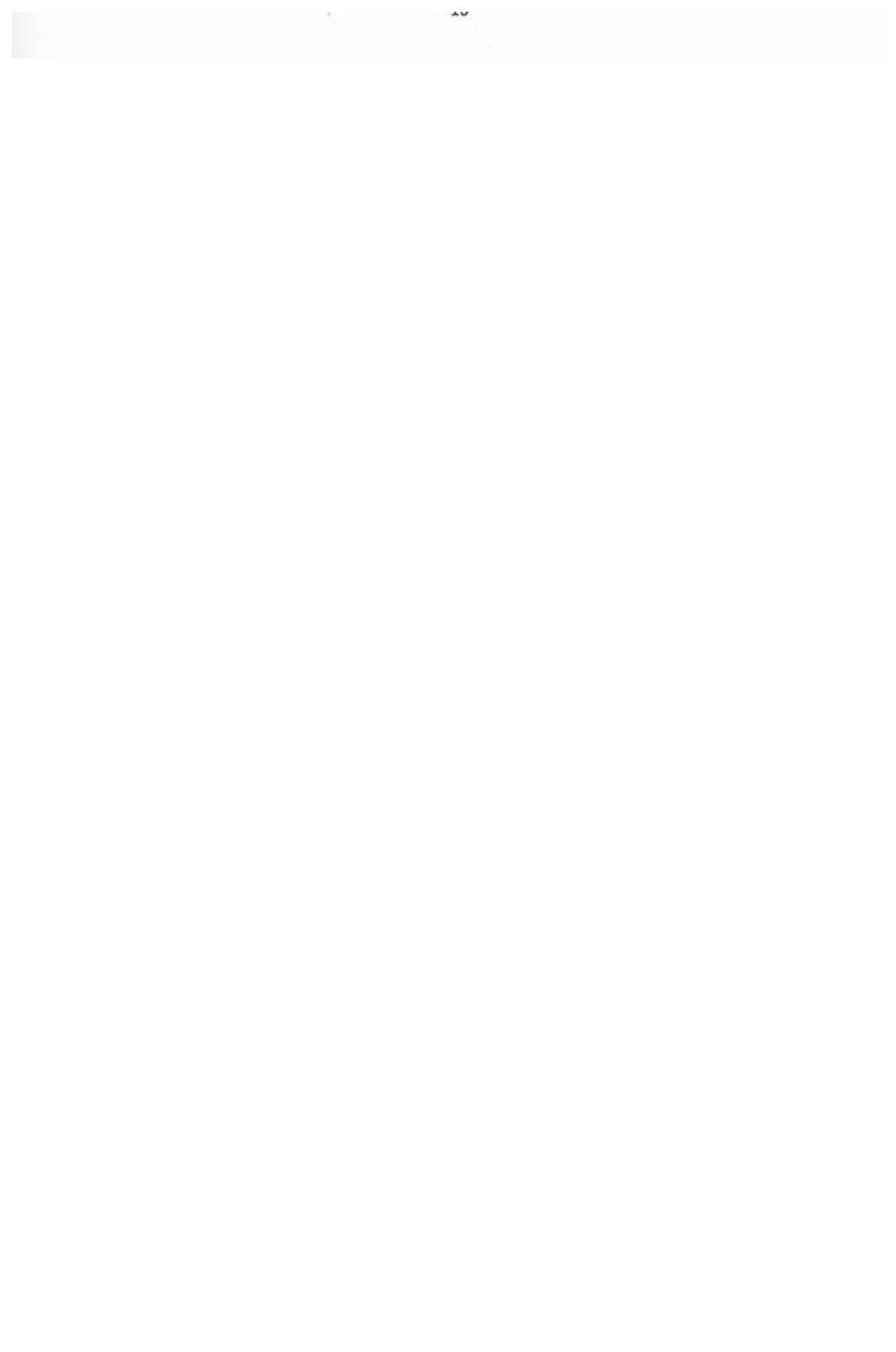



## THE FUNDAMENTALS

expression. Let us see the artist himself coming through his work — his feeling about it, his joy in doing it. If this is achieved, the work will never be considered imitation, for it is not an imitation. When we think of consistency, then, let us think of the unity of all the elements brought together into one whole effort. The artist won't go wrong when he can see the big truths, or what he feels to be the big truths. If he looks for the big planes, the big lights and shadows, the big values and relationships, he will do a better job. One can easily get lost in a lot of little truths without seeing the big ones. The leaf compared to the bulk and mass of the tree itself is the difference between big truths and little ones, or between big vision and eyesight.

Now let us take stock of all these elements. You may have realized that we have now added five more, all beginning with C this time. They are conception, construction, contour, character, and consistency. So we have five P's and five C's — which should help you remember them. They are illustrated on pages 18 and 19.

Repeat the names of these elements over and over in your mind until you memorize them, for they will always be the guiding lights to successful drawing. We will not succeed with them all every time, nor will every single drawing be successful, but we can look at each drawing to see in how many of these elements the work qualifies. A drawing fails because of failure in one or more of the elements; analyzing it to find the source of failure points to our errors and difficulties. Concentrating on these elements keeps us on our toes, and little by little our work improves. In our intelligent perception we have a guide to visual right and wrong as good as our sense of moral right or wrong — perhaps better. We can be taken in much more easily through our ears than through our eyes. Have the courage to believe in what you see, as you see it, and to draw it that way, even if Jim Jones sees things another way. That is what makes each of you an artist. Art is certainly a mat-

ter of equal rights; nobody has a corner on it.

In organizing the material in the book, I have placed perspective first, because I believe it is easier to learn to handle line alone before getting into the complications of planes and tones, which are meaningless without dimension and perspective. In art schools, a subject is usually set up before us, and we simply have to draw what is there. But when we are out on our own, the subject is usually not there. It is not too hard to draw a cube that is set up before us. But what we must learn is to draw an imaginary cube at any eye level, to fit into any set of circumstances. The importance of this will be understood when you know that almost any object may be drawn in perspective from a cube or block, since that represents the over-all three dimensions of anything we draw. Even a sphere fits compactly into the cube. The cube or block may be thought of as the box that will fit around anything in the universe. Knowing the proper way to draw the block leads us right in at the front door of perspective. The building is the outside of the box. The interior is the inside, and we must know how to give it dimension and measurement, when those are needed. They usually are needed, if only to keep the figures on the floor, in proportion to the walls, doors, and furnishings. When buildings and figures occur in the same subject, we need dimension and scale.

It is simple to place a figure at any given spot on the floor or ground plane, in correct proportion to other figures, but over and over even high-ranking artists fail to achieve this, and the result is a bad job, as even John Doe can see. When different eye levels appear in a drawing, the artist has probably failed to reconcile the inconsistencies in the various pieces of copy from which he is working. He may not even be aware of the inconsistency, but the people who see his work will have an uneasy feeling that something is wrong, though they do not know what. When all is right the public really clucks over a thing. When it is wrong they are usually just silent.

## EVERY DRAWING HAS A HORIZON

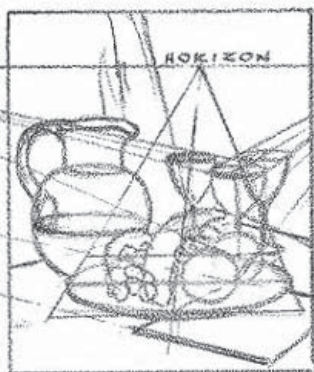
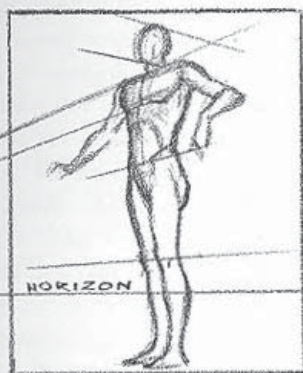

Anything we draw, no matter what it is, is affected by the eye level and viewpoint from which we draw it. The eye level is the horizon of the picture. It may be above or below the picture plane or may cross it at any point. We must

know how to relate all forms and their contours to an eye level. In a photograph, everything is related to the camera lens in the same way, but the artist cannot depend upon the camera. He must know perspective.

## THE FUNDAMENTALS

The successful artist must keep them clucking.

I personally believe an artist can develop a sound individuality in his work only if he knows how perspective, light, and shadow truly affect the basic forms. Then it is not too difficult to perceive the relationship of all other forms to the basic ones. The artist must know the difference in the quality of diffused light and direct light and not mix the two within the same subject. So many artists get involved in tricky techniques, which are well and good if all else is in order but can cover up just so many sins and no more. Technique alone will not satisfy that intelligent perception of John Doe's, and if we want him to write to the magazines and say that he thinks our work is good, we can't depend on technique. Form is form, and in any particular lighting every plane in a picture must have its relative value, or the whole fails to convince. The wrong value means that the angle of the plane is not what it should be, and therefore the form is incorrect whether the contours are right or not.

Let us consider for a moment what made the great artists great. In almost every case they were masters of form, which means that they had to be masters of light on form. Light and form were no different then. The artist of the past had no clippings or cameras. They had to find out from life. By observation and study they learned truths which are still staring us in the face, but which we do not know or see, because we think an F.2 lens is going to take the whole heavy business off our shoulders. We actually have twenty times the opportunity to produce masterpieces that they had. We are not bothered with making materials, or sketches, or studies from life. The truth is we are just not bothered. We are neither craftsmen nor contributors. The only legitimate excuse the artist of today has — and it's worn thin — is lack of time. But where is lack of time taking us?

To know is the surest way in the world to save time. An error in perspective can use up more time than any artist has. Bad planes and incor-

rect modeling can ruin a man's chances so fast that the time saved may be spent pounding sidewalks. When a painting or drawing stands as a great thing down through the years, with generation after generation of new spectators, I believe there is a positive reason, which means more than the name signed on the canvas. Those artists were great because they came so close to the truth of vision, because they had great understanding of nature and her ways. To stand before a Franz Hals is an experience. It is life, brought down through the years to you. The woman in the white cap and frilled collar is a living character, and we see her before us just as Hals saw her. She almost speaks. Through his vision and mastery we are living in a time before we were born. There is nothing we do not comprehend. No explanations are needed. We need know nothing of art to feel and appreciate the greatness of the work. I cannot believe that Franz Hals will ever be outmoded. His works will be masterpieces as long as there are people to see them and the paint and canvas hold together.

No man can successfully draw or paint a head until he can render the surface of a sphere in light. If he cannot feel the relationship of the rounded forms of the head to the sphere or egg, the rendering will not have solidity. In the material in this book we apply the light on basic forms to the figure and the head. For a little fun, we even give solidity to comic drawings. It is possible to make even a comic seem to exist in light and shadow, with nothing but imagination to work from.

The time that you spend practicing on essentials will not be wasted. Suppose you were asked to draw a series of columns, spaced 10 feet apart, set on cubes measuring 5 feet each way, with some figures standing at the second and fifth columns, and the bases of eight columns going back in the distance. This is very simple if you know perspective. Which would take the most time, to hunt up such a building, take photographs, develop films, make prints, and set the

## EVERY DRAWING IS A PROBLEM OF DIMENSIONS

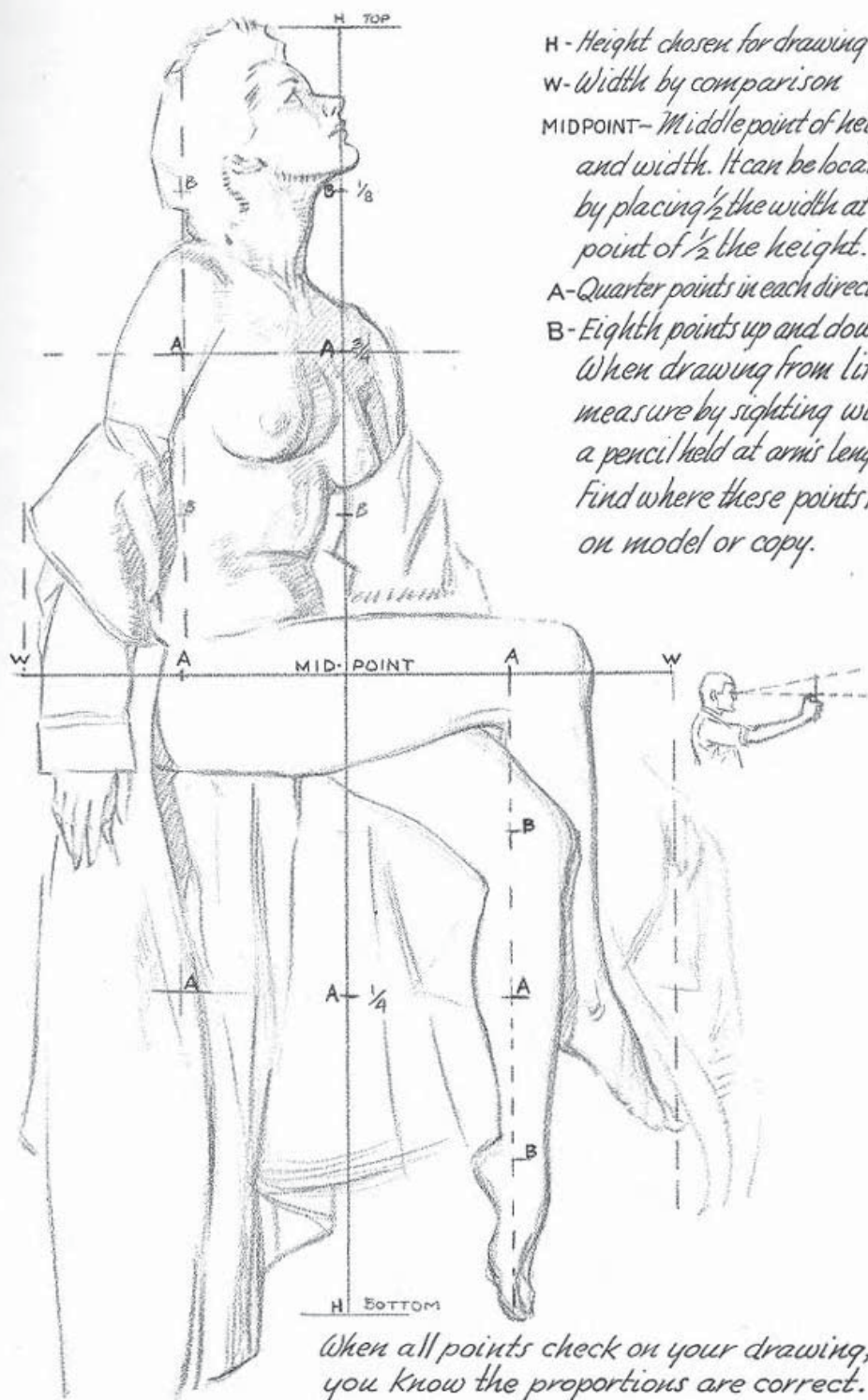

H - Height chosen for drawing  
W - Width by comparison  
MIDPOINT - Middle point of height and width. It can be located by placing  $\frac{1}{2}$  the width at the point of  $\frac{1}{2}$  the height.  
A - Quarter points in each direction  
B - Eighth points up and down.  
When drawing from life, measure by sighting with a pencil held at arm's length. Find where these points fall on model or copy.

When all points check on your drawing, you know the proportions are correct.

*you know the proportions are correct.*

# SIDE-OF-THE-LEAD STROKES

*Use wrist for movement, not fingers!*

*light to dark*

*don't do this*

*light tone*

*tones*

*black*

*scribble tone*

*arm strokes*

*flat tone (arm strokes)*

*accented line (press)*

*wrist strokes*

*variegated tones*



## THE FUNDAMENTALS

assembly on a projector, or just to sit down and draw it? Almost daily, lack of knowledge of simple perspective can hack away at an artist's time. The amount of motion and time which you save by knowing how to solve your problems far exceeds any saving by the projector. The more you lean on your crutches, the more your strength ebbs, and soon you cannot get along without them. No artist can ever save time by not being able to do for himself the things his camera does for him. Never let that camera get beyond being a source of information. No lens in the world is a real draftsman; that skill belongs to the artist himself.

Line drawing and painting actually simplify and stress the basic relationship of the forms. The leg or torso is actually better as a cylindrical shape, with just enough anatomy to make it convincing, than as a photographic replica of every hump and bump of the muscles on it. We must learn to subordinate much of what the lens sees. We are really concerned more with light and shadow and bulk or mass than with what the camera can give us. Photographs with several light sources, which is the way most commercial photographs are made, defy every principle of good drawing. There is no authentic form in them; it has been broken up in meaningless light and shadow; and good drawing is essentially a statement of form.

I should like the young artist, as he starts working on the material in this book, to consider, before discounting what nature has to offer, what it would be like to be blind. Think what light and form really mean to us. Things that seem so commonplace are really things of beauty. Strangely enough, when they are well drawn they seem even more beautiful, for they have been set apart from the endless multiplicity of nature. A good drawing of a thing can be more interesting than the thing itself, for it concentrates attention on aspects which the layman probably would not see. Flowers in a vase are beautiful, but seen with the painter's vision they can be even more beautiful. A head is just an-

other person to the layman until it is beautifully drawn or painted.

We have no lack of material. Plus all the things in nature, we have all the man-made things that have become a part of modern life. We have thousands and thousands of effects, so many worth setting down, so many worthy of study. The artists of today will all have had their yesterday before too long. Some of you students will be in their places. You will be living in the same sunlight they lived in, with all of nature now yours instead of theirs. You will live among new names and faces but with the same kinds of people doing and thinking much the same things. To appeal to those people you will have to give them credit for intelligence, for awareness of life and nature. Crudity and distortion will not be any more appreciated fifty years hence than they are now. If you can achieve truth, no man can discredit you.

I cannot believe that art devoid of fundamentals, structural knowledge, and some sort of beauty, can endure. Since we as human beings cannot do otherwise than live with nature and her laws, I wonder if art can do otherwise. I believe that the artists of the future will know much more about nature than we do, and that the knowledge will lead to greater art. Increasing understanding has led to the principles we use now. Let us attack the material before us with the feeling that additional knowledge can bring only added power.

There is little about pencil technique that can be taught. But it may be a help to the student to understand some of the things his pencil will do. I have always favored a soft pencil and do not like to use different grades or hardnesses within the same drawing. I like a large lead, sharpened to a long point, capable of standing considerable pressure. The point may be laid nearly flat on the paper by holding the pencil under the hand and using the arm and wrist rather than the fingers for the stroke. The tip of the point may be used for lines, such as out-





*Good drawing begins with a search for simple basic forms.*

*With the basic forms established, we can then build on the surface forms.*

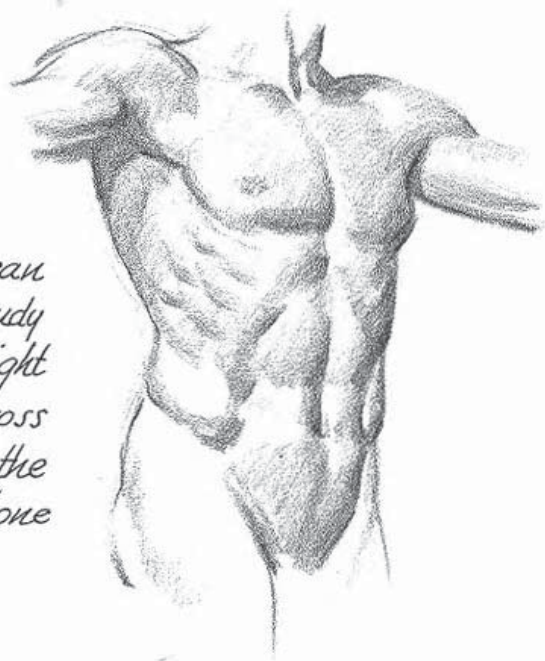

*Then, since only light can define form, we must study carefully what the light does as it travels across the surfaces, noting the areas of light, halftone and shadow.*

*As the form turns away from the light it produces halftone and shadow. The lightness or darkness of the halftone is the result of the angle of the plane in relation to the direction of the light. Shadows occur only when the light cannot reach the plane.*

## THE FUNDAMENTALS

lines or contours, and the flat side for shading or grays. For the effect, see page 24. The drawings in this book were done with the Eagle Pencil Company's Prismacolor Black 395 to obtain good blacks for reproduction, since all dots on a line cut must be black.

Different papers give different effects. The paper used for these drawings was Coquille Board, a grainy paper meant for this kind of reproduction.

There are also carbon pencils, crayons, charcoal, anything you want. Drawing is drawing in any medium; select the one you like best. You can buy large pads of layout bond paper, which is not too thin and transparent. Get a box of kneaded rubber, or the plastic type of eraser. The pencils I have used do not erase readily, so for a while it might be best to stick to the regular graphite or lead pencils.

My only suggestion as to the technical use of the pencil is to try to avoid scratchy, small, and thin-lined strokes for your grays and blacks. They persist in looking amateurish and fussy or furry instead of suggesting an area of tone.

To do the perspective problems, you will need a fairly wide drawing board, a T square, and a triangle. You need not get a complete set of drawing instruments unless you intend to ink in your drawings. A pair of dividers and a pencil

compass will suffice. Any ruler will do when working to scale.

The problems of lighting on form can best be solved by working from life. If you must work at night, any artificial light on your subject will give you the effect you want. However, keep the light simple, using one source. Draw anything you wish for practice — some old shoes, some pottery, some vegetables, fruits, pots and pans, bottles, bric-a-brac, toys, books, dolls, anything at all. It is all form with light on it, and all present interesting problems.

To keep your practice from getting too boring, perhaps one evening at perspective can be followed by an evening of drawing from life or copying some of the drawings in this book. Try once in a while to draw real people — some member of your family will pose for you. Spend an evening with comics — they are fun to do. There is plenty of material all about you. Do not try to make masterpieces, just sincere studies. Save your work for later comparison.

To learn to draw is to draw and draw and draw.

*Note:* If you wish to copy any of the drawings shown here, for practice, you may do so. However, since the book is copyrighted, no part of it may be copied for reproduction or sale.



*There is hidden perspective  
in everything that we will  
ever draw, large or small.*

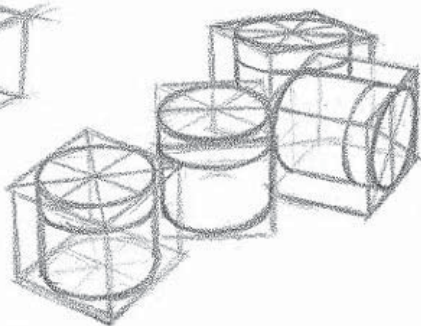
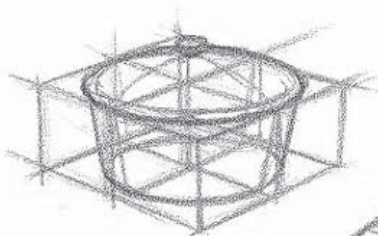

# Perspective the Artist Should Know

The pages of this book that are devoted to perspective should not be considered a side issue by anyone who is seriously interested in drawing. It may be hard to see the connection between planes and vanishing points and the kind of drawing you wish to do. But there is a definite connection, for anything you draw is related to a horizon and vanishing points, even though it is not always necessary to draw them. If you intend to make a living at drawing, by all means learn these things now, and do not have them bothering you and your work for the rest of your life. Even if you are drawing only as a hobby, the knowledge will enable you to do much better work. Remember that anything can be drawn within the cube or block. Even though you don't draw the actual block, you must feel the perspective relationship of the figure or object as it would be within a block.

Experiment with real drawing by drawing a thing first with blocks. See how much more real construction you get into it. You will later see the tie-up between lighting and perspective, which are much more closely related than the average artist realizes.

Art students are as prone to underestimate the value of the study of perspective as music stu-

dents are to underestimate the need of practicing scales. Both foundations are necessary. In drawing, the eye is as important as is the ear in music. Musicians who play only by ear are never as accomplished as those who can also read music. Similarly, an artist can draw by eye alone, but he will never draw as well as one who knows fundamental perspective. The handicap is unnecessary in either case. Since the knowledge is available, why try to struggle along without it? The difficulties of not knowing are always much greater than the effort of learning.

The problems in this section are not child's play. They require considerable application. But the time and effort required to digest this material thoroughly will pay dividends throughout your whole career. Although many of the important principles are presented here, space obviously does not permit complete coverage in a book of this kind, and I cannot possibly answer personal letters on problems of perspective. I urge you, therefore, to supplement this book with some good texts on perspective. A simple one to understand is *Perspective Made Easy* by Ernest Norling; you will find others in bookstores and art stores. No subject is more worthy of the artist's study.

## THE SQUARE AND THE CUBE

Let us start with the beginning of all good drawing, proportion and dimension. The square with its equal dimensions is extremely important, as the following pages show. From the square we

can construct nearly all other forms in perspective. The square is a basic means of measurement. We must first learn to divide the square.

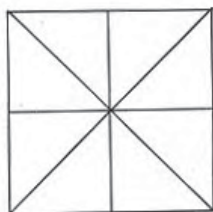
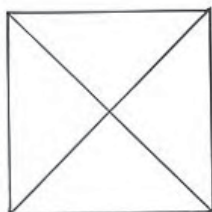

*We observe that two diagonals will locate the middle point of the square. Then a horizontal and a perpendicular line at the same point of crossing will divide a square (or any rectangle) into four equal parts. From this, many things will develop. First we construct the cube from the square.*

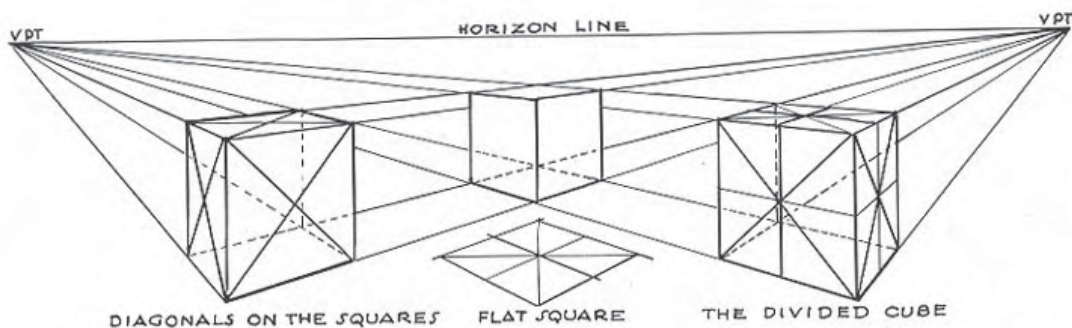

*Since all objects will fit into a box, we must know how to construct the cube or block in perspective. Knowing the overall dimensions of any object, we construct a box which would fit around it. Then we build the object within it. Even round objects fit the cube or block. To draw the cube, we must establish a horizon (or eye level) and two vanishing points. All sides of the cubes recede toward these vanishing points.*

The drawing above shows the square laid flat on the ground. All ground plans begin with this. We can now build the cube on the square. The sides of the cube are divided like the squares at the top of the page, but now are shown in per-

spective. In the drawing above there is some distortion because the vanishing points had to be placed a little too close in order to show them both on the page. Try drawing some cubes correctly.

## THE CIRCLE AND THE CYLINDER

By means of the divided square and the cube, we can draw the circle and the cylinder. We use a compass to draw the circle. The circle in perspective becomes an ellipse. We can draw the

ellipse quite accurately by using the divided square drawn in perspective. This is valuable in drawing all round or cylindrical forms.

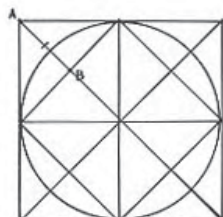
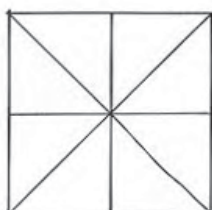

*By adding diagonals to the quarters of the square, we construct another square whose corners touch the middle of the four sides. By placing a point halfway between A and B, we can judge about where the arc of the circle cuts across the diagonals, which helps us to draw the ellipse.*

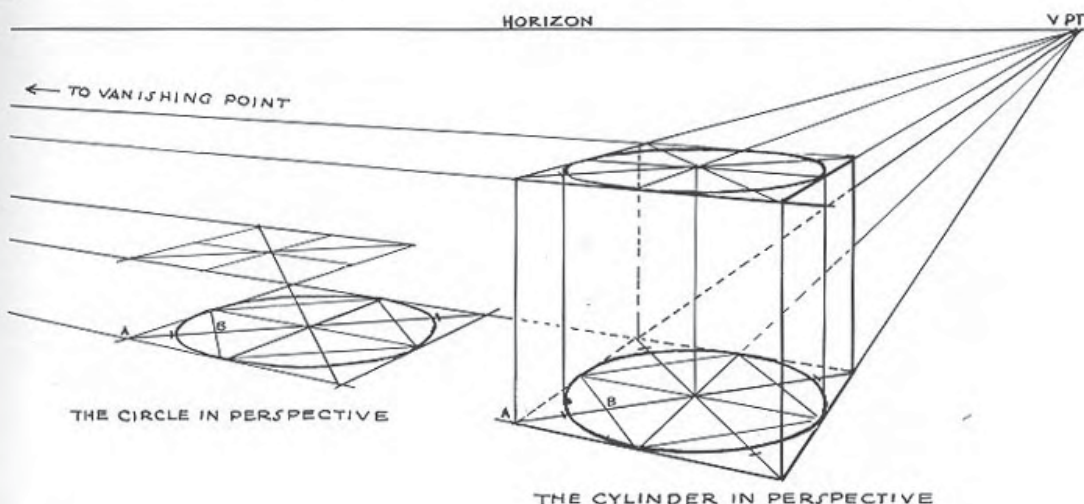

To draw a circle in perspective, we first lay out a divided square. We draw the arcs around the four sides, making the arcs cut just short of the halfway points between A and B. Now by drawing ellipses on the top and bottom sides of a

cube or block, we construct a cylinder in perspective. The vanishing points for a small object should be spaced wide apart. For large objects, they can be spaced closer.



## THE CIRCLE AND THE CONE

The cone is built on the circle in perspective, and the circle in perspective is of course constructed within the square. Many objects are

built with the cone as the basic form, such as the wine glass, horn, etc.

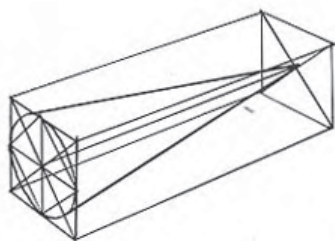
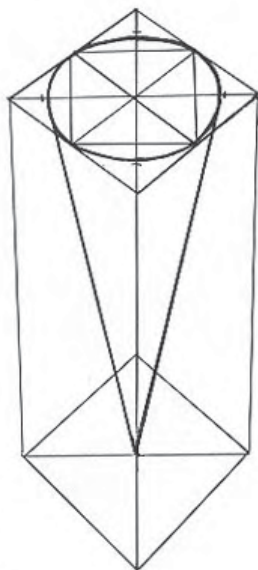
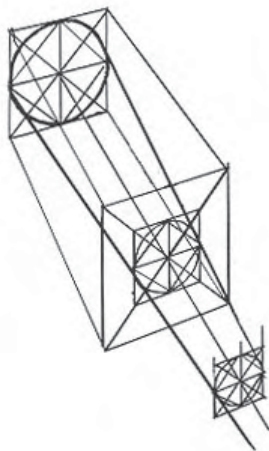
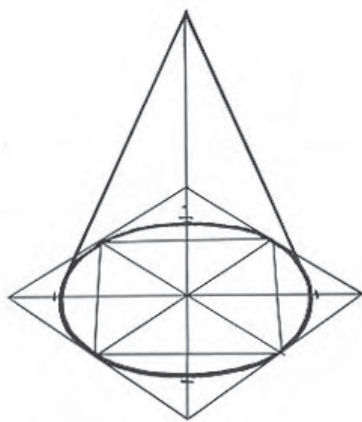
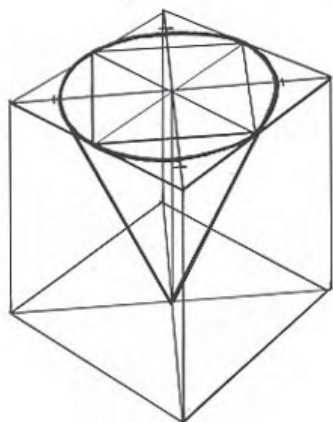

*Remember that both vanishing points must be located on the same truly level horizon.*

Later you will draw freehand, but at first, when you are learning the basic principles of drawing, you will always need a straight-edge to get cor-

rect perspective. So get a T square and a triangle and make all the lines true and straight. Careless drawing is the sure sign of the amateur.





045.jpg

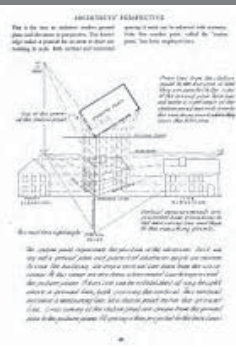

046.jpg



047.jpg

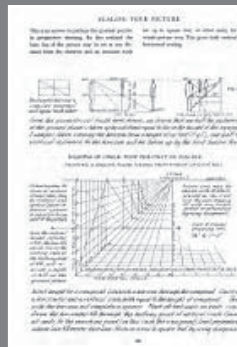

048.jpg

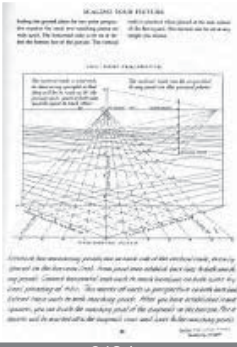

049.jpg



050.jpg



051.jpg



052.jpg

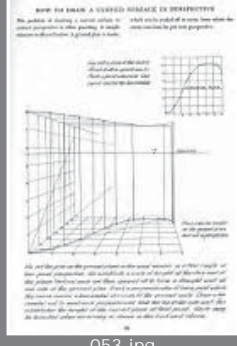

053.jpg

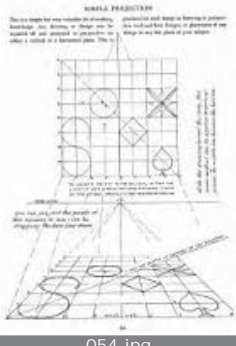

054.jpg

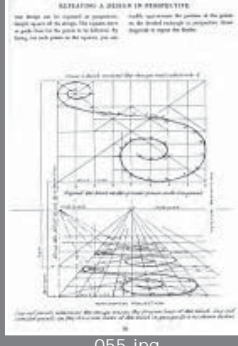

055.jpg

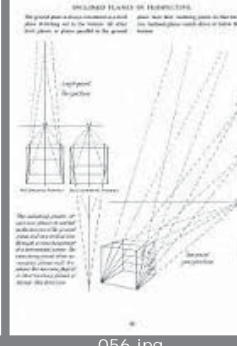

056.jpg

## THE CIRCLE AND THE SPHERE

Since a circle fits within a square, a sphere will fit within a cube. First divide the cube, then draw the circle plan in perspective horizontally across the middle section of the cube (Fig. 1).

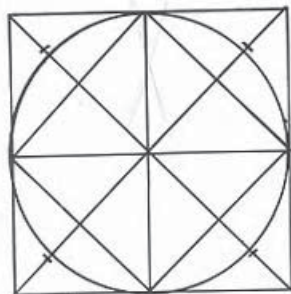

THE CIRCLE PLAN

THE DRAWING BELOW SHOWS THE CIRCLE PLAN LAID OUT ON THE MID-HORIZONTAL PLANE AND ONE OF THE DIAGONAL PLANES

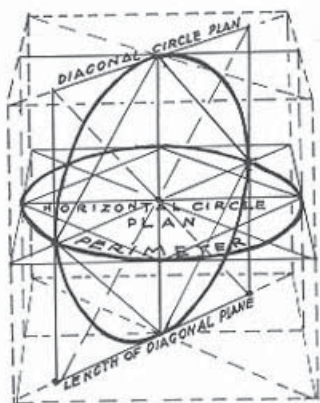

FIGURE ONE

Then draw the circle plan on the upright diagonal planes. The length of these planes is determined by the perimeter of the horizontal circle.

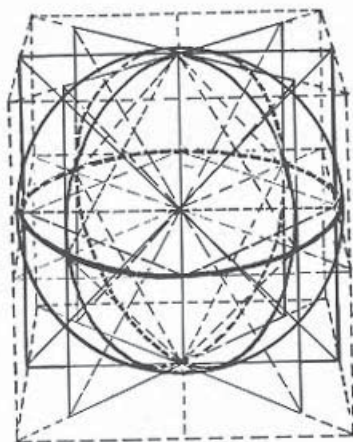
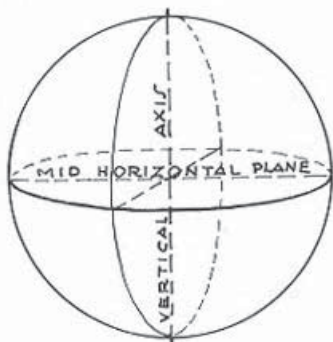

FIGURE TWO  
THE CIRCLE PLAN LAID ON ALL PLANES  
THUS PRODUCING A DIVIDED SPHERE



TWO INTERSECTING CIRCLES  
WITHIN A SPHERE

When the circle plan has been laid out on the mid-horizontal plane as well as on all vertical planes which pass through the vertical axis, a

perfectly divided sphere will result. The contour of a sphere never changes, though the lines of division are affected by perspective (Fig. 2).



## ROUND FORMS WITHIN THE BLOCK

What is true of the cube and the sphere is also true of any elongated block that will fit around any rounded form. Any such form can be drawn

in accurate perspective by using this basic approach. First draw plans of the middle planes of the block.

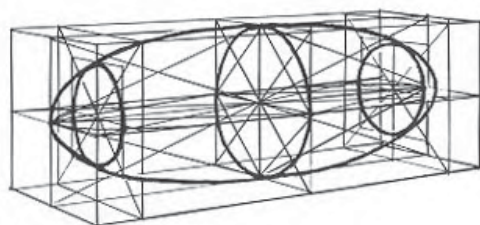
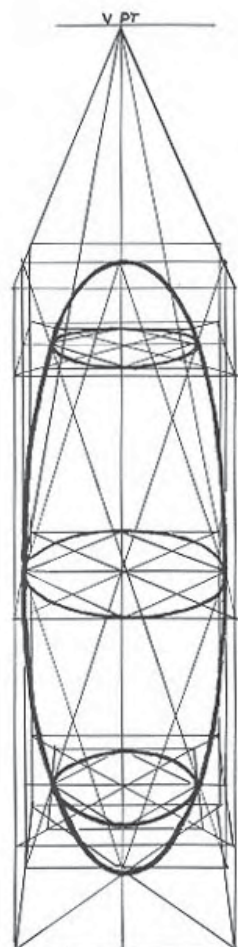
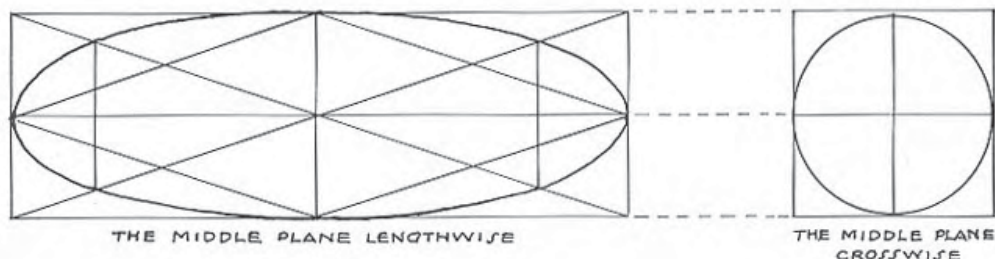

The drawings here indicate the soundness of this approach to good drawing. The whole principle of perspective drawing is to enable the draftsman to get at the inner construction and to relate all sections or parts to a single viewpoint. The mechanic builds from plans which are cross sections through the object. These are usually flat plans like the two at the top of this page. Having such plans, we can draw them to a horizon and vanishing points, showing the object in three dimensions.



## THE BLOCK APPLIED TO ROUND OBJECTS

The circle and the block can be applied in drawing many different objects. If you can draw the block in perspective, you can draw almost

any object in any position within your subject. Draw the block to equal the height, width, and depth of the form.

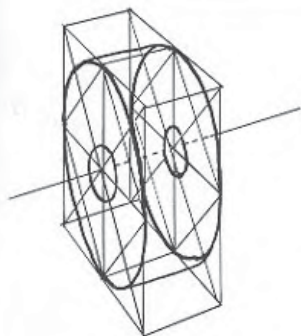
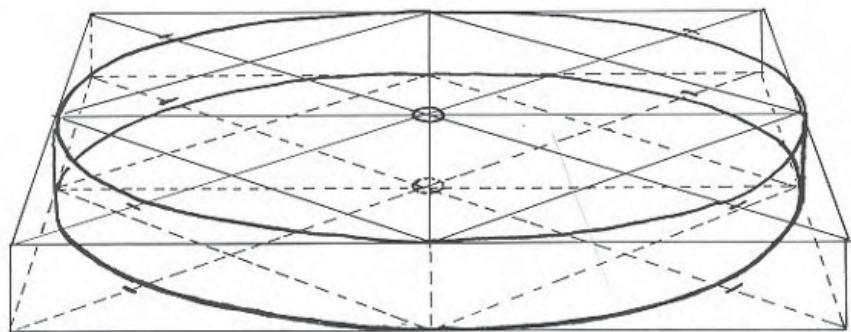
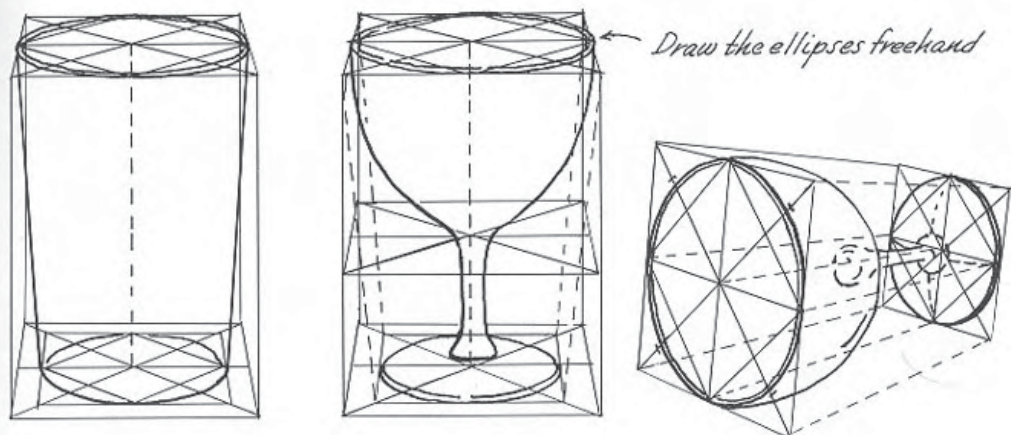

*The disk is a flat version of the cylinder. Since it has many uses, it is well to know just how the ellipses should be drawn to fit any object at any viewpoint and from any eye level.*

## HOW TO CONSTRUCT THE BLOCK CORRECTLY

In case you are having trouble in drawing blocks correctly, the drawings below will help you. Remember that ellipses narrow as they near the eye level. Studying a real object will help you

approximate this. The perspective depth\* of the top side of the block determines the perspective depth of the bottom side.

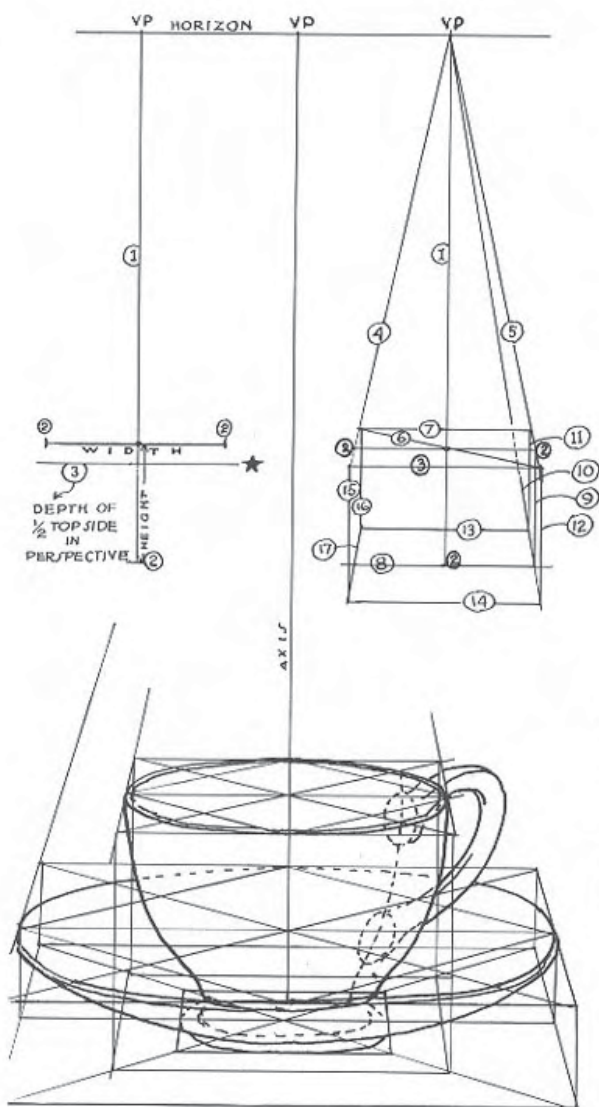

*How to construct a block of given or desired dimensions*

*You need a T square and a triangle. Establish a horizon or eyelevel. Draw a perpendicular (1). Establish height and width of block (2) on the perpendicular. The depth of  $\frac{1}{2}$  of the top side in perspective (3) is optional.\* Through the points established at ends of line (2) draw connecting lines (4) and (5) to the vanishing point above. Then draw the other lines in the order indicated by their numbers.*

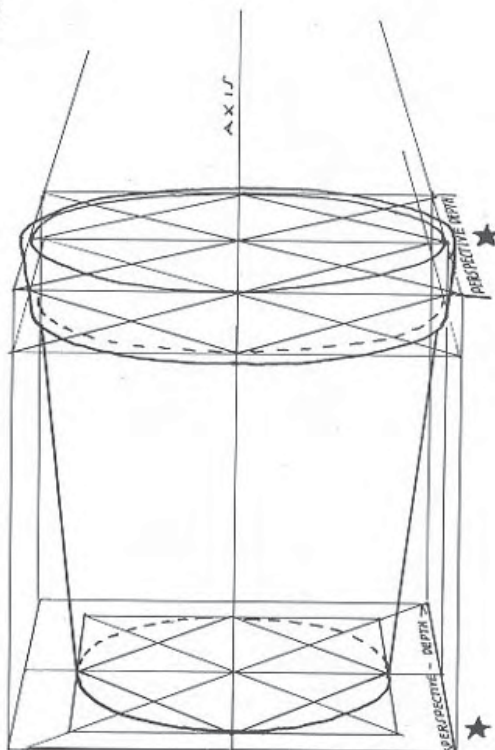





## BLOCKS OF SPECIFIED DIMENSIONS

Here are two ways of constructing blocks of specified dimensions. In the drawing at the left, the dimensions are laid out on the middle line or axis, using the procedure shown on the pre-

ceding page. In the one on the right, we establish a measuring line touching the near corner, then carry the units to the base line.

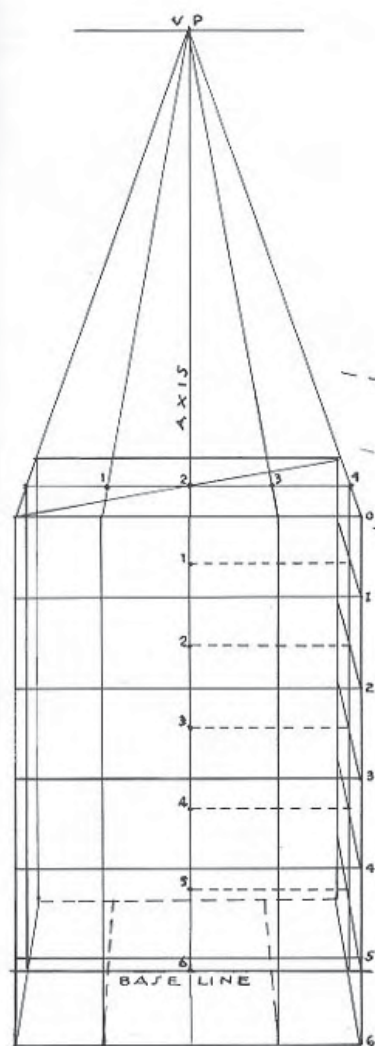

UNITS ARE PROJECTED TO THE FRONT PLANE OF THE BLOCK

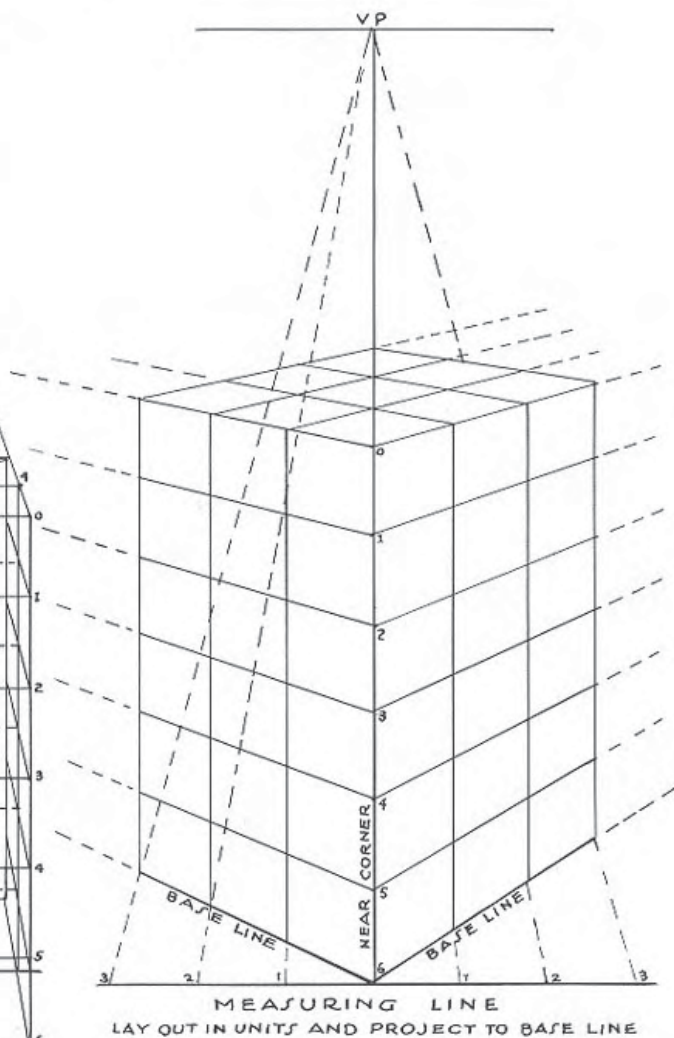

LAY OUT IN UNITS AND PROJECT TO BASE LINE

When you can produce a block of specified dimensions, you have the basis for drawing any object accurately. You are urged to practice this until you can do it, because it is a procedure that

you will use for the rest of your life. We progress from this to other methods of measurement in perspective.



## MEASURING DEPTH BY MEANS OF DIAGONALS

The drawings below show how to space off equal units in perspective within both horizontal and vertical planes. This is valuable in drawing evenly spaced units that recede toward the horizon. It will enable you to space correctly such

things as units of rug designs, fence posts, telephone poles, trains, window panes, blocks in sidewalks, building blocks, bricks, roofing, wallpapers, etc.

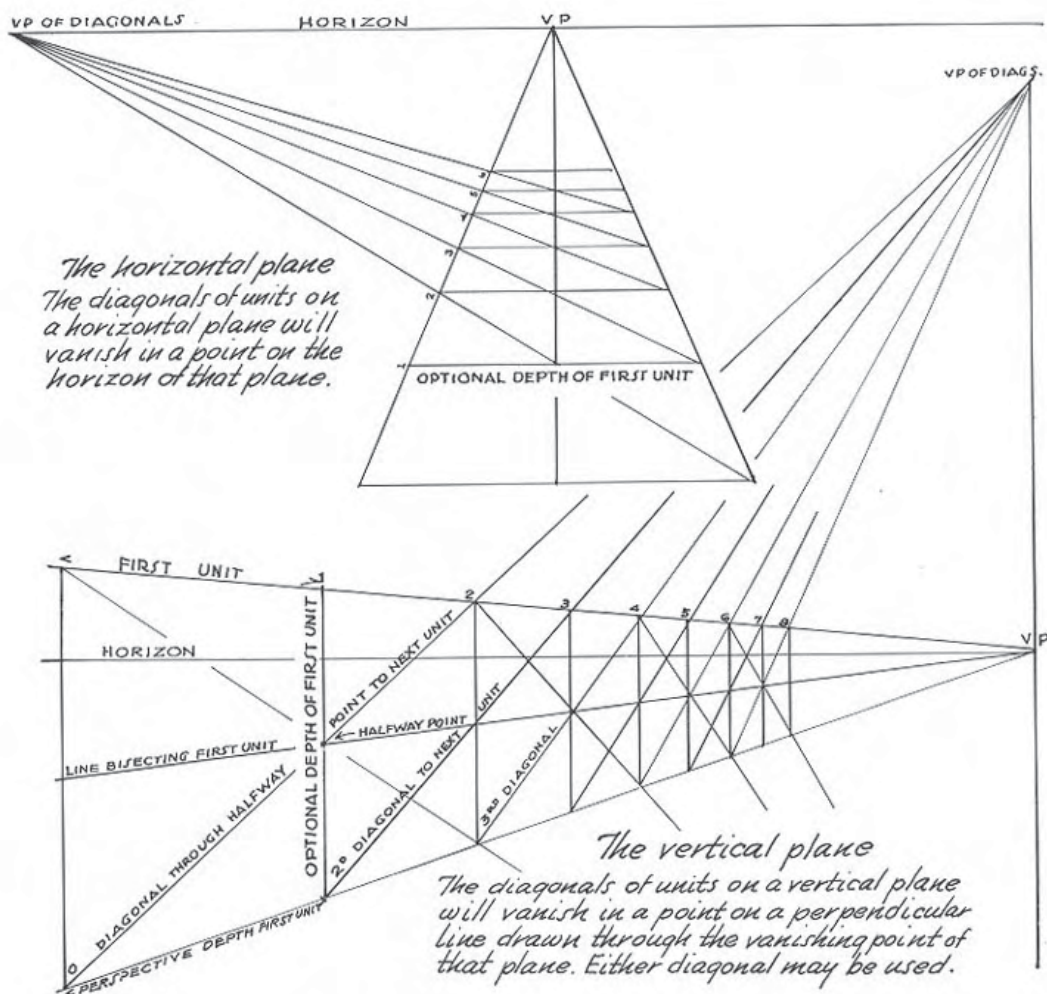

*In any perspective drawing we must set the perspective depth of a first unit, because its appearance is affected by the distance from which we are viewing it. Its perspective depth changes with every step we take toward or away from such a unit or area. When the first unit is established, we repeat it by running a diagonal through a halfway point of the unit to either the top line or the baseline. This marks off the next unit, as 0 through 1 to 2, 2 to 3, etc.*

## DRAWING TO SCALE

Every artist should know how to draw to a scale. Scale drawings usually require the division of vertical and horizontal planes into square feet or square units. By the plan shown here, we can quickly divide such planes into squares of any

dimension. Here we take a unit of 10 by 10 feet. We measure with this unit as far back as 2500 feet, which is as much as you will ever need. This is very valuable to you.

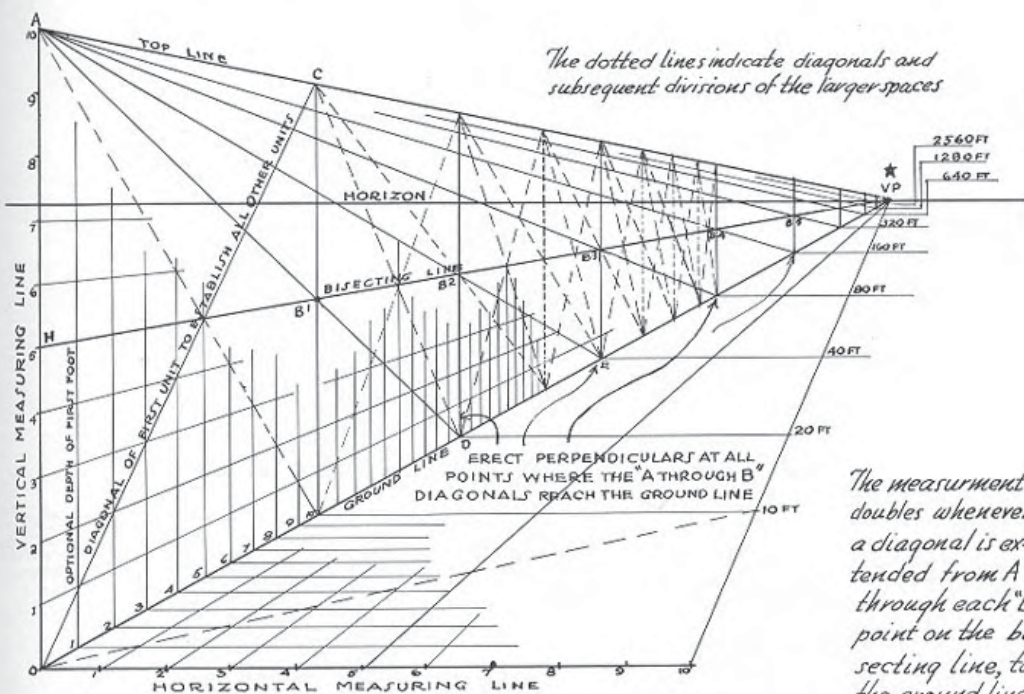

*The measurement doubles whenever a diagonal is extended from A through each "B" point on the bisecting line, to the ground line.*

### *How to scale a vertical and a horizontal plane*

*We must first establish a vertical and a horizontal measuring line, touching each other at right angles, (point zero). On both lines we lay out 10 equal units to represent 10 feet. The size of a unit is optional. The horizon is then set at any desired height on the vertical measuring line. We then establish a vanishing point anywhere on the horizon. Connect points O, H and A to VP. Establish optional depth of the first foot. Then draw lines from all foot units toward VP. Diagonal of first foot (OC) marks off vertical divisions of foot units and also the first 10 ft. unit at point C. Diagonal A through B<sup>1</sup> (on the bisecting line) to D<sup>1</sup> marks off 20ft. on the ground line. Then AB<sup>2</sup> to E is 40 ft., and so on to infinity.\**

## DIAGONALS IN SINGLE-POINT PERSPECTIVE

It is very important to understand what is meant by a single-point perspective and two-point perspective and how the planes and their diagonals operate in each. The basic plan for single-point

perspective is shown below. Although we do not need all the diagonals for purposes of measurement, we should know how to choose the ones we need.

*The basic working plan of single-point perspective*

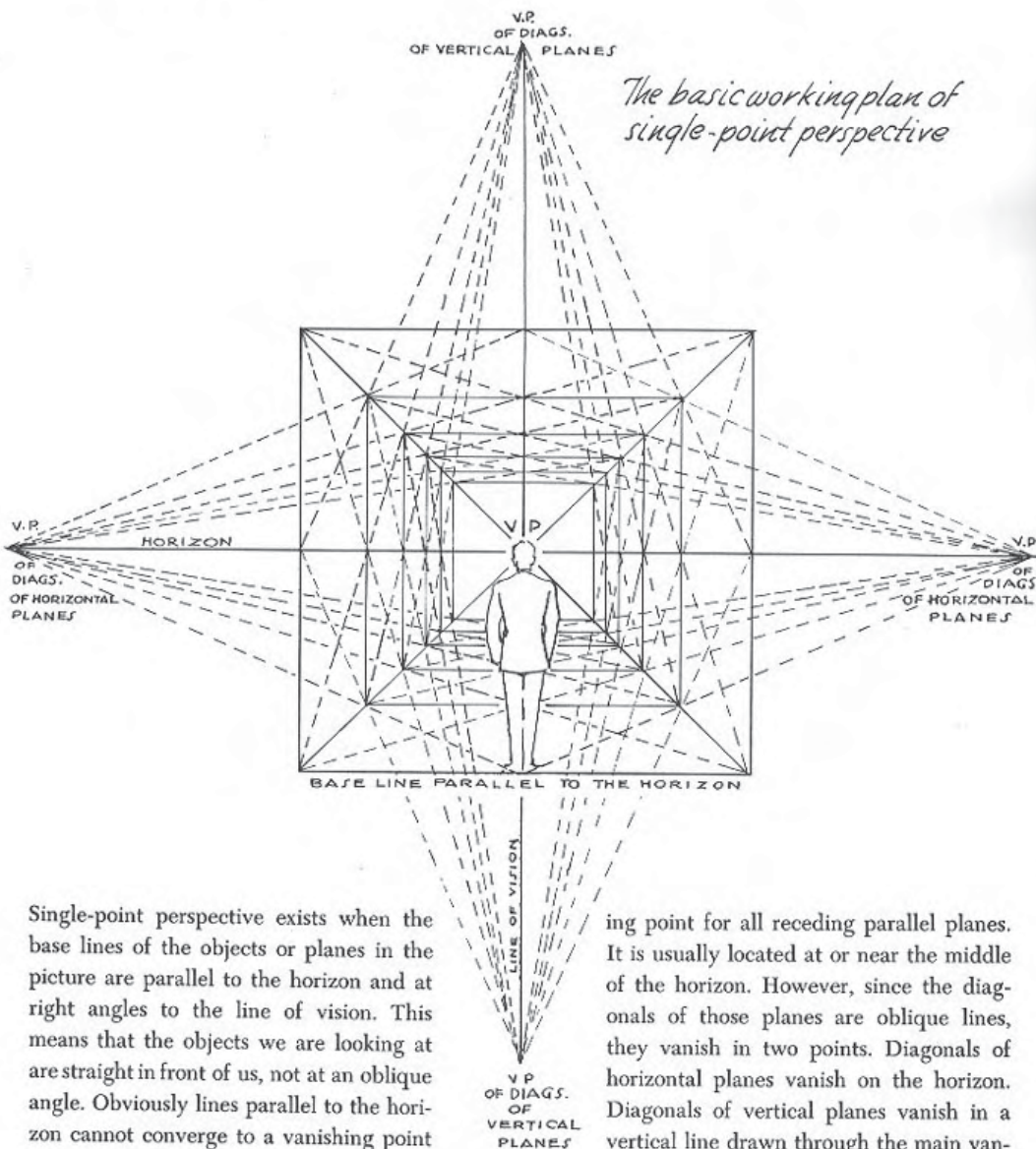

Single-point perspective exists when the base lines of the objects or planes in the picture are parallel to the horizon and at right angles to the line of vision. This means that the objects we are looking at are straight in front of us, not at an oblique angle. Obviously lines parallel to the horizon cannot converge to a vanishing point and therefore have none. In single-point perspective there is only one main vanish-

ing point for all receding parallel planes. It is usually located at or near the middle of the horizon. However, since the diagonals of those planes are oblique lines, they vanish in two points. Diagonals of horizontal planes vanish on the horizon. Diagonals of vertical planes vanish in a vertical line drawn through the main vanishing point.

## DIAGONALS IN TWO-POINT PERSPECTIVE

drawing below, while it appears to be complicated, is simple when you understand it. We divided a block into sections of four units on each side and carried all the diagonals to their

proper vanishing points. This is seldom necessary, but it illustrates the basic plan for diagonals in two-point perspective, and is important to know.

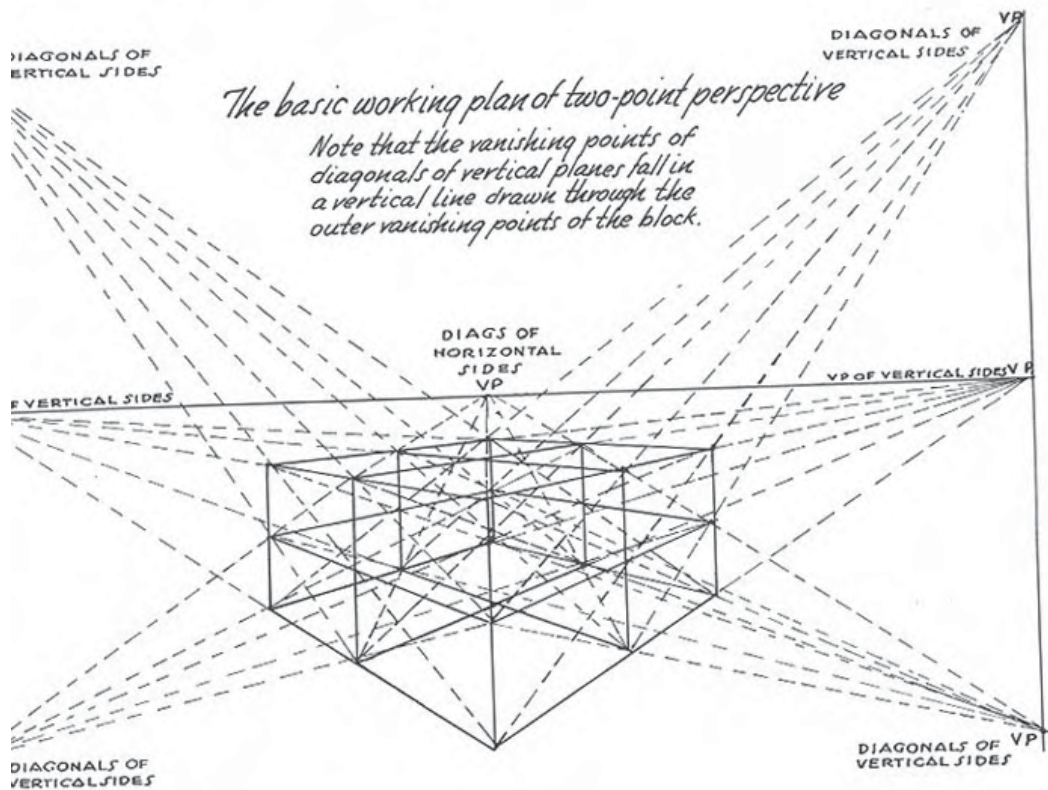

The vanishing point of the diagonals of the horizontal planes is located on the horizon. What is true of diagonals on vertical planes also applies to inclined planes, as we learn later, for their vanishing points also fall on a vertical line

through the vanishing points of the vertical planes. It is necessary to study the drawing carefully to locate the diagonals of any particular section. Try drawing this.

## EQUAL SPACING OF SOLIDS IN PERSPECTIVE

By the same method of measuring depth by means of diagonals we can also repeat a solid block, as shown below. This is valuable in drawing buildings of repeating dimensions or any

row of objects that are constructed within equal blocks. Remember that all objects can be drawn within blocks.

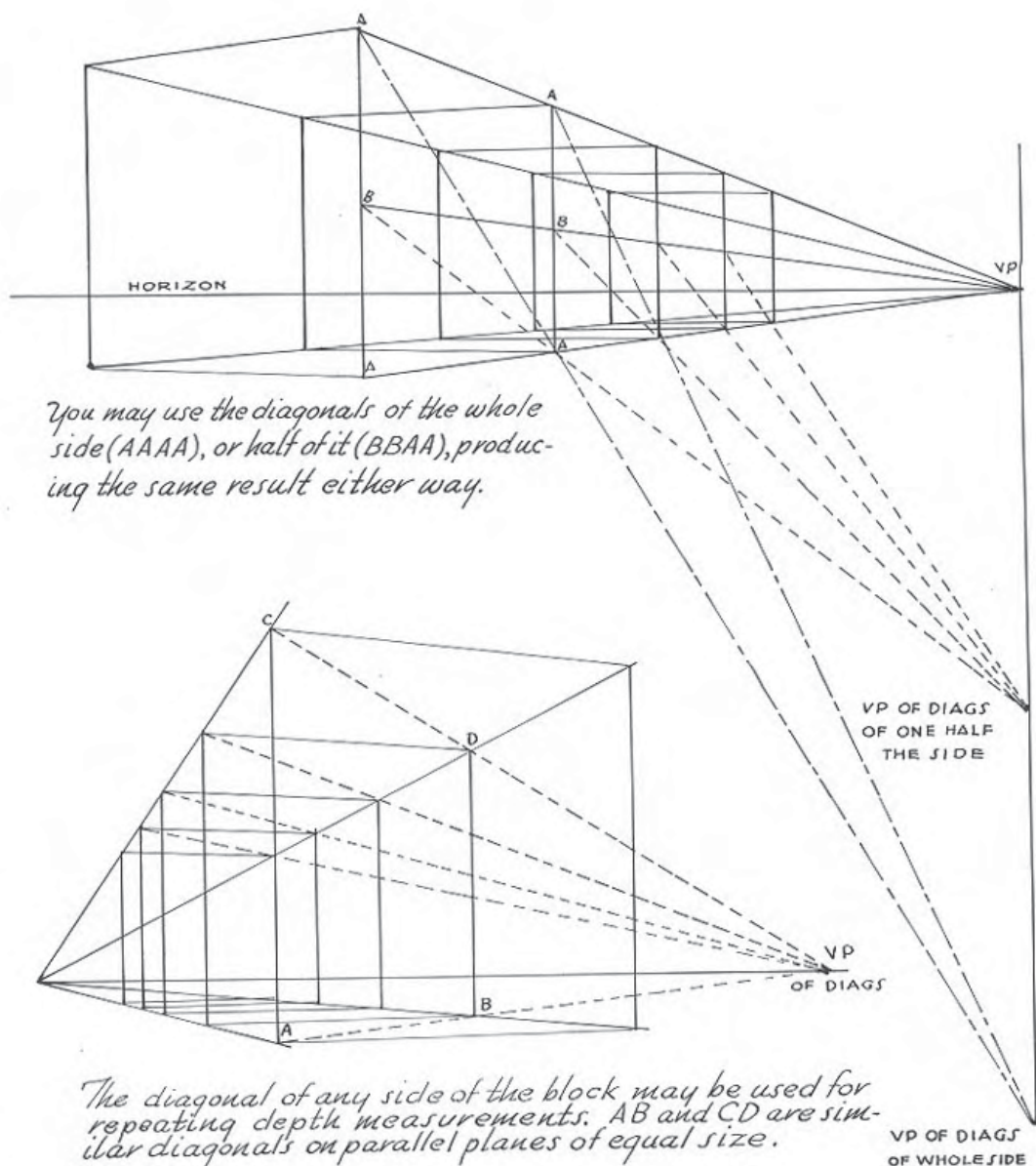

*You may use the diagonals of the whole side (AAAA), or half of it (BBAA), producing the same result either way.*

*The diagonal of any side of the block may be used for repeating depth measurements. AB and CD are similar diagonals on parallel planes of equal size.*

## UNEQUAL SPACING OF SOLIDS IN PERSPECTIVE

Measurement of unequal depths in perspective becomes very simple if we use a vertical and a horizontal scale. The scale is a right angle attached to the near corner of the first block. Such

an angle can be attached to any object, thus setting up a scale of measurement for all variable heights and widths.

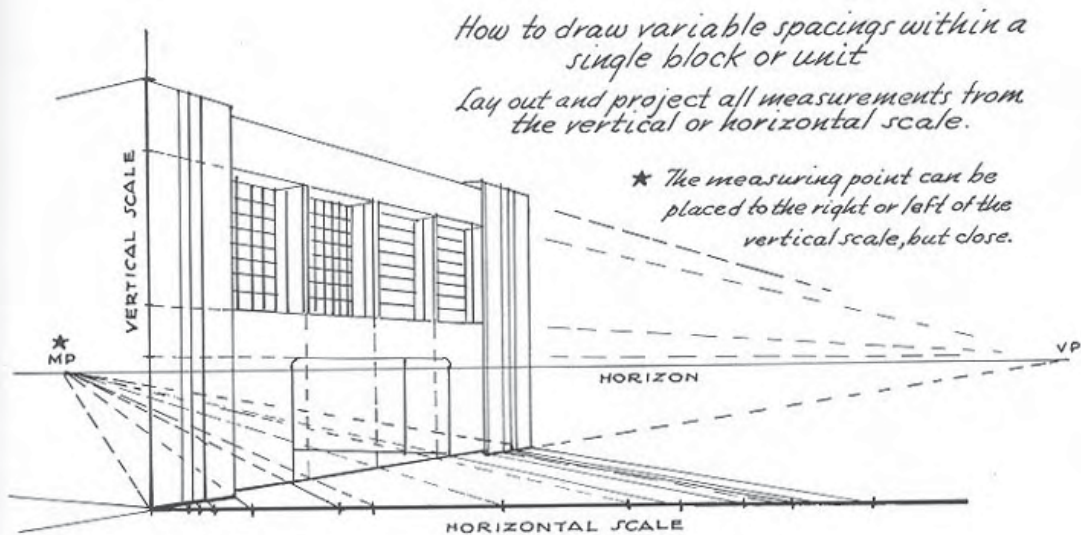
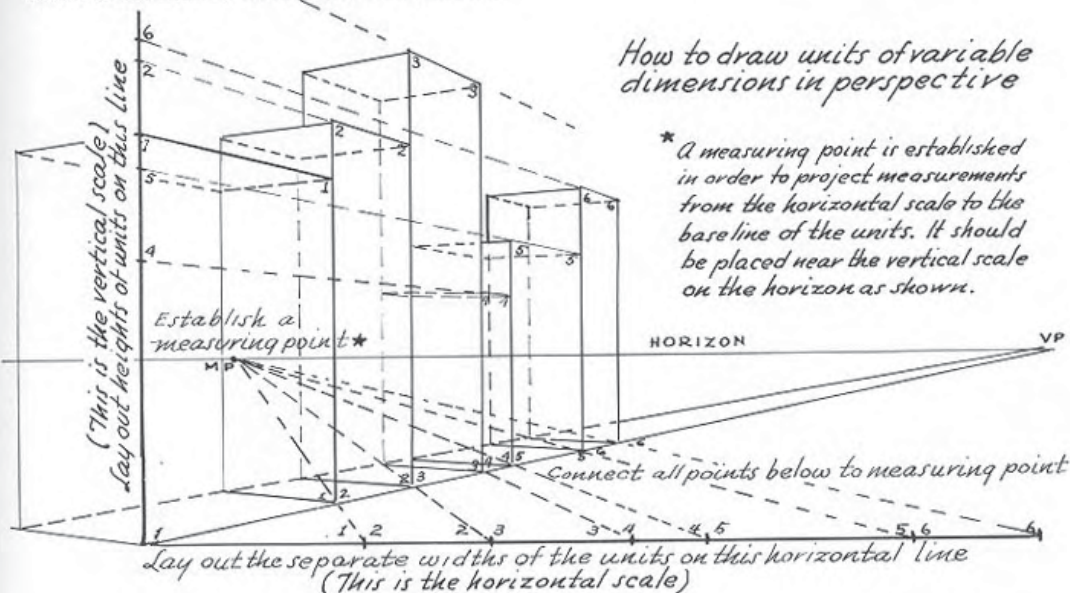

Measurements for all spaces may be set by choice or taken from a plan or scale elevation and laid out on the vertical and horizontal scale.

They are then projected in perspective in the manner shown in this drawing.



## SIMPLE PROJECTION IN PERSPECTIVE

Here is a very simple method of projecting dimensions and spacings in perspective. The top drawing shows the front and side elevations of a house. The dimensions of these create a vertical and a horizontal scale. The horizontal spac-

ings are projected to the base lines by means of two measuring points. The vertical spacings are transferred to the vertical scale of the perspective drawing and projected to the vanishing points.



*First draw the front and side elevations of a building of any dimensions or design, to a scale.*

*Bring the corners together with parallel lines.*

*Drop all horizontal measurements down to the Horizontal Scale*

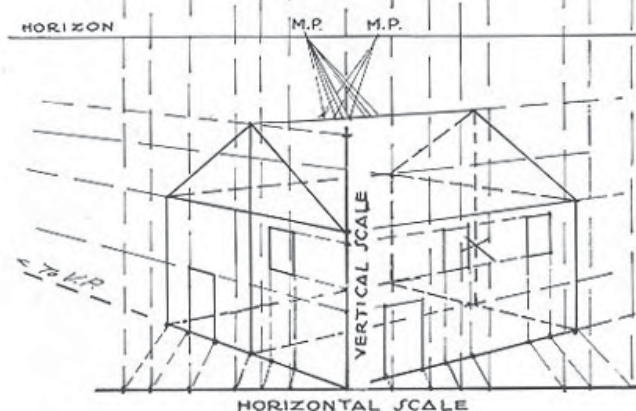

*Establish a horizon with two vanishing points set well apart. Place a measuring point on each side of the vertical scale. Lay out the heights on the vertical scale. Extend base lines to vanishing points at both right and left.*

*The points on the horizontal scale are all connected to the two measuring points through the base lines. In this way the spacings are carried back to the building. Then by running perpendiculars up the walls at these points, we determine the lateral spacings in perspective. The points of the vertical scale are carried out to the vanishing points, thus establishing the vertical spacings on the perpendiculars brought up from the base lines.*



## PROJECTING THE VERTICAL SCALE

The vertical scale can be projected to any part of a drawing. In the drawing below it is more practical to place the scale in front of the middle of the building, so we move it from the front

corner of the steps, along the base line to the middle line, which has been projected down from the front elevation to the measuring line or horizontal scale.

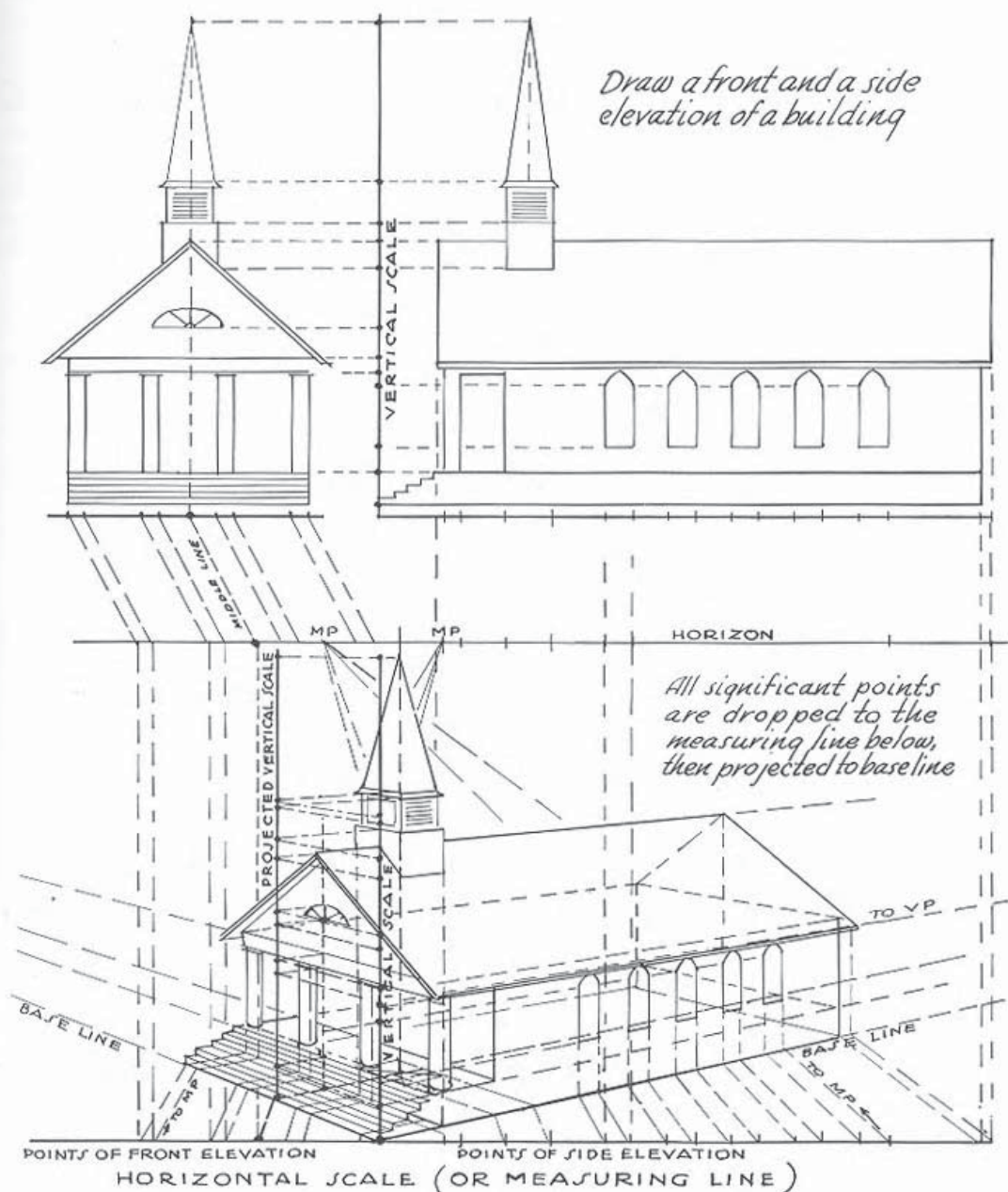



## ARCHITECTS' PERSPECTIVE

This is the way an architect renders ground plans and elevations in perspective. This knowledge makes it possible for an artist to draw any building to scale. Both vertical and horizontal

spacing of units can be achieved with accuracy. Note that another point, called the "station point," has been employed here.

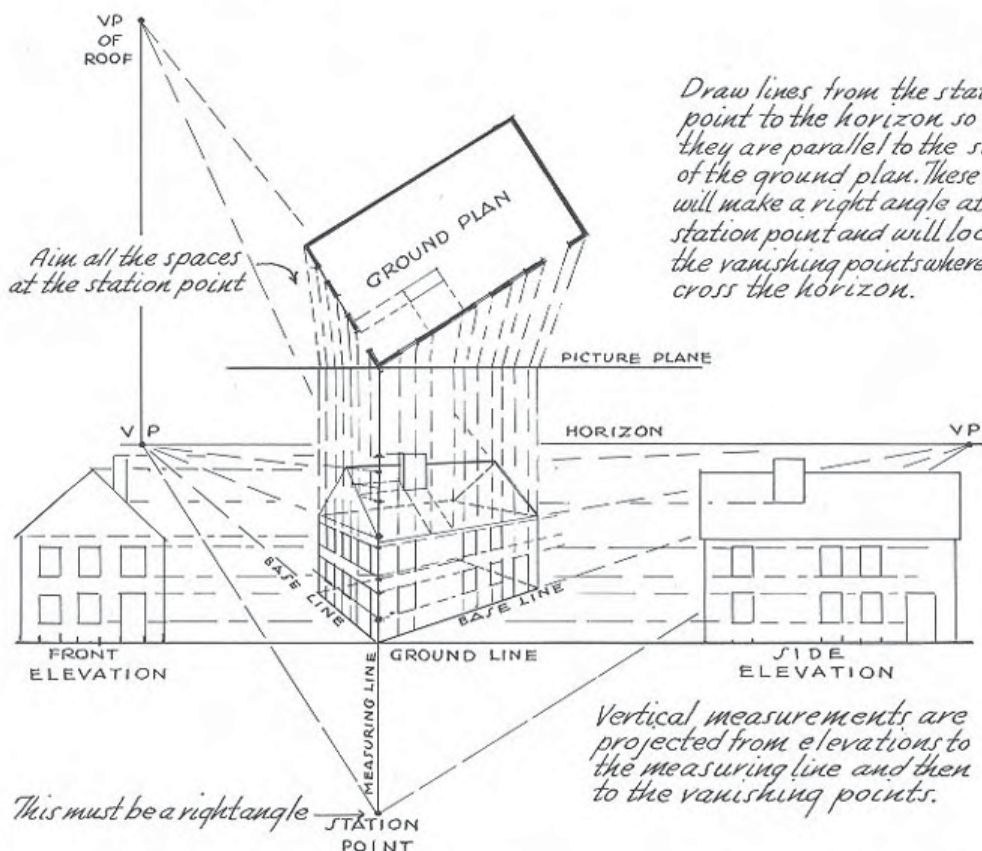

The station point represents the position of the observer. First we lay out a ground plan and place it at whatever angle we choose to view the building. We drop a vertical line down from the close corner. At this corner we also draw a horizontal line to represent the picture plane. A horizon can be established at any height above a ground line, both crossing the vertical. This vertical becomes a measuring line. Set a station point below the ground line. Lines aiming at the station point are drawn from the ground plan to the picture plane. All spacing is then projected to the base lines.

## ARCHITECTS' PERSPECTIVE

In this drawing we have a rather complicated ground plan. But remembering that "any form can be built within a box," we make use of this truth to simplify the rendering in perspective of

this odd shape. We are concerned here with setting the ground plan on the ground plane, using a single over-all height for the building.

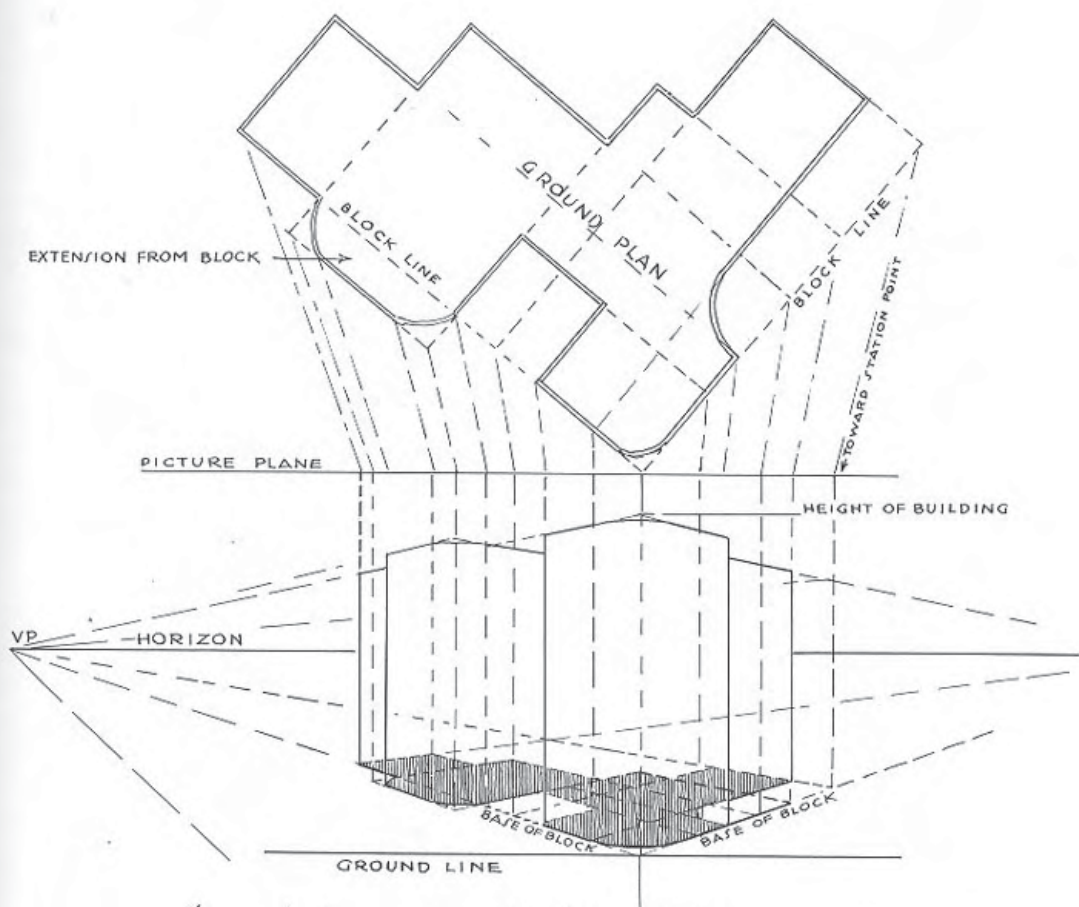

*In complicated exteriors of buildings, all divisions must be extended to the baselines, or the lines which run out to the two vanishing points from the front corner of the building. This amounts to placing the building within a rectangular block. The division points are brought down from the picture plane to the base lines then carried back to the vanishing points. Study this.*



## SCALING YOUR PICTURE

This is an answer to perhaps the greatest puzzler in perspective drawing. By this method the base line of the picture may be set at any distance from the observer and an accurate scale

set up in square feet, or other units, for the whole picture area. This gives both vertical and horizontal scaling.

Rectangles having a similar diagonal will equal each other.

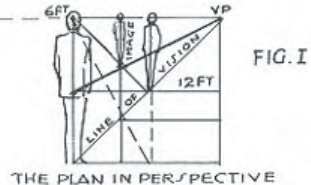
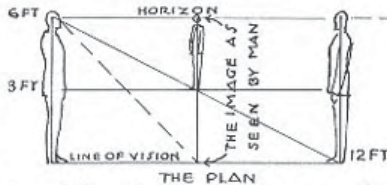
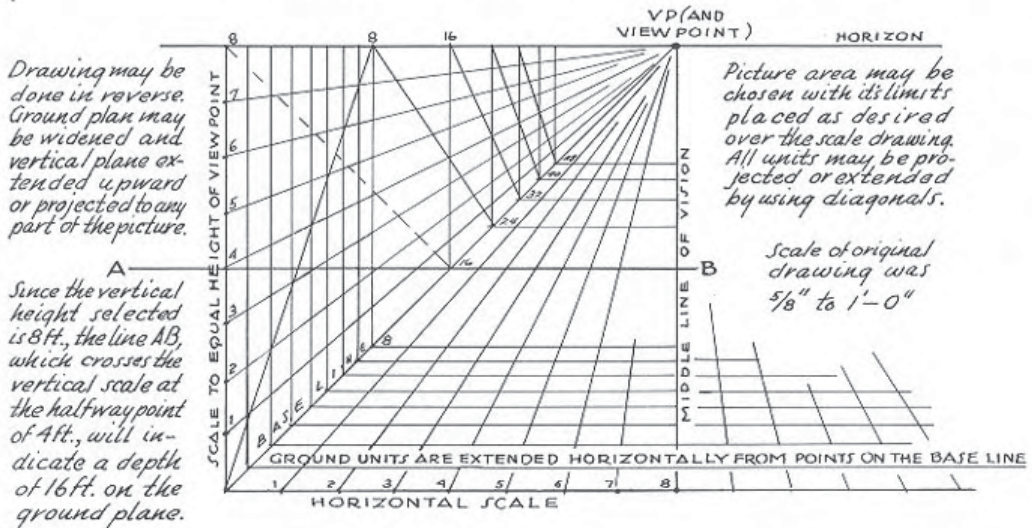

FIG. I

From the geometrical truth here shown, we learn that one half the picture area of the ground plane is taken up by a distance equal to twice the height of the viewpoint. Example: When viewing the horizon from a height of six feet (Fig. I), one half the vertical distance to the horizon will be taken up by the first twelve feet.

### EXAMPLE OF SINGLE-POINT PERSPECTIVE SCALING SHOWING A GROUND PLANE VIEWED FROM A HEIGHT OF EIGHT FEET



Select height for a viewpoint. Establish a horizon through the viewpoint. Construct a horizontal and a vertical scale, both equal to the height of viewpoint. These, with the horizon, will complete a square. Mark off feet units on both scales. Draw the horizontal AB through the halfway point of vertical scale. Connect all units to the vanishing point (in this case, the viewpoint). Erect perpendicular where line AB crosses base line. Reduce areas to square feet by using diagonals.

## SCALING YOUR PICTURE

Scaling the ground plane for two-point perspective requires the usual two vanishing points set wide apart. The horizontal scale is set on or below the bottom line of the picture. The vertical

scale is practical when placed at the near corner of the first square. The horizon can be set at any height you choose.

### TWO-POINT PERSPECTIVE

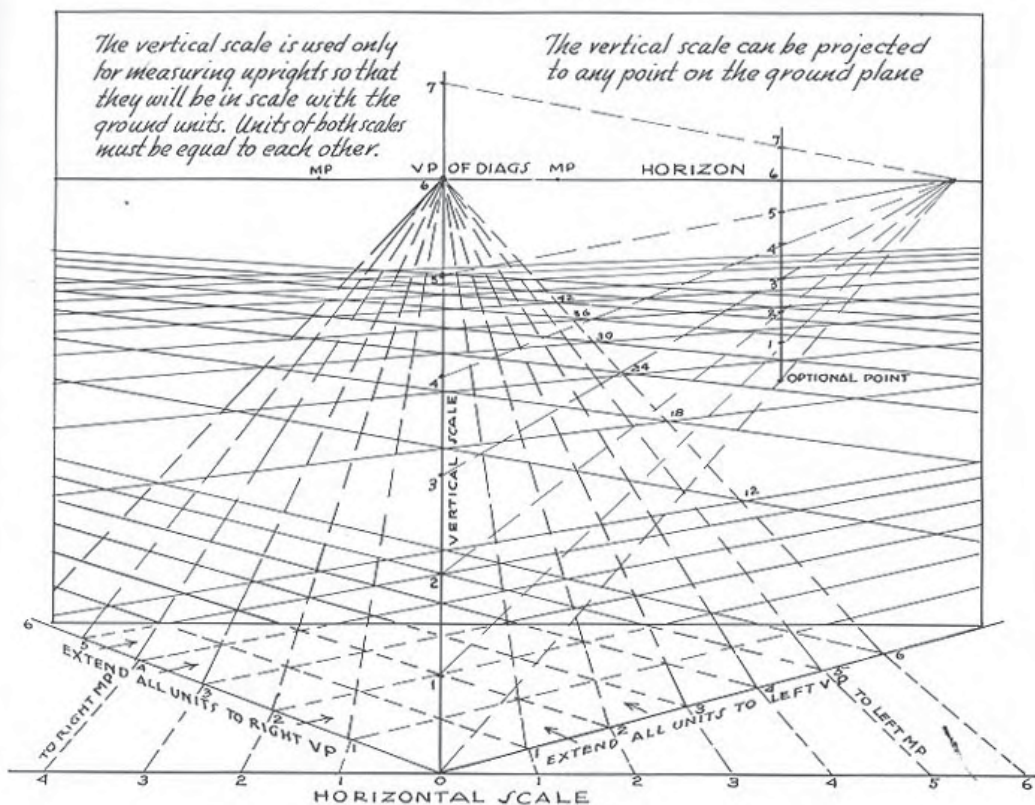

*Establish two measuring points, one on each side of the vertical scale, evenly spaced on the horizon, (MP). From point zero establish base lines to both vanishing points. Connect horizontal scale units to reach baselines on both sides by lines pointing at MP's. This marks off units in perspective on both base lines. Extend these units to both vanishing points. After you have established some squares, you can locate the vanishing point of the diagonals on the horizon. More squares will be marked off as the diagonals cross unit lines to the vanishing points.*



## SCALING THE INSIDE PLANES OF THE BLOCK

The vertical and horizontal scales can be used to scale any plane. Once we have the unit lines running in one direction, the diagonal of any square in crossing these lines marks off the units

running in the other direction, for width or depth as the case may be. All diagonals of similar squares or units will have the same vanishing point.

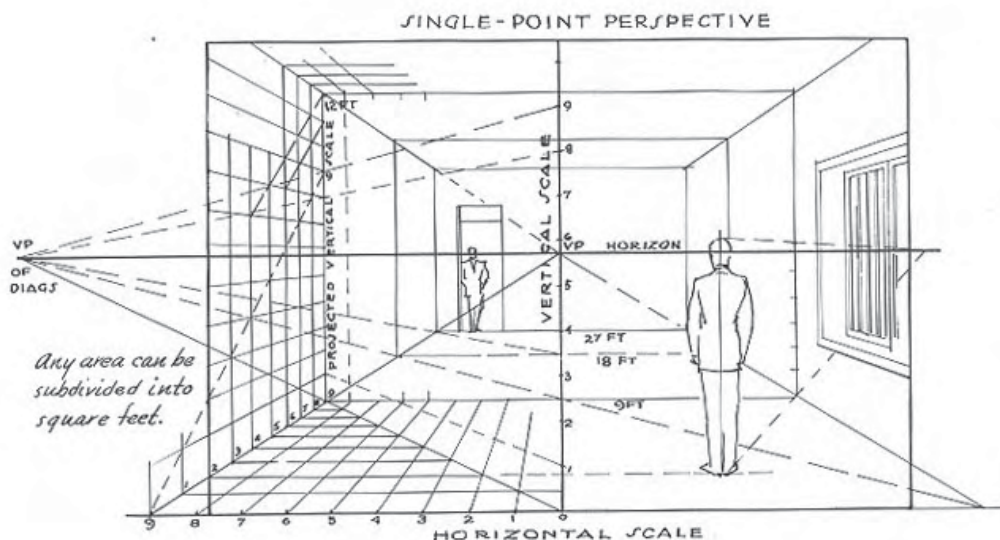

*In the drawing above the following problem is worked out. Draw a room 18 by 27 by 12 ft. at normal eye level, with two figures standing 25 ft. apart, in single-point perspective. Solution: Establish a vertical scale on a horizontal scale. Mark these off in foot units to be equal on both scales. Set the horizon at slightly less than 6 vertical feet. Set vanishing point at intersection of horizon and vertical scale. Connect horizontal units to VP. Establish depth of first square foot. Draw diagonal to horizon. This establishes VP of the diagonals for all receding units and also creates a unit 9 by 9 ft. Repeat this unit with diagonals as shown.*



## SCALING THE INSIDE PLANES OF THE BLOCK

Here the previous problem has been changed to two-point perspective. This amounts to a change of viewpoint. Instead of looking straight down the middle of the room, the observer has moved

to a theoretical position to the right of the figures. Only two walls are now visible. The full length of the room cannot be shown.

TWO - POINT PERSPECTIVE

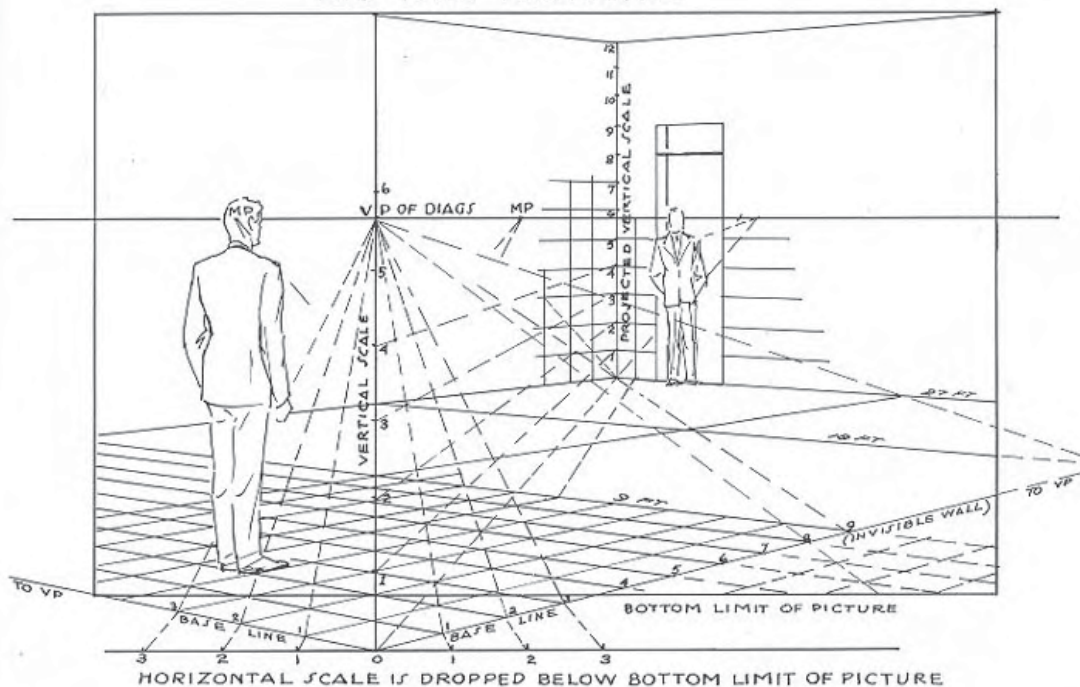

*The squaring off of the ground plane, in the drawing above, is made simpler by establishing two measuring points, one to the left and one to the right of the vertical scale. The near corner of the room is dropped below the bottom limit of the picture. Units on the horizontal scale are projected up to the base lines of the floor by connecting them to the two measuring points. By the use of diagonals, we can mark off remaining units.*

## SCALING AN INTERIOR FROM ELEVATIONS

The importance of being able to scale inside walls and floors should be obvious to anyone interested in good drawing. When you can do this, you can draw any interior and any furnishings

within an interior, keeping all things in scale or proportion to each other, and you know what size a figure should be at any spot in the room.



SIDE WALL

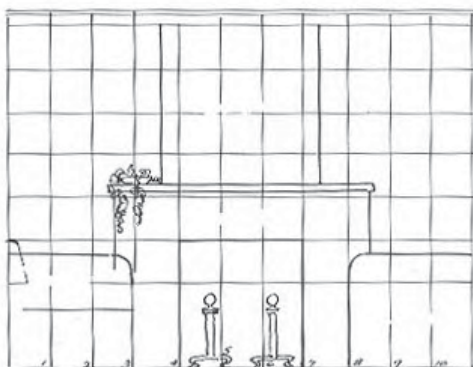

REAR WALL

*Establish a vertical scale. Mark off height of intended wall in feet. Establish a horizon cutting vertical scale at desired height. Establish vanishing points at right and left. Draw the base line for left wall to right vanishing point. Connect vertical divisions to the vanishing point. Establish depth of first square. Use the diagonal of the first square to mark off 8 squares. Further diagonals will establish all other units. Do the same with rear wall, using left vanishing point.*

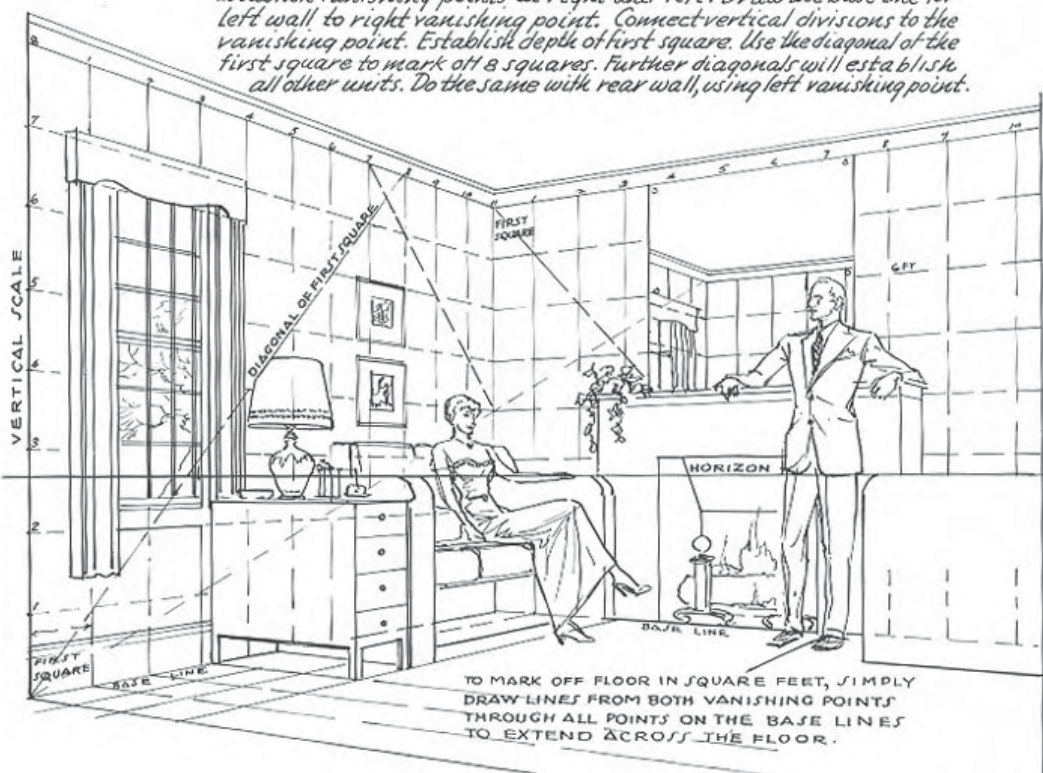

TO MARK OFF FLOOR IN SQUARE FEET, SIMPLY DRAW LINES FROM BOTH VANISHING POINTS THROUGH ALL POINTS ON THE BASE LINES TO EXTEND ACROSS THE FLOOR.

## HOW TO DRAW A CURVED SURFACE IN PERSPECTIVE

The problem of drawing a curved surface in correct perspective is often puzzling. A simple solution is offered below. A ground plan is made,

which can be scaled off in units, from which the curve can then be put into perspective.

*Lay out a plan of the curve.  
Block it off in square units.  
Mark a point wherever the  
curve crosses the horizontals.*

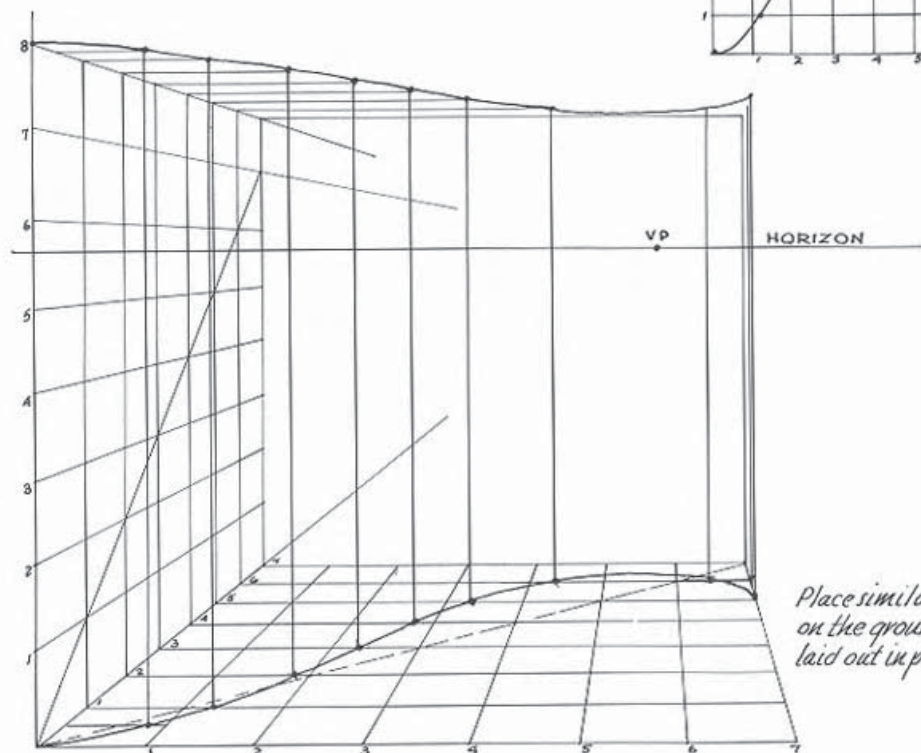
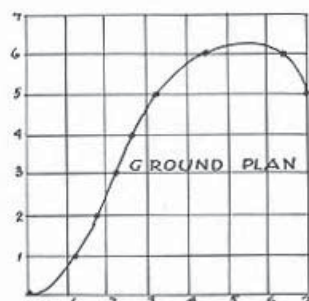

*Place similar points  
on the ground plan  
laid out in perspective.*

*We set the plan on the ground plane in the usual manner, in either single or two-point perspective. We establish a scale of height at the close end of the plane. Vertical units are then squared off to form a straight wall at one side of the ground plan. Erect a perpendicular at every point where the curve crosses a horizontal division of the ground units. Draw a horizontal out to meet each perpendicular from the top of the side wall. This establishes the height of the curved plane at that point. Units may be bisected when necessary as shown in the first unit above.*

*be bisected when necessary as shown in the first unit above.*

## SIMPLE PROJECTION

This is a simple but very valuable bit of working knowledge. Any drawing or design can be squared off and projected in perspective on either a vertical or a horizontal plane. This is

practical for such things as lettering in perspective, wall and floor designs, or placement of any design in any flat plane of your subject.

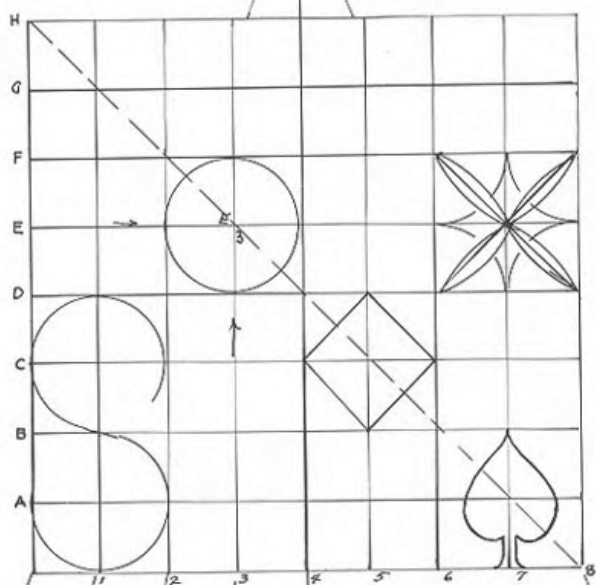

TO LOCATE POINTS IN THE DESIGN, LETTER THE LINES IN ONE DIRECTION AND NUMBER THEM IN THE OTHER, THUS E3 IS THE CENTER OF CIRCLE.

*With the drawing turned this way, the same method can be applied to vertical planes. The middle line becomes the horizon.*

*You can project the points of the squares to any size by dropping the base line down*

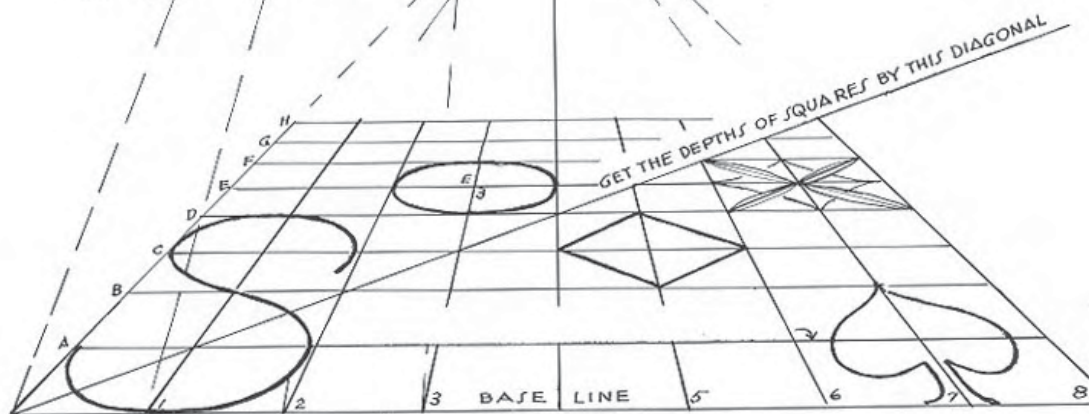

## REPEATING A DESIGN IN PERSPECTIVE

Any design can be repeated in perspective. Simply square off the design. The squares serve as guide lines for the points to be followed. By laying out such points on the squares, you can

readily approximate the position of the points on the divided rectangle in perspective. Draw diagonals to repeat the blocks.

*Draw a block around the design and subdivide it*

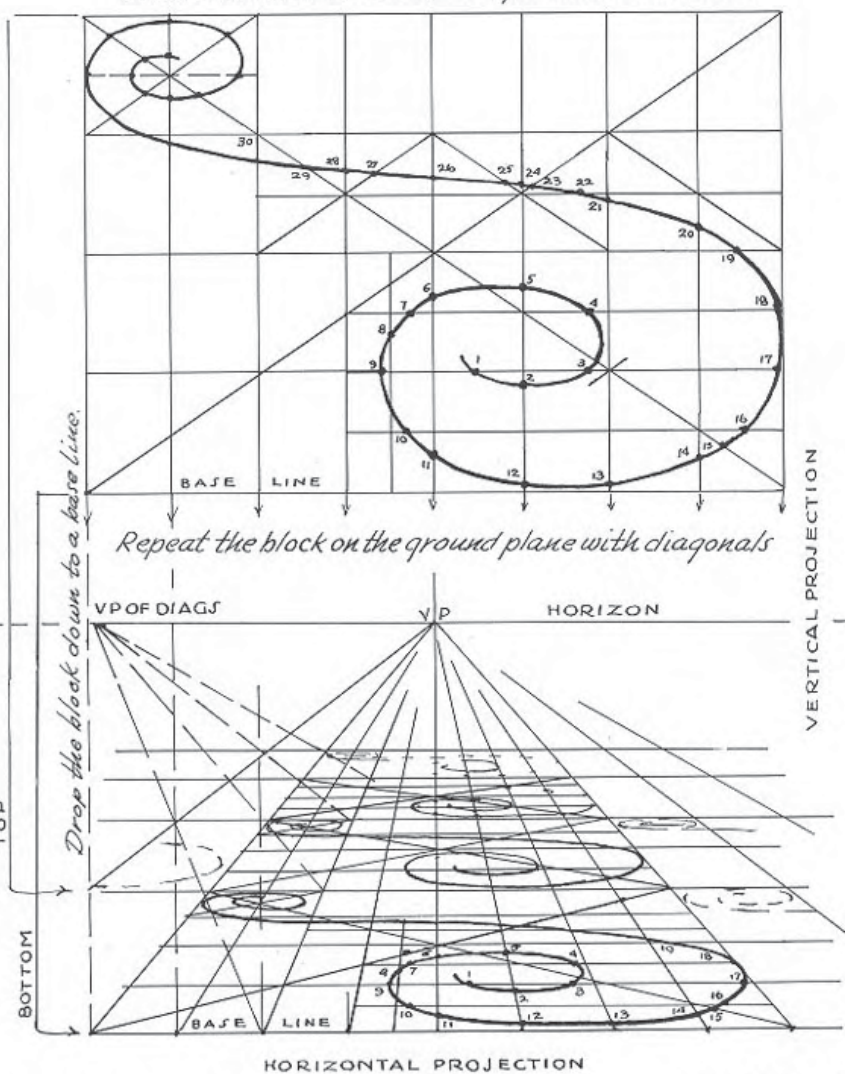

*Lay out points wherever the design crosses the division lines of the block. Lay out similar points on the division lines of the block in perspective as shown below.*



## INCLINED PLANES IN PERSPECTIVE

The ground plane is always considered as a level plane stretching out to the horizon. All other level planes, or planes parallel to the ground

plane, have their vanishing points on that horizon. Inclined planes vanish above or below the horizon.

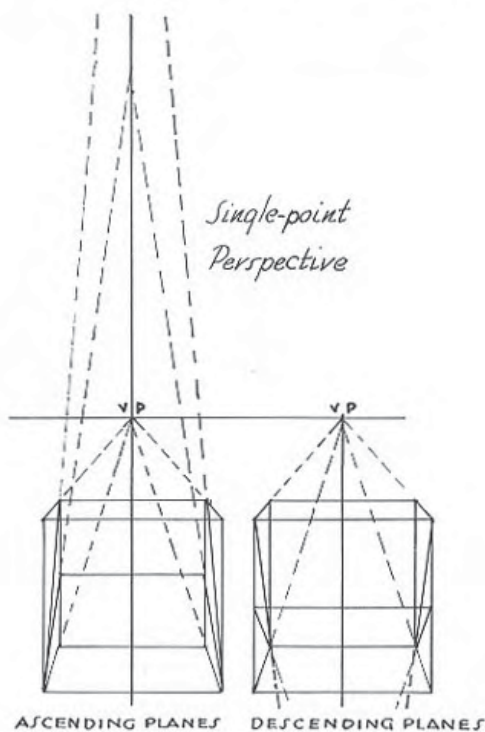

*The vanishing points of inclined planes do not fall on the horizon of the ground plane, but on a vertical line through a vanishing point of a horizontal plane. The vanishing point of an ascending plane will be above the horizon, that of a descending plane is below the horizon.*

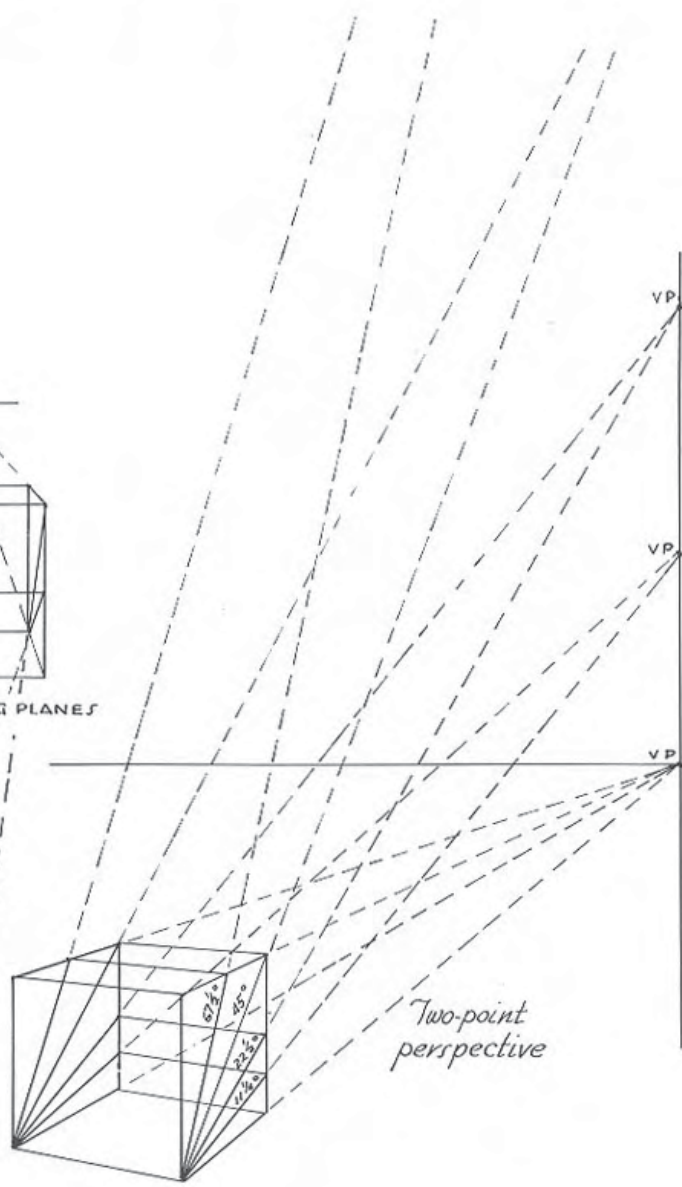

## INCLINED PLANES IN PERSPECTIVE

Drawing roofs is a problem to one who does not know perspective. A roof, being an inclined plane with two edges parallel to the ground, has two vanishing points. The edges parallel to the ground plane vanish on the horizon at the van-

ishing point of the building. The inclined edges vanish above or below the horizon on a vertical line drawn through the vanishing point of the building. Many artists do not know this.

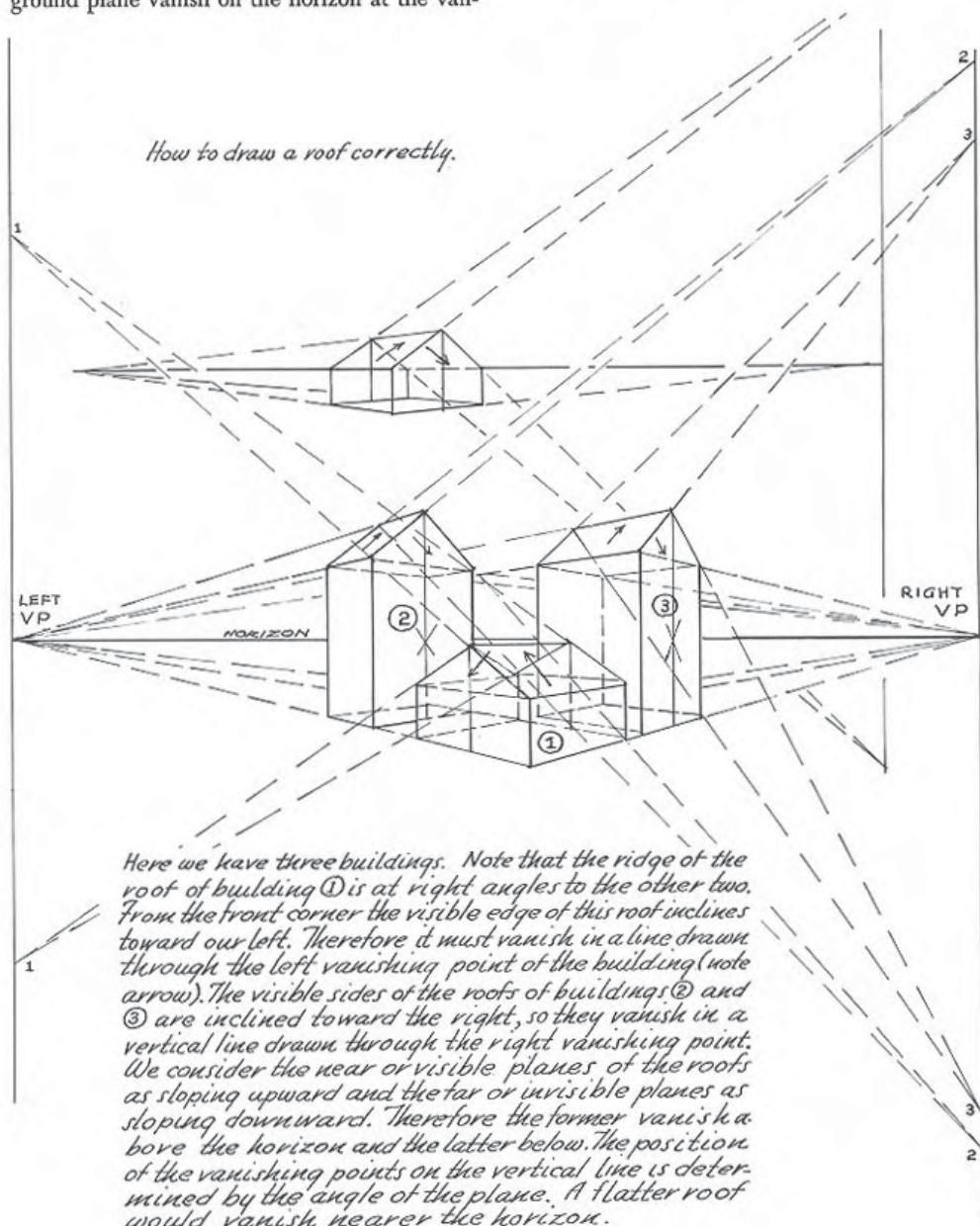

## INCLINED PLANES IN PERSPECTIVE

The pyramid and similar forms are exceptions to the general rule, in that they have no vanishing points except those for the base lines. A conical form has no vanishing points except those for

the block inside which the form is constructed. We must always build such forms from a block in correct perspective, since there is no other way to relate them to the horizon.

*All drawings below stem from the same two vanishing points on this horizon*

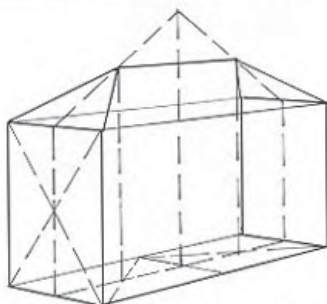
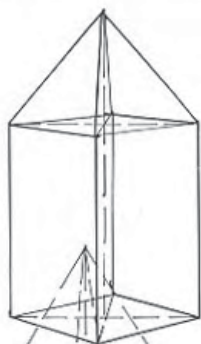

*Pyramidal roofs are built on a middle line*

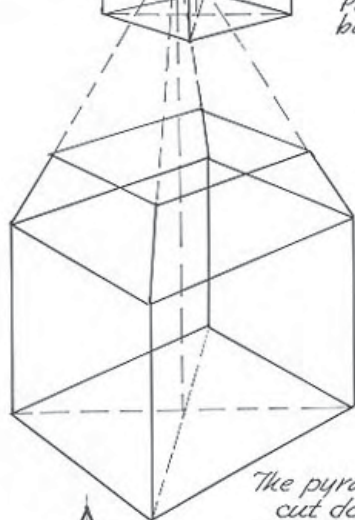
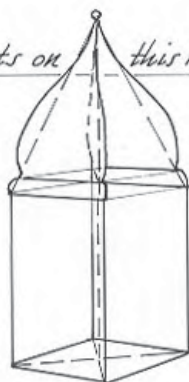

*The pyramid cut down*

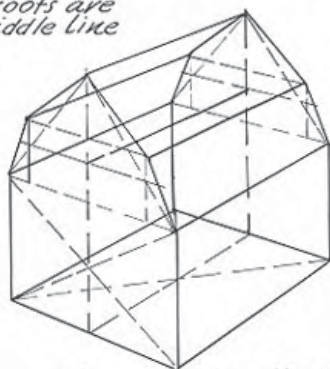

*The mansard is a "built-out" triangular roof*



*The cone*

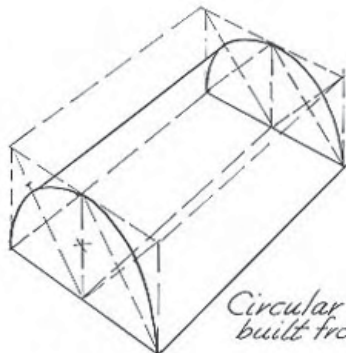

*Circular roofs are built from the block*

## INCLINED PLANES IN PERSPECTIVE

We must understand that inclined planes do not vanish at the eye level or on the picture horizon. The horizon has only to do with level planes and planes with edges parallel to the level

ground plane. This is confusing to the average student. Ascending planes always vanish above the horizon. Descending planes always vanish below the horizon. Try to remember this.

*What to do when the ground plane is not level*

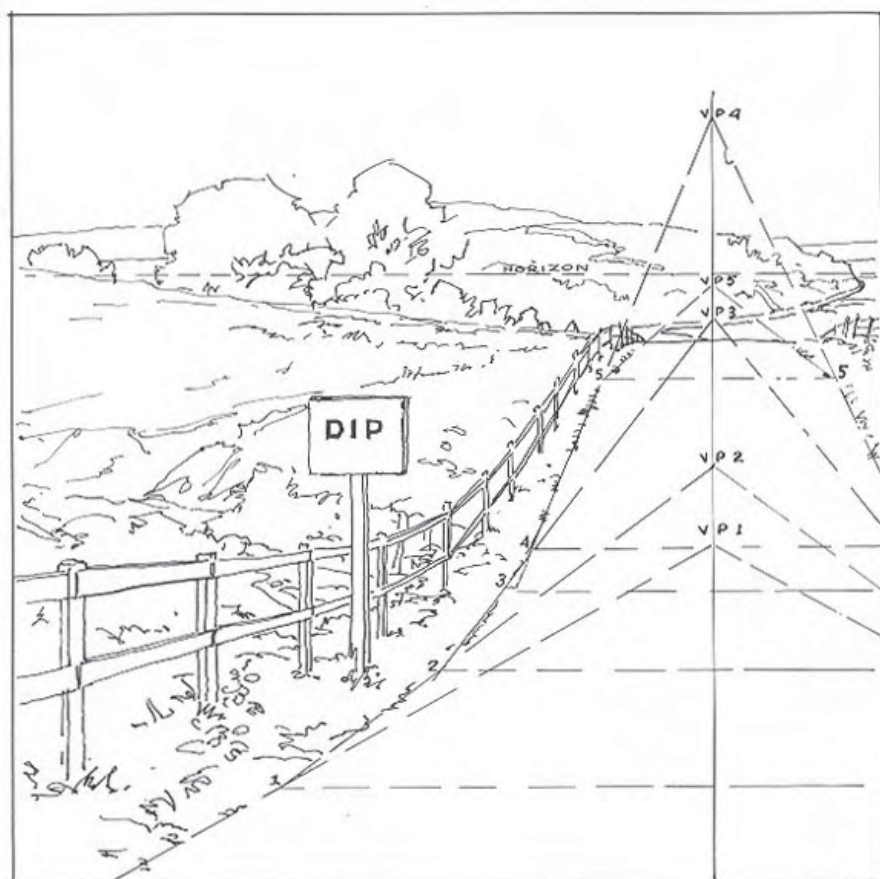

In the drawing above, the road descends and then rises over a hillside. It then appears to drop over a crest into a valley below. This is accomplished by drawing the road in sections, each

with a different vanishing point. As the angle of each section changes, the vanishing points are raised, then dropped, to follow the contours of the ground plane.

## INCLINED PLANES IN PERSPECTIVE

The problem of drawing a downgrade in perspective becomes simple once you know the basic principle. A downgrade has its vanishing point below the horizon in a perpendicular line

drawn through the vanishing point of the level planes. Note that there are two horizons. The upper one is the "true horizon." The lower one, not being an eye level, is a "false horizon."

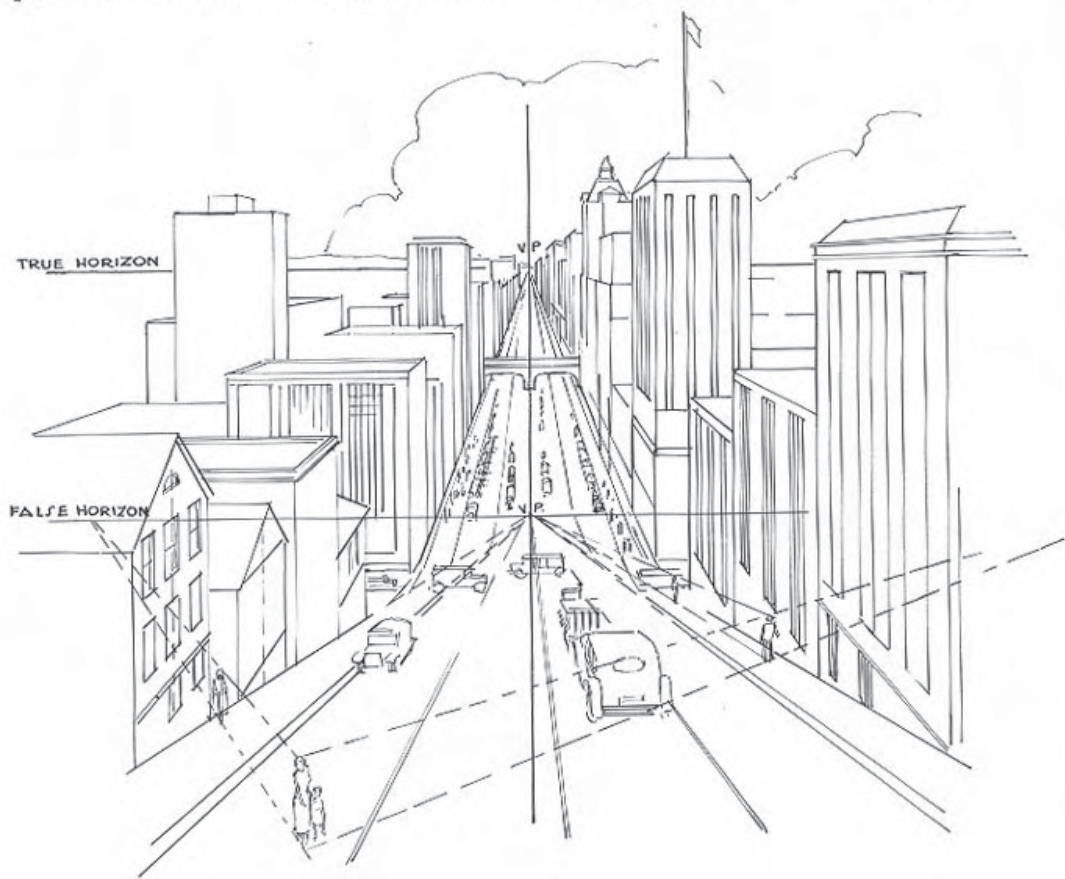

### *Looking Downhill*

Since the roofs and floors of buildings are built on level planes, they vanish in a point on the level horizon. The sloping planes vanish in a "false horizon," above or below the ground level.

The "true horizon" is always at eye level. Note that figures on the hill have been scaled to the lower horizon since they are affected by the slope.



## INCLINED PLANES IN PERSPECTIVE

For an upgrade view, the perspective principle is the opposite of that for a downgrade, in that the false horizon is above the true horizon. The

vanishing point of the slope falls on a vertical line drawn through the vanishing point on the true horizon.

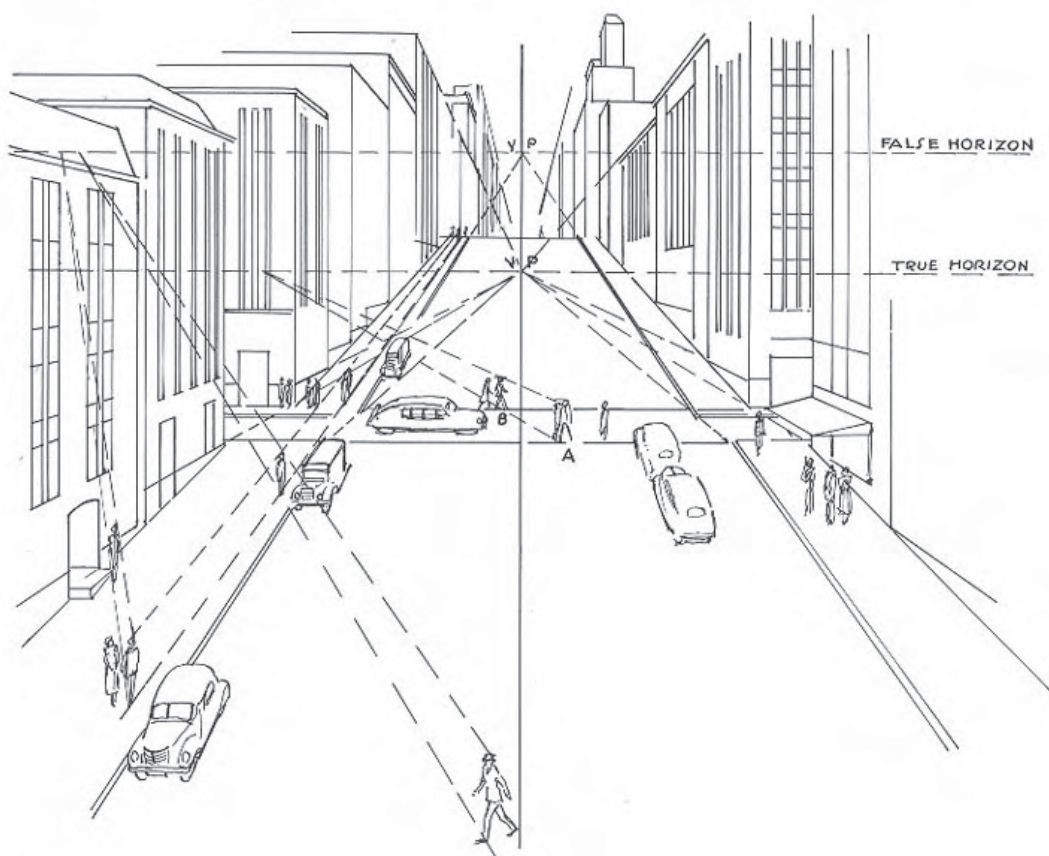

### *Looking Uphill*

The roofs, floors, windows, base lines, and all other level planes vanish in a point on the true horizon. Any plane that is a part of the slope vanishes in the point above on the false horizon. As before, the figures are scaled to the horizon of the slope since they are stationed on an in-

clined plane. Figures on level planes are always scaled to the true horizon, as shown at A and B where the figures are stationed on a level crossing. Figures in windows or on balconies are scaled the same way.

## INCLINED PLANES IN PERSPECTIVE

It is important to know how to draw a stairway in correct perspective and how to project figures upon any step. This is not difficult to do. The plane of the stairway locates all the points of the

risers. The treads all have the same vanishing point on the horizon. Scale the height of the risers to the figure, as shown in the drawing below.

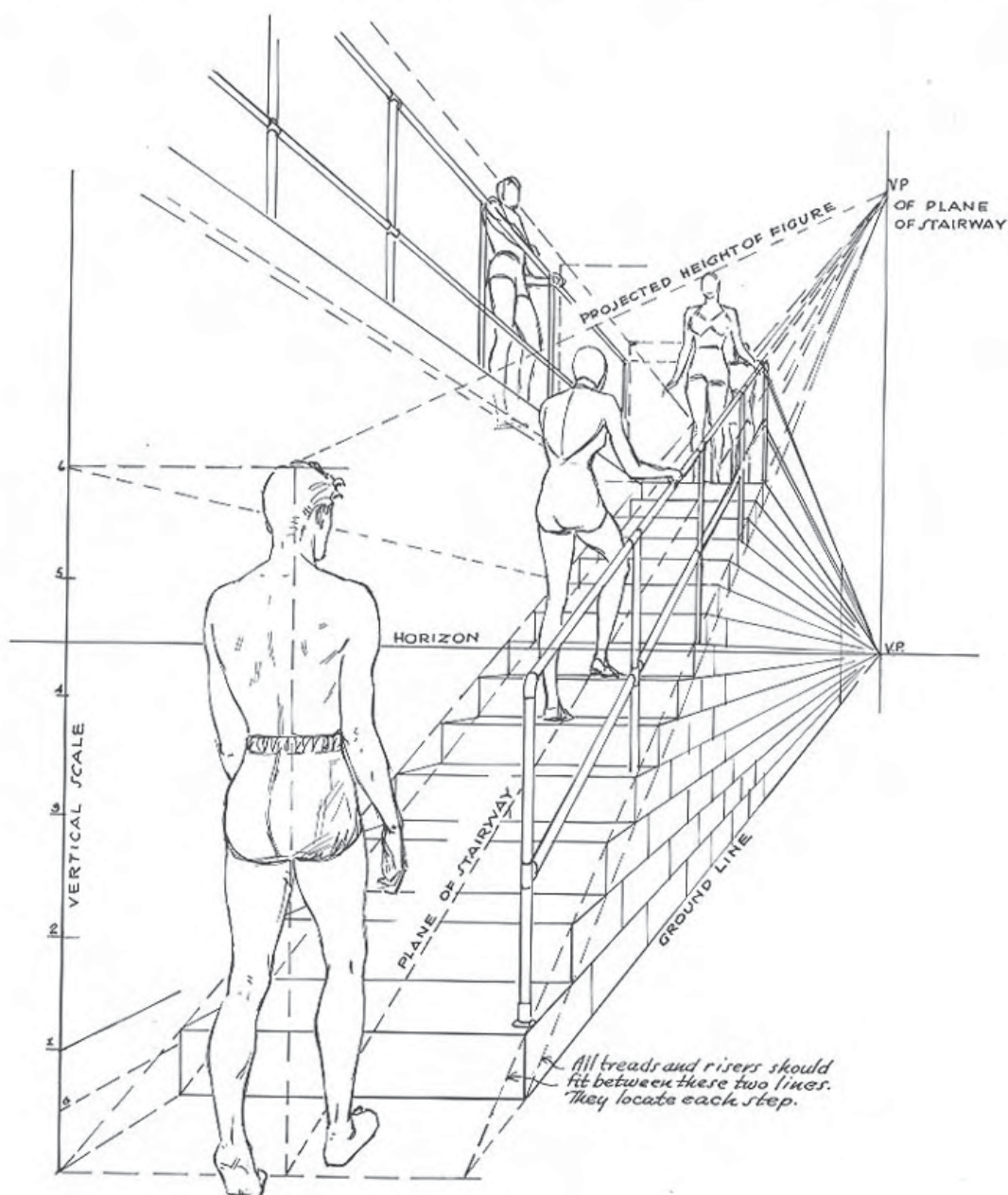



## INCLINED PLANES IN PERSPECTIVE

Here we reverse the problem on the preceding page, but we can still scale all the figures from the one at the bottom of the stairway. Note that we still have the two lines which give us the

size of the risers and treads as they come up the plane of the stairway. The figures are in approximately the same positions.

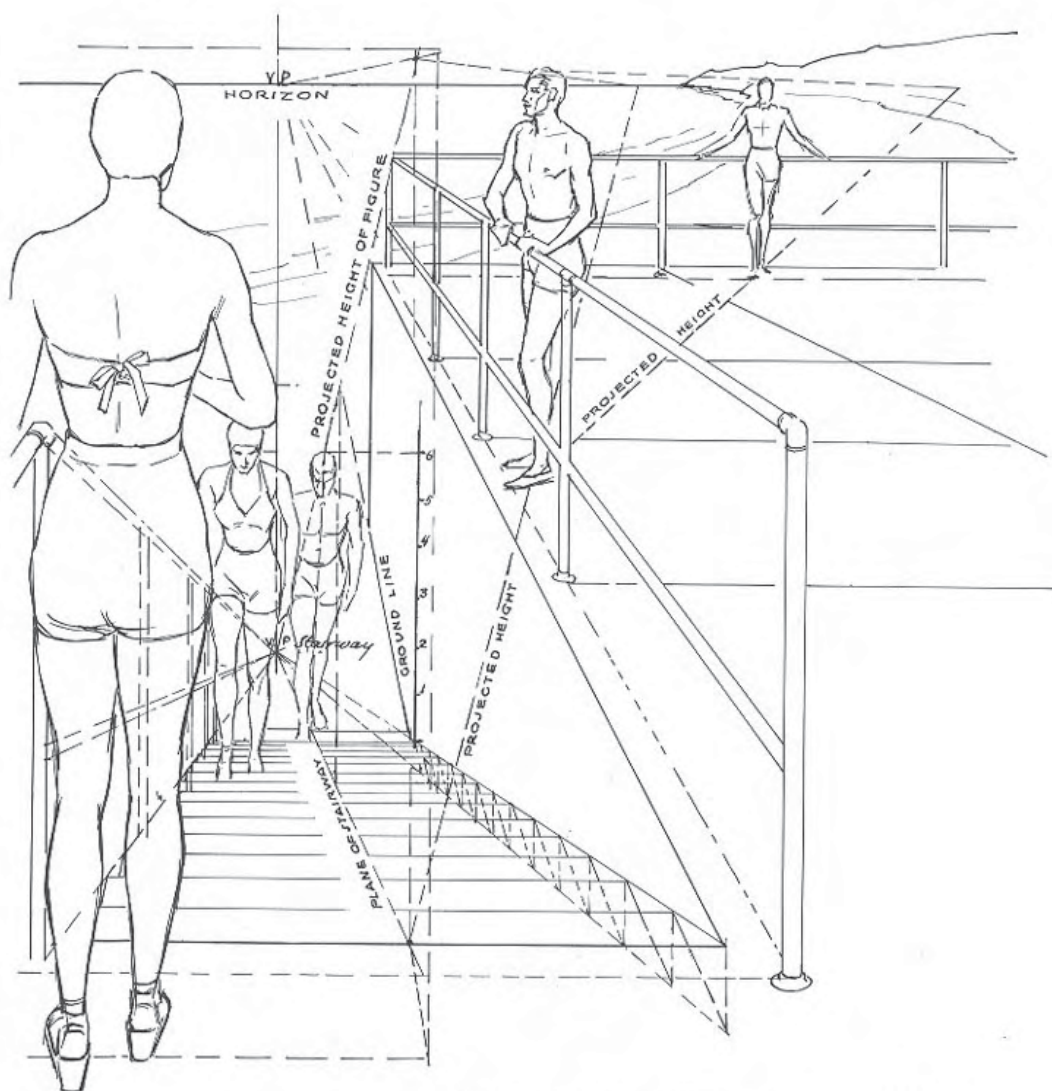

*The observer's position now appears to be at the top of the stairway looking down upon the same scene. How important is perspective!*

## INCLINED PLANES IN PERSPECTIVE

An artist may be faced with the problem of drawing a tilted object. The object may be falling, blown over, a squared object resting on an

inclined plane, or for any reason not be in alignment with the horizon. There is a simple technique for solving this problem.

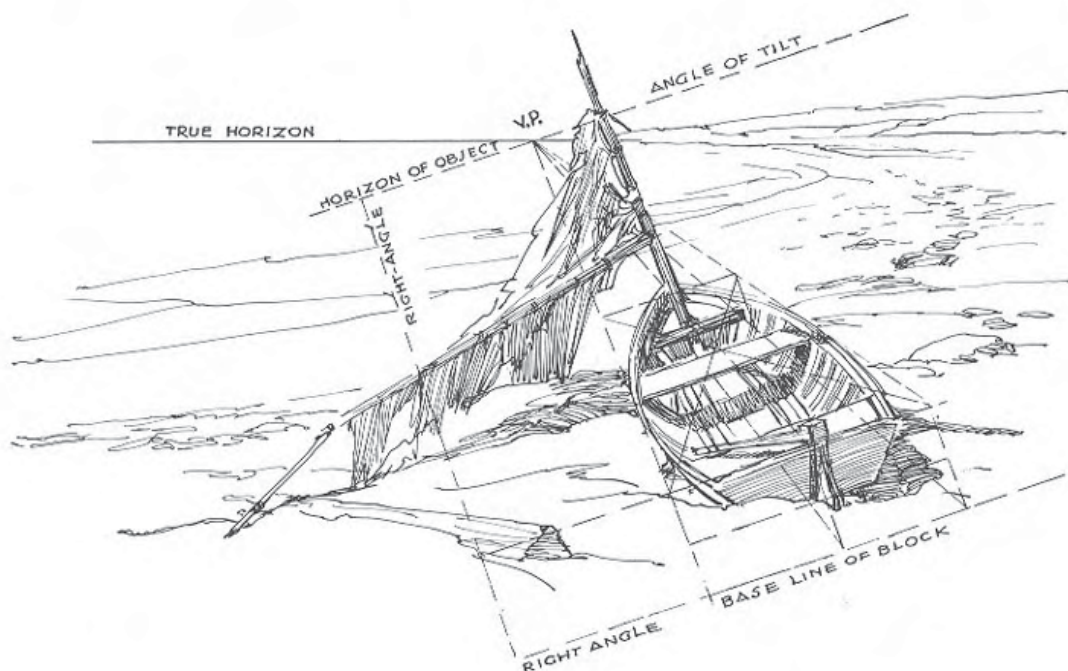

*First establish a vanishing point on the true horizon. Through that point draw the angle at which the object is to be tilted. This line will be the horizon of the tilted object. Now turn the drawing and draw a right-angle down from the new horizon. From that draw another line at right-angles to establish a base line for a block. Complete the dimensions of the block within which the object is to be drawn in perspective. Draw the object to its horizon as if it were on a level plane. The vanishing point should be at the point of crossing of the two horizons.*

## INCLINED PLANES IN PERSPECTIVE

It is important to know that any object which is not parallel to the ground plane has its vanishing point either above or below the horizon. The drawing below shows an ascending airplane.

The angle of ascension starts below the horizon and comes up through the ground plane and through the center of the object.

*Note: There is some distortion in this drawing due to having to place the vanishing point too close in order to show it on the page.*

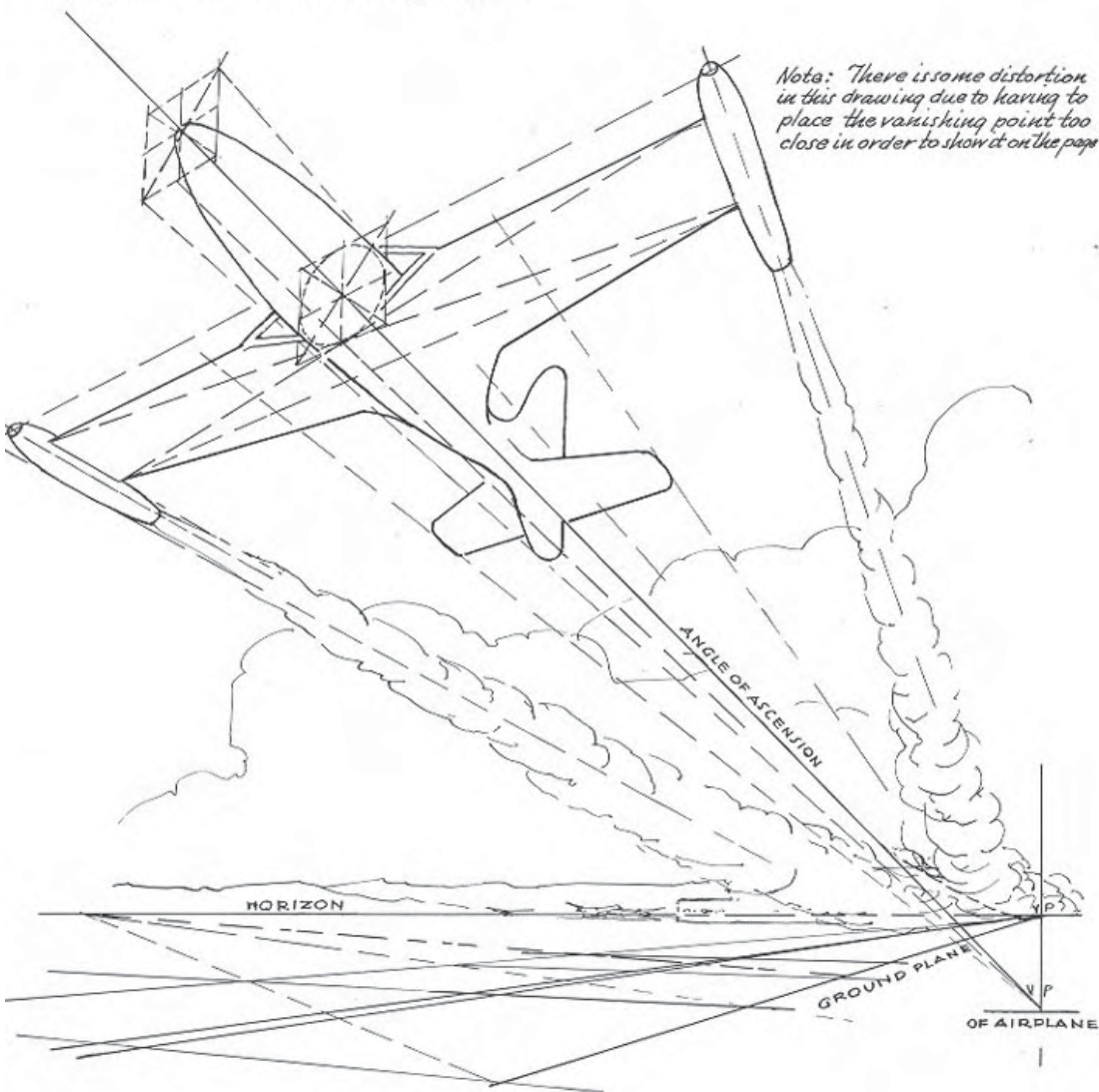

*The airplane is drawn to a vanishing point placed below the horizon. The wings vanish in a point on the horizon since their edges are parallel to the ground plane.*



## PROJECTING A SOLID TO ANY POINT ON THE GROUND PLANE

Since any object can be constructed within a block, the method shown on this page will enable you to duplicate any object for placement at any other spot on the ground plane. The por-

tions will be correct according to position and distance from the first object. The plan is to draw the block first and then the object within the block.

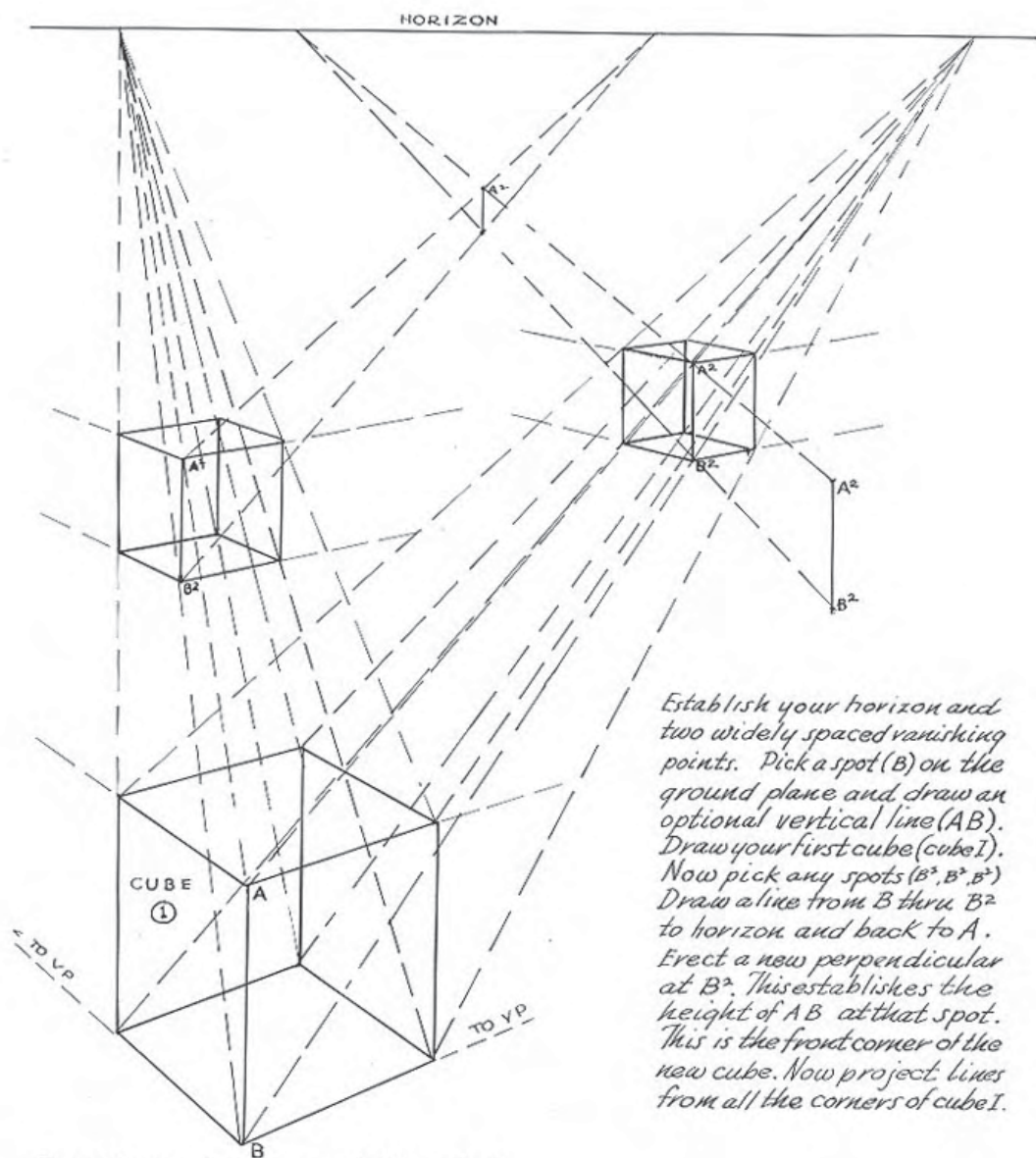

*Establish your horizon and two widely spaced vanishing points. Pick a spot (B) on the ground plane and draw an optional vertical line (AB). Draw your first cube (cube 1). Now pick any spots (B², B², B²). Draw a line from B thru B² to horizon and back to A. Erect a new perpendicular at B². This establishes the height of AB at that spot. This is the front corner of the new cube. Now project lines from all the corners of cube 1.*

*Draw all cubes to the same right and left vanishing points (not shown on this page).*

## PROJECTION OF FIGURES

Any vertical measurement, including the height of a figure, can be projected to any point in the picture. If the measurement or figure is to be shown on a plane higher than the ground plane, it must be elevated to that plane. This is done

by projecting the measurement (A and B) to a spot against the elevation and lifting that measurement to the elevated plane above. Use a pair of dividers to lift the measurement.

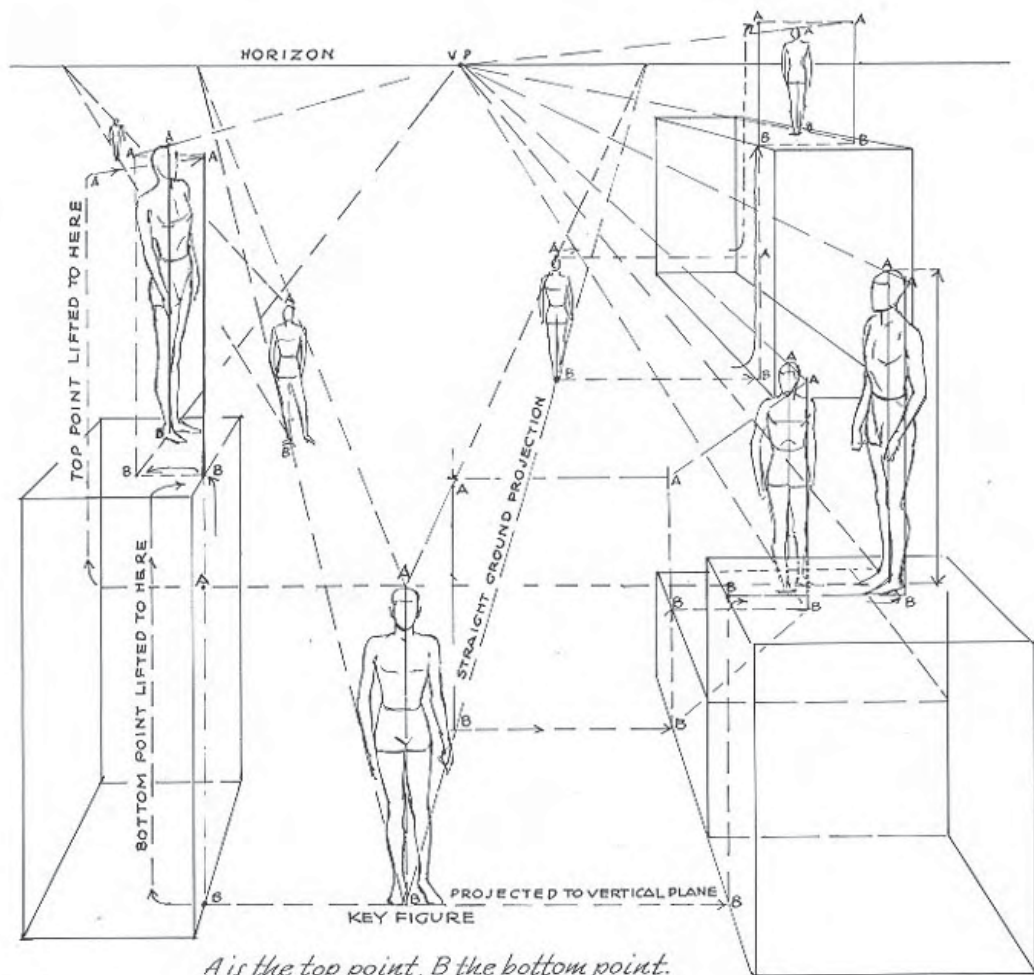

*Author's Note:* Especial attention should be given to this page, because the principles of projecting measurements as applied here are of extreme value to every illustrator or commercial artist.

The following page shows how the principles apply to subjects in which the figures are at different levels. Figures must be in correct proportion to one another.

## PROJECTION OF MEASUREMENTS

Everything in a picture has a relative size according to its position in perspective. In the drawing below, the height of the boy (1) has been projected to several positions. Although

this drawing was made without models or copy, the relative sizes of figures and other units are convincing because the perspective is correct. Study this carefully.

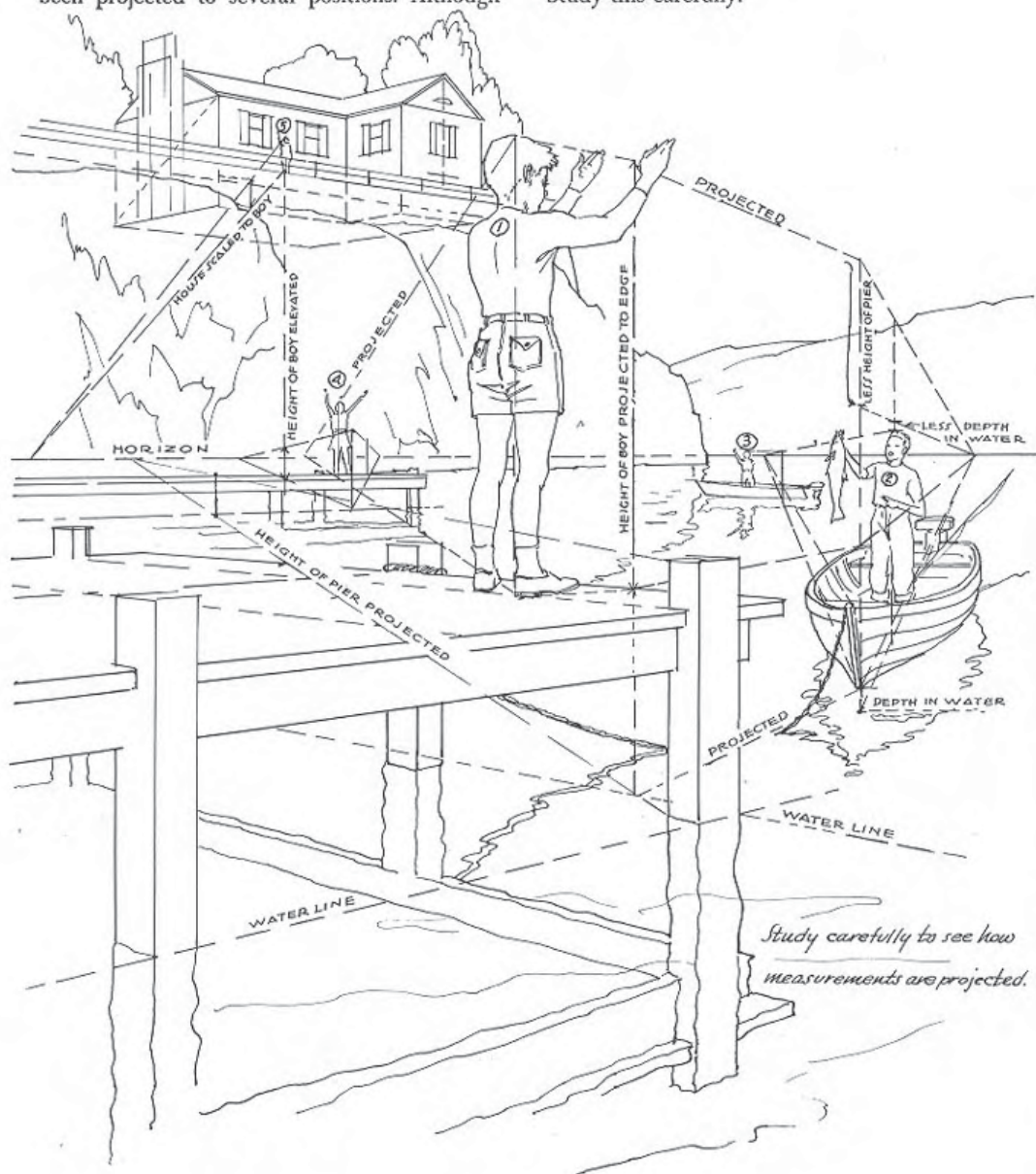

## PERSPECTIVE IN THE FIGURE

No matter how much you know of anatomy and the construction of the figure, you will not be able to draw figures from imagination until you can relate the different parts of the figure to a

horizon or eye level. Sometimes it is helpful to think of the various forms as they would appear as blocks — square instead of round. Then round them out.

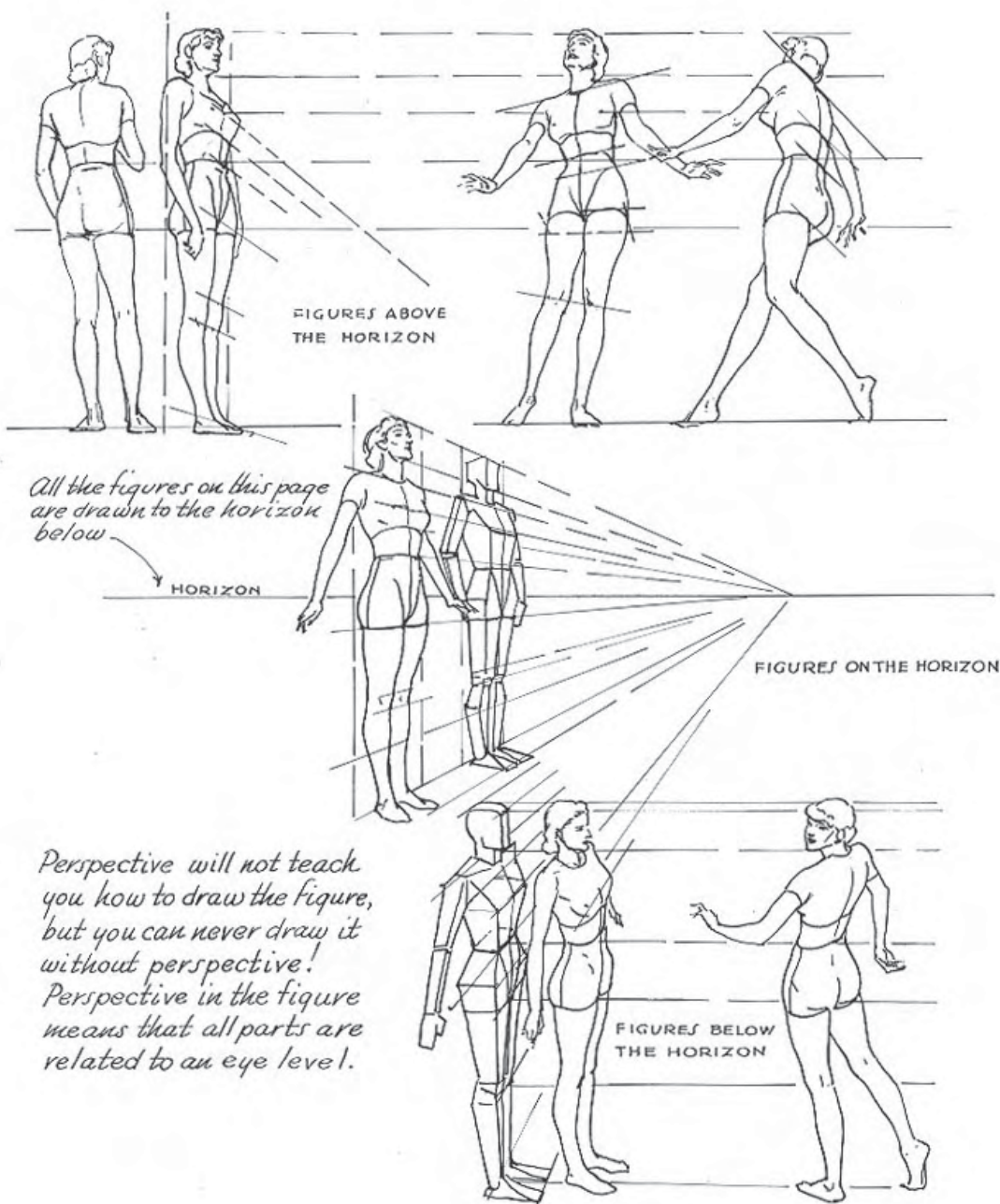





## PROJECTION OF FIGURES

One of the simplest and yet least observed rules of perspective is that all figures on the same ground plane must be related in size. To be sure of the correct relation, establish the height of a

"key" figure and scale all others from that height. To do this, draw a line from the feet of one figure under the feet of another to the horizon. Then carry a line back to the first figure.

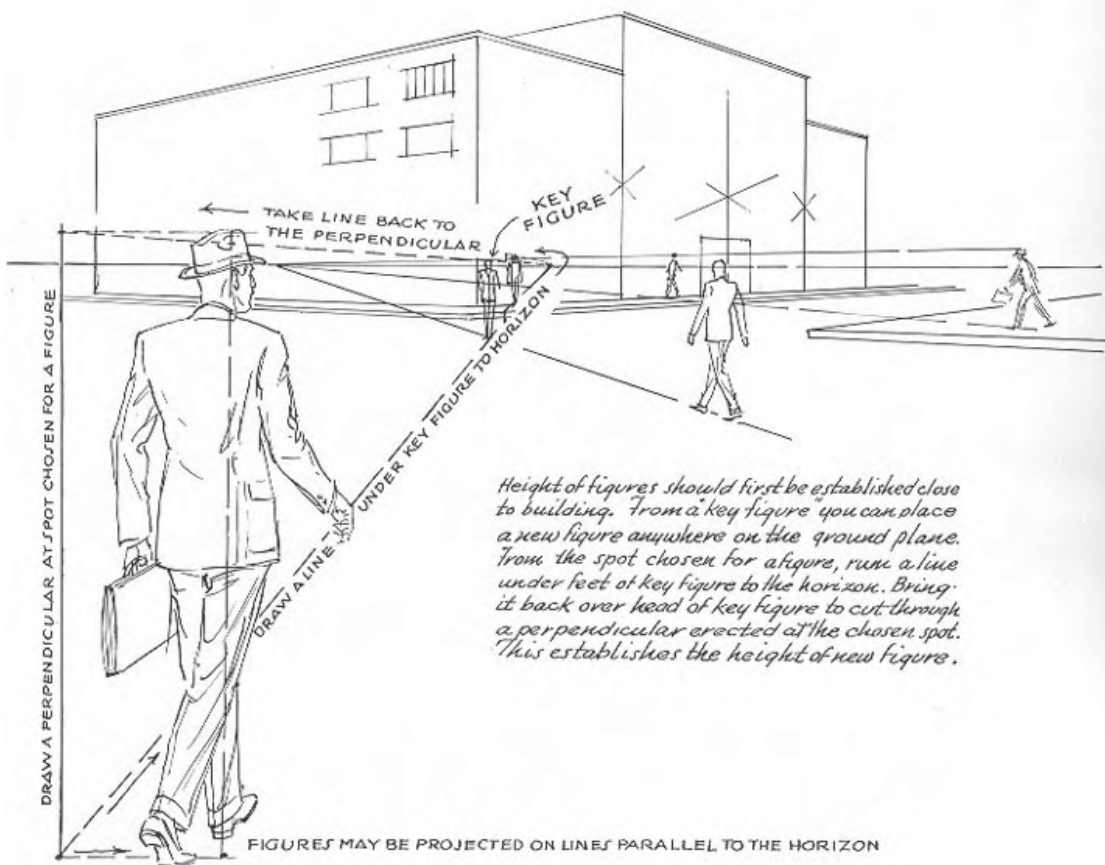

*Height of figures should first be established close to building. From a key figure you can place a new figure anywhere on the ground plane. From the spot chosen for a figure, run a line under feet of key figure to the horizon. Bring it back over head of key figure to cut through a perpendicular erected at the chosen spot. This establishes the height of new figures.*

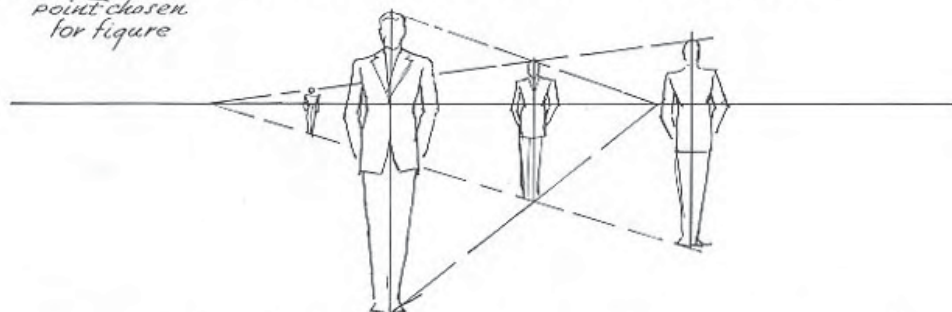

### *The Rule for Scaling Figures on the Ground Plane*

All figures of the same height, when standing on the same ground plane, will be crossed by

the horizon at the same vertical point on the figure.



## PROJECTION OF FIGURES

When it is so easy to scale a figure to any spot on the ground plane, such errors as those shown below are unforgivable. If the feet of a figure do not show, any portion of a figure may be pro-

jected, as, for example, the head and shoulders of the man in the drawing below. Remember always to scale your figures. Don't guess — you can't.

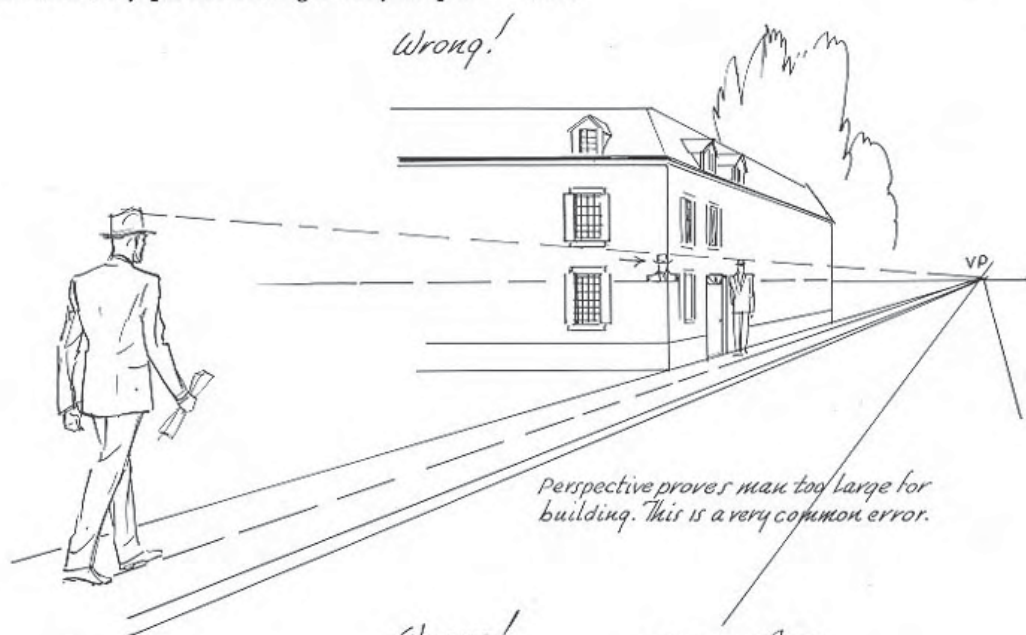

## FIGURES ON INCLINED PLANES

When we know that an inclined plane has a horizon and vanishing points which are used in the same manner as those of a level plane, scaling figures on an inclined plane becomes much

simpler. So long as the entire plane has the same slant, the perspective is worked out in the manner shown in the diagram below. The diagram shows all the necessary vanishing points.

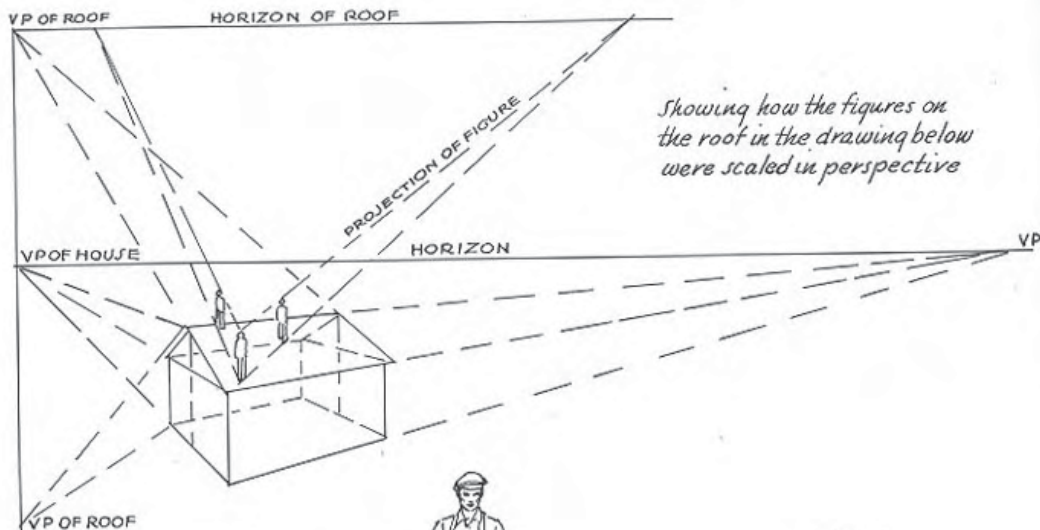

*Showing how the figures on the roof in the drawing below were scaled in perspective*

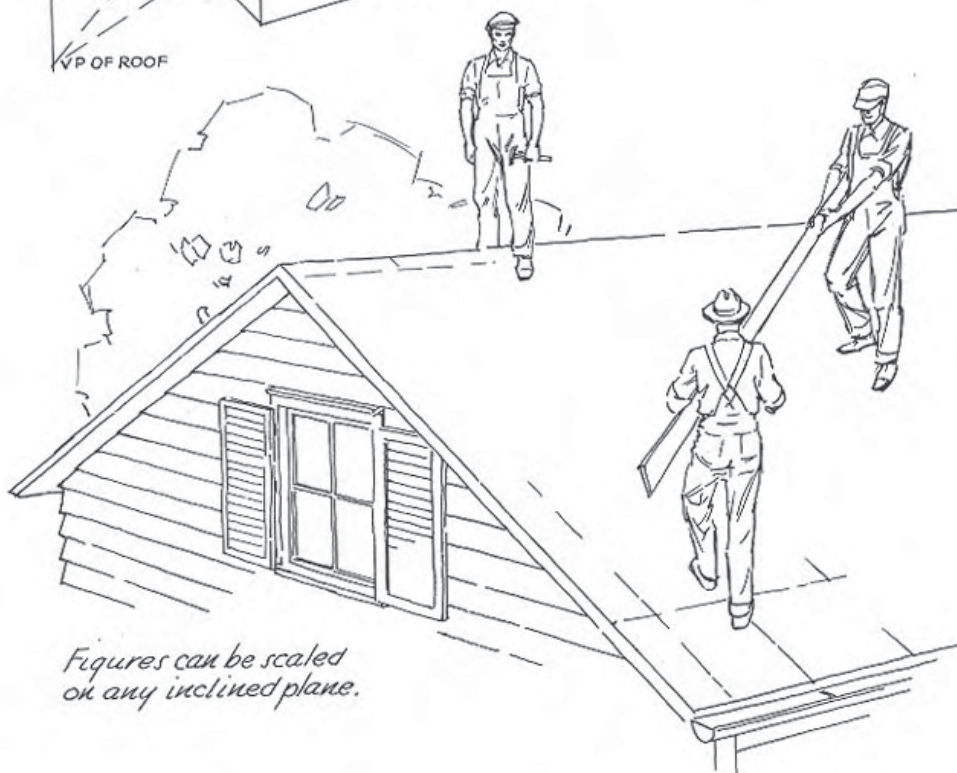

*Figures can be scaled on any inclined plane.*

## FIGURES ON INCLINED PLANES

The projection of figures on hillsides can be very puzzling if the principle is not understood. The drawing below offers a simple solution. Whenever the plane changes as it goes around

the hill, we draw to a new horizon. To keep only one horizon would continue the same plane at the same incline to infinity.

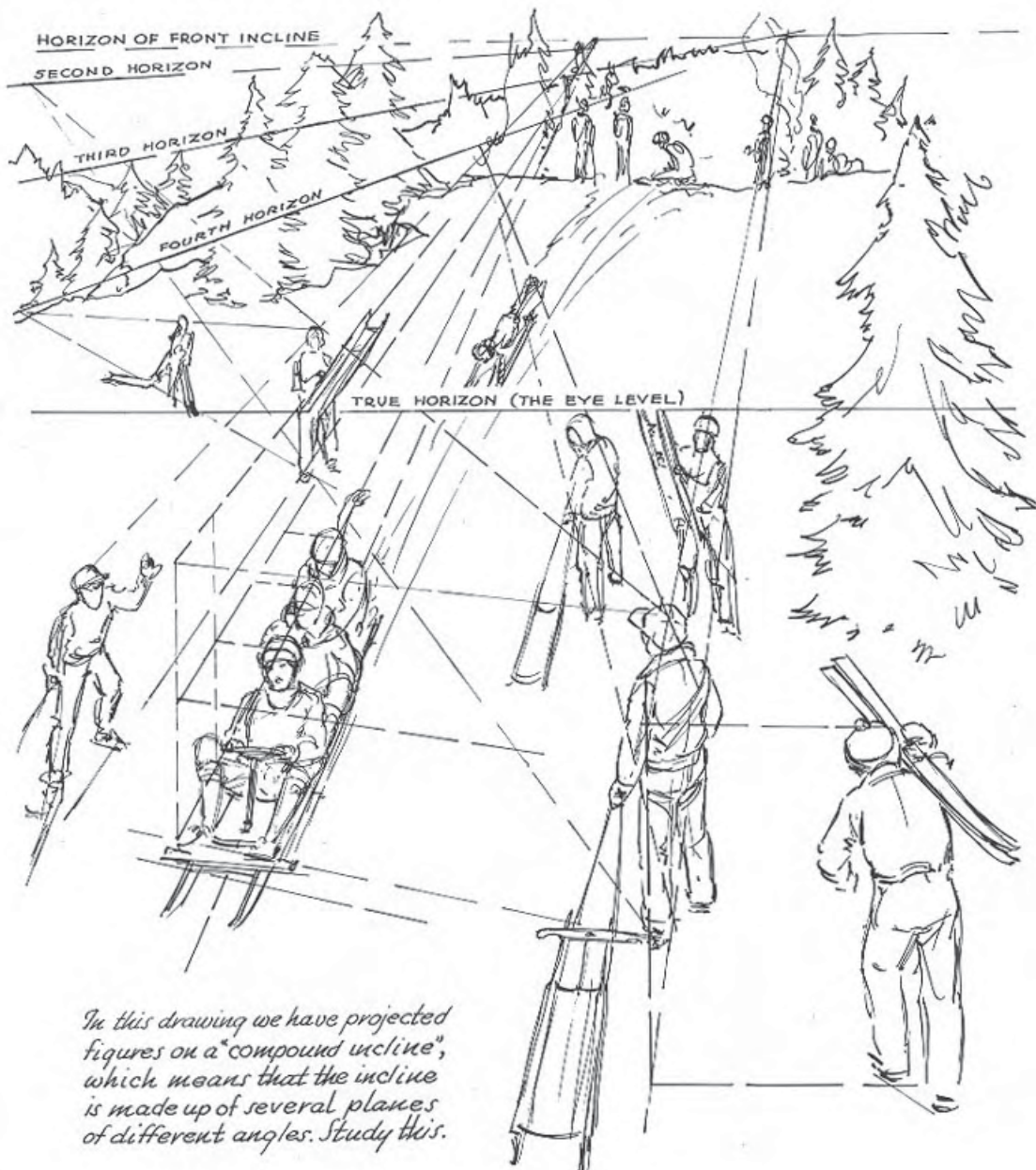



## REFLECTION

Many artists do not realize that a reflection does not duplicate the perspective of the original. The perspective of the reflection is that which the actual object would have if it were inverted

and placed in the position of the image. Though the proportions are duplicated, the actual drawing is quite different.

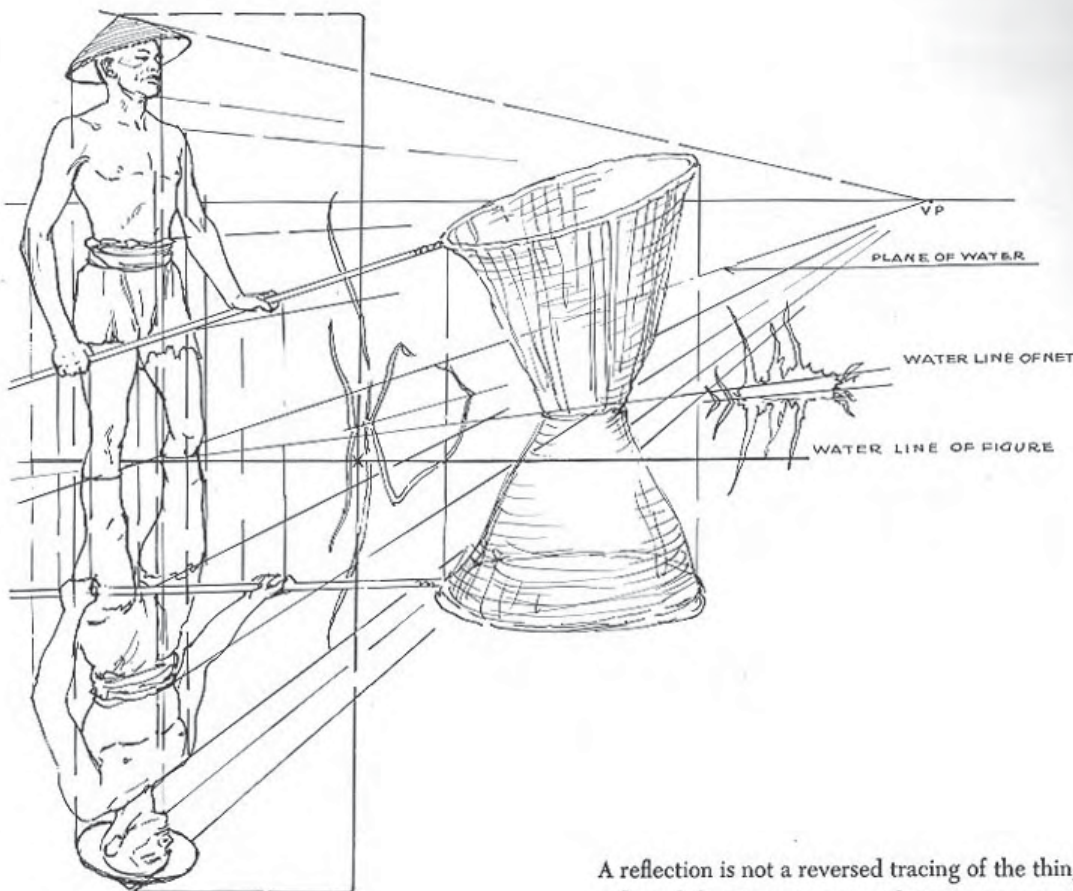

*Depth of reflection is equal to height of figure above water*

A reflection is not a reversed tracing of the thing reflected, but is an image with its own perspective. If you turn the drawing around, the difference in the angle of view becomes apparent. The figure and its image attach at the water line. All points of the figure must be projected down to a similar point on the image, which is directly below. Both the figure and its reflection are drawn to one vanishing point on the horizon. Any movement of the water affects the reflection.







## COMMON ERRORS IN PERSPECTIVE

Distortion results from having both vanishing points within the field of vision, or too close to the object. If the object has a right angle at the near corner, the base lines must make an angle

greater than a right angle on the drawing, since a right angle can not be represented by anything less than a right angle. The drawing below shows this common error.

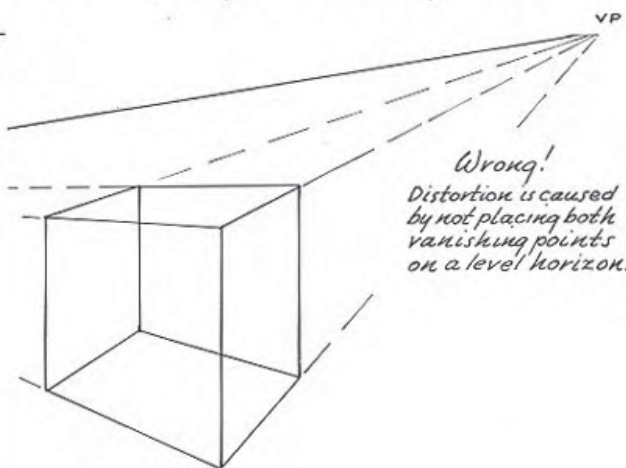
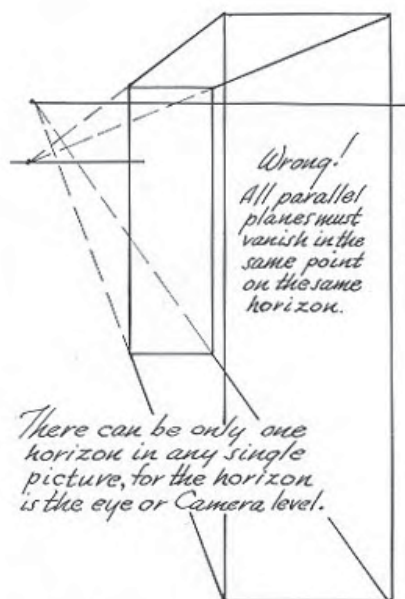
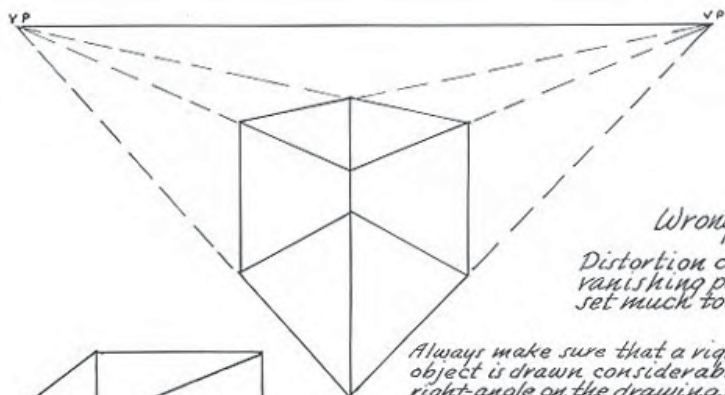

*This shows too much of the side for single Point Perspective.*

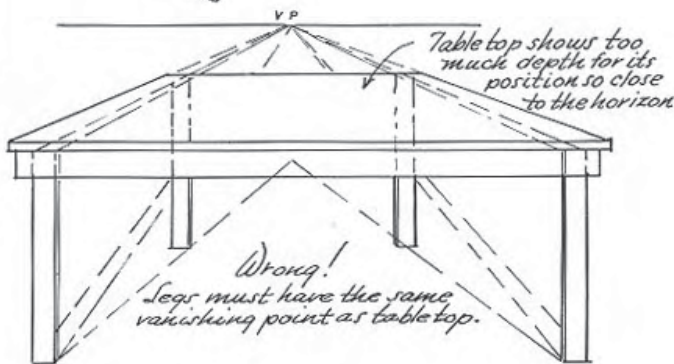
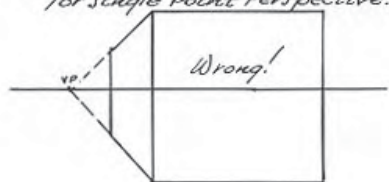



## COMMON ERRORS IN PERSPECTIVE

Too few artists follow the simple plan of projecting figures to a horizon and a vanishing point. In perspective, figures are no different from fence-posts and no harder to scale correctly. It is easy

to scale any vertical unit or measurement to a horizon, but the failure to do so occurs again and again in otherwise good work.



*Wrong!*  
These men could not be standing on the same Ground Plane.

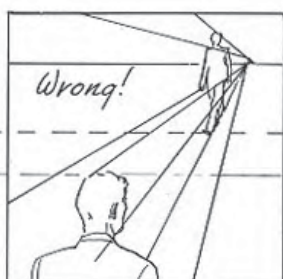

*Wrong!*  
Perspective proves him to be standing in a hole!



*Wrong!*  
The back figure would tower over him in reaching this spot.  
To correct: Make sure that the horizon crosses all similar figures on the same ground plane at the same vertical height on each figure.

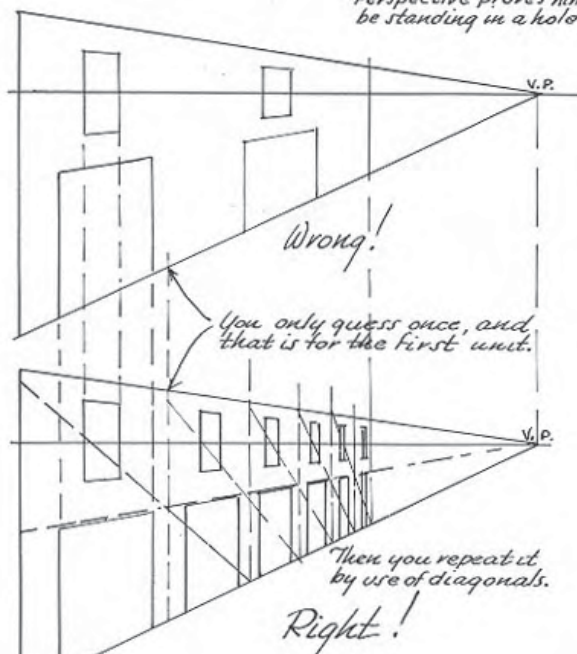

The most common error of all is "guessing at perspective depths." This immediately stamps an artist as a novice and ignorant of the basic principles of good drawing. At the left we have taken the first door and window as a unit and, by the use of diagonals, proved that the drawing above would have enough depth to repeat the unit six times! Until the artist knows how to measure depth, it is quite impossible for him to produce a correct three-dimensional effect.

The error below is in stretching Single Point Perspective too far. If the unit at the right is a cube, we have taken too much depth.



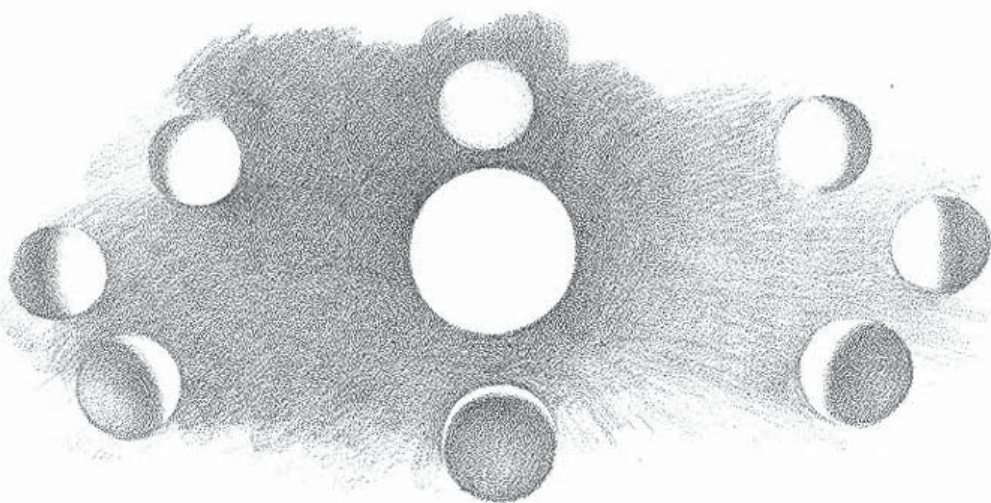
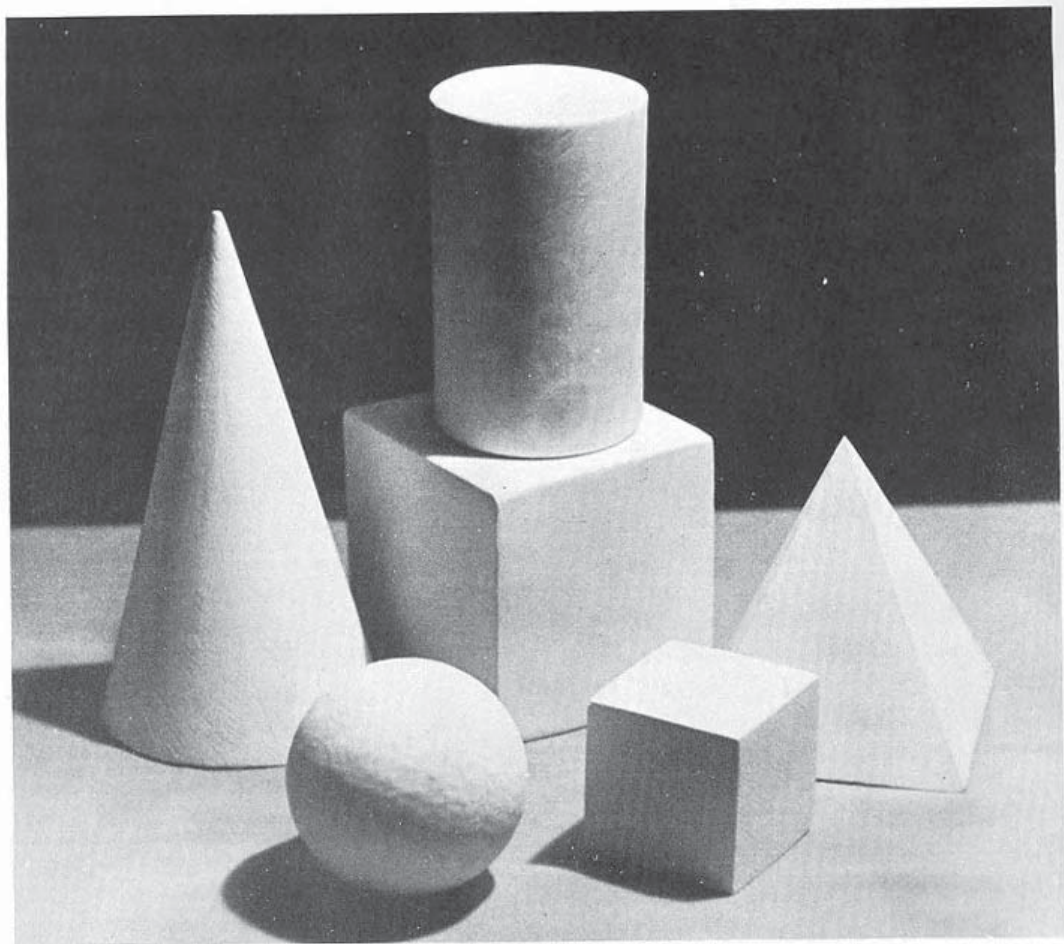

# Light on the Basic Forms

When the artist leaves the study of line and seeks to combine light and shadow, construction and contour, he steps into a new world. His drawings begin to take on a quality of existence, for through light and shadow we delineate form, and all the visible world is only light on form.

But nature, until her ways and laws are understood, can seem so complex as to be almost overpowering. Usually her forms are surfaced with endless variations of texture, and the relationship of her forms, as well as of man-made forms, to basic form is not always evident. So some simple plan must be devised to help us understand the complexities before us.

As an approach, we must simplify both light and form. The basic forms start us on the way, since they do not have confusing surface irregularities or changes of color or texture. They are a simple white, with a smooth surface, thus allowing us to look at the effect of light uninfluenced by other factors.

There is no better place to start than with the sphere, which seems to be the basic form of the universe. With the sun lighting our universe, the spheres of all the planets are always half in light and half in shadow, but because the planets are rotating on their axes, any single spot on these spheres moves from light, into shadow, and back into the light, in the course of a single revolution. Since the light on a sphere merges into the shadow through gradually darkening halftone, the rotation of the sphere of our earth produces the gradual darkening of the daylight which we know as twilight and evening. At night we have reached the shadow side where the parallel rays of the sun can no longer reach us. At noon we are in the middle of the lighted area, and at midnight we are in the middle of the shadow area.

These facts are the basis of all the light and shadow that we shall ever draw. On a lighted sphere there is a highest point of light, where

the surface is nearly flat or at right angles to the source of light. That part collects more light rays than any other. This we call the highlight. It is always at the shortest distance from the surface of the form to the light source. As the surface turns away from the source, it collects fewer rays and this causes halftone. The edge of the shadow then begins where the light rays are at a tangent to the surface of the sphere. Therefore, if we have an established direction of the source of light, we can approximate where the shadow begins on any rounded or spherical form. It is always at the halfway mark around the form.

The first basic law of light then is: *The light from any single source must travel in a straight line, and therefore cannot reach more than halfway around any round form.*

The next law follows from the first: *Any surface is lighted according to the angle of its surface in relation to the direction of the light source.* The brightest planes then are either flat or at right angles to the light. With every increase in the curve away from the perpendicular to the light source, the value of the plane darkens until it reaches the maximum darkness, which is at and just beyond the edge of the shadow.

The next law follows in orderly sequence: *Only a flat plane can be evenly lighted in the same value, since curving and rounded planes always produce the effect of graduated tones of halftone.* Here then lies the secret of rendering light on form. The flat areas are flat in tone or value. The rounded areas are modeled in graduated tones. The way we treat the area shows the observer roundness or flatness, and thus establishes the identity of the form.

*The sphere or egg is the only form without flatness. The cube or block is without roundness. Therefore the sphere or like forms can be rendered only in graduated tones, and the cube or block only in flat tones. All forms are composed*

## LIGHT ON THE BASIC FORMS

*either of flat planes or rounded surfaces, or a combination of the two.*

Now let us think of shadow. When a surface dips so that a ruler laid on the plane cannot point at the light source, that area must be indicated as in shadow. That is why there can be shadows between lighted areas, as in the folds of drapery. In fact, any depression or indentation identifies itself with halftone or shadow. Any protuberance on the surface has lighter value on the sides facing the light and halftone on the other sides, and, if it is high enough, casts a shadow on the surface.

Getting back to the sphere, let us look carefully at the shadow side. We find that the darkest part of the shadow occurs near the edge of the light. The shadow can be a flat tone only if there is no reflected light. This is the way we see the half-moon. There is nothing to light up the shadow. However, since everything in the light also reflects it, the shadows we see have usually taken on some of the reflected light of lighted planes nearby, and therefore the tones within the shadow are somewhat lighter than its edges. This darker edge of a shadow on a rounded form is what illustrators call "the hump." Being darker, it tends to accentuate the brilliancy of the lighted areas next to it, and also to give airiness and luminosity to the shadow areas. This "hump" occurs only when the initial light has been reflected back on the object. Unless the reflected light is thrown directly back at the light source, this darker edge disappears, since it is caused by the fact that neither the light nor the reflected light can fall on the angle of the plane or surface at that point. To get this beautiful effect photographically, the fill-in light should be pointed directly at the main light source, and be of not more than half its intensity. *This is the secret of preparing good photographic copy from which to draw.*

Since any object may be moved about in relation to the light source, and we may look at the object from any viewpoint, we can see light and shadow in any proportion on the object. If we

are looking at the light source, we see any object between us and the source in full shadow, for we are on the shadow side. If the light source is directly behind us or between us and the object, we see the object in full light without shadow. This is the effect we get in photographs with a flash bulb at the camera. A drawing under those conditions would be composed only of light and halftone, with the darkest darks at the edges or contours. If the object is placed at right angles to our position and to the light source, it is seen as half in light and half in shadow. If placed in one of the quarter positions it is either three-quarters in light and one-quarter in shadow, or the reverse.

Understanding these facts, we can draw a sphere as if it were lighted from any direction we choose. By turning the drawing on end we can get the effect of the light source being above or below the spheres. Incidentally, the quarter lightings are usually more satisfactory pictorially than half light and half shadow. Having either light or shadow dominate is more effective than an equal division between them. The full-front lighting is very good for simple or postery effects. It is used a great deal by Norman Rockwell, among others.

The use of two light sources tends to break down the solidity of the form. Crisscross lighting — light sources at both the right and the left of the artist — is especially bad because it breaks up everything into small lights and shadows. Outdoor sunlight or daylight is the perfect light for drawing or painting.

The sphere in light and its cast shadow on the ground plane are shown on page 81. The central ray of light is a line passing through the center of the sphere from the light source. The point at which this line hits the ground plane is the center of the cast shadow, which is always seen as an ellipse.

Spheres A and B on page 82 show the very important difference between the effects of direct light with its cast shadow and of diffused light with its diffused shadow. In sphere A, the



## LIGHT ON THE SPHERE

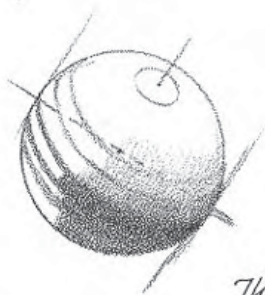
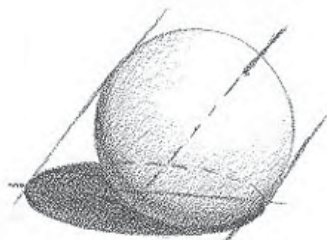
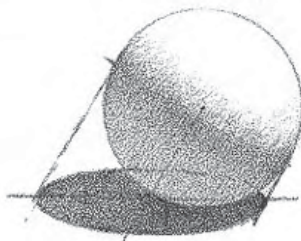

*Think of the values as occurring in bands.*

*Note the band of darker shadow that appears between the halftone of the light and the reflected light within the shadow. The cast shadow on the ground plane starts from this band*

# SHADOW FROM A SPHERE IN PERSPECTIVE

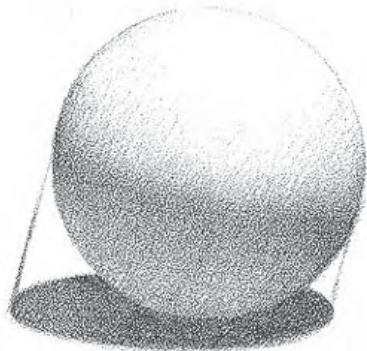

A

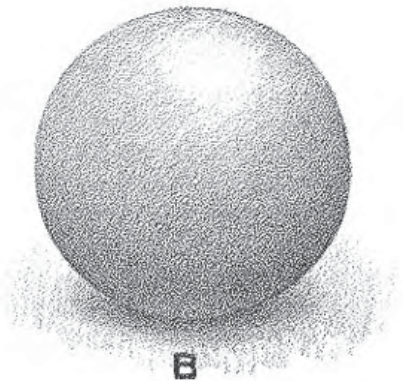

B

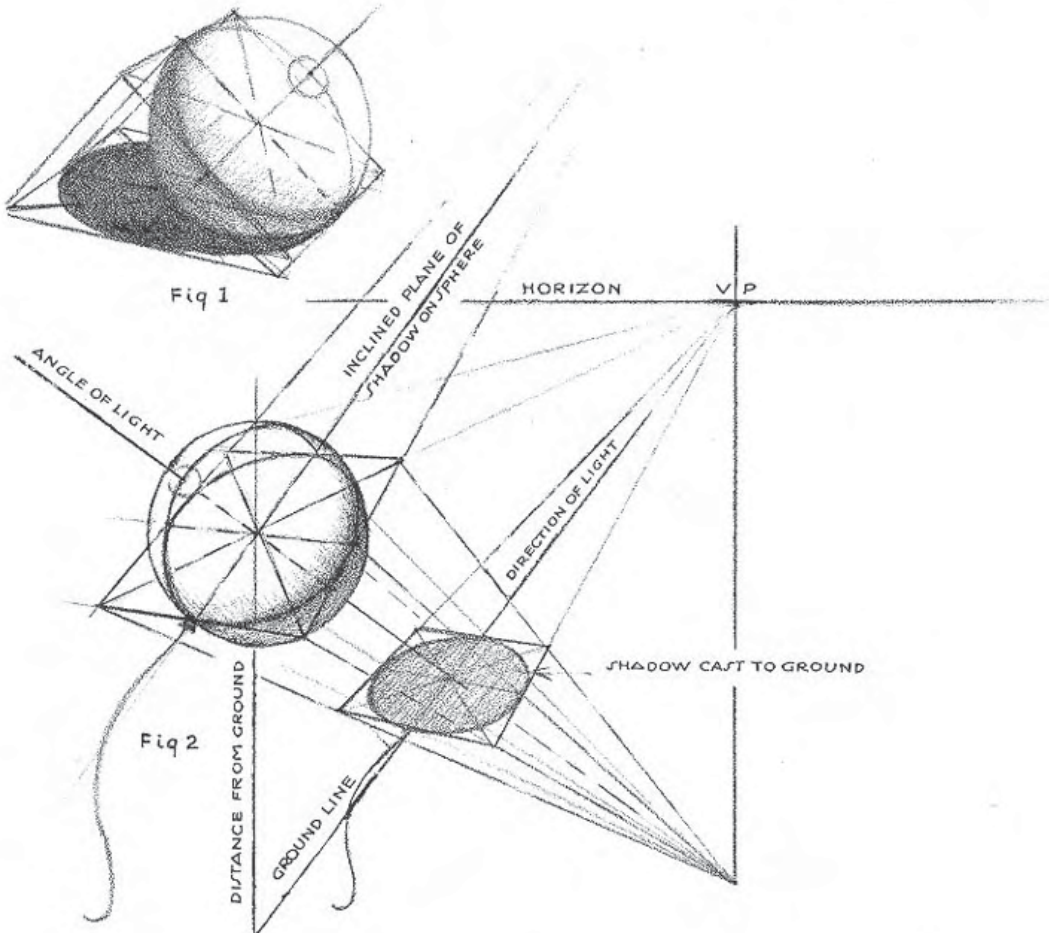

## LIGHT ON THE BASIC FORMS

light and shadow are sharply defined and positive. On sphere B, the modeling is very gradual with no sharp definition. The lighting on A is characteristic of sunlight or direct artificial light; that on B of light from the sky without direct sunlight on the object, or of the popular indirect or diffused lighting.

The difference in these effects must be taken into consideration by the artist. The whole picture should have the effect of one or the other. If one thing casts a shadow, all things must cast shadows. If one shadow is soft and diffused, all other shadows must receive the same treatment. Otherwise consistency is lost. When the effect of a drawing is bad this may be the reason.

Figure 1 on page 82 shows the ellipses of the form shadow and the cast shadow on the ground plane. Note the central ray through the middle of the ball to the middle of the cast shadow. The ellipses are drawn in perspective. Figure 2 shows how a shadow may be projected to the ground plane when a sphere is in midair.

Cast shadows of course require perspective, which many artists fail to state correctly. With any cast shadow we have three things to consider: first, the position of the light source; second, the angle of light; and, third, the vanishing point of the shadow on the horizon. If the light source is behind us, we get the angle of light from a point placed below the horizon on a perpendicular line dropped down through the vanishing point of the shadows. From this point we bring lines up through the ground plane to the object. The shadow is then located on the ground plane by drawing lines from the object to the vanishing point of the shadows. (See Fig. 4, page 84.) When the light source is in front of the object (Fig. 5, page 84), we establish a position of the light source, and, on the horizon directly beneath, a vanishing point for the shadows. We then draw lines from the light source down through the top corners of the cube. Then from the vanishing point of the shadows we draw lines through the bottom corners of the cube. The crossing of these two sets of lines in-

dicates the limits of the shadow on the ground plane. (See also page 85).

The shadow from a cone is simple to execute. Draw the line of the direction of the light through the center of the base. Then divide the ellipse of the base accordingly. From the apex of the cone draw the angle of light to the ground plane. The point at which it meets the line of the direction of light is the point of the shadow. Connect this to the base of the cone at the half-way points of the ellipse (see Fig. 1, page 84). Figures 2 and 3 show the lighting worked out with a different direction shown in Fig. 3.

The effect of looking into the light source with these planes worked out is shown on page 86. Page 87 shows the opposite effect — shadows receding, with the light source at the artist's back. The effect of a suspended artificial light is shown on page 88. Here the perspective principle is reversed, since the shadows vanish at a point on the ground plane directly under the light source. Theoretically they spread out to infinity and have little to do with the picture horizon. This is really a radiating point to give direction to the shadow contours. However, we still have the three necessary points of the triangle formed by the light source, the angle of light, and the direction of the light.

Remember:

*When you are looking into the light—*

The angle of light is the nearest point of the three and is located on the ground plane.

The vanishing point of shadows is on the horizon, directly under the light source.

*When the light is behind you—*

The angle of light is located below the horizon directly beneath the vanishing point of shadows.

The direction of light is the line from the vanishing point of the shadows to the object. The source, not being visible, is not shown, but the angle is used to point backward to the object, and not beyond it.

All points around a contour register as a cast shadow, and you draw those contours on the ground plane within a rectangle (see page 87).



# PERSPECTIVE OF SHADOWS

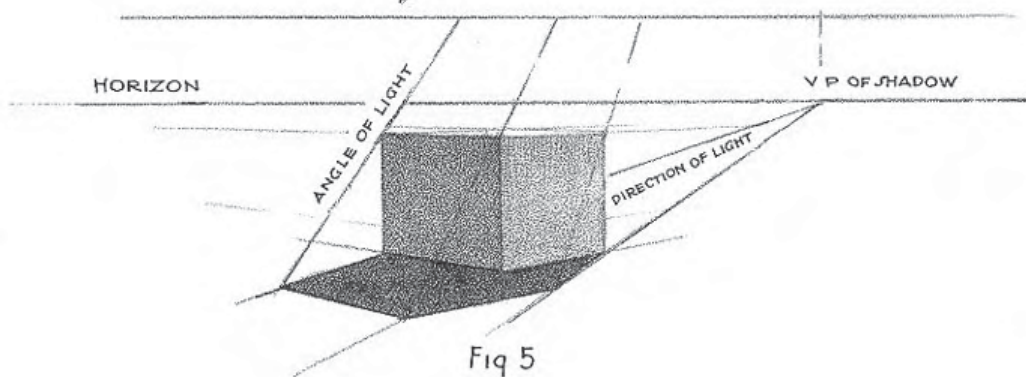
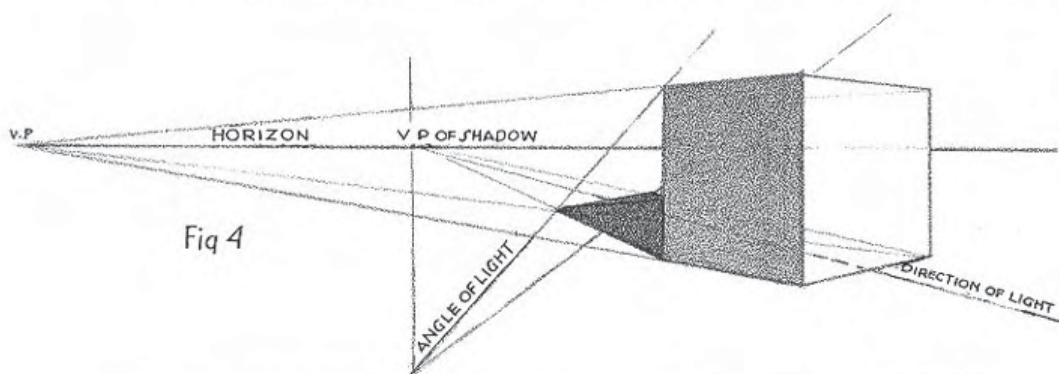
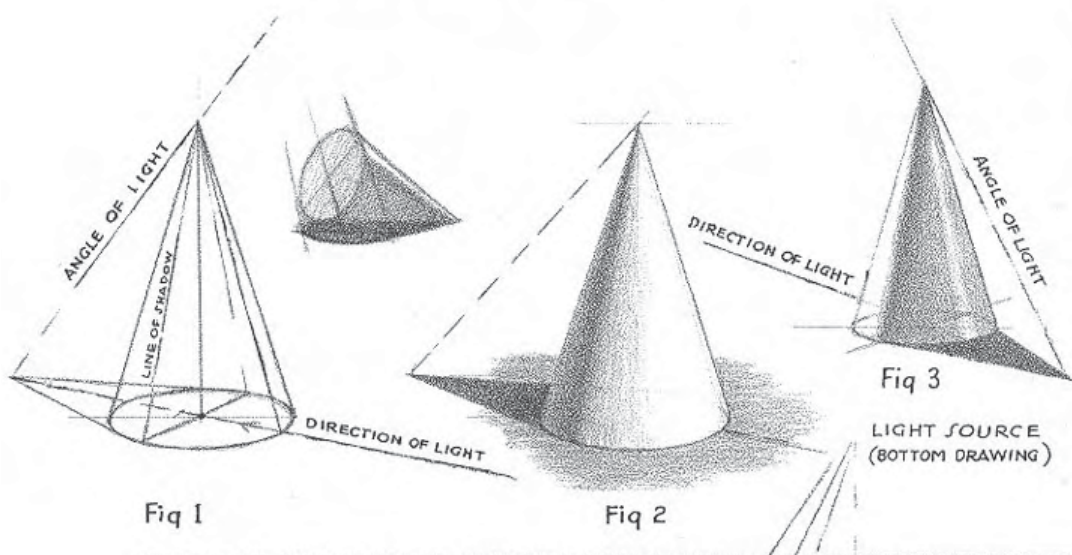

## PERSPECTIVE OF SHADOWS

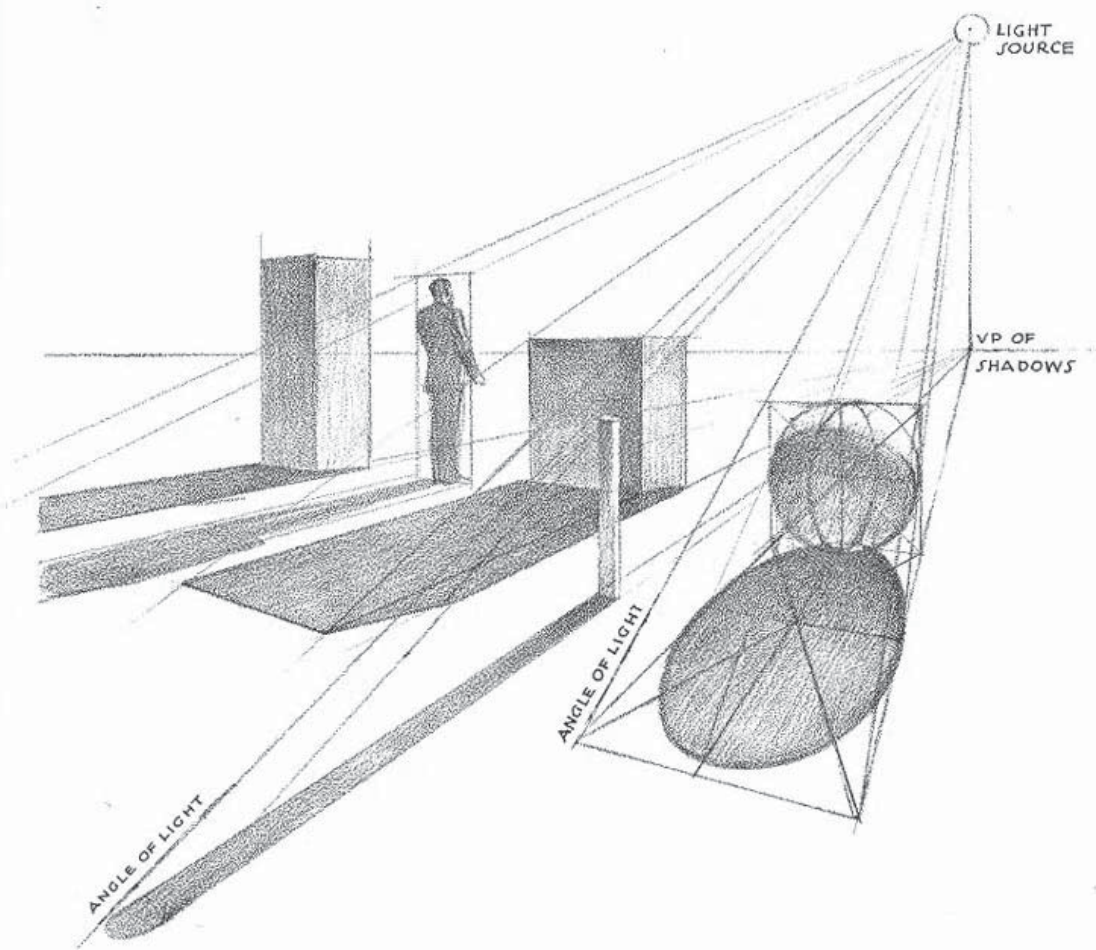

### *Looking into the Light Source*

Note that all shadows recede to the same vanishing point. The vanishing point of shadows falls on the horizon directly below the light

source. By connecting any spot on the ground plane to the light source we get the angle of light at that particular point.

## PERSPECTIVE OF SHADOWS



### *Looking toward the Light Source*

The small drawing at the lower right illustrates the procedure that was followed in the main drawing. The lines from LS (light source) through A, and from VPS (vanishing point of

shadows) through B, meet at the point of C. Thus C is the point of the cast shadow. Always think of a triangle composed of light source, angle of light, and vanishing point.

## PERSPECTIVE OF SHADOWS

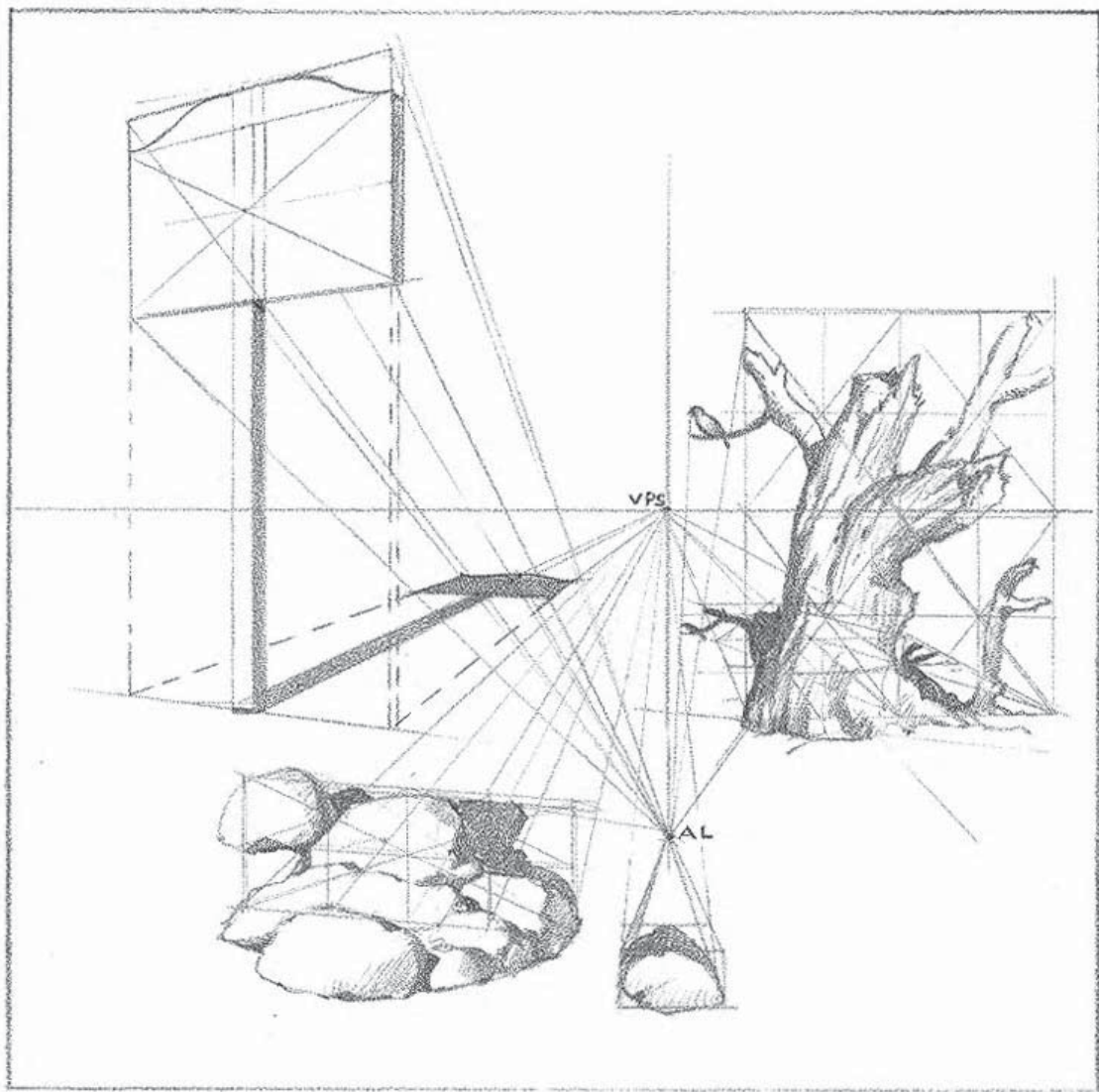

### *Looking away from the Light Source*

The angle of light is determined by lines drawn to a point placed directly below the vanishing point of shadows. Any object may be squared off in the way shown in the picture of the tree at the right above and the squares projected to

the ground plane. If you consider the tree as a flat design in a squared-off block, the contours of the tree are projected to the ground plane. These define the shadow.



## PERSPECTIVE OF SHADOWS

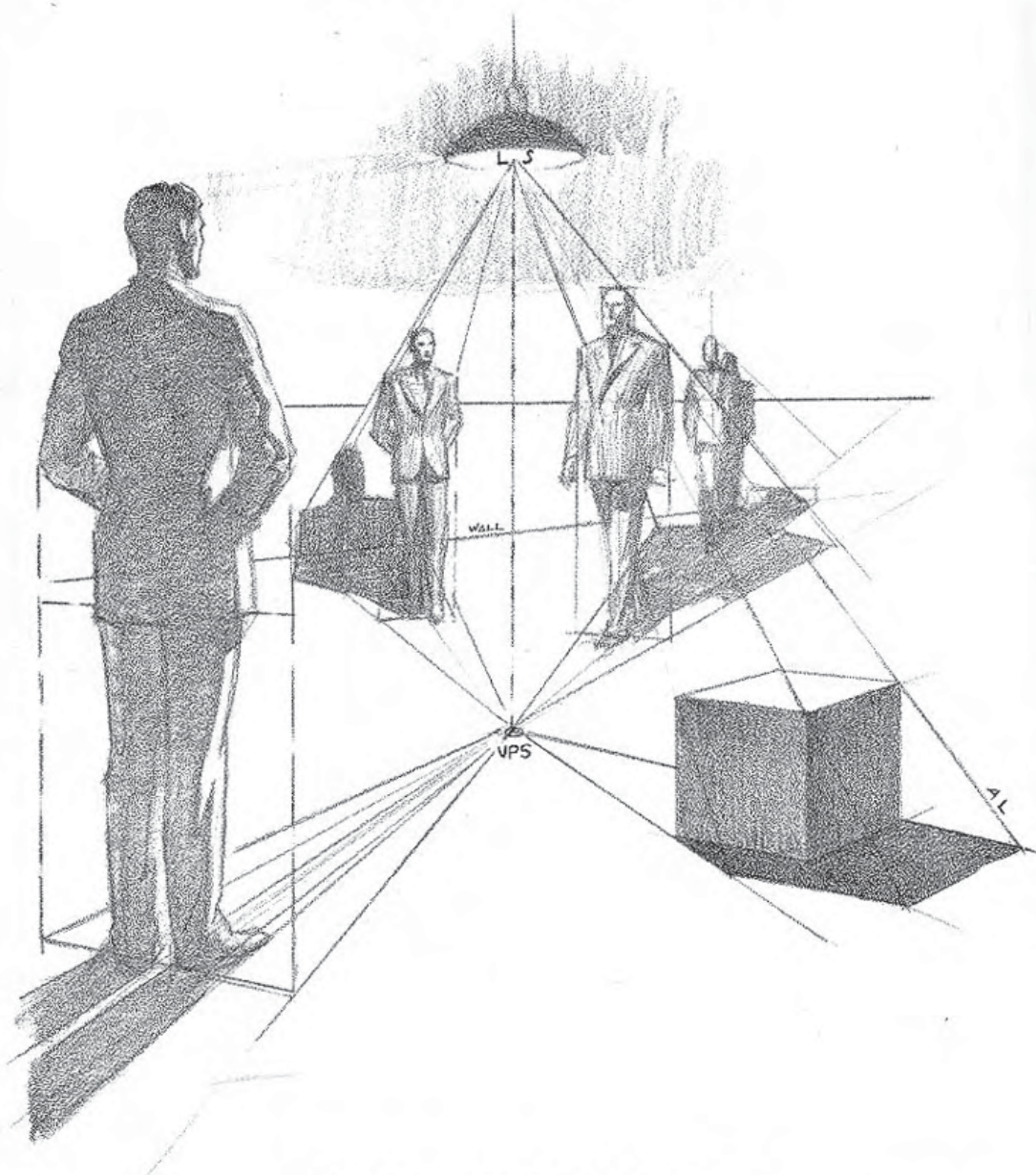

### *Shadows from an Artificial Light Source*

Note that the shadows all radiate from a point on the ground plane directly beneath the light source. This is called the vanishing point of shadows (VPS), even though it is not on the

horizon. Such shadows do not diminish as they recede toward the horizon. Their length on the ground plane is determined by the angle of light.

## Complex Forms in Light

To the layman the rendering of form with light on it seems little short of miraculous. He is likely to talk about your great talent and how lucky you are to have been born with it. The truth is that he is unable to distinguish talent from plain observation and knowledge. He has never really analyzed the way light works on form, though he has learned to recognize and accept the proper effect. When we point out that an indentation causes halftone and shadow, he may shake his head. But let there be the slightest dent in a fender after Junior has used the car, and he will see it as a dent as far as he can see. Any disturbance of a smooth tone is either a smudge of foreign material or a change of some sort in the character of the surface. How quickly a spot on the wall or a fabric is evident! The same sort of thing happens in a drawing.

If we put in a tone of dark where it should not be, the effect is that of a smudge. A light where it does not belong is just as evident. It seems strange to me that some art students will not draw objects as they really look, for they can see the difference between lights and darks as well as anyone else can. The chances are that they are not even looking for the effects of lights, grays, and darks; they must simply feel that they have to fill the space inside the outlines with strokes of some sort. They have seen that drawings are full of strokes, so strokes are their real concern, without much thought of what the strokes are supposed to be accomplishing or representing. The whites on the subjects have no strokes, since we are really leaving the whites as white. The grays have delicate strokes to leave a gray where we see it as gray, and then the darks are put in with gusto and pressure to set off the grays and whites.

The darks and accents really make the drawing, because they are most easily seen. They carry the punch. Any drawing can be reduced to a rendering of halftones and darks only, since

the whites are already present in the white of the paper. So the practice of good drawing, beyond outline construction or contour, is first looking for the areas of light, then seeing the halftones and darks which surround them.

Drawing is really difficult only to those who do not know what to look for. The placement of contours is measurement and nothing else. To find the planes of an object is to watch the angle of the surface form as it changes, and then to record the tone or value caused by that change or angle. The drawings on page 90 show how easily the effect of form and surface and even of the material itself is defined by simply putting down the grays and darks as they appear. In these drawings we are hardly conscious of pencil strokes or mannerisms, only of the use of a pencil to render the effect as seen.

After awhile you learn to recognize characteristic effects, and they become much easier to set down. The student should start by setting up a subject in a good light and studying the effects. Begin with things that are simple in form and not too complex in texture. Take a piece of broken stone and try to draw it. Take some dishes or pottery, a ball, or a box, or any simple object, and draw for the effects of lights, grays, and darks. Later, try something that has drapery — even the youngster's doll. Or drape a piece of material over something and try to draw the folds. Crumpled paper is the best example of planes in light, halftone, and shadow.

Outlines should not be dark and heavy all around, but light where the inside tone is light and dark where the darks are. In fact, in some of the best drawings we are hardly conscious of outlines at all, the stress being laid on the tones and shapes inside the outlines. Almost every light area has a definite shape, then the halftones have shapes, and finally the darks have shapes. They must be fitted together. Some shapes have defined edges, others have soft edges.



## COMPLEX FORMS IN LIGHT

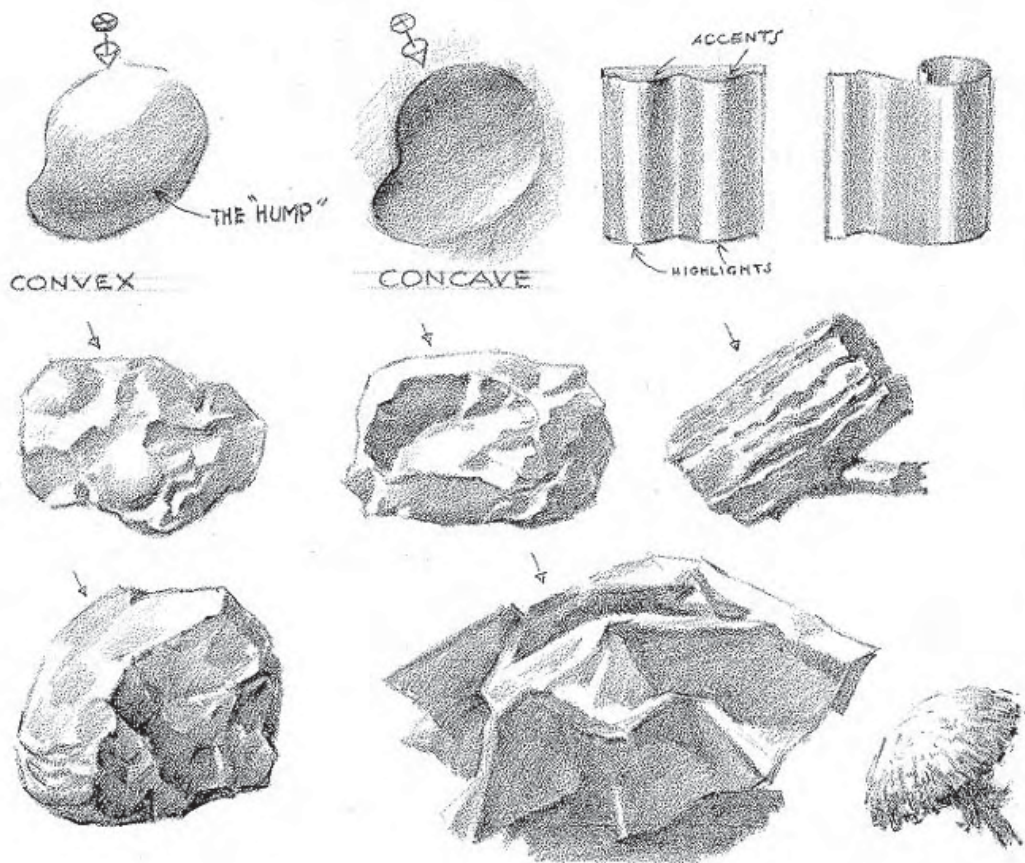

Careful study of this page will reveal the fact that any type of surface form can be rendered by duplicating the effect of light and shadow as they occur across that form. Every material or surface has a characteristic effect at any given moment. Every effect is made up of light, half-tone, and shadow. If we study the subject and

can define those elements clearly and can then fit them properly within the contours, we will have re-created the form and also the effect of the material of which it is composed. In the drawings above, arrows indicate the direction of the light. Set up a number of subjects composed of a variety of materials and render the effects.



# PLANES

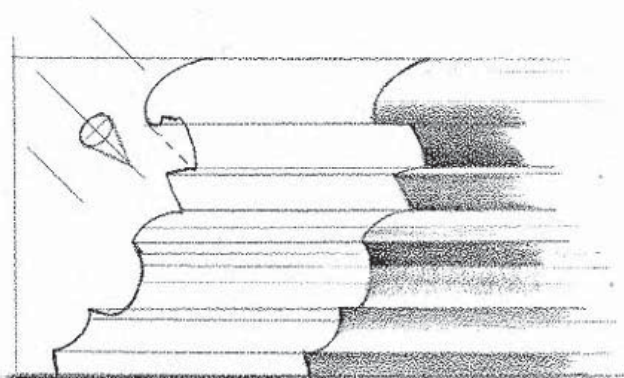
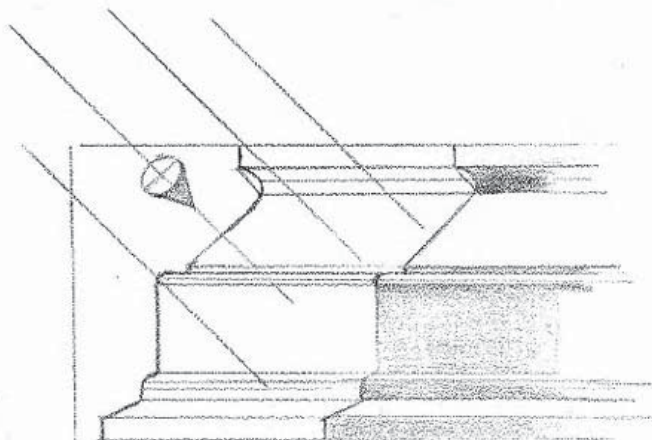
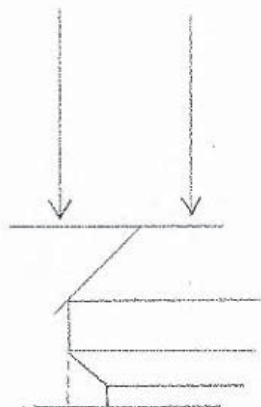
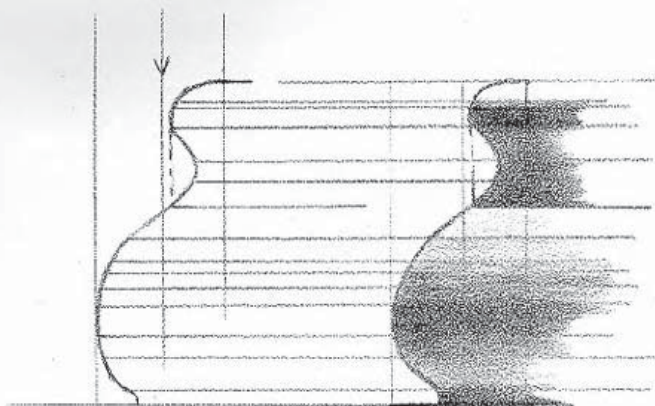

## PLANES

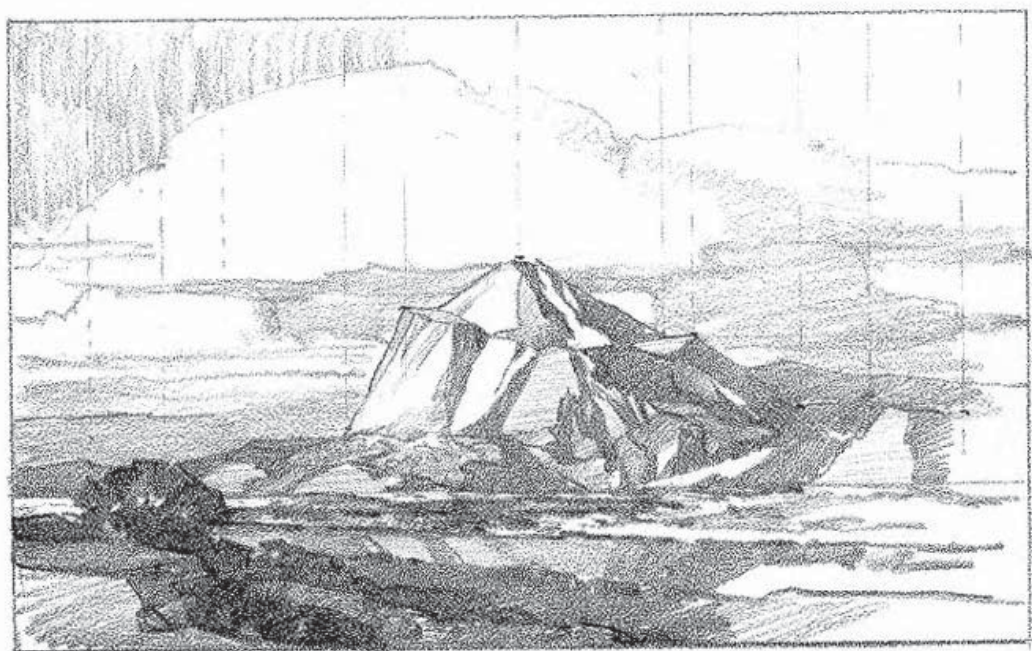
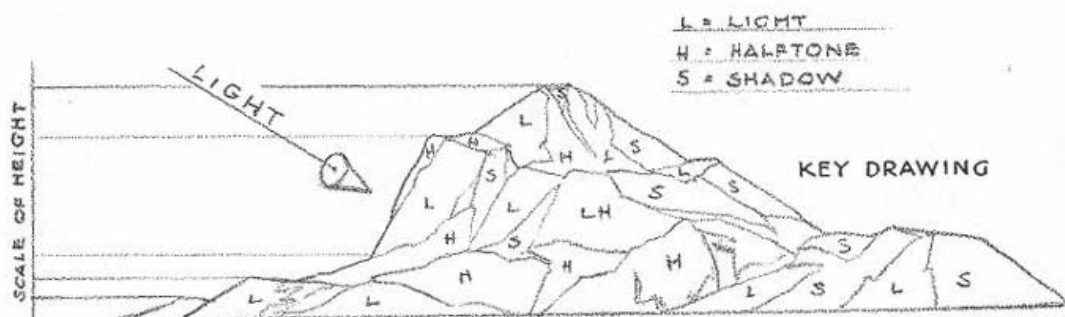

### *Changing Light on Complex Planes*

A subject like the one shown above cannot be drawn or painted convincingly without a study of the light on its planes. The camera can give only the intricate superficial effects. We must always search for the broader planes upon which this confusing detail lies. Since light changes so

rapidly, it is often practical to make a quick key drawing like the one at the top of the page, to record the main planes of light, halftone, and shadow. This gives a basis for building the solid effects later.





## PLANES



*A face is drawn as any other surface is drawn by following the angles of the surface and with each change of plane, noting the change of value.*

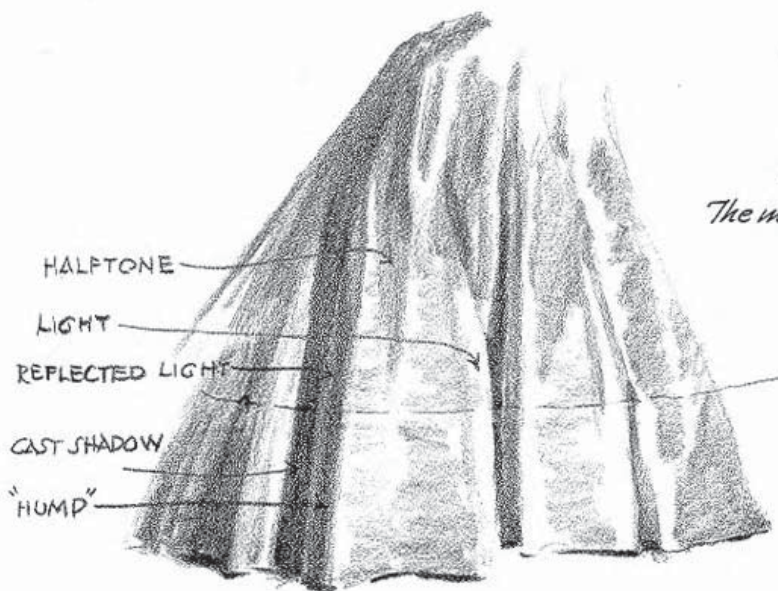

*Drapery  
The method is the same.*

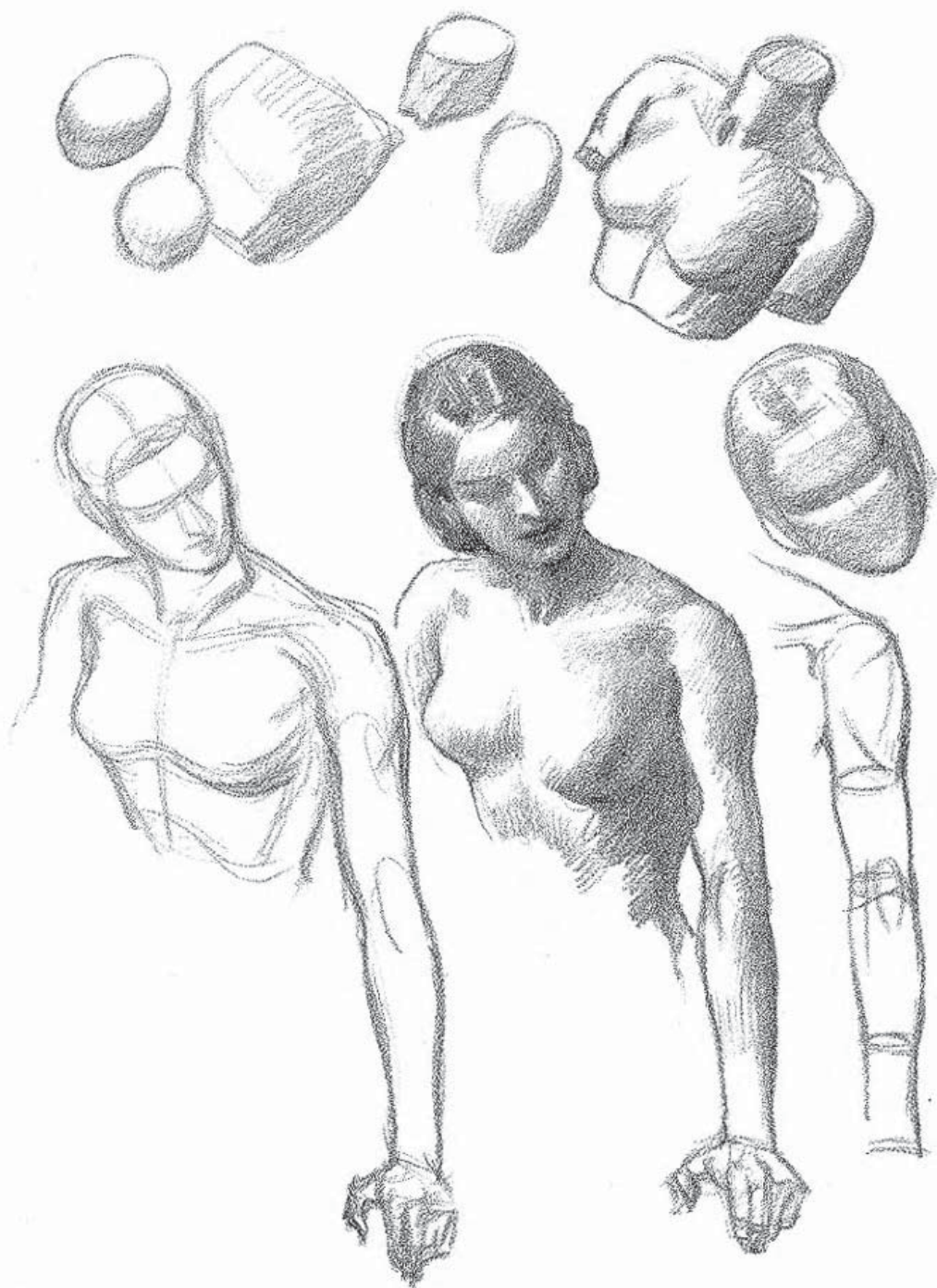

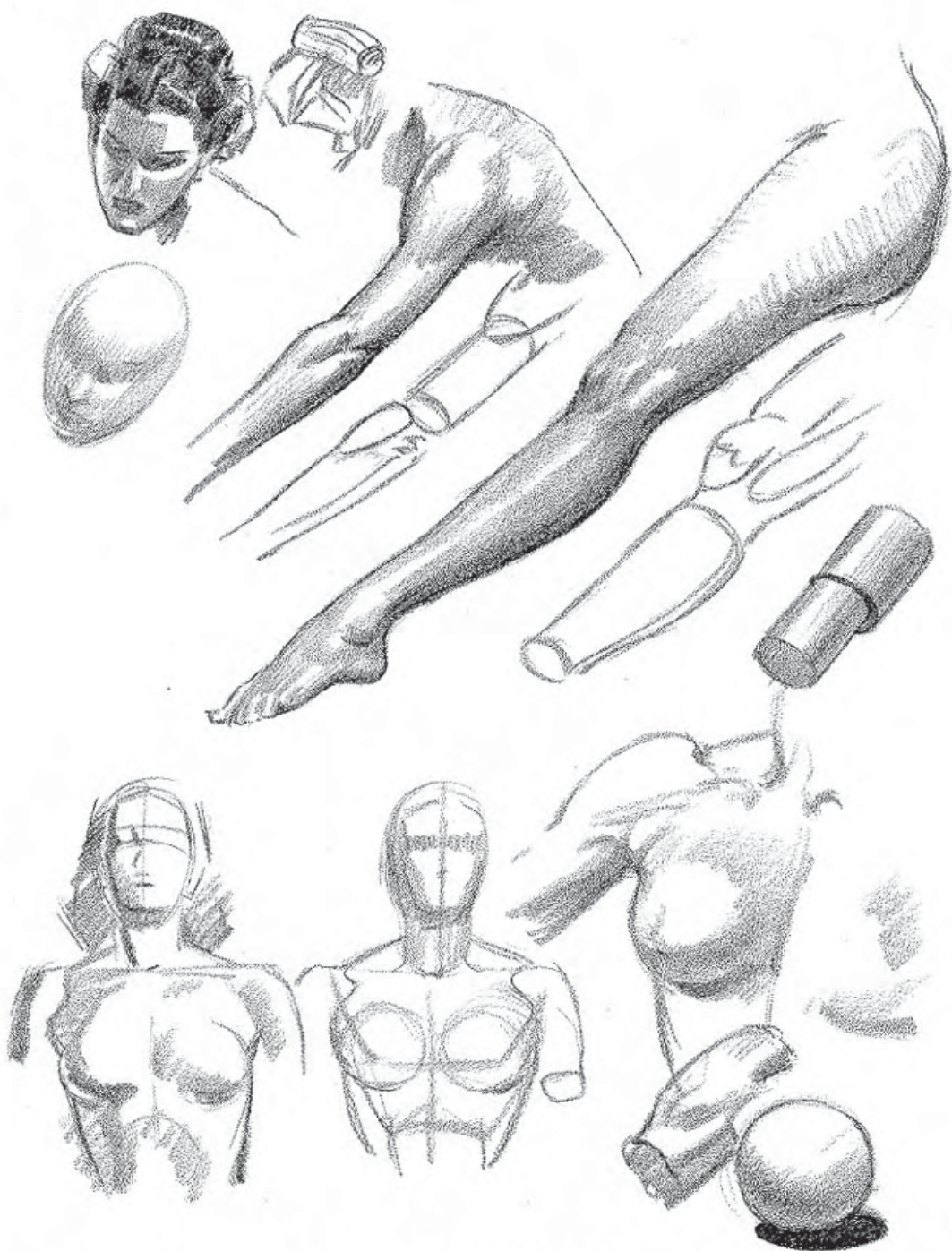

*Light on forms related to the basic forms of sphere and cylinder*



*The study of still-life is one of the best ways of learning to draw. Light the objects from one source. Try to separate all the areas of light, halftone and shadow in everything you draw. Sometimes these areas are very merged and delicate, so that it will test your observation and skill to define them.*



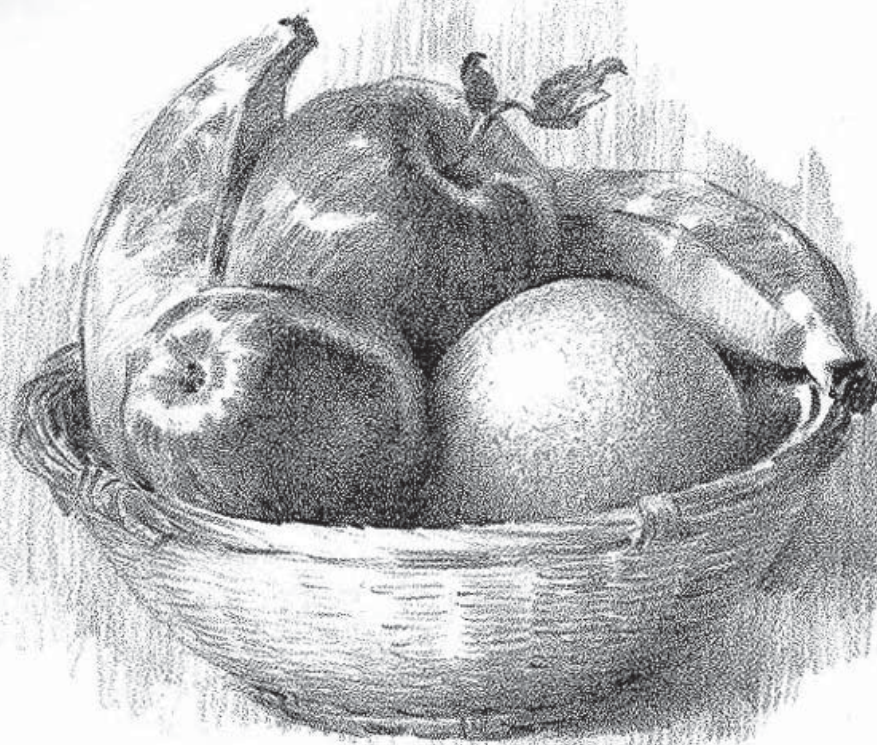



## Applying Light on Form to Comics

If you are interested in comics, here is where you can have a lot of fun. Once you get the "feel" of light on form, and learn the way light operates, you can add light and realism to your humorous drawings.

Suppose you have drawn a sphere in its normal effect of light and shadow. Now begin to add forms to the surface of the sphere. You do not have to finish the sphere first, but for a change draw some bumps on it. This principle was presented in my earlier book, *Fun With a Pencil*, but in line only. Here we attempt to add the living qualities of light and shadow.

Light can be handled just as seriously on comic forms as on any other, for form is form, and light defines it. The sphere in the left-hand upper corner of page 99 and the drawing next to it show the plan of drawing such forms attached to the ball. Invent your forms as you wish, so long as you duplicate them on each side of the face. You can gain a lot of experience in lighting form if you get some modeler's clay or plasticine and build up some of these forms on a ball. Then set the model up in light, and draw the light and shadow as they appear. This will help you achieve a very convincing solidity in your drawings, and also develop your structural sense. Any competent artist should be able to model forms that he has drawn often, for drawing and modeling have such an affinity that to be able to do the one almost assures the ability to do the other.

In the deeply rounded forms, like the nose, or the smiling cheek, we are pretty sure to have some reflected light which causes the "hump" at the edge of the shadow. Note that the darks come in the depressions—the deeper, the darker. We watch for the largest and brightest areas of

light on the forehead—on a bald head, on the cranium. A big nose catches a lot of light, and fat cheeks do also. The chin, if protruding, will catch its share in most lightings. We can make a chin come forward or recede by the way it is lighted, especially in a front view.

On pages 100 and 101 I have given you the outline construction of some characters I have drawn. You can go on building such heads indefinitely, arriving at different personalities by varying the forms you attach to the ball. I personally enjoy doing these things, and it is amazing how such fooling around helps you in seriously drawing heads. The lighting principle may be applied to the whole figure as shown on pages 103 to 105.

Comic drawing is a field in itself. Most comic artists stick to outline only, for the sake of simplicity. However, these artists also may never have studied the possibilities of lighting on the figures. Of course, when the drawings are to be reproduced in small size, there are difficulties involved. But if a grainy board and a very black pencil are used it is not necessary to use half-tone reproduction. On such board the pencil may also be used in combination with pen line.

For relaxation and real fun, there is nothing in drawing to compare with this type of creativeness. The little wooden or plastic manikins available at most art dealers can help out a great deal for poses and action.

In comic drawing the construction and proportion will be mostly your own. Sometimes the more incorrect they appear, the funnier it makes the drawing. If the wrinkles in the clothes are a problem, get up and look at yourself in a mirror. Make a mental note of what happens in a sleeve or trouser leg.





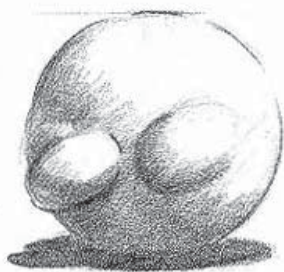
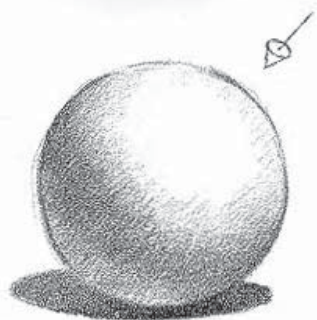



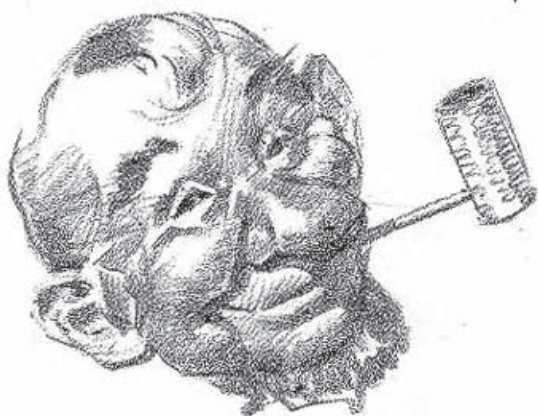



















## Using a Manikin for the Study of Anatomy

The best way to study anatomy is to set up a book of anatomical diagrams before you, and set up an art-store manikin alongside it. Draw the action from the manikin and the muscles from the book. You can also make rough sketches of the manikin itself for general bulk and action only.

Just copying anatomical diagrams does not seem very helpful to most students. The muscles must somehow be built upon a frame or figure in order to get their proportion and relationship to the figure as a whole. The joints of the manikin are usually balls of some kind, and of course such joints must eventually be covered up. For this reason it is well to concentrate on the muscles of the shoulders, and those of the thighs, especially at the hips. Then study the chest, waist, and buttocks. Next get the back, then the arms and the whole leg. To balance the manikin on its feet requires about the same arrangement of limbs and torso that the human needs to hold its balance.

The manikin is intended for line only, not for the study of the figure in light and shadow. The lighting on these simplified forms is not enough like that on live models. We consider later the figure in light and shadow.

Work in the life class should be done with the anatomy book open. It is difficult to start drawing the figure from life without any previous preparation. Upon entering a life class the student should have a fairly accurate idea of the proportions of the figure in heads, and in sixths, as illustrated on page 107. I have tried to cover most of the problems of figure drawing in a previous volume, *Figure Drawing for All It's Worth*.

Some instructors object to the use of the wooden manikin, since the action is only an ap-

proximation at best, and there is no actual play of muscle to go by. This objection is sound, provided the person studying drawing has life classes available, the time for them, and the funds to pay for them. I gladly agree that any young person who intends to make a living at art should by all means attend life classes. However, I believe that the manikin has an important use for the study of action, since a live model cannot hold an action pose for any length of time. Working from the manikin tends to loosen up the student's figure drawing. When an artist gets out into the active practice of his art, he can seldom draw a figure posed as it would be posed in a life class for twenty to twenty-five minutes at a time. The static poses of the art class should be much more for the study of light on form, values, and color.

To get figures in action the artist is almost forced to use the camera, and many present-day artists have high-speed cameras for this purpose. However, for an action picture, the artist should have a well-developed knowledge of the figure under the drapery. It does no harm to make the figure do something besides stand or sit, or perhaps hold a rod or pole. The pose or gesture of the figure does much to make it tell a story. If you intend to be an illustrator, you must have action in your work, or it will not be very successful.

The manikin helps particularly in making preliminary sketches or developing rough ideas which hardly warrant the expense of a model. A model can be hired for the last stage of the work or for the material from which the final work will be drawn.

The student should of course use his own judgment. If he finds that the manikin helps, let him use it.

## DRAWING FROM THE MANIKIN

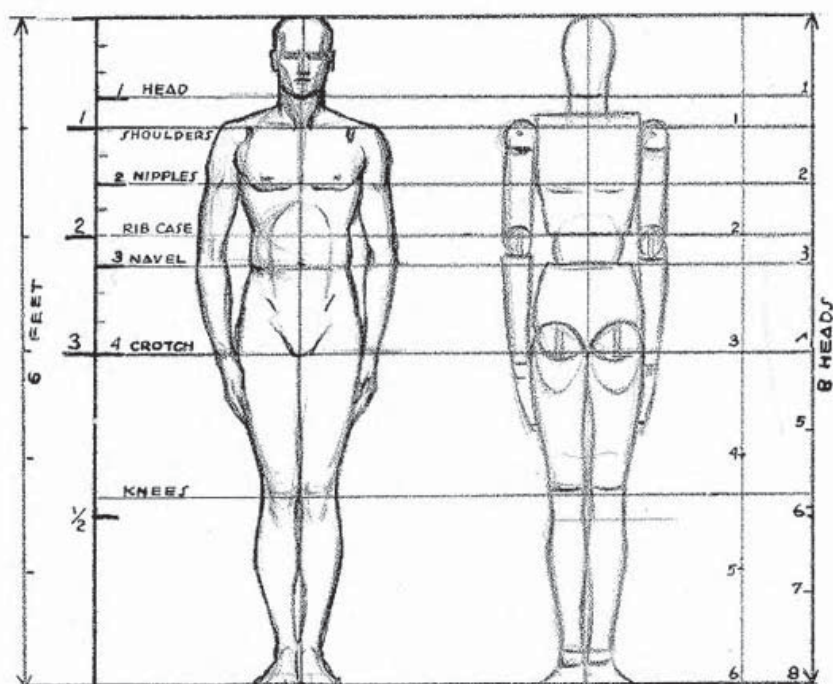

Manikins are a great help in developing action in figure drawing, in that they can be put into "still" poses no live model could hold. They can be purchased at most art dealers. Their approximate construction is shown by the figure at the right. For comparison, the figure at the left shows the ideal proportions of the male human

figure. The line at the extreme left shows divisions of the height of the figure of ideal proportions. One side of the line is divided into sixths and the other side into eighths. These two sets of divisions indicate the important points of the figure. Memorize these scales.



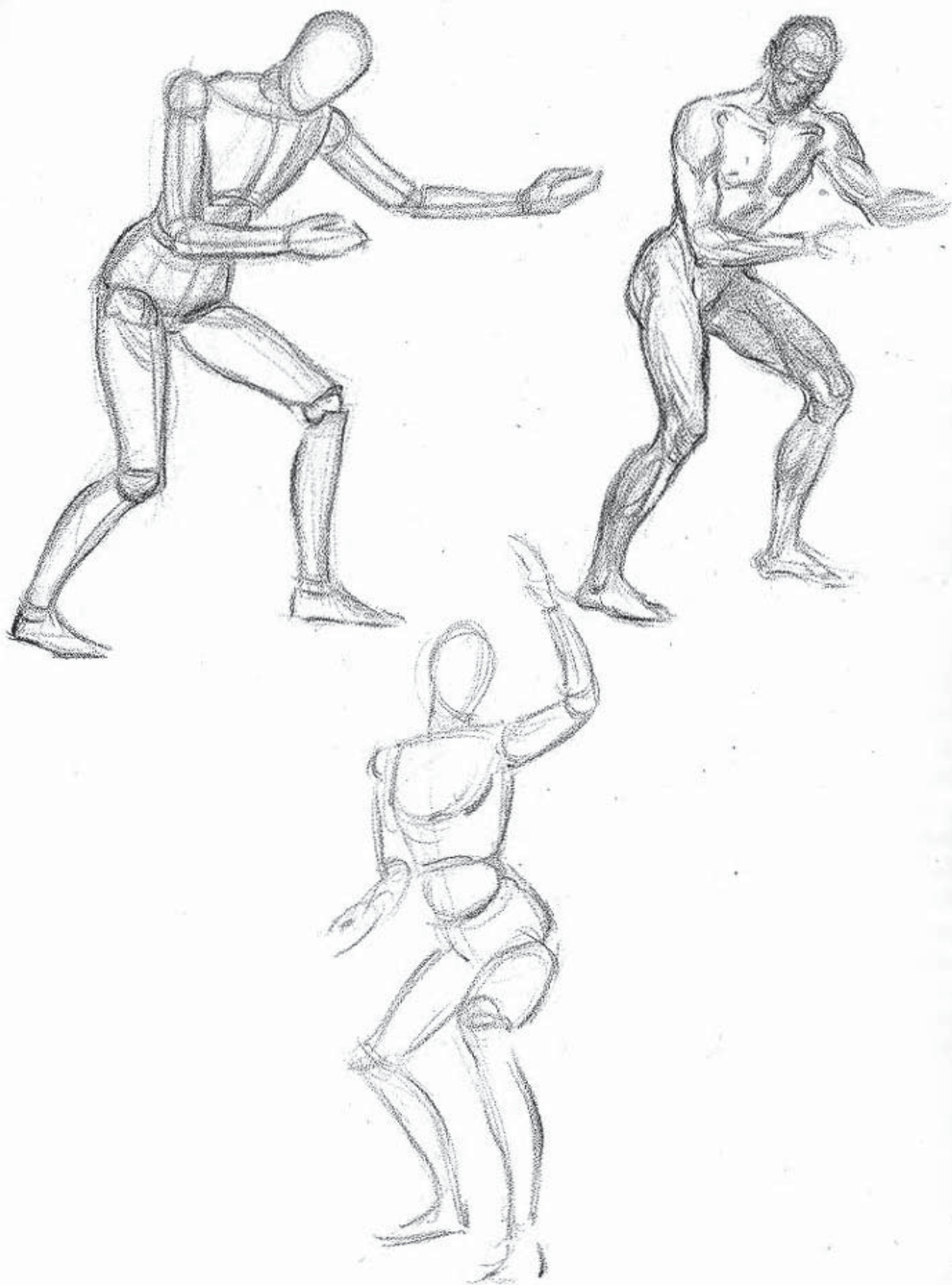





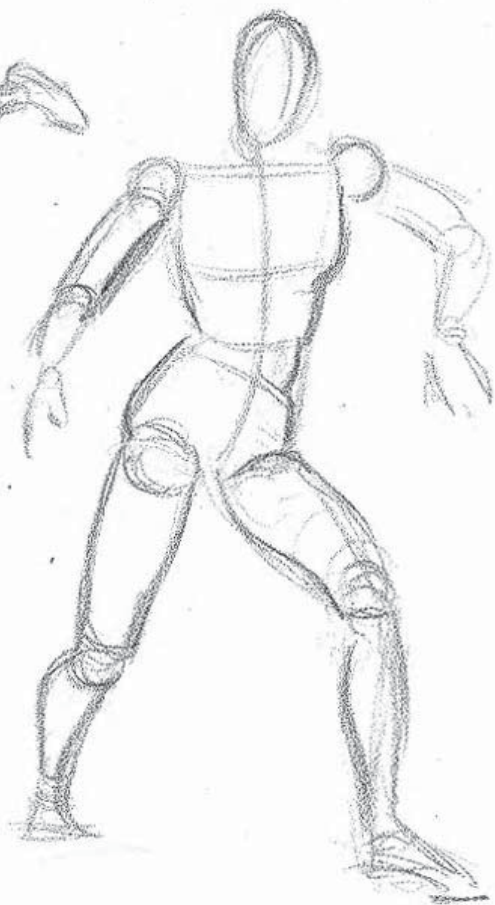









## The Figure in Light

For some reason many students seem to have their greatest difficulty in what they call "shading." This is probably because there is no such thing as "shading," in the sense they mean. The term "modeling" is more accurate. The student wants to add tone to outline, so he is likely to put in a lot of meaningless grays and darks between the outlines.

What he must do with tone is the same thing the sculptor does. The shadow is a tone that is governed in the first place by the value in the light. Things have what we call local values, which means the material or substance is light, gray (or a color darker than white), or dark. Put them in any light and the values keep their relationship to one another. A dark suit, for example, would never be as bright in value as flesh, if both were rendered truly.

When working with pencil we seldom attempt to get all the values in scale as we would with paint. When there is bright light and strong shadow we take some leeway, but we suggest some tone in the lighted areas of dark materials, making the shadow quite dark. For flesh, which usually is fairly light in value, we leave the lights as white paper, for the pencil does not give us quite the range of tones from light to dark that paint does. So in pencil drawing the best effects come from keeping the strongly lighted areas very delicate in modeling. Getting effects in the lighted areas too dark makes drawings appear muddy or heavy.

When working in pencil, I try to think of about four tones, starting just beyond white, or as light as you can state a gray, then a gray, a dark gray, and a black. Thus the whites are extreme lights, the delicate grays give some form to the lighted areas, the grays become the halftones, and the dark grays and blacks are reserved for the shadows.

There can be no formula, because every subject has its own particular values, determined by the light, its direction, its brilliance, and its particular effect upon the local values. But the student can gain much understanding of light very quickly if he can learn to distinguish the differences between areas of light, halftone, and shadow, and set them down. Even if the values in a drawing are not true, the correct separation will give solidity to the drawing. Instead of trying to match all the grays of a photograph which you are using as copy, just look for the shapes of light, halftone, and shadow. Sometimes there are tones within a shadow where light is reflected; you must draw these also, even though they are submerged in a lower all-over tone.

It is foolish to try to fake the lighting on a seriously drawn figure. Lighting is much too complicated and subtle to guess at. Either have a figure to draw from or get some good photographic material. It may be helpful to work from copy first, and from life later. The ideal thing is to enter a class in life drawing. Most classes work in charcoal, which is even more flexible than pencil as a material, for it can be easily erased. If you are studying the figure at home, get some charcoal, charcoal paper, plastic or kneaded rubber. You will also need a drawing board. Remember to keep darks and blacks out of the lighted areas, except where you find accents of shadow within or alongside of these areas. Keep a long point on your pencil or charcoal so that you can use the tip for line and the sides for tones.

Get some good books on figure drawing, and some on anatomy. If you practice a good deal on still-life drawing, too, you will draw the figure much better. Light is light no matter what it falls upon, and it always follows the form with light, halftone, and shadow.











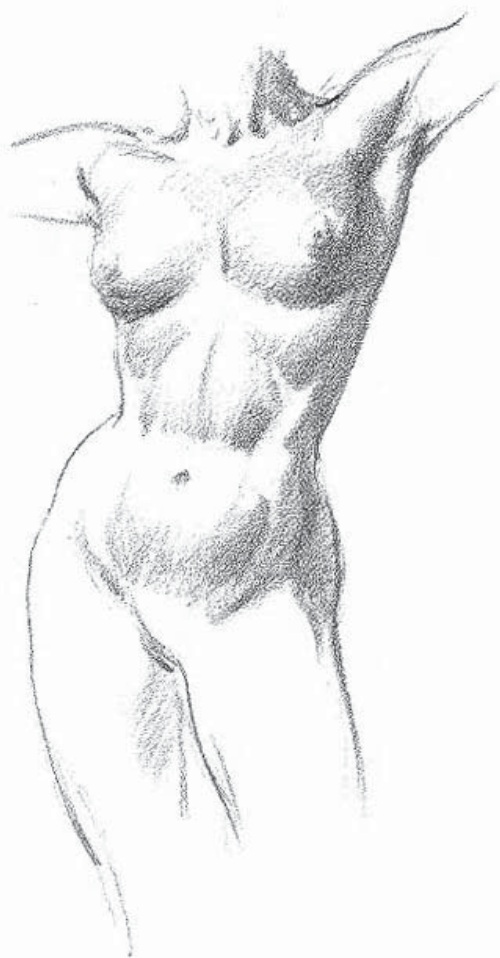

*Simplified forms in the torso.  
These structural forms are more  
important than the small and  
detailed surface forms.*



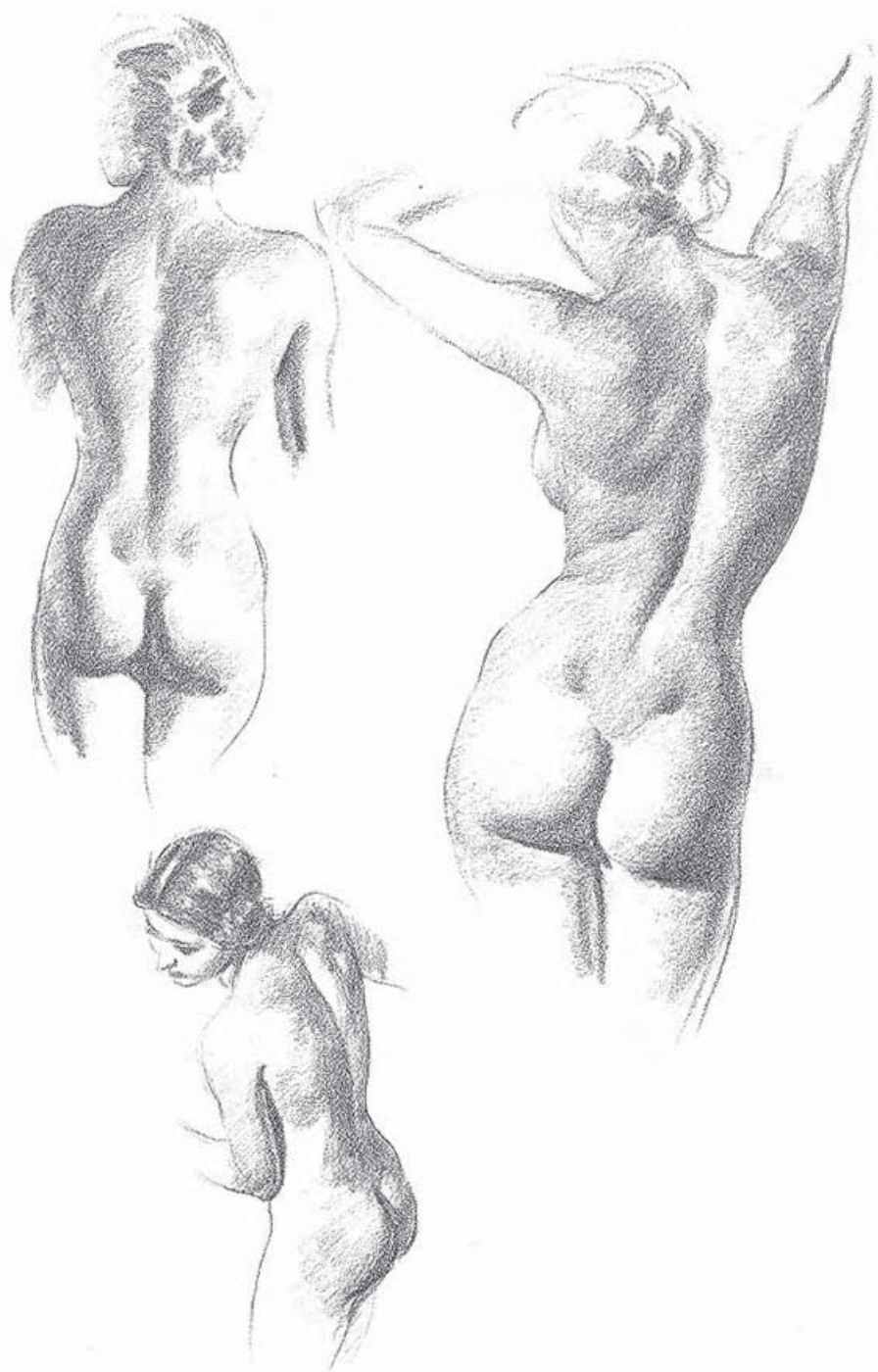



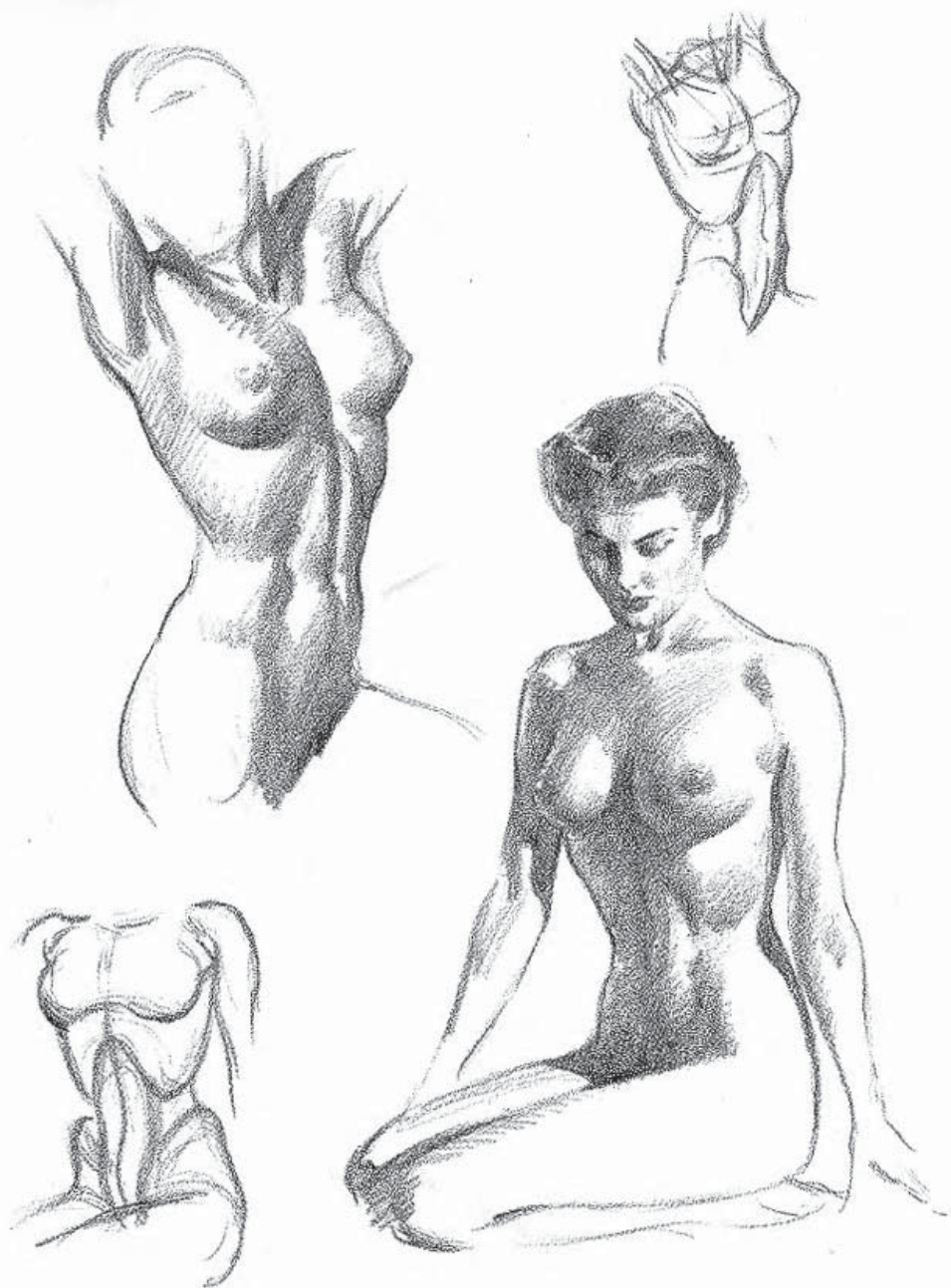





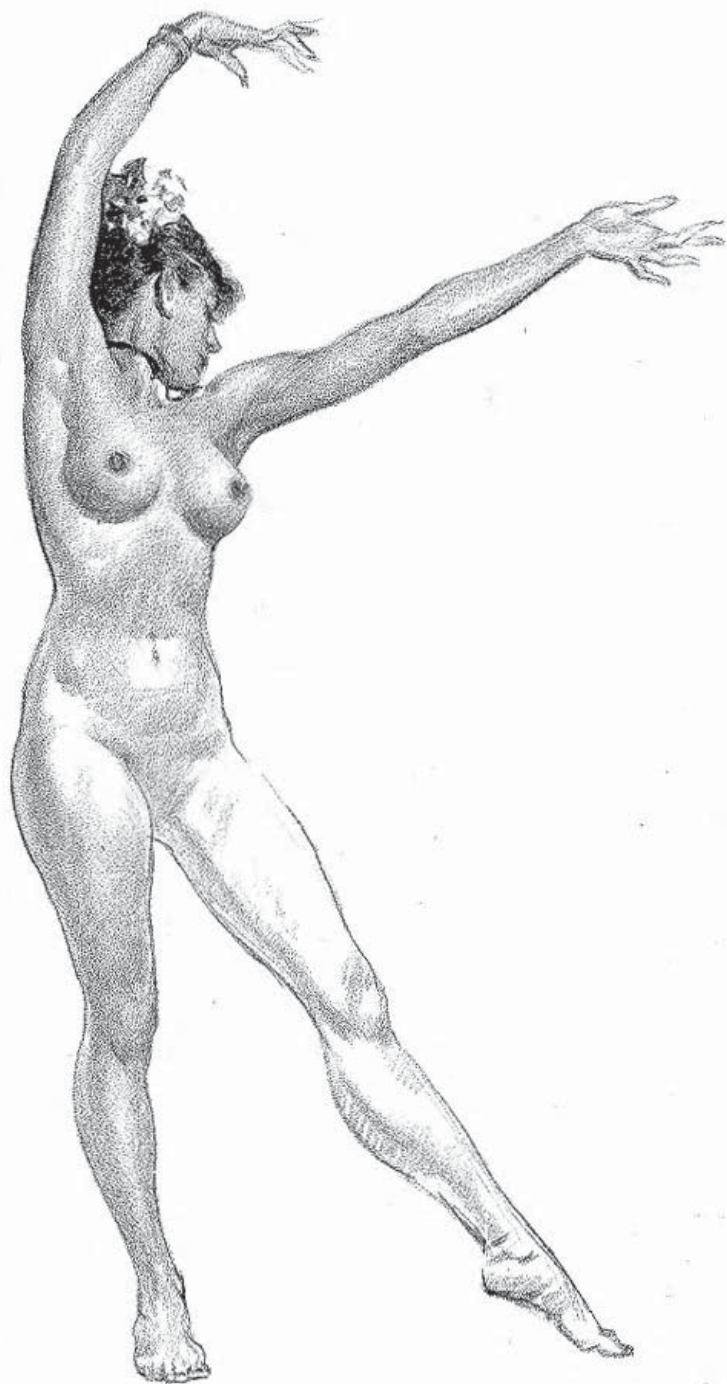

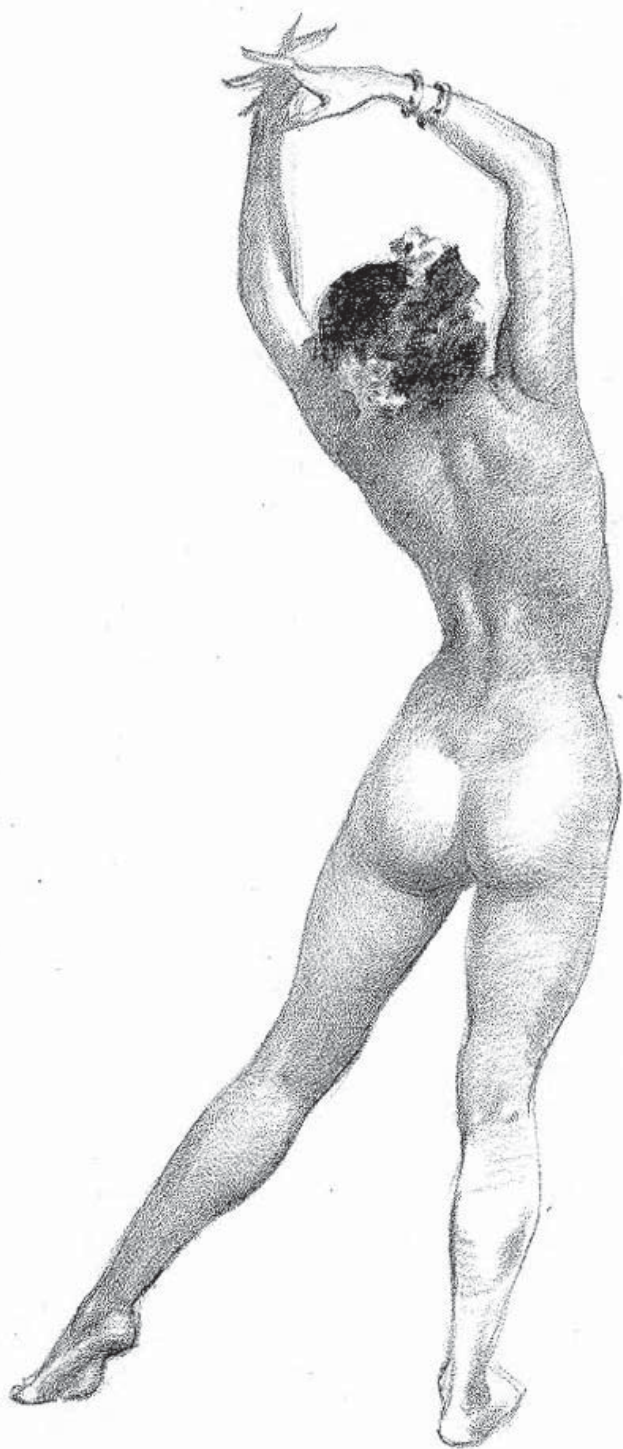



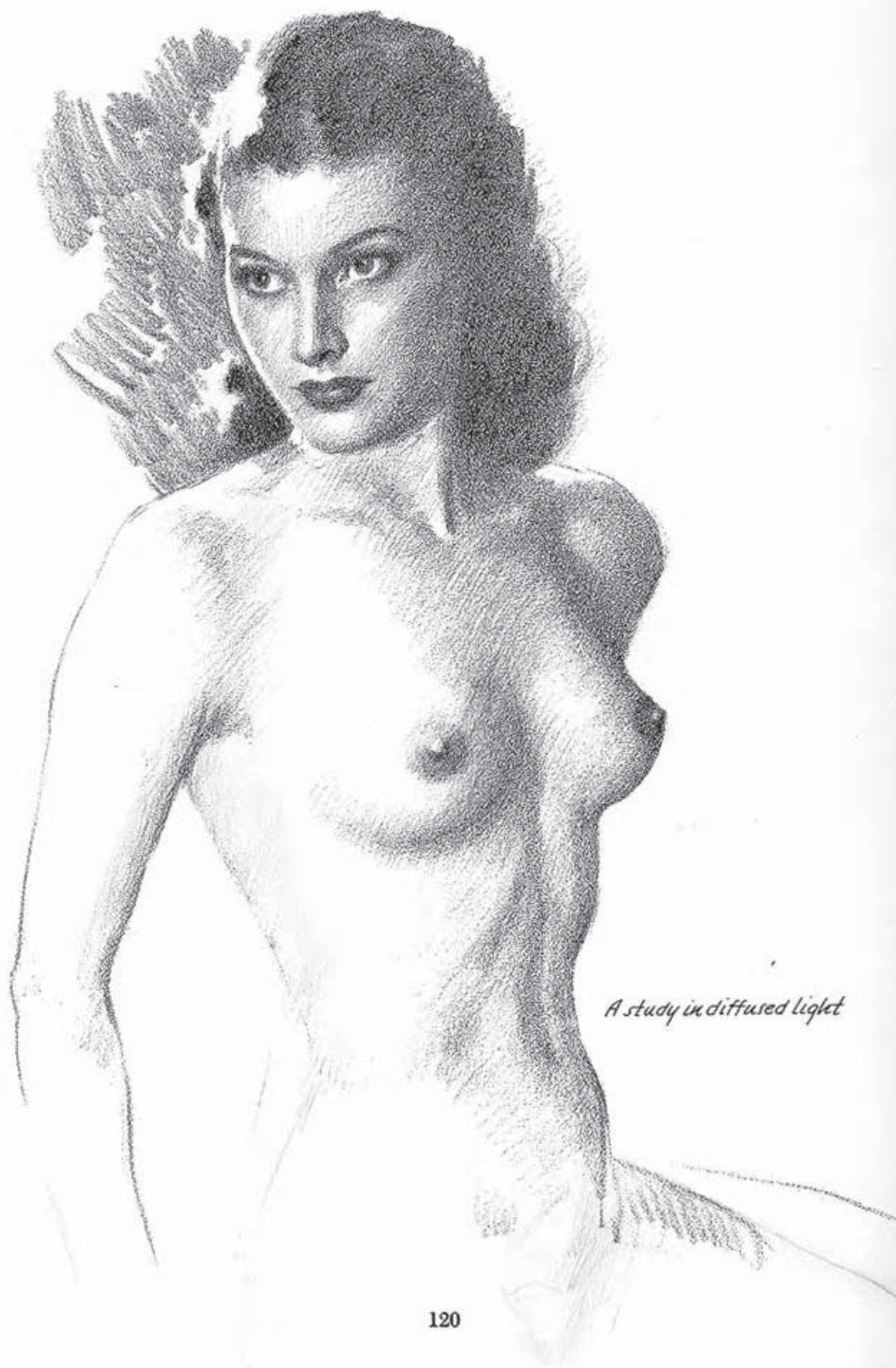

*A study in diffused light*





*A study in direct light*





## Depicting Character by Means of Light on Form

The only way to capture the character of a head successfully is to understand the forms which make up the particular individual. No two are alike, so there can be no formula, except for construction, proportion, and lighting.

True enough, we can make caricatures with line only, but even in these the forms must be seen, understood, and expressed. The whole head is the result of the forms which combined make up its bulk or mass. It is possible to exaggerate the forms somewhat, which is what caricaturists do, but, make no mistake, these fellows can do that only because they have a keen sense of form. I have exaggerated some of the forms in the heads on the following pages. By stressing the shapes that are peculiarly characteristic, we often get more than photographic likeness.

Just as in the figure, we look for the big forms first — the shape of the skull and the face, and the placement of the features. Then we take just enough of the incidental to bring out the character. This is not a matter of tracing down contours, for most of the importance lies in the forms within the contours; to make these forms exist, establish the effect of light on them.

Some of the heads shown here may not be familiar to the younger generation, but they are, or were, all characters. They include Einstein, John D. Rockefeller, Hiram Maxim, Von Hindenburg, Will Rogers, Churchill, and Adolph Menjou. To us as artists, these men, aside from their deeds and accomplishments, are so much proportion, spacing, a combination of forms in light and shadow. If we were to shift one feature of any of these faces, such as putting the nose of one on the face of another, the whole effect would be lost. If we can see the forms but cannot draw them in combination with everything else, we might as well start selling apples, as far as drawing successful heads of individuals is concerned. The old masters, who had no cameras, took measurements of faces and features

with calipers. Some, like Sargent, succeeded in training their eyes to measure proportions with a profound degree of accuracy. Some students get everything too wide for its height; others make the opposite error. Even the best artists must continually adjust proportions in their drawings, when drawing from life. But the ability to do so does eventually come with practice.

A much easier and surer way of seeing the forms is by looking at the lights, halftones, and shadows. These reveal the form though it differs in every lighting. Hence the importance of selecting a simple and easily decipherable lighting. We should know the direction of the light source on every inch of the surface. The minute light from more than one source strikes the same surface, it upsets the sequence of the operation of light as we know it.

Studio photographic portraits are not too good to work from unless the photographer has really clinched the form. The trouble is usually too many lights and crisscross effects, which are most difficult to reproduce in a drawing. Clippings from motion-picture magazines are nearly always bad. Such photographs are also copyrighted and may not be used for anything but practice. Naturally a drawing of any public figure must be made from copy of some kind. It is best to gather as many clippings as possible and build the character from all the information you have. You have a right to draw your version of any public character, even in caricature or cartoon.

The best practice is secured by having people sit for you, though it is not an easy way to work. Study them for individual characteristics, and stress these. A sharp face can be a little sharper, a round one a little rounder, and so on. Eye-sockets are more important than irises. Only the bones of the face keep the flesh in the shapes we see.



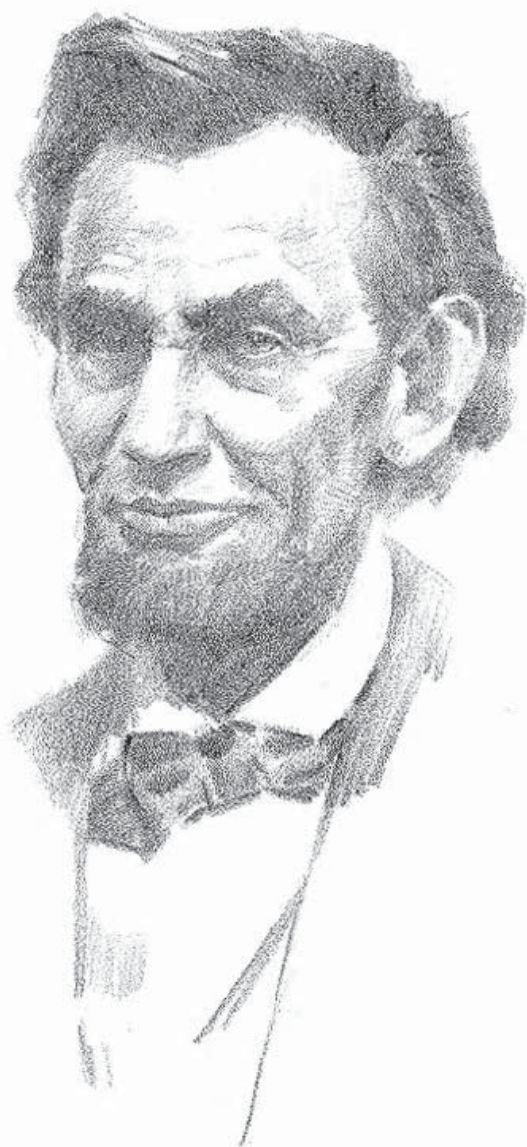



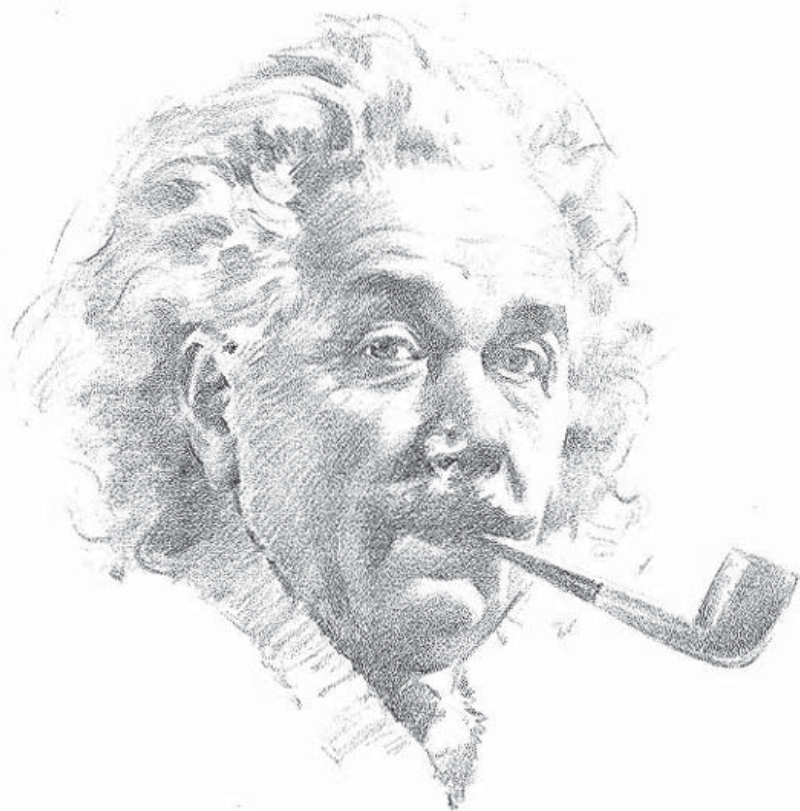

*Every head has its own combination  
of forms which will identify it.*

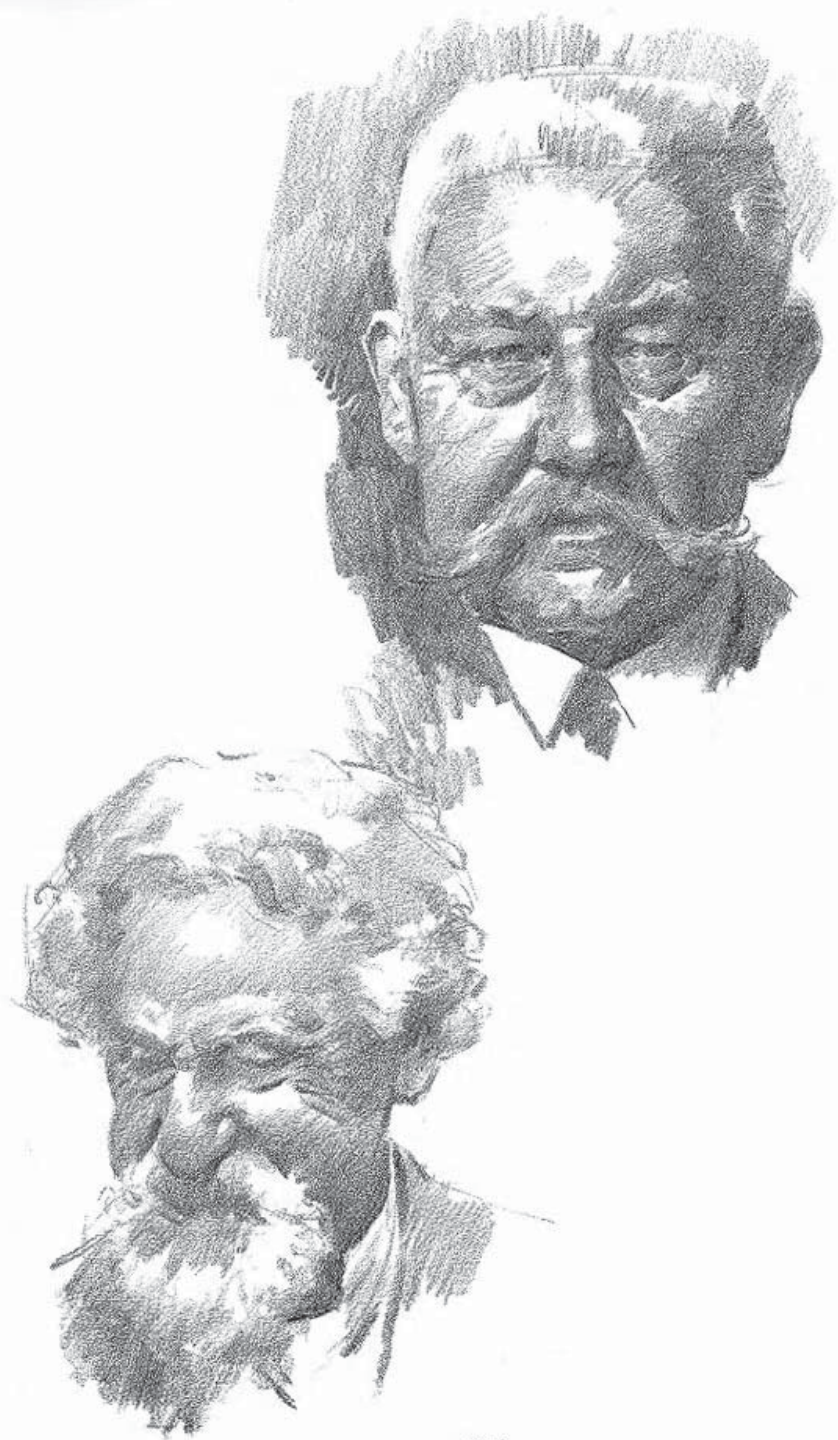



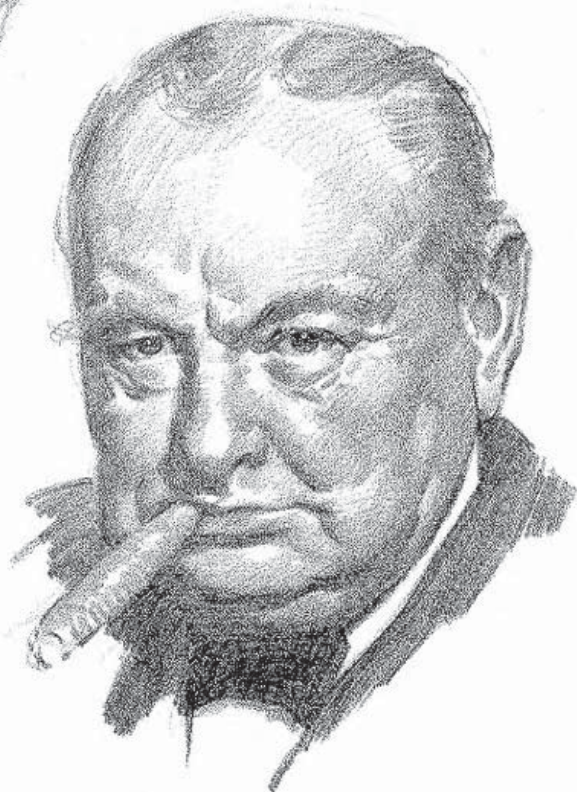



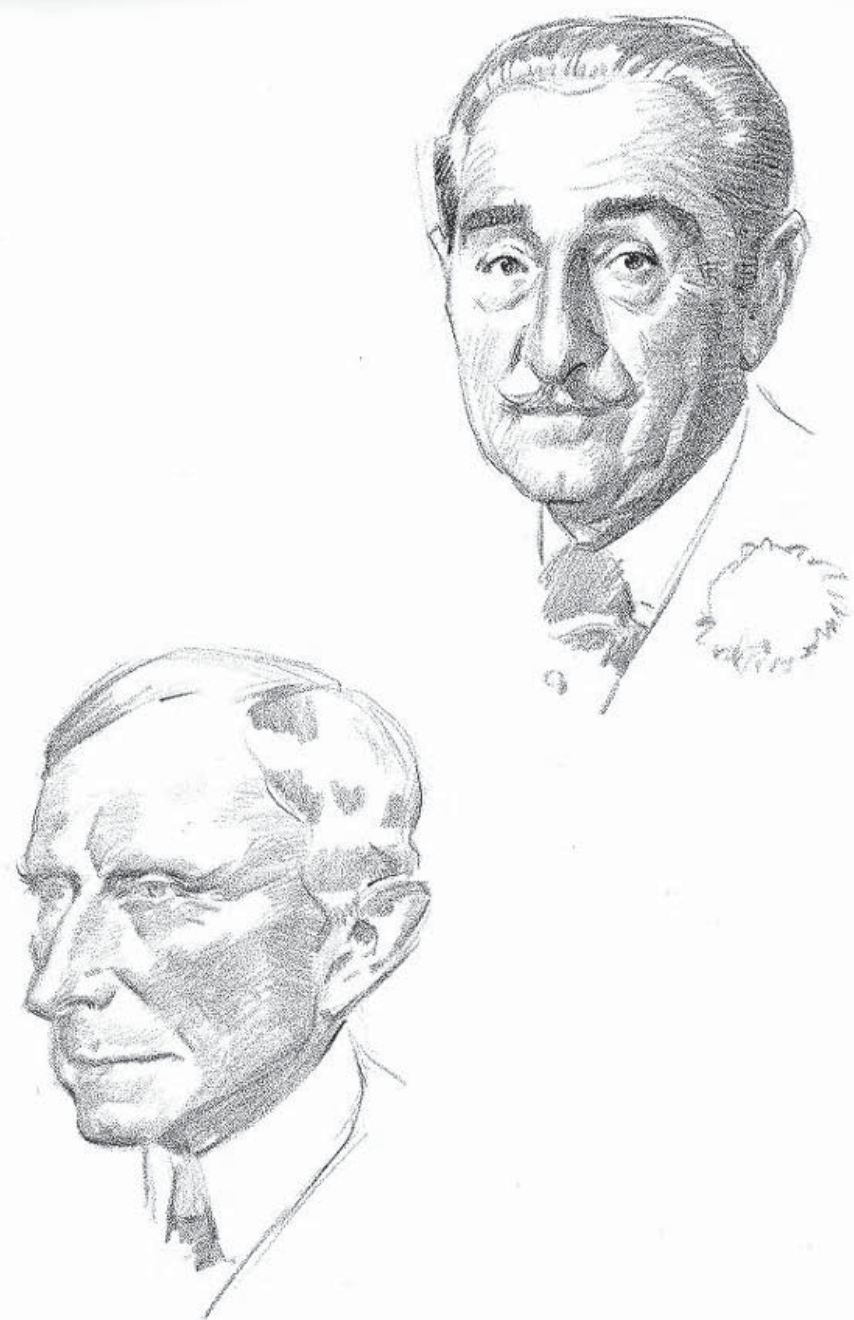



*There is no better way to study than to practice all types and characters. Heads have all the major problems of real drawing.*

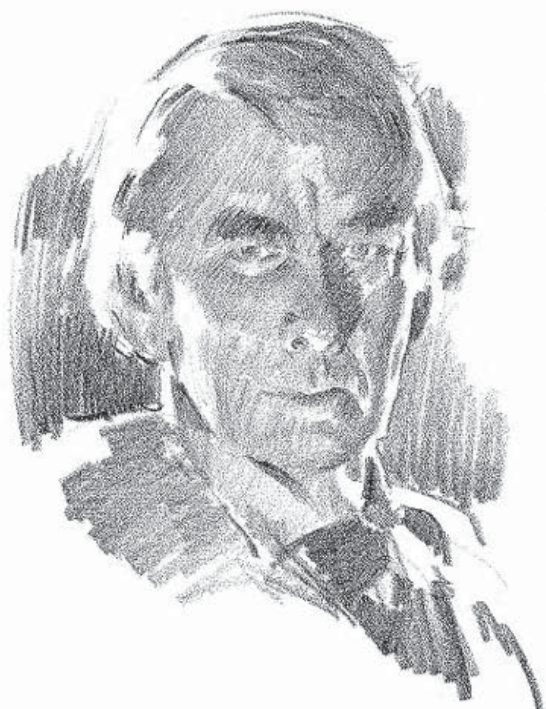



*Exaggeration of the form*



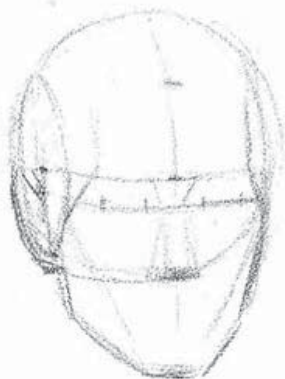
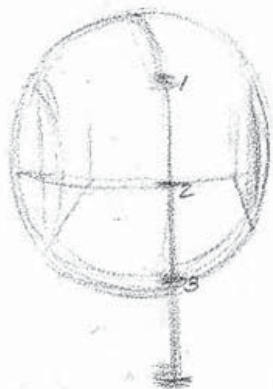
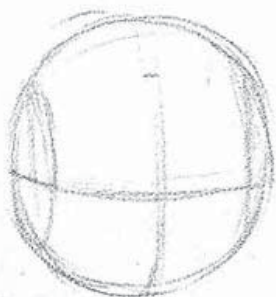

*Showing the construction of the planes and the effect of lighting*



*HE'S BEAUTIFUL!*  
*Drawing the head without model or copy*



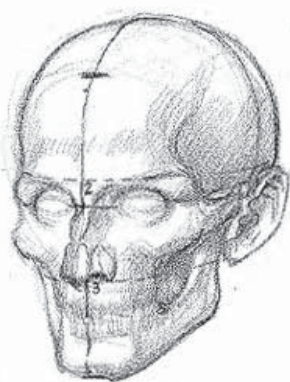

*Study the skull forms*

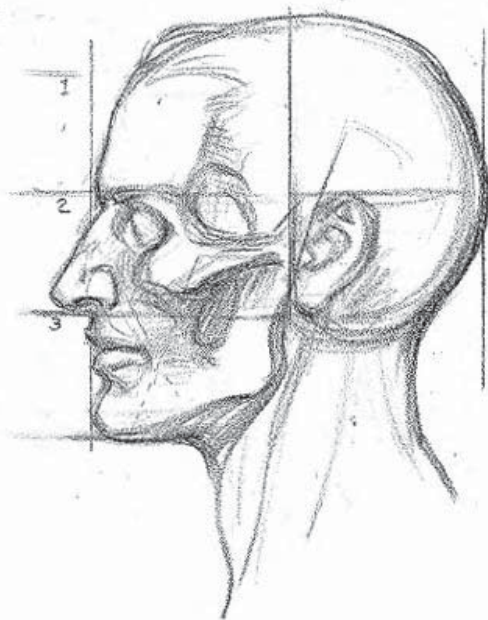

*Your skill in drawing heads depends upon your ability to understand the forms and then to space them in correct proportion.*







TONE

*It is valuable training to make many practice studies of the features, striving more for the effects of tone than line. This is a sound approach for painting. Tone is form, line is definition.*

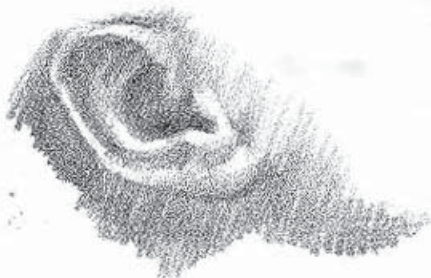



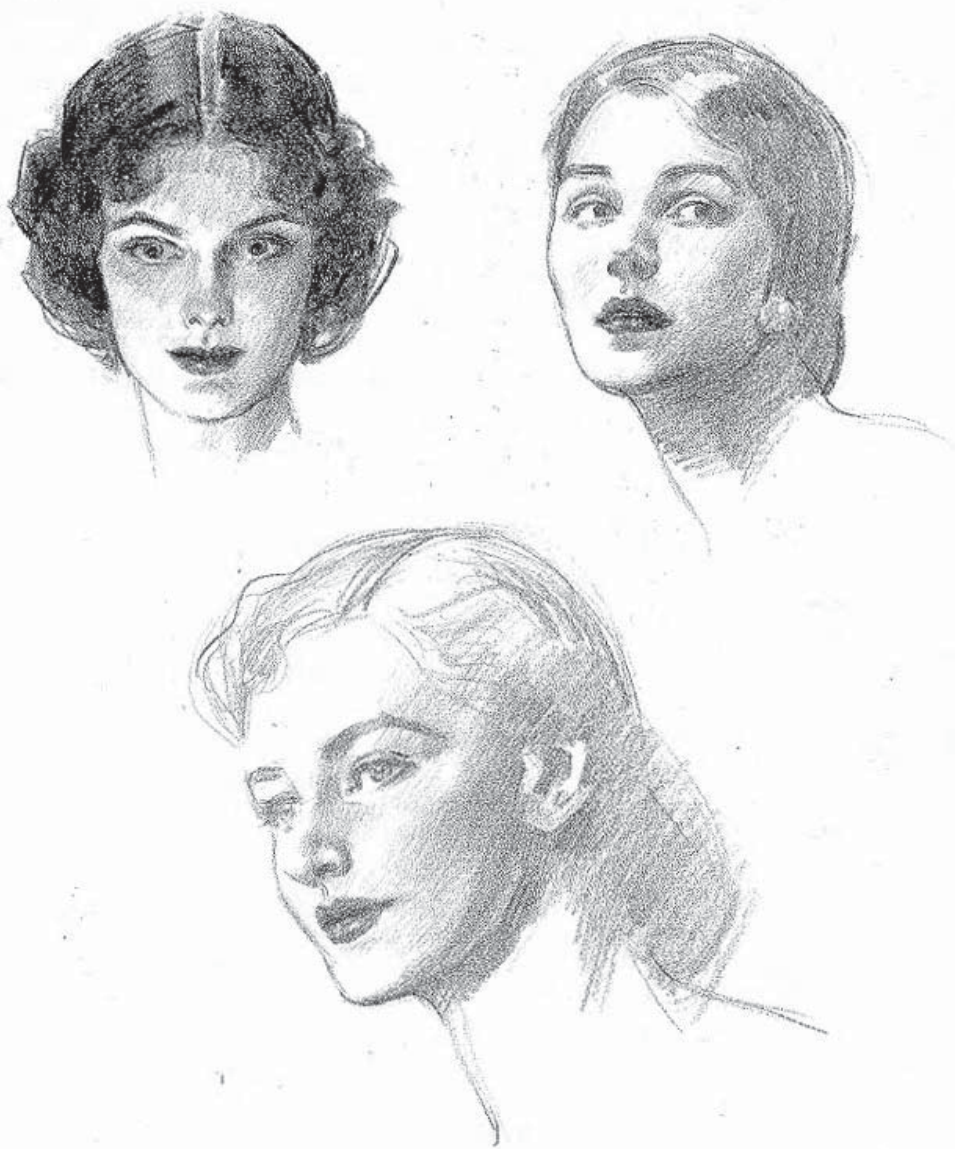

*The success of illustrators in America seems to depend largely on their ability to draw a well-constructed head. Study!*



## Drawing the Figure in Costume

Most of the preparation a commercial artist goes through is to learn to draw figures in costume with all the elements right. When a man takes up art as a hobby he is free to do what interests him most. But if it is his vocation, the costumed figure is his chief stock in trade, the thing he depends upon most.

The effort put upon the study of light on form is brought into play. His knowledge of perspective in the figure and its environment is called upon. Light falls on the costume too, the same light that falls on the head. The clothes should not only drape naturally and with folds characteristic of the material, but they should suggest the underlying form of the figure upon which they are draped.

In the drawings that follow, I have chosen costumes that are not present-day styles, since styles change so fast that even before the book is published the clothes may be wrong for the prevailing modes. Unless he is drawing a subject of an earlier period, the artist will have to keep up with styles, in order to keep his figures smart and up to date. So I have chosen costumes which are not limited as to material or style, but which present the same problems of folds and draping. As period costumes these will be used indefinitely. For practice you can make pencil drawings of prevailing styles from the multitude of photographs in the fashion magazines and advertisements. The important thing is to practice drawing garments on the figure, watching the lighting, the forms, and the perspective of the forms. In this kind of study I suggest eliminating most of the background, as in my studies, to keep the problem from becoming too complicated. There is enough in a good figure and costume in itself to make an attractive drawing. Sometimes a bit of shadow can be added effectively.

After you have made a number of costume

studies, I suggest you find illustrations in magazines which show figures in a room, with some furniture or other accessories. Copying these is valuable practice, because they require perspective and proportion. If you have a camera, try taking subjects of your own for practice.

I should like to call attention to the infinite patience that Norman Rockwell shows in getting all parts of his pictures related and correct. Few artists will ever exhibit his fidelity to minutest details. There may be argument as to artistic approach, but the warm popularity of his work stands year in and year out as proof of what I have discussed as the intelligent perception of the public. I cannot believe that such work will not continue to be appreciated, no matter who the artist is. Work based on truth will live just as truth itself lives, all arguments to the contrary.

I wish also to mention the work of John Gannum. Here again is fidelity, expressed differently from Rockwell's, but no less sincere. Here is color, along with all the other elements of successful work, including the very important one, consistency. In the work of these two men so many important elements are always in evidence that every subject is one for study and appreciation. The layman says much when he looks at the work and says, "It is good; it looks real." He has no idea of the information needed and the ability required to make it look "real." The artistic expression is only possible after the means of expression have been perfected. It is not a matter of technique, but of seeing things in relationship in plane, in tone and color, in proportion and perspective, and in light. How we put these things down does not matter so long as the results are right. Variations in technique come from individual ways of seeing and executing, but the problem itself is the same for all who ever hold a pencil or a brush. Real technique develops itself.



































## **A Gallery of Drawings**



*Every artist should subscribe to the fashion magazines. They are the best possible sources for practice material. At the same time you are learning drawing and values, you are familiarizing yourself with the very important elements of style which mark the era of which your art must be a part.*









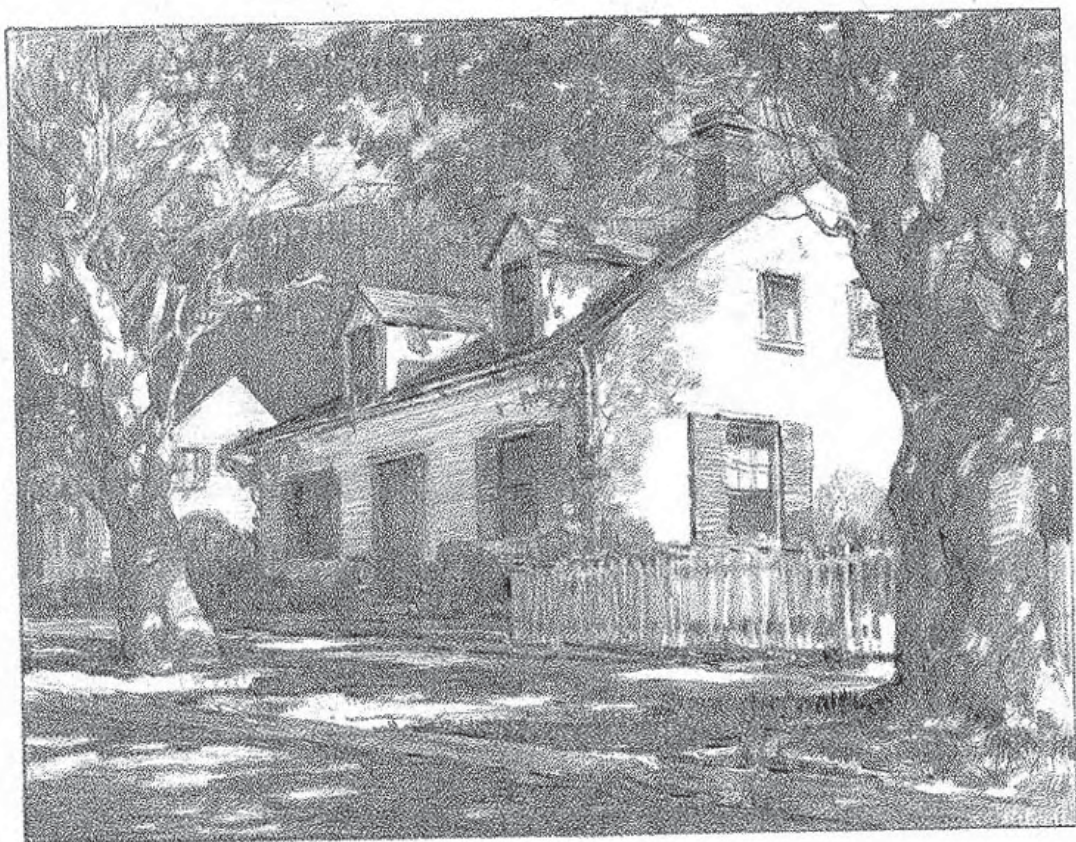

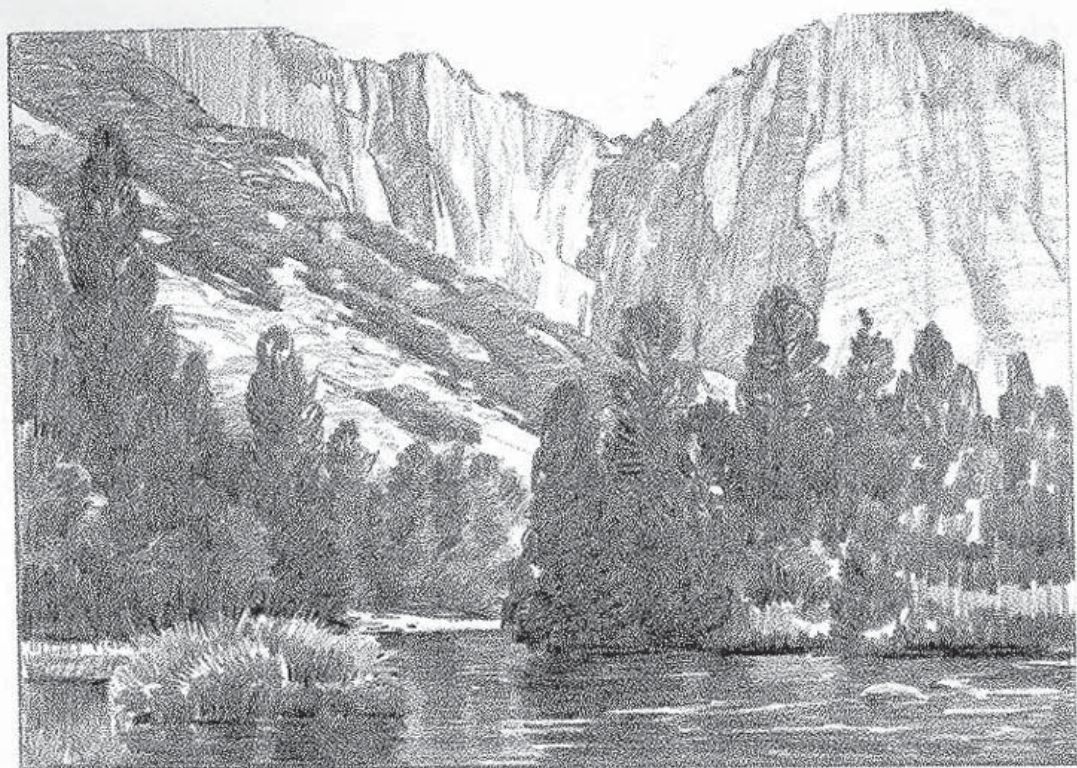





*Tonal plan for a figure painting*













# Some Parting Words

In leaving the reader of this book I wish to present a plea for sound draftsmanship, plus individualism, in art. Sound draftsmanship can hardly be associated with anything but a realistic approach. To my mind a realistic approach does not limit creative imagination, which I thoroughly agree is a part of all good art.

There are those who take the stand that realism in art curtails the full expression of the individual, that it is merely imitation rather than creative expression. If realistic art were limited to the camera and the duplication of its effects, this might be true, but it must not be so limited.

In thinking of realism, let us not confuse it with literalism. Let us think of life as a great source of material from which to draw, selecting only what is pertinent to the things we have to say. We cannot use it all, or say it all. Let us re-create, as does the good writer of fiction, the poignant truths of life in so far as we are capable of discerning them and employing them for a purpose. Literalism devoid of purpose can be most boring. Detail must have purpose, or there is no reason for it. To be interesting, it must contribute conviction to a thought which in itself is interesting. The creative thought is the delicate balancing point between good and bad in art.

There is a vast difference between an uninspired and literal rendering of life and what we may call "applied realism." Rather than to project realism for its own sake, our real purpose is to add realism to a creative idea of basic interest. We depend upon realism, then, to embellish or to fortify our creative thoughts. The idea, within itself, may be totally abstract or pure fiction. But so that the idea will not remain abstract, we strive to make it convincing and plausible by giving it all the feeling of actuality that is possible. This is applied realism.

Realism in art does not stand in the way of

individual expression but becomes an important bridge between artist and spectator. We can take it for granted that the spectator's interest is not in how accurately we can see, but in the personal experience he has in looking at our picture. Our vision may not differ greatly from his own, but our presentation and the thoughts behind it may give him a new experience. Creativeness may lie in giving reality to invention, fact to fiction, tangibility to the intangible, and conviction and power to things more felt than seen.

In the good art of today, we sense a stripping of the folderols to get down to essentials, eliminating all elements that distract from a forceful presentation of the idea. The background of a picture is no longer a matter of space-filling; it is eliminated unless it contributes to the main thought. But since life moves against a background, its portrayal cannot always be left dangling in space. When the background lends force and reality to your subject, it should not be cast away unthinkingly because of fads or prevailing mannerisms.

Realism can have simplicity and function, resulting in greater beauty, instead of merely reproducing the haphazard multiplicity of nature. There can be dramatic and dynamic interpretation of the obvious, if we have the ability to perceive and portray it so.

Let us admit that much of the realistic art produced today is mediocre. This is not the fault of art or its principles, but is due to the inadequacy of the artists. Their failure does not invalidate the principle of realism; life does not cease to be a force merely because some individuals never learn to live.

The reason so much realistic art today is mediocre is that good art must come the hard way. We dabble and daub in freedom of expression and in paint. We know too little to make good use of either. We may thank God

## SOME PARTING WORDS

for the freedom man has fought for and attained, but we must use our intelligence to understand the real greatness of freedom of individual expression. We must work to produce art just as we must work for the right to live in a free nation. Work in art is not so many labor hours, for time has nothing to do with it. To one, understanding may come at the age of twenty; to another, at fifty. Some will never comprehend the laws of form, color, and life. Life is the source, the only available source, and art lies therein.

But how about individuality? No two of us will come away from nature with the same facts, for no two people have the same comprehension of her truths. We differ in personality and talents, and therefore no one can actually duplicate another's performance. Successful drawing is intelligent drawing with independent thinking. Knowledge in art is a combination of individuality and whatever facts the artist has assimilated. It is like an equation between the things we feel and the things we hear and see. Without the artist's individuality, drawing is not art, but only a statement of fact, yet the artist cannot get along without some facts. Working knowledge is the sum total of a thousand and one small personal decisions. It results from trial and error, comparisons and final acceptance of one way as against another: this must be so because that is so; this appears to be this way

because that is that way; I draw this point because it is under that point; this seems brilliant since that appears dull; and so it goes.

Relatively few positive assertions can be made about art instruction that will fit all circumstances. Since all things are relative, we can speak of unity, but the specific relationships must be discovered in the actual problem. Many students search despairingly for an exact formula that will steer them to a definite and certain goal, when actually each problem demands its own solution and each result is an individual answer.

There is no way to produce, except to gather all possible facts and work with them as you will. Be assured that most of your knowledge will come from contact with life, both within yourself and from the outside world. It is the artist who is limited, not the source. Let him go to art with respect and reverence for the greatness of this thing we call reality, grateful for being a part of it, and for the freedom of doing and saying his bit about it. Let him rejoice that he may trust his own feelings, giving only his own version of truth and beauty; if his effort is worthy, it will be appreciated with warmth and enthusiasm. Life and the individual's feeling about it are the only real sources of creative inspiration in art. Art can do no more for him than he can do for art.

# **BERSERKER**

---

## **BOOKS**

---

