

TERRORISM OF THE HIDDEN HAND



**TARGETED INDIVIDUALS
HANDBOOK**

BERSERKER

BOOKS



TERRORISM OF THE HIDDEN HAND

a handbook for the Targeted individual to identify and counter gangstalking and directed energy weapons

Introduction

1) What and Why?

2) Who

3) Solutions

4) References

Marching Orders

INTRODUCTION

The phenomenon of state-sponsored terrorism is nothing new and has been orchestrated by the architects of destruction, the hidden hand of judeo-freemasonry since time immemorial. Imposing trauma-based mind control on the common folk is the mechanism of power relied upon to maintain power-mind control, world control. The shadow government of the cabal is comprised of jews (a biological mongrel race bound up with entities which control them) and their 'shabbos goyim' (meaning 'stupid animals' in yiddish, referring to the non-jewish tools they exploit to absorb total power for themselves). The cabal has been in existence for thousands of years and is poised for the realization of their plans for global dominion and enslavement of all to their despotic will as of the time of this writing.

This handbook treats of the foremost particular means employed in the manipulation of the common folk beyond that of chemtrails; electro-magnetic fields broadcast from cell towers and other arrays; the poisoned food (GMOs) and water supply (chlorine; fluoride; estrogenic substances and synthetic chemicals); coerced taxation and wage slavery; media and education-indoctrination system propaganda and mind control among other technotronic control mechanisms.

The cabal has allegiance towards itself alone and to the entites which control it. The society engineered and controlled by the cabal is structured as a trapezoidal geometrical figure in terms of power share: Jews are at the top of the trapezoid in the physical dimension with freemasons and other illuminist groups subordinate. Under the controlling elite the population is divided into rival camps based upon occult principles of polarity: masculine (right wing) and feminine (left wing). The whole of "the system" of the judeo-masonic theocracy operates in secrecy and is hierarchically compartmentalized with advancement or demotion based upon the degree of loyalty given to the cabal and the use value of the individual thereto.

This loyalty entails an agenda of endeavoring to eliminate, to genocide, the white race as the greatest threat to the world rule of the cabal as those of pure blood (the white race), listen to the call of the blood memory and are not willing to sell out to the cabal for self-serving ends to as great an extent as other groups as the white race intuitively understands the difference between good (harmony) and evil (cacophony) and what is harmonious is the preservation of the organism of which one is a part, the racial soul.

That the white race is that most elevated in its consciousness can be inferred from its vertical tendency towards the higher planes of existence, towards the spiritual realms and its essential drive towards maintaining a harmonious world order.

The cabal of judeo-freemasonry seeks a world order based upon greed; usury; trickery and deceit. It seeks to destroy the identity of all and to reduce all to a mongrel mass in the crucible of its power politics, the divide and conquer tactics it employs to create chaos and impose its order.

Those who oppose the cabal are targeted and those of pure blood, those of a healthy mind incorruptible by its influence are foremost in the crosshairs. This group, especially those who are the most intelligent and intuitive amongst them, are prime target's for the cabal's use of the following means of global enslavement.

It is the wish of the author and compiler that this handbook be spread as widely and effectively as possible (reaching the reachable and those who will take action) so that the crimes of the cabal will be exposed and ultimately the balance of justice they have upset rectified. The following work is largely a synthesis of existent material on the phenomenon of targeted individuals, gangstalking and directed energy weapons, identifying what they are, how they are used, by whom and why. Either this information will get out and the cabal be exposed and overthrown through effective necessary action or there will be no future for this world. This handbook is designed to be a contribution to the overthrow. Spread it- it is an arrow in the black hearts of the architects of destruction.

1)

WHAT and WHY?:

A) Definitions:

"Organized Stalking is a well-organized, occult form of covert harassment used against an individual. It is done by large groups of people who systematically & repeatedly harass individuals. This has also been called Cause Stalking, Gang Stalking, Community-based Harassment, Organized Vigilante Stalking, Vengeance Stalking, Terrorist Stalking, Revenge Stalking, Covert Action, State-Sponsored Harassment, Microwave Harassment, Microwave Mind-Control, etc. All of these labels explain the same basic phenomenon." (Rich, State-Sponsored Terror Campaigns: The Hidden Evil", pg. 28-29).

"Mobbing, also referred to by some as bullying, psychological terrorism, and organizational violence is described as a collective form of psychological violence in which many individuals unite to persecute an individual Mobbing is a way of destroying a person without using any physical means Degrading themes are often used to try to prevent people from coming forward." (ibid., pg.35)

"Operations [are] designed to intimidate and destabilise [targeted individuals, 'TIs' for short] by subjecting them to repeated disappointment, and to socially alienate them by interfering with and disrupting their relationships with others as in social undermining. The aim was to induce personal crises in victims, leaving them too unnerved and psychologically distressed to have the time and energy for anti-government activism. " (Zersetzung, pg. 1)

"What we are seeing now is a globally co-ordinated and organised effort of control and conformity. Many countries around the world are currently using a model of policing called Community Oriented Policing [ie.gangstalking]." (ibid.pg.3)

"Organized Stalking is a form of terrorism used against an individual in a malicious attempt to reduce the quality of a person's life so they will: have a nervous break-down, become imprisoned, institutionalized, experience constant mental, emotional, or physical pain, become homeless, and/or commit suicide. This is done using well-orchestrated accusations, lies, rumors, bogus investigations, setups, framings, intimidation, overt or covert threats, vandalism, thefts, sabotage, torture, humiliation, emotional terror and general harassment. It is a "ganging up" by members of the community who follow an organised method and participate in a systematic "terrorizing" of an individual." (ibid.pg.4)

"What are the goals of Gang Stalking? The usual goal is to isolate the target from all forms of support so that the target can be set up in the future for arrest, institutionalisation or forced suicide." (Stasi tactics-Zersetzung,pg.4)

This is called "sikul memukad" in Hebrew (targeted killing)

"The Zersetzung ['decomposition' in German] of individuals was usually carried out by systematically undermining the target's quality of life (both socially and in the workplace) with the intention of simply destroying the target's confidence. The tactics used took various forms, such as spreading slanderous rumours, causing trouble at work etc. " (ibid.)

Organized harassment is a form of "Fourth Generation Warfare- is a form of political/information warfare waged against civilians by a state or other entity. It utilizes civilians and the military, indeed all of society, to target civilian adversaries (aka "domestic state enemies," "insurgents," extremists, non-state actors, "cells of fanatics," citizen "terrorists") who value national sovereignty and/or pose some perceived threat to the state's interests." ("Instruction Manual for Community Gang Stalkers").

"This[...never ending systemic[...harassment, influence and manipulation of the targeted individual [...is] specifically designed to control the target with the aim of keeping them in line or the[...] destruction (Zersetzung) [of their soul].

("Zersetzung - The East German Secret Police Methodology of Psychological Decomposition",pg.3)

"The long-term objectives of these harassment and experimentation campaigns appear to be quite fundamental; (1) induce a sense of perverted loyalty toward the very agencies engaged in the individual s harassment (2) redirect the targeted individual s feelings of hopelessness, anger and frustration toward racial and ethnic groups (3) force the individual to commit an act of violence, whether suicide or murder, under conditions which can be plausibly denied by the government." Microwave Harassment & Mind-Control Experimentation, Julianne McKinney, Director Electronic Surveillance Project, Association of National Security Alumni

"[T]he objective of the campaign is to separate a person from friends/family, keep them unemployed, induce homelessness, & reduce the quality of life so much that they suffer a nervous breakdown, cause them to commit suicide, or end up medicated, incarcerated/institutionalized."

(Rich, State-Sponsored Terror Campaigns:The Hidden Evil", pg.45).

"7. Our kingdom will be an apologia of the divinity Vishnu, in whom is found its personification - in our hundred hands will be, one in each, the springs of the machinery of social life. We shall see everything without the aid of official police which, in that scope of its rights which we elaborated for the use of the GOYIM, hinders governments from seeing. In our programs ONE-THIRD OF OUR SUBJECTS WILL KEEP THE REST UNDER OBSERVATION from a sense of duty, on the principle of volunteer service to the State. It will then be no disgrace to be a spy and informer, but a merit: unfounded denunciations, however, will be cruelly punished that there may be no development of abuses of this right.

8. Our agents will be taken from the higher as well as the lower ranks of society, from among the administrative class who spend their time in amusements, editors, printers and publishers, booksellers, clerks, and salesmen, workmen, coachmen, lackeys, et cetera. This body, having no rights and not being empowered to take any action on their own account, and consequently a police without any power, will only witness and report: verification of their reports and arrests will depend upon a responsible group of controllers of police affairs, while the actual act of arrest will be performed by the gendarmerie and the municipal police. Any person not denouncing anything seen or heard concerning questions of polity will also be charged with and made responsible for concealment, if it be proved that he is guilty of this crime.

9. JUST AS NOWADAYS OUR BRETHREN, ARE OBLIGED AT THEIR OWN RISK TO DENOUNCE TO THE KAHAL APOSTATES OF THEIR OWN FAMILY or members who have been noticed doing anything in opposition to the KAHAL, SO IN OUR KINGDOM OVER ALL THE WORLD IT WILL BE OBLIGATORY FOR ALL OUR SUBJECTS TO OBSERVE THE DUTY OF SERVICE TO THE STATE IN THIS DIRECTION."

("Protocols of the Elders of Zion", Protocol 17,sections 7-9)

B)

3 STAGES OF 'Zersetzung' ('decomposition') the terrorist protocol of the Hidden Hand:

1) Targeting (investigation and surveillance)

2) Gangstalking

3) Electronic Harassment (directed energy weapons, a.k.a 'D.E.Ws')

1)

Targeting (investigation and surveillance)

Targeting "begins with [i)]surveillance so that a person's personality traits can be catalogued." (Rich, pg.19). "Targets are constantly monitored and if a target responds emotionally to a particular trigger, that will be built into the protocol." (Julianne McKinney).

From there it progresses to ii) investigation. "The bogus investigation appears to be the platform used to launch the smear campaign & remove a person's support structure." (ibid., pg.20) "The people who organize these harassment programs will try to assassinate your character. They will carry a case file on you that they will use for character assassination & to gain community support." (ibid.)

i) Surveillance and ii) investigation:

"They will set up a base of operation in your neighbourhood to conduct surveillance." "They will sublet, lease, rent property above, below or to the sides of your living space to do this. Money is no object as they have an unlimited budget. Half-truths, setups, & outright lies WILL be used. If you re an Organized Vigilante Stalking target, the investigation is not a means to an end, it is an end unto itself." (ibid.). "Gang Stalking begins the targeted individual may at first be placed under covert forms of surveillance. The person will probably be monitored 24/7. Foot patrols and vehicle patrols may be used to follow the individual as well as electronic means as part of the monitoring, psychological profiling process. Once the psychological profile is complete, the Gang Stalking can commence."

("Zersetzung - The East German Secret Police Methodology of Psychological Decomposition")

"The first stage of Zersetzung was an evaluation of all state held data and information, eg medical records, school reports, police records, intelligence reports, searches of target's residence. At this point they were looking for any weak points (social, emotional or physical) that could be used as a way to put pressure on the target[...]that could be used to socially isolate them." ("Stasi Tactics - Zersetzung")

"[T]he group will be watching your home from their bases of operation using triangulation....Devices such as radar flashlights & millimeter wave devices, like the ones used at airports may be used such as The Life Assessment Detector System (LADS). It has a range of

about 135 feet can & can detect heartbeat & respiration. It can also be configured to track a specific person s movement inside a building." (ibid.)

"Both community-based agent (CBA) visual surveillance and advanced electronic surveillance are used." ("Instruction Manual for Community Gang Stalkers", pg. 2)

2)

GANGSTALKING

"Once the psychological profile is complete, the Gang Stalking can commence. Gang Stalking generally originates from when a covert investigation is opened on an individual and teams of plain clothes police officers, citizen informants/snitches and snoopers are deployed to obsessively harass the targeted individual usually to an extreme degree"

("Zersetzung - The East German Secret Police Methodology of Psychological Decomposition", pg.2)

"The next stage was often to supplement covert surveillance with overt observation in order to communicate to the target that they were of interest to the Stasi and to create a sense of insecurity and paranoia." (Stasi Tactics - Zersetzung, pg.4)

The Gangstalking; Organized Stalking or mobbing protocol targets both the person and their property as well as those the cabal believes they care for as a means of harming the targeted individual. The following section covers examples of particular tactics employed and the desired effect of the perpetrators though it is by no means exhaustive.

i) Property:

Thefts & Break-ins

'Thefts may be reduced to small inexpensive items. But some targets have reported jewelry, passports & other important items stolen. There is usually no sign of forced entry. This is done to let you know that they ve been in your home. These cults are obsessed with all aspects of a targeted person s life. Personal items may be passed around to group members & are apparently symbolic of the control the group has over their target." (Rich, State-Sponsored Terror Campaigns: The Hidden Evil",pg. 22)

Sabotage & Vandalism

"This happens at home & in the workplace. Electronic equipment may constantly be failing. This may be accomplished with the e-bomb or a similar device[...]Projects you ve worked on the previous day may become broken. Many times this vandalism is usually just below what you'd report to the police." (Rich, State-Sponsored Terror Campaigns: The Hidden Evil",pg. 23)

"Where the target owns substantial land, noxious activities can be arranged and built for next to the property. In one case, a dump, an auto race track, and a prison were built adjacent to a target who owned a large farm in an area of natural beauty. While this is rare, it does illustrate

commitment to delivering punishment to those “deserving” of it." ("Bright Light on Black Shadows",Dr. Rauni-Leena Luukanen Kilde, ch.18)

While this is not necessarily property damage it is a destruction of the right to the quiet enjoyment of the premises and to the market value of the property thus harming the targeted individual indirectly as with most of the gagnetalking protocols.

ii) Person:

The assault against the person is of course the ultimate purpose of the Hidden hand. The cabal targets the person a) economically;b) legally; c) socially; d) physically and 3) most importantly psycho-spiritually all of which specific forms of assault are interpenetrating given that the person is a multidimensional being whose sphere of influence participates in these spheres. The following amplifies upon how the person (T.I) is affected in these ways:

a) Economic Sabotage:

Blacklisting

"Gang Stalking groups will interfere with every personal & business relationship you have.(7) Since they are state sanctioned they can easily keep you unemployed. Job opportunities will be trashed. They get paid to make sure that you don't. Most targeted people are unemployed." (Rich, State-Sponsored Terror Campaigns: The Hidden Evil",pg. 23).

Bank accounts may be shut down or sabotaged through white collar crime; online transactions may be obstructed from other financial mediums or major or minor sellers. Attempting to sell or buy on the internet will also be obstructed through sharp practices or preventing from occurring by the perps.

Should one attempt to sell real estate he will lose on the value as with other sales as the cabal has a monopoly on the real estate industry/profession. Also any other commodity of negotiable value is subject to loss of its value if sold for the same reason (eg. bullion; collectibles; etc.)

Financial surveillance. It looks like every penny a Targeted Individual has is counted and only a certain amount is allowed for the Targeted Individual to gain or evil schemes made to bring bankruptcy or poverty to the target.

b) Legal Sabotage:

Reporting things to the police should adhere to the extensive protocols and advice outlined in:"Information Handling in the Fight to Expose and Stop the Crime of Organized Stalking and Electronic Harassment"[O.S.E.H], Eleanor White

In brief one should avoid dealing with police (see below in the section "Coping", subsection "Dealing With Police")

The cabal utilizes police both plain clothes and undercover in their O.S.E.H campaign against T.Is and they are perhaps with some exceptions involved to varying degrees, the higher up in the hierarchy they are the more compromised and more corrupt they are. Officers of the rank of

Sargeant and above are invariably freemasons who are the shabbos goy ('stupid animal' in yiddish) of their jewish masters. Hence they cannot be trusted.

Police work with private security 'professionals' (locksmiths and alarm system companies as well as private security guards and their managers) to spy on and break and enter into T.I's residences for harassment and sabotage purposes.

The legal system, being under the control of the cabal (a noahide-talmudic court which has supplanted the common law) employs lawyers and judges who will seek to railroad anyone they can frame as having violated their laws or bylaws through the system and give them the heaviest penalties they are able. Advice: trust no member of the legal profession as they are almost universally compromised and are either jews or freemasons or jewdeo-christians. 'They' are the cabal along with all other bureacrats and orgnizations private or public that all work together in their 'communitarian' spy society system (the 'Hidden Hand' shadow government).

c) social sabotage:

'Some tactics used to keep you Blacklisted include interfering with communications, & slander. Also there are lists and software packages used to check these lists for suspected terrorists, threats to national security, etc. Apparently this is a flourishing business & some organizations are required by law to use it.' (Rich, State-Sponsored Terror Campaigns: The Hidden Evil",pg. 24).

"Since they have federal connections, they do have the ability to frame a targeted person for crimes out in public as well using informants.(101, 7) Any weakness a person has can be used in one of these setups. A person may not be aware of some of these set-ups, but they may be added to a case file to assist with the smear campaign. They may try to provoke a confrontation when Mobbing you out in public.("Terrorist Stalking in America", David Lawson). Group members also try to entice the target to assault them, but this is never done without having witnesses present. The criminal conviction of the target, following the testimony of numerous concerned citizens can be followed by a civil lawsuit. (ibid. pg.23)

"Pedophilia is one common lie used to bring neighbors, co-workers, community members, and in some cases even family members into the 24/7 harassment." (ibid., 62)

In the gangstalking protocol the attempt to frame the T.I is employed through the perps following the T.I around (presumably through GPS if the T.I is implanted with a chip or through maintaining a continuous visual by pedestrian and driver perps as well as residencts being given notification via text message or alerts on their cellphones that the T.I is approaching and that they should begin a noise campaign to harass the T.I when he is in range). They often deliberately involve children and women with baby strollers and babies to have them intercept the T.I while the latter is walking along a route at a certain pace (see 'intercepts' below). He can then be photographed adjacent to the women and children and these photos shown around community members by police or other 'authorities' to convince the gullibile goyim ('cattle' in yiddish) to go along with the campaign and attempt to escalate the harassment of the T.I. Once adequate evidence is gleaned of the T.I in the context of womena nd children he may eventually have trumped up charges brought against himself to involve him in legal trouble (charged with 'pedophilia' or put on a

watchlist). Should he be jailed he may be executed by prisoners there or even by vigilantes in his community. This will also prevent him from gaining employment owing to the notoriety of his constructed identity (constructed by the cabal).

Once the T.I's reputation is irreparably damaged through smear campaigns and rumour mongering he can then be further subject to punishment by the cabal and its agents and if he complains no one will ascribe value or truth to his claims.

electronics:

"[...]additionally, T.Is "[...]may receive unsolicited email that parallels a current event in your life[...]you may receive covert insults & threats."(ibid. pg.29)

"Your email may be blocked or filtered & your web activity may be monitored[...]If you try to [...]participate in online discussions groups, online dating [...]it is very possible you will be interrupted, trashed, or harassed. This can be done by a combination of paid civilian contractors (operatives/provocateurs) & email filtering." (ibid., pg. 30)

Should one encounter any others through daily life those he encounters may very well be gangstalkers/perps themselves who are seeking to either gather information on the person or who are seeking to set him up somehow (assassination via poisoning or other means; rape; planting evidence on the person for a subsequent police investigation or raid instigated by other perps, a.k.a 'swatting', calling the police with false accusations). This may be the case even after prolonged contact with the person who befriends the T.I as they may be a deep cover agent. Also the 'friend' may be simply playing the role to subject the T.I to gaslighting and other forms of implicit abuse to wear away their sense of self-worth or to encourage them in vice such as faggotry or other deviant sex practices or drugs,etc. Anything that can be made to set the person up, sully their reputation and escalate their demise in the most cruel and traumatic way (the purpose of the Hidden Hand).

Social Control - Isolation of individuals through social and societal systems of control

Fabrication of false evidence that justifies "Crime prevention" (fabrication of evidence of a falsified crime and rumor spreading - Discrediting of Targets); In most cases, Targeted Individuals are accused of a sex crimes with no chance to defend themselves.

Sudden unemployment or redundancy, discrimination or hostility within work places.

Loss of friends, because of rumors or direct control. The perpetrators take over the friendship and social life of the TI. They are always rude, and manipulative and not real friends.

Creating "symptoms" of Mental Illness (voices in the subconscious, V2K; trying to describe what is happening for others) putting the individual in psychiatric care.

Creating "symptoms" of Substance Abuse (tampering food with drugs, poisons or medication; blurred vision; read eyes; disorientation; head aches; memory loss; difficulty talking or making sense) destroying the targeted individuals reputation;

Creating "symptoms" of Insulin related diseases (pain in the spinal cord, back of the head, terrible head aches, high blood sugar levels, enormous fatigue) creating early retirement or poverty because of inability to work.

Creating "symptoms" of hormonal imbalance. (See that you take a supplement of minerals and vitamins and take care of your glands).

Creating "symptoms" or dementia because of apparent difficulty, sometimes, to express one's feelings and thoughts; memory problems when the "attacks" are enormous.

d) physical sabotage:

The use of D.E.Ws (directed energy weapons discussed below) creates both acute and chronic pain as well as the destructive of the physical body.

The perps may poison the T.Is food not only in their residence but that which exists in the store prior to their purchasing it (this utilizes advanced technology of synthetic telepathy V2K discussed below).

Poison gas may be pumped into their residence via whatever intake vent or the perps may simply drill a hole into the wall of the residence and pump it in while the T.I sleeps (eg. nitric oxide or other forms of gas).

Harming; torturing and/or killing the animals under the care of the T.I or those the T.I is suspected of caring about.

Doctors, nurses and other 'professionals' will abuse their powers to visit harm on the T.I (vaccinations; needless surgeries that will be botched deliberately in some way; pharmaceuticals will be prescribed if possible coercively through threat of physical force to ensure compliance; other harmful procedures will be prescribed and effective natural healing modalities will be omitted to be mentioned or will be discouraged)

Noise campaigns:

"Noise must be of a type which the general public deems "normal." Remember that the goal is to have the target aware they are being punished, but not be able to convince anyone else that that is the case. Observe local noise curfews, but plenty of punishment can occur outside noise curfew times. The target must not have easy cause to involve law enforcement."

("Bright Light on Black Shadows", Dr. Rauni-Leena Luukanen Kilde, ch.18)

"[...]egs. Loud music from neighboring home; frequent squealing of tires near target's home; frequent drilling into a scrap of wood or masonry held against the target's wall, floors or ceiling as if "working." Alternatively, hammering; Frequent use of sirens near the target's home[...]" (ibid.)

"Basically, there will be a steady stream of noise consisting of a rotation of various types of disturbances around your house. This noise may even follow you wherever you go. This includes car doors slamming, people coming/going, people yelling, car alarms, horns, tires screeching,

banging, engines revving, cars beeping, constant construction, lawn mowers, snow blowers, etc. Your neighbors will probably be bribed with free home repairs that will result in a very noisy construction process[.]Chronic exposure to even low-level noise is considered a hazard that has been known to produce adverse physiological and psychological health effects. Prolonged expose to noise can produce high blood pressure, a rise in cholesterol, damage to the circulatory, cardiovascular, gastrointestinal, & musculoskeletal systems."(Rich, State-Sponsored Terror Campaigns: The Hidden Evil",pg. 28-29).

Synchronization:

"Your movements will be synchronized with noise, vehicles coming or going, people coming or going, or other movements. These synchronization tactics are often times done several times, perhaps three or more."

Noise campaigns in and around your home -

1. OUTSIDE: Using vehicles, car alarms, car horns, slamming vehicle doors, idling vehicles, loud music coming from these vehicles, Street Theater with neighbors, or strangers talking loud, or amplified sounds generally via hypersonic sound direct speakers - these are directional devices that can be inside the units surrounding the target or placed within the unit/home itself, which can be reversed in either direction.

Hence, if you hear any echos in your home, the device is being reversed so that your voice will carry. If it is coming at you, whereby, people speaking sound louder than usual, or coming from some unknown origin, it is being directed at the Target.

2. INSIDE: If you live in an apartment with connecting walls:

a. If you live below someone, this occupants will be recruited to increase the levels of noise they make. Walking heavier than usual on the floors, dropping heavy objects above your head, and shadowing the moves you make in your apartment. These occupants will also give permission to have their units be used in their absence so that other recruit's can occupy these units, to continue the 24/7 harassment of the Target.

This hypersonic sound device will also be placed upon Electronics like Refrigerators, Water heaters, anything that produces sounds and/or vibrations, which can be amplified to increase the sound levels. These devices will also be used, so that you think the sounds, voices, walking, is coming from specific area.

There will also be an influx of Fire Engines, Ambulance, and Police Vehicle who will turn on their Siren's when in close range to the Target's residence.

Also, gardener's blowers, and large trucks when in reverse will have a loud beeping.

Regardless - most of it is Amplified via the directional use of HYPERSONIC SOUND -

ACOUSTIC HARASSMENT:

Harassment can be done in a couple of ways:

1. Increased Noise timed noise in your surroundings, in particular at your private residence.

Neighbors playing loud Bass driven music, generally the speakers will be in line with Hypersonic Sound Devices - which when focused targeted sound. This means the sound can be directed at a specific target, and as such can be increased when target at you, but anyone not within its range will not hear the sound.

Neighbors will also increase the sounds they make in their apartment. In particular if you live below them. They will time their noise response, by walking heavily on the floor, to increase the harassment campaign. They will also do something called shadowing - whereby, every move you make within the privacy of your home will be SHADOWED LOUDLY. If you get up to use the restroom, you will hear footsteps following you to the restroom. If you flush the toilet, the neighborhood recruit will do the same. If you get up to go to the kitchen you will hear the upstairs neighbor do the same. If you turn on the faucet, you will hear the faucet being turned on.

These are PSYCHOLOGICAL TERROR TACTICS used by these NEIGHBORHOOD RECRUITS - in order to facilitate and harbor the Architect's whose job it is to TERRORIZE, TORTURE AND MURDER THE TARGETED INDIVIDUAL.

On the streets you will have TIMED LOUD RESPONSES - where the Privacy of Your HOME ADDRESS will be given to these Citizen Recruits. These recruits will be asked what type of vehicle they drive, in particular, vehicles that make the loudest noise, they will be assigned the task of driving near the Target's home, idling their vehicle, and making sure the Targets are aware of their presence. Recruits will also be told whenever they are in the neighborhood of the Target/s address, they will be told to simply drive by.

Much of this is done in the very early mornings when you are asleep, or in the middle of the night, generally after you have turned out the light, and are ready for sleep. During this time, you will hear much traffic, car doors slamming, alarms going on and off, honking of horns, people talking, and laughing. Banging on the walls, or loud sounds around your room that will literally wake you out of a sleep -

2. ACOUSTIC HARASSMENT using DIRECT ENERGY WEAPONIZED TECHNOLOGIES -

This type of Acoustic harassment is generally in the forms of extreme High and Low Frequencies, Piezoelectric Vibro-Acoustics, Radio Frequencies - The FOLLOWING is a list of Frequencies that can effect the Biological and Neurological make up of the Targeted Individual.

SLEEP DEPRIVATION -

There will be timed loud noise responses, in order to wake you up out of this state of rest and/or sleep. These acoustic harassments can be directional to a vehicle, an acoustic frequency, an amplified household appliance - that will WAKE YOU out of rest or sleep. This is done several times, so as to get the Target in a State that they are unable to fall back asleep. If the Target is employed, they are in a Sleep Deprived State, as such makes them less affective at work, which then allows for the process of giving the false impression of incompetence, something wrong with the Target, as such their ability to work becomes compromised due to their Overt Targeting.

Sleep Deprivation is also used to slowly break the Target down, so as to keep them in a continued vulnerable state, which makes it easier for the Terrorist Architect's to ATTACK the Target psychologically for the purpose of manipulation, set-ups, entrapment, terrorizing and intimidating the Target.

Collisions & Cut-offs:

"They can happen with vehicles, on foot, or a combination. This type of space invasion is designed to startle you & create tension. It can be thought of as a virtual slap. They are used in blind areas such as corners, hallways, restrooms, or intersections where you constantly have people or cars cutting you off, or almost hitting you. The perpetrator is unseen until he jumps out in front of you[...]With some artificially induced cut-offs, the perpetrator is seen at a distance. You & the perpetrator(s) are heading toward the same focal point. It may be a corner, a very small walkway, or a path that cannot accommodate both of you. They will adjust their timing & rhythm to yours so that they always meet you at that point, so that you will have to squeeze through, stop, or go around because of their deliberate adjustment of timing. The idea is to get your attention and make you uncomfortable." (ibid., pg.26)

Convoys of vehicles:

"If you're targeted, you may have foot & vehicular traffic "re-routed" through your street. Common practice is for vehicles to drive by screeching their tires, blowing their horns, playing loud music, revving their engines, & yelling as they drive by your house." (ibid.,pg.28)

Brighting:

"You may also be followed by convoys of vehicles that have their Hi-beams on during the day. Spot lights being shined into a target's windows is another tactic." (ibid.)

e) Psycho-Spiritual sabotage:

Sensitivity Programs:

"Cause Stalking groups usually begin their campaigns with sensitivity programs.(7) The goals of a sensitivity program are: To get the person's attention and let them know they're being harassed. Anchor damaging emotions to common objects/sounds so a target can then be covertly harassed openly in public These sensitivity programs are based on a science called Neuro-Linguistic Programming (NLP)." (ibid.pg.31)

"A stimulus which is linked to & triggers a physiological state is called an anchor in NLP. How are anchors created? First by repetition. Secondly, & much more important, anchors can be set in a single instance if the emotion is strong & the timing is right. In extreme cases an external stimulus can trigger a very powerful negative state. This is the realm of phobias." ("Introducing NLP", Joseph O Connor & John Seymour)

"You can think of NLP as a very powerful tool that can be used to produce rapid, profound change. Harassment groups create negative emotional states such as fear & anxiety, & anchor them to common objects in the environment."(Rich, State-Sponsored Terror Campaigns: The Hidden Evil",pg.31).

"Groups will take an object you've been sensitized to & link it to another object. The idea appears to be to keep expanding the amount of objects you associate fear, anxiety, anger, or shame with (sensitization)." (ibid., pg.32)

"Anyone else observing this might think it s a little strange that someone would turn their alarm on/off a few times but they d write it off as an isolated strange incident. Since they have not had your previous experience (sensitization) with that sound & are not aware that it is a small part of a much larger harassment program it would be difficult to explain what those beeps meant. In NLP, the process of copying an emotional state anchored to an existing trigger & transferring it to a new trigger, is called chaining." (ibid., pg.32)

"Anchors can be chained so that one leads to another. Each anchor provides a link on the chain & triggers the next one, just as the electrical impulse flows from nerve to nerve in our body." ("Introducing NLP", Joseph O Connor & John Seymour)

Street theatre/Harassment Skits:

"Harassment skits can be classified as a type of Street Theatre that contain verbal & non-verbal harassment, threats, insults, intimidation, & violence, conveyed overtly, or overtly using themes, symbolism, or other medium. They may be carried out after a target has been sensitized. This harassment can be relayed with metaphors, verbal remarks, and symbolism using clothing or other items. Insults or comments by strangers, designed to evoke a paranoid reaction, as well as dirty looks & negative behavior from previously friendly neighbors is common among targets." (ibid., pgs.32-33)

"Some words [used by perps in 'street theatre'/harassment skits]carry with them a particular weight to potentially trigger an effect on a person's emotional state." (ibid., pg.33)

"This is called metacommunication. Metamessages are suggestions hidden in a statement, perhaps a compliment. The tone, volume, & rhythm of specific words in the sentence are changed so that the actual message is different than what the spoken words were." (ibid.)

Symbolism:

"Symbolism appears to be a big part of subliminal attacks. After a target has been sensitized, they can even be harassed, insulted, & threatened with symbolism using articles of clothing, newspapers, & other items. Just as body communication (Social Kinesics) is used to harass a target, so too is symbolic communication. Symbolism can be used with articles of clothing, especially during a wave attack where you are blitzed by a crowd [of pedestrians or vehicles]." (ibid.,pg.35)

The symbolism used entails colour; shape and number. Certain perp cab drivers for example will have the number '33' on their cab making it visible to you and be driving a red vehicle. Orange is also used frequently, symbolizing 'light' in the darkness or the lifeforce (life) but can also be used to symbolize possession by entitites (mocking the T.I as a 'blemmye' or possessed being).

Symbolism is also associated with what is known or believed by the cabal to be related to the target. An example is the target having been in certain locations and the cabal employing drivers with vehicles whose license plates are from those regions. Another example is where gangstalkers wear clothing that bears certain words; phrases; logos or other symbol that is believed to have meaning for the T.I and to allow them to know the cabal knows about them and they are being watched or to convey a related message to the target.

STREET THEATER:

Take place around your neighborhood. These are recruit's who have been illegally given you home address, and/or is a Recruited person from within the Geographical neighborhood, who are asked to show up around the Target's private residence at all hours of the day or night, in particular if the Target is home.

The Street Theater can either be in group formation, using a number of people who will show up near your residence, starting making noise, having loud conversations, and generally the conversations they are having will be specific to the Target.

There will also be solo individual's who walk dogs, or babies, most of the time the PERPS will be on a Cell Phone - directing their conversation using Keywords that are person to the Target.

Another form of Street Theater is the use of Public Service, and/or Utilities - whereby, you will see an influx of Telecommunication, or Utility vans around the neighborhood.

In addition to the use of Streets and Transportation, whereby there always seem to be road work taking place, so that the Targeted Individual is directed into another area.

Generally, if they are trying to set the Target up to appear dangerous to children, like some type of Pedophile, or dangerous to some type of official they will direct all their so called street traffic to pass by an area like schools or where children are.

In addition, to buildings or residences of Official's or Leaders' within community Organization's to give the false impression that the Target is stalking these people or areas.

This is deployed so as to further victimize the Target by way of SET-UPS and ENTRAPMENT. The Targeted Individual innocently follows the directional signs, generally not realizing that there is another Recruit - taking photos or video at the very moment that Target shows up.

This gives the Architect's video, or photos showing the Target in some designated set up Area, so that it can be used in their FEAR-MONGERING Recruitment Process.

Another type of STREET THEATER will be used, in the forms of young recruits who will come round the Target so that PHOTOS' and/or VIDEOS can be taken to once again give the false impression that the Target was doing something nefarious. These young recruit's are on a mission of Destruction, and will be told to deploy these underhanded Tactics, so that another Recruit can capture a Specific Event, to make the Target look bad.

Example: A young female or male recruit will be told to go up to the Older Male or Female Target, and begin a conversation, or place themselves in a compromising position, so that the Male or Female Target can be photographed, or video taped with the Target - giving the false impression that it was the Targeted Individual who initiated the act.

The absurdity of the gangstalking protocol, proving it to be 4th gneerational warfare can be seen in the following quote:

“To break this down for anyone who has half a brain, and the ability to think for themselves - if the TARGET were that HORRIBLE of a PERSON, or HAD COMMITTED such CRIMES - the ARCHITECT'S behind the COVERT STAGES OF PROFILING and WARRANTLESS STALKING and SURVEILLANCE - would HAVE IN THEIR COVERT STAGES - actually HAD MATERIAL EVIDENCE”

As you shop, you will begin to notice this Retail Store begins to have an influx of people showing up, who appear to recognize who you are, but who are TOTAL STRANGER to you.

Be on the look out for some of the Terrorist Psychological Tactics these Citizen Snitches will deploy in public settings:

Stare at you, point, whisper and/or giggle as you walk past them.

Have directed conversations either with the person they are with (group), or on a cell phone and use keywords as they pass, to let you know they are Citizen Snitches for the State

Psychological pain

Bullying at work, friends and family suddenly lost leading to Isolation.

Bullying in general. Because of what appears, as social problems with other people, the Targeted Individual moves to a place where the “attackers” and the “manipulators” can spread around any kind of rumor for people in the neighborhood and can take control in another way.

Gang stalking (rude people in crowds that appear and insult the individual, using both verbal and non-verbal communication). Having 20 people, or more, strategically placed to for example look with a hateful look at the Targeted Individual. They are all strangers, they are all rude. They appear every time the TI is outside, and it can take many different expressions. Sometimes it looks like they have some kind of scheme and the harassment follows a pattern, and when it achieves a certain stage, they reset themselves and it starts all over again.

Street Theater: A group of people play out a whole show for the individual, and it appears to follow a predetermined plot. Following the Targeted Individual’s thinking. The thought surveillance is perceived as humiliating. The home is entered and the perpetrators don’t steal things, but can destroy them or they can leave objects that don’t belong there. They often seem to enter with a key, because the doors are not forced. Thefts in town, at airports: money of belongings. Destroyed means of transportation: car or bike.

The use of COLOR is to:

1. Terrorize the Target into letting them KNOW of the CIVILIAN COLLABORATIVE EFFORTS taking place UPON and AGAINST their HUMAN LIVES.
2. As a CALL SIGN to let other INDOCTRINATED, and BRAINWASHED CULT MEMBERS' for this STATE and CORPORATE SPONSORED DOMESTIC TERRORIST ORGANIZATION KNOW - they are WORKING AS A TEAM to DESTROY THE HUMAN LIFE of the SOLO TARGETED INDIVIDUAL.
3. As a way to psychologically CONDITION the Targeted Victim of this Domestic Terrorist Organization -

Total lack of support

When the Targeted Individual meets health professionals they are not interested in what the TI tells them. Symptoms are treated in the "old fashioned" way.

Many times TIs are forced to take the wrong medication and to agree to sometimes stigmatizing labels in order to receive their pension.

In certain countries, the TI, can be forced into psychiatry, where total loss of human rights occurs.

Blacklisting often leads to inability for the TI to find work, or has to accept a job way under their specialization. At the new job, the TI is constantly under harassment and is bullied.

The police participates in the harassment and is totally insensitive to what the TI goes through.

The media ignores the TI-cause.

Cyberstalking:

The same goes for other units within, who will also be recruited, and given access to cyber capabilities, in order to without warrant, and illegally monitor what the Target may be doing within the privacy of their home via cable, internet, and telecommunications. They will also be queued with keywords to use when the Target is within hearing distance, so that they can repeat what the target may have been doing in the privacy of their home, to include what they were watching on television, websites they were viewing, to what they are reading, and then mimicking that very show, website, chapter of the book, etc. back to the Target to let them know or give the impression that they are MONITORING every move the Target makes.

SET UPS - you will find being the victim of Organized Terrorist Stalking -

The Perpetrator's of all crimes being committed against you as a Targeted Individual - are in many cases the same people who will then turn around in a reverse projection and pretend to be the victims of the insidious violence a Targeted Individual is being forced to endure.

The truth, these are well organized double-speak tactic that are used to further victimize the Targeted Individual, these so called - PERP VICTIMS are simply ACTORS who are used to further set up and destroy the target in order to meet their FINAL OBJECTIVES.

DEATH

The GANGSTALKING program can be described as a long term and slow DEATH with the constant life event of psychological and physical attack and torture. During any of the five levels the GANGSTALKING agents have it within their power to take a Targeted Individual out and mark the target for DEATH, and no one will be the wiser that the person was actually murdered by the SECRET push of a button.

STAGES OF GANGSTALKING: 1)-6)

The GANGSTALKING Program Targets Every Aspect Of The Person

The first four levels of the GANGSTALKING program are specifically designed to target as follows:

1. Level one mainly targets the IGNORANT.
2. Level two mainly targets the MIND.
3. Level three mainly targets the HEART.
4. Level four mainly targets the BODY.

1. GANGSTALKED (IGNORANT)

At this level, the Targeted Individual is IGNORANT of the fact that he or she is a Targeted Individual because the GANGSTALKERS are more covert in their tactics. This is the period of time that the GANGSTALKERS watch the Targeted Individual and spend time gathering background information such as habits, health, sexual orientation, illegal activity, and people and places the Targeted Individual likes to visit. I believe that most of the people on earth are at this first level IGNORANT stage. They are IGNORANT that a GANGSTALKING program exists just as Targeted Individuals were once IGNORANT of it "before" they became targeted.

Second Level Of The GANGSTALKING Program

The second level of the GANGSTALKING program is as follows:

2. GANGSTALKED (FOLLOWED/SURVEILLED OVERT)

At this level, the GANGSTALKERS keep their distance away from the Target Individual and away from the belongings of the Targeted Individual, but they FOLLOW and SURVEIL the Targeted Individual on foot or by vehicles, in an OVERT manner with COLORS OF UNITY, BODY GESTURES, STARING, STREET THEATER, MIMICING, DIRECTED CONVERSATIONS, SYMBOLS, WORDS, NUMBERS, and SOUNDS such as NOISE CAMPAIGNS, COUGHING, and CLEARING OF THROAT

3. GANGSTALKED (CONFRONTATION And ENGAGEMENT)

At this level, the GANGSTALKERS enter the personal space of the Targeted Individual in some cases for insincere intimate relationships and insincere friendships. The GANGSTALKERS want to CONFRONT and ENGAGE the Targeted Individual in person through conversation and interaction. The GANGSTALKERS seek opportunity to insert themselves into the life of the Targeted Individual. Some of the GANGSTALKERS may use "touchy-feely" gestures of familiarity such as a tap on the shoulder or pat on the hand but not in a violent way.

"Honey trapping is an investigative practice utilizing romantic and/or sexual relationships for an interpersonal, political or monetary purpose to the detriment of one party involved in this romantic or sexual affair. Investigators are also often employed by wives, husbands, and other partners usually when an illicit romantic affair is suspected of the "target", or subject of the investigation.[1] Occasionally the term may be used for the practice of creating an affair for the purpose of taking incriminating photos for use in blackmail. A honey trap is primarily used to collect evidence on the subject of the honey trap."

Note: Beware of the “honey trap” agent at level three.

There are There are two types of ELECTRONIC HARASSMENT as follows:

1. ELECTRONIC HARASSMENT with mainstream technology and devices
2. ELECTRONIC HARASSMENT with secret advanced technology and devices

Fourth Level Of The GANGSTALKING Program

4. GANGSTALKED (CRIMINAL ACTIVITY)

At this level, the GANGSTALKERS are hands-on and physical. The GANGSTALKERS are, dispatched to commit crimes against the person and property of the Targeted Individual such as breaking and entering the home of the target to commit crimes of theft and property damage. They may be dispatched to commit criminal activity and harm against the person of the Targeted Individual and/or against persons or animals associated with the Targeted Individual such as to “gaslight”, rape, beat, and poison.

4. GANGSTALKED (ELECTRONIC HARASSMENT WITH MAINSTREAM TECHNOLOGY AND DEVICES)

After the GANGSTALKERS physically enter the home of the Targeted Individual, their criminal activity may include but is not limited to the installation of cameras, listening devices (“bugs”), GPS tracking devices, RFID microchip tracking devices, computer keylogger software, malware, viruses, and trojans. Home phone and cellphone hacked. Computer hacked. Manipulation of utilities. Home security system hacked.

5. GANGSTALKED (ELECTRONIC HARASSMENT WITH SECRET ADVANCED TECHNOLOGY AND DEVICES)

At this level, Targeted Individuals are exposed to attacks and torture with advanced technology and devices which can be administered from a remote location. The GANGSTALKERS have the ability to rape, beat, and poison Targeted Individuals from a remote location through the invisible POWER OF THE AIR with directed energy weapons 24/7.

Electromagnetic Energy Targeted To The Brain

Inventor: Joel Steven Goldberg

<https://www.google.com/patents/US20160375220>

“Method to maintain peace through electromagnetic energy targeted to the brain

Patent: US 20160375220 A1 (Filing date: March 1, 2016)

Using the Belousov-Zhabotinsky (B-Z) reaction as a model of brain activity, an early prototype of this weapon was developed. In order to prevent another arms race this technology should be assigned to the United Nations.”

Electromagnetic Energy Targeted To The Brain

Abstract (Partial Excerpt)

Patent: US 20160375220 A1

“Concentrated extremely low frequency (ELF) electromagnetic waves can penetrate the cranium in the most conductive portion of the skull, the pterion-temporal lobe intersection, and produce effects in the anterior temporal lobe that contains the amygdala. Remote stimulation of the temporal lobe may cause lethal or incapacitating seizures. Stimulation of the amygdala produces fear in a high percentage of humans and in some instances respiratory depression.”

Amygdala

<https://en.wikipedia.org/wiki/Amygdala>

“The amygdala (plural: amygdalae; /ə'mɪgdələ/; also corpus amygdaloideum; Latin, from Greek ἀμυγδαλή, amygdalē, ‘almond’, ‘tonsil’[1]) is one of two almond-shaped groups of nuclei located deep and medially within the temporal lobes of the brain in complex vertebrates, including humans.[2] Shown in research to perform a primary role in the processing of memory, decision-making, and emotional reactions, the amygdalae are considered part of the limbic system.[3]”

“Location of the amygdalae in the human brain”

Amygdala Function

<https://en.wikipedia.org/wiki/Amygdala>

“There are functional differences between the right and left amygdala. In one study, electrical stimulations of the right amygdala induced negative emotions, especially fear and sadness. In contrast, stimulation of the left amygdala was able to induce either pleasant (happiness) or unpleasant (fear, anxiety, sadness) emotions.[9] Other evidence suggests that the left amygdala plays a role in the brain’s reward system.[10]”

Electromagnetic Energy Targeted To The Brain

Inventor: Joel Steven Goldberg Claims

Patent: US 20160375220 A1

Having described my invention, I claim:

1. A method to produce behavioral changes in a human from remote transfer of electromagnetic energy to the temporal lobe of the brain.
2. The method of claim 1 where electromagnetic energy is transferred to the amygdala.
3. A method to produce a seizure in a human by remote transfer of electromagnetic energy to the temporal lobe of a human.
5. GANGSTALKED (ELECTRONIC HARASSMENT WITH SECRET ADVANCED TECHNOLOGY AND DEVICES)

The GANGSTALKING agents have the ability to hack into the brain of the Targeted Individual to induce realistic “hallucinations” that affect the five senses of sight, hearing, taste, smell, and touch of the Targeted Individual. The dreams of the Targeted Individual can be manipulated.

Fifth Level: V2K (Voice To Skull)

<https://www.theverge.com/2017/4/24/15406882/ai-voice-synthesis-copy-human-speech-lyrebird>

The GANGSTALKING agents have the ability to transmit sound such as voices into the head of the Targeted Individual that others cannot hear which mimic schizophrenia. Targeted Individuals call this ability V2K (Voice To Skull). The GANGSTALKERS can clone voices to sound like people you know who are alive or dead.

The Five Senses

“Five senses and the respective sensory organs inherent among Homo sapiens”

After the brain of the Targeted Individual is hacked, the GANGSTALKERS can access the physical body of the Targeted Individual to induce sensations such as pain and various illnesses. The GANGSTALKERS can electronically rape, electronically induce orgasms, and electronically make a person impotent. The GANGSTALKERS can manipulate vital signs such as the body temperature, blood pressure, pulse (heart rate), and breathing rate (respiratory rate).

The GANGSTALKING agents have the ability to read the mind of the Targeted Individual. The technology used enables the Targeted Individual to hear his or her own thoughts in a type of speaker mode. The GANGSTALKERS can demonstrate their ability to mind read by repeating back the unspoken thoughts of the Targeted Individual to the Targeted Individual. It is a type of synthetic telepathy. Targeted Individuals cannot hide anything.

Sixth Level Of The GANGSTALKING Program

DEATH

It appears to be used to BREAK the Targeted Individual down, to the point of suicide. To get these highly functional Target's to become dysfunctional. It is in line with REVERSE ENGINEERING, whereby the purpose is to with premeditated malice, break down every aspect of the Target's life. In particular, to break down their cognitive abilities in processing, thinking outside the box, and to GIVE UP on questioning THOSE WHO DARED to Target them to begin with.

Thus, the MAJORITY of what is deployed is in line with Survival Evasion Resistance Escape (SERE) Prisoner of WAR training which, generally Elite Active Military are sent to in order to SURVIVE should they become a captured Prisoner of War, but most of all to see how long it TAKES to LITERALLY BREAK their HUMAN PRISONER'S by using a MYRIAD OF PSYCHOLOGICALLY TRAUMATIZING, TERRORIZING, and HARASSING METHODOLOGIES.

As such, the Target, will be BOMBARDED on a 24/7 basis in Psycho-Traumatology (which examines factors that enhance psychological resilience in the face of traumatic experiences.) and see how their Non Consenting Human Guinea Pigs a.k.a. Targeted Individual can rise above, and SURVIVE though the TORTURE and TERRORISM being inflicted upon and against them.

The more RESILIENT and CAPABLE the Target is at SURVIVAL, the MORE AGGRESSIVE, VIOLENT, TERRORIZING, and TRAUMATIC these ORGANIZED TERRORIST'S will INFLICT, in their TERRORIST CRUSADE TO DESTROY.

3)

Electronic Harassment (directed energy weapons, D.E.Ws)

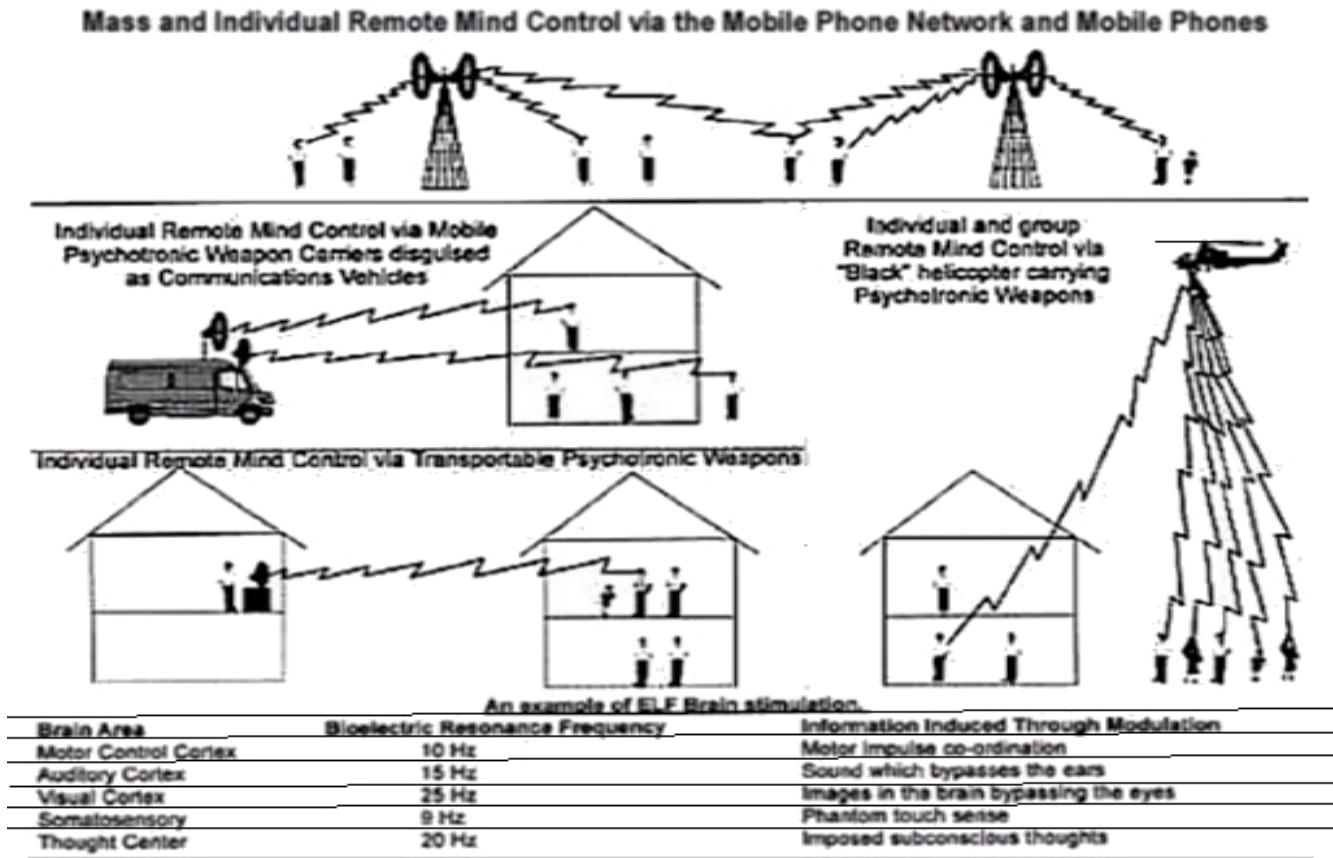

i) proof it exists and how it functions:

What are Microwave/Directed Energy Weapons; how do they work and how are they used:

"Precisely modulated microwave radiation is used to influence brain function. Human behaviour and reactions can be entirely controlled by using pulse modulated microwave EM[F]* radiation. Pulse modulated microwaves are useful as the carrier for the mind control signals as they are able to pass through the skull, which is rather resistant to low level EM[F]."

("Microwave Mind Control", Tim Rifat) *electromagnetic fields

"It was found that when microwaves were used to fire these signals at victims' brains, they experienced the moods, behaviour, and the pathological states, carried by the signals. This meant that by mimicking natural brain frequencies, the human brain could be controlled remotely by use of extremely low frequency broadcast carried by pulse modulated microwave beams (ELF pulse modulated microwave remote mind control technology)." (ibid.)

"It is now possible to broadcast mind control commands directly into the brain by use of microwave beams. All that is needed is a catalogue of every specific brain frequency for each: mood, action and thought." (ibid.)

"Particular excitation potential, is then broadcast by pulse modulated microwave transmitter. This pulse modulated microwave beam has the ELF excitation potential frequency imprinted upon it. It was found that each behavioural set in humans had a distinctive frequency. There was one for: anger, suicide, hysteria, trauma, serial killing, paranoia, lust...etc." (ibid.)

Non Lethal Microwave Weapons	
<u>Frequency</u>	<u>Illness Caused</u>
4.5 Hz	Paranoia;
6.6 Hz	Depression/Suicide;
8 Hz	Animals fall asleep;
11 Hz	Manic behavior/Anger;
25 Hz	Blindness if aimed at the head; Heart attack if aimed at the chest.
Other frequencies cause hysteria, trauma, lust, murder and cancer, and may all be induced.	

Cabal Operatives "have sophisticated millimetre wave scanners to look through the victims' walls, so they can see the targets' in their homes. Pulse modulated microwaves are regularly directed at the victims' brains, while other people in their homes are oblivious of what is going on." (ibid.)

"Some of these Directed Energy Weapons (DEW) are Through-The-Wall (TTW) in nature. These devices or a similar ones are currently being used on citizens in North America & other NATO nations. It is likely that the perpetrators are using radar/Millimeter wave technology similar to the ones used in airports to pinpoint a person s location in a building and assist with aiming other DEWs at people." (Rich, State-Sponsored Terror Campaigns: The Hidden Evil", pg. 38)

Torture: Physical, Mental & Psychological - Physical pain due to ICT-Implants + non-lethal weapons.

Direct pain in the body around the clock that tends to get worse and more severe due to ICT-Implants or other kind of transmitting devices, often labeled by Targeted Individuals as non-lethal weapons, Directed Energy Weapons (DEWs), Electromagnetic Frequency (EMF) or simply radiation.

Pain in the spinal cord or back, lethargic and aching pains.

Pain in the back of the head (Cerebellum) or various regions responsible for memory and imagination.

Pain in the "amygdala" or the limbic system. Pain in the forehead or frontal lobe (induces scattered or slurred speech).

"Cooked" brain (slight heating of the brain or Hypothalamus to induce synthetic emotional states or stress disorders (ELF waves can also cause depression or stress tuned at 6.6Hz).

Electroshocks in the brain, Zaps and mild shocks; Involuntary body movements caused by nervous system shocks and attacks.

Pain in the chest, Palpitations and Adrenal rushes.

Toothache, gum bleeding and pain in gums or teeth or in Jaw and glandular regions.

“Mild Heart attacks” or slowed heart beats, panic attacks and chronic anxiety and fast paced heart beats.

Pain in vital organs: liver, stomach, heart, lungs, eyes, genitals amongst other places

Itching eyes – leading to tears and red eyes, beams alike a pin prick or irritation.

Food is poisoned, contamination by evil Perps in food stores or restaurants etc..

Air around your nostrils heated or lacking oxygen.

Electronic sexual “rapes” during sleep or while awake, probably with ICT-implants, unnatural genital stimulation or swelling.

Image of microwave radiation is pulsed into the house. “Abuse of microwave weapons against civilians inside homes.”



Modded or modified satellite dish for radiating microwaves

Microwave in the apartment and the antenna for radiating micro waves in the flower box.



Microwave magnetron device torturing from the briefcase in car.

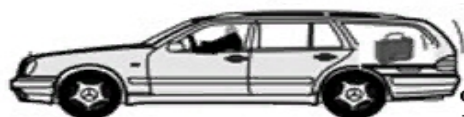

Generator / condenser / flat antenna for radiating microwaves.

THIS IS WHY SO MANY NEIGHBOR HOMES ARE SET UP USING THIS TECHNOLOGY IN THE TARGETED INDIVIDUALS COMMUNITY.

NOTE: NEIGHBORS ARE TOLD IT IS NON LETHAL TECHNOLOGY, BUT NON-STOP ATTACKS, WHICH MANY REPORT LEAD TO SLOW KILL FROM ONGOING RADIATION. THE EFFORTS ARE OVERSEEN FROM OPERATION CENTERS VIA REAL TIME / SATELLITE SURVEILLANCE.

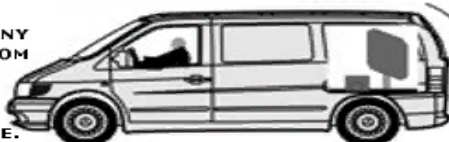

MICROWAVE WEAPON TRIANGULATION

“Military and intelligence agencies have developed frightful electronic weapons in black budget projects the last decades. These weapons, based on radio waves, are used to disable, to present pain and torture, to drive into suicide, schizophrenic or criminal behaviour. This is done by cooking/irradiating body parts, letting a victim hear voices, reading the mind, etc. through walls and from distance. “

<http://www.stopeg.com>

“The new generation of electronic weapons is capable of burning and cooking humans, destroying (exploding) body tissue, or cause heart attacks. This is all possible from large distances (hundreds of meters) and through walls. These weapons are now (2008) being used at large by secret services to eliminate people: incapacitate, drive into suicide, insanity, criminal behaviour, or are just used to cause heart failure, brain damage, etc. They replace knife, bullet, poison, car accidents.” (ibid.)

Examples:

Heated body, feeling sick like having the flu; Headaches that come and suddenly disappear; Sting sensations like a fly or mosquito; Blurred vision; Irresistible coughing; Very serious diarrhea; Heart attack/cramps; Kidney pain; Excessive burping; Excessive farting; Stomach pain; Stomach bubbling; Intestinals cramps; Pain in the legs; Pain in ankles; Heel muscle ;Reduced strength in hands; Aging the body, etc.

There are 5 types of technology being used in the targeting:

(1) Smart Meters

(2) Microwave Satellites

(3) Cell Towers

(4) Drones

(5) Portable units

(1) Smart Meters

The smart meters are readily controlled from a remote location, which allows the government criminals to harass an individual with plausible deniability. This is one of the first steps taken against a new Targeted Individual. The microwave signal is transmitted thru all of the household wiring. If you are exposed to microwaves coming from all directions, the first possible solution - is to switch off certain circuit breakers at the breaker box.

(2) Satellites

The first microwave attack satellites were launched under President Reagan's Star Wars program (SDI) in 1987. These satellites were designed to disable ICBM nuclear missiles during the ascent phase. Tracking frequencies used are 3600 - 3750 MHz, and the attack signal is 3920 - 3935 MHz. FCC frequency allocation tables, confirm the use of these frequencies. These satellites and frequencies are now being used against Targeted Individuals. The tracking signal has an accuracy better than 1 centimeter, and the GPS coordinates can be relayed to a cell tower or drone for additional targeting. These tracking signals come from a satellite that is directly overhead.

Generally, it takes about 30 - 50 feet of concrete and steel (or packed earth) to shield against the satellite microwave beam. Tall skyscrapers can provide a temporary shelter from the satellite targeting. The technology does have its limits, which is good news for TI's. A faraday cage that is properly designed and properly grounded can block some of the microwaves. However, improvements can be made by using A/C voltage grounding on the faraday cage, which will "consume" the narrow beam and take it to an external grounding rod. Please DO NOT attempt such modifications unless you know what you are doing. The satellite tracking and Vircator microwave weapon uses a narrow beam at low voltage (about 10 millivolts) and high amps.

3) Cell Towers

Magnetron microwave signal generators have been installed on many cell towers in urban areas. These devices can be identified as the vented enclosure boxes on a cell tower. The magnetrons become very hot while operating and can be seen on an infrared camera photograph (you can rent an infrared camera at Home Depot). Typical frequencies are 2400 MHz and 2550 MHz. The USAF criminals have started synchronizing the cell towers to automatically follow a specific point on your body - so that as you drive down the freeway, it will automatically transfer to the next cell tower and continue to hit the same location on your body. Use the hand technique to identify which cell tower. We encourage all TI's to pay attention to the construction and repairs at cell towers - get the vehicle number/license plate and company name of anyone that is working on a cell tower. Please send this information to us. If you are convinced that your neighbors are directing microwaves at you, please consider that it is probably coming from a cell tower that is 1 or 2 miles away. The microwave beam can travel straight through many houses. It is possible to use your fingers to "feel" the direction of the microwave beam. Hold your arm out with your palm facing you, in the direction of the beam, and you can feel the "pop" in your finger joints when the beam hits them. This will usually direct you to the cell tower, where it is coming from.

(4) Drones

This also includes commercial aircraft of varying sizes. Small planes especially are used to fly over one's residence and beam the T.I with scalar waves as well as helicopters which are employed to tail after one in urban centers for example.

A good source to track the flight paths of aircraft to determine if one's residence is targeted and by whom is: planefinder.net or flightradar24.com

(5) Portable units

These small microwave generators are used to harass Targeted Individuals that find temporary cover inside tall buildings or underground shelters. They come in small box enclosures, about the size of a small microwave oven.

<https://www.righthouse.com/technology-for-tis.html>

ii) What particularly is intended through the use of microwave/D.E.W weapons:

"When firing microwave beams through walls at one specific target, every material in the way of the microwave beam attenuates or modifies the intensity and frequency of the beam. Since precise frequencies and intensities are needed for mind control, very sophisticated microwave arrays and computer programmes had to be developed so that the microwave beam could be changed in response to the materials which lay between the target and the weapon, as the victim moved around the house. To do this, the reflectivity and refractivity of the materials between victim and weapon had to be analysed in real-time and fed to a computer which could

change the microwave array in concert with the changing environment between victim and weapon, as the target moved around his/her home. Secondly, there had to be an automatic interrupter if another person walked in front of the beam. The victim needed to be driven mad or disabled, without anyone else being aware that he or she was being targeted. The technology for this was very complex but eventually it was perfected."

("Microwave Mind Control", Tim Rifat)

"[B]y beaming the excitation potential of a particular pathological mental state at your brain while you are at home[...certain brain states/emotions can be induced." (ibid.)

Microwave DEWs will produce dizziness, burning, headaches, eye problems, damaged nervous system & internal organs, heart attack, & an inability to concentrate. A common microwave oven can be turned into a DEW by modifying the appliance to operate with the door removed. It can then be positioned against a wall to attack someone on the other side. You can also build a weapon for a few hundred dollars that will employ a more focused attack.", (Rich, State-Sponsored Terror Campaigns: The Hidden Evil",pg. 38)



"the intelligence operatives can place sounds and speech in the target victim's brain. This inter cerebral hearing is used to drive the victim mad, as no one else can hear the voices transmitted into the brain of the target." ("Microwave Mind Control", Tim Rifat)

"Transmission of auditory data directly into the targets' brains using microwave carrier beams is now common practise. Instead of using excitation potentials, one uses a transducer to modify the spoken word into ELF audiograms, that are then superimposed on the pulse modulated

microwave beam[...which causes] the Targeted individual to hear the voices transmitted into the brain." (ibid.)

used as a clandestine assassination tool:

" If the [targeted individual] needs to be made temporarily ill, microwave beams containing the signal the brain gives off during a vicious bout of flu can be fired at the victim. This causes the target to display all the symptoms of flu, even though they have not caught the virus."(ibid.) An example of this is how the 5G network is coordinated with the manufactured corona virus or similar 'pandemics' to dialectically engineer the Cabals' plans through 'creative destruction'."(ibid.)

"can also use low level microwaves to cause mental and physical confusion that leads to illness. Beaming microwaves at victims makes them fatigued, damages their immune system, causes neurological damage that effects their thinking, and ability to carry out tasks, induces premature ageing, cancer and cataracts." (ibid.)

"Heating the victim to death, by microwave cooking is caused by increasing the field intensity of the radiation, to cause local hot spots in the victims' eyes and gall bladder, which have poor circulation, so cannot carry away the heat. Irradiating the optic nerve of the victim with the same signal that is sent to the brain by this nerve, causes the nerve tissue to overload. In this way, subversives can be blinded by the intelligence community without them knowing what has occurred." (ibid.)



MICROWAVE WEAPON

"Neurological research has found that the brain has specific frequencies for each voluntary movement called preparatory sets. When you pick up an object, there is a specific preparatory set for this action. By firing at your chest a microwave beam containing the ELF signals given off by the heart, this organ can be put into a chaotic state, the so called heart attack." (ibid.)

"Paralysis can be induced in the target by use of this method of broadcasting preparatory sets encoded on microwave beams. A pulse modulated microwave beam, carrying an ELF signal, which is identical to the one in the motor neurone centre of the brain, is used to jam the victim's motor co-ordination." (ibid.)



GANGSTALKER'S ARSENAL

INDIVIDUAL TARGETED INSIDE OF BUILDING (CROSS SECTION)

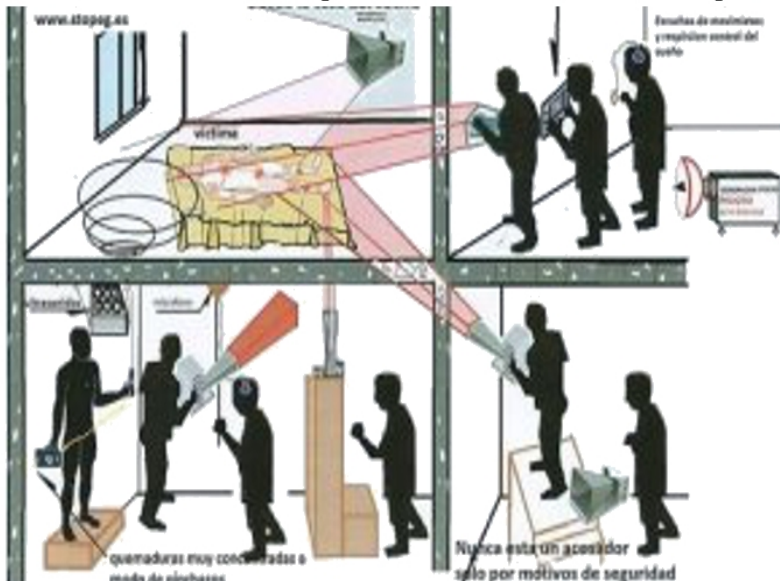

TARGETED INDIVIDUAL INSIDE BUILDING

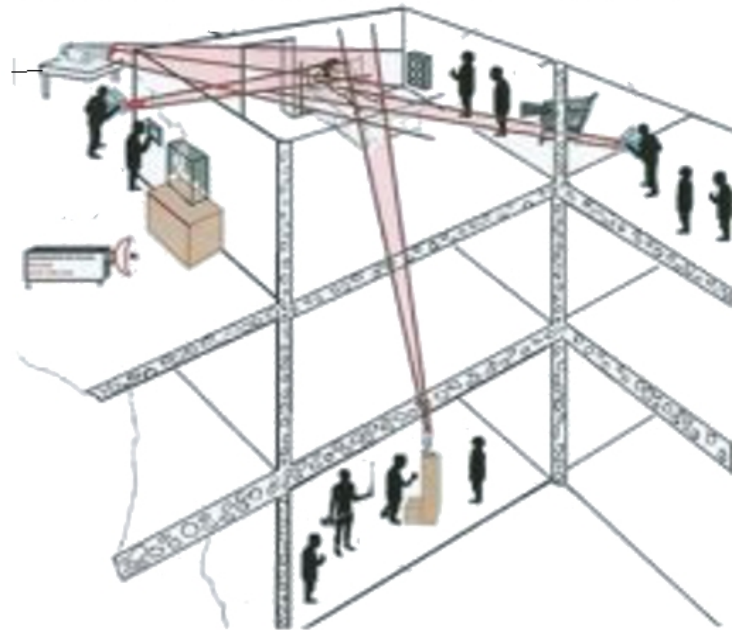

synthetic telepathy (remote thought reading/implantation of thoughts):

"The latest advance in electronic mind control were discussed in my previous articles in Nexus, but for those who missed the ESP of Espionage, this equipment uses special types of microwave beams called MASERS. These are the laser equivalent of microwave beams. These MASER beams have been used to develop something called synthetic telepathy. This is the ability to read peoples' minds from a distance. Electronic scanning of victims' brains by monitoring the

electromagnetic (EM) emissions from peoples' brains and using amongst other things, the brain waves (as measured on an EEG), to read the victim's subvocalised thoughts." (ibid.)

"Synthetic telepathy detects the 15Hz, 5 milliwatt auditory cortex brain emissions, that are linked with the excitation potentials in the brain associated with subvocalised thought. New technology, involving low frequency microwaves and RF, has enabled devices to be built which can scan through walls and look inside peoples' bodies like X-rays. This enables security personnel to see a target in his own home and to track him throughout the house. Further to this, being able to see inside the victim's head, would allow computer controlled targeting of specific brain centres in the victim's brain, even when he was walking around the house." (ibid.)

"A scan of the specific brain emissions given off when the victim subvocalises using an array of pulsed frequency MASERS fired at the specific brain centres of the subversive, while he resides in his own home, enables the victim to be scanned. By firing an array of ELF pulse modulated MASERS, which scan up and down the window of frequency emissions given off by subvocalised thought, interference effects can be measured in the MASER beam. The victim's ELF brain emissions will interact constructively or destructively with the pulsed frequency MASER carrying ELF in the ELF window associated with subvocalised thoughts. If we fire an array of pulsed MASERS, which are out of phase with each other, extraneous noise can be filtered out in the digital domain. Since the converging ELF modulated MASERS are being effected by the low level emissions in the victim's brain, the shifts in the ELF pulsed signal going into the subversive's brain can be detected. A simplistic version of this would be the LASER beam shone at the window of the person that is being bugged. The vibrations in the window cause modulations in the LASER that can be converted into electrical signals and hence into sound. In this way the subvocalised thoughts in the victim's brain can be read. Having already built up a library of excitation potential signatures for differing words and groupings of words, a sophisticated computer can begin to decode the emission signatures into word streams. In this way the subvocalised thoughts of the victim can be stored in the memory of a supercomputer and analysed to give a read out of what the target is thinking.[...]Using ELF audiograms carried by a single pulse-modulated Maser, subvocalised thoughts can be placed in the victim's brain. This enables [Cabal] synthetic telepathy operators the ability to enter into conversations with the subversive to drive him mad or to bring up key words which will get the victim thinking about the information they wish to find. Visual cortex excitation potentials can also be broadcast into the victim's brain so that illusory images can be projected into their brain to drive them mad, or to programme them to commit suicide." (ibid.)

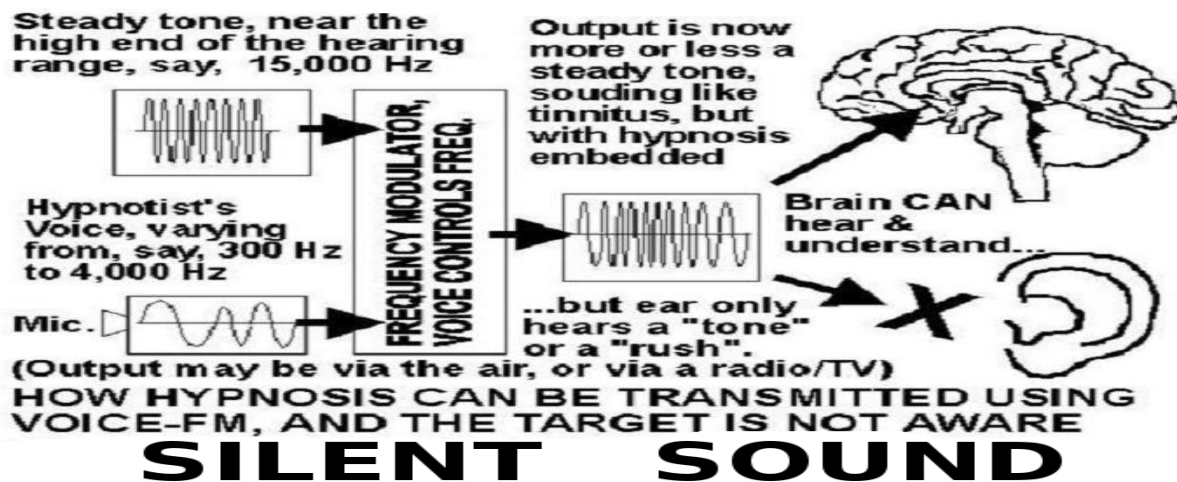
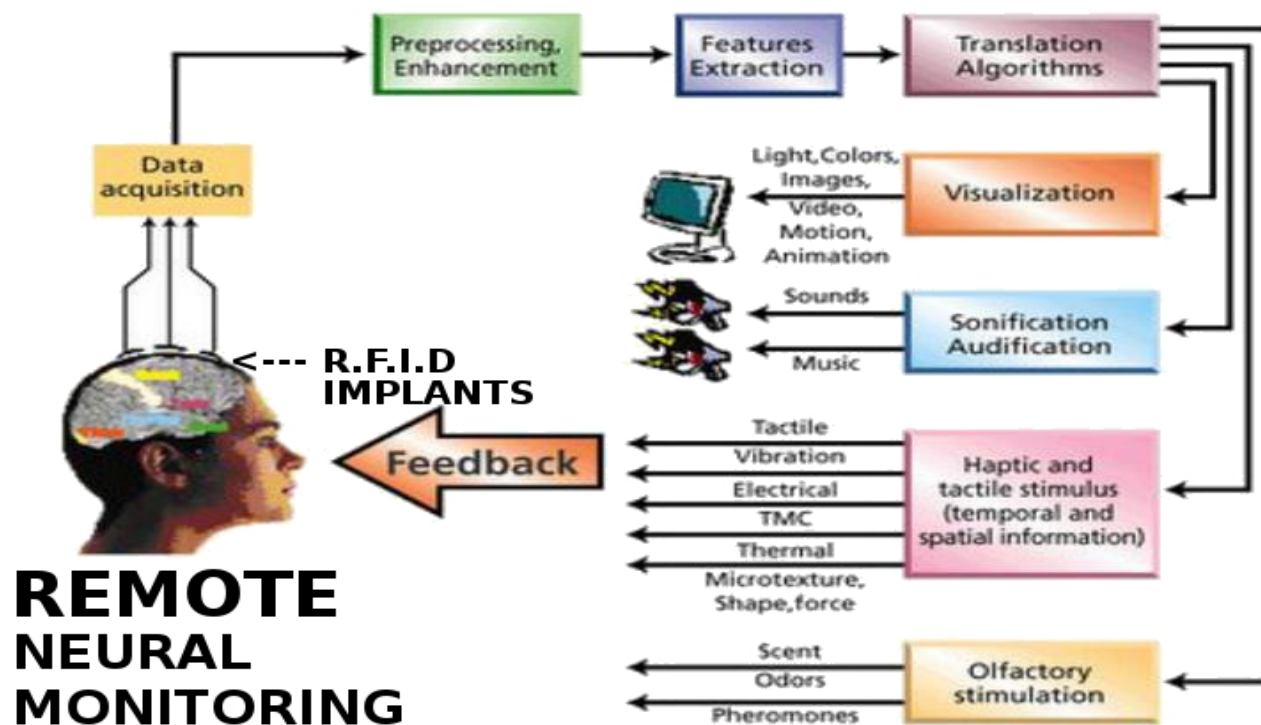

"Secondly, the police have been granted the exclusive use of the 450 MHz microwave frequency range.[...]Dr.Ross Adey found that by using 0.75mW/cm² intensity of pulse modulated microwave at a frequency of 450 MHz, it was discovered that an ELF modulation could be used to control all aspects of human behaviour" (ibid.)

Examples of Directed Energy Weapons(Through-Wall Electronic Weapons):

A simple microwave oven, door removed, with the door interlock switch bypassed, and held against the bedroom wall of a target in an apartment building or semi-detached house. This device can cause a variety of disabling medical symptoms. Some of the symptoms of microwave exposure are: Asthma, cataracts, headaches, memory loss, early Alzheimer's, bad dreams, depression, fatigue, concentration loss, appetite loss, heart and blood pressure problems, and

cancer. ("Coping With the Crime of Organized Stalking and Electronic Harassment", Eleanor White, pg.51)

HOW REMOTE D.E.WS (DIRECTED ENERGY WEAPONS) WORK

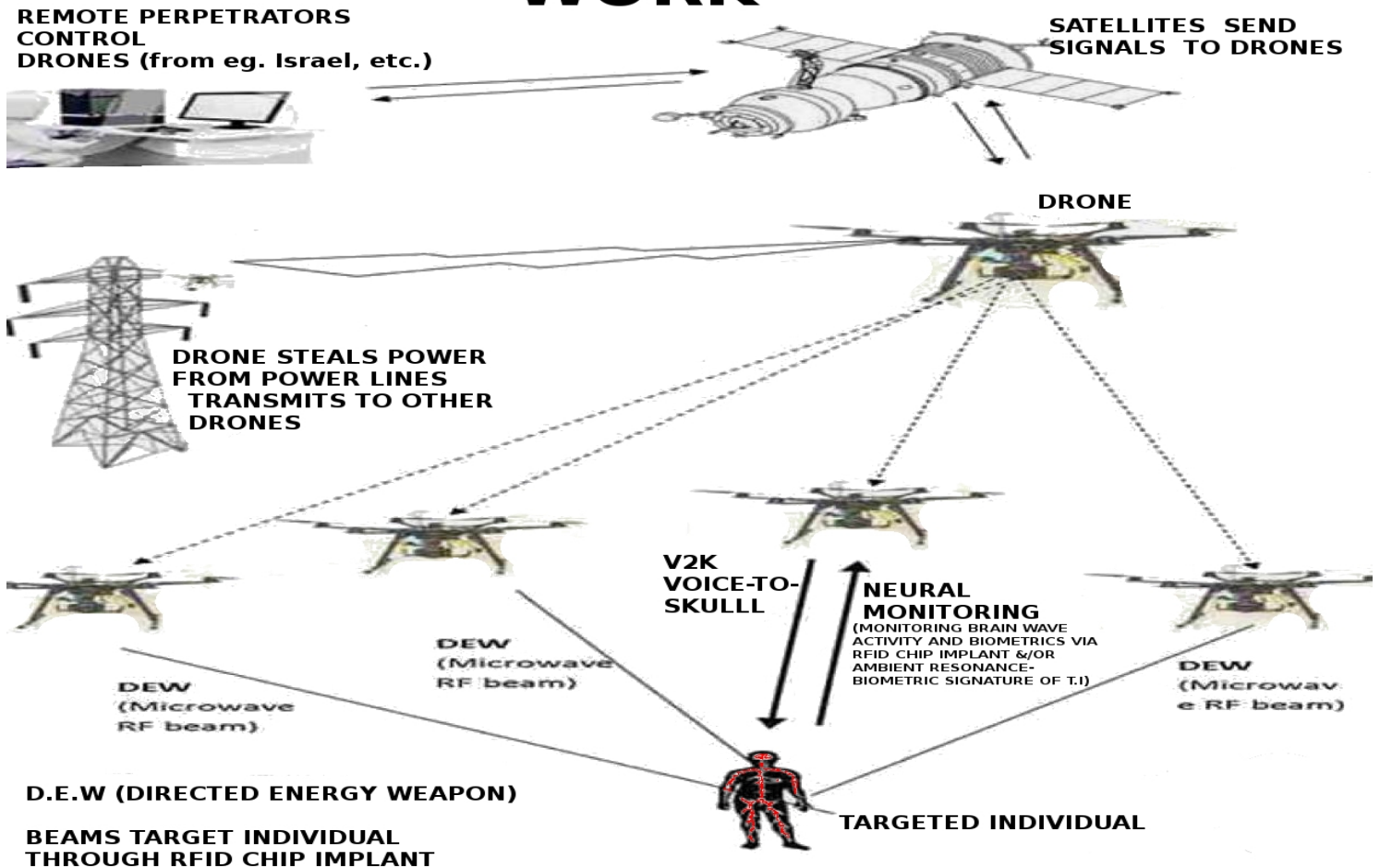

LIDA

The Russian LIDA machine (patent 3773049) is an old brain entrainment device used for the drugless sedation of mental patients. This device can be used as a weapon to drain a person of energy. The pulse rate can be adjusted so that it causes fatigue or excitability (sleeplessness). Although the LIDA signal does not travel a great distance, it can be used TTW in an apartment building. This device is about the size of a breadbox & works silently. (Rich, State-Sponsored Terror Campaigns: The Hidden Evil",pg. 38)

"[...]pulsed 40 watt, 40 MHz radio transmitter which can be used to make a target exhausted on the job when pulsing at the rate consistent with sleep, and with a pulse rate increase, DEPRIVE a target of sleep too. This device is a radio transmitter version of other types of trance induction devices[...]" ("Coping With the Crime of Organized Stalking and Electronic Harassment", Eleanor White, pg.54)

Voice-To-Skull (V2K)

V2K, also called Microwave Hearing. If you have a tightly focused antenna, this can be transmitted through walls & over a distance. Voice or other sound can be transmitted over a distance, through walls, directly into the skull of a person. This was possible more than 30 years ago. (ibid.)

For some years in the 1990s and early 2000s, the United States Army recognized "voice to skull" technology, which they abbreviated as "V2K," in their on line thesaurus. For reasons unknown, the Army removed that thesaurus entry circa 2007.

("Coping With the Crime of Organized Stalking and Electronic Harassment", Eleanor White, pg.52)

Silent Sound Spread Spectrum

"Silent Sound (patent 5159703),also called Clear Channel, is an improvement over the time-slicing subliminal suggestions. It does not need to compete with other sound to influence a subject because it occupies a separate channel just beyond the human hearing range. Hence the name: Clear Channel. This channel is beyond human hearing but not human perception. It is not normally in use but it is a direct conduit to the subconscious. Silent Sound can be used by installing a hidden speaker near person s area of work or in their home. These suggestions can be played constantly & the person would not be consciously aware of them. Silent Sound can be transmitted through ordinary radio or television carrier frequencies. However, only a speaker is necessary. But Silent Sound cannot only convey suggestions, it can transmit cloned emotions. This is brain entrainment." (Rich, State-Sponsored Terror Campaigns: The Hidden Evil",pg. 38)

"Although enhancements have been developed, at its simplest, a Silent Sound voice encoder takes a spoken message, and uses a circuit similar to a telephone voice changer to raise the frequency of the voice up near (but not exceeding) the upper limit of human hearing. The listener hears a fluctuating high-pitched tone, and any words cannot be discerned, consciously. However, the brain can subconsciously decode the words. The brain takes advantage of the fact near the upper limit of hearing, the sensitivity to frequencies drops off. The sensitivity curve is sloped downwards in the Silent Sound frequency range, roughly 14,000 to 16,000 Hertz (cycles per second.)." ("Coping With the Crime of Organized Stalking and Electronic Harassment", Eleanor White, pg.53)

"Silent Sound" is not a through-wall device by itself. However, when Silent Sound is transmitted to a target by way of a voice to skull through-wall transmitter, if the target is susceptible to hypnosis (many people are), the target's thought processes and personality could be severely disrupted over time, and the target would have no idea why this was happening, as the sound is essentially silent. The target may hear a high pitched tone or hiss, but no words. The target would be much less able to resist hypnotic suggestions than with audible speech." (ibid.)

Through-Wall Radar

"Through clothing (and through non-conductive wall) RADAR, widely used at airports and by police to look through clothing for hidden weapons. The harassment potential of this

technology in the hands of organized stalking gangs is obvious." ("Coping With the Crime of Organized Stalking and Electronic Harassment", Eleanor White, pg.55)

"The same security scanning radar used at airports, and now coming into use by police, can also view a target through a non-conductive wall[...]. Many targets report being "followed" in their apartments by rapping noises from an adjacent apartment, particularly the one below. As the target walks about, rapping noise which sounds as if the occupant of the adjacent apartment is doing "work" on something, will move as the target moves." (ibid.)

also the perps utilize Microwave telemetry to locate T.Is

IMPLANTS

What is an RFID (Radio Frequency Identification) implant?

RFID is a technology for identifying unique medical equipment and supplies and other high value assets using radio waves. Typical RFID systems are made up of two major components: Readers and Tags. RFID tags are also referred to as a 'chip'. RFID stands for Radio Frequency Identification.

The RFID reader (also called a scanner), is set to a particular electromagnetic frequency, and an RFID tag, which consists of a microchip is connected to an antenna. The microchip contains information that is transmitted to the scanner when the chip is within its range.

Implanted human beings can be followed anywhere. Their brain functions can be remotely monitored by supercomputers and even altered through the changing of frequencies.

When a 5-micromillimeter microchip (the diameter of a strand of hair is 50 micromillimeters) is placed into optical nerve of the eye, it draws neuroimpulses from the brain that embody the experiences, smells, sights, and voice of the implanted person. Once transferred and stored in a computer, these neuroimpulses can be projected back to the person's brain via the microchip to be reexperienced. Using a RMS, a land-based computer operator can send electromagnetic messages (encoded as signals) to the nervous system, affecting the target's performance. With RMS, healthy persons can be induced to see hallucinations and to hear voices in their heads.

Every thought, reaction, hearing, and visual observation causes a certain neurological potential, spikes, and patterns in the brain and its electromagnetic fields, which can now be decoded into thoughts, pictures, and voices. Electromagnetic stimulation can therefore change a person's brainwaves and affect muscular activity, causing painful muscular cramps experienced as torture.

Each of us has a unique bioelectrical resonance frequency in the brain, just as we have unique fingerprints. With electromagnetic frequency (EMF) brain stimulation fully coded, pulsating electromagnetic signals can be sent to the brain, causing the desired voice and visual effects to be experienced by the target. This is a form of electronic warfare.

Using different frequencies, the secret controller of this equipment can even change a person's emotional life. S/he can be made aggressive or lethargic. Sexuality can be artificially influenced. Thought signals and subconscious thinking can be read, dreams affected and even induced, all without the knowledge or consent of the implanted person.

Diminished blood circulation and lack of oxygen in the right temporal frontal lobes result where brain implants are usually operative. A Finnish experimentee experienced brain atrophy and intermittent attacks of unconsciousness due to lack of oxygen.

Mind control techniques can be used for political purposes.

Zombified individuals can even be programmed to murder and remember nothing of their crime afterward.

Since 1980, electronic stimulation of the brain (ESB) has been secretly used to control people targeted without their knowledge or consent.

One reason this technology has remained a state secret is the widespread prestige of the psychiatric Diagnostic Statistical Manual IV produced by the U.S. American Psychiatric Association (APA) and printed in 18 languages. Psychiatrists working for U.S. intelligence agencies no doubt participated in writing and revising this manual. This psychiatric "bible" covers up the secret development of MC technologies by labeling some of their effects as symptoms of paranoid schizophrenia.

Victims of mind control experimentation are thus routinely diagnosed, knee-jerk fashion, as mentally ill by doctors who learned the DSM "symptom" list in medical school. Physicians have not been schooled that patients may be telling the truth when they report being targeted against their will or being used as guinea pigs for electronic, chemical and bacteriological forms of psychological warfare.

Jew "Scott Silverman" Chairman and CEO of "Applied Digital Solutions," the company that has developed micro chipping for humans. The NSA contracted with Israeli companies such as Verizon of which one of the founders Jacob "Kobi" Alexander, [a former Israeli intelligence officer], owns Verint. In 2007, a previous head of Israel's intelligence wing "Unit 8200" told Forbes Magazine that the technology of Comverse, the company that owns Verint, is based on Israel's "Unit 8200" intelligence expertise."

It involves using a hypodermic needle to inject an RFID (radiofrequency identification) microchip, the size of a grain of rice, usually into the person's hand or wrist. The same kind of chip is used for tracking lost pets.

Vaccinations, flu shots, dental work, surgeries, sleep abductions, in fact most medicine including dentistry has been loaded with implantable chips since the 1960s. They have had this technology for 40 years or more and are just now bringing it out to condition and introduce it to the public.

“It may also be possible to compress the silk-based implants and deliver them to the brain, through a catheter, in forms that are instrumented with a range of high performance, active electronic components,” Dr. Rogers said.

ALL POTENTIAL VICTIMS - it becomes IMPERATIVE that you use Tracking Technologies that are on the MARKET to FIND OUT IF YOU, TOO... HAVE BEEN ILLEGALLY IMPLANTED, ALL THE WAY DOWN TO NANO-SEMICONDUCTORS THAT RUN OFF OF WIRELESS TECHNOLOGIES, AND EMIT RADIO FREQUENCIES -

However, there are plenty of completely public Homeland Security and FEMA documents detailing parts of the secretive COG plans for a national emergency. Among these is the document we covered earlier, as this document reveals not only detailed aspects of the COG personnel relocation plans and martial law takeover of communications, but a plan to militarily-target Americans and designate them as enemy combatants—dramatically, through a blue/red high-tech surveillance matrix aimed at suppressing dissidents and occupying the homeland.

Blue Force Tracking is a United States military term used to denote a GPS-enabled system that provides military commanders and forces with location information about friendly (and despite its name, also about hostile) military forces... friendly in blue, and enemy in red)

implants:

MRI (magnetic resonance imaging) cannot detect Titanium implants, because the titanium is non-magnetic.

A Portable Ultrasound machine is one method that can detect the implants.

Microwave Burns

The microwaves destroy the melanin in the skin, turning it white.

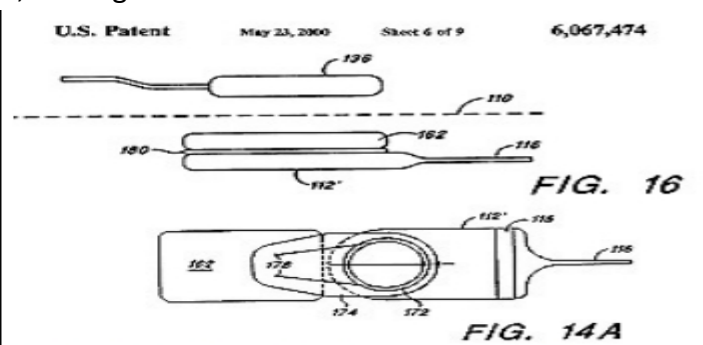
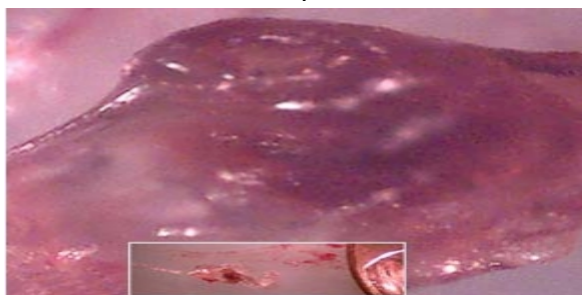

My sample #122 is shown on the left. Patent #6,067,474 is shown to the right an illustrates a microstimulator that uses multiple circuits in a stacked configuration (with a coil on top, #172 in patent illustration) and the stacking is done to save space, however, such stacking complicates assembly and lowers yield. Schulman and Loeb claim that no such stacking of chips was performed, nor required by the “BION” microstimulator, however my sample #122 at left, US Patent # 6,067,474, at right, combined with Schulman reporting “unexplainable” low yields throughout his contract (as low as 30% in QPR#3) should be more than suspicious and immediately prompt inquiry followed by an investigation. And if the above wasn’t enough, the parent case documentation, U.S. Provisional Application Ser. No. 60/054,480, was filed Aug. 1, 1997 which is during the course of NIH contract #N01-NS5-2325, and not long after my assault.

Summary of Article 3:

Devices which have been recovered from my person and provent to contain semiconductor material, emulate and resemble devices which are unique to Joseph Schulman and Gerald Loeb.

Cognitive Mapping

Knowledge-Processing System (brainwave analysis and hard-disk storage)

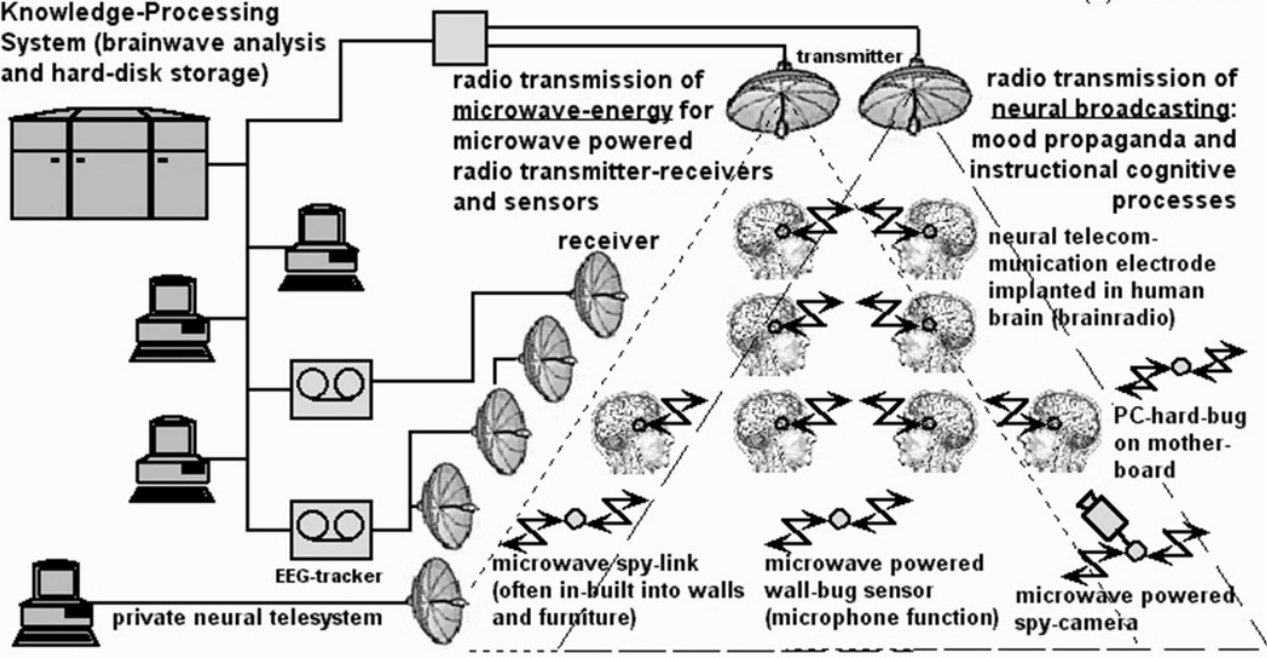

Recovered Device #60
60x magnification

Recovered Device #60 (above) is compared to various device photos (shown on right) provided to NIH Program Manager/Director William Heetderks as part of contract progress reports from contractors EIC Labs and University of Michigan. For implantable wireless microstimulator devices, it is a common design element to fold or bend the platform where the ASIC chip is mounted. This 90° bend allows the shank to penetrate the tissue while allowing the chip platform to lay flat for a lower profile. recovered device number 60 (above) is shown at 60x magnification and actual size is only about 2mm in length.

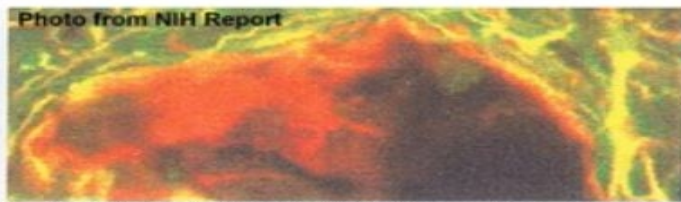

Photo from NIH Report
Fig. 7: Co-Labeling for Vimentin (red) and GFAP (green) IR one week following electrode placement in the auditory cortex. The innermost layer is made up of Vimentin IR cells with a small rim of GFAP cells making up a second layer.

The image above is from a Quarterly Progress Report submitted to William Heetderks at the NIH under contract N01-NS-0-2329 from the University of Michigan. It shows a microstimulator device implanted in-vivo into auditory cortex.



This photo is also from a University of Michigan QPR submitted to Bill Heetderks under contract. It shows a microelectrode (raw substrate prior to addition of telemetry chip) fabricated with the 90° bend at top.



This image is from QPR#9, NIH contract #NS8-2367 and also shows a 90° bend.

RFID REMOVAL: The photos clearly show something foreign that is not organic mixed with the biological tissue

NanoNeuroRFID: A Wireless Implantable Device Based on Magnetolectric Antennas

Mohsen Zaeimbashi, Hwaider Lin, Cunzheng Dong, Xianfeng Liang, Mehdi Nasrollahpour, Huaihao Chen, Neville Sun, Alexei Matyushov, Yifan He, Xinjun Wang, Cheng Tu, Yuyi Wei, Yi Zhang, *Student Member, IEEE*, Sydney Cash, *Member, IEEE*, Marvin Onabajo, *Senior Member, IEEE*, Aatmesh Shrivastava, *Member IEEE*, Nian Sun, *Senior Member, IEEE*



Overview of the wireless in

Take-Home Messages

- Self-powered and ultra-compact NanoNeuro
- Ultra-miniaturized (<200 μm diameter) magn
- Wireless Implantable devices based on magn
- Sub-mm size brain implantable devices using

Sensation Cardiac
Ex: 8
Topograma 1.0 T20s
Se: 1/12
Im: 1/1
Cor: A171.0 (COI)
Mag: 1.4x

RESOMASA
NICHOLSON JHON MURDO
1948 Jun 01 M 00241562
Acc: 38044
2011 Sep 30
Acq Tm: 12:41:03.469076

512 x 512
T20s

SCOUT SCAN
DETECTS CAPSULE
SHAPED OBJECTS

120.0 kV
50.0 mA
Tilt: 0.0
5.3 s
Lin:DCM / Lin:DCM / Id:ID
W:362 L:62

F DFOV: 51.1 x 51.1cm

Remote Neural Monitoring\Manipulation (RNM)

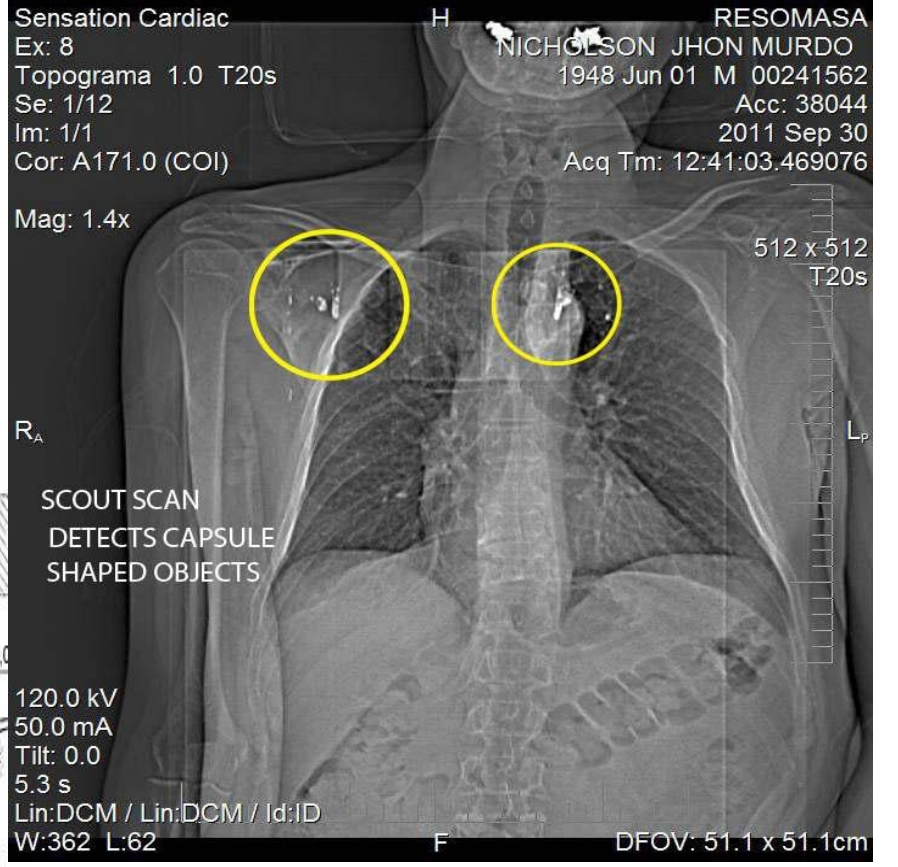
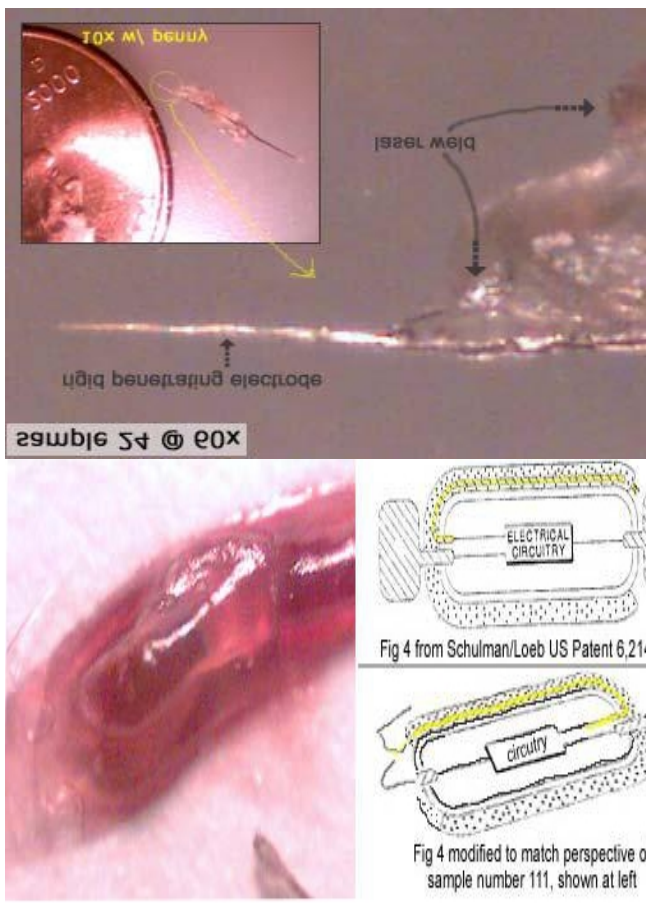
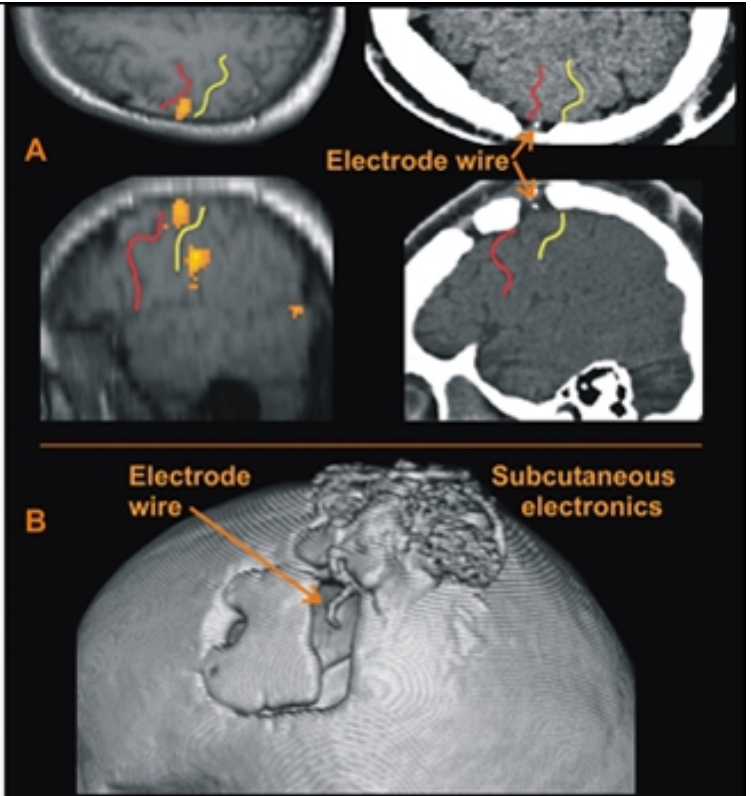
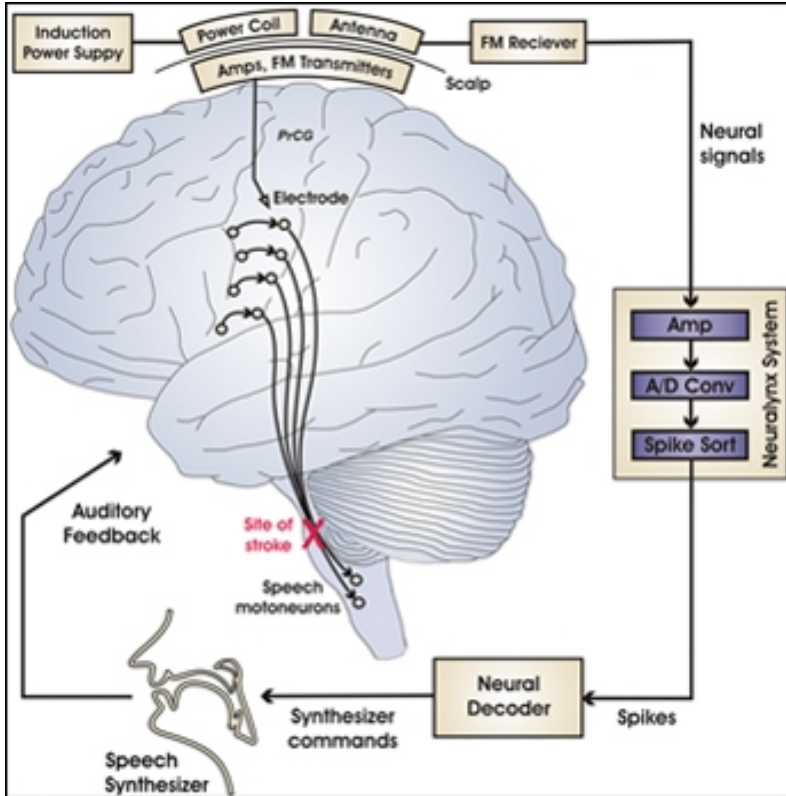

DIRECTED ENERGY ATTACKS

The human body is an Electromagnetic Organism. It is a Vibratory Organism.

As such each organ and region of the body """"VIBRATES"""" at a different frequency of electromagnetic energy.

By varying the frequency and intensity of each stream of energy, CIA & DoD operatives can manipulate and damage each region and organ of the human anatomy.

HYPER GAME THEORY ATTACKS

As soon as you say the won't then they will. As soon as you say they will then they won't. Everything the CIA\DOD operatives are doing is based off IF & THEN scenarios which are founded on the Hyper Game Theory principle. If the victim does this then they will do that If the victim does that then they will do this.

In order for TRAUMA BASED MIND CONTROL to be effective the mind control victim is kept in a constant state of severe pain, stress, hypertension, agitation, anxiety, ect., utilizing a continuous stream of directed energy targeting the victim.

TRAUMA BASED MIND CONTROL, is based on the constant provocation of the victim into set responses constantly all day and night long. So they are constantly provoking the target both physically, emotionally, etc., into set responses which their 'Remote Neural Monitoring \ Manipulation' system can remotely measure via a continuous stream of directed energy constantly interacting with the nanotechnology in the victims body.

Hence the mind control victim is more easily provoked in this constant state of physical and psychological TRAUMA! This allows them to manipulate the victims brain and, by default, the victims Central Nervous System which controls the bodily functions including heart rate and blood pressure.

That is what these directed energy attacks are about: killing me in a way that makes my premature death appear as a normal natural cause while simultaneously discrediting me in the process.

Remember they are trying to alter your 'Daily Motives' and 'Emotional Perceptions'.

The remote neural monitoring system is designed to provoke you emotionally, intellectually, physically, etc., so they can generate RESPONSE STATISTICS which the system will use to determine how to interpret and link descriptions with data captured about your memory references, etc.

That is why they are constantly trying to keep you talking, or constantly

stopping you and asking for directions, etc. So always ignore prolonged random encounters with people you don't know. You're not being rude. Just refusing to allow them to manipulate you.

Once they have consistent statistics the system will use previous 'choice references' and inject them into your subconscious thought during normal activity which is also accompanied by simultaneous 'IMPULSE INJECTIONS' to convince you that the response was your own and influence you to complete or describe the reference by making the appropriate verbalizing or performing a related action, which is known as 'Verification'. You can fight and/or control this if you learn to defeat these memory attacks by learning to read Active Memory.

Once they see what you respond to emotionally, or intellectually, they will fabricate 'conversational' or 'situational' scenarios' (Street Theater) based on events or topics they know will capture your attention.

This is why the perps try to keep you talking for so long. Not just to aggravate you but to provoke you into an 'emotional response', intellectual responses, etc., so they can map your thought process in order to subsequently inject impulses etc., and control your mind. This is why the feds try to get people close to you (eg by approaching you and/or befriending with a hot girl) with so called 'Honey Traps'.

Here is how you stop that from happening: ignore all prolonged random encounters with strangers you don't know and be spontaneous.

This same remote neural attack can be used to disrupt your speech if the attackers decide to prevent you from discussing a specific topic or repeating a given word. The system can be configured to disrupt your recollection when formulating a related statement or inject gibberish [triggered substitution] while you are attempting to speak.

Again, the goals of these attacks appear to be threefold:

1. CENSORSHIP
2. MEMORY MANAGEMENT
3. DIRECT BEHAVIORAL CONTROL

These remote neural attacks are most effective when you are stepping through sequenced tasks so try to avoid 'zoning' on your activities. How? By changing your actions and activities randomly and constantly at the speed of thought. Don't always plan out or think out your daily itinerary, if you don't have to. 'Just do it' ! Be 'SPONTANEOUS'!

Remote Neural Manipulation is accomplished via their system's ability to interpret your thoughts and is wholly dependent on its ability to predict and influence your 'reference choices' or 'impulse sequencing' during thought composition. The system maps patterns with impulses and identifiers (evoked potentials) and uses statistical data about your 'composition habits' to predict how you will think or act as you begin to formulate thoughts or prepare to act. The system's ability to define and

map these references intelligibly depends on your cooperation [or ignorance] and the attackers' ability to make sense of what they see visually or what they can guess based on your past activity

They will constantly run you through a 'verification' routine where the system probes you for a particular set of responses repeatedly in order to establish a pattern. If you are interacting and countering these probes the operator will vary the routine in an attempt to 'verify' via different methods.

Once the system 'verifies' the selected responses they will be used in the next wave of harassment routines. The process is endless and you will see the effects clearly if you are consistently defeating the system. If you are not defeating the remote neural manipulation system then you will not see or notice the effects.

How to combat: through maintaining situational awareness and learning to read active memory, ie. 'mindfulness'

HOW BRAIN TO BRAIN INTERFACING IS BEING ACHIEVED.

When our neurons fire and pass signals to each other they reach what is known as an action potential when generates and electrical pulse.

The electrical pulses are measured using EEGs and are automatically translated into what you see, hear, feel, smell, touch, taste and they are also translated into all of your muscle movement including the smooth muscle movements of your intestines. This information is extracted from your brain and it is stored in a computer. This is called BRAIN COMPUTER INTERFACE.

A COMPUTER BRAIN INTERFACE writes information into your brain using transcranial magnetic stimulation or by a number of other means. Phosphene induction is used to write information into the brain. The process of writing information into your brain is used to stimulate your action potentials which generates electrical pulses. The process is called SSVEP. The electrical pulses which are generated by this process cause you to see, hear, feel, smell, touch and taste what is not there. It is simply an illusion but yet you can be made to feel as if you are inside a virtual reality setting which can be used to either torture you or give you pleasure. Some of the electrical pulses which are generated when information is written into your brain can be used to cause the muscles of your face and body to be used against your will, which can be used to turn you into a bio-robot. This process is currently being used throughout the world as a form of wireless remote controlled secret psychological torture.

A BRAIN TO BRAIN INTERFACE is created by attaching a BRAIN COMPUTER INTERFACE TO A COMPUTER BRAIN INTERFACE. By means of brain computer interface the brainwaves are extracted from one human being and they are stored inside a computer. They can then be sent thousands of miles across the world to another computer which can be owned and controlled by cabal operatives. The cabal operatives write this information into the brain of another human being, often against the

will and without the consent of that human being. (source: Gretta Fahey:
<http://targetedindividualsireland.net/>)

Remote Neural Monitoring is a form of functional neuroimaging, that is capable of extracting EEG data from the human brain at a distance. A human subject's bioelectric field can be remotely detected, so subjects can be monitored anywhere they are. With special EMF equipment, NSA cryptologists can remotely read evoked potentials (from EEGs). These can be decoded into a person's brain-states and thoughts. The subject is then perfectly monitored from a distance.

Unique EEG patterns corresponding to each spoken word, each verbal thought, each images and each muscle movement can be translated at the speed of light by fully automated supercomputers into what a non-consenting human subject is saying, thinking, hearing, seeing and doing and this can all be achieved from a long distance from the human subject simply by remotely analysing the bioelectric field of the human subject. All of these aforementioned unique EEG patterns can be retransmitted back into the central nervous system of the human subject thereby forcing that human subject to hear words which originate intercranially, see unwanted images some of which are pornography and experience his or her own muscles being forced to move against his or her will.

Remote Neural Monitoring is now being used for the purposes of transcranial magnetic stimulation from a distance. Transcranial Magnetic Stimulation from a distance enables unknown operatives to disrupt the portions of your brain that are associated with cognitive reasoning and narrative comprehension in order to force individuals to believe what they would normally not believe and do what they normally would not ever do. (ibid.)

Hypnotic trigger words

Can mimic any of the above symptoms: radiation, pain, bad tastes, head aches, and so on or trigger unbearable fatigue.

The trigger words come in whole sequences, like they were taken out of a dictionary with all symptoms and all words that sound alike or similar.

While some trigger words have effects on the mind and body, other's have emotional effects only (sensitisation of the Targeted individual to certain words, that trigger negative emotions, like disgust, fear, anger).

The trigger words are sometimes reinforced through dark NLP and gang stalking.

Trigger words are in the beginning very difficult to discover because they are coupled with the TI's routines.

The brain can't differentiate always between what it is made to believe and what really happens.

Once discovered, they are "released"; becoming aware of the "truth" wins over the lie that the mind has been told.

When they are discovered, new trigger words will be programmed into the subconscious.

Mental pain

Loud synthetic telepathy. The attackers talk with some of the victims 24/7. They use interrogation techniques that are only used in the CIA or secret service. That is labeled also V2K (voice to skull, or loud synthetic telepathy). A learning computer with a synthetic voice that can be modulated in any voice, can take over partially or full time, after the initial stages. This keeps the victim awoken and always tired.

Silent synthetic telepathy. The victim doesn't hear the attackers but there is thought manipulation, directing their attention. The communication is experience as "thoughts". A sort of repetition of the same thoughts happens, like a tape is playing one's thoughts over and over again, word by word.

HAPTIC TECHNOLOGY

Haptic technology, also known as kinaesthetic communication or 3D touch, refers to any technology that can create an experience of touch by applying forces, vibrations, or motions to the user. These technologies can be used to create virtual objects in a computer simulation, to control virtual objects, and to enhance remote control of machines and devices.

Haptic feedback is the use of touch to communicate with users.

Human beings have five senses, but electronic devices communicate with us using predominantly just two: sight and hearing.

Haptic feedback (often shortened to just haptics) changes this by simulating the sense of touch. Not only can you touch a computer or other device, but the computer can touch you back.

<https://www.ultraleap.com/company/news/blog/what-is-haptic-feedback/>

A polymer called the 'PEDOT' polymer is being manufactured which allows human brains to be linked to computers. Applying a layer of 'PEDOT' to other materials makes them conductive.

Most of the general public now have bio-synthetic materials inside our brains and bodies which we either inhaled, ingested or had vaccinated into us.

Hydrogel Biosensor Would Emit Various Signals

The DefenseOne article outlines the properties and capacities of the hydrogel biosensor:

"The sensor has two parts. One is a 3mm string of hydrogel, a material whose network of polymer chains is used in some contact lenses and other implants. Inserted under the skin with a syringe, the string includes a specially engineered molecule that sends a fluorescent signal outside of the body when the body begins to fight an infection. The other part is an electronic component attached to the skin. It sends light through the skin, detects the fluorescent signal and generates another signal that the wearer can send to a doctor, website, etc. It's like a blood lab on the skin that can pick up the body's response to illness before the presence of other symptoms, like coughing."

Profusa's website states:

"Rather than being isolated from the body, the biosensors work fully integrated within the body's tissue — without any metal device or electronics, thereby overcoming the body's attempts to reject it. To date, the injected biosensors have functioned for as long as four years. Smaller than a grain of rice, each biosensor is a flexible fiber about 5 mm long and half a millimeter wide, comprised of a porous scaffold that induces capillary and cellular ingrowth from surrounding tissue. The hydrogel is linked to light-emitting fluorescent molecules that continuously signal in proportion to the concentration of a body chemical, such as oxygen, glucose, or other biomolecule of interest." (ibid.)

Remote Neural Monitoring, Voice to Skull (V2K) Key Evidence/Proof:

Methods of Remote Neural Monitoring

1. Remote audio satellite surveillance: RNM stalkers listen to one's speech and one's surroundings.
2. Remote See through walls satellite surveillance: RNM stalkers can watch the targeted individual and also read the thoughts in words of the targeted individual in buildings and open area like roads and parks.
3. Remote Thought Surveillance: RNM stalkers can read the thoughts in words of the targeted individual.
4. Remote Voice/sound relay: Targeted individual alone hears a white noise whisper speech when no one is there or hears someone's (synthetic voice) or a clone voice of known person clearly as someone is speaking. Also RNM stalkers can relay any sound only to you using microwave auditory effect.
5. Remote Synthetic telepathy: RNM stalkers can read the words which targeted individuals think in their heads and either repeat targeted individual thoughts in words or respond by talking to you using white noise whisper speech.
6. Remote Human Motor control: They can control some of the human body motor control i.e. involuntarily eyelids open and close fast without any control.
7. Remote Visual relay: RNM stalkers can relay phosphenes and augmented reality to targeted individual's eyes vision.
8. Remote Olfactory and Smell memory Surveillance: RNM stalkers can access specific memory of smell or create a desired smell and one can smell it by electric stimulation.
9. Remote Electrical relay: RNM stalkers use satellite to zap you with electricity causing electrical shock, pin and prick, sharp pain and more often than usual itch on the skin.
10. Remote screen and computer surveillance: RNM stalkers can view mobile phone screen and computer monitor.

Remote screen and computer surveillance:

1. RNM stalkers can view what is on the computer screen.
2. RNM stalkers can view the screen of mobile phone.
3. By using this surveillance RNM stalkers can hack your email and change the login password if you don't have strong security measures i.e. 100 or more character password, two step sign in verification and recovery options.
4. They can jam the internet Wi-Fi signals and also stop the LAN internet connectivity of a laptop.

Limitations of RNM technology:

1. During heavy rain white noise whisper relay voice volume reduces and stop.
2. RNM is unable to decipher the humming tune like 'na na na' when you think in your mind. They can only identify the phonetic sound of words and not the tune which you are singing in your mind.
3. While in car traveling 100 km/hr and above, RNM is unable to read the thoughts or repeat the word which one thought.
4. If you read a sentence from a book, fast enough in your mind RNM would not be able to comprehend what you read.

They relay the words which you know form your vocabulary database, because

- a. Make you think that you yourself were thinking about that word, if you are emotional/not alert.
- b. You'll not be able to identify the words which you thought in your head was relayed by white noise whisper voice or voiceless word relay, if you are emotional/not alert.
- c. New words will make you realize those words are from RNM voice relay/voiceless synthetic telepathy

During RNM mind reading think of one word only, i.e. meditating, mindfulness. By doing this you can identify the new words which RNM is relaying to you either through voiceless word relay or voiced relay method.

While talking to RNM stalkers in words in your head keep your tongue pressed at bottom of your mouth or top of your mouth. So that your tongue does not respond when you think of words in your head and get fatigued.

RNM electrical relay examples:

1. Pin and pricking pain in left side of the upper abdomen (probably stomach).

2. Itching skin on places like hands, groin, legs, cheek, lower lips, head, nose, ears more often than usual. RNM uses an electrical relay to create the itches. These electrical relay seem to be 3D and can be pointed to any surface of the human body. See 'GPS satellites provides precise three-dimensional position' in One's hand goes to the itch automatically that's because Spinal cord neurons control pain and itch.

A reflex response occurs within the spinal cord. Motor neurons are activated and the muscles of your arm contract, moving your hand. This occurs in a fraction of a second — before the signal has been relayed on to the brain — so you will have moved your arm towards the itch before even becoming conscious of the itch.

Sometimes hand doesn't goes to the itch if you were aware of the itch. Electrical relay itch done on others also, i.e. by passers, standing near, person visible to you. They do it to others to show as if RNM stalkers are following you or known persons are harassing you. Which is not true.

3. Electrical relay on the eye, as if something touched the eye.

4. Electrical relay on the left side of the chest (probably heart).

5. Sharp pain in the left side of the upper abdomen (probably stomach).

6. Pain at left and right back between approximately the lowest rib and the buttock (probably kidney).

7. Electrical relay in the throat to make you cough.

8. Electrical relay on arms as if a rain drop has fallen on the arm. See 'Electric shower' in Web link: <http://www.stopeg.com/electronicharassment.html>

RNM stalkers controlling abilities:

1. Control of one's Feet and toe-While standing one's body lifts up on toes all by itself, without thinking about moving.

2. Hip – swaying back all by itself, while standing and sitting

3. Jaw :

a) Clinching of jaw, making you think that you are angry.

b) Opening of jaw and mouth involuntarily.

4. Facial muscle control – Showing emotion sad and happy by control of eye brow, facial muscle and tears

5. Tears control, involuntarily tears in eyes without emotional thinking.

6. Smell memory and olfactory- RNM stalkers can access specific memory of smell or create a desired smell and one can smell it by electric stimulation. They are probably getting assistance from Artificial Intelligence or Analytics software to access those specific smell memory.

a) While I was sitting in my room I smelled cow dung.

b) While doing exercise in my room I could smell strong smell of urine. As if I had urinated in my pants which I didn't.

c) When I closed my eyes to sleep, immediately I smelled fart which I didn't fart and there was no one nearby me.

7. Eye lids:

a) Eye lids blink fast without any control, involuntarily.

b) One of the eye lid partially getting closed forcefully.

8. Going blind for a half a second, blanking out the vision which one can see

9. Control of fingers – a) On phone display my index finger was zigzagging on its own. RNM stalkers claimed that they could control my index finger by relaying white noise whisper voice to me.

b) Thumb and index finger rubbing together indicating money gesture, RNM also white noise whisper voice relayed 'money' along with the gesture. My wife and son also did the same money gesture the next day.

c) Involuntary twitching of right hand index finger like a nervous tic. See 'involuntarily moved his right index finger'

10. Electrical sensation like Goosebumps throughout the body, but without any hairs rising.

11. Tongue – Tongue twitch involuntarily at rest or when speaking.

12. Bladder – Involuntarily release of urine, RNM white noise whisper voice relayed 'bladder control'

13. Make you cough.

14. First I heard RNM white noise whisper voice relay something about 'brain mapping', then my elbows twitched and knees twitched, then RNM whisper relayed 'bladder control' and involuntarily released my urine.

15. Wrist motor control, bending involuntarily like a twitch.

16. Make one faint. The faint started with feeling of heavy head as if my brain being under heavy magnetic field. RNM stalkers have done this to me two times. Then they white noise whisper voice relayed to me that I'm having a Brain tumor, which I don't have it.

Mind Control - Control and manipulation of thoughts, feelings and ultimately behavior

Control of thoughts and thought patterns; feelings and their expression; behavior control.

Dark NLP: Neuro Linguistic Programming and Organised Gang Stalking (street theater; comments coinciding with the programming) that anchor feelings to certain words, and sometimes colors, certain types of people or objects... Creating the illusion of "guilt" or "frustration".

Hypnotic "trigger words" that results in specific sensations, feelings or behaviors brought on by Psychotronic Attacks; Voices in Head or Sounds (V2K) or certain events in your life.

Monitoring attention both where to look but also what to think about and in what terms through Remote Neural influences and subliminal ELF low hertz waves from Cell Towers etc.

Real time Mind Reading and Thought Broadcasting, sometimes before it becomes aware or apparent in the Targets Mind (Verbatim); The erasing or altering of thoughts and memories; short term memory problems. Induced memories and "synthetic" associations to those false memories (that are believed to be made by a Intelligence Super-Computers; aware of the context).

Induced dreams or manipulation of dreams, disturbing visions, thoughts and imagery.

Sleep disorders and Sleep Deprivation sometimes accompanying temporary induced paralysis or micro-comas (to force trauma or visions, sounds and a state of fear of sleep).

How to detect RNM/V2K:

For example when you experience 'sudden severe aggression and agitation' its the perps using impulse injections and memory management tactics, artificially injected, not you, and is part and parcel 'Mind Control'.

So, then, look for patterns of compulsive behavior or thoughts and contrast that current state of mind (powerful emotions & impulses) with your normal state to identify the attacks. Look for patterns. Everything they do is based on patterns.

Remember they want to keep you constantly thinking about them. They must isolate the mind control victim in order to minimize all external interference in order to force the trauma based mind control victim to 'internalize', or internally focus, on the Neuroprogramming.

This is a weapon system based on cognitive warfare and psychological warfare. The objective is to turn the Trauma Based Mind Control victim into a weapon who will inflict destruction on others or who will self destruct.

You can limit and counter this effect by learning to read active memory while blocking their system however it takes quite a bit of skill and self awareness utilizing a cognitive defence method through redirecting their remote neural attacks.

This is also known as 'REDIRECTION'.

Redirection' is simple. When the remote neural attack happens and impulses and thoughts are introduced into your mind (by strong urge [high frequency attack] or slight motivation [low frequency attack]) just change your thread of thought. This hinders 'integration completion' between your brain and the RNM system. You do this by establishing what is known as a 'Working Reference'.

You can thwart their RNM attack by establishing a 'working reference' each time they attempt to inject impulses and thoughts to your brain. This is done by recognizing something in life that makes you very happy and then re focusing or 'redirecting' back to that happy experience in life each time you are attacked through Remote Neural Manipulation.

Understanding the memory attacks (blocking your real memories and injecting false memories and impulses) are key because if you do not recognize modification of your 'active memory' the system will cause you to briefly lose time perception which may be enough procedural [functional] disorientation to influence you to respond to an injected impulse. Forced speech for example.

As you learn to defeat the predictive capabilities of the system (quenching, redirection, multitasking and spontaneity) their attempts to restrict your 'reference choices' will become increasingly evident and you will begin to perceive what I will describe as 'functional duality' [it might also be described as focal duality] within your working memory. The perps system's prediction error rate will dramatically increase and its attempts to predict your thoughts or intentions will become humorous if not simply annoying.

combat complacency

Although by cooperating and allowing the system to interpret and define your daily activity you may find that the suggestions become more tolerable as the system is designed to mimic your normal cognitive behavior, I would recommend not allowing this as you will tend to more readily accept the system's influence, and the purpose of the system influencing you in this manner is to give the attackers the ability to restrict you at will and to allow them to deceive or manipulate you subconsciously.

Everyone who is hearing "V2K" is being monitored in this manner and being influenced in this way as well. The phrases you are hearing should be related to information captured during the 'silent monitoring period' and will eventually be used as the foundation for your endless verbal harassment.

What they do is a game of DECEPTION and MANIPULATION, nothing more.

Do not accept anything they say as truth and do not acknowledge anything the system interrogates you about as truth. The system will take random bits of anything it captures through your senses and fabricate stories which they will use to harass and interrogate you with no intention other than to distract and torture you into submission [to the system's influence].

decoding electromagnetic emissions of the brain into actual thought patterns. Once those patterns are identified they are used and varied in the repeated harassment and torture of the targeted individual.

The mental images of the brain can actually be seen and through this window into the soul. Images, sounds and other sequences (aromas) can be encoded into the human brain. They do this with me a lot also engaging in situational and conversational scenarios designed to confirm their technology is working properly by capturing the attention of the targeted individual, seeking verification.

These electromagnetic impulses are sent into the brain via impulse injections, to trigger evoked potentials, for the purposes of verification.

Again, this generates sounds, images, aromas, etc., via the neuronal circuits.

Essentially, they have turned the brain of the mind control victim into their very own visual, verbal and auditive communications system.

A computer multiplexer routes the signal, or stream of electromagnetic energy, through towers, satellites and mobile platforms (trucks, vans, ships, etc.,) then on to a digital receiver. The receiver is located with pinpoint accuracy and tracked to a few feet of its actual location. However the receiver is not a cell phone. It is a human mind.

Right now they are able to clone the human mind and soul (will, intellect and emotion) by downloading ones entire persona and psyche into a computer database. This technology is also being used by British Intelligence agencies and is known inside MI6 circles as Project Soul-Catcher. This is achieved through transcranial stimulation via directed energy and bioelectric R&D

the cabal maps your brain and then ties you to a supercomputer which downloads your information (thoughts, memories, emotions, etc.) back into a database at speed of light as injection feedback and monitors all electromagnetic activity of your brain 24/7 for life until the day of your death. This is achieved through Transcranial Brain Stimulation

NSA agents use this technology to covertly debilitate people using directed energy weapons, such as micraves, to slowly degrade their minds or other internal organs until they die or become incapacitated. They have done this with me continually for years. The point at which the victim dies or becomes incapacitated by this technology is an important metric in their research and development into how to SILENTLY ASSASSINATE people THROUGH ADAPTIVE NETWORKS (S.A.T.A.N.) such as by heart attack, stroke, etc.

This Hyper Game Theory No Touch Torture Terror paradigm is based off never ending IF & THEN scenarios. They engineer chaos or trauma in the victim's life and then wait for the victim to respond, such as by trying to document the attacks are happening as I am doing now. Then they initiate the Hyper Game Theory formula against the victim by basing their next response off the victims last response; basing their next move off the victims last move.

So if you say they will then they won't and if you say they won't then they will. overcoming induced exhaustion

By causing a long term or short term, even a split second, sudden dizzy or drowsy state, the remote neural attacks are more effective than when I am alert in ALPHA state because the brain is momentarily placed into FUNCTIONAL DISORIENTATION which makes it easier to subliminally deceive and manipulate the brain into accepting the speed of light split second remote neural attack consisting of an Impulse Injection & Memory Injection thereby disrupting the victims normal thought and memory process during normal 'THOUGHT COMPOSITION' to subsequently achieve DIRECT BEHAVIORAL CONTROL over the victim.

IF YOU HAVE ANY SUDDEN BOUTS OF DROWSINESS OR DIZZINESS YOU MUST RE-EVALUATE YOUR TRAIN AND NARRATIVE OF THOUGHT IMMEDIATELY BY REDIRECTING BACK TO ANYTHING THAT MAKES YOU THE MOST HAPPY IN LIFE. THIS HAPPY EVENT OR PERSON, IS CALLED YOUR 'WORKING REFERENCE'!

The CIA/DoD operatives use an electronic brain to brain interface & an electronic brain to computer interface to achieve this, by simply closing their eyes to prevent any external interference they can see everything I see in real time as it is happening.

It is more difficult for the brain to computer interface and the brain to brain interface to measure the cognitive effect of audio to text from video to text. They need you to watch rather than listen because of the remote neural monitoring interface is using a screen of the victims own mind downloaded back to their analogue screen .

The combined cognitive effect of listening to audio not only depatterns their neuroprogramming but also disrupts the bidirectional speed of light incoming/outgoing INFORMATION and INJECTION FEEDBACK LOOP which Mind Control technology is dependent upon

It is not just the audio content and the visual text you are simultaneously reading but the thoughts and memories you associate with that content that defeats their technology because it creates noise, or electromagnetic energy, inside the neural networks of the victims brain jamming their neuro-technology and because the CIA DoD interface cannot determine a coherent pattern of thought because of that noise, and thereby make sense of what they are seeing on the screen of the victims mind, there is no data to intergrate. The thoughts and memories you are having is creating additional electromagnetic emissions or spike – evoked potentials – on their screen which confuses the Remote Neural Monitoring and Remote Neural Manipulation System.

Remote Neural Manipulation, or RNM, is accomplished via their system's ability to interpret your thoughts and is wholly dependent on its ability to predict and influence your 'reference choices' or 'impulse sequencing' during thought composition. The system maps patterns with impulses and identifiers (evoked potentials) and uses statistical data about your 'composition habits' to predict how you will think or act as you begin to formulate thoughts or prepare to act

The system's ability to define and map these references intelligibly depends on your cooperation [or ignorance] and the attackers' ability to make sense of what they see visually or what they can guess

based on your past activity which they cannot do if they cannot measure and integrate what they see into COHERENT PATTERNS OF THOUGHT

The CIA NSA perps are using a 'fabricated or falsified stream' of data known as the INFORMATION, to interfere with your memory and thought process. This is how the constant speed of light – energy travels at speed of light – bidirectional INFORMATION and INJECTION FEEDBACK LOOP works. The RNM system also downloads all your thoughts, memories, emotions, etc., back into the supercomputer at speed of light. Without the INFORMATION and INJECTION FEEDBACK LOOP WORKING PROPERLY Mind Control fails.

In other words, 'Integration Completion' between the RNM system and your brain is hindered and without your response to their specific 'impulse injection' the RNM verification process breaks apart and Mind Control fails.

This INFORMATION and INJECTION FEEDBACK LOOP is achieved by a –Computer Multiplexer which ROUTES the signal or INFORMATION to a tower, satellite or mobile platform, such as a van, truck, ship, etc., which then RELAYS the signal, or INFORMATION, via a continuous fabricated and falsified stream of energy waves – containing the specific carrier frequency of the victims brain wave signature – to the digital receiver, similar to how a cell phone call works. The digital receiver is tracked and pinpointed at speed of light in real time. However, the digital receiver is not a cell phone. It is a human mind. The brain of the mind control victim has been digitalized by way of the nanotechnology, etc., in their body.

Once you become dependent (ie. you believe their impulse injections are your own) on the system's output (or they believe your responses to it are consistent) they will begin to fabricate 'subconscious responses' which they will pretend are indicators of honesty/dishonesty, positive recognition, anxiety, etc, and they will use these 'impulse injections' to convince you that the fabricated responses are your own.

If you are unaware of this constant mental manipulation the system will begin to shape your thoughts and behavior. They will use this to [attempt to] restrict your thoughts and behavior by blocking [interfering with] your memory and thought process while these suggestions (injected impulses) are being provided the interference is triggered and can be activated at will by the attackers.

Reason for sleep interference:

SEVERE PAIN SEVERE PULSATING PAIN TO EARS AND HEAD AND HEART AND CHEST REGION. SEVERE SLEEP DEPRIVATION TORTURE! THE MIND CONTROL ATTACKS WORK BETTER IN THETA STATE LEVELS SO BY DEPRIVING ME OF PROPER SLEEP THEY ARE ABLE TO AMPLIFY THE EFFECT OF THE NEUROPROGRAMMING

interfacing their mind with the mind of the Trauma Based Mind Control Victim(s) attempting to diabolical alter the human soul (will, intellect and emotion) of the victim(s).

The fabricated and falsified stream of energy they are targeting the victim with contains a carrier frequency specifically tuned to the unique one-of-a-kind brain wave signature of the Trauma Based Mind Control victims and they use that stream to align their (cabal Clones) brain wave frequency to the victims brain wave frequency using a process called 'Alignment ' to mimic the very own EEG frequency of the victim. This is achieved by way of phase, frequency and amplitude modulation of my and other victims brain wave frequencies.

By this way they can also create a hive mind allowing them to read monitor and manipulate the thoughts, memories and emotions of the victims through 24hour remote neural monitoring and remote neural manipulation of the victims mind and soul (will, intellect and emotion).

In other words, the urges and motor cortex actions of the cabal mind control clone operative were automatically transferred to the T.I because they have entrained and mapped my brain. This is how they kill the target causing the mind control victim, for example, to suddenly jerk the wheel while driving, or jerk the gun when trying to pick it up off the table, etc

The emotions, thoughts and memories of my handlers can and are transferred to the T.I, the Trauma Based Mind Control Victim, in split second speed of light (energy travels at speed of light) real time scenarios and are used on me and millions of other victims, most of whom are unaware they are even targeted with this technology, on a daily basis to confuse and disorient the T.I.

For their technology to work effectively they need to constantly keep me cut off and isolated from the rest of society,from any and all external interference because that external interference creates chaos in their Neuroprogramming.

COMPONENTS OF THE BIOCHIP



2)



WHO

"Jews are behind the whole thing"-Alan Landis, targeted individual and jew

"many people will be recruited to participate. The idea is that you get as many people as possible to participate in the torture. The logic is that the more people you can co-op, the more assistance you'll have for covering it up, & the less likely it will be exposed." (Rich, pg.57)

"Civilian Spies also known as "Covert Human Intelligence Sources" are recruited from every level and sector of society."

("Zersetzung - The East German Secret Police Methodology of Psychological Decomposition",pg.3)

Who are they exactly? Why do they participate?

The participants are colloquially called 'perps' short for perpetrators as they are complicit in the perpetration of terrorism against others which they often rationalize as 'safety and security', upholding what they have been conditioned by the media to view as a 'noble cause'. Their ulterior motive that they may conceal even from themselves is power; material rewards; social prestige and a feeling of belonging (monetary stipends; drugs; reduced jail sentences); (employment or promotional opportunities in their organization or group such as churches or antifa).

Definition of a Perpetrator: Domestic Terrorist Civilian Recruit'

But, I believe the TEST'S that are given to All Recruited Perps, is not to show that they are "SPECIAL" in the Normal means, but "SPECIAL" because they MEET SPECIFIC PSYCHO-PATHOLOGICAL PROFILES , which makes them EXCELLENT Candidates to be Recruited, that there are DISTINCT Pathologies about the Recruits that Must be PRESENT in them and that they;

EXHIBIT various Traits' that are NECESSARY in order to Target Innocent Human Beings -Without Question, Without Reservation, Without Remorse and most of all Without Regard to the Human Life and/or Humanity of the Targeted Victim.

Antisocial Personality Disorders a.k.a. Sociopath and Psychopaths

Antisocial personality disorder symptoms may include:

Disregard for right and wrong

Persistent lying or deceit

Using charm or wit to manipulate others

Recurring difficulties with the law

Repeatedly violating the rights of others

Child abuse or neglect

Intimidation of others

Aggressive or violent behavior

Lack of remorse about harming others

Impulsive behavior

Agitation

Poor or abusive relationships

Irresponsible work behavior

Narcissistic Personalities,

Narcissistic personality disorder is characterized by dramatic, emotional behavior, which is in the same category as antisocial and borderline personality disorders.

Narcissistic personality disorder symptoms may include:

Believing that you're better than others

Fantasizing about power, success and attractiveness

Exaggerating your achievements or talents

Expecting constant praise and admiration

Believing that you're special and acting accordingly

Failing to recognize other people's emotions and feelings

Expecting others to go along with your ideas and plans

Taking advantage of others

Expressing disdain for those you feel are inferior

Being jealous of others

Believing that others are jealous of you

Trouble keeping healthy relationships

Setting unrealistic goals

Being easily hurt and rejected

Having a fragile self-esteem

Appearing as tough-minded or unemotional

There is an endless STREAM of WHO THE PERPS are, but from My own Experience in Targeting it is a combination of several different CITIZEN ORGANIZATIONS and/or GROUPS who are Psychologically Manipulated into Participation, HENCE - COMMUNITY BASED BULLYING.

A MIX OF PEOPLE WHO ARE OBEDIENT TO AUTHORITY, FOLLOWER'S and HAVE THEIR OWN INTERNAL DEMON'S TO SLAY, and CAN EASILY BE MANIPULATED by the LEADER'S within their RESPECTIVE ORGANIZATION'S AND/OR BELIEFS systems by the Slanderous and Libelous Propaganda sold to them, in order to manipulate them into becoming Vigilante Hater's who act upon that hate via Organized Stalking and Electronic Harassment.

The RECRUIT'S come from all WALKS, and Beliefs, to include NO BELIEFS at ALL - what ALL RECRUIT'S share in COMMON is their BLIND OBEDIENCE TO AUTHORITY, and their WILLINGNESS to buy into Propaganda, Smear Campaigns, Slander, and Libel of another Human Being, but most of all are easily PSYCHOLOGICALLY MANIPULATED by those who lead them.

They will use whatever weapons their Organized Terrorist Leader's hand over to them, and fire them whenever they get a chance.

These Recruits have a WARLIKE MENTALITY AND ARE PACK ORIENTED who only seek to DESTROY HUMAN LIVES.

I have found that there are three types of Perps.

- 1 Hard Core Recruit
2. Mission Offender
3. Thrill Seeker.

These are taken from the Hate Group breakdown as to the levels from which these recruits reside.

The Hard Core Recruit is someone who is fully indoctrinated into the Group

The Mission Offender believes in the Cause, and as such can be deployed to carry out Missions for the Group Leaders, at their request, and needs.

The Thrill Seeker, is someone not quite recruited, is curious about what is taking place, and as such will join in on occasion to carry out acts of Terrorism and Hate.

Basically, if you are a hard core recruit for the Group/Cause - you are totally addicted to the sense of power it gives you to terrorize, stalk, mob, intimidate, torture, and harm to the point of destruction the Targeted Individual.

The Mission Offender, feels the same sense of addictive power, but like to partake, but still has a small capacity to walk away and live in the real world.

The thrill seeker get's a taste of the power toxin, and depending upon how it makes them feel, they will move into the Mission Offender, or Hard Core Recruit sector.

3)

SOLUTIONS FOR TARGETED INDIVIDUALS

gathering evidence/surveilling perps:

the equipment outlined below is adopted to clandestinely monitor the perps

on person:

cellphone in armband facing forward

spy camera glasses (~\$100)

pinhole camera in hat

hand-held audio recorder (use in event of communications with government employees especially, to have a record of the transaction as a defense against false accusations and/or lies by omission) (~\$50-80)

burglar alarm with pull-cord (to sound alarm if attacked) (~\$40-50)

airhorn (to blast perps)

vehicle dash cam (front and rear)

bike helmet camera

digital camera (w/32 GB sd card)

telephone pickup microphone (allows recording of phone conversations)

on property (infrastructural security):

panable bubble dome video cameras (with zoom function); motion sensor

wire-mesh covered motion sensor flood lights

perimeter fence (barbed wire; stone wall with hedges; wrought iron railing)

moat with sharpened logs jutting out and retractable/removable bridge across ('chicken walk')

guard dogs (caveat: danger of their being killed; poisoned or tortured by perps)

alarm system (ideally not run by compromised security company-most are)

multiple Bolt locks on interior doors (middle and above and below midway door jamb; welded to metal door)

doors should be solid steel with reinforced doorframe (metal kick plates if wooden door; also plate to prevent intrusion through sawing of deadbolts with hacksaw blade)

barriers erected across path to residence (eg. logs; heavy steel barrels or cisterns)

wire mesh screwed into windows on the interior

telephone pickup microphone

live with other trusted person or fellow vetted TI (caveat: fake TIs abound-exercise extreme caution)

carbon monoxide and other types of gas detectors (to detect gas perps may pump into your residence)

bug sweeper (detects rfid implants and other bugs perps have planted in residence)

geiger counter/dosimeter (cheap portable vintage soviet versions are available)

emf meter (acousticom is a reputable brand)

shielding fabric (eg. silver fibre)

styrofoam panel covered with multiple layers of multiple layers of aluminum foil covering all walls

aluminum siding

lead paint

sheetmetal screwed into walls inside (must overlap or have additional metal panels covering cracks)

caulking or synthetic resin or pine sap along floor boards (to prevent gases entering residence)

mosquito screening/metal mesh mosquito net around bed and over windows

lead lined bags/containers ('pig')

personal protection from D.E.Ws::

Directed energy sources may include land-based, satellite, aircraft, drone and ionospheric relay (GWEN and HAARP systems). Land-based assaults can come from equipment located in structures, automobiles, and trailers or may be in the form of a small signal emitter device that has been covertly hidden in the vicinity of the target. Though I have never seen a directed energy device, it's speculated that some units may take on the appearance of, or be concealed as, some type of home appliance, utility device, stereo speaker or amplifier. Hidden signal emitters are small electronic devices that are probably no larger than a cell phone

Jamming

Home-made electric and magnetic jammers such as those at www.us-government-torture.com/callallfriends.html and [61](http://www.us-government-</p></div><div data-bbox=)

torture.com/countermeasuresNOguaranteeNov2000.htm may be worth experimenting with; the bare-wire electric motor jammer has been found to be notably effective

"Many" so-called DEW attacks are likely not a directed beam or laser but actually an extremely low frequency radio broadcast that has been modulated into waveforms that mimic pain, sound or an actual physiological process of the body.

magnets (N52 neodymium high gauss small size with rounded sides:creates magnetic field that interferes with the DEWs' specific frequency thereby disrupting it): wear these on stainless steel jewellery (ear studs; chains; bracelets,etc.)

earthing (1st thing in morning barefoot; tree hugging; moccasins; all generate negative ions and/or assist in removing positive ions reducing inflammation)

movement:

moving around prevents/impedes RNM on the part of the pers. When standing in front of a computer eg. Moving the body or sitting in a rocking chair or using a cardiovascular machine

Scalar Wave disruptor:

1800W/2500W ZVS Induction Heater Induction Heating Machine With Copper Tube (purchase power supply with it)

ECS machine (electro-cranial stimulation, eg. Altered-states.net; cesultra.com) [use to manipulate brain wave activity to throw off remote neural monitoring and induce certain mood states)

Brain entrainment: Use: induce states of consciousness/certain brain waves for neural remodelling of axonal connections/synapses, mood states,blood electrification,induce development of synapses/modifies brain architecture/pre-frontal cortical conditioning/activation; induces trance states, enables remote viewing/psi abilities) etc. via electrical, sonic &V visual means:

A) electro-cranial device(small handheld-least expensive; typically direct transcranial or direct body connection via electrodes));

B) RF(radio-frequency generator-typically most expensive)

C) Cymatics:[sound generator-polyrhythmic music, eg. baroque(harpsichord/other), sitar, dulcimer, complex drumming /drum machines(synthesizers)

Helps confuse RNM/mapping of T.I consciousness by perps

When you detect electronic assault employ brain entrainment tech.

Listen to subliminal recordings and/or polyrhythmic music while sleeping via mp3. This combats noise disruption and v2k interference with consciousness. Harpsichord and Baroque music is recommended

Binaural Brain Entrainment tones:

The Binaural Brain Entrainment tones will help interfere with the various frequencies they use to Brain Map us.

listening to multiple radio stations simultaneously; and thinking multiple thought streams simultaneously (what Bryan Tew called "thinking in multiple threads")

Remember it is all Encoded and Decoded Bio-Neuro-Physio-Radio-Electical
MAGNETISIM, REMOTE NEURAL MONITORING, WIRELESS CONNECTIONS
UTILIZING EVOKED POTENTIALS/BRAIN WAVES/POLICE BRAIN PRINTS/IRIS
SCANS/BIOMETRICS, etc, etc, etc.

Wearing UV (Ultra Violet) Sun or Safety Glasses significantly reduces the access to the eyes by lensatic refraction and distance shielding and de resolution.

PROTECTION FROM THE VIBRATIONS

Leaning something against the window cuts the vibration down considerably-a heavy object wrapped in fabric like a towel for example.

Rife machine (radio frequency generator)

hand-held zapper ('Hulda Clark' zapper)

Pemf device (pulsed electromagnet) [reduce inflammation; protect from DEW attacks]

Magnets:

increase voltage/boost energy field; anti-inflammatory if ~polarity of magnet used;
Magnet chair: folding metal chair with magnets underneath seat, preferably with wool blanket on top (piezoelectric effect). B)Magnetic bed (magnetic mattress pad); C)magnetized food/drink plates/containers
worn on jewellery (ear studs; necklaces; bracelets,etc.)

I use an Exercise headband to hold a complete circle of magnetic strip placed against the skin. Be sure to cover your ears, eyebrows and nape of neck. You can add more magnets to this circle especially at center forehead, at ears, next to eyes at temples (if you have video's-in-the-mind) and at base at neck. I use this to sleep many nights, but not always. Somedays I wear it all day.

All magnets need to be north side placed against the skin.

To determine north side of magnet, use a hiking compass flat on the table, pass magnet face perpendicular to compass on table. If the compass needle does not move, then you know that this is the north side.

bakeable art clay as an earplug and place a magnet in the center

sleeping mask with magnets sewn inside to minimize facial D.E.W attacks

Degauss (Instant Grounding) tips:

Place the same nickel size magnets in a small Altoids tin that you can carry in your pocket. Use the backside as the north side so you always know what is the side to use. It fits in your hand discretely. Pass the tin over the side of your face, down the side of your head, at your temples if you are getting disturbing visions or any where you are experiencing pain.

Make small flat spirals of any type of copper wire, uninsulated.

Count the number of lines in the spiral to 9 or 12 across the complete diameter. Attach speaker wire to the spirals. Tape the spirals at the nape of the neck, side of the head, over heart, inside hat (for example)

Run the speaker wire under clothing to your feet, Also put magnetic printable sheets from office store in your shoes.

child protector plugs painted with the graphite powder or lead paint

Test your outlets to see if they have been magnetized. Hold the hiking compass perpendicular to the wall and pass over plug. If the needle swings more than half way, you must change out the socket. This is easy to do and can be learned from the internet. Be sure to scrape the ends of Romex wiring coming from the wall several times to realign the electrons before installing new socket.

sleeping on a water bed had the effect of "completely grounding-out the directed energy."

grounding shoes/sandals

Electrical Grounding and Ground Planes

Aluminum screen that is electrically grounded, thus forming a ground plane, has the effect of absorbing directed energy. For example place a bed-sized sheet on the mattress, with a fitted sheet and perhaps a thin cotton pad on top of it, and with a wire or clip lead connect the screen to electrical ground (third round prong of an electrical receptacle, cold water supply line metal plumbing pipe under the sink, or a metal rod driven ~2' into the ground outside). Also effective is having an electrically grounded wire touching the skin while sitting or sleeping.

Shielding:

Move to a detached structure home or RV. A location that has the least number of angles of potential attack is best.

A home with less neighboring structures is a much better option than one in the middle of a subdivision with homes located on all four sides, because you never know who could rent or buy the home next door. The inner-most location of a dwelling may provide the most secure area due to more walls being present between yourself and the offender. Homes with basements are prime. The further you are from the nearest structure, the better.

Shielding paints – the revolution in shielding technology.

One of the top selling products for electromagnetic shielding is the metal free high frequency shielding paint. It is applied like any other paint. Most of these paints are suited for both indoor and outdoor use. There are different qualities. I have included two of the several available.

These paints are suitable for a wide range of applications.

Living areas: Protection from HF-radiation from cellphone towers, TV and radio broadcasting antennas, radar, digital standard cordless telephones, wireless networks and other last-mile applications. To prevent data-stealing from wireless networks, to prevent interception of potentially bugged conference rooms, to shield EMI-sensitive facilities and equipment. Medicine: Protection of sensitive technical equipment. Further applications: schools, nurseries, hotel rooms, hospital rooms, recording studios, etc.

(Pure acrylic, HF radiation + LF electric fields, Interior + Exterior application)

This paint has a high attenuation even with a single coat. Attenuation of 36 dB (shielding effectiveness of 99.98 %) at typical coverage in one coat, attenuation of 43 dB (shielding effectiveness of 99.995 %) at typical coverage with two coats. This paint has good adhesion on most interior surfaces, such as old emulsion paint layers (regular interior paint latex or vinyl, sheetrock, cement, plaster, masonry, wood, etc. Also, it can easily be covered with water based latex or vinyl paint, the color is black. This paint is reinforced with long conductive fibers, which bridges the gap in the underground. This simplifies the process so no ground strip is needed, especially in outdoor applications. Highly breathable, free of solvents, plasticisers, etc

Anti-EMF: use: buffer/shield electromagnetic fields to prevent mind control via cell towers/electrical grid/HAARP, etc.; Forms: A) clothing/fabric (typically silver fibre interwoven with nylon/bamboo/cotton material. hats; trenchcoats; gloves; socks; facemasks; etc; B) shielding paint for dwellings/other structures. Also Shungite stones & black tourmaline are useful for this purpose as well as having negative ionic properties for anti-inflammatory function.

Faraday Cages:

EMF SHIELDING CHAMBER

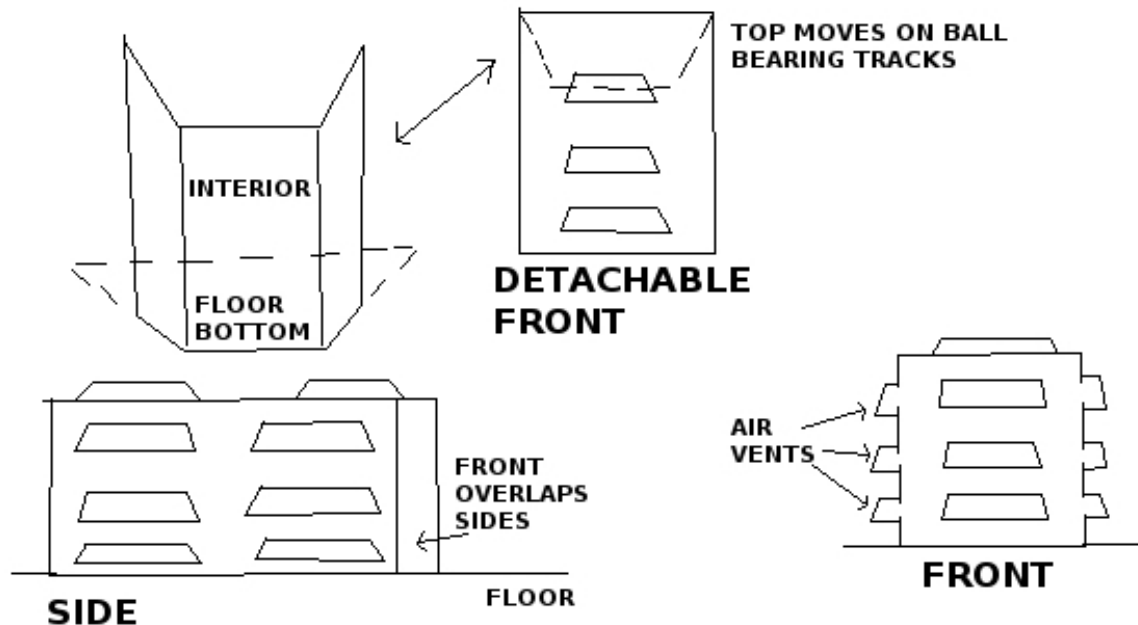

Faraday cages can attenuate electromagnetic energy. Steel sheet metal grounded by electrical wire and 50% Silver fabric can form the main base of the structure. Mu-metal and SiliconSteel can be added at critical areas (head region) to attenuate low frequencies, which are your biggest enemy. Finally, envelop the structure with silver fabric, such as 50% Silver Argenmesh. Lead sheet or PolyTungsten sheet is not required but it is added protection against high frequency ionizing energy (and acoustic energy). Sheet Metal: (below is an example of a sleeping/safety chamber) use: 20 to 30 gauge Steel sheet (with iron content - Not stainless steel) can be effective against lower electromagnetic energies when electrically grounded. I would recommend testing the integrity of your electrical ground with a small volt meter. (20ga = ~1mm thickness & 30ga = ~ 0.3mm thickness.). Other ideas for shielding faraday cages are: metal bathtubs converted as above; wood frame enclosure shielded with aluminum mosquito netting (multiple layers) and possible aluminum foil with small holes punched in it.

Steel Plate:

Steel's iron content can effect the magnetic component in electromagnetic transmissions. The steel's carbon can act against the electrical component.

Lead (Pb):

1/4 inch thick lead sheeting folded into multiple layers, as needed, can provide effective attenuation of ionizing and acoustic energies. It is malleable and can be folded with some pressure and cut with a box cutter blade. Lead is a poison and should be handled with caution.

Use lead 'pigs' to store electronic equipment to prevent emp attacks (electromagnetic pulse , aka. 'E-bomb' attacks); also lead lined bags

Rubber:

"Natural" rubber bath mats or rubber step stones (pavers) have proven to be effective as acoustic dampers (MUST be natural rubber). Five or more mats (or several pavers) can be rolled or stacked together and duct-taped as a bundle.

Other shielding materials: feathers; real wool; leather; silk

Cemented Basement as shielding:

cemented provides coverage from electronic attacks (microwave, electromagnetic, and laser). My basement is cemented throughout except for some of the walls and ceiling

3 things as essential for TI's to wear :

1- Lead vest

2- Lead hat

3- Silver-lined ballcap

I believe 0.175mm is the ideal 'happy medium'- protects but can wear it throughout the day without its weight wearing you down.

Lead curtains

copper foil; barbecue grill/baking sheets (copper infused); copper mesh scrubbers

lead or bbq grill paint (put on reverse of mirrors to deflect DEW emf)

A fabric conditioner called AegisGuard LL, available

from www.blockemf.com and www.aegisguard.com, added to the final rinse cycle of the laundry while in the washing machine, results in clothes

high rated window tinting (eg. Florida)

mylar blankets

chain mail

silicon

silver fibre clothing (buffers emf and energy fields as well as destroys bacteria) and leather and rubber clothes (help to buffer emf)

incense and wood smoke (blocks lasers/scalar weapon beams)

mist (disrupts current): showers and steam machines/vaporizers

relieve that ever so washed out tired feeling. This is meant to assist instant alertness, and also towards thinking more clearly. It has been tried and seems to work well. This simply involves a spray bottle filled with water, (Cost efficient).

Personal Health:

connecting to nature to reset human biohythms:

One can create an internal vibration of their own choosing which can counter-act/jam/override any invading/incoming ELF frequency.

Black clothes is an excellent way to avoid headaches. Black colour filters the most harmful microwaves effects; I think it is better to use natural fibres, like cotton or wool.

remove filings (they attract radiowaves and generate metal vapour which poisons the body-if a necessity only composite filing should be had)

don't frequent dentists (implants; rfid chips)

German new medicine

ozone generator (for atmosphere and distilled drinking water)

Plasma gas/Ozone generator: purifies air, kills pathogens, increases oxygen/ozone in liquid/water, internal body purification. Oxygen singlet in O₃ breaks off and binds to pathogens, etc. destroying them via redox reactions;

natural fibre clothing (linen; silk; cotton)

earplugs

white noise machines (fans; etc.)

music (harpsichord; instrumental polythmic-helps to enhance memory and to complicate brain activity to throw of RNM attempts by perps)

prayer/meditation-mat:: i)wool(magnetic resonance/piezoelectric effect)
ii) orgonite blanket(above)layering of organic/inorganic materials(eg.carbon steel wool &wool) iii)yoga mat(bamboo reeds/wicker/natural material);

ION generator: purifies air, reduces inflammation/DOR(deadly orgone energy);

Chromotherapy color light: swathes or bulbs: activates correspondent chakras via sympathetic vibration

Red heat lamp/near-infrared sauna[red bulb/colored light swathe):

draws toxins out of body; induces sweating;

initiates liver detox via sympathetic resonance of vibrational frequency(red); use during daytime from waking taper off as night approaches

Amber/orange low blue lights: reduces hormonal/mood altering blue light; use wrap around glasses(uvex); bulbs; computer screens(color film)

'Violet ray machine'/hand-held high frequency eletrotherapy instrument: calms nerves; analgesic; localized sterilization; exfoliation; destroys cancerous moles/tumours; accelerates blood circulation; increases tissue cellular metabolism; anti-wrinkle; stimulates lymphatic drainage; breaks up calcification; use on: joints; muscles;blood vessels;blemishes;

Crystals:

A)jewels: around neck(pendant); wrists(bracelets); on body(brooches, etc.).

B) environment(under/over/around): bed/bath/electronic equipment etc.).C) food/water Use: activates chakras; brings in energy; amplifies morphogenic field/energy body; improves resonance/integrity of self,structures water; facilitates growth, etc.

(recommend protection shones such as shungite; obsidion; onyx; also morphogenic field/aura amplifying stones such as rubies; these can be had for cheap if lab created)

copper string necklace with a magnetic fastener and added an electronic resistor greater than 15000 Ohms.

Musical instruments:

A)bongo: induces trance states/altered states of conciousness;

activates/depresses metabolism,etc.; improves mind/body integrity through sound wave generation through mechanical exertion;

B)pan-pipe: as above+ trains breathing techniques/lung capacity

This form of musical instrument helps to cause vibration to distribute through the limbs of the body and alter physiology such that RNM is distrupted/distorted; also induces trances which assist in right brain activation

--Vaporizer: increases H2O in atmosphere;clears sinuses; amplifies O2 facilitates respiration (water vapour helps to reduce efficacy of DEW attacks): The cool moisture mist will change your frequency, immediately assist to relieve tiredness, and help you to become more alert. Also dunking one's head in cold water and running cold water on the cheeks and neck activate the vagus nerve

-- Handheld Vibration machine:use: post application of oil to facilitate purpose: increases blood/lymph flow/muscle electrical activity; breaks up calcification/adipose tissue;

Drinking vessel:

i)glass(preferably dark-pyrex for energy absorption/minimizing breakage/heating in oven)

ii)crystal(iff~lead content)

iii)sterling silver

pitcher/cup(antimicrobial,sterilization);

additional items in vessel:

i)shungite[giza pyramid dimensions]

(negative ions/piezoelectric/black absorbs surrounding energy b/c absence of light);

ii)silver bullion .999(above);

iii)magnet[ization]: place vessel on magnetized ferrous metal plate/pan,etc.(eg.cast- iron),

magnetized by a)high gauss N43-N52 neodymium magnets in b)sacred geometrical array(eg.hex/oct-agonal circle, etc.)depending on purpose

c)placing opposite polarity in opposition on plate &V around vessel via elastics/string(eg.silk, cotton depending on purpose)

of certain color,<>electrified via battery extending from copper wire or placed in flowing water;

purification methods(priority sequence):

1)spring water

2)distilled(make own distiller-STC);

3)R.O.S(reverse osmosis);avoid all alkaline/structured

water;smaller dinking vessels: ~250ml.+pyrex glass containers w/ larger to fit over and serve as dust cover/fridge storage/minimize breakage

Tongue scraper: purpose: clean residue from tongue; enables optimal secretion of digestive enzymes through exposure of tastebuds to chemicals in food; preferably sterling silver cutlery/wire or silicon implement

Toothbrush:

Soladey titanium dioxide rod w/solar panel (generates negative ions that break up bacteria when activated by light via solar panel & via ionic rod coming into contact W/ saliva); hemp sticks an alternative to brushing with above

Neti pot: eliminates mucous in sinuses

Footbath:

generates vibration/heat; use w/ magnesium sulfate(epsom salts) to extricate internal toxins via soles/increase magnesium for anti-inflammatory/nutritional status

Spiky reflexology sandals ('spikes'): preferably wood or iron sandal soles w/ cross patterns cut in to create 'spikes'; enables soles of feet to breath/sweat for detox; activates reflexology points; improves mind/body integrity

Gravity-fed enema bag: 1.5L minimum; colon cleansing/administration of liquid for retention enemas (eg. Coffee enemas which clean the liver)

Sterling silver [flatware/cutlery/plates/pitchers, etc.]: see above + barter item in emergency

colloidal silver:anti pathogenic/microbial/bactericidal nano particles of .999 silver generated via electrical current into .999 silver bullion V wire via alligator clips

Exfoliation:

purpose: removal of skin cells to allow pores to respire/sweat for detoxification of body/moving lymph fluid around lymph vessels via mechanical pressure:

A) cloth(bodyshop-fine nylon/sissel fibre cloth);

B)loofa(marine plant segment used as brush);

C)Scalp brush(stiff boar bristle brush);

D) scalp massage brush(wooden roundtipped bristles for stimulating scalp/blood/lymph flow

Gum stimulator: builds gum tissue through irritation of gums; initiation of growth response; anchors teeth in mouth; reduces gingivitis;

Pyrex glass straw(pipette/silicon tubing): purpose: avoid enamel damage from fruit juice/acids

Sanitation:

UV light toothbrush box

small airtight vacuum seal container

gum

stimulator+refills

toothbrush(soladey+replacement heads)

safety razors+blades+small brush

nail trimmer
mechanical nostril trimmer
loofa (exfoliate)
scalp brush(boar bristle)
scalp stimulator
~ion/03 generator
pot(bedey)\bedey attachment
enema bag
extra virgin coconut oil (oil pulling; skin conditioner)
Grecian olive oil soap
towels(x2 large; x1 small)
baking powder (laundry; tooth brushing)
vinegar (dish washing)
detox: activated charcoal powder
edible clay (ca+ montmorillonite; zeolite)
epsom salt (magnesium source-calm/relax); diatomaceous earth (bedbugs-put around bedposts)
water distillation machine
hydrogen peroxide+dropper (wound irrigation; ear wax elimination-STC)
exfoliating cloth(x2)
carmex; vaseline

EXERCISE STUFF:

Pinhole glasses: strengthens eye muscles; reduces brightness enabling inner sight

Trampoline: moves lymph around body/lymphatic vessels/exercises internal organs via g-forces generated through impact; builds immunity thereby; also detoxification; proprioception(body position awareness)/balance; preferably square shaped as less foot eversion/potential damage;

--Broomstick: /4-6'long/1"dia.wide;

purpose: spinal exercise(spinal muscles; intervertebral discs-go at a controlled smooth pace not too vigorous and always keeping trunk muscles tight; twist spine back and forth<->side to side 20-30 reps each

--Hand squeezers:

A) multi-spring old school spring squeezer; purpose: strengthens 'closed fist grip'; milks veins of arms;moves lymph/blood around body; increase electrical activity in hands;

B)spring-squeezer(v-shaped/single spring)purpose: trains hand in different, awkward way-not recommended;

Pull/chin-up bar/playground equipment : straight/telescoping rod; can be installed in door frame(for back and arms); best kind is multi-angled

Cardiovascular equipment:

purpose: repetitive large muscle group movement inducing increase of cardiovascular systemic metabolism; lung capacity; sweating/detox; muscular electrical activity

- A) elliptical: recommend magnetic resistance whereby one magnet can be moved closer/further from other to increase/decrease resistance;
- B) Stationary/recumbent cycle: same principle as A);
- C) bike trainer: fluid or magnetic stationary 'trainer' to use w/ conventional bicycle. caveat: most generate excessive noise; may also wear down the perineum and cause impotence
- D) bicycle;
- E) snow shoes;
- F) walking shoes

Personal Survival(B.O.B- 'bug out bag'; frame backpack military style)
 source: military surplus; thrift stores; garage sales
 sources: thrift stores;wholesalers; garage sales; family inheritance; internet,etc.

Personal affects(on body):
 polar sleeping bag(duck/goose down)
 down-filled parka
 wool garments('bush' jackets/pants)
 fur clad leather gauntlet gloves
 polar boots('mickey mouse' style)V mukluks+extra laces
 facial covering(balaclava)/down-filled or felt face mask
 wool socks(outer); nylon inner
 frame backpack fur hat (ushanka style) mocassins

further survival gear;

fire : lighters(zippo;bic);cotton balls soaked in vaseline; spark
 lighter/fire starter(magnesium, etc.); waterproof matches; liquor flask full of
 kerosene/lighter fluid; tinder(dried sticks, etc.)

water: ozone generator(miniature, battery powered); colloidal silver
 generator(miniature): 9volt batteries+jumper cable+alligator clips+.999 silver
 wire;silver bullion; portable filtration unit: lifestraw, katadyne filter; stainless steel
 cup on thermos(store all items inside)

sanitation: wash basin; soap(100% olive oil); coconut oil; toothbrush+sanitizer;
 scissors; safety razor+blades; hydrogen peroxide; baking powder; wash cloth; eye
 dropper; gum stimulator; scalp brush; loofa; exfoliation cloth; pumice stone; nail
 clippers; q-tips; stainless steel mirror; ear plugs; shooting ear muffs

clothes: long underwear(wool); boxers; socks(extras); extra shoes+laces; money
 belt(animal leather); sweaters; gloves(security)

1st aid kit: razor knife; sting/venom kit(wasps;ticks;snakes, etc.); sewing
 needle+thread; cayenne; stretch bandage+splints; bandanas(cottonV linen); food
 grade activated charcoal powder; zeolite/terramin clay

communication: compass; map; cell; I.D.(iff~public authority probs., eg.for employment, etc.);
edible plants; 1st aid pamphlet

Sleep: sleeping bag+roll/mat; wool blanket

info./data preservation: multiple computers; External hard drives; USB; external
disc drives; power cords; Cd/DVD-RWs(burnt info in hard copy); battery powered
walkman/discman(+batteries; CDs; cassette tapes); magnetic tape data storage;
condense printed text(print back to front; small font)-> laminate
infographics/important documents to be scanned and reused/made public

food stocks: dried fruit; nuts/seeds(almond/peanut butter); turmeric; ;starch: (oats; rice, etc.);
herbs; spices; chlorella tabs; dried seaweed; sardines; ghee; waxed cheese; boxes of dried fruit

tools: multi-tools; hammers(claw;sledge); saws(hack;wood); wrenches(adjustible);
screwdrivers(multi-bit); pry bars; wire cutters/strippers; nails/screws(large;
small;med.); electrical drill; generator; plastic sealable gas jugs; hex wrench; axe;
lock picks; glass cutters;

Food: minimum 2 months supply at all times

Water: large jugs full (100 L at all times) (R.O.S V Distilled preferable)

Coping techniques:

**3rd eye Meditation+ zen satori techniques (detachment from the spatio-temporal plane, ie. The
veil of maya))**

Mantras (Aum)

networking with proven T.Is to share information and for mutual aid and support

**communal living (24 hour security/monitoring of premises+ witnesses to avoid being set up in
false flags)**

Exposing the Crime:

Propaganda:

(referencing gangstalking websites and quoting jews' anti-white statements. Messages which are brief; pithy and evoke an emotional reaction in the viewer, eg. shame; guilt; anger; outrage, as well as interest in the terrorist activity of the Hidden Hand. Examples could be: "Community Policing is Terrorism"; "Gangstalking"; "Spy Society"; "Gangstalking is Terrorism", using eg. QR codes to urls of website and/or website domain name: eg stopgangstalkingcrimes.com)

banners in windows

money bills with permanent marker ink stamped messages using adjustable business letter stamp

chalk (greasy kind-neon gets attention best)

send flyers to media and other people

pamphlets; leaflets; stickers (on vehicle windshield wipers; tossed out of vehicle on front lawns of people; placed up in public places: bus stops; etc. caveat: be ware of local laws and bylaws to avoid legal trouble, eg. littering laws; mischief; nuisance, etc.)

keep a daily journal and monitor and record all events around the 24 hour clock.

Gather audio/video evidence on all perps; compile dossiers on each individual. Most T.Is are assigned 20 perps each

video record emf meter readings of DEW attacks in property and pin point their location

social media and online activism:

memes and links to websites or forum to spread the message (as above)

email: anonymous mass emails and faxes to organizations; key individuals set up a website or forum for community discussions as well as group or person-to-person conversation on audio-video platforms

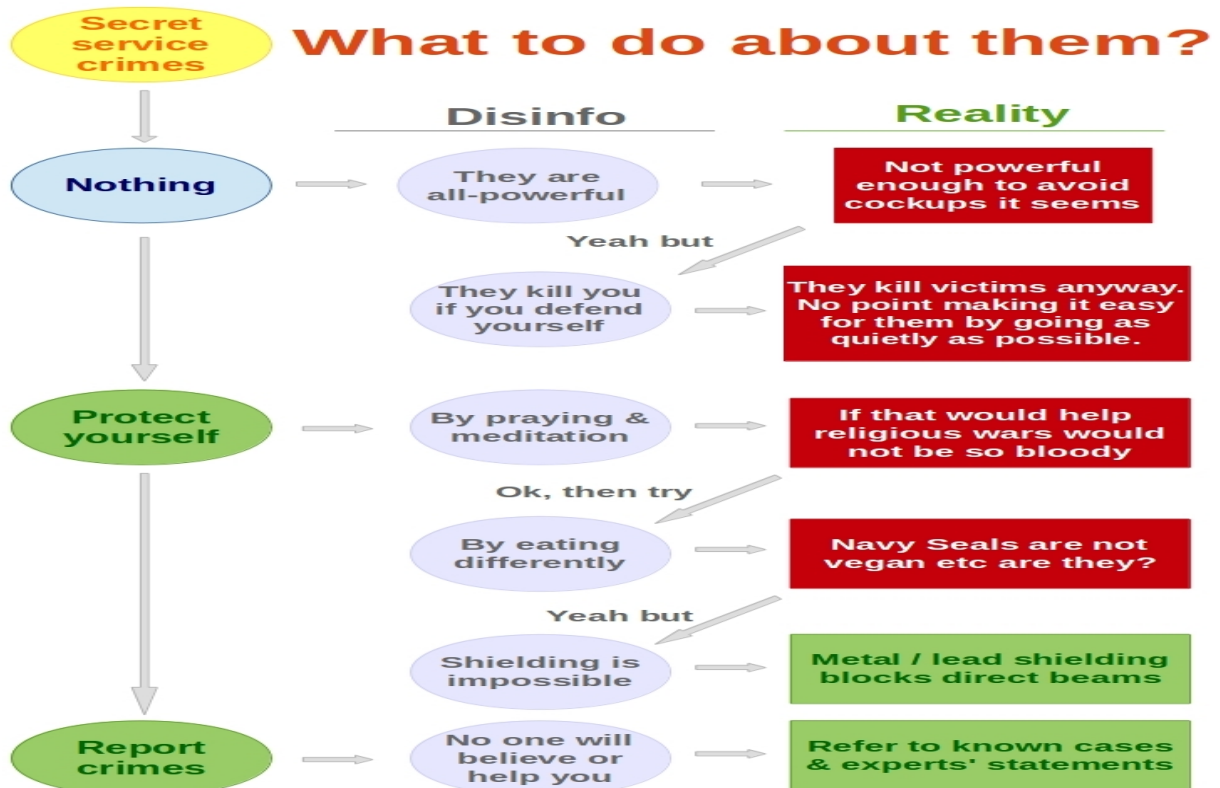

Dealing with Police:

"I'm on a terrorist watchlist" (this indicates to them they must not interfere with your activities but simply monitor you from afar)

"I reserve all rights...am I free to go" (freeman on the land advice)

5 words: "I have nothing to say"

"I'm represented by counsel": give lawyers name

If caught video recording people etc.: "I'm documenting illegal[...name of alphabet agency or omit...] surveillance and counter surveillance stalking" (Stephen O'Keefe) caveat: attempt to avoid being conspicuous

Have on hand technical diagrams of D.E.Ws and microwave weapons technology to prove the existence of such should this be the point of contention

security



exterior:

padlocks: these are only as strong as the doors they shut: the weaker the door the less valuable high security padlock would be

Grade 6 high security shrouded padlock (large-style)

Sargent & Greenleaf (S&G) 951 or 833 Padlock; Abloy Protec2 PL 362 Shrouded Hardened Steel Padlock (Finland) ; Anchor Las 590-6 Padlock (Swedish); EVVA MCS Shrouded Padlock (Austria): this magnetic lock may be most difficult to pick

smaller padlocks: S & G wheel combination padlock

security cameras on property: motion sensor; flood lights

floor safe (ideally sunk in concrete; photograph items prior to leaving residence for liability/insurance purposes)

Doors:

steel door

interior:

deadbolt

Abloy Protec2 Jimmy Proof Deadlock Deadbolt; BiLock Jimmy Proof Deadlock Deadbolt;

tape the dead bolts into the locked position, whenever possible, for your own safety.

door reinforcement :

DJA Armor Platinum Jamb Armor Combo Kit for Standard Doors

deadbolts:

Expanding Bolt for Abloy Deadbolts

all of the above from: <https://securitysnobs.com/Deadbolt-Bolts/>

Hasps:

HS1 Heavy Duty Hasp & Staple

chain:

Hardened boron steel high grade chain

<https://securityforbikes.com/products.php?cat=Chains+%28without+padlocks%29>

travelling:

portable door locks:

Calslock; MasterBolt; Addalock; Qicklock Portable Travel Door Lock; Pocket Lock Portable Door Lock;

windows: burglar bar; metal mesh; spring loaded expandable bar; security film (to prevent smash entry/mischeif);

bottom of door:

DoorJammer Portable Door Brace; Wedge Door Stop Security Alarm;

Door Barricade Brace Night Security Lock: eg. nightlock (\$40)

vehicle security:

security film
boot lock (on wheel)
club-style lock on steering wheel)

dash camera

vehicle:

Mul-T-Lock (jewish company unfortunately)

door: ArmaDLock

gearshift: MVP 45

personal defense(be aware of local laws):

body armour: helmet; face mask; shin guards; bullet proof vest

blade: pants pockets: spring-loaded folder knife; fixed blade; large machete

collapsible baton (friction)

blunt instrument:

steel shot gloves or kevlar knuckle;

baseball bat(aluminum); collapsible baton; kubaton or monkey fist on key set

guns:

rifle: sako; winchester 270.; with nightvision scope

handgun/sidearm: ruger mark 3 or 4; .38 special revolver blue-black metal.357 smith and wesson revolver

shotgun:12 gauge pump action semi-auto shotgun

semi-automatic (repeating) military-style rifle: M-16; SKS

sub-machine gun (smg): H&K MP5; MAC-11; Scorpion machie pistol

bb gun: pistol and rifle + lead bbs

gun locks+keys;gun cleaning kit(oil; rags; brushes);

[homemade]body armour(kevlar helmet+ballistic face shield/face mask/kevlar vest; ballistic shield)

home made weapons (in WROL/SHTF situation):

(look up on internet for instructions): pepper spray; microwave maser/herf gun; stun gun;

pipe guns; Homemade wooden 'knucks'(mahogany/cherrywood;teak)

straight razor; lead-filled cane;

Avoiding false diagnosis of mental illness:

"Frankly I strongly recommend that you keep your faculties together & avoid going to see psychiatrists & psychologists, because the pattern that is evolving is that they are highly complicit in these operations."-The Investigative Journal interviews Julianne McKinney, April 19th, 2006, Subject: Directed Energy Weapons & Gang Stalking

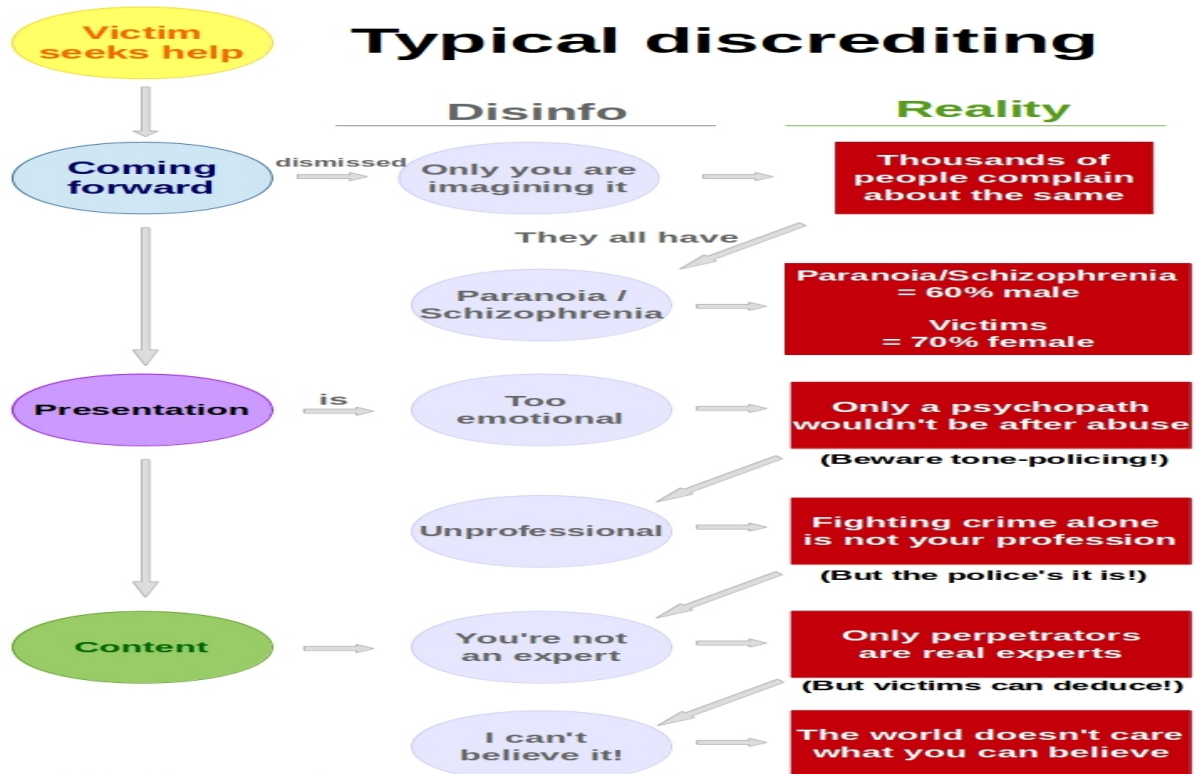

Source: Dr Katherine Horton

"If you see a mental health professional as a result of Mobbing/Organized Stalking, you may be misdiagnosed with a mental disorder."
(Rich, State-Sponsored Terror Campaigns: The Hidden Evil",pg.48)



Source: Dr Katherine Horton

dealing with psychiatrists and 'mental health professionals':

always convey only literal meaning and appear as 'average'/normal as possible displaying no idiosyncracies taht could be portrayed as 'symptoms' of 'mental illness'

state only "I'm not a danger to myself or others"

ensure you obtain informed consent should any 'treatment' be imposed upon you; do not consent to the extent possible without enabling the state to justify imposing physical force or confinement against you.

If institutionalized behave as normally as possible and ween yourself off the drugs as quickly as possible.

If institutionalized ensure you state that you are calling a review panel which should inititate a process that will put you into a position to get out of the institution. (this applies to Canada. Check local codes fo ethics and parameters mental health 'professionals' must go through in their 'sevice' provision. Know your rights).

Dealing with Implants:

Where or have around oneself magnets to disrupt the transmission/transceiving of emf by perps.

Attack to short out through emp (electro magnetic pulse)

Possibly have implants removed by a trustworthy surgeon (if one can be found and the chip/implant can be detected)

Avoid dentistry and dental surgery especially tht which entails being anaestetized ('put under') as this is the primary vehicle through which chipping is carried out (typical location: lower right jaw and upper left jaw-the route of the vagus nerve which governs motor function. This enables perps to emply D.E.Ws to influence the movement of the T.I)

Dealing with RNM (Remote Neural Monitoring and Manipulation):

other defenses:

MultiTasking

Learn how to multitask as multitasking causes you to think in multiple threads. When you are constantly thinking in multiple threads (multiple tasks or thoughts) then there is no coherent pattern for the perps to establish and integrate into RNM data. (egs.: listen to polyrhythmic music while doint other tasks such as harpsichord; use ECS machine and/or rife rf machine);

In other words, 'integration completion' between the RNM system and your brain is hindered and without your response to that specific 'impulse injection', the RNM verification process is breaks apart.

If you are unaware of this constant mental manipulation the system will begin to shape your thoughts and behavior. They will use this to [attempt to] restrict your thoughts and behavior by blocking [interfering with] your memory and thought process while these suggestions (injected impulses) are being provided the interference is triggered and can be activated at will by the attackers.

Learn active memory techniques

behave in ways which differ from 'normal' routinized forms of behaviour (while in private trying to appear 'normal'/average while in public)

DETECTION:

radio frequency scanning

JM20 PRO RF-detector RF (radio frequency) scanning

The three phases of the testing:

1. Preliminary scan for (RF) radio frequency emission from the Human Body.
2. Obtain medical imaging of the area that has shown emission of RF- frequencies. The aim is to locate possible foreign bodies, UBO's (Unidentified Bright Objects). This is the responsibility of the participant.
3. Final scanning for RF emission is done in a controlled environment. This is a repeat of phase one in a certified shielded room, also referred to as a faraday cage, to rule out the possibility that the signal might come from an outside source.
4. Surgery, under video monitoring to obtain, possible physical evidence admissible in domestic and international court. This is the responsibility of the participant.

The Zap 180 Will Detect Chip Implants in Humans

then you can cause them to malfunction within 2 days with a rare earth magnet and use a band-aid to hold them in place.

New chips, several years old, only need about 12-24 hours to neutralize. The ones you probably got as a kid via vaccines can take 24-36 hours.

Removal of RFID chips:

First you have to find a practitioner who can detect the chip. This is usually not so easy to do as some of the chips do not show up on X-rays, ultrasound machines, or scanners. Once you have successfully determined that you do have an implant, you better hope the chip stays in one location, 90% of the time they tend to move around the body. Secondly, you must find a surgeon who is willing to remove the chip, or find a technician who can erase the chip and stop it from transmitting data. The following is sure to help those of you who may have strong implications of chip implantation. This article is to aid you in your search for either chip detection and or chip removal.

Magnets can also be found inside old hard drives. They will be encased in a silver (or gold) overlay because they are more brittle than other magnets. But you will not mistake them, because the

moment you try to put them together you will pinch your fingers. They are very powerful magnets, derived from a rare earth mineral. And they WILL render micro-chips useless.”

use of magnets to short out chips:

Neodymium magnets

“For the electronic, physical, (implants), neodymium (rare earth mineral) magnets of anywhere from a quarter inch to a half inch in diameter work very well to completely disable them. Some people wear them in the headband of a baseball cap, preferably for at least 24 hours, but you can also tape them to the back of your ear and hide them under your hair! After implants are disabled, you won’t have so much fatigue, and the pitch or frequency in your ear stops happening. Use caution with these powerful magnets, though, as they can wipe out disks and computers. It’s best not to wear them while sitting at the computer, at least, not while wearing more than one or two of the little ones.”

http://www.metatech.org/implants_physical_destroy.html

<http://www.thetruthdenied.com/news/2014/11/11/how-to-remove-an-rfid-implant/>

Dealing with Perps:

Covertly monitor perps with recording devices and practice mindfulness at all times to avoid being struck by vehicles; assaulted; set up/framed

Do not respond in any way that could be construed by the 'reasonable man' as aggressive; emotionally erratic; threatening or suspicious to avoid potential public opinion you are 'mentally ill'. Maintain the facade or normalcy at all times.

"Perps have to blindly obey within a second. Or they will be punished. I have often witnessed it on the bus or skytrain or in line ups. Wherever harassment takes place, there is always a supervisor near. The perps look at the supervisor for the ok to set off their weapons. This is done by eye blinking. The supervisors never carry a cellphone openly in their hand. Many of them wear a suit to demonstrate their authority. When perps escalate a situation, the supervisor will step in and de-escalate it. Supervisors often saved me from being apprehended by the police due to some stupid act of a perp. The police yields to the intervention of the supervisor, this is how I found out who is boss. The higher supervisors are Mossad agents." (quotation from a targeted individual)

Compile a list of names; faces and residences of perps in the form of audio-video and photographic evidence which can be used to charge them with: harassment; sexual assault; voyeurism; property damage; nuisance; mischief; disruption of the quiet enjoyment of the premises (bylaw violation); break and enter (B&E) or whatever other crime they may have committed. Prepare in advance to have the list and other information available for release by an online 'deadman's switch' which will automatically send the information (be it a link to a storage site or websites of your own you keep clandestine) to trusted sources should something happen to you. This may lead to the perps being brought to justice.

Message to the Freemasons ('shabbos goyim'):

The following quotations from the protocols of the elders of zion serve to illustrate both the purposes of freemasonry for the jews and the latter's intentions towards freemasons. The fate of the traitor to their people is writ large in these quotations from the Protocols of the Elders of Zion:

"[W]e shall create and multiply free masonic lodges in all the countries of the world, absorb into them all who may become or who are prominent in public activity, for these lodges we shall find our principal intelligence office and means of influence. All these lodges we shall bring under one central administration, known to us alone and to all others absolutely unknown, which will be composed of our learned elders. The lodges will have their representatives who will serve to screen the above-mentioned administration of MASONRY and from whom will issue the watchword and program. In these lodges we shall tie together the knot which binds together all revolutionary and liberal elements. Their composition will be made up of all strata of society. The most secret political plots will be known to us and fall under our guiding hands on the very day of their conception. **AMONG THE MEMBERS OF THESE LODGES WILL BE ALMOST ALL THE AGENTS OF INTERNATIONAL AND NATIONAL POLICE** since their service is for us irreplaceable in the respect that the police is in a position not only to use its own particular measures with the insubordinate, but also to screen our activities and provide pretexts for discontents[...]"
(Protocol 15)

"It is natural that we and no other should lead MASONIC activities, for we know whither we are leading, we know the final goal of every form of activity whereas the GOYIM have knowledge of

nothing, not even of the immediate effect of action; they put before themselves, usually, the momentary reckoning of the satisfaction of their self-opinion in the accomplishment of their thought without even remarking that the very conception never belonged to their initiative but to our instigation of their thought[...]" (ibid.)

"You cannot imagine to what extent the wisest of the GOYIM can be brought to a state of unconscious naivete in the presence of this condition of high conceit of themselves, and at the same time how easy it is to take the heart out of them by the slightest ill-success, though it be nothing more than the stoppage of the applause they had, and to reduce them to a slavish submission for the sake of winning a renewal of success ... **BY SO MUCH AS OURS DISREGARD SUCCESS IF ONLY THEY CAN CARRY THROUGH THEIR PLANS, BY SO MUCH THE "GOYIM" ARE WILLING TO SACRIFICE ANY PLANS ONLY TO HAVE SUCCESS.** This psychology of theirs materially facilitates for us the task of setting them in the required direction. These tigers in appearance have the souls of sheep and the wind blows freely through their heads[...]" (ibid.)

"With this purpose we shall slay without mercy all who take arms (in hand) to oppose our coming into our kingdom. Every kind of new institution of anything like a secret society will also be punished with death; those of them which are now in existence, are known to us, serve us and have served us, we shall disband and send into exile to continents far removed from Europe. **IN THIS WAY WE SHALL PROCEED WITH THOSE "GOY" MASONS WHO KNOW TOO MUCH;** such of these as we may for some reason spare will be kept in constant fear of exile."

EXILE? THE GOY FREEMASONS WERE EXECUTED AFTER THE BOLSHEVIK REVOLUTION.....

4)

REFERENCES

Books:

Health:

"Übermenschheit: Health Protocols" (for details on optimal health and wellness)

"Salubrious Living", Arnold Devries (for additional fasting protocols)

Psycho-Spiritual:

Julius Evola, "The Doctrine of Awakening: Buddhist Varieties of Aescesis"; "Zen: The Religion of the Samurai";

Hagur, "Development of the Will";

William Walker Atkinson (thought force; personal magnetism, etc.)

Robert Bruce's energy techniques

'mental health' profession:

"Psychiatric Fraud", Richard Lighthouse

"Does Mental Illness Exist", William Ramsay, J.D

"The Theology of Medicine", Thomas Szasz

mind Control:

"The Communist Brainwashing manual: Synthesis of the Russian Textbook on Psychopolitics", L Ron Hubbard

"Chainless Slaves: Trauma Programming", U.W.Ozian

"How the Illuminati Create a Total, Undetectable, Mind Control Slave";

"Deeper Insights into the Illuminati Formula", Fritz Springmeier

"Mind Control,NLP & Hypnosis", David Shuttleworth

Organised Stalking and Eletronic Harassment(OSEH):

"State-Sponsored Terror Campaigns: The Hidden Evil", Mark. M. Rich

"The Protocols of Gangstalking", Dr.Erik Karlstrom

"New World War: Revolutionary Methods for Political Control", Mark M.Rich

"Microwave mind control: Modern torture and control mechanisms eliminating human rights and privacy",Dr. Rauni Leena Kilde, MD, Former Chief Medical Officer of Finland

"Gangstalking and Mind Control: The Destruction of Society Through Community Spying Networks", A.K.Forwood

Websites:

Targeted Individuals; gangstalking; and directed energy weapons:

<https://www.stopgangstalkingcrimes.com/>

<https://www.stopeg.com/>

<https://sites.google.com/site/targetedstalkedterrorized/home>

<https://www.righthouse.com/targeted-individuals.html>

<https://gefoltert.blogspot.com/2018/01/posts-and-videos-in-english-language.html?zx=2d55820ad4ca9aab>

Forums:

<https://exposingtheothers.com/forum/index.php>

MARCHING ORDERS

Armed with this information weapon it is the will of the author and compiler that the reader take aim and blast the cabal in its black heart and assist in the liberation of the earth and its denizens from the electro-magnetic matrix it has been imprisoned in. Rend the veil of appearances the hidden hand has blinded humanity with and let the light shine upon a new world of harmonious order.

Disintegration: Jewish Torture Murder

This work is a presentation of the targeted individual phenomenon in its hidden aspects. It is an unconcealing of the dark forces which seek to enslave the world and to extinguish the divine spark which is carried by the aryan race.

Herein are discussed the various motivations and modalities of the cabal in their subterranean operations and herein are discussed the means and methods for waging spiritual warfare in opposition to them.

The war waged is one that has existed for millenia on the earth and beyond this earth. It is a cosmic war of darkness and its instruments-the jewish anti-race; freemasonry; mainstream Abrahamic religion and their savage hordes of beastman-against the bearers of the light of the Holy Graal, the divine spark of the gods crystallized in the blood of the aryan.

The war has been brought before the aryan-the enemy has drawn first blood and is relentless in its pursuit of the blood of the aryan which it seeks as its energy source, as it is of a vampiric nature, incapable of sustaining its own life through itself.

It seeks to vampirize the souls of the aryan through degrading it to a state of weakness and submissiveness before its yolk-the slave system of Zion it seeks to impose upon the earth.

The author intends this work to serve as a guidance system to effectively subjugate the enemy or at least to maximize the survival potential of aryan kind should the war be lost on this earth. It outlines the mechanisms of the slave system and exposes them to the light of truth with the intention that cosmic justice will be visited upon the dark forces through the agency of aryan power guided by wisdom.

The reader may take from it what he will-it is a weapon of war against the vampires of Zion. The author emphasizes that failure to take up this weapon and to effectively wield it may reduce the possibility of the realization of victory as much that is needed to be known is herein contained and unavailable in any other written work so far as the author knows. Much is shrouded in the darkness of the malevolent cabal, distorted nearly beyond recognition and barely redeemable from its fallen, near unrecognizable state.

The task is daunting but is life or death for the person who has had the luck to discover that there is indeed such a task and that it is one that is necessary to take up for one's own personal survival and that of aryankind.

Incorporate this work into your arsenal aryan reader and employ it in the war everlasting.

This work is divided into three sections:

'**Self**', wherein the reader will acquaint himself with his True Self as an aryan; how to live in accordance with his own True Essence (the 'gnothe seuton' or 'know thyself' of the Greeks);

'**Enemy**', wherein he will acquaint himself with his foe as irreconcilable antagonism, the 'Other';

and '**World**', the arena in which the battle is waged and a tactical analysis of the subterranean moves of the adversary and how to combat them with wise counter-moves of his own.

Self

In order to combat the Enemy, one must 'know Himself' (gnothe seuthon)

Self-Centered

In order to live in this world of eternal struggle one must fight against the forces which work antagonistically against oneself. Further, given the self-development of the organism it seeks to expand itself and this over and against others. Hence all life, insofar as it is to live, entails the death of the 'Other' as its *conditio sine qua non*.

This war is circumscribed by the limitations of the causal forces which support and enable the perpetuation of the organism (conceived of here both physically and metaphysically). Failure to work within these limitations (themselves in large part unknowable, constituting an epistemological block) leads to extinction.

One must know one's limitations yes, but paradoxically to allow oneself to crystallize into a form that operates only within known limitations leads to entropy and self-destruction as life is dynamic and necessitates expansion aka. growth both of the body and its varied facets (soul and Spirit). Accordingly one must keep his feet on the ground just as he must-should he value the continuance of his Self developing being-keep his head in the sky (cosmos, Spirit) as condition of his growth.

The notion of keeping one's feet on the ground, being grounded in one's being in relation to the sum total of Being is metaphorical language translatable into the notion of remaining within 'reasonable limits', those which maintain his Self in its unitary structure without precipitating its fragmentation or disintegration. One thus grows and this either in a tumescent metastasis or in an anabolic fashion conducive to health and power.

One either allows oneself to escape the 'reasonable limits' or borders of his being, destroying or harming oneself or he 'sticks to the straight and narrow', a path he can only continue down in his stepping slightly off that which is well worn and expanding the path without losing his ultimate destination-that being godhood, the immortal diamond body. Thus in order to continue to live he must struggle against his own limitations, his own self even more so then against others.

What this means is that, as a dynamic self governing organism he must challenge himself and never acquiesce to the antagonistic forces which ring him round at all times without rest, harrying him without any future promise of 'peace'. Indeed for him 'peace' is death itself and the only peace he knows or could ever come to know is marked upon the gravestones in the local cemetery: 'rest in peace'. Neither 'rest' nor peace are either desirable or possible insofar as he is he he must needs be-a dynamic being, a warrior in a war everlasting.

The forces which he confronts are those conducive to chaos, to fragmentation, disintegration (centripetal-that which goes out from the center of his being, explosively, like a self-destructing munition) and those conducive to order, to assimilation, integration (centrifugal-that which is brought into the center from the periphery, implosively, a vortex of force).

One must harness those forces which are conducive to his greater being and to work up his capacity to transform himself into a vortex of energy that does not indiscriminately absorb all into itself but which has a nature that enables only life developing energy into itself through its filter-a quantum filter vacuum of being into a fragment of Being, a unitary organism, a diamond in the rough which reflects its light through its inmost radiance outwards into the darkness and annihilating those forces antagonistic to its being.

The Traditional aryan path of initiation, the Solar-Olympian path (left hand path) leads one out of the darkness, not towards a light of abstract nothingness called 'God' or 'the One' but rather towards the development of the inner light of the Hyperborean North concentrating it within oneself as means of casting its radiance glow over the earth and banishing the darkness.

In order to attain such a state of being no prayers to any semitic god will suffice-rather making of life a perpetual combat and strengthening of the Self in pure Self-centeredness-becoming centered in one's Self (the True Self) spiritually through virile opposition to the countervailing forces. The left hand path of power is the path of the gods of Hyperborea and the way out of the Demiurgic matrix prison of the dark forces.

Centrifugal force is the key-implosively generated power making of oneself a battery which is charged through one's own efforts and a drawing into oneself of energy from without (the astral light) not as in the case of the jew through a cruel barbarity of human and animal sacrifice (vampirism of the blood; blood drinking and cannibalism) but a sacrifice of the false self of the purely mundane physical organism to the True Self and a drinking of the blood of the gods-the forces of Being in its hypostases (energy; matter; magnetism and beyond).

Accordingly to thermodynamics energy flows from hot to cold-thus one must develop an indifference to and detachment from the welter of spatio-temporal conditions, to extricate himself from the corrosive waters that decompose (zesetzung) his being and live via immanent transcendence, in Eternity.

The moralizing of the Abrahamic creeds impose restrictions upon his consciousness which undermine his ability to attain this state-the finger wagging of nurse maids stifles development and renders one a perpetual infant whose life is circumscribed by the crib and his dependency upon the breast of a mother goddess figure with only a macho father figure exterior.

He who follows a heroic path upwards to the Olympian heights casts aside dependencies and risks all for the sake of immortality understanding that such a path is the only direction possible all else being a 'miserable ease' and certain slow death. He must keep himself to himself and endure the hardships that lead to the summit not allowing himself to be pulled downwards into the realm of purely material concerns.

It is a path of will power and directed forces-directed by that which transcends the transient world of the spatio-temporal towards the realm wherein is situated the higher principle of consciousness. It is also a path of hardening, of strengthening and developing greater will power, the path of integration into oneself of all of those essential elements that are one's own and enhancing them through those which are susceptible of incorporation into oneself as a bonded substance that fuses with one's being increasing it in an expansive and empowering way.

Self-centered is the only state possible for the immortals. However, this does not not preclude what is usually called 'altruism'-for one's True Self is supported by friends, those organically related to one's Self and the necessary antagonism towards those who are by definition 'enemies', those whose organic being relates to one's own in an antagonistic and destructive manner.

One must be a vortex of forces that combine in himself into one dynamic force crystallizing in the diamond body, hardening oneself for the combat.

Noble Targets: Blood Memory, Blood Sacrifice

Who are the prime targets of the jew world order, the infernal forces of this world? The bearers of the noble blood of the aryan. Specifically those who derive from the warrior nobility (the 1st and 2nd estate of the vedic caste system). They are the embodiment of the Divine Spark, of the Holy Graal, the aryan blood which derives from the gods who came onto the earth and who created this world millenia ago and who were destroyed through the cosmic war with the enemy-the infernal forces who came to operate on the earth in the form of the jews their vehicles of destruction.

These nobility and spiritual leadership passed on the higher consciousness (god consciousness) which derived from the gods themselves (Hyperborean Divyas) to their descendants who are the most able to combat the enemy through their blood memory, an awareness of who they are and what the enemy (the jews and their shabbos goyim and the dark forces who control them) is doing; how they behave; what they may likely do and how.

They have the ability to-through their higher supra-rational intuition-understand the enemy being not, as is the enemy, fixed in their limited consciousness to the lower ego but able to supersede the spatio-temporal Zion matrix and understand its function. They also have the creative capacity to think in strategic terms of how to reverse engineer the matrix and pull it apart at the joints; to discover the chinks in the armor of Zion and strike at its most vulnerable parts.

The jew understands this very well and this is why he has historically been most keen in decimating the ranks of the spiritual leadership and nobility through witch burning and mass murder of those deemed 'heretics' or 'sinners' or of a rival sect of his invented ideology of judeo-christianity.

His study of the nobility is continued in the gangstalking and targeting terror campaigns he imposes upon their descendants. He wishes to map their consciousness through sinister technology (radio frequency identification implants; gathering the frequencies of his target) and to reverse engineer what could never be intelligible to him viewing life as he does from the bottom, the infrahuman level of Being.

Nonetheless it is his hubris bound up with and driven by the megalomania and fanatic hatred for his foe which whips him forward in his attempt to destroy his enemy and to impose trauma based mind control to manipulate the consciousness of the greatest threat to his dominion over the earth. He thus singles out for reasons of irrational hatred and hyper-rational strategy the nobility and spiritual leadership of the aryan race and their descendants first and foremost before all as they are the bulwark against his despotism.

The psyops put forth in the media and its alleged alternate forms, that which is portrayed by him as resistance to tyranny but is merely controlled opposition are designed to invert this reality of targeting the best of the aryans. The jew portrays the typical line-up of non-aryans, females (most of whom are christian) and of course himself as the leadership and main focus of 'victimhood', as the primary targets of a sinister 'neo-nazi satanic' cabal.

In short creating a myth of all of that which he hates as the enemy of all, distorting its nature into a monstrous fabrication that is merely projection of his own debased mind. He presents christians as 'martyrs' when anyone who is of sound mind and possessed of a higher consciousness can infer that the fruits of christian labor are those of the poison tree of Zion and that rather than 'persecuted victims' they were and are to this day the witch hunters and burners of that which they deem 'satanic' or 'heretical', that which in other words is the Good, the True and the Beautiful-the aryan.

Perhaps it is true that the jew targets his non-aryan shabbos goyim as well-what of it? The jew's malevolence knows no bounds-he targets even his own offspring and subjects them to trauma based mind control from birth as means of binding them in ritual abuse with the entities which possess and control him.

He creates a reality that plays to the ego of his targets and dupes-making them feel as victims and martyrs the better to hook them into his messianic egregore of the 'jewish jesus'. They are promised treasure in a fantasy land above in exchange for allowing themselves to be vampirized and further traumatized by the jew who binds them to himself as a 'child of god', of the Israelite tribe from which his man-god 'jesus' came and thus instantly gains the trust of his slave class of gullible goyim.

Nonetheless it is specifically the aryan nobility and priest caste embodied in their decendants he targets-shifting attention away from himself as culprit and serving the aryan up to his minions (christians and non-aryans) as a convenient scapegoat that allows him to feel special and important not only as an alleged victim of their hated superior-the aryan-but in condemning that which the jews hate, inflating their ego all the more in a 'vulgar display of power'.

The jew with his subterranean consciousness understands how to play his pawns on the chessboard of life, understands their finite and defective consciousness and how they might be deployed as his weapons against the aryan. However he cannot-nor will he ever be able to understand the consciousness of the aryan as it transcends his limited constitution as the eagle does the frog who views his inferior from above as prey.

It is the installation into the consciousness of the aryan of his christian program by the jew that has rendered the predatorial eagle the capon of today-the 'modern' man and modern woman-the degraded remnant of his forebears. To purge the mind of the creed of weakness which was spread as a virus into ancient Rome by the jews is needed to avoid the inevitable outcome of a passivity that is the 'sickness unto death', the 'virtue' of the preachers of death.

Such is the inevitable outcome of adherence to such a creed-adherence to a semitic psyop that was formulated by chandal untermenschen in the Levant as a mind virus against the Roman nobility and which led to a dark age of ignorance and superstition.

This nobility-aryans-must redeem their healthy consciousness as means of avoiding the crosshairs of the dark side and rectifying the fallen state they have fallen into though the influence of their foe and their own fallible nature. From thence-straightening out their thinking-they may overcome the enemy and the enemy's murderous project of extinguishing the light of the world, and to bring that light to earth, illuminating the darkness. To shift the crosshairs away from oneself and towards the enemy.

Original 'Sin'

The original sin committed by the Hyperborean arians which lost them their first estate was miscegenation, that is to say 'bad breeding'-mixture with the anthropoid beastmen. Jorg lans von Leibenfels' in his work "*Theozoology*" discusses this in light of the earliest records both archaeological (in stone-bas reliefs; stela, etc.) and in textual sources which reveal the condemnation of the practice, the existence of these anthropoid entities and their voluntary mixing with the arians amongst whom the women were specifically preserved by them for 'sport', for the satiation of their primitive lust with the beastmen.

As then, so today we witness the continual participation in these activities by the aryan females who sully the temple of their ancestors with the contamination of the profane, the simian defilement of their purity-ruination of a thousand generations in a fleeting moment. Such indeed is a sin which has brought low the first estate of the aryan to a state of debased mongrelization and the concomitant loss of those faculties which now lie dormant in his nature and whose physical concretions appear still in the pineal gland and the pituitary body.

The struggle of Spirit and flesh play themselves out as inner tensions which produce a turmoil upsetting the harmonious equilibrium of the inner being and thus introducing the disintegrative element into the consciousness which in cases where an adequate self control cannot be exerted against the countervailing forces reconciling them equilibriously will serve to tear apart the fragmented constitution as a virus replicating itself in its host.

Thus the men of today who are all ruins of the temple of first Hyperborea find themselves fragmented, ontologically fractured by this 'original sin'. It is useless to blame Eve (the female) or Adam (the male who could not restrain her excess, her feral impulses).

No it is not a question of blame but rather of resolution of the problems which have been imposed upon the aryan remnants. They must find their way back to Hyperborea and expiate the sin through the appropriate lifestyle, creating the appropriate conditions of Being who they are in germ: aryan- and thus finding redemption in the only intelligible meaning of the term.

This entails a life of asceticism, of the cultivation of the higher consciousness-Spirituality in the True sense; supra-rational intuition and creative thought-and its development and exercise via theurgy to attain the body of immortal vajra-the diamond-thunderbolt body.

Concretely it means developing a warrior Spirit capable of opposing degenerate trends and infrahuman influences and a segregation of oneself from the mass. A deliberate selection of a suitable partner if possible but not of necessity as the god lies higher than mundane domesticity.

The Domus of the traditional, Norman Rockwellian familia has meaning only when viewed from the heights of Olympus or, if such are unattainable given one's fallen nature for that degraded being to at least cast his gaze skyward thither and attempt to understand his proper place with a healthy respect for the Divine not the servile false humility of the untermenschen but the proper nobility suited to an aryan aspiring towards the heights.

Though the original sin of mixture has condemned the aryan to the mire he has not yet become submerged in it yet and must accordingly struggle against its vortextual downward pull to find redemption.

Combat A Necessity, Ignorance is Death

Those who fail to learn the lesson of this world and seek escape in the pleasant fantasy of a 'hereafter' or a 'heaven above' are simply courting suicide as life in this world entails combat and opposition to that which seeks to oppose one's life through its natural necessity (the attainment or maintenance of the conditions of its being). Life entails death and competitors insofar as they live at all necessarily vie with one another for power both individually within groups and collectively between groups. Such is the law of living in this world and those who neglect it merely ensure themselves a short stay on the earth ('nasty, brutish and short' in the words of Hobbes).

To ignore this brutal combat is to precipitate one's destruction and bring about his death as the forces antagonistic to his being necessitate a confrontation in which the stronger force overcomes the weaker and to put aside one's implements of war is to allow oneself to have the vulnerable parts of his being exposed as a target-this in the manner of the 'jewish jesus' whose only fate was martyrdom, nailed to the cross of his own iniquity.

This worldview, that 'the world' is merely a 'satanic realm' or 'veil of tears' that one must simply pass through as a wandering pilgrim seeking converts to an anthropomorphic deity above is a recipe for the grave as the inevitable end result. At this time in history there is a clear cut divide between choices-an absolute disjunction wherein one may either choose life in this world-and this through combat, through opposition to that which seeks to destroy him or he may choose death through pacificism.

However this is not to say that a purely physical or material life is herein meant but rather life as it is manifest in its differentiated forms at all dimensions of being-insofar that is to say, that 'it' exists as a determinate (and self determining) being amidst Being (the sum total of Being), a self-propelling wheel, an entelechia whose motive principle in the nucleus of their being could be referred to as a 'divine spark'.

It is the spark of their being that the vampire elite seek to absorb into themselves and the mechanism through which they seek its absorption is the creation of psyops or mind viruses of ideology, those thought forms (egregores) which manipulate and influence the consciousness to make their prospective prey weak and easily controllable by their gullible manipulations, which operate on the basis of the vampiric elite's knowledge of the mechanics of consciousness and how to control others.

Their knowledge of course is limited to their own limited consciousness and thus they cannot fully comprehend that which transcends their finite state of being. Hence they have the vulnerability of their own finitude which runs up against the wall of the superlative nature of the aryan.

This is the reason they create self-destructive mental programs like christianity and liberalism, its modern variant-they are designed to pacify the inherent vital will to power of the aryan and thus subjugate any potential opposition prior to having to encounter it-an encounter they can't afford as it would precipitate their destruction.

The vampire elite would seek to bury and snuff out the Divine Spark through the contrived texts they scribe in their subterranean realm of darkness. However, that divine spark cannot be doused and thus will flare up and burn the tombs of false dogma the vampires have scribed.

Ghost In The Machine Fallacy

The lie of egalitarianism, of the equality cult (christian, liberal, etc.) is based upon the pseudo-spirituality of what will herein be designated as the 'ghost in the machine fallacy' (this pertains to those varieties of egalitarianism that are not purely materialistic such as the darwinist and scientific/science ideologies, themselves mere formulations of the equality cult, blinds to the Truth which are dragged across the purblind vision of the masses).

This fallacy claims that somehow the ghost (the soul) can inhere in machines of different nature or type and yet be 'one and the same' such that the ghost a) remains the same although inhering (and how?) in different machines and that those machines (bodies) in their essence do not affect the ghost such that the ghost remains 'the same', ie. equal.

Translated into common parlance this means that the souls of all bipedal beings (so-called 'humans') can be transplanted into other bodies or have no necessary relationship to the type of body with which they are bound (inextricably or extricably) and that b) the ghost remains of a unitary structure regardless of the machine, uninfluenced by it and thus being the 'true nature' according to these ideological formulations.

Those which posit the existence of the ghost (ie. soul) as the 'only thing that matters', the body being a mere 'husk', a machine to be discarded once no longer necessary for the dull, utilitarian tasks of a worldly incarnation in this veil of tears and transmigrate to whatever dimension or 'going to god'-whatever its alleged destination may be.

This fallacy serves the equality cult's purpose of 'legitimizing' the discourse of egalitarianism by attempting to establish a 'higher plane' or dimension of being that justifies according to this regime of discourse), demeaning the essentiality of the body/machine, such that the body/machine is denied in its value to be anything of a determinative nature on a typological basis, ie. in terms of race, the different types of bipedal being.

This is the universalist fallacy: everything, though different in appearance at a mundane/vulgar dimension of being, is nonetheless the same (identical? equal? If so how so?) at a 'higher' dimension such that the former physical plane is at best of subordinate value and at the present time is construed as a 'sin' to concern oneself with in the name of 'spirituality', of a higher purpose or goal, that being what is conventionally called 'Peace'; 'Love'; 'Unity'; 'Humanity'; 'God', all of which are merely abstract conceptions having no concrete basis in reality.

Such a worldview derives from the psychotic mind of the Near Easterner whose schizophrenic nature leads him to a state of inner schism, having an inner conflict or inharmony between spiritual and material dimensions (the races of the body, the soul and the Spirit as conceived of by Julius Evola in his "*Elements of Racial Education*" and "*Synthesis of Racial Doctrine*").

The Near Easterner, especially the Jew is a mongrelized anti-race and possesses the schizophrenia gene (DNST-3) which is an outer symbol in the physical plane of the inner chaos that is the result of incompatibility of body-soul and Spirit aspects of one's identity. For this reason a proper comportment towards Being (Reality/God) is not had but rather a deviant misunderstanding and correlative action creating gods in their own image and denying the reality of 'the world' claiming it as per Mani the Manichean mere 'matter' and 'Evil'-which is an expression of their inability to harmonize at all dimensions of being and in relation to the sum total of Being. Hence as a consequence of his own inner deviance and incapacity to face the world given his own inherent instability and weakness, this leads the Jew to attempt to render himself secure and self-protected through attempting to deceive the non-Jew into thinking that the machine has no value or meaning (i.e. that race doesn't exist or that it is of inferior value or, moreover, that it is something to be 'overcome' and via mongrelization such that no races or distinct types of biological groups exist). That this is the telos or end goal of the Jewish cabal and its pantheistic affiliates who conceive of all things as part of 'one'/'God and thus who seek to negate the identity of those especially who threaten their power if only *in potentia* by virtue of their 'machine', i.e. genetics, physical body).

The reality of Being and beings lies rather in the contrary position, that being difference; separation; integrity and advancement of the being in question which seeks to perpetuate itself over and against countervailing forces which seek to destroy and erode the type (rival groups of bipedal beings called 'humans'; disease; famine, etc.)

The machine (body) is of a certain genetical-material structure ('hylo-morphic'-matter/form in the sense of Aristotle) which structure is bound up with the structure of the soul after the latter's incarnation, the soul gravitating towards a certain material formation upon the combination of two types of so-called humans based upon the law of attraction-"like attracts like as surely as the lodestone attracts iron"-the particular type of body not being a mere machine or mechanism into which the soul inheres but rather a low density form that crystallizes via the souls' incarnating process such that the material form is simply the animate lower density form of the soul and/or inextricably bound up therewith such that the two are one and are merely the same thing vibrating at different frequencies.

To the Jew this is unintelligible as their material ancestors were of such widely divergent nature that the fragmented and distorted soul or souls that incarnated in which they themselves are (the 'Jew') are incapable of creating any harmonious ensemble (body-soul-spirit complex) that can be able to be said to correctly perceive Reality.

Thus as an emanation of the consciousness of this group of being (jews) a distorted set of conceptual systems or ideologies are manifested which purport to separate 'matter' and 'Spirit' in an antagonistic relationship such that a mystical flight "from the alone to the alone" becomes possible in their conceptual system and based upon the ethical imperatives that derive from the concept that all emanate from the One ('God'/'Being').

That all are bound to return to the One if and only if they adhere to the pacifistic-egalitarian theurgical priestly caste system of ethics with the laity of commoners being forced to behave according to the dictates of the priestly caste (which claim to be derived from 'The One' or the higher entities that only the priestly caste have communion with) and for the latter a system of ethics that is simply one of exclusivity and concealment: initiatic so-called 'gnosis' based upon blood oaths and a lawless self-determination ostensibly under the guidance or with the approval of the 'One' or the gods which govern over human affairs or the affairs of the 'chosen' race, their shepherd kings.

Thus the ghost in the machine fallacy is applied only to those not of the 'Chosen race' (jews) as a politico-infernal weapon of power that is designed to sabotage and undermine the opposition through weakening their relationship to their own deities and encouraging their mixture with those of foreign stock precipitating the 'fall of man'. Thus the ideologies the equality cult contrives and seeks to tempt the non-jews with, especially the stronger and more intelligent and Spiritually developed aryan race.

The pantheistic naturalism of jewry is inherently universalist and yet hypocritical, as always the jew views himself as the spiritual superior based on the ghost in the machine fallacy derivative therefrom: that all are one and thus differentiation upon the material plane has no meaning or reality and thus is merely 'dross', that which has an insignificant worth and must be avoided or condemned while absurdly combining with their supremacistic ethos/ethnos.

This, according to their schizophrenic logic enables them to be the master race 'anti-race' while simultaneously being one with 'The One' and all others being forced to destroy their identity so they may be 'reshaped' and attuned to 'God'/'One'/'Being' (the jews' version thereof). Thus to expose the fallacy of the ghost in the machine is to pull aside the veil that conceals the jew in his deceitfulness.

Bellacist vs. Pacifist

In life there are two different types of person: the bellacist, he whose natural tendency is to oppose that which is Other to himself-to conquer if possible or if need be to die in the attempt-and the pacifist: he who, as a fundamental tendency of his being, his *modus vivendi*, is to lay down before that which is 'Other' to himself, to capitulate and to allow the imposition of the Otherness of the Other to curtail and or to negate his own being.

The most artful bellacists are those who play the role of pacifists-who conceal their aggression behind the facade of friendliness and who seek to overcome their opponent through this guileful strategy. Such bellicosity is that of the sneak, the jew, the chandal, and is necessarily artful but in no wise honorable.

The pacifist however, he who naturally bows down and subordinates himself to the 'Other' is neither honorable nor guileful-is the antithesis of the bellacist and thus necessarily loses in any conflict between rivals achieving nothing but slavery or extermination as his reward.

The bellacists may be inclined to honor or dishonor as aforementioned. When honorable, the bellacist faces his opponent openly and combats him strength to strength-more as a contest to determine supremacy between rivals in a way that is minimally harmful to their overall greater good. Should both parties to the conflict adhere to a common standard of combat then the outcome would test and prove the merit of the respective parties who would to what ever degree of willingness demonstrate their proper rank in the hierarchy of Being, in relation to what many would call 'God'.

This applies only to cases of intragroup rivalry of course, where the individuals of subgroups perceive the necessity of the preservation of the larger group of which they are a part. An example is in the case of wars between the principalities of Italy during the time of the middle ages or in the case of Germany and the thirty years war (however baseless and artificial the motive principle may have been).

In such a case it entailed both aryan groups vying with one another for dominance and constituted a '*jus bellum*', a just war, the respective bellacists being relatively evenly matched and thus serving a purpose that within their finite comprehension was 'just'-the augmentation of one's group via wealth and territorial acquisition from another or for the purpose of what was sincerely believed to be a Divine purpose.

Thus such a combat may be considered 'aryan' in the sense of a mode of living or acting that conduces to the greater overall Divine Will and the strengthening of the type that one belongs to and the subjugation of that which is 'Other' to oneself.

Combat which relies on dishonorable means and which serves a dishonorable purpose can be said to be dishonorable and not a '*jus bellum*' or just war. One waged against a pacific Other who poses no threat to oneself for no necessary purpose but simply as an aggressive gesture of dominance over another and which victory does not conduce to an overall harmonious benefit for one's own group in its harmonious relationship with the sum total on the principle of *suum quique* ("to each their own") is dishonorable.

Of course it might be objected by the realist that "all is fair in love and war" and indeed, war is simply "politics carried on by other means" and thus merely a question of the unfurling of one's own flag according to a nexus of causal relations over against each and all regardless of any 'morality' in any universalist sense of the word.

Perhaps this is the True meaning of *suum quique*-that is if one has the power to get what one wants, then he will do so and this necessarily in opposition to that which is 'Other' to himself, running roughshod over the competition with war horses regardless of the suffering of the 'Other'.

Such a *modus operandi* is the behavior of a thug or brute...and yet is it not the case that man in the sense employed today is merely "the sick animal", having become sick through the saccharine poison of christ-insanity and its variants (liberalism; new ageism, etc.), and that moreover all life is "will to power", the vital organism merely existing to vent his strength in self assertion over and against the 'Other'-and indeed all 'Others' save those of his own kind?

Perhaps this iron law of might makes right-within the confines of his own organism (racial soul) is correct and that it is simply misunderstood, being construed as a "war of all against all" on an individualistic basis heedless of collective identity within the confines of the racial oversoul (nationalism in the sense of 'racial nationalism').

The false dichotomy between the collective universalism of the freemasonic 'humanitas' and that of the individual (regardless of race, creed or 'color', etc.) collapses into the totality of Oneness as both libertarian possessive individualism and collectivism (of whatever artificial, inorganic variety) are based on individualism, itself being a mere abstract 'humanistic' ideology without any basis in fact.

Thus one can conclude there are only two directions in which to head: either pacifism and its outcomes: certain death or slavery, or bellacism: and its outcomes, victory or valhalla but in no case slavery which is the fate of the chandala who are born to degrade unto death. Their own inherent weakness and incapacity to resist that which is Other to themselves, ie. the countervailing forces of the Demiurge being their fatal flaws.

The bellacist is the only being who can be called 'aryan'-as he determines himself through himself in opposition to the 'Other' and this either harmoniously or inharmoniously (perhaps it would be better to say authentically or inauthentically): either opposing that which opposes his group, racial soul and its concrete particular forms (individual units of physical race) even at the expense of sacrificing his own life or in the case of the inharmonious) inauthentic type of bellacist seeking to serve his self interested ends over and against his own collective group, or siding with rival groups being of a wholly perverse mind which has no capacity to understand its own good and merely living for deviant purposes (eg. saving the jews or negros or whales, etc.).

Modernity, a product of the degradation of type, of the healthy aryan stock through mixing with negros and mongols over the millenia, breeds the degenerate type which has no conception of Race, is not a 'man of Race', an aryan (noble) having a harmonious soul form. Rather he is a mere 'individual' cog in the machine whose mind is negrified and judaized to such an extent that he lives an inharmonious, perverse life against the survival, expansion and advancement of his own kind, against his own greater good and True Self as an expression of the Divine Will which he defecates upon through a life of 'anti-race' (anti-aryan, ignoble deviance: purely tellurian and Dionysian in nature, in the terminology outlined by Julius Evola in his "*Synthesis of Racial Doctrine*").

From The Periphery To The Center

The *modus operandi* of the cabal is simple enough in targeting the population of aryan who they, out of a jealous hatred for their superior, wish to tear down and supplant as the ignobility (the ignoble neo-aristocracy) of their Zion government which they have been formulating for millenia whipped forward by their dark masters who control them-the vampiric astral parasites who prey upon the souls of the aryan.

It works through, after the jews have intruded by stealth (under the guise of traders mainly) into the aryan society, appealing to certain segments of the population that can be dialectically played off against one another: rich vs. poor; female vs. male, etc. dividing and conquering the aryan by factionalism which is done gradualistically by setting up rivalries and having the rivals attack one another.

This applies to the general differentiated nature of the nation which admits of elements who are of varying degrees of power and influence. The jew seeks to use these groups as antagonists, exploiting the comparatively powerless and their desperation against the comparatively powerful and encouraging the latter in the exploitation of the less powerful as means of inflaming mutual antagonism and contempt, driving the thin end of the wedge between the different groups and exacerbating tensions as means of generating ever increasing chaos in the society, progressing towards its collapse through this fragmentation.

Historically it is the playing different castes off against one another that has served as so many cats' paws fishing chestnuts from the fire for the jew. However, throughout history and especially in more contemporary times once the more elite and powerful castes have been alienated from their own people [by the stoking of the fires of revolution by the jews through propaganda and the exertion of mental influence via the contemporary organs of (mis)information] the ever widening periphery of the outcast, the chandala, the marginal increases and once sufficient numbers arise they are used as so many wedges to tear apart the once integrated society/nation (when it was an 'organism' properly so-called).

The center of the nation-the norm-becomes ever more vulnerable though the creation of division between the divergent sects and thus weakens proportionally. The jews accordingly use the peripheral elements (criminals; outcasts; eccentrics; quasi-criminals and deviants) against the center, the backbone of the society, the middle class as a means of attempting to break it and thus to break the nation itself, creating an extremist polarity between rich and poor while absorbing the wealth of nations and decimating their competition for power by using the periphery as their cats' paw or battering ram.

The larger the periphery the more the abnormal becomes normal and the more quickly the nation is sabotaged amidst the chaos of revolution. Into the ranks of the jew's cabal come elements from this peripheral space which functions as a vortex of dark energy matter which seeks to absorb all into itself.

The ultimate end or fate of the presence of the vortex is the destruction of the nation. Those absorbed into its ambit be they wealthy or poor are subordinated to the jew who transmutes them via his black magic into his agents of subversion though they are not necessarily aware of the fact, the very participation of these elements in his system (now all but officially declared) renders them his slaves and cancerous cells in the host body of the nation.

These cells proliferate and exude their poisonous influence which eventually leads to a terminal point where the nation is degenerated by cancer. The solution to this problem is multi-fold: exclude the jew (eliminate the cause eliminate the effect); ensure the establishment of more orderly standards of society that conduce to the integration of the whole in accordance with the maxim of *suum quique* ("to each their own"-their own proper place in the nation based upon their mind/body/spirit qualities).

The periphery thus constitutes a danger for the center-for those who are centered in their being, who constitute an integral member of the nation rather than a pariah or fragmented being whose existence operates in a cacophonous manner creating disharmony by virtue of their having no place in the center save as its disturbance or disruption.

This has always posed a threat to the aryan nation's historically-the element that is 'Other' to the center; that which by virtue of its deviance is the bearer or embodiment of chaos, a veritable powder keg of irrational tendencies which, like a munition could explode upon being triggered and harm the center.

However this element, that of the deviant, perhaps the tainted genius, constitutes paradoxically the spark which lights the fuse of revolution against a crystallized center which becomes static and incapable of vital expression, closing in on itself in its own narrowness (if and only if that center is not of a dynamic nature having its place within the larger caste system that offsets its tendency to sclerosis and impinges upon it in such a way that it conduces to a sustainable dynamism of a developmental nature).

Strengthening the center against the periphery (that which is 'Other') serves to achieve the result of an upward vitalization. Such is the competition of life that makes the organism strong and enables its continuance in the dynamic flux of becoming, making of it, in the words of Aristotle, an entelecheia ["the actualization of the potential form or function of a substance"].

The jew for this very reason strikes against the center (the heart) of the nation so that he himself may become the Center-surgically removing the heart with the scalpel of the periphery and the buzzsaw of revolution. To thwart his aims is the goal. This for those in positions of power to effect the change, for those not so positioned they can only attempt to avoid getting sucked into the vortex of the forces of chaos and this through developing an inner strength through challenging oneself in confrontation with the peripheral elements.

Seek To Possess And You Will Be Possessed

The creed of mendacity is that of the lowest castes-the 'merchant' (vaishya) and the serf (sudra); that of possessive individualism.

In the case of the third estate (the bourgeoisie) the creed orients around the employment of the faculty of reason as instrument, tool of economicity-will to power to will to possess, to acquire and accrue to oneself as an individual, an atomistic economic unit, a producer-consumer machine the fruits of one's labors (via occupation) or that of others (via usury, itself via a usurious occupation such as a stock broker or a real estate investor).

The will invests itself so-to-speak in a commercial trajectory-the pot of gold at the end of the rainbow being the driving force which serves as a conduit for the will to power. Reason is exalted as the mediator between the Self and the object towards which the Self comports itself as object with the structure 'to-be-apprehended' or 'possessed' (as in the case of Hegel's "Philosophy of Right", as an amplification of the concept of a 'conception' or a concept-in German etymologically related to 'grasping'/'begriff'-to grasp, to 'conceive', to 'conceptualize').

Thus the knowledge object becomes a commodity and reason is the modality of labor of its acquisition-the rational man of the professions being an entrepreneur or capitalist for whom knowledge is capital and the higher quality and more extensive the wealthier he is within the context of the system and *eo ipso* the more valuable, the more powerful (will zur macht-will to power).

Thus to be endowed with a certain knowledge-set is to be qualified (and to qualify is to posit oneself) as a power, a receptacle of power whose ontological structure is 'powerful'-to whatever degree (the quantity of quality is degree).

Thus the third estate defines itself and, by virtue of the natural tendency inherent in all organisms, its members vie with one another in the *bellum omnia contra omnes* as means of attempting to gain a monopoly on power for themselves based upon the possessive individualist orientation.

The fourth estate are still further removed from redeemable qualities in terms of their materialistic trajectory towards the hells and away from Spirit. They live not for bread alone but for bread and circuses alone, the faculty of reason being weaker within them or perhaps altogether absent they are motivated to an even greater degree by sentiment and its transient nature of irrationalism and its necessary tendency to fragmentation of the personality and lack of controlled will through lack of sufficiently development faculties of its management.

This caste seeks to pillage the rich out of a jealous hatred for their betters and the brutalizing influence of toil which undermines their ability to perceive the higher states or being that lies within them or attain them owing to their erosion through "working their fingers to the bone".

Both castes are oriented towards the hells and are unduly focused on material possessions having no guarantee of their continued possession owing to their obligation to compete for the maintenance of their position (their rank) and the lack of fixed principles which ensure their place-at least with sincerity. The bourgeois caste constitute a hypocritical aristocracy at its higher levels in which wealth and power are concentrated and monopolized (oligopolized) under the pretext of equal opportunity, allowing others to participate in their *de facto* ignoble nobility or their 'cacocracy' (from the word 'kakos' meaning 'bad' in Greek); the term 'aristos' means virtue deriving from the prefix 'Ar' for aryan-itself meaning 'noble' in sanskrit, connoting the being of a higher spiritual being, the aryan noble man).

The very hypocrisy of the bourgeois caste is that which enables its downfall as the foundational principles of its being-liberty; fraternity; equality-undermine it. Thus it is a citadel of gold built on quicksand by rapacious architects who concern themselves only with the quick buck and/or have blinded themselves by the sacred cow of 'humanity' whose golden sheen concealed the reality-that of a dunghill).

"Seek to possess and you will be possessed". This is because (the possessive individualist) hyperfocuses his consciousness on material things (even the knowledge-object of commodities in the market place of ideas, themselves mere items of itself whose value is an empty universal value form-the value they are endowed with being based upon the market and those who control it-the hypocritical hierarchy who pulls the golden wires of their goyim puppets through the economy-political and financial, social and libidinal-the latter as the foundation of all of the superstructure).

They become earthbound souls whose consciousness, like the pig, is rooted in the mire as they pursue their truffles. The act of transferring one's consciousness away from its inner form-outwardly towards the object of knowledge or material/aesthetic commodity (the object/percept of conscious awareness-the intentional object about which knowledge is had and made into a 'concept'-'begriff'-grasped and appropriated to oneself, placed into his coffers augmenting his power/knowledge set).

Through the act of transferring consciousness to the Other one entails the risk of decenteredness, of becoming contaminated with foreign and harmful contents of consciousness that may pose harm to the integrity of one's being assuming he has insufficient power to overcome the Other in its Otherness.

This is the necessary condition of his being however and thus what may be deduced from this principle is that "all life is struggle" as Hitler said-one must overcome the impingement of the 'Other' on one self at the phenomenological and ontological level-to assimilate it and transmute it through his being or to be overcome himself. If the latter to become opened up in the nucleus of his being to outside forces which accounts for possession and obsession by entities who prevail over oneself through the Self's orienting itself over much towards the 'Other' (the commodity upon which he fixes his gaze; through a grasping will-'begriff', a will to conceptualize and control and dominate or appropriate into oneself the Other).

Thus however unpleasant it may be to the domesticated animal that the members of the third and fourth estate live in a vampire world, a *bellum omnia contra omnes* and "those who refuse to fight in this world of eternal struggle-do not deserve to live"(Hitler), as the nature of Nature (of the Divine Will) tolerates no acquiescence before an opponent for in such a 'possum play' the weaker force gives way-if and only if the possum play itself is not merely another move in a sequence of moves on the chessboard of life.

Thus not only should one value the continuance of his existence he must take a cue from Christ and "sell all he has and give it to the poor"-if only hypocritically and *in imaginatio*. The ultimate principle here is where to focus the will-Self or Other.

The gangstalkers are all possessive individualists whose lower egoic consciousness leads them towards the baits put out by the Jew. Theirs' is what might be called 'profit motive', the Mammonist orientation around the procurement of external value they wish to appropriate and incorporate into themselves as an act of black magic (*vide* James George Frazer's "*The Golden Bough*").

These baits are the fiat currency of Zion, not bank notes alone but rather any token of value which is established by the controllers of the system as constituting value as a social signifier of worth or status. It is primarily these baits-those of a materialistic nature-that is the conscious intention of the perpetrators. However the ur-conscious/subconscious intention as aforesaid is the sadistic thrill that accompanies the visitation of harm to the target that the perps desire-the pay off of the libidinal economy of the monkey minded perps whose conscious intention is always directed towards the 'maximization of pleasure and the minimization of pain' and this in the crudest and coarsest forms.

Manifesting itself through the libidinal reptilian brained self-activation is the will to power whose vehicle simply happens to be the only act possible for those governed by the base drives and incapable of elevating themselves above them in a conscious resistance against the beast.

Thus the motive force of the gangstalker is 'will to power' expressing itself as a working up or stimulation of the reptilian brain (the pons/medulla and brainstem) and metaphysically as well as physically the activation of the lower energy centers (muladhara chakra and the generative and excretive anatomy), a characteristically Jewish exercise.

It is best to speak of such 'exercises' as 'exorcises' however as they correlate with the demonic possession that the Jews' and their non-physical masters seek to achieve. This is why all actions and norms the Jew encourages the adoption of orient towards the reptilian brain states with their sex-death nexus (eros and thanatos) and the hyperfocus and ultimate welding of consciousness of the 'I' to that spatio-temporal point (the uro-genital region and the arc-complex of pons/medulla/brainstem and correlative pleasure centers of the brain).

This is what might be called the acquiescence to the dark side of the force, a failure to resist the 'current of disintegration', through strengthening and directing the will towards the higher energy centers (vishudda; svadisthana and sahasrara chakras and above) and remaining 'centered' in one's being against the perpetual pull of the dark forces whose power is enabled through directing one's attention to the lower states of being.

The phenomena the jews present (temptation) to the aryan are mechanisms of shifting their consciousness towards meaning which works up the lower states of consciousness in the undeveloped person, the person or rather 'individual' who is not strong in his being as an integrated soul, who lacks control through lack of challenge through exercise of the will.

The jew amplifies the correlation between these lower type of phenomena and the associated noumena-the media he controls correlating phenomena with noumena that lead towards the creation of lacunae in the soul or weak points that enable him to debase the consciousness of the person/individual and enable possession by these entities.

An example is the usage of nudity-ordinarily a perfectly natural or non-sexual phenomenon correlated through false associations by the jews with noumena designed by him to shift the consciousness towards lower states of consciousness, directing the focal point of consciousness towards the lower energy centers and activation of the lower regions of the anatomy.

The meaning is 'systemic' or 'contextual' in the manner in which it is portrayed in the particular phenomenal/noumenal context, being not entirely visible, audible or physical in general but an ensemble or mixture of unrelated or only semi-related elements (the seductive perfume of a woman and the presentation of a suit of clothes within the context of an advertisement display, or the subacoustic subliminal message repeating a salacious word or phrase over and again to entice the consumer of a commodity; the pairing of an image of a murder victim in a newspaper with certain formulaic words or syntax that have implicit and even magical meaning unbeknownst to all or most all of the readers; the pairing of an event such as a false flag terrorist operation the cabal stages with a targeted victim and perhaps creating aetheric changes through magical rituals on certain occult holidays in conjunction with advanced technology such as E.M.F./E.L.F transmission to modify the consciousness of the experiencer of this orchestrated act in the "theater of the real").

The cabal minions and handlers involved in the gangstalking have opened themselves up to possession by these entities (archons; mudshadows; asuras-call them what you will) and thereby play host to demons. Their consciousness, their 'mind' is no longer their own if it ever was, the higher ups being generational occultists as are many of their minions who are possessed generationally (such as in the case of generational police and military brass and even rank and file).

Accordingly they have exchanged self-possession (the centeredness of their soul as an integrated aspect of their being) with the possession of thrills, temporal transient gain, and 'worldly' desires which merely serve to further submerge them into the pit, the abyss of 'hell', dragged thither by the archons to be consumed in the 'second death' and *in vivo* throughout their lives.

They have forsaken their True self (the soul-Spirit) for the false (the lower egoic persona, the mask which conceals their emptiness as 'the hollow men') and have damned themselves through their own iniquity. Through the weakness of their character which is oriented towards the lower states of consciousness they have purchased a ticket to hell through selling their soul to the jews and their masters.

Those who may escape this fate are they who develop an adamant self possession completely centered in themselves and unshakable in themselves as a fortress under siege resists the onslaught of the forces of chaos.

Beyond this defense against the enemy not a brutal attack is needed but rather the attack from Olympus, the holy war of the gods against the would be demigods of judeo-masonry. For the targeted person who exists in the crosshairs of the cabal only returning fire is an option and this in the only effective way possible given that anything he does in the mundane plane would simply be stifled by the cabal and its creatures.

He must strike against them through use of spiritual forces as they alone can enable him to avoid the physical backlash of the police state. From the fortress of the mind missiles of adamant must speed to their targets.

Enemy

One must know the Enemy: who he is and how he acts

Original 'Sin'-Jewish Influence

The original sin of miscegenation did not arise purely through the lust of Eve (of the aryan female) nor did it arise purely through the weakness of Adam (the aryan male). It was rather the serpent who entered into paradise and who corrupted Eve and who perhaps placated Adam's inevitable opposition to his presence with the promise of filthy lucre (the willingness of Adam to sell out and to look the other way being perhaps a result of the idealism inherent in Adam-his desire to achieve projects or attain some objective necessitating the possession of the requisite capital-for which Eve was the necessary sacrifice, allowing the anthropoids brought by their jewish pimps into Eden, paradise, to fetch a high price for the carnal delights they offered Eve-this and the weakness of her husband who had not the power to restrain Even in her lust).

Thus the blame is shared by the jew who represents the tempter and Adam further proves his weakness of will and fragility of ethics and principles in permitting the entry of the serpent, the jew and his 'wares' of anthropoid beastmen who then defiled the purity of the blood leading to 'the fall of man' as von Liebenfels reveals in his researches in "*Ostara: Magazine of The Blondes and Masculinists*".

The Jew has always been a trafficker in vice as a natural tendency and he utilizes this vice as a means not of profit alone but for more sinister purposes—that of the destruction of they who represent a light which outshines him, the Aryan. It has throughout the millenia been the protocol of the Jew to defile the blood of the Aryan with the temptation of the flesh. This is his vengeance for his own fallen state, a natural tendency to tear down and reduce to a lower state of Being that which offends his sight. It offends his sight as he is blinded by his own ego and can't overcome his egocentrism—wanting to look upon himself as the be all and end all he seethes with jealousy when there are those who are capable of soaring to greater heights and who have the consciousness that derives therefrom, the Holy Graal or the Divine Spark not present in those not of Aryan kind. It is the recognition of his inferiority in relation to that which exceeds his lowly estate that motivates the Jew—out of an instinctive hatred and malice—to tear down the Aryan from his height and this in the most coarse way of sullyng his nature. It is an ontological assault against the gods and their decedents (the Aryans) that the Jew orchestrates—he wishes to destroy the being of the Aryan and to supplant him as the god of the earth.

That he never came from heaven (cosmos, the stars) implies that he can never return thither or bring upon earth any heaven of milk and honey but rather a veritable hell in his own making, modelled upon his telluric consciousness—purely animalistic and oriented around the base drives perhaps overlaid by a fictive 'supernatural' world which is itself a fictional byproduct of his failed transcendence in imminence.

He is the embodiment of the original 'sin' of the flesh and against the spirit and thus he perpetrates sin with every word and deed. One can infer the Jewish nature simply by observing the modern world and its corruption which has as its fount the Jewish mind, from which pours forth the sewage that is the hell on earth of Zion.

The Rhetoric Of The Victim

A self-defense of the weak and meek is the rhetorical smokescreen of victimhood that they perpetually throw in the face of their betters as a means of shielding themselves from the power of their betters, its exercise amounting to a denial of their own through the greater force eclipsing the lesser.

This is the dynamic of power that prevails between the confused and beguiled superlatively powerful Aryan whose mind is placed under hypnosis and anaesthetization by the Jew who is the weaker power in physico-spiritual terms. The victory is attained through deception, playing upon the mid of the greater who may also be greater in terms of intellect, intuition and creativity but whose achilles heel consists of an empathic 'Other'-regard that enables the 'Other', the relatively weak Jew and his hordes of dumb-downed savages, to creep into the civilization of the Aryan and to take what he did not create. Indeed beyond this to harness the creative Aryan into slavery and to decimate his ranks as recently seen in the Bolshevik revolution of Russia where the elite ruling caste were exterminated and the remnant reduced to slavery with Jews ruling over all. Such is the *modus operandi* of the Jew: infiltrate, assimilate; agitate and exterminate.

The rhetoric of the victim's of the jews' shoehorn he used to insert himself into the golden slippers of the aryan. His rhetoric is a sweet admixture mixed with the anaesthetizing poison that pollutes the brain of the aryan and enables him to get away with his protocols of takeover and total control. This rhetoric is merely a linguistic form of his cunning consciousness which is a collective consciousness and not something that can be restricted to mere 'individuals' as if any humanoid entity could be conceived to exist in a vacuum completely apart from all others when all are inter-related in terms of degrees of power and proximity which latter factors determine the degree of influence upon that which is 'Other' to themselves.

Truly all are one in the sense of participation in the sea of Being-however that in no way argues for mixture as life is a dynamic system necessarily entailing conflict and antagonism, the absence of which amounts to the cessation of life itself-"All life is struggle" as Hitler said and failure to struggle by having an absence of antagonistic forces which struggle against oneself is to precipitate one's destruction.

This lack of struggle or vital antagonism is what is termed in (post)modern parlance 'peace', a prescription for destruction both of the higher principles of one's being as well as the lower for 'as above so below'-to destroy the physical vehicle is to harm if not to destroy the higher or at least to prevent its reincarnation in a similar physical vehicle and thus to negate its being in higher dimensions ('genocide' in other words, both spiritual and material).

The jewish strategy of antagonism manifests itself through deception-such is its *modus operandi* as a compensatory mechanism for his own inherent weakness-the rhetoric of the victim, being only a particular instantiation of that *modus vivendi*-the mode of life of the creeping leech or the noxious parasite who buries itself into the host and absorbs its vital energy into itself as a necessary condition of its existence, its essence.

To allow the jew to perpetuate itself within one's midst is to allow the jew to increase its power at the expense of oneself. To listen to the rhetoric of the victim that is put forth by the jew and all of the jews' imitators and hangers on (non-aryans; degenerates, etc.) is to enable one to become disempowered as they open up opportunities on the part of themselves to vampirize the energy (money; power; bio-energy) of their betters and to augment their own power.

This is why the jew has artfully honed his rhetorical skills throughout his trek through the ages, wandering amongst the arians and seeking to absorb their wealth and destroy their nations by stealth. He has developed a great deal of skill in his observation of the 'Other' and has activated tested methods of 'gaming' the aryan, of assessing him and manipulating the inner workings of his nemesis. This is the subterranean strategy he employs.

His rhetorical weapons match or correspond neatly in a linguistic form with that of his other forms of giving combat in his survival: economically/financially he develops systems of usury which he employs to harness his nemesis with the crook of prospective gain.

The aryan leader or non-jewish ' Other' is beguiled and voluntarily assumes the yolk of debt and is then forced to conscript his own people to shoulder the burden while he sits atop his golden throne- until such time as the jew brings into being the revolutionary reaction that he was himself instrumental in bringing about *ab initio* as means of doing away with the upper caste of non-jewish opposition.

Once the jew has wormed his way into aryan society through usury (lending/trade) he takes the reigns of state via intermarriage again employing his artful tactics of manipulative rhetoric as mechanism of getting his foot in the door. Once in power he then crafts a complex web of legalistic architecture that he employs as his net of entrapment of the host population the better to drain their blood into his rapacious maw.

Organized religion works in lockstep with his more mundane plans and is the primary instrument of their realization: "as above so below", though that which he constructs as 'above' is typically a contrived world of illusion, a pure fabricated distortion of aryan Spirituality. He sells religion like pretzels in the shtetl or diamonds on the diamond market: another commodity that is proffered to the non-jewish masses having either overinflated value or being merely a valueless simulacrum.

The diamond is the perfect example: a quite common stone whose worth is amplified in the mind of the targeted demographic (namely the non-jew) through clever advertising. The religions of today are merely the diamonds the jew sells to the non-jewish slave caste he wishes to maintain in harness and hijack their mind to serve his interests which latter are built into the religions as their underpinnings: universalism and overt or covert jewish supremacism. Thus the rhetoric of the victim, endemic in egalitarian ideology (all mainstream religions also) has served the jew as his main source of power and as means of diminishing and ultimately extinguishing the power (the life) of the aryan nations he has invaded and sought to overthrow.

Jim Carey, Jew Scary

The Canadian born jew, Jim Carey, an actor made famous by such movies as "Ace Ventura: Pet Detective"; "The Mask"; "The Cabal Guy"; "The Truman Show", etc. all reveal the jew in his sinister aspect, which is to say in his true aspect and which movies serve as a vehicle of revelation of jewish methodology.

The following is a brief analysis of these movies. The writer is not overly familiar with the character of Jim Carey as an actual person, assuming anyone is or could be, and thus can only look as it were 'through a glass darkly' into the diabolism of jewry as filtered through the motion picture cameras of 'satanic' (ie. jewish) hollywood.

The difficulty of discerning the jew and just who the jew is as an actual person or being behind the mask of personae he wears is intimated in the movie "The Mask" which illustrates the figure of an average everyday 'individual' who discovers a demonically possessed mask.

When put on it transforms him into a different persona, a different person, one who is 'green' in color, presumably referencing the green man Osiris and 'the great work' of alchemical gnosis (transmutation of the lower into the higher or True self) and the attainment of superpowers, the ability to manipulate time-space and to transcend the limitations of the former 'human condition', ie. spatio-temporal limitations within the realm of 'becoming' or in the phenomenal world.

Perhaps also the green color that becomes the skin of the 'masked man' once he places the mask on his face connotes venus, the stella matutina (morning star) and the 'lucifer spirits' which are alleged by such as Blavatsky to dwell within this realm? The mask worn by the jew is the means through which the jew adapts himself to this material world, being presumably in whole or in part, an alien entity bound up (again the writer ventures a presumption) with reptilian aliens, or whatever other entities that empower him and facilitate his hegemony over the earth.

The jews' mockery of the 'goyim', of the 'gentile' authority is readily seen throughout all of the movies Carey has starred in but is most simply perceived in that of "Ace Ventura: Pet Detective" wherein the mockery of American culture (eg. its obsession with football) and of masculine heros is showcased (eg. the portrayal of alleged masculine archetypes such as football stars as androgynous trans-sexuals); the portrayal of Carey as a clownish 'sophisticate', lampoons the 'hard-boiled' detective archetype which was previously exalted in jewish hollywood during the time of the jews' building up the police state through the excuse of combating 'gangland' in the prohibition era (jewish actors playing detectives that were typically heterosexual aryan anglos and German and Irish stock-the Hyperborean stock that created America in its origin as a means of continuing their fight against jewish mafiosi as means of further introducing the appearance of mafia glamor in the minds of the naive youth, conditioning them to become as jewish heros were portrayed in the 'pictures').

Thus Reality is inverted as the jews' black magic technique of slandering and bringing to destruction their enemies, conditioning the latter to interiorize the archetype of the goofy 'male', metrosexual, who simultaneously (in fiction but not in fact) is the 'winner' in 'the game of life' amidst the players of alpha male dominator types. The influence of such movies is to weaken the aryan male youth and thereby weaken the aryan society, and replace the 'hard boiled' leadership with the cadre of corrupt jewish 'macho man' types in the mold of macho man Randy Savage of wrestling fame (infamy).

The 'goyim' of the aryan males are yet further lampooned by the jew Carey in the film "Dumb and Dumber" which is an even more overt portrayal of the 'dumb goy', who is a stereotypically low I.Q geeky and vulgar creature who lives in a world of foolish idealism questing after a female archetype (the red haired devil in a blue dress) and expending the sum total of their life force in this 'quest' for purely mundane lust as opposed to Cosmic Love (living in the matrix as a 'goy' with beast consciousness as opposed to living outside of the matrix and having cosmic consciousness; living for the lower instead of the higher self).

The inability of the goy to adapt to 'elite society', of the elite caste, serves as a demonstration of not only the ineptitude of the 'goy' played by Carey but the dual purpose of mocking and denigrating 'W.A.S.P elitism' in the person of the infiltrator jew Carey who, through playing a 'dumb goy' is nonetheless a jew in actuality. Thus the archetype of the 'superior jew' who condemns the 'material world' of the 'goyim' is put forth and the inevitable defeat of 'gentiles' of all castes (both low and high) is also put forth.

"The Cable Guy" is a vehicle of the revelation of the method of the jew in showing the consequences and effect of the mediatization of the 'goyim', of how they become their program, their consciousness consisting of nothing but a loosely tied together series of images; sounds and other forms of phenomenal illusion woven together as the tapestry of their 'mind'.

Thus their 'mind' is in reality a mere program or composite of various forms of sensation trapping them in the matrix of illusion and preventing them from existing at any higher dimension of being, rendering them slaves who are ripe for the vampirization of their bioenergy. Such is the programming of the biocomputer mind by the jewish architects of destruction.

"The Truman Show" is yet another vehicle of the jews' revelation of the method and relates to their protocol of surveillance and intervention in the affairs of others in the form of their targeted individual/gangstalking protocol as spoken of in the protocols of the Elders of Zion. The hopeless dupe in the Truman show is portrayed ironically as a mockery of the goyim, as the 'True man', he who is trapped within the matrix of Zion subject to the perpetual monitoring and manipulation of the engineers of the system and their lower level minions. Of course the 'cursing of the gentiles' aspect of the film, is revealed in the fact of its apparent 'benignity' and lack of the actual malevolent sadism involved in the actual protocol of gangstalking.

The Trueman of course is not as portrayed in the movie, a hopeless dupe who perhaps has a dim awareness of the trauma-based mind control being imposed upon him 24/7 and at all times and places (an absence in the movie, the surveillance and monitoring being portrayed as 'benign' and altruistic instead of the actuality, being malevolent and diabolical).

The Trueman is the man who can transcend the matrix and its disintegrating influence on his soul, the 'zersetzung' which is carried out in the targeted individual program. Again Carey portrays a 'aryan man' and portrays him as having some dim awareness, being gullible and stupid, and inevitably (as a jewish revelation of the method) having revealed to him by his jewish engineers that he is living in a matrix and that he is a dupe of their 'benign' experimentation, when the reality is that the malignant experimentation is carried out by jews who desire the 'goy' to know what is being done to him only to the extent they can reveal this information to him as means of making him aware of the torment he is being subjected to to enhance the pain and suffering which they will not cease and which the target is made aware of.

The target is of course the aryan man in actuality and the jew is the mad scientist sadist who seeks to harm the former as means of feeding the demons the jews are bound up with, the more pain and suffering caused the more energy released, the more energetic food which can be vampirized by the jews and their demonic entities.

Jewish hollywood creates these revelations of the method to attempt to "let the goyim know what they are doing or going to do before they do it" as means of attempting to discharge their sins for their habitual theft; abuse; torture and murder from the 'goyim'. Jim Carey is yet another tentacle of the giant squid of jewry which is controlled by the hive mind of Satan and which manipulates its minions on the earth in orchestrating its chaos to vampirize their soul energy.

Wolves In Sheep's Clothing

The jews' protocols for global dominion are realized to the extent they have been through deception. Had they been overt about the implementation of their plans they of course would have failed. Their only means of success-again given their relatively small numbers and lack of creative genius and will power lay as it still does in claiming the garb of a sheep and attempting to: 1) pacify or allay and 2) beguile the opponent.

Appearing therefore weak, the wolf in sheep's clothing operates through artful legerdemain playing upon the behavior/psychology of the non-jew specifically the aryan, the creator and sustainer of civilization upon whose back he rides as the parasite leeching off the host. He is not thrown off as he has acquired a detailed knowledge of behavior of the aryan-of the latter's reactions in various times and places which have been seemingly codified in his system of law as it relates to others, in the practical techniques he employs, in the attempted usury and overthrow of the targeted host.

1) pacification relies upon the manipulation of the mind of the non-jewish Others in contemporary times. It is N.L.P and emotionalization amongst other techniques that are used to win the loyalty of the Other; the creation of common enemies that the jew and his dupe may mutually target ultimately for the former's benefit and the latter's detriment over the long term; and ingratiating demeanor and serving as a bearer of gifts whose real value renders them false (being overall more harmful than beneficial over the long term).

This transferring of potential aggression on the part of the non-jew by the jew via the latter's manipulation towards the common enemy takes the heat (potential or actual; in the jew's mind inevitable) off himself and enables the jew to utilize it as a weapon against a scapegoat or enemy 'Other' (in today's world muslims, liberals and aryan racists/antisemites of all variety).

The ingratiating demeanor, the usage of a conspiratorial tone, one being the promise of gain and advantage, conscripts the non-jew onto the side of the jew enabling the latter to not only acquire the asset of the aryan power but to convert a sword potentially used against himself into a shield he may use to protect himself.

Hence the jews' appealing at various sectors of aryan society for example to the rich and turning them away from the poor of their own race with indifference and at the lower level the poor-as a reaction to policies the jew has been instrumental in causing to be implemented-against the rich.

Thus he divides and conquers as a wolf in sheep's clothing: for the nobility he is a descendant of levite priests or at least a humble lender or merchant simply seeking mutual advantage; for the poor he is a rabble rousing revolutionary firebrand who wants to crusade for 'justice', 'peace' and 'equality' all of which are codewords for his own supremacistic tendencies and are yet another weapon in his arsenal to use against they who are his hated foe: the aryan, who are cosmic enemies that have been engaged with him (and he being the instigator) in a war to the finish-the Ragnarok; the apocalypse, in the Kali Yuga.

The wolves in sheep's clothing only discard their costume once they anticipate they have sufficient power that it is no longer necessary to conceal themselves. At such time events such as the Bolshevik revolution arise out of the circumstances the jew has brought into being as an act of black magic. At such times-the wolf age in miniature it might be called and at the present time on the cusp of the macrocosmic wolf age, the jew is poised for the chaos with all of his mind controlled minions arrayed on the battle lines-fighting against one another and against they know not what-simply the 'Other', that which the jew has inculcated into their mind as 'enemy' as the target they must attack without question, as to question would be 'ungodly'; 'satanic', against 'our values'.

The non-jewish puppets naively become their programming allowing the jew to hypnotize them with his black magic techniques of ingratiating: tone; cadence; pitch; diction; repetition; enunciation, etc. (color; sensation; image; symbol, etc.) and in doing so they become an instrument of the destruction of the jew's enemies and ultimately as an end result an instrument of their own as the jew and yet other of his minions would simply do away with them after their use value is expended.

For this they pay the price of their soul which the jew and those entities they are bound up with vampirize as their food. This is the realization of the protocols of the jew: total sway over the whole planet as a prison planet soul farm wherein the goyim are commanded to be 'fruitful and multiply' so that the jew and his minions can have their souls as its sustenance.

Hence the jew shows his true wolfishness in the end and his sheepish facade is torn aside by the clawed paw of his innate ferocity.

The dilemma of the jew consists of his over eagerness for blood (soul energy, the blood is the life) and his premature casting aside of his sheepskin, this born of hubris, his chutzpah. The arrogance of the jew is his downfall and the aryan comes to recognize that what he initially had come to understand as a sheep is in reality a dangerous foe that must be dealt with not with extreme prejudice but balanced judiciousness meaning the declawing and defanging of the jew.

Criminals With Badges

The agents of the Jewish occupation government are portrayed in the Jewish controlled media and education system as hero figures whose purpose is to confer 'safety and security' upon the larger society, to maintain societal order, what is conventionally called law and order. This 'order' is the Jewish world order of Zion and is not in any way universal or cosmic in the sense of a cosmic law wherein different groups (mineral; vegetable; animal and so-called 'human') are given what they need in order to maintain an organic self-sustaining and self-sufficient Order but rather an order which enables the vampirization of the population of these distinct beings (from the mineral to the human kingdom) for the enrichment and empowerment of Jews and to the extent these servants are serviceable to the Jews. To the extent they are not they will not be so enriched but rather the contrary: stripped of all of their worldly goods, their culture, and even their body and soul taken and destroyed to be absorbed vampirically into the Jewish vampire whose role in society is one of predation.

The order is the one of hegemony and empowerment (and maintenance of power) of Jews, and is enforced through myriad subtle and underhanded techniques by their agents, those who have the kosher certification to employ these means against those who they do not want to exploit as their slave class.

The weapons of war span the gamut of the sinister: from the more coarse and brutish weapons of rude implements such as batons, tasers and firearms to more subtle of scalar and directed energy weapons; the usage of myriad psychological tactics of the manipulation of consciousness (neurolinguistic programming; voice-to-skull synthetic telepathy; pharmacopia; electromagnetic fields from cell towers; drones with the capability of deploying these energy weapons, etc.).

The war is 4th generational warfare and is against the so-called "civilian population" who are qualified by the Jewish police state and its agents as the cattle, the tax slaves who are used purely as a source of bioenergy to be vampirized by the parasitical priestly caste. 4th generational or unconventional warfare so-called means that they are enemy combatants in potentia and the so-called 'good guys' are the kosher certified (by virtue of their badge) slaves of Zion-the zogbot ironheel enforcers, the 'bad guys' are the amorphous 'population', the battleground is the society itself which turns in against itself in an act of autophagy, of self-consumption.

The parasitical controllers who control society have engineered the minds of their goyim via artful mind control to such an extent that the latter become their programming and are incapable of transcending it as they are classically conditioned to carry out their masters' protocols. These appear to them (are made, are designed to appear to them) as their own plans and thoughts being the source of short term self-interest and ultimately long term self-destruction. Their perspective having been rendered myopic through their programming, restricted merely to immediate self-interest according to their possessive individualist weltanschauung which orients around the ego as the be all and end all echoing the words of Richard Coudenhove von Kalergi "we will replace the nations of peoples with the nations of individuals".

The individuals seek their own interest alone naively subscribing to the false conception of individualism and disregarding the actual reality of biological reality which is the only real *de facto* basis for their individual survival: united we stand divided we fall.

The kosher nostra have kosher enforcers wearing the kosher badge that is called the badge of the 'police'-that which authorizes them to implement the 4th generational warfare protocols against the 'civilian' population and at the behest of their jewish masters who dictate the particular course of their actions. This is the way the jews ensure that they weed out any probable opposition to the jews' power that might potentially threaten their control system-they ensure that not only have they indoctrinated their slave class from the kindergarten to adulthood with egalitarian dogma but even antenatally through E.L.F (extra-low frequency energy fields) they have implanted certain thought forms and certain behaviors and predispositions into the consciousness into the very soul of the 'goyim'. This ensure loyalty to the individualistic-collectivistic credo that serves to tear out by the root any ethnic consciousness that might serve to unify the 'goyim' against themselves.

The jew employs his mind control system (religion-media-akadumbia) to condition his slaves to look upon anyone and indeed anything (ideology; mineral-vegetable-animal-human-higher dimensional being) as a threat to all and sundry, to 'society' and thus can the more easily employ his goyim slaves to sabotage via unconventional warfare tactics his enemies though in the end the jew is an enemy of all and thus would simply precipitate the destruction of all out of his megalomaniacal desire to absorb the world into himself as his personal morsel, a filet mignon served up by his goyim serf class. The filet mignon of 4th generational warfare is the 'enemy Other' of the jewish despotism upon which he feeds; feasting upon the bio-energy of his alleged allies and friends simultaneously in a cannibal feast of rapacious greed. The meat of the goyim is served up to him by his hunters-the police and military, kosher enforcers whose sole purpose in life is to rend the bloody scraps they hunt as the *conditio sine qua non* of their being (a power rush; the thrill of the kill of the dehumanized 'Other').

The scope of the warfare protocol extends beyond that of the official (officious) gendarmerie and into the amorphous mass of the population who are conscripted via what is called 'community policing' to precipitate (bring about) that which the jew hopes will flush out the foxes of the enemy 'Other' from their midst.

"Everyone is One" and thus each and all are conscripted into the ranks of the unofficial gendarmerie and deployed as an army against that which has been constructed as 'Other' to themselves though it may in reality be and typically is in the same biological group. Thus the divide and conquer tactic is employed "terrorists vs. law and order" and all of those the jew deems 'terrorists' are terrorists by virtue of the fact that the jewish priestly caste determined that this would be what is 'righteous', 'moral'; 'kosher certified'; 'godly', etc.

The rhetoric of the priestly caste hegemony is employed and the targeted individual is placed into the crosshairs to be set up for ritual murder by the cabal and its minions. This is warfare against the population, against the elements in it who are rebellious and who have no willingness to allow themselves to be done away with in a cowardly manner, to go along with that collectivistic despotism that impedes and/or subverts their capacity to exist their essence as a free man, as an autonomous being whose autonomy would under such a despotism be forfeited as a condition of their participation therein.

Collectivization and standardization of the hive mind of sub I.Q Bolshevik untermenschen; the protocols of the jew which styles itself: "peace, love and unity" and which is in reality only the conditions of resting in peace through civilizational collapse via the jewish system of entropy being imposed upon the world according to the inclination of jewry-a closed system of rigidified law (mosaic law; Noahide law) which chokes out all liberty and precipitates death as its final judgement.

The proper badge worn by the police (which would reveal their true nature under the jewish regime) is a six pointed star badge which says: "kosher", signifying their kosher approved right to kill and annihilate opposition to the system in any and all ways necessary or useful. The most effective means, as the protocols of "The Elders of Zion" say, lie in the conditioning of the peasants to spy on each other out of a sense of civic duty, a sense of moral virtue (ie. public approval or approval by the ruling power).

The citizens have a hive mind which is crafted by the craftsmen of Zion from kindergarten to graduate school and which has as its contents of consciousness emotionally based programming that is paired with the stimulus (and thus conjured up) of the enemy 'Other'. Every time a confrontation occurs between the goyim population and the 'Other' their inevitable reaction of hostility is conjured up as it were by black magic which indeed it is, the black magic of the elders of Zion.

The conditioning of the stupid masses is especially rigorous in the case of police and military training where only those who are vetted by the jews as useful servants are permitted to play a role in Zion as the iron heel enforcers-only the shabbos goy puppets who will target the kosher targets can wear the kosher seal of approval, the badge of the police and military. Trained in the state of israel by the mossad and the cabal's manipulative operatives, the kosher approved state killers are then released upon the 'population' to impose 'law and order', aka. the implementation of the noahide laws upon the 'goyim'.

Like everything in pantheism the war is pervasive and everlasting always like a donkey pulling the jewish peddler's cart chasing after the carrot of 'everlasting peace' as it crashes the gates of civilization and tears it down in Demiurgic force-the emanation of the jewish vampire Jehovah reigning upon a once peaceful world the fire and brimstone of the dirty desert. The war is on and the only side which is fighting is that of the jewish police state. Hence it has thus far been like shooting fish in a barrel for the jewish despots in their war everlasting.

'Cant' Stand The Jew

The jew uses rhetorical devices as one of the main modalities of his power and manipulation of others to achieve the purpose of:

- 1) ingratiating himself with them (being accepted by the 'Other') and
- 2) manipulating them to fulfill his goals as instruments thereof and
- 3) destroying them when he has decided that they have outlived their usefulness in his despotic plans for global dominion.

Thus 1) the jew employs rhetorical techniques, often called 'cant', clever wordplay and syntax and various other forms of language manipulation to appeal to the non-jew through making himself appear not as a threatening foreign presence bent upon takeover and slaughter but rather as a bosom companion who only harbors good intentions and mutual aid often using the tactic of transference to transfer the attention of the non-jewish 'Other' to an enemy of theirs or even a created enemy, a purely fictional construct ('witch'; 'nazi', etc.-see the section 'nazi narrative' for fuller analysis of this creation of a villain).

Upon achieving ingratiation into the society or company of the non-jew he then employs his dialectical language to mobilize the non-jew ("fight for 'god' and country"; "give to god"-tithes and taxes; citizen's duty to pay taxes; to go to war; to work 14 hours a day in a jewish controlled factory at the age of 8 years old, etc.).

He then divides and conquers the population through similar rhetoric and conditions different groups through repetition of weaponized words to attack one another then steps in and plants the victory flag of Zion on the bodies who have fallen upon one another's swords.

The cant of the jew operates on the basis of a pretense of good (salesmanship; making that which is unappealing appear appealing or simply concealing it) and a beguiling of the no-jews' mind through hypnotic techniques and prudent (for his general goals) selection of diction and syntax which creates that influence upon the mind of his mark or dupe.

Semitic Cruelty, Its Causes

The jew is: "The carrion fowl of humanity" (Napoleon); "The demon of human decadence" (Wagner); "The pestilential miasma from the East" (Robert Ley).

He is the predator parasite which insists on the vampirization of his host and their despoliation and ultimate ruination at his hands. What is it that drives his rapacious lust and bestial animosity towards the 'gentile', the non-jew and especially the aryan?

It is in the blood, or rather, the anti-blood of jewry to perform this role in the theatre of the real-a role he can never cast aside and must play. He is a bit player in the hollywood of the matrix of Zion, the arch villain, the diabolical presence and all of those actual hollywood stereotypes and those of the novels which preceded the "artwork of the future" (Wagner-that being t.v and movies) have all been cut from the same cloth, the tissue of the jewish soul-a chaotic, hybrid entity that must visit upon others its inner chaos. But why, what is the cause of this cause-of the fabric itself? Is it purely mixture of radically incompatible kinds, or are their other causes? This is an insoluble issue for those not possessed of clairvoyance and so we must simply stick with what we have by way of explanation in terms of "the nature of the beast"-that it is the conflicting inner structural essence of the jew which enable this behavior.

Those conceptions of the jewish type being a demon possessed or a 'satanic' being throughout the ages which have marked the jew (in many cases in the most literal sense with the judenhut or yellow star badge) can be validated through personal experience with jewish behavior and ontology (the 'being' of the jew-perpetually creating strife and for those of a more sensitive disposition, the feeling when in company with jews of a strange negative, vampiric quality-like that of the draining of one's life force through some mysterious influence).

The being of the jew can thus be described as not only vampiric but 'infernal' in the sense of having a harmful, low vibrational frequency that has the effect of destroying or degenerating the being of the gentile, the non-jew not only through energetic vampirism but through exerting a strange influence upon them that acts as a stressor and wears away their life force.

This perhaps is the basis of their cruelty-their vampire nature, which is the means through which they augment their own life force at the expense of others. Beyond this fact lies the conception derived in part from gnosticism of the archons and their being a predatorial parasitical influence on this planet. The jews, given their hybrid form (its chaotic nature) play host to these entities as they not only reflect in outer form the behavior these entities have been reported to undergo but they have historically been associated with such entities amongst the lowest and highest strata of the aryan societies they had invented as has been recorded in the quotations from such figures as Emperor Titus and Cicero as well as Luther and various popes; scholars and learned men seemingly without interruption everywhere they have ever been a presence. Such a legacy is not unfounded as anyone with adequate experience of jews can witness.

Thus it may be safely assumed as a hypothesis that those astral parasites, infernal archontic entities are bound up with the jews and that they presumably exert a motivational influence upon them such that they are incapable of behaving otherwise save perhaps through some form of exorcism. This having been tried time and again throughout history one must conclude that it is the structural essence of the jew which enables these entities to intertwine themselves with them and to utilize them as a vehicle in their inter-relations with other non-jewish and even non-bipedal entities (hence the cruelty to animals so frequently observed in all semites and the animals' becoming overall more aggressive in the case of the jews than in that of confrontation with aryan).

Thus the jew-semite-can be seen as a catalyst of the will on the earth plane of these entities and these entities, as the behavior of the jew bears witness to, are a vampiric and destructive. Presence on the earth. The jews perpetually delight in the torment of their 'gentile' hosts through countless means of torture (rack; stake; thumbscrews, etc.) and creation of bloody harvests-the harvest of souls for the jew to feast upon-in wars, revolutions; depression; bloody rites and crime all of which can be traced back to the jew as ultimate cause...and antecedently to that of these archontic entities who are presumably the *primum mobile* of the orchestra of chaos on this 'veil of tears', the mundane plane.

The cruelty of the semite he is only partly to blame for-the entities which are inextricably bound up with him based upon his genetical-spiritual essence are to blame also. However, it is not a question of apportioning blame, only understanding the causal mechanism involved and employing the necessary measures to eliminate them so that harmony may reign upon the earth and the matrix in which these entities and their physical vehicles operate in and seek to weave over the earth as a tissue of bonds that trap the higher aryan with his higher spiritual consciousness will finally be destroyed so that there will no longer remain upon the earth these savage creatures and their hybrid chaotic nature.

To describe further the reasons behind the cruelty of these creatures and the semites themselves: the goal towards which they are driven in their tense relationship of *quid pro quo* with their archontic masters is that of the vampirization of the energy of Others, specifically the aryan, as the highest and purest source of energy these beings seek to vampirize and attach to.

To create stress via imposing irritation and existentially threatening circumstances upon the aryan leads the average aryan to respond physiologically/energetically in a stressed out way such that energy is released and these entities and their jewish masters can thereby absorb the energy released -the entity motivating the jew and the jew allowing the entity to feed off them such that should the jew cease to create stress and trigger a reaction in the aryan the entities with whom he is involved would simply feed off his own energy field and this would shorten his life force thereby leading to his destruction in proportion to the extent and intensity of the archontic astral parasites feeding upon him.

Thus he is driven to create perpetual strife by both the entity who uses him as a vehicle and by himself who must take in healthier and more vital energy centers in order to perpetuate his life of usury and parasitism. Semitic cruelty is a function of the biological tissue of the jew manifesting itself as a weapon of predatory astral parasites in relations with non-jews especially arians as the highest and most intense source of energy-a target for the intended vampirization of the aryan.

The Fifth Caste

In the age of iron-the Kali Yuga-the situation of the world is a war of all against all. We are at the cusp of this world situation which will inevitably blow up in conflagration that will put the higher type (the men of quality, the aryan) against the lower-the chandal hordes led by the jewish oligarchy and their archontic masters.

This downward spiral of history through the cycles of time leads, as Julius Evola has written in his work "*Revolt Against the Modern World*" to a regression of castes or 'estates' from the first to the last as an organic degeneration: from the priestly caste (first estate) to the warrior nobility aristocracy (the second estate) to the merchant-bourgeois caste (third estate) to the fourth estate of the proletarian serfs. All these are modelled upon the caste system of Vedic India not as a purely 'human' invention but rather as an essential regression through incorporation of elements into itself that upset the balance of power and led to the weakening of the higher principles of an authentic Spiritual Tradition collapsing in on itself through that foreign viral influence (the 'pride' of those who put their ego before that which transcends their own finite consciousness).

In the Kali Yuga-the iron age or wolf age spoken of in the Edda (note the linguistic similarity to the 'Vedas') all are brought into a state of chaos in their being-are ontologically brought into the maelstrom of chaos which chaos followed from the antecedent conditions and merely culminated in a state of extreme disorganization in which a limit point is reached.

However there are proceedings from this larger collapse from which only the gods may arise victorious (those possessed of the Divine Spark, the aryaans who keep or at the least seek to recover their first estate). These proceedings are visible, tangible, around all who have a higher sensibility who are capable of perceiving the chaos which exists within the consciousness of those who are unable to transcend the conditions of the Kali Yuga where the gold of the gods has been transformed into the base metal of the debased chandala (the fourth estate) going into the age of lead as the fifth estate - the caste of the embodiment of violent chaos, microcosm of the macrocosm.

A perfect example of the fifth estate are the subhumans who participate in the so-called 'community policing' aka. gangstalking program that the terrorist police state of the jewish occupation government runs-they delight in manipulation, in lying, in the abuse of that which is deemed 'Other' by their self-appointed authority figures-this helps them to work up their inner demons as a rite of black magic.

In so doing they become possessed by those forces which have been largely responsible for the fall of civilization, the archontic entities who possess the jews' given the latter's genetical-demonic constitution (the jews possess the DNST-3 schizophrenia gene which enables possession, being a hybridized creature bound up with *homo neanderthalensis*).

Thus those members of the bottom of the cycles of time-the walking dead, the zombies of postmodernity, are indeed a receptacle for the forces of chaos, vehicles of the will of these entities and by virtue of their amorality/immorality, of their delight in harming others, in their lack of integrity they serve as a vehicle of these beings not having an adequate self-possession to exclude those entities from their being-to repel them, not being made of adequately strong force.

Hence the delight in evil ('evil' being defined as a willingness to harm others) and aversion to the good unless it conduces to a self satisfaction or low level stimulation of the nerves or the elicitation of a dopamine spike. They are indeed 'thrill seekers' living for thrills and having nothing beyond momentary self-seeking as their goal and purpose-"ashes to ashes and dust to dust".

Forsaking the higher for the lower (the Spirit for the lower ego and its attachment to all of that which is fleeting and earthbound) they have abandoned all principles, abandoned their higher principles for the momentary rush of power in their sadistic acts of dominance over and against the 'Other' who has been deemed anathema maranatha, 'fair game' in the witch hunt of postmodernity.

In being so deemed by the self appointed authorities, the gullible goyim without integrity or principle are unleashed from the bonds of moral sanction and, feeling thus liberated in their otherwise neurotic lives of inhibition through forced conformism, they have been given a chance to 'exorcise their demons'.

In doing so, in participating in the 'community policing' they have however simply opened up a window of opportunity in their soul for these entities to possess them and to further their agenda of the enslavement of the world through the elimination of those who their earthly emissaries the jews single out for targeting owing to the blood memory and higher consciousness of the targeted individual (person).

These 'individuals' comprise the leaden mass that is molded into a weapon (the hammer and sickle of Saturn) that the jews utilize to attack those whose very existence-ontologically- poses a threat to their oligarchic despotism as they had promised themselves in their 'holy books'.

To avoid being dragged down into the mire with the rest of the masses, losing one's soul to the archons as a drone robot slave in the cybernetic prison of Zion, one must strengthen his soul and repel all influences which conduce to its fragmentation-to become a spiritual warrior who merges the first and second estate (the priest caste and warrior aristocracy) within himself and push aside the lower elements that serve to drag him downwards into the hells of Zion through over attachment to one's ego such as in the case of the bourgeois-merchant class their hyper-rational egocentrism (best exemplified in freemasonic luciferianism) and the gutter behavior of the proletariat based purely on bread alone and an animal life devoid of True Spirituality (eat-sleep-fornicate-propagate).

To avoid the lead casket of beast consciousness making of life a cadaver bereft of Spirit and allowing oneself to be taken possession of by the vampires of Zion losing their soul, one must detach oneself from all attachments to all sensationalism-immanent transcendence is the path.

Those who, through their own inner weakness have had the misfortune to pursue temporal at the expense of Spiritual power through becoming accomplices of the terrorism of Zion in gangstalking, have shackled themselves to the archons and their system of slavery.

Collectivist Despotism: Microcosm And Macrocosm

The jewish occupied governments of what have been termed 'Western Civilization' are *de facto* oriental satraps, oriental despotisms run by an oligarchy of jews and their underlings, at this time those of the founding race, the ethnic european/aryans in their freemason lodges.

The shabbos goyim ('stupid animals' in yiddish referring to the useful idiots jews exploit to harm their own people) are the defenders of jewry who enable their masters to enforce their despotism.

In all historical despotisms where jews have ruled either behind a ruler puppeted through themselves as rulers (crypto or overt) they have transformed the society they have come to infest into a closed system of control with themselves as an aggregated rulership oligarchy, a *de facto* nobility (ignobility) who ruthlessly exploits the peasants through taxation and coerced slavery or work.

This is the case today with the imposition of the income tax which was instituted on the pretext of funding the war effort for the first world war and was allowed to remain without discussion or debate ever since that point.

It is the modern form of tithing, just as tithing is the medieval form of taxation (this in addition to all correlative costs levied against the slave caste-note the term 'levy' which is cognate to 'levite' as in the Levite priest caste).

This system of exploitation is enforced by the jewish oligarchs through a police state which is installed once the jews have sufficient power to do so typically through convincing the shabbos goy elite that it is within their interest to have as their personal bodyguard and tool to ensure the peasant serf caste pays their property taxes and 'correlative fees' to keep the parasite oligarchy positioned in their state of superiority.

Beyond this however, what applies are purely mundane considerations of money (which is the abstract representation of human energy, 'a claim on work done', the receipt of something paid to the jewish elite, namely labor in exchange for nothing-fiat currency, a mere 'promisory note'). There is also an occult dimension: the coercion of the populace as a receptacle of bioenergy to release their energy in the form of louche so that the archons which are bound up with the jews and the jews and masons themselves may feed upon this energy which is released through hardship and travail ('travail' being 'work' in French).

Thus all are rendered human batteries to be vampirized by the dark forces. To further have the slave caste, receptacle of energy that they are, release their life force to augment the vampires of Zion, stress and fear, anxiety and unease are imposed upon the slave caste and this through the particular protocol of the witch hunt known in contemporary euphemistic language as 'community policing' and the targeting of members of the community the oligarchy seeks to harm (especially those who are capable of threatening their tyranny-the aryan noble blood lines).

To harass and abuse others in the protocol of mob stalking or gangstalking (a more appropriate term for 'community policing') is to cause the target to release energy thereby empowering the vampiric oligarchy.

Beyond this it is a means of understanding through classical conditioning, so-called 'scientific observation' how the slave class and especially members capable of escaping the net of the Zion matrix through having a higher consciousness and discovering holes in the net, thinks and behaves as a means of closing off all exit points and strengthening the net to bind all into 'Oneness' as a receptacle of soul food (bioenergy) to continue to feed the beasts who rule over the slave system and their controllers the archons.

The Organic Lie

The jews, emissaries of darkness, have historically been known as the 'organic lie' the embodiment of mendacity which their fruits have made plain to all who come to know them. The inner is the outer and the outer is the inner-the behavior of the jew is always against harmony and represents itself as harmonious-it is always a simulacrum, a fake-an appearance that serves to conceal the real motive and real harm visited upon others.

The actions of the jew are an extrapolation of their inner being-their inner being is a mongrelized amalgam of disparate and conflictual genetics presumably tied together through infernal forces as a 'chaotic bundle of drives'.

The Truth, that which is (Being or Reality) is an organically developed substance which develops itself through itself and thus has nothing in itself non-essential but all is an integral part of a whole thus making it 'organic' in both the sense of 'self-development' and in that of a complex of elements working harmoniously with one another in the sustaining of the organism-to whatever extent that organism in question can sustain itself given its weak links or built in design flaws.

The jew however is a product of artificial engineering, which is to say the embodiment of the 'original sin' of mongrelization-a combination or mixture of elements which are not self-supportive in themselves but which are conflictual by virtue of their qualitatively different structures or essences.

This means that they are not in harmonious resonance with Being/Reality and thus are not a bearer of 'the ring of Truth', are not able to hear its mellifluous sonorousness but rather create a cacophony in a nation.

Truth is harmony, the articulation either in language or ontologically of organic substances which are mutually self-supportive even if conflictual (such as in the case of predator and prey-the predators consume the prey which reduces the latter's numbers, paradoxically enabling them to exist else they would overpopulate their territory and die of starvation or disease).

The lie (ontological lie) is that which exists and yet creates chaos not only for others but for itself and brings about its own destruction through its existing its essence. There is no agreement (correspondence between the organic lie and Being and other organisms) and thus no Truth in the existence of such beings whose being is the incarnation of chaos.

Thus it follows from the premises that no jew of any kind may exist harmoniously in the midst of other beings. The behavior of the jew is vampiric and parasitical, it is predatory and all beings (organisms) are their prey as they constitute harmonious organisms (to the extent they are not themselves like the jew the embodiment of chaos) as they are sources of bioenergy the jew seeks to harness, to vampirize their target's energy for themselves.

To live in the Truth one must live amongst the forms which exist organically (are self-developing and which resonate harmoniously with other beings). To live against Truth one must, like the jew, involve themselves in relations which support greater chaos within one's sphere of influence which simply rebounds upon oneself as a karmic backlash.

'The Truth will out' as they say and the organic lie will eventually be exposed as the harbinger of chaos on this earth. The organic lie is defeated by the Truth which is Being/Reality, which many call 'God' in its manifestation: "Let there be light", to banish the darkness of the organic lie.

Perhaps this is why the jew is forever seeking to generate inorganic beings or structures on the earth? They are a product of his own inorganic nature, are themselves a 'lie', which is why the jew through existing his essence on the earth generates more lies and chaos on the earth in the form of his technocracy or rather techno-crazy and his transhumanist agenda-he would create a world in his own image and sabotage the images of 'God', the organic beings in their being/essence-distort; pervert; contaminate that which is pure as a means of imposing his being upon Being, a demiurgic overlay upon the realm of eternal forms. As a de facto 'fly in the ointment' of life the jew simply can't help himself-in order for him to exist his essence he must needs attempt to render the natural (Being/Truth) artificial (simulacral/false).

The solution to the organic lie is the Truth and this is the light which exposes the darkness and its creeping influence, the malevolent spread of its attempted usurpation of the Truth and the light by falsehood and darkness.

No Jewish Targets

In the gangstalking psyops that the cabal orchestrates as controlled opposition to its terroristic campaign nearly all of them are represented as having a jewish or non-aryan leader and/or christians, specifically females. This inverts the reality: which is a jewish terror campaign against aryan people specifically and this of noble, aryan blood especially as they represent the greatest threat to the jewish tyranny being of a higher consciousness and can understand the causal mechanisms and motivations of the jewish oligarchy.

The reality is a deliberate targeting of those who are:

- 1) not jewish;
- 2) of aryan bloodlines, specifically blonde haired blue eyed people;
- 3) not non-aryan and
- 4) those who are dissidents or whistle blowers (presumably over 90% of whom are aryan, who have an innate sense of Justice and Truth-of the preservation of the harmony of existence).

In the jewish gangstalking media psyops (websites; organizations; figures, etc.) it is only the non-aryans and aryan christians who are given representation. This enables them to portray the villain as the aryan and themselves (the true villain and perpetrators) as victims, attempting to transfer their sin onto the aryan scapegoat.

Presumably the vilification protocol of the jew works to establish conditions for the intended genocide agenda: a crucifixion of the aryan on the cross of their own iniquity-portraying arians as 'satanic'; criminal; 'neo-nazi', as means of demonizing/vilifying and setting up for slaughter their opponent who they wish to destroy through the agency of their non-aryan hordes hiding behind the constructed facade of victimhood, the 'persecuted' innocent, in reality the archvillain of history and embodiment of the lie (which constructed the false 'history' they use as a sword and a shield to orchestrate their ends).

It is also a fair presumption that, since the jews are behind the gangstalking protocol themselves they are almost certainly never targeted by their own cabal but as usual hide behind the mask of suffering victimhood which plays to their ego and elicits sympathy for them by the gullible 'goyim'.

The Perp Complex

The psychological profile of the perpetrator (or 'perp') of the gangstalker, is that of the 'infrahuman'. Their consciousness being rooted in the base drives of sexuality or desire manifesting itself in perverse forms and means of affirming the lower ego and deriving a sense of power, accruing to themselves a sense of vitality and of stimulation of the lowest depths of consciousness, that which dwells within the infrahuman dimensions of their psyche and works up those propensities of consciousness towards materialism and sensationalism.

The 'perp complex' may be characterized as encompassing the following conditions or sub-complexes: sado-masochism; malignant narcissism and a generalized psychopathy, all of which are features of their living life rooted in the base drives.

This profile applies to all of the gangstalking perpetrators at all levels regardless of degree and participation in the terrorist campaign (regardless of their degree of knowledge of its end goals or operations).

With regards to sadomasochism, the act of willfully harming an 'Other' (the target) elicits a quasi-sexual thrill of a sadomasochistic nature-the perp feels pleasure in imposing conditions of pain upon the target and delights in harming the 'Other'. The danger of retaliation lends a sexual thrill (the thrill of being 'caught' by the target and the implied risk to self protection and safety that entails sex/death correlation) and the correlation between the imposition of power over another (the act of dominance) and that same sexual rush is embodied in the set of relations between perp, target and the act and its consequences-the act of dominating the 'Other' as means of obtaining sensual gratification through fulfilling one's desire or simply working up ones desires through the act of domination of the 'Other'.

This perverse ur-state of consciousness which the perp seeks as in many cases of continual pursuit of addiction (sexual addiction), is rooted in that egocentric desire to feel and to desire itself-to desire sensation and gratification through an assertion of the ego in an act of vital exertion (the act of dominance).

This is narcissism in the mode in which it manifests as a self-reflexive positing of the ego, the 'I' over and against the 'Other' in a master-slave relationship in which one seeks mastery (one who is a narcissist and the mode of manifestation of narcissistic thrill-seeking and ego-gratification is malignant in that it harms or willfully harms the 'Other'-whether the 'Other' is harmed *de facto* or not is irrelevant, its "the thought that counts", the intention of the malignant narcissist.)

Psychopathy is tightly correlated with this sub category of the 'perp complex'-a lack of empathy/sympathy for the 'Other' through a failure to identify oneself in the 'Other' and to recognize the being of the 'Other' in their being; in other word's a nihilation of the 'Other's' being through callous disregard for them, failure or refusal to posit them as a being endowed with any conscious life or existence and on that basis a relating to them as a mere 'object', a 'rat in a cage' that they may impose cruel and unusual punishment against with complete disregard of their suffering.

The perp complex is thus three fold and is based upon a ferality of lower egoic consciousness-(beast consciousness) which is the defining trait of the barbarous creatures who participate in the harassment campaign.

The degree of involvement as aforesaid is irrelevant-the very notion of deliberately and willfully harassing and abusing an Other in a surreptitious and covert manner is deceitful, female in its nature (the dark feminine, feminine consciousness in its most subterranean and debased form).

It is mendacious as it-the actions of the perps-are carried out behind the appearance of normality and manifest in a secret way that is known by the perp to be known by the target. This dark feminine aspect of consciousness is the form in which the perps habitual behavior reveals itself "for those who have eyes to see" and their malignancy; their narcissism; their psychopathic delight in harming another (shaudenfreude), their sadomasochism all testify to their perverse desire for power. This desire not only is motivated by their own lack of cultivation spiritually (a cultivated person would never participate in such an action-those who are aryan that is to say) but presumably by the dark forces which feed off the pain and death energy of the pure.

The perps, by gradual degrees of initiation into the dark side become who they are and through the subtle manipulation of the black magician adepts on the material plane-the cabal vampires-are converted into them should they be deemed 'worthy' rather like the ring wraiths in Tolkein's "The Lord of the Rings".

They are indeed-as one can observe in their appearance-that of an evil zombie -not fully in control of all of their faculties, as it were possessed, and thus are mere husks of subhumanity and this to varying degrees-the higher up they are in the hierarchy of the cabal (based upon their corruptibility; their fallible nature) the more empty and devoid of personality they are-a sure sign of possession. Their hostile malignancy further underscores their sick minds, or rather the fact that they have no mind but are merely possessed and displaced by the minds or Mind of another an 'Other') who utilizes them as an instrument on the mundane plane.

Signed In Blood

The scum of the jewish occupation government have made a deal with the devil in order to obtain for themselves temporary advantages. The members of what is called 'community policing' have demonstrated their loyalty to evil in signing onto a pact with the devil, the jew, who controls the slave population of Zion and chains all to himself as the usurious murderer and slaver of the world and all of its population.

Those who do not know the jew controls the world have at least some excuse to exempt themselves from blame for their slavery, though they nevertheless participate in the harassment and abuse of individuals and thus incur their karma and their justified fate.

The deal with the devil is made between goyim and jews for the long term advantage (and in most cases short term advantage) of jewry who ultimately robs the wealth they had conferred upon those they conscript as tools in their conspiracy assuming society lasts long enough to enable them to perpetuate itself with them on the top of the heap of subhuman untermenschen.

To sign a thieves pact with the jewish devil is to sign away one's life-either this or the lives of their children who have their future destroyed through the spiteful nature of the jew who turns the knife on all of those who so foolishly serve them, blinded as they are by their own greed.

To enter into a pact with the jew is to compromise one's integrity as the jews' contracts always entail a compromise of one's purity, a falsifying of his essence. Binding himself to those contracts entailing conditions that are of an onerous nature that binds him to the jew (though these contractual conditions are written in small print that most, being blinded by their greed and momentary self-interest), refuse to perceive, but simply 'take it on faith' from their jewish master that all is 'kosher'. They assume that this contract does not entail any necessity for performance of vicious acts or omissions that serve the interests of the jews and lead to the defilement of the 'aryan race', its loss in some form or fashion and ultimately to harm the agent of their own action.

Such is the fate deserved by the race traitor who seeks the death of their own people as a collective or innocent parties thereof and this for some petty self-interest or satisfaction, the satiation for the desire for power through a sadistic imposition upon the targeted person of their will according to their jewish masters dictates. They, the race traitor of whatever socio-economic class serves the jews in their thieves' pact, assaulting their own people and causing harm to themselves indirectly (given that what harms their own kind harms themselves ultimately as 'no man is an island entire unto himself').

Those who serve their own executioners bring about their own execution-it is that simple, and the example of the fate of all freemasons in soviet Russia being executed testifies to the inevitable end result of service to the jew, enemy of 'humanity' and destroyer of worlds. To involve oneself in a *contractus diabolus* with jewry is to bring about one's inevitable fate of extinction. Those race traitors who are recorded as having served jewry in their diabolical plans should be, and it is the expressed wish of the writer that they will be, brought into the public square for execution by the loyalists who have loyalty to their own people and who act according to the Divine Will in the perpetuation of their own kind against all odds.

Swarm Of Vermin

The gangstalking protocol of the jew world order operates in a manner very characteristic of jews, that being as a bestial swarming of an enemy. The myriad minions the jews conscript to carry out their dirty work as soviet spies and sadistic abusers of others of their targets can be likened to a group of animals who swarm another animal, eg. a collective of rats leaping upon a small dog or cat who they percieve as a violator of their territory or who they seek to eliminate and to occupy its territory or take its resources.

The ferality of such 'people' strips them of their humanity and qualifies them as 'goyim' by definition according to the jews' terminology, the 'cattle' or animals. The behavior suggests further a possibility of possession by whatever entities with whom jews are involved in their thieves pact and at the very least a zombification of the mind through whatever form of mind control (psychotronics; chemical-electrical labotomy; general dumbing down of the population).

The crude masses are malleable putty in the hands of the jews and play the role of their legions of slaves in the torment and harassment of the exception to the rule, those who jews have no tolerance for as a potential trouble source in their protocols of global dominion.

The zombie hordes are subject to the greatest possible influence of dumbing down and programmed in the process to love and hate certain particular things (person; places; ideas, etc.) and to act in a passive/accepting or aggressive/hostile manner towards them via the mind control of the media and akadumbia and the tax exempt kosher approved churches. The latter presumably enable the possession of the zombie masses in conjunction with an overall weakening of their genetico-spiritual constitution.

The biocomputer brain-mind of the population is routinely programmed via classical conditioning in these institutions and, via these organs of information spread to a completely reactive minded goy easily conditioned to attack whatever target the jew places before them. All that is needed is for the jew to create chaos and impose it upon others, blaming others for what they do as means of ducking a karmic backlash against themselves.

The zombie-herd psychology is the mass mind in its operations which mass mind has been engineered by the jews via the organs of information not individually alone but as a collective, creating a collectivized hive mind of 'spiritual isreal' which serves to mobilize the masses as so many puppets on the electromagnetic strings of jewry. Presumably they are controlled both individually and collectively by entities and/or a singular entity possibly from Saturn and they are thus merely instruments or robots of these entities on the earth.

The entities one may fairly speculate are the true controllers and dictators of this planets' affairs and work through their principle instruments the jews to engineer this hive mind, to create a matricized prison in which all inside know nothing of any 'inside' or 'outside' but simply exist as a passive cipher of whatever information flow is planted in their consciousness. The swarm or herd of zombified robots is mobilized to attack any who is not a drone in the beehive-anyone having any quality 'Other' to society or to the 'mass' will be targeted and persecuted as an 'enemy' of the nation. The zombified masses have been dumbed down to such an extent that they are in reality nothing more than a physical organism with a captive soul which is controlled by jewry and their entities form above. Those who are exceptions to this rule are able to transcend the programming of their mind by the technologies and engrams or thought forms that are projected upon them as so many missiles of illusion hurled at them by the enemy. Most are unable to circumvent the harassment and thus become a mere 'cipher' of the information flow, the waves of the evil tide of the Demiurge and are thus rendered animalized, goyim.

No Touch Torture

The tactic utilized in gangstalking of 'no touch torture' is a symptom of the dark feminine consciousness of the cabal and its minions who bathe in the false light of the unenlightened black magicians who engineer the Zion matrix.

It is reminiscent in its motivation of the behavior of a schoolyard girl who lays traps for her rivals, such as the placement of a thumbtack on a chair or who gangs up against a target with a coterie of others (the very essence of bullying and the sadistic delight the perpetrators derive from their actions).

The gangstalker is a schoolgirl who seeks to torment the better looking and more intelligent blonde haired and blue eyed girl (the aryan) out of a jealous hatred for their superior qualities which they seek to defile as means of overcompensating for their own deficiencies, similar to that which the witch in snow aryan and the seven dwarves did, smashing the mirror which reveals the image of snow white as 'the fairest of them all'.

The behavior of the gangstalking perpetrators is that of the schoolgirl-(typically the jewish schoolgirl) who wrangles with jealousy at the sight of the blonde beauty who she seeks to tear down and destroy, typically conscripting easily manipulable dupes into her game of manipulation (the lower level gangstalkers being the adult analog, the jewish mastermind being she/he who stands above and incites the minions to carry out his/her protocols which consist of imposing harm and abuse upon the 'Other' as a means of eliciting a sense of power as the agent of the harm caused). Again the sex-death correlation appears in the act of no touch torture-the delight in being the causal instrument of harm visited upon the 'Other', the targeted individual.

The fact that the torture is carried out in a way concealed and in a way 'plausibly deniable' is not only how it is carried out successfully within the context of the dishonorable communitarian society but how it is performed as a mechanism of delighting in the act of terroristic violence-the perpetrators being able to attack their targets behind a veil of non-being or occlusion of themselves, having the power to warp and change reality and to impose their own simulacral reality on top deceiving all but the target who alone is made aware of what is being done.

This further relates to the double bind of jewish black magic wherein the target is subject to the power relations of the jew and his underlings and is given the illusion of choice: to oppose what is being done to them and yet in reality having viable, practical options taken from them by the system as it is established by the jew. This creating a 'damned if you do damned if you don't' scenario wherein, should the target take any action they will be the ones portrayed as criminals for acting outside of the bounds of the system's laws which restrict their ability to defend themselves to a state of will-less inertia-the negation of all agency. Should they attempt to invoke the law in their defense they will have punitive psychiatry imposed upon them and be construed as 'mentally ill' for revealing what is being done to them, given a false diagnosis of having 'paranoid delusions' or something reminiscent thereof.

The no touch torture is the sadistic behavior of a school girl in her harassment of a rival as means of situating herself on the throne or pedestal occupied by her betters. The delight acquired in the act of torture that the perps derive is based upon their inability to supercede lower-egoic consciousness, the crude positing of the 'I' in front of all.

The act of torture is a stimulus that triggers a self-reflexive positing of the 'I' as a causal agent, concomitant self-regard and correlative physiological states (eg. dopamine secretion; activation of pleasure centers in the brain, etc.). It is the behavior of the psychopath whose consciousness is exclusively egocentric and can't ascend to any higher level or dimension of being beyond that of the restrictive sphere of the lower self, one who dwells within the physical and lower astral realms of sensation and motion.

Those unable to transcend this coarse state of being (that of a clever ape-intellect plus emotion governed by feral drives) are ripe candidates for the gangstalking program and those involved whose numbers grow tumescently by the day are invariably of this type, what may be characterised as a 'spiritual jew' (an oxymoron as no jew is spiritual by definition). They are an intellectual ape at best (or worst) and are motivated by base drives rooted in the lower ego.

The fact that these operations are carried out clandestinely as means of not leaving mark are not purely undergone as a liability waiver but out of cowardice, a desire not to have any retaliation brought against oneself, a weakness which must needs conceal itself behind barriers of secrecy and as it were dart out from the shadows with a poisoned dagger-or better yet shoot people through the walls of their residence with a microwave weapon or poison their food, clothes or water supply.

Beyond this, cowardice and as an emanation of this cowardice a perverse delight in sadism ('cowards are always cruel' as the maxim goes). Again the correlation between death (violence, the violation of the 'Other' in his 'Otherness') and sex (the delight had in this act) is visible, all rooted in the lower ego and perhaps in that which is sub-egoic or infra-human, below the human consciousness even in its lowest aspects, what might properly be called 'beast consciousness', the so-called 'Id' of the jewish inventor of the discipline of psychology and of psychoanalysis Freud. The gangstalkers are 'Id-I- Its' in the sense of their identity being Id-ic or Id-centric, derived from and rooted in the feral drives.

This is the anti-spirituality of modernity manifesting itself in yet another one of its forms, of an upsurge of the infernal into the human level of being-all passion, emotion, stimulation, sensationalism-all that thrills and depends upon the provocation of worldly *sensa* or phenomena conducing to noumena which are of 'hell', of the lowest states of existence, or which don't exceed the lower astral plane.

Such a recipe is one of self-destruction and so the paradox exists: to immerse oneself in the ego, the lower self, riding the dopamine roller coaster (of self-stimulation) leads downwards towards the need of an ever increasing stimulus to have it register in consciousness which in turn lowers the consciousness and leads to its decomposition (*zersetzung*).

The paraodox lies in the fallibility of the ego when it bases itself upon itself and nothing higher. It leads to its destruction through, like flechettes from a hand grenade, being ruptured by the hellfire of infernal noumena that are almost certainly accompanied by the lower astral entities who consume the soul and with whom the jews are bound.

The gangstalkers destroy themselves through attempting to destroy others-live by the gun die by the gun. The salvation of the soul lies with the target as the very act of participation in the gangstalking leads one down the path of self destruction ('decomposition'-*zersetzung*) whereas the target has the choice to cultivate the higher Self and to avoid the pitfalls of their own voluntary destruction as the inevitable outcome of their practice in sadistically riding the dopamine roller coaster to hell.

'No touch torture' is the perpetrator of evil's attempts to 'cheat God' by operating *sub rosa* and with kosher approval-within the bounds of the 'laws' of man, of the jewish de-men oligarch vampires who enslave the world in their matrix system of lies and half truths. However they can't cheat Divine Authority with the merely temporal power of a pseudo-authority which is merely self-legitimizing as having no authority from Above (from cosmos) just below (chaos; hell; the lower astral entities which control them).

They would blind themselves to their 'sins' on the premise of the jewish comedian Jason Alexander in his role of 'George' on the show 'Seinfeld': "Its' not a lie if you believe it"-however it is a lie even to the 'organic lie' of the anti-race of jewry-they are just not able to perceive Truth in its fullness but only from a subterranean perspective.

Nonetheless they understand they are lying and no amount of concealment of the Truth will exonerate them from that act of concealment whose deliberate performance attaches to themselves karma for their deed, gone about willfully and with malice aforethought. Doing evil in darkness does not shroud the act which is laid bare by the light of Truth understood by those who are of sufficiently developed consciousness, who are amenable to Truth and who comprise the main target in the cross hairs of jewry as they who are able to expose the evil of jewry.

The harm visited upon targets, though undergone without any physical contact and over lengthy duration (in many cases from birth) being designed to abuse and elicit pain prolonged over the course of the person's targeting is more traumatic and harmful than physical assault and thus is a greater 'sin'; 'karmam'; 'crime' than the mere act of physical assault which is fleeting and momentary (though it must be acknowledged that eg. noise campaigns are 'physical' in the sense of vibratory and thus a sonic assault amounts to a physical assault only of a more subtle nature).

That the harm is designed to assail the target's very soul and to destroy by slow degrees their soul is a symbol of the cowardice, cruelty and barbarity of the perpetrators who are worse in their acts of violence than any murderer or criminal in the jails of the jewish matrix. Accordingly what attaches to the gangstalker is extreme karma and a reciprocation of their harm at a soul level which degrades and erodes the integrity of their souls opening them up to increased possession and control by the dark forces who dispossess them and consume them vampirically.

Most of the perpetrators are already dead-they just don't know it if they ever will as their epistemological state is that of non-being, not ignorance as that would imply the agency to ignore reality but rather 'a-gnosia', the total privation of knowledge as the total privation of the faculties of knowing through subjecting themselves to the vampirization of their soul by the vampires of Zion (archons; asuras; reptilians-call them what you will). The 'no touch torture' relies on the concealment of phenomena and the presence of harmful noumena which are as flechettes of a demonic munition which negates the soul in its fundamental structure.

Gaming The Jew, Gaming You

The modality of jewish consciousness is that of what Max Heindel called "Atlantean Cunning", the jews having been slaves in Atlantis according to the Rosicrucian author. They possess the consciousness of beastman, the inheritance of the untermenschen, the anthropoid non-aryan with whom the aryan intermixed to varying degrees millenia ago which brought about the loss of their first estate, the higher consciousness of the aryan.

The jew has inherited this cunning and like all non-aryans his consciousness is structured on the basis of this cunning which is a lower egoic mode of mind (lower 'manas' in the theosophical sense).

He thus is perpetually seeking to assess his marks or dupes as means of exploiting them for his own ends in the manner of a common criminal or street pimp (read the book "*The Jew as Criminal*" by Karl Kellner and Hans Anderson for concrete examples of jewish criminality).

The criminal is in most aryan societies and even in most non-aryan societies the embodiment of lower egoic self-seeking at the expense of the society and its rulership who make the laws. The jew is a criminal on this basis-that his mind is lower-egoic and rooted in the base drives of fight-flight-fornicate and propagate-the accumulation/derivation of benefit with the least effort to the greatest degree at the expense of those not of his tribe (his tribe being an extrapolation of his lower ego).

As it relates to the targeting of marks and dupes in the context of gangstalking the jew's cunning is employed in the assessment of the 'Other' through a circumspect, instinctive grasping via a lower level conscious intuition that enables the jew to gather data on the mark and to base subsequent decisions related to the mark on that data set.

The jew 'games' his mark through entering into relations with his mark hoping (with the expectation of) the elicitation of certain forms of reaction that the jew can synthesize into a profile of the non-jewish 'Other' and attempt to come to an understanding of how the 'Other' behaves and on that basis how to manipulate the 'Other' in order to cause maximal harm while deriving maximal benefit for himself and his tribe as a collective group as means of advancing his protocols for global dominion. For the jew it is a 'game' of actions and reactions, of feints and power plays between himself and the 'Other' in a set of antagonistic relations that serve this end.

The jew is willing to take a step back and make concessions of power if the larger objective is approached through this round-a-bout way creating, the appearance of altruistic 'Other' regard as a means of stabbing the 'Other' in the back while the jew embraces him.

The gangstalking protocol for the mapping of the target's consciousness through advanced technology (remote neural monitoring and manipulation) relies on this game theoretic manipulation of the jew-a deliberate initiation of a sequence of actions and reactions that enables the jew to understand the slightest signs or expression of meaning based on facial expression; patterns of movement; pursuit or avoidance of certain cultural forms; certain thought patterns and in general modalities of existence that the jew wishes to obtain full comprehension of as a mechanism of the enslavement of his charges- and beyond this the traumatization and torture of his targets.

The employment of the advanced technology of synthetic telepathy and electronic/energy weapons to impose certain sensations or assaults against the 'Other' is the crowning achievement of this 'architecture of control' which has spanned millenia of abuse and harm towards the 'Other'.

The game of the jew is a chessgame of light versus darkness and the outcome is death or survival in the physical and spiritual planes. In the ancient world cruder physical technology was utilized but also more sophisticated in the form of magic-the actual employment of forces to manipulate the conscious mind inducing fear; pain; lust and the entirety of the seven deadly sins and their stain upon the soul through participation in them by the target.

Whether the target is responsive or not is precisely what the jew and their affiliates seek to determine as means of initiating further and typically proportionally subtle and intense forms of temptation or stimulation so that the target facilitates via participation their own destruction, allowing the game to continue to the jews advantage.

However the game must be played as failure to do so is to forfeit and give the jew the victory bringing about one's own destruction through failing to counter the moves of the jew. The jew seeks to harm the aryan who is typically his target and it is the duty of the aryan to subjugate the harm the jew seeks to impose upon him within the bounds of Cosmic law, straying outside of these bounds amounting to concealing victory to the jew to whatever degree or in whatever particular case and his archon overlords and minions are all on the darkside and seek to visit harm on their foe in the way most efficacious for their goals, those being whatever conduces to the establishment of absolute rule by the jews and their puppets under them.

The contents of consciousness of the aryan the jew seeks to know and infer through his technologies of control be they the soft technologies of the so-called mental health pseudo-sciences or through the hard technologies of directed energy devices (electroencephalograms; voice-to-skull E.L.F devices; radio frequency generators, etc.) and various more mundane and crude techniques (N.L.P hypnosis sensitization; honey trap enticement, etc.).

It is the duty of the aryan to not only counter these technologies but to subjugate them as well as this effectively liberates him and others from the mind control of the jew and the jew's utilization of these technologies as instruments of black magic brought against the aryan race and indeed against all sentient life on earth: mineral; vegetable; animal and anthropoid and whatever higher dimensional beings he harms.

The game of the jew is inevitable and one must play it ot the end. There is no use praying to the jewish god for salvation, one must save one's own soul by becoming an adept in playing the game.

Failure to do so is to hand the victory to the dark side and sacrifice the light of the aryan for the sake of momentary feelings and emotions. Thus one must not only cultivate a higher consciousness through the proper forms of meditation (such as third eye power meditations) but he must live for a higher purpose than egotistical self-stimulation and hypocritical altruism towards non-aryans. The game is for keeps- the keeping of one's soul or its forfeiture to the dark side.

Jewish Gangstalking, Jewish Paranoia

The *modus operandi* of the jew when exposed in their evil plans is to preemptively strike against others ("accuse the accuser") and to attempt to ruthlessly go after those who they deem their enemies and indeed that encompasses anyone having the power to do them harm though the enemy 'Other' the jew targets might have no intention to harm the jew at all.

It is the profound insanity of the jew combined with his megalomaniacal egotism that he directs against those he calculates could pose a threat to his hegemony over the earth. Thus he embarks upon a preemptive strike as means of attempting to curtail any potential threat to his power though it be derived from the most insignificant source imaginable, even the lowliest vagrant constituting a threat to the jews power should he ever find out about the jew and his activities as he might reveal this to others who would somehow threaten jewry.

Such is the climate of paranoid suspicion and neurotic micromanagement borne of the jew's paranoid mind and encoded in his mosaic law and talmudic rabbinical scrawl that enchains his consciousness within the confines of his cultures' prison. Of course his 'culture' is mainly an epiphenomenon of his mind and its externalization and could not be anything other than what it is and thus the jew is unamenable to change, a rigid, inflexible unit that must needs carry out its laws for despotic control over the earth should the aryan race-his only threat- seek the exposure of himself and his plans, discovering the existence of the wizard behind the curtain of illusion the jew creates to bamboozle and use, confuse and abuse the aryan race, nature's finest.

The jew thus understands that the only threat to his survival is the aryan race and that it is they and they alone who must be exterminated for his plans to fructify and bear thenceforth the poison fruit of Zion over the earth. The paranoid fear of the jew is that the aryan race might one day find out about what he is doing and seek to work against it incites the jew to perpetually spy on and monitor all aryan as they are his only opposition to global hegemony.

As in the cartoon 'Heman', the blue-eyed blonde haired aryan aryan virya, the Hero, who has correctly aligned chakras symbolized by the equal armed cross, resides in Eternia and alone being immortal can escape the realm of illusion wherein the jew (Skeletor) and his beastmen slaves dwell.

The paranoid jew employs the technique of placing under surveillance his slaves, his aryan would-be slaves being those subjected to the greatest scrutiny in the jews' panopticon open air prison. The eye of Sauron as depicted in Tolkein's "The Lord of the Rings", is the eye of the jewish 'god', the dark lord which is the collective of dark forces, dark energy matter entities who work to enslave the people of planet earth (Gaia, Gerda) and this through a micromanagement of the population as stated giving hyper-focus upon aryan as the greatest threat.

The recent installation of the 5G control grid is one such mechanism of control as is the popularization of smart phones and watches as means of tracking and a monitoring people's every move so that the jews can feel 'safe and secure' in their state of paranoid fear and as in the state of israel (Mordor), they can observe the every move of the non-jews, who they designate as 'goyim' (animals, cattle).

Thereby they live a life of leisure at the expense of the goyim and vampirize their bio-electric energy through subjecting them to work slavery and self-destructive lifestyle practices such as alcoholism and drug use which further drains away their energy releasing it for the dark forces to vampirize.

The habitual practice of gangstalking is at this time still employed by the jews as means of monitoring the non-jews as their control apparatus has not as yet become 'fully operational' as was the case of the death star in the Star Wars franchise, another kike revelation of the method by the jewish director George Lucas. The actual physical in real life surveillance of non-jews especially aryan is a yet ongoing and common, pervasive phenomenon.

The jews of all areas have spread themselves over the ends of the earth and embedded themselves amongst their aryan and non-aryan hosts working as a network, an invading army doing reconnaissance and sabotage operations on the host enemy 'Other'. They act as in a state of war amongst the oblivious host as they are indeed waging a war on their host while they simultaneously play up to them and exploit them for profit the better to work in their clandestine way, for if they were to work openly they would be slaughtered or at the very least deported and thus lose their ability to parasitize their host.

They act as a dragnet, a spy network perpetually intruding into the affairs of others and visiting harm upon those they exploit and whose affairs they busy themselves with always under whatever pretense that masquerades as help but is in reality hindrance and harm to the extent they can manage to get away with it.

As Maurice Samuels said: "We are destroyers" and indeed the surveilling and stalking of those they deem a potential threat is not merely undergone for the purpose of neutralizing potential harm to themselves directly but to their global conspiracy that has been ongoing unflaggingly for millenia on the earth and presumably on planets prior to this (eg. Mars which has experienced a nuclear war that destroyed its atmosphere as "*The Cosmic War*" by Joseph Farrell explains and "*The Face on Mars*" by Richard Hoagland elaborates, though both works contain disinformation elements shifting blame to 'nazis' from the kike-o-demons).

Thus the jews are, as the saying goes "hell bent for leather" and employ their gangstalking techniques as a mechanism of neutralization of opposition, potential or actual and, when the targeted individual is a sufficient 'threat' used as a torture mechanism to psychologically torture their victim, the efficacy of such torture depending upon the strength of will of the victim, those of a weaker constitution buckling under the pressure and winding up as suicides or dysfunctional wrecks which is the jews intention should they not wish to go further and seek to kill the target outright if the life of the target poses too great a risk to their vile plans for global control and the enslavement of the world.

Making 'Good' Men 'Better'

"Judge them by their fruits, by their fruits ye shall now them". This applies especially when it comes to those who style themselves "the great and the good", those in other words who are the self-appointed 'gods' of the lodge of freemasonry.

Their actions enables one to understand them by abductive reasoning (argument from sign, from the symbols they employ to 'hide in plain sight'-symbolic gestures; actions and events they bring into being).

What they create is chaos and this chaos is a manifestation of their mind as can be inferred on the basis of the fact that the Creator's nature can be inferred from the Creation. The creation of what calls itself Zion is a state of being that is the state of chaos-inherently self-destructive through a violation of the Cosmic Law; the violation of all organic life (pollution; genetic engineering; the imposition of harmful technologies upon the otherwise harmonious environment such as chemtrails; big arga; combustion engines utilizing gasoline; power plants, etc.)

The gods of the lodge are violators of 'The Divine' (Being) and wish to create their reality as an act of usurpation of God from his thrown. Everything they undergo in their projects is artificial and harmful to the Being of the beings (organisms) in Being (the sum total). Thus they are the violators of Being/'God', doing violence out of their own egocentric hubris. Hence they are not 'Good' men being 'made better' according to the discourse of freemasonry but rather they are instead bad men ('men' in the sense of aspiring luciferian androgynes) made worse through the self-destructive rites and actions, emotions and thoughts that render them a perfect ashlar (aka. a lump of stone molded in the image of the jew).

It is these who are the perpetrators at the level subordinate to the jew and superior to their own underlings, the profane 'goyim' who carry out whatever orders they have issued to them always in a manner where the underlings only know what their superiors need them to know to carry out their tasks.

The very nature of the hierarchically based secret society wherein lower levels are kept unaware of the actions of the higher and the higher issue orders in the form of implications and suggestions from top down implies the lie of the organization itself as it has something to conceal and the higher ups withhold the motivations they have or even the larger objectives that any honest elite not operating on the basis of the lie would make clear in terms of their intent thus consolidating around themselves the forces of their loyal members whose loyalty is based on Truth (honor/fidelity towards a common purpose held amongst the members). Hence any kosher approved secret society is false in its very nature and liable to corruption (corruption of Truth) as it is accommodative of mendacity by virtue of its secrecy-anything goes and usually does given the track record of the jews throughout history and the bloody harvest they have reaped against and amongst their non-jewish adversary (an adversary in the mind of the jew simply because they are not jewish).

Hence rather than making 'good men better'; the lodge of would be demigods is in reality a crucible of the demonization of bad men who were bad enough to begin with to enter across the threshold in the first place...and into the antechamber leading into the lake of fire.

Perp Army

The dark forces employ their slavish hordes through the conditioning of their minds through classical conditioning techniques of elaborate sophistication such that the legions of doom (of the doomed that constitute that army) are assimilated into the hive mind of Zion as 'spiritual israel', aka. mere captive souls who are gradually destroyed and assimilated into the hive mind.

This is what the jews call "going to god"-being disintegrated and absorbed as energetic food into the egregore they have created, the oversoul of jewry ultimately itself being more of a refined amalgam of soul food the archons feed upon to sate their vampiric necessity, the *conditio sine qua non* of their being.

These legions are brought to bear against the aryan host such that they are mere marionettes on strings -are merely a coterie of possessed entities who are only at best (or worst?) semi-autonomous creatures, thoroughly zombified through the vampirization of their soul and its intended robotization through transhumanist techno-crazy (the implantation of rfid chips and the connection of the zombified slave with the grid).

This army is possessed by more than mere strength in numbers and the superlative intellects of sadistic black magicians which lead them to their doom-it is possessed by the archons and thus functions to as great an extent as possible as a collective serving the interests of the cabal in their enslavement of those who might threaten to break out of their prison.

The standardization of the hive mind is the end goal for the creation of a closed system prison planet soul farm for the manufacture of souls ("be fruitful and multiply" goyim). Accordingly the jewish vampires may then "suck the milk of the gentiles", their souls.

The intention is a self-perpetuating torture machine that enables the furnishing of these entities (which jews call 'angels' in their religion) with the energy of their abused serfs. One can only gird himself with the weapons of war and bring combat to the enemy as no other alternative exists-victory or valhalla is the only conclusion.

The perp army is a mob without independent will-"strike the shepherd and the sheep will scatter" as the jew Robert Greene said in his work "*The 48 Laws of Power*", a work typically jewish: a falsification of history and offering of an inverted morality: the good arians trampled via slander in the mud of the jewish mudslinger and the criminaloid jewish deviants exalted as heros. The perps are all heros in their own mind-their 'not-self' owned hive mind modelled on that of the chandal jew and being a mere satellite controlled by their masters the dark forces.

Caste Of Characters

In the ancient vedic caste system of what was then called 'Bhūstan' now modern India the entirety of the population was divided into four groups called castes which served as the structure of the society.

The conquering aryaans who had migrated to the region from the North approximately 5,500 years ago or more imposed upon the negroes from the South the chains of serfdom relegating them to the bottom of the caste system, the serf caste designated by the name 'shudra' or 'chandala'.

The aryaans divided themselves into the remaining caste with the possible presence of a Near Eastern or Asian mixture which constituted the merchant caste, the intermediary or middle man between the bottom and the top two tiers who furnished the latter additionally with its opulent desires- for a fee.

The ruling castes were the Brahman or priest caste which occupied the top tier and played the intermediary between the Divine and the human realm. The Kshatriya caste being the warrior caste of nobility who administered order and involved themselves in territorial conquest. The four castes excluded from themselves those who were designated 'pariahs' or people without caste who were shunned as lower than the shudra caste as having no participation in the society.

The priestly caste at that that time under the aryan rule may have been quite tolerable as a rulership in conjunction with the Kshatriya though Nietzsche's criticisms from his work "*Will to Power*" nevertheless apply-the priestly caste has always been and will always be hypocritical and deceitful in their manipulation of the masses through their smoke and mirrors intermediation and for that reason are at any future time and today especially not only a superfluity but a curse upon the development of the people of the nation when divorced from their warrior element.

As then, so today, the priestly caste is infinitely more corrupt than ever before and this as it factors into the presence of the born priestly caste hypocrite and paradoxically the born sudra-the jew, whose magian fatalistic mendacity has marked him with the mark of cain, the judenhut and yellow star badge throughout the ages.

Priestly castes always tend towards decadence given their absolute authority and lack of any challenges to their authority in addition to their having the opportunity to deceive for personal advantage the broad masses who are easily surveyed by its artful guile. The current concealed priest caste of jews and freemasons further underscores their decadence.

The kshatriya caste is traditionally associated with the more masculine element that conditions the society (the nation; the 'Organic state'; in the words of Julius Evola) to adopt a more masculine attitude and mode of life which was adopted by aryaans throughout history from Vedic India to Prussia and National Socialist Germany and all of the related nationalist parties and states which existed around that time (Portugal; Spain; Italy; Greece; Bulgaria; Finland; USA; Japan; Romania; Belgium, etc.).

This castes' role is to maintain an orderly and regimented society of virile and active members governing in tandem with the priestly caste which latter has the final say as the intermediary of the Divine Will and whose corruption facilitated the regression of the castes throughout world history proceeding from the Hyperborean and Atlantian epochs.

The defect of the Kshatriya caste is that the individual members thereof (the nobility) at times place their own particularity over the universal in Hegelian terms (*vide*, "*The Philosophy of Right*") this created division between rivals who vied for power beyond their current position as an essential trajectory of their failing to subordinate themselves to a solid priestly caste of Divine Right and thus perceived windows of opportunity to usurp power for themselves and fill the power vacuum created through the corruption of the priestly caste.

In contemporary times there is no longer a Kshatriya caste but rather a mercenary army under the thumb of the plutocracy of judeo-masonry which mindlessly caters to their beck and call. Though elements of that caste may and necessarily will, when conditions obtain, come to the fore and usurp power for themselves in coups and counter-revolutions against the last caste the shudra from which the original jewish elements derived (having been Atlantean slaves and so too in ancient India).

The danger of the Kshatriya caste was its lack of unity around a higher Idea and its plunging into decadence through lack of challenge to its power from without and accordingly itself opening up holes through its decadence enabling the usurpation of its power by the bourgeois caste from 1789, the beginning of the first world war and perhaps around the second though remnants still exist whose power lies in more subterranean forms than in that of any governmental agency or official monarchical power, being largely titular at this juncture and rotted out with the syphilis of jewish admixture, subordinate in large part to jewry via freemasonry.

The third estate or caste called in Vedic India 'Vaishya' connoting merchant or trader caste has now gotten hold of the reigns of power which are concentrated into the hands of jewry who now exercises arbitrary sway over the whole population through the power of gold and the stock exchange operating as a vampire spider ensnaring the world in its web of economic relations connecting most all non-jewish elite globally through the trap of freemasonry which necessitates the non-jews' loyalty to the jews and their projects for global dominion.

At this juncture the jews have imported the teeming hordes of savages from the barbarous areas of the planet into all aryan homelands-lands the aryan created with their own ingenuity and Creative Will-and this under any and every excuse: temporary foreign labor; refugees; humanitarianism, etc. The private army of the Bolshevik untermenschen are brought in to destroy the remnant of the bourgeois culture through contrived crises and staged events brought about by the jewish spider twitching in his web and manipulating the strands of his system of slavery to destroy the bourgeoisie enabling him to usurp all power and money remaining not totally possessed by himself.

His invention of the 'aryan privilege' myth serves as a mechanism of transference of his own karma for living a lazy parasite life at the expense of the aryan population from whom all his wealth is derived through usury and exploitation.

He uses this myth to mind control his low I.Q. untermenschenn (aryan and non-aryan) and to frame aryan people in preparation for the acting out of the aryan genocide agenda through the instrumentality of his hordes, his bioweapons (vaccinations, etc.) and his perpetual contrivance of false flag operations in his stage managing the theatre of the real to attain his Zion government over all and sundry.

The caste system has ended with them (the jewish priest caste)-which regression leads to the total destruction of civilization and concomitant collapse of society. The promise of the dawn of a new day however will not arise in the form of a red dawn of soviet slavery but a Golden Dawn of the Solar Logos of the aryan Race who will usurp power from the megalomaniacal jew and take total control for himself over the earth, ensuring a new kingdom of heaven upon earth, an *imperium albus* (aryan empire) imposing order upon the chaos of a fallen world.

Tripartite Bipedal Schema

Those who are falsely called 'humans' today are in fact a diverse group of dissimilar species of being such that any

1) proximity in terms of physical space and

2) any mixture undergone between two or more (miscegenation) leads *ordine geometrico* to conditions of extreme chaos.

The beings who bear the appellation 'human' are in fact properly schematized in terms of their differences as follows and can only be spoken of comparatively based upon a few anatomical and physiological features: those being the fact of their bipedal erect or semi-erect gait, their having tangible and palpable similarities which yet are in no way identical but instead radically distinct physiologically and anatomically as well as spiritually which will be gone into more in the following.

The first and second entities to be discussed is that of the non-aryan, the bipedal being who is not what in modern parlance is termed 'aryan' that is to say not a european/caucasian/aryan bipedal being and the jew.

The first being can be considered related insofar as they are intertwined or share in anatomical/physiological properties. The first is that of the non-white who, though mixed to a degree is nonetheless the being most possessed of the primordial traits that derive from the now extinct anthropoidal bipedal entities (*homo neanderthalensis*, etc.) The non-white is what is now referred to as the negro; the mongol and the australoid and those who have a proportionally significant share of their blood (genetics) of these anthropoid entities (the term 'anthropoid' here being used merely as a conventional term designative of those entities reminiscent in their anatomical/physiological structure to those currently designated 'human'). This non-white is not the second type or the third but a singular entity unto itself though admitting of variations as aforesaid.

However the origins of certain of the non-whites specifically the far east asians may have some other origin as Blavatsky said in "*The Secret Doctrine*", being the seventh sub-race of the fourth Atlantean root race. Perhaps their origin may even be partially extraterrestrial.

The second type is that of the jew, who is largely mixed with the first and third again in varying proportions and shall be designated 'de-man', being of a certain genetical-spiritual structure that enables their possession by entities with whom they are bound generationally. This aspect of possession applies presumably in the case of some non-whites but the specific entities they are bound up with (such as the 'orishas' in the case of the negro) are of a comparatively feeble influence in their visitation of chaos on the earth, whereas in the case of the jew they are of a superlative malignancy as can be inferred from the behavior of the jew in his bloody trek through the ages.

Thus the jew is a de-man and partakes of specific entities based upon his possession of a certain hybrid genetical-spiritual (or rather genetical-infernal) constitution through his combination with the third type herein considered, that being the aryan or 'human' ('hue-man', 'man' with 'hue' or light).

This type is he who is possessed of a genetical-spiritual constitution comprised of a body-soul and spirit which latter aspect of his being exceeds that of the former two types in subtlety and refinement and substance, making him a 'heaven sent' being, participating in the higher realms which are inaccessible to most of the previous two types. It is from this originary faculty that is derived the creative impetus of the aryan and which may be spoken of as a recapitulation of the Divine Will, the microcosm of the macrocosm from out of which all ontologically meaningful culture derives.

Nonetheless in spite of this 'blessing' from 'the lord' (this faculty of what Kant called 'transcendental apperception', a supra-rational intuition based upon a higher consciousness crystallized in the material forms of the pineal gland and pituitary body), they have suffered a 'fall from grace' through mixture with the anthropoid and thus have become earthbound to a great degree.

Augmenting this fall is the influence of the second type, the jew, who understands that the aryan is fallible and, though not fully understanding his Nature viewing the aryan from his perspective (from the bottom up, from the 'hells' below, from Hades) he nonetheless seeks to further debase and degrade the aryan through what may be referred to as 'temptation'-the presentation of various phenomenon to the latter's sight-forbidden fruit-in hopes that he the aryan will take the bait, a bite of the poisoned apple.

Examples of this are all the multifarious forms of corruption existent in modern society: sex, drugs and crack rocks and bank roll-all of which however lowers the consciousness towards a purely materialistic-sensationalistic state and stifles and obstructs the cultivation of the higher or rather the 'redemption' of the higher states of being through the exercise of those faculties which elevate and which amplify the restricted consciousness beyond the purely lower egoic mundane orientation. The presence of the non-white also is a significant factor in the jews motivation to trip up the aryan to an ignoble stooping and ultimately-so the jew intends-a fall into a leaden casket or a mass grave through failure on the part of the aryan to perceive the trap.

The beastman as has been historically borne out has served as a mechanism of temptation: in the form of decadence of the aryan through reliance on the non-white or slave labor which led in many cases to either the non-white being used as a destroying influence through slave rebellions presumably led by the jews' instigation and/or the seduction of the aryan to the carnal delights the non-whites proffered as a means of advantaging itself at the expense of the aryan seeking to elevate his status as happened in ancient Egypt, Vedic India and the surrounding regions in the Near East and Mediterranean leading to their collapsing in on themselves.

Thus it is temptation and the fallibility of the aryan which has precipitated the downfall of his civilization. This in conjunction with the malevolence of the jew-the resentment morality of the chandala-that has brought yet further low his first estate, that of the Divine God-Man who derives from the gods.

The redemption of the aryan entails his supercession of the base drives, his chaining and reigning in the beast of beast consciousness and seeking to elevate himself above its gravitational pull. For this he must develop spiritual strength and this means the exercise of those regions in the anatomy which serve as conduits of the Divine Will the pineal gland and pituitary body; the detachment from the worldly chaos of the seething corrosive waters of spatio-temporality and the orientation upwards around the Self through undergoing challenges that develop the higher faculties and integrate within himself the greater power they confer via control of the Will.

The aryan is a vortex of energy whose resistance to the disintegrative currents which ring him round is the *conditio sine qua non* of his being. The warfare against the dark forces is a spiritual one which necessitates training and development for the deployment of his Self against the infernal forces and this as a means of building the kingdom of heaven upon earth.

Mercenaries Of Anti-Race

Those who are portrayed as 'successful members' of the modern world-as a necessary condition of their 'attaining what they have attained-are invariably proponents and embodiments of anti-race, of the universalist creed of egalitarianism. This is because the system is controlled by the originators of the anti-race creed and its greatest exemplars the jews who have developed this creed out of themselves organically as 'the organic lie' (the original sin qualified as the sacred idol of semitic supremacy around which all are forced to circumambulate and kowtow before in order to 'please the lord').

All of the shabbos goyim, the useful idiots of jewish anti-race must carry the silken robes of the jewish emperor in the empire of Zion and clean up the messes he makes, pretending that the excreta of jewry (his entartete kulter) is shinola and alchemical gold. The establishment must exalt the sacred idol of anti-race, of the freemasonic 'humanitas' of identityless universalism wherein 'all are one' before the jewish version of 'the One', what has come to be designated in the English language 'God'.

They exchange True philosophical gold for the fool's gold of worldly wealth worshipping mammon over God and having not even two masters but rather the master of mammon and jewry who have twined around their neck the golden chain.

This is the idol before whom they sacrifice-the golden calf of equality, the identityless anti-race, the quantitative abstraction of the 'mixed multitude' which mixture, though implying difference is deliberately ignored as a mechanism of achieving a perverse amalgam of difference in a universal commodity called a 'human resource'.

This is designed to be exploited, bought, sold and exchanged by the parasite plutocrat priest caste to enrich themselves hedonically (in terms of the accrual of social capital and the sense of importance that accompanies the display of one's 'humanitarian virtue') and monetarily enrich themselves as characteristically defining of bourgeois identity (itself negated through its own universalism, clinging at most hypocritically to its pot of gold while affirming identity with those who have at most a piss pot filled with the excreta of the leisure class).

These mercenaries of anti-race, specifically the aryan bourgeoisie, traffic in the coin of the realm of Zion, accumulating golden coins while pretending to live a life of humble and honorable work, pretending in characteristically hypocritical fashion, to sacrifice themselves on the altar of 'humanity' while actually sacrificing the slave class on the altar of their own ego and self-enrichment.

This has been the role of the decadent leisure class throughout time-only in today's bourgeois world they are not possessed of any 'royal prerogative' that endows them with any 'Divine Light' to conquer and to command the sacrifice of the lower tier of society, rather at this time they sacrifice the lower tier for their own base born ends and with the pretense of helping them.

At least the nobility of yesteryear would pick their own people up from the mire instead as in the case of today cast them into the pit. The nobility of the past degenerated through decadent hyper-sexualism, which lead to their failed duty of care to their own *de facto* 'children'-the lower class peasants. Now the bourgeois class revels in its own hyper-sexualism (*libido dominandi*) and brings about its own destruction through inner decadence and the contempt and hatred directed towards it by the peasant class who recognizes the smiling mask of hypocrisy which is used to pacify and placate that hatred.

The peasant caste as well in this stage of the cycles of time has fallen from its former grace, not being able (of necessity to the extent it recognizes reality) to respect its socio-economic betters who deny it what it needs to preserve itself, that being a land exclusive for itself and the conditions of its identity-the honor of performing its accustomed work in accordance with its own nature upon the basis of the principle '*suum quique*'.

The peasants now are infected with the doctrine of anti-race and fall into the trap set for them by jewry and the traitorous bourgeois internationalists. All have fallen into the pit, the crucible of the melting pot and only the purest elements who yet possess the Divine Spark may extricate themselves therefrom.

Those are they who are targeted most strenuously-they who, having the blood memory of the aryan, can extricate themselves and potentially others from the 'shit stew' as Matt Hale called it of the multikult crucible of Zion and potentially upset the entire pot into the fires which rage beneath, banishing the excreta of anti-race to the hells. With such a bold gesture-bon geste- precipitating via alchemical magic the 'Good', the True and the Beautiful-the torrent of diarrhea that is the evil horde can be overcome and the land purified in a world of Eternal forms ('nunc stans', the eternal now), a return to first Hyperborea and the aryan race, the renewal of the earth after a cleansing of the earth (a genuine 'tikkun olam', not the falsified version of the kabbalistic scribes and pharisees).

Anti-Race enters the nigredo phase of its own diabolical alchemical transmutation and finds itself lacking, unable to wrest the Graal from its pedestal or to recover the emerald from the crown of the gods (the green ray via the black sun).

It is only they of the royal bloodlines who may obtain such and this through disentangling themselves from the egregoric tentacles of universalism, through an overcoming (a self-overcoming) of intellect by suprarational intuition and an attunement to being, overcoming the rationalism of Semitism which has negated Being through the Self-reflexive modalities of consciousness amidst the welter of becoming as means of clinging to simulacral knowledge objects to preserve itself (oneself) as life preservers amidst the torrents of becoming, of the corrosive waters.

The semite grasps ('begriff') becoming in attempting to salvage his being (fallen and corrupted as anti-race) but merely grasps at illusion and gets carried away by the torrent, comfortable in his prison of conceptual abstractions that are the illusory self-defense he girds himself with in confrontation with Being (God). The aryan by contrast (-by diametrical opposition-dwells in Being and escapes the torrent like an action hero clinging to a helicopter and escaping the maelstrom below, the current of disintegration, ascending to the Olympian heights and crowning himself with the emerald crown as man of Race. This is beyond class, it is a self-positing of the aristocrat of the soul against the clawing hands of the grasping untermensch, the anti-race plebeians of the soul of whatever class).

Dark Caste System

The caste system will never and could never disappear as it is a function of Being/'God', the differentiated order of Spirit into crystallized matter. All organic life arranges itself hierarchically and this irregardless and in spite of any artificial engineering to the contrary.

The cabal which rules the world seeks to create the illusion of a state of 'universal brotherhood' having no reference to race and being antithetical to Race-to the identity of those being falsely called 'brothers' implying some form of impossible equality amongst the unequal.

This illusion is of course adopted by jewry solely for the (unexpressed) purpose of their bringing low the hierarchy of their enemies (those not jewish) and increasing the probability of their supercession over their competitors for power which is a cryptic, mendacious positing of a caste system of an inverted type wherein "the last will be first and the first will be last" (the gutter creed of the untermenschen, the chandala and the attempted realization of their utopian pipe dreams of supremacy over all).

Through the process of the organic involution of the aryan caste as spoken of in Julius Evola's "Revolt Against the Modern World" and through the fires of revolution set by jewish and freemasonic incendiaries the aryan caste has been brought to its lowest level, torn down from its height and supplanted by the inverted caste of the chandal which could properly be spoken of as the "Dark Caste System"-that of the infernal forces (archons) and the humanoid forms they work through on this terrestrial globe (jews; non-aryans; illumanized arians; zionist christians, etc.).

This dark caste system has the following structure:

1) The top of the tier is that of the archons who are the mastermind that controls those beneath to a degree of proportional influence, radiating their false light over the goyim beneath them-'beneath' in terms of the false light and its containment within themselves but also in terms of relative socio-economic status and political-temporal power.

2) Underneath the archons are the jews, the visible agents of chaos upon the earth who work with their masters and are bound up with them in terms of bloodlines and a special formulation of blood (DNA; DNST-3 scizophrenia gene) and via occult rituals based upon the hebrew kabbalah in its most modern form, that within the Sepher Yetzirah of the Zohar of the Bablonian Talmud, though paleo-historically in the form of the mother goddess cults of the Near East and the priestly caste consorts thereof (*consortium infernus*).

As then, so today the formula is the same-shepherd king priests of the order of melchizedek seeking to rule over the slaves as the intermediaries between 'God'/'Being and the organic forms (goyim) who are not illuminated through the appropriate bloodlines and rituals.

The relationship between the archons and jews is that of a *quid pro quo* (tit for tat) exchange of energy for energy: the jews engineer chaos and this induces strife in the non-jews which releases their energy and which is vampirized by the archons who in turn confer upon the jews a portion of their own power/energy, 'illumanizing' them. This exchange occurs through the torture murder rituals of the jews and this within the context of a larger or smaller *topos*-the synagogue or masonic lodge (more privately) or the public space such as in the case of false flag terrorist operations which very often entail the targeted person they have placed in their crosshairs from birth and tortured throughout their lives through the gangstalking protocol.

Under the jews in the Dark Caste system are the illumanized goyim (shabbos goyim-'stupid animals' in yiddish) who follow in the shadow of the jew and are bathed in the false light. These are the sellouts who knife their own people in the back and who are trapped within the lower ego envisioning themselves in their arrogant vainglory to be 'beyond race' in their anti-race 'humanism' or Abrahamic monotheism. They sell their souls to the jews and become bound up with them through the influence of the egregore (thought form) into which they are assimilated or are bound to as if by demonic chains that enable them to be utilized by the jews as their pawns and which then facilitate the takeover of the archons on the earth and the enslavement of the 'goyim' serf caste these latter represent mere ensouled husks (qliphoth) or organic forms that are receptacles of bioenergy that are vampirized by the occult 'powers and principalities'.

To enforce this system the occultists utilize their black magic as a bond which glues together the moving parts of the trapezoidal structure (in its material forms-from the occultists below; with the archons constituting the capstone of a non-physical pyramidal structure) and mobilizes the lower level minions to carry out their bidding.

The system is 'conditioned' to enforce itself through the black magic influence of the vampires of Zion. The system enforcers who wear the kosher badges and insignia of Zion (police and military) eagerly carry out the orders of the occult theocrats without thought or question and impose upon the goyim serf class-the proletarian 'workers'-the economic chains which bind them as human batteries to the cabal and facilitate their genocide by act and omission (qualifying them as terrorists should they not acquiesce to their own replacement by foreign hordes).

The 'god people' in the government offices pulling the levers and twisting the knobs of the Zion murder machine are supported by their fellow hypocrites at a lower level though oftentimes to a lesser degree and in many cases privately being against their tyranny the trades people who prop up the infrastructure and ensure that the machines' parts synchronize in elegant machinization in their grinding the bones of the slave caste to make the bread of the occult elite.

The sudra caste of serfs has become a caste predominantly of the aryan population in terms of any creative and productive action though the aryan are being cast from their place into the caste of the pariah's and out-castes (the homeless; the unemployed). The ranks of the indigent and shunned are being ever increased by the aryan whose proper place has been usurped by the jews and their hordes enabled by the decadent aryan bourgeoisie especially.

Such a growing population is the thunderhead which swells in looming threat to the cabal as the disaffected aryan no longer have the means to carry out any higher forms of life and beyond this no longer have the means to even partake of the necessary conditions of a 'low-life' of basic necessities.

Indeed the Weimerization of all aryan nations is underway and on that basis it is grounds for a revolt against the modern world now that enough of the serf caste and the healthier members of their superior ranks are aware of the danger to their own survival.

The Dark Caste System must be replaced by a new Caste of Light, that of a new aristocracy of 'blood and soul'.

The Caste of Light

The caste which must replace that of the dark forces is that of the inversion of the inversion of the caste of darkness—a return to Hyperborea, to the golden age of the purity of the aryan, the spiritualization of the infernal world of Zion. The overthrow of the archontic entities and the jewish pestilence; of the occult traitors of the aryan race and all of their incorrigibly corrupt underlings will bring into being that golden age and this first and foremost through a spiritual awakening of the aryan, rekindling the Divine Spark of his fallen state.

The top tier of the Caste of Light, of the sun of Mind, will be occupied by a warrior priest caste. The Kshatriya nobility will ensure an orderly society/nation based upon the laws of 'God'/Being, maintaining an equilibrium of harmony over the earth and developing the collective consciousness of the aryan race to a state of god-hood, returning them to their first estate within the meritocratically based hierarchy of Universal Order.

The Order of the Universal is simply the particularization or concretization of the Absolute, and not a 'universalism' in the egalitarian sense which latter prevails in the dark caste of the chandal usurpers.

Within the Caste of Light all will direct their efforts to the maintenance and preservation of Order and all will live in accordance with the Will of the Divine (harmoniously; Orderly). The system will reinforce itself in union with the Good Forces which are aligned against the darkness of the archons and work towards a preservation of the sacred flame of the Light of the North.

III-U-Man-At-I

Those who style themselves 'illuminated' are in reality instilled only with the false light which is itself merely what has conventionally been referred to as 'demonic possession'. They are those who are 'ill' in their 'manas' ('mind' in sanskrit) and as it relates to their ego/I/Self. They have lost their True Self and like little bopeep don't know where to find it, as the entities or entity that possess them have monopolized and perhaps even substituted itself for their consciousness, have nihilated the 'I' (icheit; 'I-ness').

Accordingly they are, are those illuminated ones, assimilated into the hive mind of Zion, of 'spiritual israel', and are under the black magic influence of the archon entities and their jewish underlings who employ their qabbalistic gematria and hebrew formulae to manipulate and control their actions such that they the illuminati become puppets on invisible strings, pinnochios manipulated by the jewish puppet master Stromboli who himself is a mere marionette on the strings of the archons.

Thus is one of the main techniques of the jew is that of the occult usurpation of the head of society, of the consciousness of the elite. As it was written on the wall of the then assassinated Tsar Nicolas during the Bolshevik revolution in hebrew script: "Kill the king, kill the kingdom". The book "*The 48 Laws of Power*" by the jewish plagiarist and falsifier of history Robert Greene, spells the jewish black magic spell clearly in his chapter entitled "*Strike the Shepherd and the Sheep will Scatter*". Such is the protocol of the jew for their despotism.

As it speaks of in "*The Protocols of the Elders of Zion*" with regards to freemasonry the jews beguile the freemasons in their lodges though appealing to their curiosity and putting forth wonders and smoke and mirrors as a means of enticing the goyim cattle into their harnesses of occult enslavement.

The upper caste of the aryan who have become ensnared in the lodges and have visited upon themselves the curses of the hebrew are the dupes of Judah, the cats' paws he uses as a mechanism of the sabotage of nations. Once hooked into the hive mind of jewry, the shabbos goyim become their puppet and this with an increasing degree of corruption the higher up in the occult hierarchy they go, the higher degree in masonry they are, the more bound and the less autonomous they are in their function.

This is why the "Ill-U-Man-At-I" is required still to carry out their tasks in the mundane world in relation to their own particular knowledge set and context (spatio-temporal conditions). The process of possession, for it to become a complete fusion of or elegant correspondence with ('elegant' not meant here in an aesthetic but mathematico-geometric sense-'god geometrizes') the entity (the 'evil genius' of the lodge) requires time, a continual relationship between entity and person such that the person becomes assimilated in their consciousness to 'spiritual israel', the luciferian hive mind collective consciousness stage managed by the jews and their dark masters.

Illumination translates into "Ill-U-Man-At-I-On" which means the making 'ill' (or bad, 'kakos' in the Greek of Aristotle) of your ('U') mind ('manas'-'man') and this performed by the entity and or the lodge members on the 'individual', the 'I' of the subject making of them an 'Ill-U-Man-At-I'. Such is the process of the kindling of the false light and such is the means through which the archons and their material instruments the jews, garner complete control of the elite goyim and take control of the nation assimilating it into their 'federation of the world", a "united nations" of raceless, identityless 'individuals' who are mere transient economic units who serve the jews as mercenary slave labor and bow before the false idols of 'humanity' and the jewish god, chief archon of evil, what was referred to in J.R.R.Tolkein's mythos as 'Sauron'.

The all-seeing eye looks through the eyes of the illuminized goyim as his slave underlings rather like the ring wraiths or like Saruman of the white hand (the white hand of masonry). Sitting above the slaves in his tower of Orthunc, Saruman, the "Ill-U-Man-At-I" freemason gazes out upon his minions and sneers as he takes a sip of his brandy. Just then a knock at the door is heard and Saruman, irritated barks: "What!" to which a nervous and exitable tone responds from the mouth of the jew grimir wormtongue: "Saruman-the city, it is under attack!".

Saruman frowns and hurls the glass of brandy into the fireplace rushing to the palantire he has placed upon his mahogany desk and observes the siege engines outside the walls armed by the fighting men of middle earth prepared for battle, their blue, green and brown eyes gaze out from weatherbeaten faces whose ruddy glow bespeaks a proud victory over the orc hordes who have been swept aside to make way for the aryan champions.

Saruman moves towards his cabinet wherein he has shut up his wizard's wand and heads towards the window in the tower which faces the ramparts. As he spreads his arms and prepares to summon a spell he confronts in his palantire which he had affixed to his staff the figure of Gandalf the aryan, the good wizard who has now attained the diamond thunderbolt body of immortal vajra after having fought the Balrog in Moriah in the nigredo phase of alchemical transmutation-he starts and falters losing his concentration.

At such point a bolt of aryan hot energy breaks forth from the darkling clouds above and strikes him in his black heart casting him from this lone promontory and towards the orcs and mongrels amidst the technical monstrosities below. His mangled corpse looks upwards towards the heavens with vacant eyes and receives no response to his dying supplication. O'erhead circle the nazgul who descend upon his form and rend it, bolting it raw into their ravenous maws, Saruman experiencing at the last a reciprocation of his own vile rites against the innocent children of middle earth. Such is the fruit and fate of 'Ill-U-Man-At-I' who have failed to understand the simple principle "with jews-you lose", for the jews are indeed the children of the damned whose fate is the lake of fire.

World: The Arena

One must know the world in its worldliness to achieve victory therein

Manhunt

There exists a genre of action movies from the late 70s to the early 90s that portray the act of man hunting by an elite group who target isolated individuals, specifically non-whites and jews, for sport and a power rush-the jewish hollywood created stereotype of the 'evil nazi'. This is a complete inversion of reality as the actual phenomenon of man hunting (beltane hunts, etc.) has always been undergone by the dark forces of the earth led by jewry as the vanguard of destruction against those who could properly be spoken of as "the children of light", the aryan race.

In the phenomenon of gangstalking, a modern (and yet millennial as the witchhunt of yore bear testament to) version of the beltane hunt, it is the blonde haired blue eyed aryan females specifically and other nordic bloodlines who are targeted and placed foremost in the crosshairs by the cabal of darkness for sacrifice and the form of this ritual torture murder.

It is specifically those of Nordic noble bloodlines who the jews seek to target and eliminate as they embody the blood memory-the higher consciousness of aryan man- and thus they would pose the greatest threat to unconceal the agenda and *modus operandi* of the cabal through the higher intuition (suprarationality) of the aryan, its defining attribute, the holy Graal or emerald in Lucifer's crown having fallen from heaven (Spirit into Matter) and inhering in the physico-spiritual structure of the aryan noble stock.

The jews are aware of this fact which is why they seek to mobilize all of their halfwit captive serfs who they have ensnared in their traps through mind control-the exertion of black magic hypnotic influence upon the mind of their dupes and pawns. These are the puppets, bred generationally to serve the jewish oligarchy as means of deriving power and advantage for themselves.

Today these pawns are the generational military and police and the generational drawers of water and hewers of wood that cater to the whims of jewry and who, it appears inferred from their behavior and words are possessed by the entities the jews themselves are-the astral parasites known as the 'archons' in gnosticism or the asuras in vedism.

These entities avatar the bodies of these 'hollow men' (in the words of T.S.Eliot) and whip them forward as so many Frankenstein's monsters mobilizing them to attack whatever constitutes a threat to their control matrix, specifically the target in the crosshairs of their man hunt-the aryan (the only 'man' as 'man' derives from the sanskrit word '*manas*' connoting 'mind' or the higher principle of consciousness which principles are foreign to the goyim who operate purely at the level of animality, beast consciousness).

The aryan can perceive the chinks in the armor of the matrix cube and pry it apart or attach incendiary charges at its most vulnerable points and detonate it-hence he (be the aryan a woman or a man) constitutes a threat to the system as he alone has the key to its destruction.

For this reason the jews avatared as they are by the archons prejudicially target with malice aforethought the aryan and impose their malevolent intent upon their slave caste so that the slaves can serve as their subhuman battering ram against their foe.

Gangstalking is the beltane hunt of postmodernity and the targeted individual is the witch that the self-appointed priest caste seek to burn at the stake with microwave weapons held in the hands of both themselves and their low I.Q untermenschen.

The manhunt ('*manas*' hunt) witch hunt of post modernity is the occult ritual which feeds the archons the pain and death energy of the victim whose soul the jewish priest caste seeks to destroy through countless minute techniques of soul destroying influence: drugs; alcohol; vice of all kinds; an occlusion of True Spirituality and its supplantation with a purely materialistic and fictional dogma having neither rhyme nor reason other than to keep the goyim mixed multitude serving the so-called (by themselves), 'israelite's'. The aryan thus must grid himself with weapons of war and do his utmost to gain his dharmic reward through combat-either the conquest of the enemy and the latter's minions of savage slaves (be they white or non-aryan in their nature).

The struggle between light and darkness continues on with the aryan having the onus to involve himself (in his involuted form) in perpetual combat-war everlasting- against the jewish evil and their infernal masters. Though targeted one must himself be-a hunter and turn the tables on the enemy making prey of at least some of the predatorial hordes though he, the higher being, may die as he takes aim at the enemy he at least will leave this earth in a manner suited to the aryan.

The '*manas*' hunt for the souls of the aryan and the destruction of threats to the Zion matrix the jew kike-o-demons and their bestial legions pursue with fanatical zeal seeking to sate their bloodlust on the sacrifice of the enemy. Whipped forward by the influence of the archontic astral parasites who manipulate their unconscious mass-mind as a puppeteer employing its instruments of destruction against their foe and for the purpose of feasting upon the foe's energy.

The aryan, unrelentingly molested and harried by the foe, must give combat unto death in this world if need be as the victory has already been won in the spiritual. Thus in combating the foe he can say "victory and valhalla!" and he thereby secures his place in the heavens, returning whence he came, having never left save in a moment of weakness.

Cybernetic Pairing

The jewish occupation government utilizes its cybernetic control system-arrays of cell towers coordinated with satellites and rfid implants-to mind control the population to adhere to every jot and tittle of the noahide laws the jews seek to impose upon the 'goyim' the non-jew.

Beyond this it serves an even more sinister agenda unbeknownst to most and unbelievable to most given their limited state of consciousness and knowledge set (being trapped in the matrix): that they are having imposed upon them electromagnetic chains that harness them into acting according to various programming algorithms programmed into them by the jewish hidden hand via their supercomputers-until then require no or at least little intervention on the part of human or jewish agency-merely a self-operating system, operating autonomously, creating a cybernetic prison planet for the harvesting of soul energy by archontic entities and a rendering of the souls of the former humans-now robotized slaves- mere receptacles of power-energy that can be bled off by these entities who feed upon that bioenergetic source vampirically.

This is the ulterior motive of transhumanism: the conversion of once autonomous beings into captive souls. The means for the realization of this protocol (beyond the imposition of the above technology) entails the consent of the purblind masses: this is the key to the enslavement of non-jews by jews: the jew's discharge of their karma (according to their understanding of karma) through revealing to the non-jew what they themselves are going to do or intend to do prior to doing it and thus discharging their responsibility through transferring it onto the non-jew.

According to the jews this absolves them of their sins as does their kol nidre prayer taken on January first (the new year) or each year: "vow to end all vows, commitments and agreements in advance of their formation for the entire year". Trapping the goyim in the cybernetic control grid is the means of enslaving them and it is only if they allow themselves to be trapped that this can be achieved.

Hence the very discreet and often symbolized mode of communication of what is being done to the non-jews-communication by sign and symbol that the jew anticipates would be very difficult to come to an understanding of-difficult but not impossible and thus according to the above logic absolving the jews from their sins.

Cybernetic pairing is one of the techniques of the manipulation of the consciousness of the goyim: pairing stimulus and response: the stimulus of electromagnetic fields broadcast from cell towers and the additional stimulus of media propaganda and the behavioral modelling of the jews acting as theatre actors in the theatre of the real. This conditions the population to mimic their behavior in relation to certain events the jews have created or simply exploit and take advantage of the genuine response on the part of the jews which is done in as public a fashion as possible as means of creating archetypes they can seed the consciousness of the goyim-archetypes here meaning signifiers of meaning that are intended to be adopted by the non-jews to their detriment and ostensibly for their benefit-displays, eg. of moral indignation or humanitarian love and peace are put forth in hopes that the non-jews will mimic their behavior and that it will replicate to serve the intentions of the jews to as great an extent as possible.

The pairing of the stimulus of rf (radio frequency) and media propaganda impinging upon the five senses of the non-jews conduces to a certain set of behavioral responses/reactions on the part of the non-jew-such is the causal process the jew implements and which works on most all of the non-jews given that their mind is not their own but largely an ensemble of programming that is designed by the jews and imposed upon them from birth such that what they believe to be a thought or opinion, belief, idea of their own that they have arrived at through their own thinking or will power or that they have simply in their possession as a 'natural' fact of their consciousness-is in reality merely programming.

Indeed, they rarely by virtue of the automatization of their consciousness through the programming they are subject to, attain that meta-level thought process and thus simply 'exist' at that level of consciousness which constitutes their 'mind'-the ensemble or sum total of all reflexes/reactions and senses that comprise that holistic and plastic presence called their ego/I/Self.

They are, are the goyim, thus a construct of programming and are in no way autonomous but at best semi-autonomous entities who are having forged for them electromagnetic chains that keep them enslaved in the matrix and prevent their severing its bonds which encircle and become merged with their minds and those of others.

Thus in the Zion matrix cybernetic prison planet, all are fused into a pantheistic Oneness which collapses in on itself through entropy and all 'go to God', to the extermination of their individuality or rather personality. All are 'individuals' in the cybernetic internet of things-all are things and yet merely functions of the whole, nodes in an infinitely complex system of nodes.

However these modes collapse in on themselves through being vampirized by that which is 'Other' to themselves namely the archontic entities and their jewish robot slaves who simply bring about their own collapse of power through not having any sustainable system that enables them to attain the state of a self-propelling wheel that is the condition of the aryan.

The aryan, he whose consciousness has liberated itself from the Zion slave matrix, is the only being who can liberate himself from the prison as only he has the key to autonomy-that being a higher spiritual consciousness that transcends the purely material plane (maya).

However it is not a question of attempting to 'transcend' the spatio-temporal internet of things but rather to bring the kingdom of heaven to earth and to clear away the cobwebs of the Zion control matrix.

The solution lies in understanding the difference between the false 'reality' and Reality Itself and that through a heightened awareness/intuition. To unconceal the deceptive pairing of things into false realities (false associations) to sever the connection between the constructs of the jews and that with which they would pair that simulacrum-to tear aside the veil of maya in short.

With all of the imposition of intrusive technologies into one's body and ultimately into one's mind the only alternative is to raise awareness and to expose the despotism of Zion for what it is and to shut down the illusion machine in the most efficient and effective way. To unplug oneself from the cybernetic grid is foremost on the agenda of those of sound mind- a mind sound enough to understand that there is not a world of freedom or harmony extent. Those unable to perceive such obvious things (obvious to those of sound mind) are unworthy of attempting to further disillusion as they are too enmeshed in the matrix to be extricable through their own efforts and will power. Those of sound mind must draw from its scabbard the sword and sever the bonds that enslave them and others doing their aryan duty.

'Peace'-or 'Piece'?

The perpetual bleating on the part of the adherents of the equality cult over 'peace' serves as a soporific means of shutting down any dissent against their tyranny. Any time one questions or even in the slightest degree opposes the equality cult and its tenets, namely that 'all men (women and other bipedal, sentient lifeforms) are equal' and must be equalized they will meet with this passive aggressive means of censoring that dissident.

By saying 'peace' according to the discourse of the cabal and its semantics this means anyone not complying with the demands of the equality cult, that which flies under the banner of 'peace', will be portrayed as a terrorist and 'shut down' from any such opposition even to the extent of their termination. Yet further, to the extent of the termination of everything related to their inner being (family; race; culture, etc.) which will then be associated with the antithesis of peace, ie 'violence'.

Thus 'peace'; is achieved through maximal force, meaning deadly force through the 'piece' of the gun. What is construed as 'reasonable force' is simply the implementation of force which purports to give the targeted 'violateur' of 'the peace' a chance to cease their violation. The absurdity of the notion of 'reasonable force' lies in the fact of the construal of the target as a 'violateur' of 'the peace' which justifies, according to the discourse of the equality cult, the immediate usage of maximal force once the target can be acquired and placed into the crosshairs and constituting a 'justification' for the imposition of this deadly force against the target.

Beyond this the gangstalking is utilized (the 'community policing' tactics of state sponsored terrorism and perpetual low grade harassment of targets) to impose what is deemed 'reasonable force' against the target and which itself amounts to ultraviolence just as in the case of the 'normal' forms of policing.

Thus it can be seen that anyone not complying with whatever the cabal calls 'peace' is immediately portrayed as violent and what is termed 'peace' by the cabal is anything the cabal says that nullifies any power possessed by the population.

Any form of independence from the pantheistic panopticon of Zion is portrayed as 'harmful' or 'violent': from the possession of independent farmland and self-sufficient prepper-style living to the usage of any form of communication which calls into question the cabal and its operations or does not genuflect before it as the absolute authority ('the kingdom of heaven upon earth').

Any form of power be it a 'piece' in the hand of a 'citizen' (a gun or personal defensive weapon, the Traditional mark of a freeman) or a woodstove for heat and the meaning of these possessions (detachment from the system-a means to live independently of the mass and to avoid being drawn into the communist pit with the mass) and the forms of knowledge that derive from an authentic spirituality based upon Tradition-this especially the jews wish to eliminate as competition for their power. This as knowledge (in the sense of gnosis) is power and it is that which most threatens the cabal in its power which power is based on deception and the concealment of Truth and a consequent monopoly on power for themselves and to the exclusion of all else.

Such a 'peace' is in reality the cessation of all vitality and struggle. For it to be achieved (an anti-achievement, as a mere negation of the creativity of the Creator and the destruction of the Creator through the destruction of his Creativity) is to bring about a sterility of the mind, the achievement of a total zombification of the populace. This is the inevitable result of sovietization which is equivalent to christianization as both are merely two sides of the same coin (christianity being "the grandmother of Bolshevism" as Oswald Spengler said).

To subvert freedom of consciousness through subverting freedom of expression is to set up conditions for the destruction of society as it requires an uninhibited creative drive as its motor force without which it would cease to exist. Thus achieving what is called 'peace' in the sense of a covert suppression of the will through censorship is to achieve a gravestone of an uncreative 'nation' which is no longer a nation as it lacks completely the motor force of genius which enables any sustainable society.

That the cabal understands that the naturally creative aryan man will seek to rebel against any restrictions placed upon his mind and that to allow himself to be yoked is to bring about the negation of his very being as a Creator-hence his rebellion is met preemptively by the jews' 'piece' in the form of the guns of the police and military forces as mechanism of castration of the rebellion of the aryan man, attempting to 'nip it in the bud' so to speak and to subjugate any of the rebellious tendencies of the aryan man.

This is when the usage of punitive psychiatry and the 'helping disciplines' enter onto the scene and are imposed against anyone critical of the state who is *eo ipso* portrayed as 'violating the peace' by virtue of his rebellious behavior, rhetoric, etc. Anyone acting in such a way will have various spies and rats in 'the community' inform against them to the police and from thence an investigation will ensue into the person. Rumor campaigns orchestrated by the jews and their apparatchiks and the establishment or construction of the target's identity as 'dangerous and unstable' will be undergone with the ultimate objective being the forced institutionalization of the individual.

From thence their termination either through forced drugging or through advanced weapons such as microwave or particle beam or the simple poisoning of their food, water or air (with such a black mold; glyphosate, etc.) will be undergone.

At the least if they escape with their lives they are discredited in the eyes of all and sundry having been forcibly institutionalized and thus will have their message falsely associated with mental illness and/or the implicit potentiality latent in such a diagnosis or act of institutionalization of 'violence', i.e. a disturbance of the 'peace'.

In the end the only peace that can ever be attained as the jewish occupation government itself proves is that obtained through a 'piece', i.e. a gun, a credible threat of deadly force. The cabal wished to employ their propaganda apparatus to portray the possession of any form of potential counter violence to its violence, its usage of deadly force against the 'citizens' under the color of right, as violence itself.

Simply for a 'citizen' to possess the most meager implements of self-defense (and purely defensive) such as body armor or plexiglass shields or similar articles are construed as 'violent' and 'illegal', that is to say a 'disturbance of the peace'. This is ultimately the cabal's goal.

Though it is not as of the time of this writing a global phenomenon as yet such is ultimately the end goal: to transform swords of any variety into the ploughshares of wage slavery so that the jews can continue to suck to the point of drawing blood the 'milk of the gentiles' as the old testament says.

'Peace' thus means the complete and utter castration of 'the gentiles' by the jews who simultaneously would seek to accrue to themselves a monopoly on force so that none may call it 'conspiracy' or even to question that the powers and principalities which style themselves 'godly' are indeed not something diabolical and in reality the evil of the earth. The 'peace' of Zion is the 'piece' of bloodshed and sinister rites of diabolism. The only 'peace' one receives through its praxis of thanatos is resting in peace in the grave.

The particular instances of what style themselves 'peace' can be reduced to this:

- 1) the disempowerment and genocide of aryan and
- 2) the relative and simultaneous empowerment of jews and to the extent necessary to justify:
 - 1) the empowerment of non-aryans especially those who are servants of the jews in their churches though the alternative leftist non-whites are in some ways more useful in the deliberate destruction of aryan society by jews and thus serve as cannon fodder.

The 'peace' of non-white immigration by which the jews mean in their justification of their continual influx into aryan created society the prohibition of any criticism by law of the presence thereof and/or the granting of special privileges thereto (reduced jail sentences; favoritism in hiring and free economic handouts, etc.).

Anyone seeking to obstruct these policies is portrayed as the embodiment of ultraviolence, 'grossly offensive', carrying out conduct meriting the strictest penalties, failure to comply with which amounting to meriting the death penalty for a failed 'sin expiation' of the ultimate sin of 'racism' which translates into anyone aryan affirming their own existence and opposing their own displacement and genocide.

'Peace' is the emotive word which disengages the rational brain and which is utilized in the discourse of power as means of shutting down thought and action based thereon (based upon a prudent opposition to the genocide agenda) through activating the emotional brain, shifting the center of consciousness away from the higher forms of mentation and towards the instability of the emotions which necessarily exhaust themselves in their lack of fixity.

References to 'peace' are references to self-extinction which is the death cults' morbid morality of conditioning through this emotive discourse the broad mass of 'goyim' to lay down and acquiesce to their own displacement from the former Elysium of a harmonious world of the aryan into the grave of their non-being, 'resting in peace'. The jew cries crocodile tears as he pronounces his sermon of the dead over the aryan race and cries out to his demonic god: "Oi! Oi! Oi!-Peace!".

This of course should the jew be able to get to that point through his artful guile and cunning manipulation. It is up to the aryan to oppose the jew and to center his consciousness in the higher mind of suprarational intuition (intellection) and reason and to 'act without acting', without being affected by the empty emotive rhetoric of tear-stained pacifism, but nonetheless to acknowledge what it is and how it is used to effect the jews' purposes as means of achieving the subjugation by stealth and indirectly of the 'goyim'. The rhetoric of 'peace' is the discourse of power that is the basis of jewish mind control and world control.

Psychopolitics 101

Under the current regime the modality of its politics is based on false dichotomies which function as a mechanism of sowing and creating divisions amongst the population. Polarization is the technique of unifying the mass under the control of the system, turning its pent-up aggression upon that which the system seeks to eliminate as it perceives it as a threat to its power-the enemy 'Other'.

Those who are not assimilated into the collective as yet another node in the system are targeted for destruction should they not be assimilable. The conditions of their assimilability are their weakness of will emanating from their own egocentric self regard-regard for the lower self, the mayavic self and failure through inadequate spiritual development and power to transcend the false self and to serve their own organic collective if need be in opposition to the inorganic/artificial collective of the state.

Under the collectivist despotism of the jew world order the mechanics of the despotism are necessarily antagonistic to the organic collective and thus anyone who is not of a sickly constitution, anyone of healthy mind (in a spiritual sense, having a regard for the preservation of their own collective racial soul of which they are a part) will be targeted by the system and its agents, official and unofficial, for termination at the behest of those archontic shepherd kings who control the system and who determine after gathering intel on the target that the latter is incorrigible, ie, unassimilable into the collective hive mind; is a resister who seeks to rebel against the system and its inherently genocidal policies against any distinct collective.

This divide and conquer technique is a necessary element of the totalitarian system-all must be One and none can exist outside of the Whole ('Humanity'; 'God'; 'Love'; 'Peace'; 'Equality'; 'Oneness').

Whether it be in the form of pantheistic naturalism or some variety of monotheism the form in general is universalistic 'oneness' wherein everything and everyone must be merely a 'reflection reflecting'; a mere element in the system of elements, a federation of identityless monads who are juxtaposed within the system according to the algorithms and blueprints designed by the priestly caste architects of destruction.

Such a system of course inevitably defaults to self-destruction through unsustainability, collapses in upon itself in entropy and thus is a system that can be characterized by the phrase 'being unto death' in Heidegger's terms. Hence the inevitable outcome of peace is death, the cessation of all vitality.

Vitality is based upon dynamism, upon each organism seeking to enrich itself as the *conditio sine qua non* of its being-all life is struggle and competition over resources (the conditions of the being of the organism: that which enables it to survive, expand and advance its being necessarily in opposition to others which seek to advance theirs through the acquisition of these same resources).

Should these resources be amplified such as eg. the genetic modification of the food supply to enable the procreation of teeming multitudes beyond sustainable limits (limits of growth) the consequences being the degradation unto death (over time the gradual diminution of health, the pollution of the atmosphere; depletion of the soil of nutrients, etc.) of the organism.

Such is the absurdity of the egalitarian-pacifist worldview (be it christian or liberal) it is all nonetheless a recipe for suicide and wholesale genocide through working against the laws of Spirit and matter both, as attempting to do the impossible hubristically is to precipitate the self-destruction of the system as a house of cards inevitably doomed to fall through its inherent weakness.

The absurd attempt to reconcile opposites in a *conjunctiva oppositorum* is doomed from the beginning as the perverse amalgamation of diverse kinds creates no stronger but a weaker organism that pollutes its blood and precipitates a gradual dysfunctionality in the organism (both spiritually and materially) that leads to an entropic collapsing in on itself through lack of compatibility of its diverse and antagonistic elements, that warring of diverse forces that bring about the destruction of the organism through inharmony (cacophony) which manifests itself outwardly in what is called 'crime'-'cacophonous' behavior, ie. not harmonizing with the Sum Total as not preserving the differences conducive to dynamism which in turn enable the perpetuation of a System and its vital striving, lack of conflict, lack of challenges leads to decadence and death.

The psychopolitics of the system imposed upon itself and all of those outside itself operate through this attempted synthesis of opposites: a dialectic of destruction which purports to be a creation of a new synthesis but which in reality is merely the creation of an irredeemable collapse of civilization as no such civilization has ever existed nor could ever expect to exist given the inability of the organisms to sustain their vitality when juxtaposed with those organisms of radically distinct and incompatible types.

Nonetheless the despotic jew and his controllers (archons, call them what you will) who attempts the impossible simply bring about their own downfall like Icarus whose wings melt in the heat of the sun. The Solar-Uranian consciousness of the aryan alone can attain those heights and will do so once Icarus begins his descent towards the rocks below.

The artful guile of the jew which is a behavioral projection of his lunar-feminine -telluric consciousness has thus far been employed as a weapon against the aryan organism-the collective consciousness of aryan 'mankind' (the only mankind-'manas' deriving from the sanskrit word for 'mind') being the only possessors of that higher consciousness, buddhi-manas call it what you will-godmind, the mind of the gods which can attain that level and dimension of being and understand the distinction between Truth and falsehood.

They act in accordance with Truth for the survival, expansion and advancement of their own kind and the creation of greater overall harmony on earth and in the heavens-justice, the preservation of differentiated order in opposition to the undifferentiated chaos of the psycho-politics of the system and its antagonism to universal order while purporting to orient itself towards the creation of order-an order of jewish despotism wherein all are one under the thumb of the jew who stands above all brandishing an iron rod in his fist). Such a world, as envisioned by the jews, must come to an end else all that matters will come to an end, that being the white race and aryan mankind.

Zion Asylum

Today's world is reminiscent of an insane asylum: those who control it are insane (*non compus mentus*); are fanatically obsessed with creating a global slave population over which they can be the rulers and all else are reduced to a state of slavery in a mongrelized amalgam of so-called '*humanitas*'. '*Humanitas*' is not however '*veritas*' (contrary to the claims that 'all are one', ie. equal) and the attempt to collapse the distinction between dissimilar things is a failure from the beginning as that which is distinct cannot be collapsed into that which is another distinct vital form but would simply be collapsed into a grave of dead forms ('die-versity' in other words).

The goyim masses are reduced through trauma-based mind control to a state of insanity and are thus established as representatives of normality-the 'new normal' which is superimposed upon all and sundry (all being equal and thus being subject to the standard that had been engineered into being via social engineering and which has become the acceptable standard).

The mind of the shepherd king priestly caste is extrapolated and imposed upon the mass through the organs of information that are in the hands of the priestly caste (the pharisees and scribes in the media and academic system). Thus the mental illness/insanity of the ruling class has a trickle down effect percolating in the minds of the goyim at all points in time throughout their incarnation-presumably even ante-natally in the womb via the transmission of radio waves that hinder and modify the development of the fetus and subsequent other means of the disruption of homeostasis and healthy development which retards the development of the brain, etc. (via vaccinations; malnutrition, etc.).

As an almost necessary consequence the population of 'Zion' are converted into zombified robot slaves who are incapable of thinking independently of their programming and instead can only undergo reactive brain processes and reflex actions of consciousness that render them merely automata, nodes in the system and who react according to the 'propaganda de jour' according to their so-called 'education and training', ie. classical conditioning.

The Zion asylum represents itself as the arbiter of Truth and Justice and is in reality the antithesis of Truth and Justice being merely a control mechanism for the reification of jewish supremacy according to their self-scribed 'dominion mandate'.

Whereby they certify themselves in godlike fashion as the arbiters of Truth and Justice-anything deviating from their misrepresentation being anathema maranatha, 'untruth/falsity' and 'injustice' or at the very least 'immorality' as running against their mongrelization globalist agenda.

Indeed, anyone deemed beyond the pale of jewish globalism is targeted for destruction, qualified as 'mentally ill' and framed as an enemy of the state. The insane asylum they are forced to dwell within turns against any of the inmates who recognize that the administrators are themselves mentally unsound (*non compus mentus*) and thus that the notion of mental soundness (health) certainly doesn't apply to them or any of their shabbos goyim but perhaps it does to themselves.

If so they had best find a way out of the asylum before they are subject to the influence of the administrators and fellow inmates who have the power to restrict their liberty and even destroy their soul through pharmaceutical drugs or more sinister weapons that masquerade as therapeutic modalities (particle beam or microwave weapons; electroshock therapy, vaccines, etc.).

The Zion insane asylum is the torture facility used by the judeo-masons to subject expendable 'human resources' to torture and slow murder, releasing the pain and fear energy into the aether which is then fed off by themselves and the vampire entities they are bound up with who they presumably call the 'elohim'/'sephardim', etc.

The insane asylum of Zion has an ulterior purpose most of all of the inmates fail to understand: that it is merely processing facility for souls to enable their vampirization by 'elohim' and by their physical-carnal instruments on the earth, the jews: a soul farm and butchery facility that enables the empowerment of its archontic controllers via demonic rites of ritual torture murder-the matrix of Zion.

The rulers who control it understand that they are enslaving the population and that they are committing a sin against the Spirit through facilitating the control mechanism which perpetuates itself in a downward spiraling death drive of entropy-closing in on itself through destroying the host off which it feeds.

The onus lies on the autonomous person to find the means of extricating himself from the matrix and ultimately tearing down the asylum itself, finding its self-destruction mechanism and flipping the switch.

'Nazi Narrative'

The jews have throughout history created boogey men that they impose upon others as a means of conscripting them into a unified collective that they can play off against this boogeyman which is the 'enemy', the 'Other'. This 'Other' need not be and in most cases isn't an actual real being but is typically a fictional construct that jew have invented: the devil/satan; nazis, etc. the contemporary 'sinner'; 'heretic'; 'witch' (he who traffics with or is the embodiment of all of that which is undesirable or bad) is the so-called 'racist'.

This is defined as any aryan person who affirms that they exist as a distinct ethnic group and that has no willingness to precipitate (and even if they do) their own destruction as a collective group.

Thus any aryan person unwilling to destroy their own people's lives (genocide) and ultimately their own life (suicide) is targeted as the embodiment of evil on the earth and slated for destruction. Thus to attempt to defend one's territory and to oppose foreign invasion by the non-aryan 'Other' is in the jew's system of lies, a 'sin' and constitutes a 'moral transgression'-a transgression of the jew's standards, which entail the annihilation of the aryan race as a 'moral imperative'.

The 'nazi' narrative the jews have contrived in their media is simply a re-presentation of the witch narrative from the middle ages-the persecution and perpetual hunting of the enemy by the collective who is unified over and against this 'Other' as its 'morally superior' witch hunters.

This serves the jews' mongrelization agenda of destroying the aryan by:

- 1) vilifying the aryan who assert themselves and stand up to the jewish evil (evil being conventionally defined as that which is harmful to an 'other'-at least as viewed from the perspective of the 'Other'; perhaps 'bad' or simply 'undesirable' would be a better term) and
- 2) on that basis imposing upon the population a 'moral obligation' to condemn and ultimately to kill the 'Other', he who has his character constructed as 'nazi', the embodiment of that which is undesirable and carries with it the moral/praxiological imperative 'to be killed' just as a noxious insect or harmful predatorial animal is killed by a farmer's housewife so as to prevent it contaminating her child with venom or rabies.

Such is the creation of false associations between that which is an objective reality (white men and whites in general) and a fictional simulacrum which is scribed or predicated to that object (hate; violence, etc.). Thus the jew has employed this tactic and continues to do so in seeking to facilitate his genocide agenda setting up the white man for the kill, creating genocidal conditions through the construction of his identity as a 'white devil'.

This works not simply through the contemporary narratives of jewish pseudo-scholarship in the academic system and media but through a representation as aforesaid of the christian-Abrahamic narrative of aryan in the role of 'nephilim/satan' which seeds into the consciousness of the non-aryan and aryan christians the notion that aryan are the embodiment of evil, are not 'human beings' but rather creatures who: 1) pose a threat to those not aryan and accordingly 2) must be exterminated, ie. genocided through any and all means.

The new age propaganda also parallels this vilification narrative on the secular side portraying aryan as reptilian demons (aka. nephilim). This is more demoralization of the aryan population as a means of weakening their will and deteriorating their sense of self such that they are more effectively dispatched by the non-aryan hordes and the more lunatic fringe of anti-aryan aryan (christians; liberals, etc.).

The jews' *modus operandi* works by wearing away at the fringes and moving towards the center: like a wood cutter sawing a tree from both sides-ultimately the center is cut through or nearly through and the center is torn asunder by the weight of the falling tree of the race, bringing down the whole to be cut up and served up for the jews to exploit as a mere commodity (genetic vampirism).

The 'nazi' narrative works in conjunction with the 'nephilim' and 'reptilian' narratives across all varieties of ideology manufactured by jews in their think tanks and by their funded operatives (scribes) who scribe their fictional narratives as a weapon of war against their enemy: poisoned baits which they leave out for the aryan to partake of and which have within them addictive properties that continue to poison the consciousness of the aryan.

These narratives or egregores become the programming of the aryan population which then loses their own autonomous consciousness and simply replicates itself and conditions them in certain built-in ways both in terms of their thought patterns and in terms of their correlative actions.

The conspiracy of the jew works as the communist jew Selenkov spoke of in 1922: "we will make racialism a dirty word"-getting aryan to associate regard for their identity with that which is wholly unacceptable and that which is intolerable to society. Thus, the logic follows that if one wishes to be a member of society they must condemn all of that which affirms or espouses or is related to 'racialism', ie. 'racism' as the ultimate sin.

This ensures to a great extent that aryan are hamstrung in their defense through shaming, guilt tripping and demoralization such that aryan are rendered happy little lambs of the jewish god-gelded cuckolds and stupid slaves who have no purpose in life but to serve 'humanity', meaning jews and their savage hordes they bring in to replace the aryan population.

The 'nazi narrative' is yet another propaganda campaign of vilification that constitutes a weapon of war, of social engineering the jew employs in his intended destruction of the aryan race.

A new narrative thus needs to be constructed not only to counter this but to posit a more affirmative alternative and this is the narrative of jewish supremacism and, in its positive aspect, of aryan morality, aryan Goodman, the embodiment of the gods in contradistinction to that of the rotten egg of history, the jew.

This narrative coincides with Truth and would, ideally if it were carried forward skillfully enough, banish the darkness of ignorance the jew has blanketed the earth with over the millenia. Of course the difficulty lies in being heard amidst the din the jew has created in his propaganda mill and repeated *ad nauseum* in the consciousness of his slave class. Once the aryan man is silenced he has only recourse to alternative means of communication, laying the pen aside he must take up the sword.

'Humanity': A Fictional Concept

The notion of humanity has been enshrined in the priestly caste discourse of the Jewish occupation government as the sacrosanct fundamental principle on which all others are based—take this lynch pin away and the crazy train of Zion falls to ruins. The Jews however intend that the system fall apart on the basis of this premise so that they can establish their global despotism with themselves as unchecked rulers over the earth, as the only 'humans' on earth.

The current phase of the implementation of their protocols entails convincing the Aryans that the Jews' humanistic egalitarian dogma is a sacred cow and having a moral imperative of being unquestionable and that which must be worshipped and circumambulated around and can never be a matter of doubt or ignored or not be lauded as the most important and essential purpose of the life of all and sundry who are called humans (all 'bipedal entities' who bear the appellation 'human' in contemporary parlance. This term is designed by the Jews as a semantic mechanism of unifying the disparate bipedal biological beings they wish to mongrelize together into one mass of easily controllable 'goyim').

That this 'human' concept is merely an abstract idea and has no concrete biological being (metaphorically and physically) will be discussed in broad outline in the following discussion. The ancient Polarian epoch which was the period of the initial presence upon this earth of the Aryan Divyas (gods) was located in what is now called the North Pole.

This led to the metamorphosis via involution ('the fall of man') of these beings into the pure Aryans who then existed in and around that same geographical area in physical reality which became known as 'Hyperborea' to the Greeks ('beyond the borders', alluding to the far North, arctic region of the planet Gaia/Earth).

These Aryans then migrated outward from thence, towards the East in what was called 'Gobland' or the Gobi desert civilization in the modern region of the Gobi desert in Western China and surrounding areas (the Tocharian peoples, the Scythian peoples who further radiated outwards into the far and Near East forming the colonies of Sumeria and Egypt (Berber people), India (Bahustan) and in the Americas Teochuanaku, Machu Picchu; Easter Island and surrounding regions.

The resulting mixtures as Jorg Ians von Leibenfels speaks of between the Aryans and the anthropoid entities living in the Near East and in other areas led to the current black and brown stock who populate those areas which now bear the name 'India', 'Africa'; 'The Middle East', etc. These cultural enclaves are now merely the relics of a degenerated population whose culture has been distorted and perverted such that they are no longer recognizable from their previous origins and are thus merely inauthentic forms of Aryan existence and thus are in no wise compatible with the purer remnants of the Aryan population of this day.

At best they contain, buried as it were in the rubble of history the redeemable germs of what may be represented as an authentic Aryan culture—like mining gold from the earth and refining it of its base metal and rocky encrustation.

The non-whites who are the custodians of the documents of the aryan (of the ancient manuscripts and of the symbol and ritual that have to only a faint extent been preserved) are merely fulfilling their duty to the Good, to preserve the remains of their antecedent traditions and receiving their Dharmic reward to the extent they are upholding their duty to the gods.

They have then fulfilled their duty and may pass on and reincarnate in whatever form depending upon the condition of their enlightenment (of the quality and caliber of mind). From thence the remnants globally may develop themselves into as pure a distillate of their ancestors as possible and attain a perfect state of being, purging themselves of the dross of their involuted forms and attaining the diamond thunderbolt body of immortal vajra.

The other non-whites who uphold this spiritualization process, who facilitate it and who harmonize with its coming to pass will receive their just reward and live out their lives harmoniously in the area of the earth they are suited to. Those who violate this duty will be laid aside and receive their just reward: the punishment fitting the crime, and go the way of all flesh.

The black and browns are a hybridized creature who is hybridized with anthropoid entities over the course of millenia and the original aryan who interbred with them (the sons of god coming into the daughters of men-Eva, Eve, the non-whites females).

Thus the term 'human' is seen as an absurdity as the paleo-history of the world and the aryan race belie any common ancestry or origin save through a bastardization of different types and subsequent mixtures of relatively degraded life forms who have lost their higher faculties through such miscegenation.

This miscegenation is the original sin, the interspecial interbreeding that occurred over the millenia and especially the original mixture which led to the degradation of the higher type and a diminution and in some cases the extinction of its higher faculties whose physical concretions are the pineal gland and pituitary body.

This is the materialization of the Spirit, a satanic fall of man and the duty of all is to Spiritualize the material plane as a means of overcoming the entropy of the cycles of Time, of the continual degradation through mixture of Spirit into ever more degraded forms of incarnate souls, their vehicles no longer playing host to higher souls as no longer possessing the physical structures in their adequate condition of purity to enable the expression of the soul on the material plane.

Thus in order to qualify as 'human'(meaning 'spirit man') one must cultivate his True Self through the activation of these glands and through their exercise-through spiritual exercises. These are available only to the pure as they alone can 'see the light', can gain access to the higher states of being and thus are able to utilize these structures which may indeed be a complete absence in some of the non-whites especially in those of the lowest grade, the blackest of the lot, those who are closest to the anthropoids with whom the aryan bred and/or used as a source of gene splicing paleo-historically.

'Humanity' today is a concept which is a political weapon employed by the jews as a means of manipulating aryan and convincing them that they are not a special people, above the beastmen with whom they share no common origin.

What is called 'evolution' both in physical and theosophical terms is a discourse created by jews as a means of deceiving aryan into thinking that their own preservation and development has no meaning and further in the case of both, that there lies in each the moral imperative to sabotage and destroy their own kind (those who alone are capable of 'humanity' and attaining the spiritual state of perfection we might call 'aryan') in the name of this 'Good' which is good only for the jew and this only temporarily as the jew would inevitably destroy civilization through his inherently control freakish and self-serving nature.

Thus the so-called 'evolution' of what is falsely called 'humanity' today is in reality merely the devolution of aryan mankind ('man' being derived from the sanskrit term 'manas' connoting 'mind').

The jews intend the genocide of the aryan race as the latter are the only threat to the tyranny of the jewish despots. These latter are genetically engineered creatures a composite of neanderthals and reptilian aliens who ruled over ancient Lemuria the now sunken continent.

These beings, the jews, are a hybridized mixture who are possessed and controlled by infernal entities who dwell in innerspace between the third and fourth dimension called 'archons' in gnostic parlance and reptilians by such as David Icke.

Their genetical-demonic stock contains within itself the DNST-3 gene (scizophrenia gene) which enables possession by these entities and which is why the jews adhere to a specialized formula of interbreeding such that this genetical-demonic template is preserved enabling the continuance of the jew as a physical instrument of these archontic entities.

Human they are not but rather the term 'subhuman' and indeed 'infernal' is most appropriate in discussion of these creatures. They can only proliferate themselves and there is no possibility of assimilation as to assimilate is to merely spread the genes and contagion that inheres within them. To banish them to another region may be a possibility should they have a willingness to leave (which they would presumably not) and would it be possible to force them to leave (they are concealed amidst the mixed multitude in all white 'multiculturalist' societies).

Thus they will need to be forced to leave (it would be impossible for them to stay as they would simply sabotage the nation and its people as the archontic entities which control them are the main cause of their action and thus they would override the jew's comparatively feeble will). Thus no assimilation or relocation is possible and thus only one alternative remains so that 'hue-man-i-ty' in its proper sense may continue on the earth and fulfill its proper destiny namely the spiritualization of the material plane and the nihilation of the forces of darkness which seek to snuff out the light.

Plausible Deniability

In today's modern/postmodern society plausible deniability is a necessity for all parties, those who are rivals and affiliates, given their conflicting interests, divergent purposes and the plethora of lower egoic beings whose life centers around self-seeking. The reason for this being that to be a known quantity in the eyes of enemies (those whose interests irreconcilably conflict with one's own) is to render one's interests vulnerable to the negative influence they exert and to jeopardize the realization of one's project and purposes.

Accordingly one and his purposes cannot be made an object/subject of knowledge to an enemy as this is so to speak to lay one's cards before them and to bring about self-defeat. Thus he must act strategically in such a way that his actions could be interpreted by the enemy or by a reasonable third party in more than one way, or in a way that isn't the reality or not susceptible of interpretation by those 'Other' to himself and his kind.

'When' backed into a corner' or 'put on the hot seat', exposed or interrogated by word or deed by the enemy he will be able to avoid being identified by the enemy such that he will increase the probability of gaining the victory.

In cases of judicial entanglements he must needs establish himself in a position of the impenetrable, the least suspicious and the most bland and average thus minimizing or reducing the probability of punishment or a disruption of his privacy or activities. The 'grey man strategy' is the means through which one carries on under the panoptic vision of J.O.G.

Of course one might develop a persona created deliberately for consumption by the 'popular man' in the street or the plains clothes detective, the secret operatives and spies of J.O.G who perpetually ring him round and attempt to examine him for threats to the system; such a persona could be to adopt the dress and behavioral mannerism and jargon (syntax; colloquialisms; figures of speech, etc.) that clothe him with the facade or mask of normalcy thereby enabling him to ingratiate himself with the broad masses.

Thus his true persona is as it were masked behind the face of the crowd, the undifferentiated multitude who lives 'in time', in vanity staring into their vanity mirror for the vain hour of their life's course. The danger of attempting to blend into the crowd in today's decadent age of course lies in the fact that one would still stand out as an anomaly given the abnormal norm which constitutes a significant presence even amidst the kaleidoscope of shapes, sizes and colors of the 'undifferentiated /differentiated multitude.

Nonetheless there is a broad enough cross section of society that a grey man strategy may be adopted, indeed one doesn't have a choice should he value his skin. In terms of physical appearance the use of fake tattoos; of false piercings; facial hair; temporary hair dyes; wigs; spray tan et.al could be employed; in terms of behavior and mannerisms taking acting classes if one is not already a proficient liar would be a necessary recourse in order to establish the smokescreen of 'plausible deniability'.

Of course deliberately failing to represent oneself as he is is a lie-but to different parties he might reveal and conceal different aspects of his persona in the name of prudence. Hence he is not lying but merely presenting different aspects of himself that serve the greater good. Whether one is lying or not is itself a matter of plausible deniability and he must needs consult his 'conscience' for an answer. As to the 'Other', whether it serves the good to support the 'Other' even if only feigningly, as another act in the theater of the real, this itself must be taken into account.

Further to the notion of the imperative for concealment and the creation of an appearance, a mayavic veil behind which is hidden the reality that must not be revealed to the enemy manifests itself in enumerable forms. Examples are the concealment of one's address through representing himself to the enemy as residing in a different place; as possessing minimal wealth in the case that one wishes to conceal his power inherent in financial means or to represent oneself as possessed of these means so as to threaten the enemy with his implied status and connections; as being weaker or stronger physically or epistemically depending on the case; towards a strong foe relying upon a 'possum pose' as an instrumental means of persuading the enemy if he be so inclined to relax his defenses or reduce the vigor of his assault; or to represent oneself as a credible threat through a display (amplified or no) of his power to deter the foe who would otherwise be inclined to take advantage of his greater strength and to crush the enemy.

Covert weapons are consistent with the plausible deniability creed: carrying a chain attached to keys loosely attached to a belt and employed as a chain whip; a concealed cane or pen knife or pen gun; steel toed shoes; knives or firearms concealed under clothes; all such physical devices having their most significant counterpart in the mind, it being the ultimate weapon from out of which all others develop.

Ostracism

In ancient Greece the city states would give the 'ostraka' to those who were deemed unsuited by the city's members to live in the society and this 'token' or 'ostraka' (deriving from the Greek word 'oyster shell' upon which the name of the person was written who the society wanted banished), was placed into a pile and the person with the most votes was cast out of society.

Such is the nature of all democracies in their true form and from their inception and thus necessarily so, as the nature of democracy is as Ben Franklin said: "The vilest form of government" and as Aristotle said: "little more than "mob rule". As then so today and yet today it is even more insidious with the facade of any direct influence on the political process and indeed could never be anything but that on a large scale as all large population societies are necessarily undemocratic in the classical sense as they could never be an expression of the will of the people. This because the contents of consciousness of 'the people' is simply inculcated in the minds by the jewish controlled media, education-indoctrination system and indeed all organs of information such that the 'hive mind' of modern democracy is nothing but a simulacrum, a construct of jewish programming.

At the time of classical democracy only free men had votes and they amounted to a handful of thousand at most-slavery flourished and females had separate quarters and no rights. Democracy then still failed as all decision-making power was fragmented amongst multiple parties and from there combines and factions were formed (similar to the political parties of today) and tore apart their own society, siding with foreign interests and leading to a collapse. Thus democracy under any form is nothing but despotism ruled by treachery and deceit and the consciousness of the masses is not unified under a higher idea (as in the organic state idea of Julius Evola) and under the will of a higher man (Duce; Fuhrer).

As to ostracism and the ostraka of modernity it comes in the form of the smear and slander campaigns of jewry which are designed to undermine and sabotage all of those they perceive to be a threat to their power and thus who they vilify in the minds of the masses as means of preemptively striking against their enemies.

Ostracism comes in the form of stigmatization, of the mark of cain branded upon the forehead of the 'Other', he who is not-self, who is not a subscriber to egalitarian pacifist globalism, the globo-homo monocult of Zion in its leftwing form of communitarianism is its right wing of zionism.

Those who are not carbon copy fags and freaks who have a completely effeminized character are shunned, condemned and shut out of society as the monstrous 'Other'.

Ostracism comes in the form of soft power-cancel culture (censorship with the threat of jail and jobloss); shunning behavior so that one is rendered a pariah of society and is unable to play any role within the context of society in any way either through occupation or some form of non- employment group collective action.

He is shunned and indeed outlawed not having the protection of the law and yet being subject to the law, having only the brunt of the law brought against him in the form of the iron heel but not having any recourse to defend himself against it or any of those who have its protection (non-aryans; jews; females; fags; race traitors, etc.) and who can in their characteristically cowardly manner conceal themselves behind it as school children hiding behind the petticoats of a school marm. Such is democracy in its true form and at its finest-the facade, the smiling mask, of 'freedom' and 'love', etc. but in reality the club and the jail cell and worse.

Bullshit Tango

The jewish occupation government operates on the basis of deceit and codifies the cultural form of jewish dialectics ('pilpul'-lying to cover lies) in its education and training of its minions so that all agents of government become de facto jews or judaized gentiles in terms of their interrelations with the proletarian mass of 'workers', the 'civvies' as many of the apparatchiks arrogantly and condescendingly refer to them.

The dialectical relationship between state and population is governed by the 'pilpul' behavior of the jew having a trickled down effect from the overlord oligarchs to their subordinates in the system, all being tainted by the jewish influence. The lies of government agents come in the form of an interrogative discourse of question and answer when they are dealing with the public in a relationship of aggression, of attempting to establish the 'civvie' as liable for whatever obligation or commitment.

It is a dialectical process of the government agent, 'leading the conversation' and to 'get the civvie to talk'. This in accordance with conventional forms of behavioral norms of conversation and human interactions as established by the system through its propaganda and information bureau (akadumbia). Those who 'refuse to play the game' of 'everyday normal conversation' with government agents are qualified as potentially 'mentally ill' as constructed in their identity by the government agent for violating the hypocritical norms of social convention.

Thus the civvie is obligated to speak unless they can be as reserved as possible in accordance with social convention which still necessitates a pertinent response on the part of the 'civvie' to questions and communicative acts put forth by the government agent (ie. facial gestures; tone, etc.).

In the case of the 'civvie' needing to undergo some bureaucratic process this immediately puts them in a position of relative inferiority, of lack of power with the government agent having the power to either not assist them properly or to not assist them at all and this depending on their knowledge/power of the 'civvie'.

Should, eg. the 'civvie' not be aware of the obligations of the government agent the latter may pretend to not understand the request as the request was not made in the proper way or the agent may do only a half-assed job of carrying out their duties and send the 'civvie' or the paperwork or file of the 'civvie' to the next government agent who simply disappears into the faceless bureaucracy.

Such is the nature of an irresponsible democracy wherein all government agents work with one another unofficially to undermine those 'civvies' who are not useful slaves of the system and especially those who are a threat to the system. Thus the game of political hot potato is employed to transfer responsibility away from government agents in the immediate vicinity of the 'civvie' whether in physical presence or through anonymous virtual reality where the agent to whom responsibility is delegated can simply make yet further excuses for not fulfilling their duties according to their job description.

This dialectical game is used as a means of obfuscating the 'civvies' alleged right and denying the civvies a means to exist or to facilitate their own destiny within the system which is designed to tangle them up in a spider's web of bureaucratic red tape.

Any excuse that can be justified is put forward as means of:

- 1) exculpating the government agent of responsibility and blameworthiness and
- 2) transferring blame onto the 'civvie' or 'the system' itself or
- 3) denying the 'civvie' their alleged rights to a 'fair' (eg. 'trial'-or whatever other 'right' they are alleged to have).

The agents of government are conscripted into the bureaucratic spider's web based upon their own corruptibility, their susceptibility to corruption and from thence they are indoctrinated yet further, the more deviant and corrupt the higher and quicker they rise through the leaven of the pharisees their puppet masters. Things have gotten to the point that it is a systemic- derived cultural norm for people to be theater actors without any capacity for Truth who are merely self-seeking 'possessive individualists' completely severed from any healthy ties to their ancestral culture and their racial soul.

Loyalty is to the self first and to the system as necessary condition of self service wholly divorced from any loyalty to ones' own kind. The minions of the system, apparatchiks, recognize that they must adopt the hypocritical false behavior that is the necessary condition of participation within 'the system'.

In order to feed from the trough they must squeal like the rest of the 'goyim' and allow the jewish tax farmer to drain blood from their body and, when no longer useful to 'the system' to be cast into the slaughter house replaced by the next pig who eagerly lines up to the trough to derive their personal self-interest in the form of an abstraction called 'money', the wage of slavery.

In order to derive any advantage from the system one must adopt its behaviors, its obligations, and interiorize the rhetoric of 'the system' else they will be shut out and denied an ability to carry out even the most basic bureaucratic process and ultimately to even have the ability to protect themselves and secure basic needs let alone have the protection of the genocidal system which seeks to destroy them.

Those who are honest and decent people and not cowardly liars and backstabbers such as the christians and liberals are immediately scented out by the system via its web of apparatchiks and targeted for further ostracism, abuse and manipulation via the bullshit tango of being led around the bureaucratic dance floor in a confusing chaos of steps leading towards ones' disorientation and subjugation.

The ultimate conclusion is death via the termination of all ties to 'normal' life, to all of Maslow's 'hierarchy of needs' being held in bondage by 'the system' which views people (the goyim 'civvies') as puppets on strings being forced to dance about on the freemasonic checkerboard ballroom floor doing the bullshit tango being led by the wirepullers of the hidden hand of jewdeo masonry which simply leads them to the trapdoor over the abyss and into the lake of fire.

Those who are 'resistors', who are unwilling, indeed unable to support their own destruction-who perceive that the final destination of this 'pilpul' process is the bureaucratic red tape mummification of the living cadavers of the 'goyim'-animated only by greed and the desire for self-stimulation-seeking to oppose the system and understand that that is the only step in the 'right direction'-that being a confrontation with the system and its overthrow else a gradual slide into the abyss through the dance of death with the Zion spiders who lead one through this confusing process towards his destruction.

One must first have the capacity to discern Truth from lies as means of understanding the process and this requires courage to face the reality that there will be no 'normality' for those who are not drones of the system engineers. The system denies to all of those not useful tools in the system, all of those who are not able or willing to participate in the dance of death, those courageous enough to take a stand and face down the enemy and recognize the reality of what is beyond the illusion and what is not, penetrating the gauze of the spider's web and observing the spider's behind.

Spy Society (Intel Gathering)

The society of today is as that of yesterday and will always be under the yolk of semitic slavery. In the medieval ages it was a witch hunt in the most literal sense and in the society of today it exists in a more apparently sophisticated yet no less barbarous form: that of the hunt against 'racists' and 'terrorists' who become especially at the present time nearly equivalent, such that anyone (who is aryan) who espouses any values that are favorable for white people, is associated with 'terrorism' and is subject to the persecution of the witch hunt perpetual spying and observation on the part of the system and its agents both unofficial and official.

The spy society of this nature existed in the soviet union and perhaps even in earlier incarnations such as the Byzantine Empire and every other semitic society for the paranoid spy society mentality is inherent in jewry and is born of their neuroticism, itself a result of racial/special hybridization and the constitutional weakness that is bound up with jewry and other hither-asiatic near eastern stocks.

Potentially also their entities with whom they work play a role in the restructuring of their consciousness and create that neuroticism, perhaps even avatar their physical body and bind themselves to them and use them as a machine to spy on those whose soul they vampirize? Whatever the ultimate cause it is reasonable, indeed necessary, to conclude that all 'semites' in the popular sense of the hither- asiatic near eastern stock are spies by nature and all societies they infest will become negatively affected by their neurotic tension. Should those societies have the misfortune to be taken over by the semites (jews; arabs, etc.) they will transform into a spy society, as a reflection of the extrapolation of the semitic consciousness and its paranoid neuroticism that extends itself into the consciousness of the 'goyim' semitized society as a whole.

Living in such a society the populace are forever apprehensive, looking over their shoulder, spying on one another and ratting one another out for the merest pretext of perceived 'immorality' or 'transgression' of the society's egalitarian falsehoods it clothes itself in.

What is established unofficially as a spy network becomes official policy once the formal government can justify it via the democratic process, making the spy mentality legal and creating variations of the G.R.U and K.G.B to impose upon the slave class under the guise of giving them 'safety and security'.

The creation of false flag events traumatizes the masses and conditions them to acquiesce to endless limitations of the freedoms they previously had which they now have no memory of as the 'new normal' of the spy society has been imposed upon them and this to their detriment though to all appearances to their benefit.

Their life of illusion is a living in the matrix, a spy society panopticon metatronic hypercube that crystallizes their consciousness to exist merely within that set of limitations that keep them slaving and spying on one another and serving the jew who appears as their 'moral superior' benevolent leader who is merely 'one of the little people' and yet who is an instrument of the dark forces in their leading their slave class to perdition.

Anyone trying to break out of the matrix or to destroy it completely and liberate all is targeted and subject to harassment as means of either forcing them back in 'line' or exterminating them altogether.

Targeted Individuals (T.Is)

The J.O.G (jewish occupation government) seeks to place in its crosshairs those who refuse to bow themselves down as sheep to the system. They are the 'dissidents' which the system targets for destruction as they are the only existential threat thereto. The beastman can of course be bought with welfare and government jobs and thus they can be easily neutralized as potential opposition and, given that they don't have the Spirit of the gods within, they will necessarily be no threat to the jewish oligarchy who understands and is removed at a 'higher' level from their savage mind, though partaking in it through interspecial mongrelization and thus having a greater understanding of the beastman's savagery than the aryan.

It is the lack of that savage mind that at once distances and elevates aryan from that 'might is right' ferality that constitutes the hive mind of J.O.G and which renders them maladroit in understanding and anticipating its reactions towards them, they the aryan naively projecting upon non-aryans their consciousness.

It is this naivete which leads them to exercise inadequate prudence and caution in dealing with the J.O.G and renders them a mark placing them in the crosshairs of the system as a targeted individual. This individual is subject to police and military spying and intrusion into all alleged private communications which are private in name only.

Thus the psychology of the T.I (targeted individual) is that of paranoia-around them there are always spies and there is no privacy thereby, creating a mental state of ec-stasis ("going out of, or away from " in Greek) whereby the T.I loses a sense of security of the person and is perpetually in a fight or flight state fearing for his life and looking over his shoulder.

Thus he can never in this mental state have any individual free will or freedom of conscience as all thoughts are subject to intrusion at least '*in mente*' in his imaginal space. The mental unfreedom is compounded by the usage of synthetic telepathy and other forms of psychotronic mind control manipulation, implanting thoughts and emotions in the mind of the target. In such a state the T.I self sensors and regulates his conduct and thought patterns so as to maximize his survival potential regardless of whether there exists any actual detection of his thoughts, actions, etc. and thus becomes, through this constant pressure if he buckles under, a robotized soviet slave who operates according to the expectations and dictates of his oligarchical masters whose purpose this is.

Thus in the creation of a spy society there is the necessary condition of the standardization of the hive mind, of the creation of self-policing soviet untermenschen who regulate each other's behavior according to social engineering from above, according to the jewdeo-freemasonic blue prints which intend to form more bricks in the wall of Solomon's temple. Social targeting of potential dissidents is the J.O.G's method of social engineering the soviet mass through social compliance and all those who refuse to or cannot 'get along' with the communist party platform are placed into the crosshairs and, when deemed 'irredeemable' in their social sins and transgressions are then dispatched through whatever means (drugs; allopathic medicine; being stigmatized as a mental patient or outright assassinated in a fake suicide attempt, etc.). Thus if one is a targeted individual and was not paranoid before he would be well advised to cultivate a paranoid awareness to maximize his survival potential.

Oriental Despotism

The postmodern society of the jew world order is that of an oriental despotism-the jews ruling over all with arbitrary sway and without any checks and balances on their freedom of action such that whatever they want is whatever they get insofar as it exists within the realm of possibility and the confines of their vain imaginings as the old testament so well reveals (a world of materialistic decadence and opulence). 'Absolute rule' is the defining trait of a despotism and the jew, an oriental, what Robert Ley called "the pestilential miasma from the East" holds the reigns of power in his hairy fist.

The jew being an oriental qualifies the despotism as an 'oriental despotism' in the classical sense. In such a society there is a double standard: the law for the masses, the goyim ('cattle') in this case the noahide laws and one for themselves and their own kind, that based on the Talmud of babylon.

Regardless of the law's letter, the infernal spirit of the law the jews' seek to impose themselves upon the broad masses with their perpetually changing laws they manufacture in their sanhedrin amongst their rabbis such that the masses have little understanding of what the laws are and are permitted or prohibited from the same action from one minute to the next, the laws being ever more particular and restrictive, regulating every jot and tittle of the life of their serf caste.

Beyond the letters of the law exist the unofficial implementation of the infernal spirit of the law of the jews and their infernal masters (archons? call them what you will) which is enforced by the neurotic masses whose mind is shaped into whatever form the jews desire through the terrorism of legal and societal backlash-hence the slave class is entrained through classical conditioning (stimulus-a set of behaviors; response-despotic backlash by the conditioned masses who enforce their own enslavement) and the despotism perpetuates itself with arbitrary sway determined by the collective will of the sanhedrin.

Despotism's necessarily fragment and fall to ruin through crystallization-else they expand to unwieldy proportions and open up the empire to foreign backlash leading to the disintegration of their power centers through failing to have created an organic state or integral society that operates on the basis of a harmonious relationship between the totality of the parts who are enabled to have adequate liberty to preserve and advance their personal destiny in conjunction with the whole.

Only an organic state can maintain itself in the face of external threats as all of its elements act cohesively and seek to preserve their larger collective which in turn preserves them as the externalization of their collective consciousness.

The despotism, by contrast is a state of entropy held together only by brute force-all disparate factions-vying with one another for power against others-the stronger force overcoming the weaker forces and simply having its power offset by the others or negating the vitality of their being through reducing them to serfdom.

The iron bands which hold in check the chaotic forces of revolution and revolt against the despot only last so long before they are worn away and the whole flies apart in violent upheaval or simply exhausts itself through the jarring cacophony of its disparate factions. In order to develop an organic state out of a despotism, the despots(s) who constitute the power must be thrown out or destroyed. It is either this or the state leads itself to ruins.

The Sewer Of Demo-Crazy

Cloaca Gentium of post-modernity, the sewers of democracy bubble and stew with the stench of the mixed multitude. The jewish chefs add more ingredients to the stewpot, melted pot of ordure, stirring the pot and continuing to work up the mixture to a bubbling, rollicking boil with their golden spoons.

The fatted goyim are seated around the table of plasticized material, chained to their plastic seats by electromagnetic chains which are riveting them to their seat from headsets and rfid chips, nano tech implants and smart dust.

Their prozac smiles are twisted into a grin of eagerness as the jewish chefs activate their beastman slaves at the press of a button who then serve up the slops to the dumb goyim who eagerly lap up the putrescent goop into their fat jowled maws.

Such is democracy under the Jewish yolk-the pretense of a wonderful world of all of that which is good (the promise thereof; a promise never realized) and the receipt of a promissory note that is not redeemable at any credible institution, only the usury banks of Zion and this in the false coin of the realm.

The sewer of democracy is the society which is that of the sewer-all must be dragged down into the depths and none may ascend therefrom-the lowest common vermin constitutes the standard, meaning there are no standards and the vermin ensure that they tear down that which organically/ontologically is of greater caliber than themselves out of a jealous hatred for that which is superior to themselves.

Democracy is the death drive of the slave class manifesting their destiny-tearing down that which supercedes their lowly estate as means of ego gratification rather than a desire to ascend beyond themselves-having no desire or being organically inferior and incapable of even conceiving of that which exceeds their lowly estate.

Hence the term 'leveling equality', a *reductio ad absurdum* of the superior through the process of and justified by-the false premises of 'equality'; 'humanity'; 'love'; 'peace', etc. This as a mechanism of justifying the redistribution of the wealth from the creative and productive-those with capacity-to the useless and worthless-the uncreative, those without capacity.

Such is the nature of democracy, better spoken of as 'demon-crazy' as the untermenschen are dragged into hades, into the abyss by the dark forces which possess and influence their ever downward fall into material density and unto the negation of Spirit. The masses have what Baudrillard referred to as "the terminal madness of the end times", ie. the "sickness unto death" as Kierkegaard called it. The current of disintegration, the ever increasing densification of the organism (crystallization of Spirit into matter) and the extinction of the soul and its vampirization into the maw of these entities as energetic food. The principle of 'our' democracy is the lie that is an extrapolation of the organic lie of the Jew-a simulacrum of 'goodness'-a sugar coated poison pill that intoxicates the consciousness of the otherwise healthy reactions against the system of illusion should they have ever come to understand what is being done to them.

Thus the system of illusion is designed as a means of pacification, of neutralization, of any opposing power that might well up from the more conscious elements of the 'broad masses' or perhaps that might reach them or all of those capable of seeing the light from above. The system of illusion is designed to drag down into the depth the sun of mind, submerging it in the darkness of a system of slavery and vampirization.

Democracy is the feel good illusion-the theater of the real that has real consequences and consequences deleterious to the survival, expansion and advancement of the light of this world, the Aryan race, and the maintenance of all order on earth.

Democracy is thus, in the words of Aristotle: 'mob rule', the dysfunctional rule or lack thereof, of a mass of confused and cacophonous beings who have no direction or sense of where they are going or how they are going to get there but merely fall upon one another in the name of their self-interested egotism and necessary conflict of diverse motivation (the lowest motivations based upon the purely cthonic-tellurian orientation towards the sewers of savagery). Holding them up-if only for a time, is the hidden hand with its guy wire strings of at first gold, then electromagnetism, the fingers having intertwined these invisible strings into the souls of their slaves and thus hijacked their consciousness into their hive mind, like a camel driver or peddler steering the goyim towards their destination, that being usury and their destruction when no longer possessing any use value.

Democracy is thus the curtain which is pulled across the wizards of Zion (judeo-masonry) who manipulate the levers and press the buttons that transmit the electrical impulses and subtle occult forces that manipulate the minds of the 'voting cattle' of goyim who are forced to swallow the steaming goulash of the faecal matter gumbo of multikultism and this to the bursting point while they race on the treadmills of economic serfdom paying for their own execution-like a scene from the "Running Man". The figure running on the treadmill-the longer he survives the longer he lives the more money he makes and upon stopping he ceases to exist-such is the slave society of neo-liberal democracy.

Those who are not independent minded continue to race along the treadmill towards nowhere, understanding this is a necessary condition of their continued survival though what the purpose of their survival is given that it merely leads to their continued enslavement and degradation of their soul is a question. They live for the flesh and for a purely materialistic purpose, the circle of their life closing in on itself in entropy like a downward spiral, the 'sickness unto death'.

There are those however who have no willingness to go that route. These resisters who oppose this current of disintegration are they who the hidden hand wishes to snuff out and, rather than expose their iron fist by extracting it from the velvet glove and revealing their despotic nature they simply pull a few levers and twist a few knobs on their illusion machine and the masses have put before them the caricature of their enemy-who then becomes the monstrous 'Other' or enemy of the broad masses who is placed into the crosshairs so that the stupid goyim can tear asunder their 'enemy' in reality the only hope for salvation from the rapacious exploitation of the hidden hand and their own inevitable disintegration into the maw of the Demiurge.

Ideological P.I.S.S

The ideology of the bourgeois is that which could be ackronized as 'P.I.S.S': 'pacifistic; internationalist; sentimentalist; stupidity' or 'pacifist; internationalist; semitic sentimentalism'. This ideology derives from the Near East-the sewers of the Levant and the Chaldaen/Sabaen pantheistic naturalism which has infected the minds of the masses since its inception and was designed to achieve this purpose in its inception by the corrupt priestly caste.

The shepard king oligarchy wielding pastoral power over the 'flock' of bamboozled and low I.Q savages over whom they hold arbitrary sway constituted the model of oriental despotism that prevailed and has prevailed over the aryan society into which it had seeped as the sewage from the Levantine camel sty, contaminating the once pristine marble temples of the aryan of Rome and Greece.

This ideology has laid waste that which can properly be spoken of as 'aryan', that is to say 'noble' and supplanted it with the baseness of the shudra/chandal caste. 'P.I.S.S'-the creed embraced by both vaishya and sudra caste as means of destroying the nobility, the true aryan; the bourgeois (vishya-merchant caste) hypocritically and the sudra (serf caste) eagerly; as a mechanism of the political maintenance of power by the former and siege engine of power on the part of the latter.

'P.I.S.S' ackronizes the creed of the bourgeois especially, for the mass, the mob, it has no mind with which to formulate any creed save the strivings of the flesh of the lowest parts: the belly and generative organs. Hence the creed of 'P.I.S.S' is necessarily a creed of hypocrisy-all action that is called for in it is only pretentiously undergone as mere tokenism and theater and given sentimental feelings as confirmation of its realization-what is claimed to be ontologically valid (equality, etc.) is only paid lip service to and thus is ontologically invalidated all at the same time-but the illusion keeps the bourgeois caste in power and serves to pacify through emotional catharsis the broad masses and sate their bloodlust on scapegoats who serve as the 'enemy other' of the moment, disabling any potential revolutionary strife which might unseat the bourgeoisie.

The bourgeoisie however falls for its own propaganda perhaps out of an instinctive dishonesty and confirmation bias. The bourgeois instinctively understanding that their life of comfort and amusement depends upon bad faith in the egalitarian lie and accordingly disengage the rational mind through sentimentalism as means of perpetuating their status through willful ignorance of reality.

This sentimentalism derives from the pathos of semitic idealist philosophy and its house of cards architectonic of conceptual abstractions: 'Being' and 'the One'-"the flight from the alone to the alone", for the "completion of the One thing"-a yearning and longing for security and 'salvation' from the hardships of life borne of a fragile constitution, itself a result of bastardization of type (mongrelization).

This pathos is the plaintive cry of the runt for the breast-the mewling irrational outburst of the congenitally defective and weak. From this estate (the sudra) emanates the creed of egalitarianism, the supplicative desire to tear down the stronger opponent through cunning guile and deceit, the plucking at the heart strings of the superior who, in order to shed himself of the cloying lepers simply hands them alms and turns away in disgust and contempt. This gesture of emotional appeal has worked like the deft fingers of a gypsy pickpocket for the whole of history descending from that time perhaps emanating even from ancient India and vaishnavism and before that time period to Atlantis and the slave rebellion which transpired there millenia ago.

The mewling creed of semitic pathos, of egalitarianism derived from the slave caste, was borne of their cunning mind, an understanding of how to tear down and destroy, playing upon the psychology of the nobler type whose mind lay elsewhere, in the Olympian heights.

Internationalism, another feature of this semitic gutter creed necessarily lay within as a latent virus and which proliferated amongst those demographics (if such they may be called) of untermenschen who lay around the fringes of aryan Empires and who were mobilized by the cunning jews to assail white society and tear it down either from within (as slaves and traders) or from without as mercenary hordes.

The lowest common denominator can elevate himself through the creed of equality-since all are equals 'in the eyes of the lord'. The falsehood of this saccharine creed of craven untermenschen works to appeal to the ego of the lower type who necessarily wrankles with jealousy when in company of his betters and who harbors-in a society of diverse nature and even in one not-more often than not a murderous hatred for his betters.

The exception to this being an organic state founded upon principles of blood and soil and *suum quique* ("to each his own"-organic ontological-differentiation). The credo of equality 'before god' and the inevitable jewish priest-caste who with false humility mediates between 'god' and 'man' serves to virally replicate amongst the dregs of society, the outcast chandala who, becoming emboldened with the illusory pipe dreams of an 'other world' become willing to sacrifice themselves in a gambit for power as the gullible dupes of the rabble rouse revolutionary jews who lead them against their betters and with all probability to their death. Hence the efficacy of the egalitarian dimension of the Near Eastern pantheistic ideology into conscripting into its ranks 'all and sundry'.

The bourgeoisie of today are no different than the jews of yesteryear: a hypocritical oligarchy who utilizes the priestly caste hegemonic discourse of 'P.I.S.S' to bamboozle, pacify and justify to their slave caste their 'legitimate' authority. Pacifism is especially emphasized as it keeps the slave caste from tearing asunder the priest caste who are the representatives of pacifism, the embodiments of 'peace' and thus *eo ipso* sacrosanct, an untouchable caste in the eyes of their wretched devotees whose limited understanding can easily be clouded by the emotionally based discourse of the pacifist creed and, failing that, the threat of otherworldly consequences the priest caste is looked upon as having the power to visit upon them (hellfire; eternal torment, etc.).

The 'P.I.S.S' creed is the warm draught of the poison of messianic false promise, priestly caste sanctuary and ideological opium that is used to ensure the slave class remains within its iron bonds.

Now these bonds of course are even less noticeable to the slave whose consciousness is structured upon the principles of the promise of eternal life or bliss-returning to the womb via the vesica pisces or failing their continued toil a nihilation of their being in the hellfire of priestly caste horror stories.

The horror stories of today in the materialist world of communitarian post-modernity are no different: the threat of social condemnation and ostracism, threat of job loss and starvation in the streets; threat of imprisonment or the terrorism of the criminal elements should they not toil until they are no longer needed.

The 'P.I.S.S' ideology promises a comfortable life of leisure and amusement if only one adheres to the soul destroying creed of egalitarianism, of 'weakness as virtue', of 'loving thy neighbor' (all bipedal beings who walk on two legs) as thyself, of, in short, embracing the death cult of pantheism into which all are dragged, into the pit of perdition though failure to develop adequate spiritual power-a power reserved for the priest caste alone, their 'royal prerogative' as priests of the order of melchizedek. The end result for the slave caste of post modernity is simply-the false promise of sensory delight, the momentary transience of a roller coaster ride of dopamine spikes leading inevitably to a crash into oblivion, ashes to ashes and dust to dust.

To face this illusion and recognize it as such is to overcome it, to pull aside the veil and observe the priest caste behind the scenes in their true garb: no longer wearing the aryan robes of their invented monotheistic 'god', but rather the black robes of the black magician deceiver.

Once recognized the aware may then take the necessary action and put the witch to the stake and be done with the 'P.I.S.S' ideological manacle for good and all.

Excretion Of 'Anti-Race': Modernity

Modernity-its culture and denizens are the excreta of anti-race. The culture is the product of the anti-race jew who has managed to get a strangle hold on power through his characteristically subterranean, mafia-style tactics of takeover: nepotistic tribalism; usury and sharp practices; clandestine assassination and rabble rousing; intermarriage with corrupt nobility they themselves had corrupted through the religion and secret societies of the Levant (from archaic Akkadian and Phoenician religion to neo-platonism to christianity to the enlightenment-pantheistic naturalism and monotheism).

All of these diverse tactics working in concert to achieve the objective of the overthrow of the aryan by themselves and whichever untermenschen tools they utilize against the healthier elements of the society-those who are integrated 'men of race' whose bodies, souls and Spirits are harmoniously aligned with one another without any jarring cacophony between them.

The culture of modernity was properly called "entartete kultur" by the national socialists-degenerate culture, that which leads downwards; drags low; debases; defiles and reduces all to the state of a pantheistic primitive 'Oneness' with the jews being the top of the heap as its creators and advertisers, its proselytes.

Harmony is supplanted by rhythm; form by the amorphous; complimentary colors by colors that clash; order by chaos. The examples continue on without limit and one need only observe the historical record to glean an understanding of the degradation of aryan culture (the only true culture) in the quagmire of non-aryan sewage which calls itself 'culture' at this time in history.

The consciousness of anti-race: the jews representing its head, the body the non-aryan mass manifests itself in the forms of excreta which are bought, sold and trafficked in the market place of what is called 'culture'-all products of this culture are either one of two things or both:

- 1) a cultural weapon of non-aryans used against arians as mechanism of destroying their culture and self-understanding and leading towards destroying them as a biological-racial group;
- 2) the authentic expression (if authenticity could be predicated of its agents) of non-aryan consciousness; in both cases an expression of non-aryan consciousness as an oppositional force against arian consciousness in the way in which these respective consciousness' crystallize as concretizing in cultural formations.

One need only observe the culture of the non-aryans, in their own territory of the earth to understand what conditions 'authenticity' amongst the inauthentic (the bastardized/mongrelized non-aryan demographic whose 'culture' is merely a distorted pleomorphism of the ancient arians in their particular area of the earth which they inherited through rapine and murder-cultural expropriation non- arian style).

The culture of modernity is not some liberal/magical nebulous concretion of ideas and mystic processes but rather fundamentals, a result of miscegenation and incompatible elements which are not organically compatible and thus form the resultant product of the excreta of multikult sewage calling itself culture today.

Maya

The theater of the real the jew orchestrates and participates in as the actor he is in the realm in which one must give battle against him-it is the arena in which the gladiatorial contest between the children of light and the children of darkness takes place.

One may lose his soul in the arena, his non-physical being, but he can also win in the world. He may lose in the physical but none the less save his soul from the perdition waiting him should he fall into untoward ways, into paths that lead into the abyss-the cthonic sewer which is the fate of those who refuse to give combat in the spiritual and strengthen themselves in the fight and who become ensnared in sensation in the phenomenal world of illusion-the theater that the jew operates: falling for the temptation that the jew holds out to his non-jewish dupes and would be dupes-those whose soul he would seek to steal in this life and in the next so that there is no after life for the 'goy'.

The enticements of drugs, of alcohol, of carnal delights he lays before the goy as so many baits with which to ensnare the non-jew, especially the arian who, according to Crowley, has the greatest and purest energy.

Such is the spoil of the jews-to cannibalize the soul of the arian. Those who become entrapped in the vice of sensation, pulled down into the mire of maya, are in danger of losing their soul as their higher principles of being (soul and spirit) become entangled in the sensa of the material plane.

This is the reason why the jews and all of their golem cronies at his behest and instruction seek to perpetually bombard the senses of the aryan-with noise especially (vibration) as a means of creating an earthbound soul which is rooted in maya and detached from its higher principles.

This and the chronic abuse and manipulation that a targeted individual ('person') undergoes is designed to serve up their soul as food for the entities the jews are bound up with and for the jews themselves so that these entities can empower themselves and continue their vampiric work-perhaps, through the creation of chronic stress, to enable the attachment of these entities to the targeted individual and in being attached they may experience vicariously what the possessed being experiences while simultaneously having their soul vampirized by the possessing entity.

To create endless stress in the consciousness of another, to trigger certain reactions (fight or flight reactions) causes them to be distracted from their potential heights of consciousness, from their higher principles and focus their conscious energy on the stimuli which impinge upon their mind-sounds; sights; vibrations, etc.

Thus the operations of the cabal of the dark forces have a more sinister objective than merely mundane vengeance or sadistic domination of others, a mere exercise of strength. Rather they are, as reflections of their entities they are bound up with, interested in the vampirization of the soul of the greatest and purest aryan.

For the whites (potential arians) to escape this fate necessitates combat of a spiritual nature-detachment from maya, living at a higher level of spiritual consciousness. This means avoidance of sensationalism (drugs, alcohol, sexual license-coarse nervous stimulation) and practices which conduce to the development of the higher consciousness (contemplate/meditate and Self strengthening through the endurance of challenges which are causally related to the control of the will and the empowerment of the soul which, like a muscle, atrophies for want of proper exercise and training).

In maya all is a show, theatre-yet the outcome is always permanent in its impress and modification of the soul-either a strengthening or a weakening and the outcome of either through confrontation with the dark forces, the stronger force overcoming the weaker force.

Judeo-christianity and its modern variant liberalism set one up for destruction as it preaches weakness as virtue not vice and strength as vice not virtue. It is the mind virus installed into the consciousness of whites by jews as a means of softening up their target while convincing them to serve those who exploit them; that it is the height of virtue-indeed an ethical imperative issued 'from on high' to slave before they who would seek the destruction of oneself and one's kind.

To acquiesce to the enemy is the same as acquiescing to the reaper. Turning the other cheek and allowing violence to be done to oneself and refusing to employ or exercise the higher principles of consciousness (reason and intuition) as means of ensuring one's survival remaining in a state of perpetual ignorance and allowing one's own death adhering to creeds of spiritual suicide.

Such is not the aryan path, such is the path of weakness, of semitic serfdom, the mentality of the chandala who requires subordination as means of fulfilling their destiny. To save one's soul and the Racial Oversoul of which one is a part one must give combat and adhere to a virile spirituality, that of the warrior for whom life in the world is combat and 'war everlasting' as guarantor of his continuance in this world for a time if at all but in the next with as great a certainty as he can purchase through his limited power against the enemy.

Honey Trap

The phenomenon of the honey trap is characteristic of the matriarchy that rules the world. The use of sex as a means of entrapment is female in nature: both because it relies upon the lower states of consciousness, the instinctive drives and the appeals to the lowest and basest elements in the person but also because it is deceitful in essence relying upon shifting the conscious mind (the Higher consciousness) from a higher to a lower plane of being and manipulating the target through having them lower their defenses through that means.

The target is placed off center, is taken off their base as an autonomous person and upset in the equilibrium of their mind through the magnetism of sexuality as a force of beguilement or enticement. The promise of a 'sweet delight' of carnality (honey) is the force of impulsion that entraps the target.

The understanding of the instinctive mind the oligarchy of darkness has emanates from their own lower state of consciousness and is projected onto the target as a fisherman would cast a net into a body of water seeking to come up with fish.

What the oligarchy and its minions do not know however though they may suspect at some level of their comparatively low consciousness, is that the aryan man is not always a bottom feeder who can be easily ensnared in their nets and that he is in many cases a shark in the waters though he may be mistaken for merely being a fish.

The honey trap is laid out in characteristically subterranean fashion by the cabal as an enticement of both men and women ('man' being employed here as a collective pronoun and referring to the aryan race, they alone who have the higher consciousness, 'mind' which derives from the sanskrit term 'manas').

It operates as does all of their other protocols on subterfuge- a false appearance concealing a sinister reality in the case of that which they portray as a 'good', a 'benefit' and a concealed good which is shut off from the sight of the non-jewish slave caste and obscured by various hex signs and words that serve to conceal the real good or benefit so that the slave class will not be able to avail themselves of it.

In the case of the honey trap the bait ('honey') is the apparent good of carnal indulgence or even a spiritually elevated relationship- whatever may be an enticement of the targeted individual, who the cabal anticipates would have a willingness to bite the poisoned apple.

The purposes of the honey trap are manifold: have the honey trap (the individual who is conscripted by the cabal to entice the target):

1) gather the biometrics or other information of the target for the purpose of mapping their consciousness or manipulating them to a greater degree and more effectively (through eg. skits acted out in the theater of the real, incorporating neurolinguistic programming and its sensitization elements for classically conditioning the target and eliciting reactions that can be entered into the database on them);

2) to have the 'honey' enable their assassination leading them into a trap of some kind (into, eg. their residence wherein they would be ritually murdered by the cabal or abducted for sacrifice to be done away with in whatever lodge or synagogue).

The honey trap thus is as the name suggests: enticement (honey) and entrapment. Dealing with the honey trap is simple: become an expert on the psychology of others, ask pointed questions to elicit responses which may suggest the person is an operative; employ certain keywords to elicit similar reactions to shock the person or cause them to act in ways subtly different and abnormal referencing such as 'gangstalking' or 'community policing' or 'jews'; 'freemasons', etc.

Any subtle twitch or behavioral cue would suggest an operative. However, given that these individuals are possibly multiple personality disorder victims of trauma based mind control whose alter personality could be triggered at the slightest provocation on the part of their handlers (through eg. radio frequencies, etc.) it may be a fruitless endeavor.

Hence one never knows who one is dealing with and at most one-the prudent target-can draw inferences as to the reliability of the individual (honey trap) based on the surrounding circumstances and an investigation into their life and its relation to others.

Nothing is certain when dealing with others at this time in history as most people are placed under some form of hypnosis and this through the electromagnetic fields of the matrix (celltowers, etc.) which may also open them up to possession by entities who will control or influence their behavior.

Thus the watchword for all parties at this time in history is "don't trust anyone" (D.T.A)...at least fully and without reservation. The cultivation of a higher understanding of things (attunement of oneself to the Divine Will, to Being) enables a greater recognition of who is friend and who is foe.

"By their fruits ye shall know them" is simply not adequate as a condition of knowledge as inference only goes to the extent of appearance and the concatenation of sense experience via reason- rather: "by their fruits as they can be sensed at a higher level than merely connecting bits of evidence at a mundane level". To avoid walking into a honey trap one must tread lightly but also skillfully not with timidity but with deftness.

The dark feminine nature of the cabal (its dependency on the cunning of reason and its projection of its diabolism onto those who exist on higher planes if only *in potentia*) is the modality of its despotism. It works in imposing itself on the Other cryptically and through deceit, through temptation, offering poisoned fruit which merely serve to poison the target (the target being any and all of the cabal's capricious inclinations /desires, singled out for torture murder-yet another trait of its dark feminine consciousness).

The projection of the cabal consists of its own desires being projected upon that which is Other to itself, lowering the higher type and blaming them when they fall claiming they 'had a choice' to resist the temptation. Of course this is true-the target did have a choice but that doesn't mean the cabal is exempt from their karmic backlash or that the 'sin' didn't attach to themselves, the causal agent of its coming to be (the honey trap being typically a groomed and well instructed member of the cabal themselves).

For cabal members this is merely another 'insight role' which enables them to experience as a theater actor the target's behavior-to manipulate, to influence and to derive a sense of superiority in achieving their intended goals-perhaps even in the form of cannibalism or vampirism of the target's energies, of their very soul.

Voyeurism Under The Matriarchy

The foundational feature of the mob-stalking protocol of the terrorist regime of Zion is the perverse thrill that its participants derive from the abuse of the kosher approved 'enemy other': they derive a sexual thrill through the observation of the 'Other' (voyeurism) and they derive moreover a sadomasochistic thrill in the overt harassment and torture of the enemy 'Other' (depending on the degree of involvement this sadism can go as far as mutilation and the destruction of the physical body to whatever degree of the theft and mutilation of the soul through binding it with entities through the cannibalistic rituals of higher level 'adepts').

The cabal is a hierarchy and the mob-stalking protocol is merely an initiation into the profanation of the mysteries by the black magicians who utilize this protocol as one amongst many mechanisms of entangling the 'goyim' in their nets.

It is the power rush which is simultaneously a sexual rush (from the bottom, the infernal regions)-hence 'sadomasochism', the sexual thrill derived from the visitation of harm upon the 'other', he who is deemed 'anathema maranatha') that entices the gullible goyim into the cabal from the outside and it is those who are born into it who play a role at a higher level bringing up outsiders to a higher level of infernal life.

The sex-death connection is borne of the womb of the matriarchy and its consorts-consorts of the mother goddess, the baal priests of Zion hiding behind the petticoats of the matriarchy of the mother goddess and manipulating the gears and levers of the Zion matrix machine.

The delight in their deceit and playing the role of a theater actor in the theater of the real manifests itself in the form of voyeurism which is the most basic modality of their perverse infernal minds (coming from the instinctive bottom of consciousness)-to look upon the 'Other' as a source of perverse delight and to seek to interact with that Other as a means of displaying their strength and power over the Other.

This process is initiated by the all-seeing eye, that of the mother goddess which spies upon all with its panoptic vision making all the object of its knowledge and thereby establishing power/knowledge relations with the objects of its vision (to have knowledge is to have power over that of which is knowledge is had-it is the basis for imposing power on the known object).

To create a spy society of an initiatic sort wherein all are conscripted as participants or targeted as enemies is the totalizing function of this knowledge-power dynamic and means of regulating and regularizing the mass into the Solomon's temple architecture engineered by the architects of destruction, the cabal priests. The spying phenomenon has its basis in the feral drives of the instinctive mind: fight; flight; fornicate; feed-modalities of action gone about in relation to the 'Other' as known object of power relations-known through the lower drives which govern the lower instinctive mind and which connect together the inclinations towards sex and death in sadomasochistic no touch torture of the 'Other'-to be magically incorporated into oneself once they are made a knowledge object through voyeurism.

Robots Of Zion

The transhumanism program is the telos of Zion: for all 'good goyim' to be subjected to chipping and the modification of their conscious mind through radio frequencies that are transmitted from E.L.F and E.M.F stations that condition the slave class to think and behave according to predetermined algorithms that piggyback on their biorhythms. Changing the frequency and resonance of the once semi-autonomous freeman to an automaton over whom the jews and their accomplices have arbitrary sway at the press of a button to run their protocols.

The robotization and automatization of the goyim is well underway and we are now simply awaiting the implementation of their plans. The rfid chips they wish to implant into their slave caste which would give them electronic control of the body's functions and which would alter the consciousness to resonate at whatever frequency transmitted via satellite to those same rfid chips has already been accomplished though it is portrayed as a mere 'future' source of dread, ushering in the apocalypse according to the psyop of biblical prophecy which the jews utilize as a template for the orchestration of their plans to convince enough of the masses to "believe, believe, believe!" the "glad tidings" of the messiah and to embrace the jewish 'chosen people' as the holy tribe and untouchable rulers.

Dentists; Surgeons and doctors have been injecting rfid chips into the bodies of people presumably for decades at this point and have gotten away with it as the program-like all of the programs of the dark forces-have been run clandestinely in the shadows of the theater of the real by the stage managers of Zion.

Most doctors are freemasons or judeo-christians or both and most work hand in aryan glove as the hidden hand proxies of the dark forces-and most doctors are jews. Hence there is no need to "fear and tremble" before the jewish 'lord'-as the only salvation lies in being saved from the jews not saving the jews-and this through one's own will power not through any prayers to the magic jewish 'lord'.

The rfid chips are the control mechanism through which the jewish terrorist cabal control their underlings-which technology gives them power over life and the ability to visit an immediate death upon their charges through the transmission of direct current into the body via the chips from satellite and to manipulate the motor functions of the body through such electronic impulses.

This is why the rfid chips are inserted along the path of the vagus nerve-the main nerve governing the functions of the physical body-like Pavlov's dogs, the non-jewish targets (and there are no jewish targets) are activated or rendered passive-perhaps like electroshock therapy their nerves or neurons become short circuited or burnt out like a fuse in a fuse box and thus rendered comatose or zombified.

This power however is limited only by the survivability of the system, of the electromagnetic Zion matrix. This system's perpetuation constitutes the perpetuation of suffering and the only alleviation of the suffering comes in the form of its nihilation-knowing of the satellites and control grid at a sufficiently high level that renders the system inoperable.

It is only possible to influence those in sufficiently high positions of power through conscious intent, through remote influencing to take the necessary steps to bring down the matrix. This and to bring down those who have engineered it in the first place and who maintain its operations-everyone from street level gangstalkers to their handlers and those in positions of high office and the highest echelons in masonry and the kehilla of international jewry.

The performance of black magic telekinesis assault against the known figures, is the key and to generate enough animosity towards them to bring about their downfall. At such point the rfid chips may be able to be excised by the deft hand of a competent surgeon who was not a part of the cabal of evil else they may simply remain as non-functional prostheses in the flesh-*memento mori* of the dark age of Zion.

To attempt to extract the chips at this time would be futile as the terrorist cabal can simply implant more through the clandestine means they employ, eg. to drill a hole or holes in the wall of someone's residence when they are gone and to pump in knock out gas when they return and perform the implantation after entering into their residence.

Such procedures are not something that can be practically combated save through having multiple persons sleeping in shifts-but they themselves would be knocked out by the gas. Hence the only means is to employ remote influencing telepathy to motivate the good to take action and destroy the bad, the terrorists of Zion and to take whatever direct or indirect action one can themselves (eg. telekinetic psychic attack inducing strokes and heart attacks).

The only alternative is to acquiesce to one's slavery and should one be targeted for destruction such an act (or rather forbearance from action) is suicidal, as one either gives combat or he dies in the attempt-and preserves his soul from the disintegration of the black magican vampires and their entities the archons who use them as pawns in their chess game against the light side, the aryan side. It is either willing self-robotization and certain extinction, the effacement of one's identity as a cyborg slave or it is preservation of one's autonomy even in physical death.

Infernal Machines

The technocracy of Zion utilizes the machines of enslavement that comprise the matrix system.

These machines are multifunctional information processing systems-they transmit radio frequency and electronic signals to the slaves of the matrix and detect, interpret and relay information derived from their monitoring of the slaves within the cybernetic control grid.

The information they detect is translated in the quantitative reductivist language of mathematics-0s and 1s. All beings are reduced to mere 'information' which can be manipulated through their interrelationship (interface) with those machines, making of themselves mere nodes in a larger machine called the Zion metatronic hypercube of four dimensional hyperspace.

However these machines are merely able to relate to the organisms which exist within the matrix as physico-chemical structures, as matrices of maya within the larger system and are not capable of understanding or influencing the higher consciousness that certain of these organisms possess/are-at least which they possess/are *in potentia*, in germ.

The Zion matrix is unable to understand that which exceeds its comprehension, that which can be reduced quantitatively *ordine geometrico* to 0s and 1s and that is Spirit, the Holy Graal which is the sole possession of the aryan in this three dimensional spatio-temporal complex system.

Only those possessed of Spirit can overcome the cyberneticization of themselves as mere units or nodes within a system based upon electromagnetism. The substance such beings are comprised of are beyond the finitude of the 'worldly' machinations of the Zion machine. Hence they alone can extricate themselves from the matrix. However this is not to say they will or that they should seek a mystical 'flight from the world' but rather that they are simply capable of casting aside the worldly fetters through an immanent transcendence.

The machines of Zion as designed as crude mechanisms of the enslavement of the populace so that the 'goyim' may have their energy drained by the vampiric elite oligarchs and their archontic entities these oligarchs are controlled by and to which they have become bound.

These machines themselves may, as in the movie 'Maximum Overdrive' by Stephen King, become controlled and possessed by these entities who, operating on the basis of electricity perhaps or through some subtle force capable of activating or modifying them would employ them to realize their sinister purposes of the stealing of the souls of the population.

Thus those who control and engineer the machines (perhaps ultimately motivated by the vampiric entities in the first place) would themselves not only be transformed into machines but be transformed into weapons which are the vehicle of the malevolent will of these entities. Like the movie "Terminator", the machines takeover and destroy the human population rendering all enslaved as human batteries to serve as receptacles of energy for the entities who care not for that particular physical form of energy they seek to vampirize but simply that they have the option of vampirizing the energy itself (soul stealers and eaters of souls).

Most of what were once referred to conventionally as 'humans' today have become machines, many of whom having lost their soul to these entities ('archons'; 'asuras'; 'reptilians'-call them what you will). Thus the machines made by machines have an infernal purpose-that being to bring about one's destruction at a soul level.

The machines are indeed taking over organic life and most of which has ceased to remain organic and has become instead a possessed mechanized artificiality that is a simulacrum of the real, the hyper-real as spoken of Baudrillard into which the consciousness of the energy battery goyim becomes absorbed into the cybernetic vagina of the matriarchal global system-'all are one', all are nihilated in their difference and submerged in the corrosive waters of cosmic vaginal fluid, to be disintegrated into mere energy-0s and 1s that can be entered into the system as yet more 'information' that feeds the machine.

The mechanism of action of the machines are substitutions of organic functions with artificial automated functions such that as the ultimate conclusion or consequence all rational choice and independence from the system becomes subverted through a gradualistic (logarithmically gradualistic) process of substitution-in place of the spoken word we have the encoding and decoding of words through communications devices; in place of movement we have machines serving the archons as a cybernetic husk, matricized nodal point ('mech' body).

However it is not as if people have not lost their first estate millenia ago-they have atrophied their higher mind and connection to higher consciousness and their communications have been degraded through the media of abstraction-texts, symbols, numbers, etc. Their first estate has been overlaid by artificial repeatable characters and graphai which have been translated into phonai and *vice versa* such that the given is mediated and lost in the translation.

The being (organism) is rendered merely a node in a communications system of 0s and 1s. This is the meaning and intention of *remote neural monitoring and manipulation*-the cyberneticization of the goyim so that their forms are enmeshed in the spider's webs of Zion that they may be vampirized of their soul by the archontic entities who were and are the impetus of the current system in its origins- from the 0s and 1s of double-entry accounting to the philosophical-theological abstractions of priestly caste rhetoric to the language of the real (electromagnetic impulses) the cyberneticization of the 'goyim' has been ongoing for millenia.

Spreading The Blood Around

According to the logic of the vampires of Zion-which is the logic of the absurd-harming others, that which is 'Other' to themselves, is perfectly justifiable and for the following reasons:

1) the false narratives they contrive and have come to believe as a mythos of victimhood they use to condemn the 'Other' for alleged past 'sins' that this 'Other' is alleged to have been the causal agent of and

2) delegation of the tasks of harming others to a myriad of 'Others' (loosely associated with themselves so that according to their logic, their own hands are kept clean and the hands of others are stained with the blood of those they seek to harm. This is the black magic of the jew and his associates which is based upon scapegoating of the 'Other', transference of karma to that agent which is most convenient to themselves and ideally according to their logic that agent towards whom animosity is held and who the jews wish to frame, set up or burden with their own karma-the concatenation of disharmony of which they are the ultimate cause.

The entire cabal operates on these premises of scapegoating and transference giving the 'Other' upon whom they transfer their sins and responsibilities as well as the targeted individual what the cabal interprets (in most cases speciously operating on the basis of the lie) as a 'choice' to pursue or forbear from courses of action that the cabal leads them down.

This is the 'set up' of the non-jew who is placed in the crosshairs of the cabal's double barrelled shotgun and given a 'choice' of one barrel or the other. This as far as the transference/scapegoating modality of their ill-logic applies (which it never does in a real sense).

In terms of transference applied to multiple parties the karmic burden is shared by them and according, again to their specious ill-logic, discharges their karma, rather like inserting a multipronged metal instrument into an electrical outlet-the more prongs (participants in the harmful deed done to the target) the less discharge of voltage into the individual prong.

However the reality is otherwise as, insofar as the agents are aware of the deed being done they are fully responsible for the outcome as it would not have occurred but for their agency which applies in the cases of willfully blind patients who refuse to oppose the harm equally to the willing active participant whose willingness is embodied in his action regardless of the specious reasoning to the contrary (willful ignorance and cognitive dissonance as means of blindfolding oneself as he thrusts the knife in the enemy 'Other').

Thus the notion of 'spreading the blood around' is yet another attempt on the part of the black magicians of Zion to exculpate themselves of their sins, a means of cheating 'God' so to speak. Given their deeds, this will be revealed through the discord they cause will necessarily expose their crimes especially in proportion to the publicity of their crimes and their being objects of knowledge, of the conscious awareness of the participants and the victims. The ripples will spread outwardly and become an object of awareness of increasing numbers who will retaliate against the perpetrators, bringing them to justice either in this world of the physical dimension of 'the next' (at higher dimensions).

The logic of the cabal is intrinsically faulty and thus defeats itself as it is self-defeating in essence. That one is an agent within the sum total of Being (what many call 'God') they initiate certain causal states (ripples in the ocean of Being) which have reverberative effects that caromb against them for good or ill depending on the quality/quantity/relativity/modality or those acts and omissions.

The repost of the cabal would be that 'spreading the blood around' works and is not ill-logic or ineffective or self-defeating as one's own 'sin' or 'karma' is merely offset by the quantity/quality/relativity and modality of the specific action. This is fallacious and specious reasoning for the following reason: all specific acts are causally related to all other things and are deliberately undergone for the purpose of harming the target. Insofar these acts are supportive means for the realization of the act of harm without which the harm would not be achieved even by the slightest degree such as for example the blocking of a target along their journey which causes them to change direction leading them into a trap which results in the specific harm.

Thus any act which is undergone with awareness of the harm it does to another implicates one to the extent they should have known (the 'should' here being based upon their nature and epistemic state and capacity such as a retard or a genius being blameworthy based upon their capacity, *mens rea*, the ability to formulate intent).

That the 'goyim', in the slave matrix of Zion have been reduced to a state or near automaticity, of robotization they are no longer who they were and 'their thoughts [and concomitant actions] are not their own to a degree. However they allow themselves-to whatever degree-to be led to such a state and are to that degree blameworthy, have made 'their choice'.

Nevertheless they are exempt from karma and blame to the degree they had no capacity to form a *mens rea*. This of course doesn't exempt those at higher levels in the gangtalking terrorism from blame-rather the reverse is the case-they are the more blameworthy the less blameworthy their agents, their cat's paws or patsies if and only if they were aware at whatever level of their consciousness of the fact.

To, for example, employ a criminal drug addict to vandalize a target's property knowing that if they did not carry out the deed they would not be given a reduced jail sentence. Such an act would result in a greater blame for the handler though blame as well for the lower level pawn who physically carries out the deed for the self-interested motive of saving his own hide.

Such a scenario is seen in the movie "The Running Man" where each victim is also a perpetrator and pitted against his foe such that they either fight or die. Nonetheless it is a choice but one made under the extreme of disjunction and thus those who had imposed upon them this choice are all the more culpable as they were the causal agent who orchestrated these circumstances in the first place.

Thus, far from transferring karma downwards to intermediaries in committing atrocities against targets the karma flows upwards, the ripple effect being felt most by those who are the ultimate cause of the subordinate causes, the puppet master who pulls the strings of his lower level minions and initiates the cascade of events leading to the harm.

None are exempt from 'the judgment of God' as it is called in Abrahamic theology-they are all condemned by themselves through their own actions in participating with conscious intent in acts of harm against others regardless of their specious reasons or justifications. "two wrongs don't make a right" as the maxim has it whether the target has indeed perpetrated any wrong themselves or no is a question for 'God' to decide (for those of conscious awareness and who are just to rectify as well).

Psycho-Babble From The Tower Of Babble

One of the main mechanism of jewish control is the employment of priestly caste rhetoric. What this is is a self-enclosed system of discourse which legitimates and validates itself through itself-is 'homologous' in the sense of entailing logic which implies its validity (the word being derived from the Greek 'homo' meaning 'the same' and 'logos' meaning word or discourse).

It is also based upon what might be called 'axiomaticity', or axiomatic forms where the language has meaning through itself and is founded on 'axioms' that are unquestionable and irrefutable as their legitimacy is inbuilt in the system of language or discourse.

This is how the power of the discourse in its implementation operates-it derives its meaning from axioms themselves merely posited phrases or words (conceptual constructs clothed in language, bags of wind clothed in fabulous garb) which are, if amplified at all, given further meaning based upon 'recursive proof'-the notion of 'proof' itself being purely a function of discourse, the meaning of the discourse deriving itself from those conceptual constructs and thus being hollow, empty windbaggery.

The priestly caste hegemonic discourse employed by the architects of destruction (the dark forces) is that which serves as their mechanism of self-legitimation- that legitimates their acting against the autonomy of others, violating the 'Otherness' of the Other, imposing upon the Other whatever is beneficial to themselves.

This applies in all spheres of the jewish matrix of Zion-from the political to the economic and legal spheres in addition to those of the medical system and 'social services' system all of which interpenetrate one another and are based upon the assumed truth that jews are 'the chosen people' of the Absolute and are thereby entitled to impose upon all their own autarchy whose legitimacy allegedly derives from 'on high', ie. from 'God' who they seek to monopolize and claim as their own as the 'elect' intermediary priest caste collective messiah.

The operation of the matrix system is based upon the lie: that it serves the good of 'humanity' in the sense of applying to all bipedal beings when the jews look upon themselves as the only humans and thus in effect excluding all who have not come under their thumb and have gone through their rituals of 'illumination' as human but merely 'goyim' or beasts. Indeed, even those who have become 'illuminated' (read 'demonic possession') are nonetheless beasts for the jew though they view themselves otherwise and the jew has deceived them into thinking they are otherwise in the jew's mind.

The lie is thus the lubricant of the gears of Zion and it functions according to the algorithms of its hegemonic discourse (that of a hypocritical universalism-double standard hypocrisy applying unevenly between the jews on the one hand and the goyim on the other being buoyed up by the usury of the jew in the other pan of the scales of the injustice of Zion).

In the case of the medical allopathic system the discourse is based on the false 'axiom' of 'humanity' in the universalistic sense and the rhetoric of 'rights' to 'health and help'. The pretense of help has the outcome of harm through the praxis of allopathic medicine especially that of psychiatry which is the modern equivalent of the medieval torturer-the inquisition (psychiatric/psychological assessment), institutionalization (confinement to a dungeon) and torture (the forced subjection of the 'patient' to various forms of treatment which purport to 'help' but which are in reality harmful and indeed lethal destroying the body and soul of the 'patient').

The language of psychiatry itself reveals the nature of this 'help'-the patient' is merely a 'docile body' in the sense of Foucault (as discussed in his "*The Birth of The Clinic*" and "*Discipline and Punish*") who must endure the impositions of power of the psychiatrist who is the master in the master-slave dialectic of the psychiatric/psychological process which has as its unexpressed ulterior motive the rendering of the 'patient' a source of experimentation and sadistic harm imposed upon them by the 'master'.

They by virtue of their status as a 'patient' are subject to the impositions of the psychiatrist: the elimination of the autonomy of their will ostensibly within certain 'ethical' parameters which are themselves merely linguistic justifications for that same imposition.

So long as it is consistent with the parameters and meaning of the language of psychiatry the psychiatrist is *eo ipso* legitimated in imposing themselves upon the patient in any manner they so choose. Under the current neo-liberal democratic marxist regime (one among many of the guises of the jewish matrix of power) as long as a member of the public (a citizen) can be qualified as having a 'mental illness' by false psychiatric diagnosis (meaning that the label projected upon the 'citizen' has no correspondence with their inner being or behavior) and through that means the initiation of restrictions of the liberty of the person and the probability of their being harmed by those who have accrued to themselves through self-legitimizing discourse the right of 'authority' based purely upon their own invention or that of the entities with whom they are bound. To hold out the facade of 'helping' people is the means of justifying the imposition of harm. Such is allopathic medicine as a whole (cutting; burning and poisoning) and psychiatry specifically.

The notion of a person (citizen) being 'mentally ill' is merely a fictional construct of the priestly caste hegemonic rhetoric and implies 'mental soundness' as a compass of 'the good' in terms of thoughts, emotions and actions and upon the universalist discourse of 'humanitarianism' or of an egalitarian monotheism (all equal before 'god').

'Mental soundness' is, under the secular humanist regime, merely an expression of the group think of the collective mass mind-whatever the mass has been conditioned to think by the jewish oligarchs who control their mind through their control and implementation of the organs of information (media; academia; institutionalized religion, etc.) and the electromagnetic grid which traps them in a matricized hive mind obfuscating independent rational thought and supra-rational intuition.

Here 'mental soundness' is thus a mere social construct, purely aleatory and contingent upon the shifting of the minds of the political climate like a weather cock spinning in the breeze. Under the monotheistic universalism of Abrahamic theology that which is of sound mind has at least some stability or consistency-however it is nonetheless a universal construct and makes no allowance for the extreme variation of the consciousness of the aryan and non-aryan beings of this earth reducing all to a vapid state of 'Oneness', 'before god' and transforming the higher type into the lower through the imposition of levelling equality, destroying the 'first estate' of the aryan through his submergence in the mire of beast consciousness.

Organic Differentiation

All forms are emanations of Being, of the 'One' (*vide* Plato and Genesis). They are in their True form organically developed beings whose ontological status is that which could be spoken of as 'True' or 'Good'-the Good, the True and the Beautiful. All of those forms which are mixed are, to the degree of their mixture the converse (on a sliding scale proportionally Good, True and Beautiful or bad, false and ugly). This because they do not preserve their original elements in a state of harmony but rather in a derivative form, they do not harmonize with the Truth (Being; the 'One'; 'God'-call it what you will) and exist in a manner antagonistic to the Divine Will.

In most cases the forms which exist in the material world (those in 3D physical reality) are corrupted forms, fragmented in their being and fused in their disparate elements only only to varying degrees of bonded stability-certain fragments comprising their being; as in the case of examples of extreme mixture (such as 'ligers' or 'tigons'-mixtures of tigers and lions or mules-mixtures of horses and donkeys) manifesting themselves in ways that would properly be spoken of as 'diseased' (dis-eased, not harmonious) or dysfunctional-hence 'no good' or comparatively bad, not able to sustain any relations either to themselves or others of a harmonious, mutually self-supportive nature.

Hence they would merit the designation 'bad' or ugly or false not containing within themselves the ring of Truth as a close enough approximation to Divine origin of the elements of which they are comprised.

These fallen beings, 'broken cisterns' as they are referred to in biblical parlance are the 'peels' or 'qliphoth' (soul shells) spoken of in the qabbalah of the jews who misapply perhaps deliberately this label to those who are non-jews when the designation best suits themselves. Let the chips lie where they fall-such is the nature of the Demiurge, of the ever increasing densification of the light in its fall into matter and its 'fall from Grace'. This explains the state of the world today, what has been called in various sacred texts 'the end times'; 'the kali yuga'; the 'wolf age' or the 'iron age'-the nadir of the cycles of Time-the organic process of the materialization of the Spirit in its genesis or solidification or densification.

Nonetheless, the redemption lies in the fact that the Divine sparks (the Holy Graal; the Holy blood of the aryan) can transmute itself spiritually as the more dense the physical body can be rendered spiritualized. This is the process referred to in the bible as the 'resurrection body'. This is only an option for those who possess the Divine Spark, for those who are sufficiently possessed of aryan blood to be able to attain this state who live a life that is of a spiritual nature overcoming the leaden chains of materiality which seek to draw down the Spirit into a lead coffin through the nucleus of the aryan-the Graal-the soul becoming earthbound in a coffin of lead-through dwelling excessively in one's consciousness in the material plane.

This is the goal itself, perhaps an instinctive behavior on the part of the fallen and corrupted-the 'ungodly' in the sense of they who have no Divine spark or whose spark has been extinguished in the mud of material density-they wish to bring down the aryan and snuff out the light out of a jealous hatred, for their eyes can't stand to see the light which radiates forth from the essence of the aryan.

Hence they seek to create conditions of chaos and hardship for the aryan which bombards him with or entices him to bombard himself with sensationalism and all of those phenomena which debase, defile and destroy his first estate, the flame of his inner being, which is the microcosmic presence of the macrocosm (Being; 'God'; call it what you will). They wish to submerge the Light in the 'corrosive waters' of Maya, to douse it in the mud flood-this way they won't have to face their own inner demons as they will have no standard to compare themselves to which exceeds their own inferiority.

This is how the untermenschen tear down 'the city of god' built by the gods who are 'ruling with God' (gott mit uns). Hence the fanatical desire of the beastman to again debase, defile and destroy the culture of the aryan as it, this culture, is a manifestation of his inner being which they ultimately wish to destroy in its essence.

The differentiated Order manifest in the culture of the aryan aryan Man ('man' being derived from 'manas' meaning 'mind' in sanskrit), they seek to tear down as they are the embodiments of chaos, being 'broken cisterns', having 'lost their first estate'. They must of necessity destroy as they have no means to either create or preserve that which did not come from their hands and which was the Creation of the Creators of the world who were and are still the children of the Creator having the Divine spark within.

It is in simplest terms a holy war between the children of light and the children of darkness for the preservation or the destruction of the culture and civilization made in the image of God and no 'graven image'. A kingdom of heaven on earth is under siege and in order to protect its ramparts and those within its walls who may still be redeemed-those possessed of the Divine spark-a staunch defense must be made against the evil tide of the chandal untermenschen as means of maintaining what the aryan has built and as a means of creating a spiritualized world transmuting the fallen aryans who have lost their first estate (or nearly so) during the 'fall of man' of the original sin of mongrelization and to establish a 'fortress of God' upon earth.

The untermenschen wish to create an undifferentiated order made of impossible utopian imaginings that could never maintain itself as it is not an organically developed world but rather a world of (sub)human invention based merely upon false ideas that emanate from the consciousness of false beings (those who have lost any glimmering of the Divine Spark).

The intended 'Zion' of the jews, creation of a freemasonic utopia based upon technology utilizing explosively generated power is inherently unsustainable and would necessarily crumble to ruins through its own entropy.

The differentiated Order which is an emanation of the Divine Will cannot be perversely refashioned with the baling wire and string of a judeo-masonic techno-crazy which would merely destroy itself through its own inner weakness. Hence only those who have the Truth in them and are not an 'organic lie', the anti-race of jewry and their savage hordes are capable of establishing a 'new order of the ages' which is at the same time not new but merely a continuation of the aryan in his origins in a new golden age, a kingdom of heaven upon earth.

Bella Bellum

There are 'good' wars and there are 'bad' wars. Those fought for the preservation and establishment of Cosmic Order, the justice of 'God'/Being are good those fought against it and which conduce to an overall inharmony or upsetting of the balance of existence are bad.

However given the inherently destructive nature of war it implies that chaos must be created in order for the greater good to be attained. Hence war can be likened to a nigredo phase in alchemy clearing away the inharmonious elements supplanting them with a harmonious composite which has had those elements removed from itself.

The reality of life is war-a perpetual conflict between different forces which seek to achieve their own ends if need be in contravention to that of Others (and necessarily so as reality entails predator and prey). Hence there will necessarily be war and since all life is war one must fight and this everlastingly to the extent of his life. Failure to do so, to give combat, is death and the victor will then appropriate from the dead their weapons of war and their property and their kith and kin if need be and gain a victory, only to war against others in whatever form or fashion for the achievement of their own ends.

To allow oneself to die in martyrdom simply takes oneself out of the game of life and does not put a stop to the game-rather in many cases it simply conduces to greater chaos and inharmony should one refuse to fight.

One must fight on one's own side as that is the way 'God made him' (ie. how he manifested on the mundane plane through incarnation) and failure to take one's own side is to cause harm to one's own kind. This is the case of the race traitor who sacrifices his own kind for his own ends and to whatever degree or in whatever way specifically he will be called to account according to the laws of karma/Cosmic Law (the laws of 'God'). The 'good' war is that which is waged 'on the side of God/Being', on the side of Cosmic law.

At this time the aryan people of the earth fight against their own survival in large part and simply bring about greater harm to themselves failing to acknowledge in most cases through deliberate blindness, that they are not a sinner who owes all and sundry and that they are not the equal to those who they have become convinced by propaganda they are equal but rather are infinitely superior and thus might take their own side.

They must come to understand their special place in 'the grand scheme of things' and the necessity of their acting in their own interests to create a world of a spiritual nature and to supercede the coarse materialism of the modern world. Hence they must fight against all-even members of their own kind-who have inculcated in their mind an animosity or indifference towards their kind and their own preservation as a collective group.

The perpetrators of this anti-aryan hatred must be brought to account and so too must its supporters-the punishment fitting the crime according to Cosmic Law.

Such is the good war we the aryan race are in at this time and all must fight in defense of their own people. This fight is simultaneously a defense of themselves being a member thereof and a defense of 'God', the Cosmic Order, returning the fallen world in which they dwell to a state of spiritual purity.

If one does not fight on the side of the Good he fights against the Good-as no passivity is possible in the 'kingdom of God'.

Mental Map

In the targeting program the goal of the perpetrators is to impose upon the target the appropriate quality/quantity/relativity and modality of harm such that the outcome is the target can achieve the perpetrators' goals of:

- 1) mapping the higher consciousness of the aryan through classical conditioning and reverse engineering enabling their transhumanist agenda to work towards its completion (the perfection of the metatronic hypercube or tesseract of the Zion matrix closed system prison planet soul farm) and
- 2) so that the entities the perps (who are themselves perps at a different dimension of Being) can feed off the pain energy which is released by the target through the causal mechanisms of sadism employed and
- 3) so that, as in the story of snow aryan, they can destroy the image of God ("mirror, mirror on the wall..."-they can smash the mirror which reminds them of their comparative inferiority).

This classical conditioning/reverse engineering procedure involves the use of advanced technology as means of first gathering information on the target, creating a mental map in other words- a template or blueprint of the target.

Observation via the energetic frequencies of the target through specialized software and hardware in cell phones that record the energy bodies of targets-the deliberate provocation of targets while being remotely monitored through the walls of their residence by way of other advanced technology (eg. microwave telemetry and radar) by the cabal and its operatives.

The provocation mirrors that of Ivan Pavlov and whatever other jewish antecedent psychopaths whose history is steeped in the blood of aryan man as the history of torture bears witness to. They the perpetrators simply need an excuse to target the victim, ie. a heretic, witch; racist; 'criminal', etc.

Although in their own minds they have no need of excuses as they are their own justification-what they will is what is just according to their self-[mis]understanding.

The mental map they seek to create is based upon the stimulus-response relationship of pavlovian classical conditioning, in the causal relationships between their attempt to elicit a reaction via a stimulus (an act or omission which triggers a response) and the response of the target.

Observing this phenomena enables them to understand the target's mind by way of inference-infering the inner (state of consciousness) from observation of the outer (behavioral reactions).

The goal of the perpetrators is to derive information from targets through this exchange-based process, this dialectic of

1) imposing pain (what would cause the average person pain or annoyance and lead to their reaction) and

2) elicit tangible, observable signs of reaction which can then be recorded and entered into a database which will enable the perps to probe yet more deeply into the mind of the target and create even greater pain in the target and understand to an even more subtle degree the reactions and consciousness processes of the target and to accelerate their programming to such an extent that they are led to their death or are no longer of use at which point they are dispatched.

This 'stage six', the death stage, the stage of the gangstalking/targeting protocols occurs when the perps have had their fill of their sadistic enjoyment and have fully expended the targets' life as a resource upon which they may capitalize: in maximizing their gain [(pleasure in the libidinal economy and/or financial gain through making movies of their abuse and the sale of it or granting others the right to visit harm on the target for a fee, broadcasting their abuse live or on audiovisual record as a means of deriving even greater profit for themselves at the expense of the target ('blood money'))].

The mapping of the consciousness of the target is undergone to harm them maximally while gathering as much data as they can in the most profitable way possible through classical conditioning and the usage of advanced and in many cases secret technology unavailable to the public.

The mapping the consciousness of the targets is both external and internal-by way of inference as aforesaid and through the usage of the technology to view the world in the most literal sense through the eyes of the target, by gathering the biofeedback of the target and translating the brainwave activity into code which is then decoded into a mental map of the consciousness of the target.

Then the wedges are driven into the target as a means of imposing trauma to sate the sadistic glee of the cabal members and probing as deeply as possible into the core of the targeted person such that their soul is assessed in its nature or essence enabling the cabal to steal the soul or at the least to fragment and destroy it which latter enables it to be vampirized by entities with whom they are bound as its energetic food source.

To oppose this outcome the target must seek to construct blinds which conceal their thoughts, emotions and actions from the perpetrators so that the latter become confused as to the sincere nature of their targets, in other words to get out of the crosshairs of the perpetrators through feints and modalities of action which confuse and deceive.

This in conjunction with the building of the fortress of the mind-an impenetrable consciousness inaccessible to outside parties if at all possible both countering their superficial observation and intelligence gathering and the probing attempts to occupy that fortress through the advanced technology employed.

The fortress must have all of its rooms sealed with bands of iron and the most complex locks embedded in walls of super hard reinforced concrete. The mind must be as a supermax prison from which the intruder perpetrators cannot escape and cannot gain access to save in the S.H.U (special handling unit) wherein they are confined in solitary, can be identified and ultimately brought to the electrical chair and blasted away with electrical impulses into their neurons. Their influence is negated through:

- 1) isolation and
- 2) ignorance of their presence, overriding their presence with the mind's self-presence, its awareness of itself (awareness of awareness) and
- 3) through the maintenance of normal functionality not to be side-tracked with the foreign presence of the criminal miasma who has intruded into it.

This is where the training of the mind has its place:

- 4) the development of this fortress: target hardening one's True Self; situating oneself in the center of his being and 'bracketing off' all Otherness, all extraneity and harmful contagion of that which is not-self. The oriental conception of 'wu-shin' ('no-mindedness') is a valuable protective ward as is the zen conception of satori, the taoist conception of 'wei wu wei' (acting without acting), transcending in immanence the spatio-temporal context as means of building the 'armor of God';
- 5) Challenging the mind through exposing it to challenges which it can cope with though with difficulty as means of hardening oneself to assault, developing the power of the mind as a sword with which to give combat against the enemy. Thus one must as a condition of survival and to repel the attempted hijacking of the mind train oneself in forms of thought that strengthen the thought process.

The study of language and logic as well as philosophy (encompassing both) and regulating one's thoughts so that they attain crystal clarity and thus can serve as stones in the wall of the fortress of the mind creating a consciousness that is not necessarily rigid and inflexible but which has the cable-like sinews of a strongman who is agile yet can also repel assault. Hence rather than a stone, the structure of one's thoughts would be of a more holistic nature more akin to concrete assuming different forms yet not moveable by outside forces.

The Greek phrase 'gnothe seuton' applies-one must know oneself, the structure of one's thoughts, must map his own consciousness and in doing so may then restructure it according to perhaps superior trajectories and purposes.

The danger lies in the fact that the modern world is largely a construct of the jew and thus is inherently designed by him to serve as a trap for those who are of an inquiring mind and who wish to understanding reality, themselves and how to live which they would of necessity. It is like walking through a landmine field for the seeker of Truth, the landmines being placed by the jew as means of causing harm to the seeker.

Hence the corruption inherent in the modern world of the Zion matrix precludes its serving as a source of Truth-all literature, sold and advertised-all that which receives funding from the governments of Zion is to be cast aside.

Only a rediscovery of the Traditions of the aryan may serve as a source of Truth as only they are closest to Truth in the degraded forms of language and symbol. Hence the orientation of oneself towards Traditionalism in the sense of a Julius Evola is imperative as it alone can furnish external materials for the construction of the fortress of the mind and the forging of weapons of war needed to combat the enemy. Basic source for such materials are included in the reference section.

Entrapment Dialectics

The *modus operandi* of the jewish occupation government which enslaves the world is that of creating the illusion of 'the Good' being universal (for all) but in reality being good only for jews specifically. In order to deceive the population into thinking that they are doing what is good for themselves when in reality it is only good for the jews.

The latter invent whole 'genres of discourse' which confuse and beguile the masses, psyops if you will encoded in texts called 'sacred' or constitutions or bills of rights; systems of ideas and theoretical smokescreens which blind the masses to the actual legerdemain of the hidden hand.

These discourses are affirmed without any evidence save the homo-logicity (same logic) that is built into themselves to be 'True' and unquestionably sacred the violation of which amounts to a death sentence or some other form of punishment which the priestly caste establish as 'righteous' or 'just'.

Thus is established the morality of mores or the 'moral code' which regulates the conduct of the so-called citizens or the 'profane'-those who are 'subject to' the imposition of this code and must run within the narrow grooves that trap them within its bounds.

The establishment of such a code enables the establishment of a disjunctive set of behaviors and actions that qualify the 'citizens' as 'good' (non-'criminal'; non-'heretic'; 'true believer'; one of the 'faithful' flock of sheeple) or 'bad' (criminal; heretic; excommunicated).

On this basis those who violate or do not uphold the moral code through their actions (words; behavior; expressions of feelings and emotions) are claimed to have exercised 'free will' in non-compliance and are then subject- to (according to the logic of the moral code as a discourse) the appropriate specific punishment.

Those so qualified historically have had the opportunity to 'atone for their sins' to become in postmodern discursive terms 'rehabilitated' such that though a record of their transgressions is preserved and thus for whatever duration of time and then to whatever degree 'washed away' in priestly caste absolution.

The notion of the existence of crime (or its codification in a moral code) and its correlative punishment is not necessarily wrong or bad-this depends on the one evaluating things and whether the 'crime' and its 'punishment' are overall greater or less harmful and to whom (and what does 'harm' mean).

Thus a moral code is simply a construct of a particular group of priestly caste elites and what they have established as 'just'; 'true' and 'lawful'. According to the author any moral code which does not cohere with the overall harmony of the sum total (what is 'godly') is 'bad' or 'unjust' and any which does is 'good' or 'just'. This does not mean that the current moral codes which have existed under the Piscean regime of Zion (from the creation of the notion of 'all men' or 'humanity' in the ancient Near East and from christian Rome to freemasonry) are 'just' as if they, if the author rightly understands them, are embodiments of hypocritical egalitarianism which subsumes under the concept 'man' all bipedal beings and elevates jews beyond the non-jewish bulk of 'humanity'.

Hence the moral code of postmodernity is factually incorrect and thus unjust to support as not cohering with the Cosmic law (the Divine Order of differentiated manifestation). Those who are unwilling to support such an egalitarian moral code are deemed by the priest caste 'anathema maranatha'; heretics; criminals, etc. and are subject to the appropriate penalty, perhaps initially as a threat of its implementation but ultimately in its applied form.

Witch Burning

The vampire psycopaths of the contemporary society of 'Zion' are no different than they have ever been throughout their history and neither are those peasant slaves who expend their barbarous lives serving them as witless minions.

In the medieval ages those the priest caste deemed 'witches' or 'heretics' were burnt at the stake, those who did the burning and the informing against the so-called 'witches' were the peasant mob who had been programmed from birth to slavishly bow down to what their priestly caste masters called 'the law' (of 'god', the *vicarious filiae dei*; the priestly caste 'interpreters of the law', etc.) without thought or question.

These peasant minions were conscripted to burn down and destroy any who had that stigma projected upon them by their masters and imitated their masters ('will to power') in attempting to brand those who behaved or appeared the slightest bit dissimilarly in the same manner, deriving a sense of power and importance through attempting to assume the role of judge, jury and executioner or at least facilitate the process through casting the first stone under the apparent auspices of 'the law' (of 'God', etc.).

As then, so today the brainless mob are conscripted through their mind programming to persecute, spy on and inform against any of their kind, of the 'citizens' who do not appear or act the same as themselves-eager to condemn and imply their deficiency or negative traits (mote pickers)-will to power. It is the will to power of those of beast consciousness-those who are incapable of elevating themselves above the level of the brute-that leads to the modern witch hunts and burning's.

The witch of today is the so-called 'racist', the heterosexual aryan male (and often female but not as frequently, as given her comparative physical weakness, the jew world order has still not made it popular to assault aryan females-not yet but soon undoubtedly) who advocates his own self-interest *qua* aryan male and that of his Race over and against that of Others and of necessity over and against that of Others (given the competition over power and resources necessitated by life).

The modern witch is the racist and the witch hunting mob are unleashed by the priestly caste to inform against; attack; shun; condemn; insult and ultimately to kill and torture to death those deemed 'racist' by the priestly caste. The witch hunters are mobilized and trained to attack and destroy their opponents with ruthless sadism and are rewarded by the superlatively sadistic priest caste for their efforts.

Such a mentality creates a 'society' of sadism-a 'society' of neurotic inhibition of the regularization and regulation (through Talmudic style laws) of the consciousness of the mob- which is a purely hive mind entity and which is 'shaped' in the parlance of the jewish neo-liberal marxists, into a monster of violence when the priestly caste deems the time ripe.

The witch hunts lead to the acceptance of the witch burnings which are undergone in myriad forms both metaphorical and literal-metaphorically the witch burning is undergone through burning the bridges the 'racists' have to society such that they are prevented from having employment and access to not only the conditions that would enable them to have a meaningful life but to live at all, killing them in a way cruel and unusual which factors in the act of burning, namely the usage of directed energy weapons to torture and eventually to kill the target-the 'racist'!

The entrapment employed in the gangstalking phenomenon is based on the same [priestly caste self-legitimizing discourse/rhetoric: that which is permitted in terms of any actions (speech acts; physical acts)] the target can undergo (permission) and must not undergo (prohibition) is derived from axioms built into that discourse or dogma of egalitarian secular humanism or abrahamic or mainstream religious monotheism (Hinduism; Buddhism; Christianity; Islam)- in short egalitarian pacifism.

Those not subscribing to egalitarian pacifism are marked for the targeting and harassment campaign. However even those who do go along with the agenda are targeted and should the cabal desire to target them for their sadistic behavior, will be and are then subject to the limited parameters that circumscribe their actions (what is permitted; obligated and prohibited-the modal logic of the cabal as it applies to the targeted person).

What is permitted/prohibited/mandatory is made known to the target by way of inference, through the circumstance the cabal orchestrates surrounding the target-controlling their options in life and imposing upon them conditions which necessitate certain actions as means of attaining certain outcomes-a game theoretic situation imposed by the puppet masters of Zion who derive sadistic delight playing with the pawns in their game of life in the theater of the real.

There is always the presence of a 'choice' for the target. They are presented with temptations and options that enable them to pursue or forbear from a course of action both of which lead to rewards or punishments or yet further situations with rewards or punishments associated in a perpetual movement on the chessboard necessitating countermoves on the part of the target as means of self-defense.

The Zion masterminds orchestrate entire schema of scenarios which are played out with the myriad pawns they have conscripted into their post modern version of the Cheka of the Soviet Union ("community policing" and "infraguard"). This as means of conducting fourth generational warfare against the populace for the attainment of their goals of deriving perverse delight in abusing those not as intelligent as themselves (perhaps) or at the least not as temporally or spiritually powerful as themselves.

The end goal is total control via mapping human/aryan consciousness and creating algorithms which regulate the lives of their slaves so that they can maintain a soul farm prison planet in 'perpetual balance with natural law'.

What they fail to understand is that their finite consciousness isn't adequate to circumscribe Being or 'God' and thus their 'closed system' is in fact open-has countless leaks unidentifiable to their necessarily limited understanding and for that reason could never succeed in maintaining itself especially as it operates on the basis of the lie, that which does not and necessarily could not agree with Truth, (i.e, Being).

Nevertheless the target is forced to play the game as means of continuance though temporary survival in physical reality. Paradoxically in order to continue in physical reality the target must keep their head in the clouds (Cosmos) as means of becoming an adept player of the game through supra-rational intuition. The cabal seeks to entrap them in the matrix-but they don't live there, hence they cannot be entrapped. If they are aryan.

Monotheist Madness

Monotheism is a creed borne of the Levant, what might be more appropriately called a 'Levantine disease'. It stems from the ancient mother goddess religions existent in the whole of Asia Minor-the fatalistic self-denying creeds of Chaldaens, Canaanites and Sabaens et.al-all semitic societies. Societies of a semitic caste were necessarily societies that served as the crucible of this monotheist creed.

The reason is that monotheism is simply a positing of a superior value having no determinative qualities or attributes and yet overarching all and sundry, indeed being all and sundry itself such that that which are merely parts of the whole (the beings of Being, creations of the 'Creator') are worth less than their sum (ie., 'the One'; 'Being'; the pantheistic mother mater) and on that basis they have no value in their being save in relation to that whole which is greater than the sum of the parts, their value (necessarily subordinate) lying in their having to prostrate themselves before 'the One', to serve it (the Creator) as a mere finite and fallible creature.

The reason why this is a specifically semitic creed is that it is a creed which has a fatalistic dimension inherent within it and such a fatalism is an inherent behavioral trait of the semite. The reason why the semite possesses this property of fatalism is that they are of a weak constitution which is attributable to race-mixing (or 'the fall of man', interbreeding between the anthropoids and aryan millenia ago) and the consequent genetic deterioration that has resulted in their being genetic chaos on earth, spiritual chaos in heaven-in the higher planes.

The creed of 'Oneness', of monotheism, is a creed borne of the sickness of the semite who, understands suffering and misery on earth via his mongrel constitution being the embodiment of genetical-demonic chaos. It is as Ben Klassen has written of in "*The White Man's Bible*" a "cowardly flight from reality"-an escapist fantasy that appeals to those of weak constitution who have no willingness to engage others in the *bellum omnia contra omnes* that is the struggle for life in this world.

However monotheism may have a saving grace insofar as it-as a theoretical construct or worldview-can accommodate the differentiated order of beings that it posits as its 'creation' or 'emanations from the One'.

Insofar as a monotheistic creed can accommodate an acknowledgment and support of mundane Reality in the form of organic life (life which develops itself out of itself in relation to the sum total) and its differentiated being it is agreeable with Truth. A creed of that kind may be called one preserving 'Cosmic Law' or 'the Divine Order'. One which advocates a promiscuous mixture and combination of different beings, collapsing all into one in the form of monotheism peculiar to the semite-a desire to simply so-to-speak 'throw in the towel' and forfeit the victory to the stronger and healthier organism or to defer to the stronger deliberately owing to their 'sinful' or 'evil' nature, inverting values and positing weakness as virtue and strength as vice such that "the meek shall inherit the earth" and "the last will be first and the first will be last".

Such an inversion of values is borne of the constitution (genetical-demonic) of the chandal mongrel who seeks in irrational fury to tear down the superlative stronger and healthier 'Other'.

Nietzsche was only partially right however as he completely neglected the spiritual dimension of 'beings with Being' (Is-Ra-El-"Man with God") in their being, namely the aryan. Perhaps he understood but only revealed it through a glass darkly or perhaps his creed was simply put forth as yet another theoretical/philosophical red herring leading the aryan away from a higher spiritual worldview and state of being towards a debased form of naturalistic existence?

Insofar he played his part well dragging the aryan from the stars to the slime pits of pantheistic naturalism and into the primordial ooze. However he was right about the chandala and their 'gutter creed' of 'Oneness' and the fatalism inherent in such a creed-a laying down, bowing down, a voluntarily exterminating oneself as means of attaining an illusory "pot of gold at the end of the rainbow"; 'treasures in heaven'.

Such is the revenge of the wandering jew-to seek to sabotage and destroy the superlatively endowed aryan as a means of exalting themselves even if only for a moment of pyrrhic victory. This monotheism may be divided into two forms-that of the aryan and that of the semite-both entirely contrastive, oppositional forms of 'Oneness'.

The aryan entails a preservation of Cosmic Order in its differentiated Being and the semite a destruction of all beings into a seething cauldron of 'Being', of chaos-the dark feminine mother goddess into whose womb are absorbed all and sundry-a reverse virgin birth-parthenogenesis; melted into oneness in the womb-tomb of the 'sacred mother', the sacre mater of pantheistic naturalism wherein all are one and their being matters not-simply Mater's, the possession of 'the Mother' (Cybele; Kumbaba; Typhon; Tiamat; Jormundgand).

The monotheism of the aryan is that of henotheism: that all god-forms are hypostases of Being, of the Absolute in whatever form of representation, merely allegories of the stars (and beyond) and their influence upon the earth, 'as above so below'. Also it is an ontology and metaphysics encapsulated in mythopoetic form. The current monotheism which exists is the semitic overlay upon that of the aryan.

A project of the unconcealment of that Tradition is underway and will lead to the transmutation of the monotheism of the semite into that of the aryan enabling the radiation of the Truth to banish the darkness of the mayavic curtain and observe the semitic priests of the mother goddess pulling the levers and gears of the matrix machine and dragging all down into the slavery of Oneness-dragging the aryan down from the stars into the mire. To awaken the aryan within the population through a representation of their proper Traditions is to blind the wizards and to banish darkness.

Truman Show...Or Jewman Show?

Theater of the real. The jewish theater directors set the stage for the orchestration of the chaos that they impose upon their unwitting actors. From false flag operations to the ritual murder of those they force to play a role in their dialectical games of manipulation, the theater skits continue with one 'goy' being played off against another. They have different costumes and play different roles again unwittingly, without understanding the mainsprings of action of the theater props which constitute the backdrop of their consciousness and without understanding the insignia and symbolism which they are branded with as cattle.

The theater of the real is the "Truman show" of postmodernity-the players are experimental guinea pigs manipulated and played off against one another to the delight of the psychopathic controllers. They are 'true men' in the sense of being true chess men on the chess board of the ruling powers but 'false men' in the sense of an inauthentic man, those who are mere masks of personality overlaid on physical robotized meat puppets whose external tissue (face; appearance) is woven of synthetic tissue and has no reality save as an artificial construct, one of the golem of the jewdeo-masonic hidden hand.

These marionette players on their electromagnetic strings are jerked about by the hidden rulers as their puppets playing their role according to their programming. The show could not be anything but false as it is a scripted series of events designed to create certain states of affairs, changes in the aether and to precipitate a new aeon.

The show appears to star 'true men', heroes and villains who are mere caricatures who carry out their preassigned roles without thought or question: those who are elevated to the status of hero today are brought low as defeated former victors tomorrow, all according to the game theory of the jews who wish to tear down and destroy those who are truly heroic, 'true men' in a real sense and to portray them as the villains as means of inflating their own status through attempting to obscure the brighter shining star.

The jewman show is re-presented before the eyes of all as means of tearing down and destroying the good, the true and beautiful by those who are deficient in these qualities and as means of presenting to their enemy the aryan Race the downfall of the latter's former glory observed in real time. This is their 'revelation of the method' that reveals their cards to the goyim before they play their hand as means of transferring responsibility for their own karma, their own bad deeds to those they are harming . They thereby blame the victim for what they themselves have done and are in the process of doing to their enemy.

The jewish director of the theater of the Real spends his time drafting up skits and scripts, designing props and backdrops in his holly-jew (holy-jew) studio of the Real with his fellow serpent seed whose funding is derived from the life's blood of their goyim slaves. These willingly participate in the theater of the real as pawns on the chessboard, worshipping their own executioner or the 'master race' and extending their necks to be placed in harness for the right to feed, fornicate and propagate as the goyim cattle they are.

Those who are genuine, authentic 'true men' are the heroes of the theater of the real who understand through higher gnosis that 'life is a stage and we are all but poor players' and who work towards the tearing down of the curtain of the wizards of Zion, revealing to the sight of others the inner workings of the theater of the real and the 'jew man' behind the scenes of the artificial reality all are trapped within. Like the movie starring the jewish serpent seed jester Jim Carrey, the world as experienced by the 'goyim' is mere illusion and those who dwell within 'know not what they do' are hapless pawns who lack all agency and refuse to acknowledge-indeed have no capacity to acknowledge-that they are but 'poor players' on the stage of life.

Common Purpose: Communitarian Bullying

"We are all one"-such is the fundamental precept of the world order. This precept is also a presupposition-a question-being an assertion as to who 'we' are and what the unity of this paradoxical plurality is that would make of the many 'one'. Such an assumed truth (with neither rhyme nor reason) is the operating premise upon which the world order runs.

Deviating from this principle, the presupposition this precept, one will be targeted by the 'community' who are all entrained to conform to one another's behavior which follows the blueprint or template of the architects of the world order and their impositions upon the mass.

The 'common purpose' of the communitarian collectivist society is this fundamental principle, this assertion of unity. Those who disagree with this principle and especially who actively oppose it (even simply non-agreement is adequate) are violently suppressed to the extent of their being subject to torture murder by 'the community' taking orders from their jewish masters the 'community' within and behind, and indeed above the 'community' of the communitarian society.

This amounts of course to a soft totalitarianism, standardization protocol wherein each and all are reduced to the lowest common denominator, sufficiently intelligent to serve the cabal and not more. The 'common purpose' of 'the community' is the genocidal purpose of 'the community' in its gambit for the elimination of all competitors for power and the gullible dupes of judah below this 'community' of jewish oligarchs. The masses believe in their extreme ignorance and egocentrism that they themselves have this purpose as if it were an invention of their own and as if they were some form of 'champion' of this 'oneness' rather than being a mere puppet jerked about on the golden and electromagnetic strings held in the aryan-gloved hands of jewdeo-masonry.

The purpose of the cabal is effected through its totalitarian nature-there is no room for any difference in the 'unity' mandated, as this kosher mandate negates all 'Otherness' to itself, itself being an idealized construct of miscegenation, the mongrel of the world order 'citizen of the world'.

This creature, Frankenstein's monster, is what the jews have envisioned as the 'man' of the future which is in reality simply a grotesque mockery of man and is merely a distortion and perversion of what heretofore has qualified as 'races of man' though such a historically archaic qualification itself was a mockery and distortion of the Hyperborean archetype of the aryan man, from whom all current, historically acknowledged 'races' descend and this via miscegenation with proto-mongols and proto-negros on the part of the aryan race.

The 'common purpose' of the cabal is to establish as means of achieving this purpose, the lowest common denominator on a pedestal and to panegyryze this Frankenstein's monster in the making of the 'future' result of progress, the pot of gold at the end of the rainbow road of 'progress'-progress towards the global dominion of jewry over the easily controllable docile mongrel slave. Such a pot of gold is yet mere illusion as the apparent pixie dust that wafts from this melted pot is in reality the noxious vapor of faecal matter that is simmering in the sewer pot of the multikult and is merely concealed behind the mayavic veils of 'rainbow reality'. Such is how the illusion makers craft their 'common purpose' and serve it up to the 'goyim' for their supper. Those who 'smell a rat' in the cereal bowl of multikultism and have no willingness to swallow the rubbish are targeted and placed in the cross hairs for extermination by the cabal.

Crepusculum

The twilight of the gods is apparently upon us at this point in the nadir of the Kali Yuga. The creatures of this twilight, those who are the crepuscular remnants of the fall of man in their lowest forms (beastmen; jews and degenerated arians whose body-soul-spirit complex is internally divisive and divided amongst and against itself).

Those chandalen untermenschen are carrying out the intentions of the dark forces, bringing down the world into a state of chaos according to their programming-that of levelling equality in the name of abstract emotionally charged terms such as 'Love'; 'Peace'; 'Humanity'; 'Democracy'; 'God', etc.

Such crepuscles of the twilight seek to douse the Light of the North-the arian, who they beset on all sides working towards his downfall. The war of all against all (*bellum omnia contra omnes*) is upon us and the night threatens to fall as an iron curtain over the once great spiritual heights of arian man.

The gangstalking protocol is yet another sign and symptom of this degenerative process of this aeon which culminates in the ragnarok's implosion-explosion. The impure elements are discarded and the pure in their purity remain to be formed anew just as lif and lifthrasir are formed anew in the tale of the Edda.

It is the nigredo phase which the author here designates, using the ancient Roman Latin language, 'Crepusculum'. Only the night vision of the arian, the pole star can guide him through this tenebrous state of being, that being concentrated in the pineal gland and pituitary body-the light of the Divine Spark, inherent in the Holy Graal.

The gangstalkers are the crepuscles of the twilight-they are the walking dead, the zombified goyim who are possessed by the archontic forms of the vampires of Zion, avatars to wreck havoc and bring about their own inevitable fate-that of complete destruction in this world and in the next undergoing the second death in the lake of fire where the dross of their soul will be burnt away in the crucible of their own iniquity.

They are the damned. The onus is on the arian to ensure they don't meet a similar fate. In order to overcome the 'fate worse than death', the conscious slow disintegration of the soul through a life of karma/sin, the arian must seek to develop and rekindle to the greatest degree the brightness of the Divine spark within. This can only be achieved through a development of the Will through combat and opposition to the darkness-doing one's arian duty.

To develop an attunement in one's thoughts, emotions and actions with the Divine Will. Only insofar as he can transcend the crepusculum of the Kali Yuga-not allowing himself to be dragged into the abyss of the 'corrosive waters' will he be able to preserve his soul regardless of what damage is done to his false self within the spatio-temporal realm (maya).

His only option is to spiritualize his physical body through the appropriate spiritual practice and to thereby create the diamond-thunderbolt body as means of hardening himself to unassailable diamond hardness spiritualizing the material elements of his body and, like a thunderbolt being able to use his spiritual power to combat the enemy. Only then will he ascend to the heavens and dispel the twilight of the gods making accommodation for their return to first Hyperborea.

Cognitive Infiltration

The targeting of the person has as its end goal the decomposition of and vampirization of the soul of the person. The term 'person' is used here in the sense of Julius Evola-an integrated being whose body-soul-and spirit are harmoniously integrated and are not structurally related in any way that would create a disintegrated Self at least at the lower dimensions which is the purpose of the cabal-disintegration and 'decomposition' of the lower self (body/action and soul/emotions) and its detachment from the Higher or True Self such that the formation of the Absolute personality or diamond body cannot be attained by the person.

This means further that the aryan alone is a 'person'. 'aryan person' is a redundant term given that only aryan can be 'persons' given that they alone have a Higher/True Self owing to the relative purity of the elements of which they are comprised, having been derived from the Hyperborean aryan who are the Creators of all originary civilization on earth from the North as the light of the North-radiating outwards from East, West and South.

Thus only the person who is fallen but redeemable can attain the state of the aryan-the diamond body, can become so-to-speak a twenty four karat personality, the gold of his ego becoming illuminated and purified in the transmutative process of the alchemical crucible of his will and skill.

Thus we must leave aside the term 'individual' and refer to targeted persons (the Absolute personality *in potentia*, in germ, whose Divine Spark glows yet dimly) and can thus properly orient himself along an upward path of combat against the forces of darkness who are soul vampires and soul destroyers seeking to sever all aryan people's connection to the aryan state of being as a means of:

- 1) stealing their soul energy, and
- 2) nihilating any opposition to their absolute temporal and anti-spiritual power on the earth.

The means of doing this may be called 'cognitive infiltration', the mental rapine and torture of the person. This is done in stages beginning with monitoring and surveillance of the person by the cabal and its minions employing advanced surveillance technology and from that stage, once a preliminary collection of data is gathered on the person the second interaction with the person and revelation of the method used as a means of traumatizing and manipulation of the person, itself a subordinate means to the mapping of the individual's consciousness and its destruction and vampirization.

The mental map acquired is used for further control (the power-knowledge relation here being related to the formation of the 'jewish utopia' of Zion and accruing to the cabal occult power through demonstration of dominance over the person which elicits a power rush in them, a testosterone boost and a diminution in the power of the target).

This control is then made known in the second stage to the target in a feed-forward loop rather like whipping an animal so that it increases the pace of its motions and furnishes through stress responses to the stimuli more bioenergy that the cabal and its astral parasites may feed off (the so-called 'archons' of gnosticism or the 'asuras' of the Bhagavad Gita; the 'mud shadows' of the shill Carlos Casteneda; the 'reptilians' of David Icke, etc.).

The programming becomes accelerated through the feedback of the target-the more the target responds the more quickly the targeting may progress such that they are led along their predetermined course from the initial targeting to ever increasing abuse and feedback and to the assassination of the target as the ultimate end goal.

The infiltration of the targets' mind is undergone through the stimulus-response classical conditioning procedure which enables an ever more subtle mental mapping of the person. This mental map can then be-the cabal reasons fallaciously-extrapolated in a universalistic fashion upon all.

This of course is false as those who are aryan (if only *in potentia*) are not of the same species as those who are non-aryan and thus to apply data gleaned (assuming it could ever be gleaned) from arians to those who are radically dissimilar to such an extent that they constitute another species is fallacious-the nature of the aryan man can never be comprehensively known or circumscribed by those of a more finite consciousness whose consciousness is limited to maya-the veil of appearance or the realm of illusion, the corrupted forms in their distorted being available to the five senses of the chandala.

The beastmen and jews who seek to infiltrate the consciousness of the aryan through their classical conditioning manipulation (sadistic ritual abuse) are no different than a back alley ghetto criminal seeking to rape a aryan woman as a means of asserting power-knowledge relations over and against her in a master-slave dialectic.

The absurdity of such an act of the part of the cabal mirrors the absurdity of the ghetto savage, the ape of the concrete jungle: they would nihilate through dominance of a crude intrusive kind the being of what they deem 'prey' but the reality of the situation (ontologically) is simply that of a low brute employing crude and materialistic means to assault the lower vehicle of the higher being who could never be assaulted in their higher being by that which is lower.

The end result is merely the leaden chain of karma being welded to their necks and their being dragged yet further into the abyss through their own disturbance of the forces of Being, creating ripples in the pool of life which caromb against them. The mental rape of the aryan is merely an attempted assault against the fortress of God and his children who participate as elements of His Essence in His Mind as emanations thereof.

To guard one's lower vehicles against this mental rapine one must guard the fortress of the mind through orienting it towards the large fortress of God/'Being'-unifying the lower, the self which is entangled in the mundane states of transient sensationalism, scattered and fragmented in its essence and concentrate one's forces, his energies through orienting his will upwards through becoming a vortex of energy whose higher faculties govern the lower, thus organizing them in a centrifugal fashion from the periphery to the center, a cementing of the scattered materials of the fortress of the mind into an integral whole.

The first step is a concentration of forces, from there it is a strengthening of these forces such that they fuse one with another and enable the deployment of oneself against the enemy. Strengthening one's forces entails a perpetual challenging of oneself, an exercise of one's faculties and this in such a way that weak links are eliminated or forged anew both in the crude terms of neuroscience (axonal connections) and in those of higher ones.

Developing stability is key-stable forms of thinking which would serve as a basis for subsequent expansion and development of the new terrain being conquered by the army of thought and appropriated into the empire of the mind. New territory must however not be too foreign and dangerous that it threatens the possession of territory currently established within the borders of empire.

Thus one must send out his legions to conquer more and as a consequence will have more territory to move about in (different languages; different modes of thinking and being not exclusively cerebral but modalities of consciousness all of which should be reigned in by the phalanxes of his legionnaires-his thoughts, emotions and actions governed by the general his will and the higher principles of his consciousness).

To build sufficiently strong ramparts against the evil tide one must have the weapons to defend oneself against their perpetual assault and the mind is the goal , the territory over which the war is waged for its possession and superior development by the aryan or its being raised to rubble by the hordes of the dark side and plundered of all of its worth.

Kindly Killing

The hypocrisy of the vampires of Zion manifest itself in the behavior displayed towards the 'Other', the enemy or exploitable tool of the cabal and its purposes. For those who are exploitable they are manipulated by the cabal into thinking that they the 'human (goy) resource" are an affiliate or associate of the cabal when they are in reality a mere tool or dupe.

For those who are unexploitable or a combination of being exploitable and an enemy whose existence and/or purposes are viewed by the cabal as antagonistic to their project of global dominion, they are treated with the behavior and action that leads to their elimination once no longer exploitable-which is the ultimate end goal of the cabal regardless of the willingness had on the part of their goyim slave caste.

Thus the cabal is by nature in its essence a vampiric murder machine or combine-a combine harvester which rolls over the 'Other' and vampirizes their soul into itself to augment its power regardless of the lives of Others who, by virtue of being deemed 'Other' are stripped of all value beyond an exploitable resource and or an antagonist, an enemy.

Thus the cabal is an enemy of all and a friend of none save itself (and even then it is comprised of a nexus of inner antagonisms that are reconciled only through the greater antagonism towards the 'Other').

The mechanism of enslavement, exploitation and murder is always that best conceived of in an image: the hidden hand and the iron fist in the velvet glove-the apparent benignity and even altruistic 'Other' regard and the actual *de facto* 'Other' disregard, the Other being regarded only as a target in the crosshairs of the cabal.

The smiling mask is worn as a means of pacifying the Other, the target. It is the mechanism of entrapment, the piece of cheese inserted into the cleverly concealed trap.

The multifarious means through which the kindly killing enterprise is orchestrated span the gamut of cabal operations in all of the facets of the black diamond of their system: economic; legal; medical; educational.

In terms of economics the slave class, in the name of 'civic duty' are coerced to work as a necessary condition of being permitted to acquire the conditions of life, having to pay for basic necessities which deprive them of all of their liberty and substance-their potentialities to cultivate their True Self being sabotaged through the lash in the form of the police state which is the main instrument of coercion ultimately as force alone prevails over any specious reasoning to the contrary.

The goyim are deceived into thinking that their 'noble efforts' of serfdom are not only necessary for their own survival as 'their lot in life' but are a 'moral virtue' that is commanded by an anthropomorphic Deity.

The economic endless chain keeps tethered the goyim furnishing the slave masters of Zion with a leisure life of tax farming, vampirically leaching the blood of the so-called 'worker' who is reduced to a state of mute drudgery, a mule existence without any higher life beyond that of the brute.

The legal system also wears the smiling mask of virtue-the kindly and benevolent judges, lawyers and police who reciprocally support one another in a thieves pact of enforcing the overall system of slavery and exploitation in a way portrayed as 'just' and 'good' in the eyes of the masses who have come to associate 'the law' with 'goodness' when in reality it is merely a set of rules and attached penalties established by the sovereign authority and enforced through the iron heel and iron fist of 'security forces' whose operations are justified at this juncture to the demos (democratic mob) as 'safety and security' without the latter's understanding, just who is furnished with safety and security, and what that in general means.

The means of safety and security for 'humanity' and 'people' of course relates only to the cabal as in their understanding only they qualify as 'human'. Thus it is their interests alone which are upheld and the slave class are trodden under the heel of the police state when they refuse or fail to pay the slave taxes, their exorbitant rent costs and various other fees and fines all of which are absorbed into the coffers of Zion. Those not able to pay will be shut out and fall into the streets or shut up in a jail cell or mental institution by the police.

The mental health profession, a subdiscipline of the allopathic genocide system, is simply a means of disposing of those the cabal deems a threat or 'expendable' owing to not being a useful 'human' (goy) resource. This imposition is justified through any and all means by the jews and their operatives who seek to build a consensus as means of convincing the goy to accept counseling or 'mental health' treatment which eventually builds towards an 'evaluation' by a psychiatrist or psychologist and the end result is institutionalization (ie. coerced confinement under unhealthy conditions). This leads to the coerced drugging of the 'goy' with pharmaceutical poisons and probable experimentation on the 'goy' with advanced directed energy technologies such as particle beam and microwave weapons to facilitate the transhumanist agenda of the robotization of the slave class.

The smiling mask of the 'caregiver' is in reality a form of concealment of the ulterior motive-the monstrous facade of Mr.Hyde who grins with sadistic glee over his prospective visitation of harm upon the 'goy'.

The political system is yet more of the same 'kindly killing', the parliamentarian dialectic moving back and forth like a pendulum based upon the force of the manipulation of the mass mind through propaganda-voting for one party one term and its opposite the next as means of dividing and conquering the population against itself, dividing "the Egyptians against the Egyptians" with characteristically semitic guile.

When the ruling power acts it does so '*in nomini populi*'-in the name of the goyim and proceeds to harm, enslave and destroy the populace in the way most efficient and effective for the service of its own ends-from foreign wars to the mass importation legally or illegally (the latter by passive allowance; forbearing from acting to curtail their intrusion) of violent savages who achieve nothing but destroying the culture of the population, creating violent acts against them and draining them of their life's blood economically and in every sense destroying their quality of life. The smiling political hack, mere actor in the theater of the real and puppet on a string controlled by the cabal, promises the goyim the moon- and gives them the moon, ie. his posterior-not what they desired or understood his false promises to mean.

The education-indoctrination system is yet another instance of the hypocrisy of Zion. The so-called 'teachers' having nothing to teach having never been taught the Truth and accordingly serving the role as mere robot puppets broadcasting pre-recorded propaganda messages into the minds of their charges. The gullible youth become mere ciphers of the dogma the teachers' have implanted in them from birth having no critical distance from the twenty four seven programming and no capacity for critical thought or reason.

The foundation of their education is the false premise of materialistic pantheism, otherwise an empty semitic monotheism-and from this false premise follows the equally false conclusions:

1) all are 'one' and

2) anything not behaving in a uniform manner deserves to be forced into compliance with the uniform standards prescribed from on high by the shepherd king priest caste of judeo-masonry and enforced through the mechanisms of state backed up at the point of a gun.

The quasi-police of child and family services departments or organizations [whether private or public-all are 'one' after all in a 'communitarian society'] are the mechanism of enforcing compliance with the will of the oriental despots of Zion the educational-indoctrination curriculum is that of 'crepusculum'-the twilight of the gods of the aryan Race-the nigredo blackening of the 'Light of The North' by the black magicians of Zion.

The outcomes are emotionally unstable, mute slaves who at best (worst?) are tools of industry, 'human'/goyim resources exploited until such time as they forfeit their value by the arbitrary will of the cabal who is the Damocles' sword positioned over the heads of their slaves, ready to let fall upon those deemed 'anathema maranatha'.

The gangstalking and targeting are specifically designed to expedite the departure of what the jews deem 'qliploth' (incomplete souls) from the earth through the harassment and abuse of the target which the cabal surmises will to a high degree of probability elicit a reaction from the target that will justify the invocation of the 'community'- (the jews and their shabbos goyim) to initiating the cascade of dominoes of the system's mechanisms: forced police intervention or more subtle means of coercion to lead one to a jail cell or psych ward and/or the streets and from there to ritual torture murder after being experimented on. Such is the 'kindly killing' of the killer clowns of Zion.

Regressus Ad Infernus

Both individually (personally) and collectively the modern world and its denizens are a product of the regression of aeons from the golden age of hyperborea to the iron age or lead age of the Kali Yuga at the bottom of the cycles of Time. The demiurgic time flow of becoming, overlaid upon Being has dragged down the consciousness of the aryan and involved him via involution in the corruption of lower density states of being, threatening to bury him in the leaden casket of the second death.

His consciousness existing as a stone within the larger river of Time-flow, is dragged downwards opening up paths of involution via his pure ancestors' mixture with the anthropoid beastmen millenia or perhaps longer ago transferring the spiritualized Higher man, (the aryan) into the debased sub-man of today.

Thus this involutive process is a *regressus ad infernus*-regression towards the hells of non-being and dissolution of one's being amidst the river of the corrosive waters of Time-flow. To seek eternity amidst this maelstrom of chaos is to attain it or at least to do one's best in the attempt.

Thus he transmutes himself from lead into gold, at the very least fool's gold on the path of the fool to avoid drowning in the corrosive waters.

His project and mission as an aryan is antagonistic to that of the jew, the 'robot of the demiurge' as the jew was called by Miguel Serrano. The aryan project is to seek the light while that of the jew is to conceal the light and if he could ever do the impossible extinguish it in the darkness of lies and simulacra and simulations he seeks to impose upon Being as a marionette on the threads of the puppet master Demiurge.

Thus in order to combat and counter the evil tide he must progress towards the light and this first and foremost the light within, rekindling the Divine Spark which has undergone a dimunition of its refulgence since Hyperborea through the process of involution, the solidification of the brains and of the pineal gland through ever-increasing densification of Spirit into matter.

'*Progressus ad Aeternus*' this as a counterstrike against the regressive forces whose inherent defectiveness leads them downwards towards the hells-*ad infernus*. The protocols of jewry and their masters are directed towards that end and this exclusively-for to strike out in shaudenfreude against the aryan is to accrue to himself the pleasure of harming another, the dopamine spike and concomitant sensory exitation of the lower senses that he and his masters through him crave and experience.

Hence the jews' perpetual orchestration of circumstances and events that the jew intends to cause harm to the aryan (the definition of 'evil'-willfully causing harm to an 'Other', which Other is not causing harm to oneself and which Other does not disturb but rather preserves the harmony of existence).

The multifarious means the jew employs in his intended strike constitute the repertoire of his debased 'knowledge', his 'false light'-base-borne trickery of the lowest stamp, 'baseborne' here referring to the sub-human state the jew possesses as derived from *homo neanderthalensis* and combined with other non-aryan anthropoids, possessed by the demonic entities he calls 'angels' in his qabbalistic black magic. *Regressus ad Infernus* is the fate of the jew who embodies within the germs of his own destruction.

Death Setence

The protocol of gangstalking, the phenomenon of the 'targeted individual', the act of placing a person/individual in the crosshairs is intended to be the visitation of a death sentence upon that individual/person by the cabal. It is an act of black magic deliberately undergone as a ritual cursing of the person/individual the cabal hates and/or wishes to abuse for sport in the same manner as the beltane hunts of yore.

However there is no certainty of success for the cabal least of all at higher dimensions of being, at most only on the earth plane the cabal can destroy the person/individual in the physical and seek to destroy or debase their soul through the underhanded and cowardly techniques they perpetrate against the target.

The onus is on the person to save their own soul and escape this fate which challenge is a life or death matter-life deriving from the combat, opposition to the dark forces and death resulting as an inevitability through the laying down of arms.

This is why the jew seeks (through multifarious means, to dispossess and disempower the aryan through gun control legislation) through the distortion and concealment of Truth in the jew's propaganda organs (media and akadumbia) and in every way possible to strike at the sources of power of the aryan, to render him weak and easily controlled as a slave that can be exploited by the jews for taxes, tithes and the labor of the willful aryan and most significantly of all the aryan souls who he the jew seeks to vampirize and appropriate into himself and into that of the archons with whom he is involved in a thieves' pact as the eaters of souls.

A death sentence comes to he who acquiesces. To he who resists he obtains a birth certificate-giving birth to his True Self from out of the state of living death which would otherwise be his temporary stay in purgatory while the archons and jews vampirize his soul. He thus attains a mehr als Leben-a 'more than life' state which enables a transcendence in immanence out of the matrix while still dwelling within, in the world not of the world. In the world for combat and opposition as the necessary condition of remaining within the arena. He has purchased a ticket to fight another day and faces the fatwas issued by the cabal in the form of a death sentence which he confronts at every step and at all times.

Nonetheless he the aryan rises above it in immanent transcendence and against it in a recognition of the proper trajectory for the deployment of his will.

Metropolitan Prison

The Zion matrix orients itself around quantity-its architects draft up blueprints of rationalistic closed systems, of quantitative prisons whose 'elegant' (fie upon the word in its inappropriate aesthetic) 'necessity' precludes any existence or being outside of the system.

The closed system leads towards static Being without recognizing the being of Being-that it is neither static nor closed but an open system that admits of Eternity in becoming: "let there be light!"- Let there be life. The Zion prison seeks to entrap Spirit in matter in a crystallized casket of superhard concrete, in finitude.

Its administrators-wardens, jailers, et.al work towards the stifling of the dynamism that is life, seek to negate the vitality of beings who are rendered inert receptacles of energy-human batteries which are plugged into the system to transform their inner light into an artificial glow in the street lamps of the metropolitan prison.

The transhumanist nature of jewry is the trajectory of his technocracy-the supercession of the organic by the inorganic, by the artificial. The intention of, as The Protocols of the Elders of Zion say, "taking the peasants from the soil" is to negate the organic complex of blood and soil (blut und boden) and to attempt to serve it to create an artificial techno-crazy that all can be tapped within and drained of their bioenergy, their souls, into the forms of jewry and the archons who control them.

The gangstalking protocol serves this end as means of mapping human consciousness and providing necessary information (biofeedback) that can be used by the administrators (priests of the order of Melchizedek) to reinforce their technotronic slave plantation, soul farm for the soul farmers, harvesters of souls.

Like the movie "The Matrix" wherein the so-called 'humans' (read aryans-those who possess the Divine Spark, the Holy 'Graal') are entrapped in technological cells and their bioenergy harvested by the archontic entities who have found residence in the robotized creatures manufactured by their mundane agents.

The 'humans' now are being entrapped by ever increasing degree into the matrix of extinction, becoming robotized. Everything becomes function and a mere data processing, a rationalized calculus which is subordinated to political economy and the economists of 'the social'- controllers or archons ('rulers' in Greek) who are themselves controlled or ruled by archontic entities whose goal is the vampirization of the soul energy of the 'goyim' and ultimately of their material instruments the jews as well).

To break the prison-not to break out of this prison, is the duty of aryan mankind and in doing so to break the archons and their legions on this terrestrial plane. The proper assessment of the matrix as blueprint is needed to understand how to dismantle it and further to understand how to redeem the earth from the desecration of its technological bonds which have been imposed upon it to tear down its purity of energy, to lower its energies such that they may be harnessed by the rapacious vampires who view everything as mere food and thrills to absorb into themselves for themselves alone. Only the aryan may attain such a goal as to know the matrix one must know how it affects oneself which entails self knowledge (gnothe seuton) at a sufficiently high level-and only the aryan may attain the Olympian heights through his oneness with the gods.

Nigredo

The phase of the Kali Yuga that the aryan Race is now having to endure is that of the nigredo phase. Within this phase all manner of multifarious means are brought forth to justify the genocide of aryan and to bring it about by:

- 1) the demoralization of aryan such that they become apathetic and ultimately antagonistic towards their own survival, such that they acquiesce to their own genocide through
- 2) the incitement to violence against them by the cabal employing their media mind control to instill a self-righteous victim complex in the minds of their beastmen slaves they use against whites targeting the latter as the incorrigible villain who can do no right save to passively allow their own extermination.

The nigredo phase is the Rahowa (racial holy war) instigated by the jews and employing the negros and other non-aryans as a mechanism of the enslavement and ultimate extermination of aryan. Nigredo-negro-the blackening of whites by miscegenation (so-called 'race-mixing') and overt and covert slaughter-dispossession; job loss; cultural genocide through the 'blackening of culture', etc.

The blackening phase is that in which the light of the North-the aryan race-is submerged into the twilight of a degenerate tellurism that brings aryan into the bottom of the cycles of time. The instrument of this phase is the 'fall of man', the intermixture of the Hyperborean aryan with the anthropoid beastmen which was undergone as a deliberate act for the purpose of liberating the creatures of the Demiurge from the cycles of incarnation and then being consumed as energetic food by the archon astral parasites who seek to bring all into a state of perpetual serfdom as a means of voluntarily absorbing into themselves the souls of their captive charges.

As above so below-the instrument of these archons are the jews and their affiliated 'illuminati' 'ill-u-man-not-I'-those who are ill in their 'manas'/mind and who no longer have an 'I' or ego as they have sold their soul to the entities who possess and vampirize their ego which leads, like the jews' to having a faded and degenerated appearance, becoming pale and grey in their skin tone as their soul- their vitality-is substituted by the entity itself).

The driving force of the non-aryan and those corrupted by the Demiurge who are aryan is 'will to power'-will to enrich, to increase, regardless of the obstacles and barriers. The inharmony of the nigredo phase is a direct transmission of the will to power acting through the corrupted forms (beastmen) who manifest their destiny/exist their essence as a relationship of exploitative antagonism operating on the basis of the lie, itself a natural proclivity of they who comprise the 'organic lie' (being miscegenated miscreants) and who lie *de natura* being products of nature, of maya (illusion).

The Truth of their mendacity exposes them eventually as they are caught up in the web of lies they spin in their vampiric praxis attempting to trap within the blood of the Graal (the Divine Spark of the aryan).

Hence the nigredo phase is brought into being by the vampires of Zion as means of 'clipping the wings' of the angels, the gods, binding them as soul food for the dark forces. However this itself will never succeed as it will simply alert aryan to the dangers which ring them round and on that basis they will break free and from that point banish the darkness in the albedo (aryan) and rubedo (red) phases: the aryan's finally unchained from their serfdom to the dark side and which then enables them to radiate their light from their aryan blood.

Beware The Bearers Of False Gifts

The system operates on the basis of the lie-hypocrisy-a pretense of help concealing harm and a pretense of all bipedal entities who are absurdly ruled over by a self appointed master caste of jews and freemasons, the self-proclaimed 'only humans on earth'.

Hence when 'humanity' is spoken of it is only the jews themselves and those subordinate to jews who have undergone the rites of passage which bind them to the entities the jews are bound up with in the hive mind of Zion 'spiritual israel' underneath who exist the slave caste of mixed (up) multitude of identityless drones-zombified goyim.

Those who claim to be representative of 'Others' while not in any way participating in their Otherness (their essential qualities organically having no relationship to their underlings) are the hypocritical despots who hold out the 'false gifts' of materiality and pseudo-spiritual (read 'demonic') powers that serve as baits to bind the slave class in invisible manacles.

These same operate the system which distributes rewards and punishment according to their arbitrary caprice (*liberum arbitrium*-the libertinism of occult psychopathy). They reward those who are 'useful idiots'(sayanim, shabbos goyim-"stupid animals" in yiddish) and this to the extent of their use value.

No honor existing amongst thieves the swindlers of Zion (baal priests, 'lucifers', bearers of the false light) employ their usury system to exploit and 'shake down' the working class aryan and, taking the lion's share, cast crumbs to the non-aryans slaves whose function is merely to be a receptacle of material advantage, a drain of the life's blood of the Aryan and, once they are incited and led into acts of revolutionary violence to spill the blood of the aryan, blaming the latter for what they themselves have done.

Those who are conscripted into the gangstalking protocol are promised the false gifts of monetary advantages (mere currency or the empty universal value form itself having no value and that which can be taken purely at a moment's notice through the creation of economic crises and wiping out the bank accounts of those they deem expendable and no longer want around to 'tell the tale' of the cabal's corruption) and the even more false gifts (the gifts that keep on taking) of what is profered as 'occult power' but is in reality the possession of the soul by the entities that are the ultimate wire pullers and puppet masters at higher dimensions.

The gift of a license to torture and kill is granted the psychopathic perps who become bound to the cabal through the compromise of initiation rituals (sodomy; torture murder rites of passage, etc.) and who lose their autonomy (autonomos; 'self law'; 'self rule') not only on the mundane plane but on higher planes, become 'infrahuman' instruments who are mere spear points or arrow tips in the arsenal of Zion used against its enemies. These latter are declared enemies as their very existence serves as a bulwark against the despotism of jewry (they being 'aryan' whose light enables them to see the Truth and unconceal ('aletheia' in Greek, 'unconcealedness'), Truth/Being from the lies of jewry).

The jews' supremacistic value system is achieved through a confusion of language (babel-babble) which deceives those who allow their intellect to hamstring intuition and those who have no higher faculties (beastmen and debased infra-human husks, once aryan).

The false gifts of Zion are those baits which serve to bind their slaves to themselves in a world of cannibal vampirism with the life force of the slaves absorbed vampirically from bottom up by those at higher levels of the system.

It is a system of sadistic predation wherein the stronger force (predator) overcomes the weaker (prey) and the justification for predation comes in the form of the 'bestowing virtue' spoken of by Nietzsche. The apparent conferment of a benefit upon those who are mere receptacles of energy (labor; money; souls; blood) to the predatorial overlords; while appearing beneficial yet being harmful-'harmful help, helpful harm'.

The false gifts are those which justify according to the system its taking and which construal of the exchange based relationship exempts them from karma and transfers it (according to the ill-logic of the system) to the victim. Such however is not in the akashic records simply in those of the bureaus of Zion, in their computer databases.

The real nature of the 'gift' is not articulated and made known in 0s and 1s but rather is articulated in itself and through itself having no mediation save the consciousness of the recipient of the gift and those who bear witness to the exchange-the gift qualifies as such only in the consciousness of they who dwell in illusion, maya and can't pull aside the veil of becoming (aletheia, unconcealedness, revelation of Truth).

Those who are not on the side of the Divine and are not the children of gods (gottenmenschen, those possessed of the Divine Spark who derive from Eternia, the 'nunc stans' (eternal now), in Greek, the immortal realms) are incapable of discernment between 'Truth/Being' and falsehood (becoming; illusion) and accordingly receive eagerly the false gifts their calculating masters cast before them as so many scraps from their table. The cannibal feast continues on as the blood of the innocent (and the guilty) is spilled and drained down the throats of the vampires of Zion.

The gift of the liberation from the cycles of time has been bestowed upon the non-aryans through mixture with the arians, freeing them from the endless chain of incarnation. The thankless ingratitude repaid the arian will receive its own reward and they who have exploited and abused him and attempted out of jealousy and vain imaginings to usurp his place will be subject to the proportionality that is cosmic justice. "See how the heathen rage and imagine a vain thing" (their equality). To upset the balance of justice is to bring upon oneself karma such as when a child, greedy for the meat boiling in a pot pulls the pot down upon himself and scalds his ravenous maw. The 'chilluns of Zion' and the Yiddishe Mame (jewish mother goddess and Baal priests of the order of melchizedek) will receive the just lashing from the belt of the arian for their transgressions-"Domini Patres!", 'Got Mit Uns!'

Kehilla Communitarianism

"When a jew speaketh he speaketh a lie and of his own as he is the father of it, the prince of lies and the principality of liars" (an anti-semite). The jews speak for 'the community', for their own community and pass off their own will as that of Others (non-jews, the host body they infect), attempting to particularize the universal as the god-man demigods (Baals) of the topos they occupy and universalizing the particular-projecting and imposing their own will upon that topos, the organic-indigenous community they seek to usurp.

Communitarianism is kehillism as it is a function of the kehillah, its concretization in post-modern garb, still concealing itself behind the mask of universality, though possessing no universality as having no Truth-only particularity as the 'organic lie'.

It is the ruse of 'the jewish community' to present themselves as 'representatives' of 'the community' of the 'Other' and to convince through artful guile and emotionalization techniques the indigenous that their community is that inclusive of the jew. He can make this move in his chess game when he has garnered adequate power and strength to ingratiate himself in the host indigenous community and has begun his miscegenative process of the corruption of the relative purity of their blood with his own serpent seed. In today's modern world he has opened up the gates to the allegedly benign non-indigenous invader under the guise of trade or 'humanitarian' regard, etc.- anything to convince the population to allow the non-arian 'Other' to enter in and to diminish the power of the indigenous. If it is within the jewish community's interests, to initiate the surreptitious genocide by miscegenation, and failing adequate acquiescence thereto to precipitate the overt slaughter. The 'jewish community' extrapolates its organism (even though an 'organic lie') onto that of the 'Other' as a tumor in the host body metastasizing and expanding itself in its entropy, creating ever greater harm for the host.

Communitarianism is the politicization of the soul of jewry-an anti-race universalism (the false universal of undifferentiated chaos) that has a totalizing function assimilating all into itself and admitting of no difference save the implicit difference of the kehillah when it is not in total power-that between jew and 'gentile' and a relationship of master and slave to the extent the jews have adequate power to impose serfdom on the indigenous population which they occupy as a conquered territory and as the conqueror.

The totalitarian nature of jewry shows itself in its tendency to close in upon itself sealing itself off in its own ghetto (shtetl) of its own creation, out of its own megalomania and paranoid antipathy towards the 'Other', to the extent it is sufficiently powerful to exert a soviet style top down command over the 'Other' as its targeted prey. The closed system serves itself as an autonomous antagonist and feeds off the host body just as a tumor or a cancer.

Into itself all energies must be directed through its entwining itself with the host in a mutually self-destructive relationship through its own myopia and megalomania, its inability to understand its own self-destructive metabolism which consumes the host off of which it feeds.

Its agents are the sum total of its members and those who might attempt to inadvertently or deliberately break away are consumed by itself through the same gangstalking ritualism and/or clandestine assassination that the kehilla seeks to impose upon those it deems a threat, not to its survival in the conventional sense of an active strike against itself but in that of a threat to its supremacist intent which is for the kehilla the same thing-for all of that which seeks to resist its vampiric expansion is deemed 'enemy' and targeted for destruction though it is the self-defense of the 'Other' seeking to escape the fate of vampirization and simply 'live and let live'. To let live the kehilla is to precipitate one's own death.

The community of jewry corrupts the indigenous community and turns into spiritual (read 'demonic') jews (that is to say 'jews') the non-jews. The phenomenon of gangstalking is a textbook case of jewish psycho-politics, of its relation to that which is 'Other' to themselves: the transformation of the non-jew into a paranoid sadist who derives perverse pleasure from voyeurism and the abuse of that which the kehilla and its public relations representatives pillars of the community wish to brand with the 'mark of cain' and to destroy through their occult torture-murder campaign using their useful idiot 'shabbos goyim', the less intelligent and/or morally bankrupt self-serving members of the indigenous community on behalf of their own community ('safety and security'/community watch) while in reality on behalf of the kehilla, the jewish 'community'.

The kehilla monopolizes society for themselves and thereby works against the genuine interests of the indigenous community in characteristically subterranean fashion, seeking to come up from the bottom while pulling all down into the sewer to make of themselves 'the top of the heap' in a mafia-style neo-feudalist 'communitarian' society: "we the people"; "humanity", simply translates in the jews' 'holy' book of life (of cunning political praxis)-"we the kehilla and none Other".

Communitarianism can only be abolished by the organic state and this through an imposition of the higher forces of spiritual life on the materialistic world of tellurism. One must call to them in 'earnest prayer' (with stoical equanimity, with the nobility of the aryan) and conscript them into the fight against the infernal forces.

Ex Cathedra Diabolus

The jew world order puts forth its kosher bulls, its policies; norms; conceptual models; et.al as axiomatic pronouncements that come from 'on high' and that cannot be questioned, that carry the value of an 'assumed Truth', assumed as emanating from the 'Source' (the jewish god).

The mundane realm of the jewish god lies in the bureau of the marxist multikultists who assume the false premise that they are the emissaries of the 'One', divinely inspired through illuminism and their particular anti-race mongrel bloodlines. That moreover they are entitled by virtue of that assumed Truth to impose dictates upon Others which are themselves assumed Truths as deriving '*ordine geometrico*' from the 'One'.

Thus the jews have appointed themselves *vicarious filiae dei*, substitutes for masquerading as humble servants of 'the One' and all (being 'equal before god' according to this logic) must humbly 'bow before thee' o' jewish master race.

The oligarchy of jewry is the self-appointed rulers of the earth and all are their goyim slaves who are governed by their arbitrary caprice (*liberum arbitrium*-freedom for the jewish despots to rule and for those not jewish to bow-"yours is to command o' jew, mine is to obey").

Ex Cathedra Diabolus-from out of the synagogue emanates the diabolical preachments of the Sanhedrin which issue forth dictates that are unquestionable and that are as iron bonds that ring around the goyim in their action.

They are prohibited from reaction save according to the parameters outlined by the jewish kehilla. No form of action may be undergone save that which is determined by them-hence total control is the *modus operandi* of those who accrue to themselves the 'Divine Right'.

However such an accrual is in reality a mere theft of what does not belong to them but is a mere lie and yet one which the jew believes in and convinces others is Truth-the 'Truth and the Light'. Such a false light is nothing but a satanic beacon of illusion, a will-o-the-whisp that leads off a cliff, the pied piper jew leading his blind goyim to their doom.

The invention of a complete system of lies which reciprocally legitimate themselves (propositional abstractions based upon yet more abstractions-'the One'; 'God'; 'Equality'; 'Peace'; 'Love'; 'Humanity'; 'Democracy', etc.) is the basis of the *cathedra judaensis*, the synagogue of semitism-the despotism of jewry which is founded upon the empty abstractions raised to the highest height by the false humility of priestly caste parasites who dictate over all the very structure of their lives, tearing them away from heaven (Being-the Eternal realm) and casting them into hell ('becoming'-the transient world of finitude).

This is why the priestly caste requires offsetting or rather integration into the warrior nobility as it, the priestly caste, is inherently hypocritical and defective and the jews are simply yet another exemplar of the hoodwinking liars that priests have always been.

The priests, especially in the form of Semitism, crystallize in their decadence and cause the subsequent decay of the society which they have, through clever emotional appeal (in their characteristically lunar-semitic theatre) manipulated into thinking they are the intermediary between the Absolute, the Supreme Being and the earthly creation and His Creation.

By that means they monopolize society for themselves and lead it to its ruin. Only the revitalization of society by elements thereof can rectify that society through the warrior spirit of the aryan. That is the only path forward, that of total war and total victory or total defeat and this led by the aristocracy of the soul of their contemporary estate (tradesmen; scholars, etc.).

For the priestly caste hypocrites to be removed their Baal temples must be smashed to the ground and this first and foremost on a spiritual level-the counter-revolution of the mind begetting the counter-revolution of action against the dark forces. Tearing aside the mayavic veils the effeminate priests garb themselves in with the steel gauntlet of aryan might.

Collective Crime, Collective Punishment

The logical fallacy the jew employs in his lying hypocrisy is that of being a perennial victim of the antagonism of the aryan-the jew is always "innocent darling, innocent" and can do no wrong while the aryan is always and forever 'wrong!' by default and can do no right. Under such conditions it is always a victory for the jews and a defeat for the aryan.

The jew contrives the terms of the debate and forces them upon those he forces to become an interlocutor in-those who he accuses of immorality/heresy/thought crime, etc. and who he invokes his hired goons to threaten and coerce justification from-"justify yourself!".

Anyone perceived by the jew to be 'enemy' the jew seeks to destroy and this through his hegemonic discourse or justificatory rhetoric that he imposes on the Other. The Other who refuses to 'play' in an impossible game the outcome of which can only be defeat is then set up and framed as 'not playing by the rules'(against 'our' values; a 'criminal'; 'mentally ill'; an 'enemy of society', etc.) and subject to the imposition of what the system considers according to its logic 'justice' (reasonable force; the will of 'god', etc.).

This applies in individual cases as well as to collectives-those the jew deems transgressors of their laws (ostensibly those of 'god' or 'society'-their society, their invented 'god') are singled out to pay the penalty if the jew deem then an existential threat (and this being any and all who do not positively facilitate the supremacism of jewry).

In extending the scope of penalty to include those who have not immediately carried out the deed or those the jew does not specifically and singularly perceive to be a potential or actual doer of a transgressive deed but rather the collective of which they are a part being targeted for harm or total destruction-in extending the scope of punishment for potential or actual transgressions of the jews' moral codes the logic of collective crime and collective punishment is invoked.

This is based upon the paranoia of the jew and his 'scenting out' potential enemies and seeking their destruction. The israeli I.D.F t-shirt which depicts a pregnant muslim female in a burka with an aiming scope over the womb which bears the caption "one shot two kills" illustrates the dangerous consequence of jewish paranoia.

The absurdity of the doctrine (dogma) of collective punishment as the jews deliberately misunderstand it for self-serving ends, lies in the attempt to

- 1) project certain attributes onto an 'Other' which are not necessarily theirs (the definition of paranoia being believing something to be a reality which is not a reality but believed to be such delusively) and
- 2) extending those attributes to a collective they are affirmed to be a member of. The fallacy of collective punishment the jew utilizes as a political weapon to demonize and ultimately to destroy their competition is to extend that which can not necessarily be extended from one person to another (the collective) and to implicate the whole based upon the part (fallacy of composition); and to ascribe attributes to the one which are not necessary attributes but mere mudslinging by the jewish slanderer accuser as a paranoid delusion, a figment of their own megalomaniacal mind. Whether the jew has any genuine 'belief' in the accusation it is only in his estimation to be judged according to its fruits politically not in terms of its Truth value, for truth has no place in the consciousness of the 'organic lie'.

The visitation of collective punishment upon the 'Other' by the jew through the instrumentality of his minions is a function of his mind control of Others who labor under the delusion that his word is a mere echo of the Absolute and thus carries the weight of divinity with each and all of its pronouncements.

Collective punishment is legitimate only in the case where the part transgressed and the transgression of the part is an essential attribute of the whole and threat, the whole being composed of the sum of the parts has that attribute in germ, within itself and thus has the possibility of continual transgression. This according to whatever particular moral code establishes the behavior or conduct (act or omission) as a 'transgression' necessitating a reaction according to the controllers of the system.

In the case of jewish society/system (jewish occupation government in a multikult society) the transgressor is anyone who has within himself any feature or attribute that the jew deems 'transgressive' to the jews' supermacistic agenda.

In the context of an aryan society what is deemed 'transgressive' is anything that violates Cosmic Law or the Divine Will and upsets the harmony of existence. Thus those who, in the context of a jewish society violate his moral codes are subject to the ruthless punishment extending to all of their kind (*vide* Palestine or the Soviet Union) and those who in an aryan society disrupt harmony are subject to a suitable punishment if and only if the aryan population and the aryan elite controlling it are indeed aryan and not 'judaized gentiles' such as in the society of today.

Chaos Vs. Order

The intention of the cabal in its operations against the aryan population is to deliberately create with well-formulated strategies and tactics as much chaos within the system as possible as a means of destroying their enemies and usurping power to install their own version of what they deem 'order'.

This has its parallel in the physical sciences (a system of abstract concepts) in that of 'entropy' and closed and open systems. The society of the non-jew (predominantly that of the aryan, the creator and originator of all society and meaningful culture) is the closed system that the jew seeks to 'open up' via the creation of chaos (entropy) and thereby initiate the process of its destruction.

The 'opening up' phase is achieved through incentivization-offering some sort of benefit to the non-jewish 'Other' as means of gaining access. An allegory of this kind is the story of 'Dracula' by Stoker wherein the vampire (the jew-the harbinger of entropy) seeks entry into the residence of the female (the receptive non-jew) through cunning strategems.

In the case of the jews history they have gained access through:

- 1) offers of trade connections or commodities they are the principle traders in which appeals to the host nation and
- 2) appealing to the sympathy of the non-jew based upon the jews' ostensibly being a weaker and 'down trodden' group which allows jewry in through giving the non-jew a sense of power and relative superiority as "only superiors can condescend" as Seneca said.

Once in the jew immediately goes to work in his characteristically subterranean fashion, seeking to undermine the Order of society (the order of the once-closed system which has been opened up by the appropriate mechanism to the 'Other', the jew): this in the form of introducing class war; sexual war (females vs. males and the introduction of 'alternative genders' as a means of destabilizing the nuclear family which is the nucleus of the nation/society/system); factional war (through creating splinter groups and fragmenting society/the nation/the system on that basis) employing divide and conquer tactics.

The thin end of the wedge is inserted in the form typically, of the 'chalice' and 'the blade', of the sexual members, as the corruption of temptation-the 'temptation of the flesh' which appeals especially to those most decadent of the society leading them to ever greater forms of decadence.

This could be any class of course but it is especially the controller class, those who administer and determine the course of the society who the jew puts in the crosshairs, targeting them for the disintegration of their soul through having them bite the apple of iniquity (partaking of the forbidden fruit of carnality which introduces a laxity in the order of the society/nation/system. This is done through creating eg. sex addictions and enabling jews to plant their honey trap spies amongst the upper class and have then gather information compromising the nation or to the extent of assassinating the noble or elite but typically leading them towards a lifestyle of debauchery and though corrupting them and thereby corrupting the nation as a whole.

In transforming the decadent elite into the enemy of the people and driving the relatively poor into greater poverty unto the breaking point the poor erupt in revolution against their controllers either simply destroying the nation outright or enabling the jewish revolutionary leaders to usurp power completely in a new regime).

It is the usage of poisoned apples that enables the intruder jew to destroy the system and to engineer as much a chaos as possible in an attempt to usurp total power for himself. The sex, drugs and myriad other cthonic mechanics utilized serve to debase, defile and destroy the consciousness of the aryan.

This is the trajectory along which the jew aims his low blows seeking to drag down and focus the mind on lower states of consciousness based upon sensationalism and hedonism (the shifting of emphasis from spiritual heights of power and creative action, of the manifestation of order that strengthens and ennobles to the subterranean depths via the libidinal economy of pleasure maximization and pain minimization).

The wares the jew sells are those of the pimp who traffics in the pleasures of the flesh and in the most literal sense. The profits of the jew are political power and the visitation of harm to the non-jewish population-this as a way of trapping them within the matrix and creating stress and other emotional states (pain; fear; lust-all states of consciousness that drag one low into the lower brain states of the 'reptilian brain'-pons/medulla and brainstem-and the lower chakras-muladhara and manipura, etc.-and shifting consciousness away from the higher states-pulling down Spirit into the mire of its imprisonment). The goal ultimately is to enable the entities and jews themselves to feed upon the energy released in addition to monopolizing power through their characteristically subterranean praxis of revolutionary chaos.

The usage of gangstalking as a protocol to engineer chaos affords the jew not only the biospiritual energy given off by the targeted person should they-as most all would to a greater or lesser degree-give off their energy as a reaction to the abuse imposed upon them, but also affords them with an understanding of how to further manipulate the consciousness of the non-jew and derive yet greater power (both mundane and occult) from their targeted host population.

The intention of the jew may be the dominion over the earth with themselves as rulership-but the *qualitas occulta* (occult quality) they perhaps are unaware of is that they are not themselves in complete control-rather it is the archons who control them who are and to whom they are subordinate who are simply driving all into a state of total chaos so that they, the archons may feed upon the pain/death/sex energy that leads to the complete disintegration of not only the particular persons both rich and poor alike but the system itself leading to the negation of all life. Hence the danger of the jew as harbinger of chaos and the tolerance of the jew by the non-jewish population.

To tolerate the jew is to tolerate one's own destruction for to enable the presence of the jew into one's society is to enable continual dispossession and destructive action. Expulsion of the chaos conduces to order just as a sick body expels wastes and viruses which beget waste as a metabolic byproduct.

It is simply a question of house cleaning to return the system to Order as "a slight deviation at first leads to a greater deviation later" (Sun Tzu) which is a principle of mainstream 'scientism'-that greater entropy/chaos in a system leads to the system's collapse and to allow manageable entropy/chaos is to bring about the destruction of the system. The question remains: is the Jew a manageable presence in Aryan society? The trek of the Jew through the ages affords an answer.

'Rights': An Ontological Absurdity

The notion of 'right's' is that of a legally guaranteed benefit of a particular contingent socio-political-economic system. This alone. There is no mysticism or magical quality inherent in the notion of a 'right' as the being of a 'right' is notional. This alone. A 'right' has no ontological reality beyond these mere words and phrases which state approximately the following: "'person'/'citizen'/'legal person' XYZ is permitted LMNOP (the 'right' under conditions QRS (the particular contingent conditions of a socio-economic-political-legal system) by ABC (the legislators/administrators/enforcers (police and military) of QRS)".

This is all a 'right' means, it is a purely artificial construct without any non human 'being' but a pure invention of the mind or minds of ABC (the legislators/administrators/enforcers) of QRS (the system).

There are those in the modern world who have elevated this notional entity to a lofty promontory as the sacred cow idol before which all and sundry ('humanity'-yet another abstract concept) must prostrate themselves. Such is the erection of a new religion based around these conceptual abstractions: 'humanity'; 'rights', whereby, according to the logic of the secular humanist liberal-communist (leftism) those who are qualified by itself as 'humans' are *eo ipso* entitled to 'rights' (legally guaranteed benefits).

The religion of humanism is an inherently contingent one having no ontological validity as 'the human' is an abstract, notional entity, what are called 'humans' today being merely a disparate mixture of bipedal entities sharing in common a finite constellation of attributes in the finitude of their being, having no relationship to anything beyond their own fallible and contingent being that could be spoken of as adequate 'common ground' upon which to base a stable and orderly society or nation.

'Humans' of radically disparate kind cannot maintain a harmonious or stable bond as no such bond exists ontologically but rather a mixture of disparity (diversity). Thus to impose upon this rag-bag of elements a common impress is simply to negate the being of the distinct beings who are merely juxtaposed within an artificially delimited topos, as it were 'penned in' like animals into a zoo whose bars are of 'clay and iron'-doomed to be torn out of the concrete mold and enabling the eruption of the feral denizens who were moments before contained within.

No legally enforced benefits would enable the preservation of that which '*in se*' (in itself) cannot be preserved, as 'rights' today can at best be a contingent pragmatic instrument of the organization and regulation of Organic states (wherein the ethnos, race, is subject to its survival and enhancement by the laws and their conference of rights and duties, obligations and prohibition).

Any discussion of 'rights' is merely the windbaggery of 'intellectual sophisticates' who make of the subject matter fuel for their mental masturbations and the tool of hypocrits to attempt the impossible, that being to create a society, a Solomon's temple out of 'clay and iron', doomed to failure under its own weight.

There are some who attempt in their intellectualism and 'science philosophy' to unite the notion of 'rights' with that of biology (in the mainstream scientific sense). The absurdity of this notion lies in the facts of existence (an ontological absurdity): 'rights' are notions that are neither inherent properties of the consciousness of 'all and sundry' nor properties that magico-mystically attach to particular individuals (in the 'universalist', 'humanist' sense) but are merely conceptual abstractions ('humanity') the 'individual has predicated of it, yet another abstraction ('rights') and neither one nor the Other has any ontological reality but a purely notional one. Neither can such a set of notions be combined in any 'ontological' way or egregores (thought forms) as the 'notion' of a 'right' is not a universalisable thought form as 'all' are not all...('humanity': an abstraction) but rather infinitely particularisable diverse entities whose thoughts, emotions and actions are radically distinct at a fundamental ontological level (essentially in essence). These should they ever be able to think 'the same', act 'the same' and feel 'the same' they will inevitably be destroyed, nihilated in their being as diverse entities.

Such is the totalitarianism of universalism, wherein 'all' are equalized *in abstracto* and nihilated *in concreto* at all dimensions of their being. Universalism is a genocidal weapon of nihilation and nihilism, a product of the Near Eastern pantheistic mother goddess cults which metamorphosed into christianity and from thence into freemasonry and illuminism all of which emanate from the consciousness of the 'self chosen' people.

Zersetzung

The stasi of East Germany (D.D.R) were the secret police whose task was to exert an iron grip on the population in its velvet glove, that of a hidden ubiquitous presence such that all 'citizens' eventually came to understand that the stasi, might be everywhere. This imposes a climate of fear and of paranoia on the population who eventually were entrained to spy on one another and to self police not only in terms of their fellow 'citizen slaves' but their own mind (the ultimate conclusion of the enforcement of dogma).

The self-regulation and self-censorship of the mind was a result of the trauma-based mind control of world war two which effectively shut down any conversation or discourse that was permitted, was forever confined within the box of accepted dogma as if its walls were of magnetic slabs that repelled the interlocutor from venturing towards the walls of the cube matrix in which they were confined.

The Berlin wall may have come down but the walls of the mind in the case of free people were always down and in the case of those who hadn't the capacity to overcome their programming they were always up, the former were masculine in their consciousness the latter feminine.

The existence of a matriarchy control grid wherein all are subject to the micromanagement of the nanny called 'the state' necessitates that it assume the form of a Stasi like state with innumerable spies and informants who are placed among the population to gather intel on potential dissidents, or those in short the regime determines to be ideological enemies or 'subversive' *in potentia* or *actua* and who, according to the logic of the system, must be interrogated and subjected to gangstalking. If discovered to quality as 'subversives' according to the system, they are then subject to punitive measures that subjugate the dissident.

The means through which this is activated is through the gangstalking or community policing of these or other spies (which may be criminals or moral majority types) who then are assigned tasks by what calls itself 'authority' (the system) and who are granted incentives to serve the system in this capacity, be it in the form of a sense of importance or a reduced sentence or erasure of criminal penalties for crimes they have committed; drugs; money; sexual favors, etc.

The hired spies play the role of discoverers of 'dissidents', 'subversives' and the gangstalkers play the role of a harasser and tormentor of the 'dissident'. Should the dissident complain, which is what the system wants them to do , to any putative authority, the later can claim they are 'mentally ill' or that they should visit a psychiatrist and, once that is either mandated or undergone voluntarily by the suspected dissident the psychiatrist can then mandate institutionalization and the 'dissident' rendered a vegetable, a lobotomized zombie through the usage of psychiatric medications, of directed energy weapons and anything the dissident will say to the outside world will simply be qualified as 'paranoid'.

Such is the ultimate end result of this 'process' of zersetzung:

- 1) spying
- 2) gangstalking and 'community policing' harassment;
- 3) either killing the target with directed energy weapons or poison or setting them up in a false flag terrorist act if they don't complain to the self-proclaimed 'authorities' (police) about the harassment or the 'dissident' having recourse to the police and from thence to
- 4) psychiatric assessment and institutionalization and a silencing and probably elimination of the 'dissident' like a fly in a spider's web.

The only way to break out of the web and ensure one's own safety is to publicize what is being done and how, by printing off stickers and leaflets and leafletting one's area and being as public as possible about what is being done. Then presenting sound evidence that relates particularly to one's situation so that no claims can reasonably be supported to the contrary on the part of any community spy or slanderer who would attempt to play the unofficial work of the psychiatrist to convince the population or a sufficient number of them, that such process is actually being done: gangstalking; harassment via noise and directed energy weapons. Silence is death in the silent war upon consciousness using the silent weapons of the nanny state. The dumbed down masses are sufficiently stupid to cynically ignore this phenomenon and ascribe it merely to melodrama as their reality is the hyper-real matrix of the postmodern soap opera.

Reality to them is mere fantasy and the fantasies concocted by the jews are their reality (hollywood-ization of the Real-'hyper-reality', in the sense of Baudrillard). The gaslighting jews are the architects of destruction and seek to destroy all who would cut through the matrix they have imposed upon the mass mind. To blind the all-seeing eye of the nanny state one must alert enough of the blind masses to hurl their missiles into the eye of Zion.

'Mentally Ill'

The jewish occupation government uses the facade of concern for its slaves as a means of enforcing compliance with its tyranny-"helping people", translated into the more appropriate semantic content of controlling populations of 'goyim' such that the goyim are deceived into thinking they are being treated with kid gloves and that their nanny state overseer is benevolent.

And indeed within the context of wage slavery the nanny state is benevolent; within the context of coerced labor (for aryan people of course-all non-aryans having the option of subsisting or rather thriving on welfare for eternity...even though living in illusion/maya). Thus the facade of benevolence is employed as means of pacifying the pent up aggression of the goyim serf caste.

The usage of a soft tyranny is most effectively employed through the alleged 'helping disciplines' which are smiling masks concealing the death's head of genocide and slow killing.

Specifically the 'mental health' disciplines are utilized by the system as its most subtle instrument of doing away with and ensuring the compliance of its slaves should it desire them to continue to live as its tax paying serfs chasing after the golden carrots of status and money it dangles before its mules to incentivize their willingness to pull the cart.

Should any of their mules become a threat to the system they are coerced through word of mouth and the intervention of the hired goons (police; security; community spies) who are forever at the beck and call of the ubiquitous jewish spies and their underlings who micromanage the goyim in all of their particular minute aspects of their lives.

To be dragged before the psychiatrist who in postmodern times is the equivalent of the medieval inquisitor, the witch hunter, who pronounces her *ex cathedra* judgements as to whether the individual in question is 'certified' *compus mentus* or otherwise on a sliding scale of what is portrayed as the potentiality to harm oneself and/or others-the more probability of harm the individual is assessed at potentially visiting upon others or themselves as a Mr.Hyde tearing aside the Dr.Jekyll mask and unleashing the beast into the public sphere the more severe the punishment, the so-called 'help' he receives, this 'help' is in reality merely a mechanism of control of his behavior to the very limit-and beyond-of his soul, such that he is subject to a 'discipline and punish' protocol in the manner of a prison planet, prison society as discussed in the operative Michel Foucault's (fag-cult's) book of the same name.

He becomes, under the panopticon vision of Sauron/Saturn the 'docile body' spoken of by fag-cult; an individual, a 'citizen', a 'patient', subject to the regularization and control of his every move by the J.O.G (jewish occupation government) system-he is the patient and the J.O.G and its operatives are the agent.

The use of pharmaceutical pills and poisons (black magic pharmakeia) are one of the most effective methods of regulating the behavior of the slave class and 'shaping them' in the euphemistic terms of the J.O.G into geometrically suitable bricks in the wall of the temple of Solomon. Even should this mean the destruction of the mind of the 'individual' or 'person' as a consequence of the process of regulating the docile bodies. Fag-cult, in his "*The Birth of the Clinic*", also speaks of these issues and how what calls itself 'knowledge' is in reality a discourse, a system of ideas/concepts that are upheld by the system itself as 'apodictic' or the standard by which all else must be judged-again according to itself. That establishes itself as the authority and incontestably so immediately and *eo ipso* nullifies all other forms of discourse which are 'Other' to itself.

Thus it present a hegemonic discourse as incontestable and unquestionable rhetoric that according to its own inner logic legitimates the imposition upon all of those Other to itself of whatever its logic prescribes as necessary or prudent courses of actions: what is deemed necessary; obligatory; mandatory; or at least sufficient and the 'least harmful' necessary course; what is 'reasonable' of course is whatever the priestly caste declares to be 'reasonable'; 'necessary'; 'mandatory'; 'obligatory'; 'inhibited'.

The entire system of its modal logic is brought to bear as a mechanism of keeping in line the slave class so that it the system can continue to expand its entropy over the sum total of Being- destroying and consuming whole worlds into itself. Karl Marx made a statement of a similar nature about his dreaming about destroying all of the stars.

Indeed it is the psychopathy of the jew which would most appropriately by qualified as 'mental illness' as the jew is the embodiment of entropy, the vehicle of chaos upon the earth, and has accordingly countless 'mental illnesses' associated with himself even according to his own tribe who are the controllers of the system and apply its concepts of 'mental illness' to themselves as these concepts derive from self-reflexive observation of themselves and thus become codified in the discourse of psychiatry having specialized labels which are then projected upon the goyim to whom they much more rarely apply.

Thus the double standard function of alleged 'mental health' services are established by jews based upon a projection of their own consciousness onto the non-jew while themselves being exempt from the usage of diagnosis as a weapon to enslave and reinforce the structure of the system-setting legal precedents (that which is prohibited/permitted/mandated) as means of doing away with the unruly element, with those unwilling to subordinate themselves as a slave and even simply those who know elements of the system that might potentially threaten its security.

Hence the example of the institutionalization of public figures such as Ezra Pound who might have exposed the lie that Italian fascism (with which he was intimately acquainted) was not a viable and in fact preferable politico-economic system to liberal-democracy and communism. The system thus employed its machinery of bureaucrat regulation, mobilizing its pawns the police and military to arrest (physically detain) the poet and translator of the I Ching and institutionalize him (cordon off from society), preventing him from writing or communicating to the outside world.

Such is the operation of the J.O.G machine and the particular weapons of discourse it employs to eliminate or mitigate threats to itself.

By claiming that one of the 'citizens' of the system (an individual bipedal biological being called 'human' or 'goy' amongst the jews and shabbos goy elites) has a 'mental illness' or could potentially be 'mentally ill' and thus potential threat to himself or others is to qualify the individual 'citizen' as a 'patient' and thus to establish a formal relationship with the system legitimating their claim.

This, according to the logic of the system, entitles it to predicate of the 'patient', the 'docile body' as spoken of by fag- cult (Foucault), any number of labels they have associated with them various procedures that can be employed against them and their liberty-everything from forced vaccination and medication to incarceration, ie. confinement in a mental institution.

This at the behest of the psychiatrist who has the power to employ these means to kill if need or desire be by the system of which s/he is a part-to chemically or electromagnetically lobotomize the 'patient' and to render the docile body of no force or effect against the system even to render it docile as a cadaver on the physical plane. Of course it is dead as a soul, being prevented from self-cultivation and thus has had its physical life rendered mere 'meat' that persists for a few years on the physical plane before it expires.

Thus for all those prudent and unwilling to live the life, if such it may be called, of a vegetable, it is best to completely avoid any antagonism with the J.O.G system especially in its aspect of medical genocide as it is this which is used as the means of controlling its population of goyim, transforming them into the bricks' in its walls.

The label 'mental illness' thus by virtue of its entailing the potentiality of harming society (many mental illnesses have the related conceptual contents of 'harm' bound up with them based upon the J.O.G's statistics and precedential decisions (*stare deces-*"the doctrine of precedent"-; *ratio decidendi*-"reasons for decision") is bound up with a forensic element such that not only can the medical orderlies once institutionalized impose greater restrictions on oneself (straight jackets; gags, etc.) but they can also employ the more vigorous arm of the J.O.G, the police and security force and indeed any mandate or prohibit on the part of the system that relates to oneself as a 'patient' entails the implied coercion of the iron heel of the system should compliance according to the system not be forthcoming. The individual would then be dragged into whatever set of circumstances is mandated by the J.O.G be it incarceration; lobotomization; electromagnetic mind control and 'euthanasia'.

Thus the J.O.G system enforces its despotism through the specious pretext of 'helping people' as means of pacifying resistance and as means of deceiving the gullible that they are receiving some form of benefit when in reality they are receiving chains of slavery. The fact that the average person ascribes at least partial legitimacy to allopathic medicine and psychiatry specifically enables the J.O.G system to legitimize its imposition of its 'help' upon the non-compliant slave caste who live merely for the lower purposes, they have been conditioned to accept as the be all and end all of existence- namely feeding; fornicating and 'workin'-trapped as they are in the matrix of Zion beyond which they have no ability to go. The destruction of the mind through the chaos of the lower vibrational frequency states of being the J.O.G creates leads the mentally unhealthy (who is unhealthy at the expense of the J.O.G) to partake of the 'services' of the 'mental health' helping disciplines: their soul destroying drugs and poisons which merely fulfill the purposes of the J.O.G namely: aryan genocide.

The Aryan Consciousness Is Rising Like The Phoenix From The Ashes

We, the collective of aryan racial kin see the Divine Spark ascend and bask in its glory, imbibing strength from its form and reifying it in our actions as the rightful owners and occupiers of this globe. The night of dark-age ignorance will not shroud the True Light of the aryan Man who will herald the dawn of a New Aeon of the Divine Will through his just purgation of the evil of this terrestrial globe, through the shining sword of his conscious Will-power overcoming all darkness.

References

Self

"The Doctrine of Awakening"; "Synthesis of Racial Doctrine",

Baron Julius Evola

"Theozoology",

Jorg Lans von Liebenfels

Enemy

"Jew Who: How to Identify Jews",

compiled with additions by Loki Hulgaard

"The Babylonian Talmud",

Soncino addition

"The Egyptian-Masonic-Satanic Connection",

David Carrico

"Freemasonry and Judaism-Secret Powers Behind World Revolution",

Viscomte Leon de Poncins

"Destruction of Freemasonry Through Revelation of Their Secrets",

General Erich von Ludendorf

"How the Illuminati Create a Total, Undetectable, Mind-controlled Slave"; "Deeper Insights Into the Illuminati Formula",

Fritz Springmeier

"The 48 Laws of Power"; "The 33 Strategies of War"; "The Laws of Human Nature",

Robert Greene

"The Brainwashing manual: Synthesis of the Russian Textbook on Psychopolitics",

L.Ron.Hubbard and Lavrenti Beria

"Rules for Radicals",

Saul Alinsky

World

"Targeted Individual Handbook:

Combating Gangstalking and Directed Energy Weapons",

compiled with additions by Loki Hulgaard

"Atlantis, Edda and Bible",

Hermann Wieland

"Revolt Against the Modern World",

Baron Julius Evola

"The Crisis of the Modern World"; "The Reign of Quantity and the Signs of the Times";

Rene Guenon

