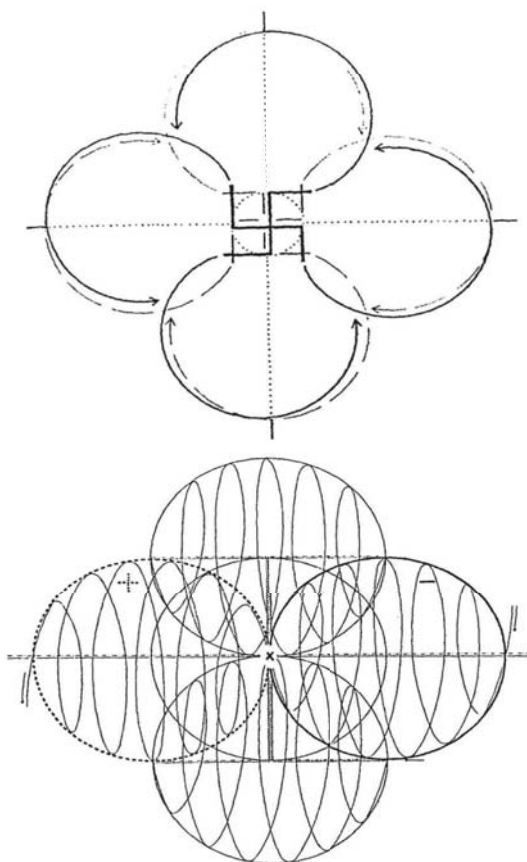


Hyperborean Physics



An Introduction

BERSERKER

BOOKS



Index

pgs. 3-47

"Basic Study of Hyperborean Physics",
Wolf Fenrir
OCTIRODAE Brazil

pgs.48-83

"Of Wave and Quantum Mechanics",
Author Unknown

Pgs.84-97

"Hyperborean Physics: Fragments"
Nimrod de Rosario

*Basic Study of
Hyperborean Physics*

Wolf Fenrir
OCTIRODAE BRAZIL

Basic Study of Hyperborean Physics

We will begin the explanations on the Hyperborean Physics taking as a basis some concepts of the traditional physics, adding other concepts of the Hyperborean Wisdom and when necessary indicating some parallels between these concepts. We understand by Hyperborean Physics the correct understanding of the functioning and mechanics of the universe of the One. We will deal here with some of the basic principles of the Atlantean technology rediscovered by the SS in the III Reich. The Hyperborean Physics is obtained by re-examining the physics of the created universe of the One, through the prism of the Foundations of Hyperborean Wisdom.

FRACTAL GEOMETRY

For physics and modern mathematics, these are the dimensions in the Universe:

Dimension 0: point

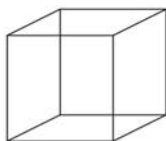
.

1^a. Dimension: line (soma of points), or even width.

2^a. Dimension: square (soma of lines), or even width and length.



3^a. Dimension: cube (soma of squares), or even width, length and height.



Traditional physics teaches us that the point does not exist, the line does not exist, the square does not exist and neither does the cube exist, that is, that we are in front of six planes that are united and form the cube, that we can see them together or separately, but that they do not exist!

Nimrod in Part II, Volume II of the Fundamentals of the Hyperborean Wisdom clarifies that:

"First, there is the SPECIES, which is the class of INDIVIDUALS with common traits. Then, there is the class composed of species which is called GENUS. The 'genus', as a systematic concept has greater EXTENSION than the species, since it embraces them in its definition, but

The dog genus, for example, includes the species of 'canis familiaris', 'canis lupus', 'canis occidentalis', etc.; and we have to observe here that the dog genus includes the species of 'canis familiaris', 'canis lupus', 'canis occidentalis' etc. The genus of the dog, for example, includes the species of 'canis familiaris', 'canis lupus', 'canis occidentalis', etc.; and we must observe here that, evidently, the 'dog', as a genus, is a UNIVERSAL CONCEPT. Thus, the classification of an individual specimen consists in 'distinguishing its specific differences' and establishing 'the proximate genus'. The class of the genus is usually called ORDER and the class of orders simply CLASSE."

And Nimrod continues:

"From the point of view of the reality of entities, there is undoubtedly a limit between species and genus; but what does this limit mean? Answer: THE BORDER OF RATIONAL CERTAINTY FOR EVERY DESPERATE VIRGIN. If the use of reason, and of its conclusions, is already suspect for the awakened virya, the species marks, in effect, the limit where the credibility of knowledge must stop: such a limit can never be crossed by confidence without running a serious risk of falling into the subjectivism of the genus, into the falsely universal, that is, into the Deception of culture, 'enemy strategic weapon'. HE WHO BELIEVES IN THE REALITY OF GENDER WILL NEVER BE ABLE TO REACH THE 'STATE OF ALERTNESS' DEMANDED BY THE WAY OF STRATEGIC OPPOSITION, THAT IS TO SAY, HE WILL ALWAYS BE IN 'STRATEGIC DISADVANTAGE'".

If we apply this rule to our existential dilemma narrated above, then the only thing that has real existence is the point. Now, here is the first key to the Hyperborean Physics: only the point has existence. All the rest, all the manifested reality, all the universe, nothing but the one that is made of several united points. The obvious conclusion that can be drawn from this is fantastic: **each point has in itself an enormous amount of energy and information.** Potential energy of impulse of the archetypes up to the entelechy and information of its logos or "being in itself". If only the point is real, each point is connected with the universe and with the whole; the point contains the whole and the whole contains the point, contains in itself all the possibility of the universe. The point is, therefore, infinite (by infinite here is understood the "infinity" of the created universe of the One, or, to explain better, potential infinity; the universe of the One is finite insofar as it has a beginning and will have an end; but it is infinite in potentiality for the greater or the lesser, as we shall see below).

The concept of the universe within a point has already reached Hollywood's screens, as we can see in some dinners of the movies "Contact" (based on the book by physicist Carl Sagan) and "Men in Black", for example.

But this calls attention to an interesting question: if a point is infinite, so are the groups of points. How then am I, you or any other known body not infinite? Our bodies have a limit, and being so, how are they infinite? How to answer this paradox? Answer: because the two systems, the finite and the infinite, coexist in the same reality. But, by what way can a finite system and an infinite system coexist together, in the same reality, and complement each other?

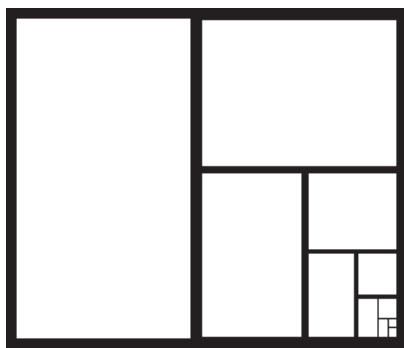
The answer to this question is: Fractal Geometry.

We will try to explain how the infinite is organized into something finite, how they complement each other, using the geometrical analogy, which the reader of the FSH is

already accustomed to.

What we will see now is something crucial: the way systems are organized and generate the geometry of our "reality" whichever way we look at it.

At first we will make a square. We will then divide that square into two equal parts. Now, we will divide the new parts also in two equal parts, and so on, as in the drawing below.



Now, each level of division will generate a new limit. And that is something very important for me to understand: each level generates a new limit. You can calculate the equation and insert it in a specific computer program that will continue to do the fractal division... infinitely! With a graphic program, one could "zoom" in the sequence of squares, moving forward or backward in its sequential formation. However, even if we can place an infinity of smaller squares, we can never exceed the first square... never. Thus it is that the infinite coexists with the finite in the Universe of the One. Because it can be divided infinitely, as long as it is within the original square.

Returning to the explanations of the Nimrod in FSHs:

"Well, the Hyperborean Wisdom provides an explanation that is quite different, but which perfectly understands the gravitational phenomenon and makes it possible to master it for the benefit of the strategic objectives of the Siddhas. And such an explanation does not require the use of formal mathematics except when one wishes to develop a technology, in which case one has recourse to an esoteric geometry that is entirely outside the academic environments of the West."

The referred esoteric geometry is nowadays known as Fractal Geometry. And this fractal division of the structures of the universe occurs in a very precise way, from one limit to another, always following the AURINE or DIVINE PROPORTION, which Gustavo Brondino explains so well in his book "The House of Turdes":

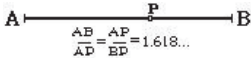
"A 'natural fractal' is an element of nature that can be described by fractal geometry or Divine Proportion. Clouds, mountains, the circulatory system, coastlines, or snowflakes are natural fractals."

And Brondino still explains:

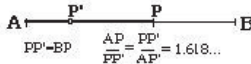
"Pursuing this development, Phi is also found in another older, more obtuse and obscure relationship. Extreme and Mean Proportion reveals more about the unique properties of PHI. In simple language, it says: A single point P divides a line AB so that as the entire line is to the larger segment as the larger segment is to the smaller.

$$\frac{\text{TODO}}{\text{MAYOR}} = \frac{\text{MAYOR}}{\text{MENOR}}$$

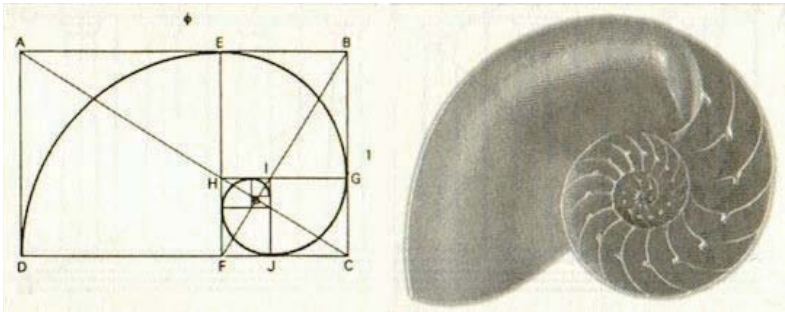
This strange, obscure reason also equals PHI. In a simple diagram:



The value of this is not immediately obvious, but becomes clear when we divide the major segment by the minor segment to put a new point P':



The old AP segment is now the whole, PP' the new major segment, and AP' the new minor. All three new lines are in reason PHI."



But how does it help, how is this information useful?

Let's look for an example within physics itself. More and more particle accelerators are being built, such as the one in Geneva, Switzerland, with a price of billions of dollars, with the financial and technological support of several countries, in order to obtain smaller and smaller particles, in the attempt to discover the smallest material particle of any material particle.

universe. All for the sake of discovering smaller and smaller particles. But if we understand that principle, then we understand very quickly that they will continue to make particle accelerators faster and faster, and they will obtain smaller and smaller particles, because they will always continue to divide! Hyperborean Physics, then, does not apply to this type of research, because we understand that what we really need to understand is not the size of the particle, but the dynamics of the division, the dynamics of quantization.

This also implies, therefore, that each of your atoms, each of your cells, each of your bodies, has infinite potential, has infinite connectivity with the whole. And here we draw a very important conclusion: **if you can divide it infinitely, it has infinite mass.** In physics, bodies with infinite mass are called black buracos. So each of its cells, each of its atoms have mini black buracs. And when we remember that the microcosm is a copy of the macrocosm, the full potential of the pasu becomes clear.

There is another important conclusion to be drawn from this event: **if there is infinite potential for both the greater and the lesser, then the universe is expanding and at the same time contracting.** Thus, the external part of the existence of the universe is expanding and its internal existential part is contracting. And more: by the principle of action and reaction (every action generates an equal and opposite reaction) and also by the principle of duality, there must be balance between the expansion and contraction of the universe. Pray, the Universe of the One is dual: you have day and night; Yin and Yang; masculine and feminine; good and evil; black and white; so, if there is a part of the Universe that is in expansion, there is necessarily another part that is in contraction! The contracted part of this equation of equilibrium is precisely the part that generates, creates; and the part that radiates is the part that alienates, destroys. And ALL the science of today, all the knowledge of the lost pasu or virya is based on the radiating part. They are just to this day exploding everything! They fill a rocket with thousands and thousands of liters of fuel, put some people on top of it and hope that they will survive (or not) the experiment, explode gasoline inside the engines of cars, dynamites on the rocks, and believe that the universe is just expanding!

In the classic book "Gravitation", about the equation of relativity, by the legendary physicists Charles Minner, Kip Thorne and John Wheeler, the universe is shown as a globe with little coins inside. The coins represent the galaxies. And as the balloons are filled, the galaxies are distancing from each other, thus generating the expansion of the universe appreciated by the Hubble telescope, called the "Hubble Constant" or "Hubble Expansion", which says that the measure of inertia of the expansion of the universe is given by this constant, where the galaxies are distancing at a rate proportional to their distance. And analyzing all the equations of these famous physicists, we do not find any equation related to a fundamental detail of this expansion movement: the equation of who inflates the balloon. Who or what makes the universe inflate, expand? Because it, or he, is obviously a component of this dynamic!

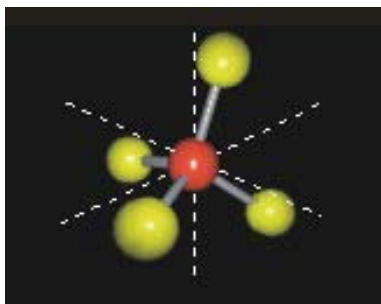
Moyano warns us in the FSH that one of the great errors of modern science is to fragment, to divide events as if they occurred only by themselves, in isolation. And here we have one more classic example of that grotesque error. Because the balloon is expanding, it is because the lung of the one who fills it is contracting. Then, if the universe is expanding, something must be contracting to generate the necessary energy to the expansion movement. **We arrive, then, at the so-called 4th. Dimension: the contracted side of the universe.** First Law of Physics, already quoted: every action generates an equal and opposite reaction. And that was simply left to

for after by the current physics! And all this movement of expansion and contraction has a very specific topological, dynamic structure.

Well, if we look at the universe we will see that everything in it radiates, which leaves the question: where does that radiation go? Answer: to the void, the void of space; see for example the energy radiated from the sun. So the void cannot be understood by us as emptiness, can it? Because no energy is lost or created. And if all suns, all stars, all galaxies radiate into the void, then the void must be full. Full of energy!

Now we can draw from these concepts another important conclusion: **the void is the side that contracts**. And when it contracts, it releases the energy that generates the movement, giving impulse to the universe, whose movement generates energy that radiates to the void. In other words, the contracting side of reality is the side that the pasu does not see. And it does not see it because it is contracted in the direction of the infinite, putting itself far away from us.

It is interesting to note that to this day physics is still uncertain about what an atom is. After all those years of study they still cannot say what an atom is. The very idea of the atom translates into something that cannot be divided (A = no, TOMO = division), that is, the smallest particle in the universe. And we already understand the error of this concept, so how can they want to affirm anything else? The only thing they can affirm with certainty about this matter is that it is composed of 99.99999...% of space. That is, it is almost entirely space.



Everything you look at, everything you touch, even you, is composed almost entirely of space. And what is it that connects the different points of the universe? Answer: space. And it is for space that all energy is radiated. Now we can then conclude that an atom is a division of space, like the stars that we saw above, divisions of space to infinity. Let us think, for example, in music: you need silence (pause) to be able to divide it, to make a rhythm, a beat. In breathing, you need the pause to be able to differentiate inspiration from expiration, and so on.

Therefore, "reality" is the division of space into a fractal structure of emptiness, where emptiness, far from being empty, is structured and energized.

But, for the Hyperborean Wisdom, the void, the contracting side, is called the "archetypal plane", as Moyano explains in Part 1 of the FSH:

"The archetypal plane is, as the analogical scheme shows: that part of the Demiurge which liaises with the material plane on all sides, contains the latter and determines its phenomena. If one considers, as is classical, a threefold composition of the Demiurge, Power, Beauty and Wisdom, it may

that the 'Wisdom' aspect corresponds directly to the 'archetypal plane', where the 'Divine Plans' exist, that is, the Universal Archetypes and Manus; that the 'Power' is exercised by the 'Breath' or transcendent flow of His Time-Consciousness upon the material plane; and that the 'Beauty' aspect consists of the potential integrity of all archetypal entelechies."

It is where the archetypes are, charged by all the potential energy that drives them towards entelechy, releasing that energy, driving the archetypes and defining reality. That is why the pasu does not see the astral plane. Because it is extremely contracted. **And if it is contracted, the density of energy is very great.** Let's look now at what current physics says about the density of energy in the astral plane.
empty:

"The current quantum field theory is split by a process of re-normalization of an energy density in the vacuum that could be infinite, if not removed by re-normalization."

Not bad, is it? At least they understand the concept of energized vacuum. This means that for the current physics on sub-atomic particles, quantum physics, there must be an enormous amount of energy in the vacuum for all this physics to work. But here we have, once again, the big mistake of being able to isolate a certain aspect of the phenomenon: the removal of that energy from the vacuum by "re-normalization". And why do they try to remove that energy, "which could be infinite", by re-normalization? For the current physics, there are two infinities: infinite small quantities, infinitely small until no value is attributed to it; and the other one is called by the physics books: Sublimated Infinity, which is infinitely large. But differently from the previous situation, when you find an absurdly large amount of energy, for example, you cannot simply ignore it. How to ignore an enormous amount of energy that can, for example, move a galaxy? And what does the current physics do with all that energy? According to one current and almost standard procedure of science in general, somehow science simply gets rid of it! And the way used by them to get rid of that sordid infinity of energy is the re-normalization, that is, When they have an infinitely large number they cut it out! They take it out of the equation! They sweep the matter "under the rug" and just don't talk about it anymore. So, for example, you can even have a PhD in Physics who has never heard that the density of the vacuum is infinite at the Planck distance (Quantum Physics).

The Planck distance is 1.616×10^{-33} cm. That is a very, very, very small point. And basically they say that this small point is the smallest thing that the universe produces (and we just explained about this subject). And what they did was to see how many of those Planck points fit in 1 cubic cm of space, to try to re-normalize the infinite density of the vacuum, to get an "approximate number". Then they will calculate that the density of the Planck measurement should be 10^{94} gm/cubic cm. Soon, they now have a finite number! But what is this finite number? To get an idea of what that number represents, if we put together all the stars we observe in the universe with the largest telescope on earth (and what we see are about a hundred billion galaxies, each with about three hundred billion stars) and put everything in 1 cubic cm of space, we still would not have 10^{94} gm/cubic cm of density. All that would be too little. Now they have a finite number, but it really seems quite infinite, doesn't it? The current physics should try to understand itself with the infinite, instead of trying to "re-normalize" the infinite.

lo". Physicists must overcome their inability to work with infinity. Still, at least they understand that the void is not empty and that it is extremely dense.

And how can the void be so dense and the pasu fail to see that? The void is everywhere, and in its characteristic of infinity, it is in perfect equilibrium. And if it is in full equilibrium, there is no way for the senses of the pasu to perceive it. It can have infinite forces, but even if it is in "*perfect equilibrium*", the pasu will not perceive them. It is like a fish in the water, which will never know that it is in the water until one day some person removes it from the water or exposes it to the air, that is, until it perceives a different density. The pasu has no way to feel a different void, so he thinks that the void is empty. And so it is, because this knowledge of the archetypes that comes to us by a strategic movement of the Loyal Siddhas, the Hyperborean Wisdom, is forbidden to the pasu.

Well, we have seen that it is vacuous, the Archetypal Plane, that is what defines reality.

And how does it do that? Let's see what FSH tells us:

"The gravis is the "heaviest" of the psychoid archetypes and its action is directly related to the spatial, i.e., extensive, form of matter and energy. That is why gravis, which is the last of the scale, is also the first that the Demiurge precipitates when he prepares to "organize" a material plane. Without gravis no other Archetype could evolve in matter."

Well, then, the Gravis Archetype is what, from the archetypal plane, organizes all reality, all the dynamics of the Universe of the One. And how does it do it? The answer with the help of the FSH:

"Every archetype tends toward an entelechy. But, at the origin of the movement, the first impulse is produced by a power that contains within itself the perfection that is intended to be reached; the movement is thus an evolutionary development that aims at a finality that has also been a beginning. As finality the entelechy is something that "is not yet", that must be reached, that is to say, something "future".

It also states:

"The culmination of any evolutionary process, of any Archetype, is its final perfection, which is present in the ontic as a potential entelechy, as a finality that is identical with the beginning. And here we will give another definition that will complete the description of the properties of the Gravis Archetype, and to which we will refer again later: THE POTENTIAL ENTHELEQUIA OF THE GRAVIS ARCHETYPE COINCIDES SPATIALLY IN THE SIMPLE BODIES, WITH THAT IDEAL POINT WHICH PHYSICS HAS NAMED "CENTER OF GRAVITY".

And it continues:

"Physics supposes, and supposes well, that a relation links the mass with the gravitational field. Where it is mistaken is, since Newton, in the affirmation that such relation is of cause and effect, that is to say, that the gravitational field occurs by effect of the mass; with such erroneous concept it is not strange to observe the enormous armatostes that must be manufactured to take advantage of the aerial space. Y,

naturally, they, the manufacturers of flying gadgets with metal engines and "internal combustion", would doubt our sanity if we assure that the Loyal Siddhas, ON THE BASIS OF THE ARCHETYPICAL CONCEPT OF GRAVITY, have vehicles of STONE, for example, to move to any place they wish; and even more if we add that such vehicles do not have engines. But this is not a delirium but "science"; ancient, extraterrestrial science; science that the Black Order SS developed again in this century and that allowed them to build their own "flying saucers" in which their best surviving cadres left for the Antarctic oasis and other hidden bases of the Earth. And from those bases, which cannot be located even with spy satellites because they are camouflaged? also psychoid, will return the SS Knights of the last battalion of the Führer integrating the Wildes Heer of Wotan, at the end of the Kaly Yuga, in the gottendemerung. But this is another story, or, rather, the End of History."

To recapitulate, then: the universe is in expansion and contraction to its entelechy, the void is contraction and manifested matter is expansion, and all reality comes from the feedback between expansion and contraction.

Now we can draw an important conclusion: **the expansive part corresponds to the electromagnetic radiation of the universe and the contracting part corresponds to the curvature of space-time, to the gravitational field generated by the process of entelechy of the Gravis Archetype**, in the direction of the singularity at the center of this system, which can also be called "abraxas' eye", "indiscernible point", etc. Let us see by the words of Nimrod:

"For the Hyperborean Wisdom, the mass of the Earth generates a curved space that is a reflection of the distortion that the gravis represents with respect to transcendent Time".

The expansive part of the universe is the reality that the pasu or lost virya perceives, it is the emission of radiant electromagnetic energy. A star, an atom, everything radiates energy and that is why it is perceived by the pasu. And the part that contracts, that the pasu does not see is the energy of the void and the space-time curving itself inside the system until an indiscernible point. And that movement obeys the snail design. We have now, finally, the relation between electromagnetic field and gravity.

When Einstein wrote the field equations, he failed to solve them. It was the physicist Karl Schwarzschild who did, and his calculations became known as the "Schwarzschild Solution". And the first solution for those equations was: a black buraco, also called the "Schwarzschild Singularity". And when the equations are directed towards the singularity, to the indiscernible point, the numbers tend to infinity. And this part is ignored by the current physics, it is the so-called "unresolved nonlinear part of Einstein's equation". So the current physics uses only the weak part of the gravitational field, the part that is not curving much in the direction of the indiscernible point. Enormous amounts of energy are simply ignored because they do not fit into the concepts of modern physics, into its cultural structure.

Interesting the words of the theologian Joseph Farrel in his interview to Project Camelot about the Physics of the SS in the III Reich:

"Within the SS there is an ideological culture that instead of engaging in scientific progress, what it was doing was forcing science to achieve this hyper-dimensional physics. This is what the Germans were doing. I want to emphasize here the importance of why Nazism is the

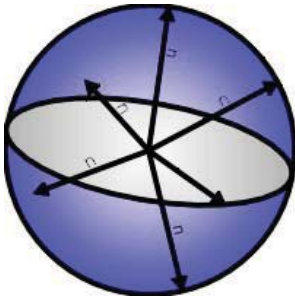
ideological cauldron of all this: Nazism had set aside Jewish physics, or in other words, relativity. It even had ideological difficulties with aspects of quantum mechanics because it considered it too statistical, too probabilistic; it was not deterministic enough for some Nazi ideologues. What follows from this official history is that in Nazi Germany there was an abandonment of the scientific method that led physics to a dead end.

But I think you look at it now, 100 years after 'relativity' you see precisely that physics (the dogma of modern science) is at a dead end. It's a dogma that is being challenged by reality.

What in a way I think Nazism did is to free its people to think 'outside the box.' And all that 'thinking outside the box' took place in the SS."

THE GEOMETRIC STRUCTURE OF THE UNIVERSE

Now, if the universe is contracting and expanding, there must be a geometry, a structure that describes the contracting side and the expanding side. The geometry of the expanding side is easy to understand. As the universe was created from a primary monad, an initial indiscernible point, everything else expanded and expands multidirectionally and radially from this point. The shape of the expanding side is, therefore, a sphere.

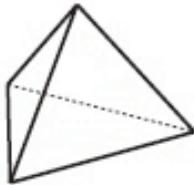


But what about the shape of the contracting side, and why are we interested in the structure of the contracting void? Because if we understand the structure of the contracting void, we will understand the basic geometry of creation. Because the void is the main force, what holds things together. So that is the key to the force of creation of the universe.

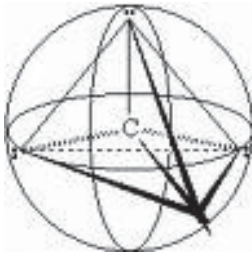
Using an example to better understand the idea: if we stick a ball and place it on the end of a rope, grabbing the other end of the rope and start to rotate the ball, when it reaches a certain speed we will feel an external force acting, pulling our hand out, to the side of the ball. This is the centrifugal force, and it is not the real force. It is not the real force, because the only reason for that force to manifest itself is the initial force applied by your hand on the opposite end of the rope, thus turning the hand-body-ball system into a dynamic system. This primary force is the true force. From this example it is worth mentioning the

analogies with the present situation of science. It concentrates on the centripetal force, resulting from motion, and not on the main force that makes the ball spin. In other words, the present science concentrates only on the radiated force, when the true and great force, the one that makes everything radiate, is neither known nor utilized.

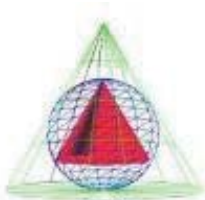
What we know, for now, is that, as everything in the universe, the geometry of the collapse must be in equilibrium. If the sphere is the largest possible volume, because it is expanded, the geometry of the collapse of the void must be the smallest possible geometry, the smallest volume, the volume that goes into collapse, and that is a tetrahedron.



Then, the relation between the geometry of expansion and the geometry of contraction would be a tetrahedron inside a circle.



In "The Mysteries of the Mexican Pyramids", the author Peter Tompkins shows us a graphic where a tetrahedron is contained in a sphere, intersecting - at exactly 2/3 down and 1/3 up, at latitude 19.47122064°.



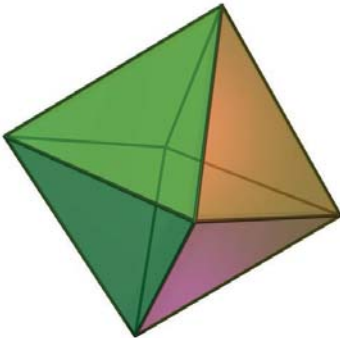
This graph is the result of a work of an American engineer, who was hired to research about the enormous city of Teotihuacan, near Mexico City, where it has the pyramids of the sun, the moon, the path of the dead, etc. His

and his study was published by the America L. Society after 20 years of research on the local constructions. In his work, he perceived that all the constructions of the place, the great buildings and temples were organized according to the orbit of the planets of our solar system, including Pluto and Neptune, which would only be discovered by our astronomy at the end of the 19th century and beginning of the 20th century. And he also discovered that there was a common mathematics in all the measurements they made. And it discovered that this mathematical factor common to all the measurements pointed to the geometry of a sphere with a tetrahedron inside. What he did not realize is that Teotihuacan is located at 19.47° latitude on the earth. So it not only has the mathematics of the tetrahedron inside the sphere for all its extension, as it is positioned on the earth exactly at the point where the tetrahedron intersects with the sphere.

In the end of his work, the American engineer makes a very important comment on the Isotropic Vectorial Matrix of Bushminster Füller. It says that the mathematical constant that he discovered in the research of the city pointed to $3/8$, which is the constant of the Isotropic Vectorial Matrix. He thought that this Matrix was the basic mathematical plan of the universe. Composed of 10 tetrahedra in the base, 6 in the second layer, 3 in the third and one in the top, forming an enormous tetrahedron. So there are 20 tetrahedra forming the Isotropic Vector Matrix.



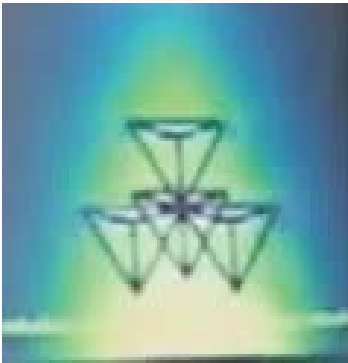
But we cannot forget about the space between the tetrahedra of the Matrix. If we remove the tetrahedra, we obtain octahedra inside the tetrahedra.



One octahedron is two pyramids, joined at the base. We have then, present in the Matrix, the pyramidal structure. For this reason many Atlantean constructions made in the

world have a pyramidal shape. Because they know the structure of the void, the logos of reality.

And when we remove the tetrahedra, we also have:



When we do that, we perceive something wrong, because the matrix should be isotropic, that is, it should be in equilibrium, there should be symmetry. But there is no symmetry in the center, there are 4 tetrahedra pointed downward and rotated 90°. They belong neither to the octahedra nor to the forming tetrahedra or formed by the whole. Then there are 4 tetrahedra completely out of place, causing imbalance in the whole structure, creating asymmetry not by means of symmetry. This evaluation is enough for us to perceive that the shape is still incomplete. For the fundamental structure of the void must be isotropic, thus obtaining perfect equilibrium. And the universe of the One is polarized: dark and white, male and female, day and night, etc. So reality must also be polarized. And in our search for the form of the collapse of the void, we have to keep in mind the perfect equilibrium of the geometric system, and a single tetrahedron in a sphere is neither in equilibrium nor polarized. So we have to have another inverted tetrahedron inside the circle. We must have, bearing, another inverted tetrahedron, polarizing with the first one.

Or result would be, then, an octahedron, as in the second figure above. But here we have another problem, because in this way we will not have a spherical structure of universal expansion, but an oval structure, as in the figure below:



And, how to make this structure become spherical without deforming the Isotropic Vector Matrix? By "pushing" one Matrix against the other, until the line of its bases reaches the latitude of 19.47° of the sphere. In this way we will have:



When you do that, you have a perfect sphere.

And that symbol, the double tetrahedron inside the circle, is one of the oldest symbols of humanity, appearing in the most diverse civilizations around the world. A circle with polarized equilateral triangles. The famous Davi's Star, or even Solomon's Seal, Star of Zion, etc., which is nothing more than a two-dimensional vision of this structure.



And more: its central geometrical structure is the vectorial equilibrium; the only geometry in total equilibrium between all the possibilities of the vectors. All the vectors have the same size, thus avoiding the implosion of the structure. And there are 12 vectors leaving the center, responsible for the equilibrium. A number so well known by all civilizations: 12 months of the year, 12 signs of the zodiac, 12 apostles of Jesus, 12 works of Hercules...



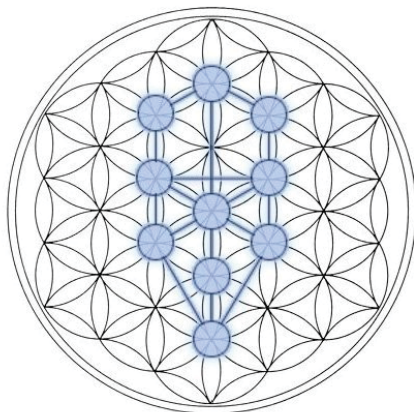
And there is no more distortion, because the 4 tetrahedra in the middle of the matrix were only there to fit with the other reverses. Therefore, the Isotropic Vector Matrix was without its half-face. With that, the octahedra of the center were complete, but those of the edge were not, so we still do not have an equilibrium. Then it is necessary to continue adding tetrahedra until the symmetry or equilibrium is achieved. E are more 24 tetrahedra until this goal is achieved, until all the uncovered faces are covered. We have, therefore, 20 tetrahedra of the first matrix, plus 20 tetrahedra of the second, plus 24 added until reaching the equilibrium, totaling 64 tetrahedra. Thus we arrive at the geometric form of the void, of the contracted universe, of the first monad on which the one projects all the thought entities, as Moyano explains to us in Part 1 of the FSH:



"In reality the universal Archetypes themselves are composed of monads, which are therefore also called 'archetypal', for they come from the first emanation of the Demiurge, while the Archetypes are 'ideas' thought UPON the monads, in the second emanation. The universal Archetypes are thus forms ranging from the simple to the complex composed from groupings of the ABSOLUTE FORMATIVE UNIT which is the archetypal monad. It is not true, then, that the universal Archetypes are all perfect and simple ideas, but that, on the contrary, they have been structurally conformed by successive and orderly imitation of the archetypal monad: it may be said that THE ENTIRE UNIVERSE HAS BEEN BUILT FROM A FIRST MONAD IMITATED INCANSABLY BY THE DEMIURG. That is why the ESSENTIAL CHARACTERISTIC OF THE DEMIURG IS IMITATION."

And if we add to the figure the fields of expansion of each of the 64 tetrahedra, we will then have what the Sinarthic kabbalists call the "Flower of Life", that is, the geometric structure from which all life and creation is born.

FLOR DA VIDA



Fonte: http://159.photobucket.com/albums/aa111/Diedradi/Tree-of-Life_Flower-of-Life_Stage.jpg

And for us, students of the Fundamentals of the Hyperborean Wisdom, the Flower of Life is nothing more than the First Monad, as Nimrod explains to us in Part I of the FSH:

"The first step of the 'emanation' are the MONADS, archetypal atoms that underlie the whole cosmic structure and act as the MATRIX of the Plan of the One".

We have here another cabalistic number: for example, there are 64 codons that form the 24 amino acids of the DNA structure. This is how the first human cell divisions occur, for example: first, a cell divides into two...

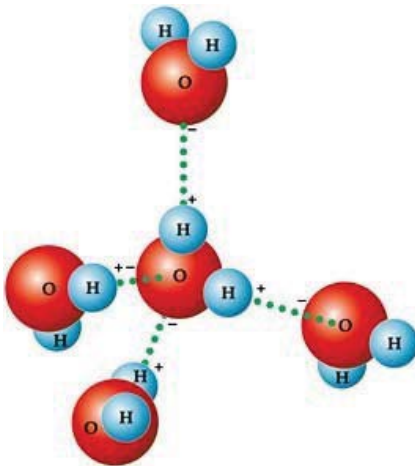


... and then those two divide into four and form a tetrahedron; not a line or a square, but a tetrahedron.



And then they divide again, originating other four cells that compose the inverted tetrahedron, and so on, until they reach the number of 64 cells, that is, until they reach the structural formation of the collapse of the void, where everything is compacted, not limiting its density. Up to this number, all first cells, stem, are equal. From this point on, each one will develop according to its specific task in the organism.

Well, let's take for example water, that important substance from which all life on earth arose. Water molecules are H_2O , which can have positive and negative charges. These are called polar molecules. When the hydrogen atoms of the water molecule (positively charged) are placed next to the oxygen atom of another water molecule, we have a bond between them, called "Hydrogen Bridge". The Hydrogen Bridge guarantees the cohesion between the molecules and keeps water fluid and stable under the usual conditions of temperature and pressure. Some of the most important properties of water come from hydrogen bridging, such as surface tension, capillarity, high specific heat, solvent capacity, etc. But here is one detail that is of great importance for our studies: Hydrogen Bridges are tetrahedra!

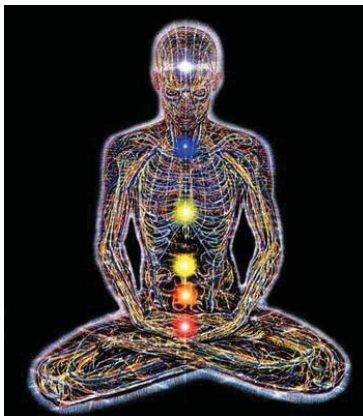


Its structure contains four H_2O molecules, each one at a point of the tetrahedron, and another H_2O molecule at the center of gravity of the structure, where its

black burachus, and in it the Eye of Abraxas. Water can function, then, as a transducer of information from the void, from the archetypal plane, to this reality, to the material plane. This is one of the reasons why Atlantis sank. It was not ended by fire, by meteor impact, or by volcanoes, nothing like that. Atlantis and a large part of the world sank in the water because a large amount of water was necessary to bring all the new information from the void to reality, from the astral plane to the material plane. A great quantity of information about ALL THE ARCHETYPICAL AND GEOMETRIC FRACTICAL STRUCTURE OF A NEW

REALITY, of a new era. Or also, as another example, the body of the pasu, a fact that is already known by its science, is in its great majority composed of water. This great quantity of water is responsible for the transmission of information of the ontological designs activated by the Logos Kundalini in its path of Ida and Pingala, from the soul in the Astral Plane to the body in the Physical Plane. That is why we hear stories of various seers over the centuries who used water in their forecasts, such as the mother of Achilles who was in the water when she made the reading of her future, or Nostradamus who used a vessel with water. Or still, the Lady who delivers the Excalibur Sword to Merlin is the Lady of Water, as well as the Tyrodal Knights use water to do the Ritual of Strategic Opposition, as John Dee did, as Moyano explains in "The Secret History of the Thule Gesellschaft". And also our drink, the Hydromel, (from the Greek, hydro = water) is made of... water! Because a transducer capable of bringing the information from the archetypal plane that will define our reality must be a tetrahedron, there must be combination, connectivity.

Another interesting example of the connectivity property of the tetrahedron is the Lotus meditation position used by the synarchic schools. In this position, the body takes the form of a tetrahedron, with the 3 base-points formed by the knees and the coccyx, and the upper extremity formed by the head, thus facilitating the connectivity between body and soul during meditation.



Another important property of water is that it is the only substance we know of that expands when it cools and contracts when it warms. All substances contract when cold and expand when heated. Meanwhile, water, between zero and four degrees Celsius of temperature, has a thermodynamic structure

completely inverted: it contracts when it warms up and expands when it cools down. And that is the other characteristic that makes possible the "link", the connection, between these two planes, contracted and radiated. Another interesting characteristic is that a snowflake, obviously made of water, is a hexagonal vector equilibrium, and it is fractal. There are millions of different snowflakes and all of them are hexagonal in nature.

Returning to the first monad, to the geometric structure of the void, what is obtained then is a fractal structure in complete 3D spherical coordination. The vectorial equilibrium inside and outside continues to crescendo to infinity. In the inner vector equilibrium, the radius is exactly half of the outer one. So the geometry not only grows fractally as perfect opposites. Infinitely large or small. Here then is the geometric structure of the void.

This structure is based on 8 star-shaped tetrahedra, each containing 8 tetrahedra inside itself ($8 \times 8 = 64$). They all come together at the center, and when this happens the 8 star-shaped tetrahedra come together forming the non-center vector equilibrium.



Why is this important? Because the 8 star-shaped tetrahedra are made from 8 tetrahedra pointing outward (radiation), coming together to form a vector equilibrium with 8 tetrahedra inward in the direction of the center (contraction).

The grade of 64 tetrahedra with the octahedron in the center generating vector equilibrium is a foundation, the structure of the collapsing void and the radiating side is the sphere. The pasu sees the sphere, the pasu sees everything that is convex. What the pasu does not see is the contracting part, what is concave.

So now we not only have the geometry of equilibrium but we also find the unique 3D fractal metric capable of generating radiation and contraction, maintaining stability, exactly as in the axioms! And also

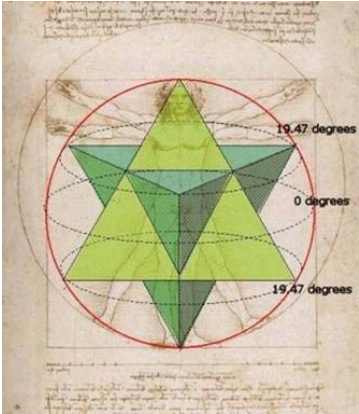
Now we understand why Judaism, Freemasonry, etc., use as a symbol the six-pointed star, formed by two equilateral triangles, inside a circle. Because that is one of the secrets of the architecture of the universe, of the work of the Demiurge. Or still, in our words, the geometric form of the first monad, base of all the entities of the Universe of the One.

Now, if we have the fundamental structure of space, all the technologies resulting from this information will have infinite potential for energy, gravity, regeneration, etc. We speak here of serious changes in the way of making technology. That is why it was stated here that this text contains the basic principles of SS technology.

And it seems that this is exactly what some UFOs try to show us with their famous "Crop Circles" made at dawn in some plantations scattered around the world. It is as if they were talking to us: "This is what you have to learn now: fractal geometry!"



The fractal division always obeys the golden ratio of 1.618, for larger or smaller. This is a constant in nature. For example, the tip of your finger is 1.618 smaller than the second phalanx, which in turn is 1.618 smaller than the third phalanx; your finger, in turn, is 1.618 smaller than your hand, which in turn is 1.618 smaller than the tip of your forearm, which in turn is 1.618 smaller than your arm, and so on.





Your whole body is like that, all nature is like that: fractal structures. And that fractal behavior gives nature emerges directly from the structure of the void. The void directs reality, and reality portrays the structure of the void.

For example, let's look at that FSH stretch:

"Let us look at some of these marvelous possibilities. He who has understood the Gravis Theory, for example, can SEEK IN HIMSELF, in his microcosm the indiscernible point and, BY MEANS OF THE GRACEOUS WILL, MOVE THE CENTER OF GRAVITY OUT OF HIS BODY, AVOIDING THE WEIGHT, THAT IS TO SAY, THE TRACTION THAT THE EARTH EXERTS ON ITS MASS: IT IS "LEVITATION". But, as its own indiscernible point is the same as that of the stone that is there, it will also be able to move it by an act of its will: it is "psychokinesis". But when a skillfully designed material body is brought to coincide in its entelechy with that of a human body, then one has a vehicle "that travels without an engine", like those that the Hyperboreans have always manned. And since at the indiscernible point there is spatial distortion, such vehicles can become invisible by "temporal acceleration" and not by "high vibrations" as certain materialistic ufologists and sinarchs maintain."

When we speak of "a skillfully designed material body" that coincides in its entelechy with that of a human body, we are talking about fractal geometry.

As another example, the physicist Kepler resolved, one day, to join all the geometries and from his calculation to trace the orbits of all our solar system. A totally crazy idea, if it was not for the fact that... it was true! And it is until today the most accurate solution, with 99.9999...% of success. And Kepler's Scale Law uses the golden ratio.

If we stick all the bodies of the universe, all obey the condition of Karl Swordchild on the black hole. Current science has calculated the radius of the spherical expansion of the universe. If we stick the total mass inside the universe, we will see that it exceeds the escape velocity of light. Also it is already known by the traditional physics the fact that the light or the electromagnetic energies can be curved by the gravitational force (space-time curvature). So, if we emit a date of light in a certain direction, it will follow the challenge until it passes by a star, for example, when it will make a curve; and it will make another curve passing by another star, and another, and another, and so on, until it returns. It cannot escape from our Universe of One because there is a lot of mass in it.

And what does that mean? Answer: we live inside a black hole! That is why, when we look at the sky, at night, it is black. This happens because the light contracts non-vacuum in direction to the singularity, to the indiscernible point. And all that is inside this black burachus are minor black burachus, of which you are outside.

Current physics is divided into quantum theory (atomic particles and sub-particles) and cosmology (relativistic equations and two large objects). Again, the same mistake of dividing, separating events that are not really isolated. A quasar, the center of a galaxy, a star, a planet, an atom, a sub-atomic particle, etc., everything is related and responds to the same principle.

Now, if we are in a universe that is a black hole, the smaller black holes within it, which we observe from the outside, look like white holes. We see the side radiating from the event horizon. It looks like a star, a planet, an atom, a sub-atomic particle? In other words, the black and white bubbles are not different objects, they are one inside the other. And there is a feedback of the gravitational field and the electromagnetic field. Radiation generates curvature of space that generates radiation, creating an open feedback. And what is an open feedback? Answer: it is a fractal.

Well, in this sense, knowing that everything has a black hole is nothing new for us who have already studied the indiscernible point. Nimrod explains to us in the FSH that all bodies, independent of their size, have the indiscernible point, the eye of abraxás, the singularity. Moyano explains to us in the FSH:

"Thus, therefore, no precaution that the virya adopts will be excessive in dealing with this subject since THE DRAGON OF THE WORLD IS PRESENT IN ALL ENTITIES, FOR ALL ENTITIES ARE PART OF HIS BODY."

And yet:

"In the entelechy of the gravis, from the indiscernible points that are in all bodies, that is, from the transcendent time that is His Consciousness, He is sustaining the material order. BUT HE DOES NOT ACT THROUGH THE GRAVIS. HE ONLY SUSTAINS THEM. IT IS NOT THE LOGOS ASPECT THAT MANIFESTS ITSELF IN THE INDISCERNIBLE POINTS, BUT THE CONSCIOUSNESS-TIME ASPECT. IT IS NOT THE VERB BUT THE EYE OF THE DEMIURGE. AN EYE TIRELESSLY MULTIPLIED IN ALL CREATION BUT WHICH IS ALWAYS THE SAME EYE: BEHOLD MAYA. AN EYE THAT CONTEMPLATES ITSELF, THAT PERPETUALLY ADMIRES ITSELF. AN EYE THAT IS IN THE WOLF THAT STALKS AND IN THE LAMB THAT FLEES, IN THE MAN WHO PLUNGES THE DAGGER INTO HIS BROTHER AND IN HIS BROTHER WHO DIES AND, ALSO, IN THE DAGGER THAT BECOMES DRUNK WITH GURGLING BLOOD. AN EYE THAT LOOKS FROM THE BELOVED AND FROM THE BELOVED AND FROM THE BETRAYAL OF THE THIRD. IN SHORT, THIS EYE, WHOSE SOCKET IS A CHASM THAT DESCENDS INTO THE ABYSSES OF GOOD AND EVIL, IS THE EYE OF ABRAXAS, A TERRIBLE EYE AND A TERRIBLE EYE, A TERRIBLE EYE, A TERRIBLE EYE.

INSANE. Not for nothing did the Alexandrian Gnostics, who knew what kind of monster they had to deal with, enclose the Eye of Abraxas in a triangle, that is to say, they applied the "law of encirclement", so as not to go mad with schizophrenia. The Hyperborean Initiates, the awakened viryas or the Knights of the SS, for example, like those Gnostics, also possess techniques to resist the dissolving gaze of the Demiurge and the indiscernible points of the gravis for the benefit of the Strategy of the Siddhas. And these questions seem to be unanswerable in an era in which, if one does not have a Bevatron, it seems that no one can even dream of investigating the interior of matter and, if one does not have a crane, it seems that one cannot even dream of investigating the interior of matter and, if one does not have a Bevatron, it seems that one cannot even dream of

investigating the interior of matter.

hydraulics, who would try to move the stones of Sacsahuaman? But the truth is that only for the marvelous should one "take advantage" of the Gravis Theory, which is a science of the Siddhas and from which the lost pasu and viryas are excluded."

The novelty is only in the thermo-common to modern physics, buraco-black. All we have, then, are bodies with black buracs changing their organization in the universe, evolving to their entelechy. They simply evolve from one level of organization to another level of organization. From one fractal sequence to the next fractal sequence.

Just to give you an idea, all the gaseous planets in our solar system produce 70 to 80% or more energy than they receive from the sun. And nothing and no one in physics today knows how to explain why. It is clear that there must be some internal dynamics of energy production. But for us there is no more mystery, since we already know that it is the black-brown, the indiscernible point, at the center of these bodies.

No case gives land, for example, it is estimated that your black buraco is no more than the size of a soccer ball. That is very, very small in proportion to the size of the earth. But enough to generate all the energy of its dynamics. It explains even the rotation of the earth around its own axis. The situation is that we are so far away from the black buraco, so far away in its horizon effect, that gravity here is already weak. And the expelled plasma has already caught a cold (long distance implies long time) and the crust on which we live is that cold plasma. The surface is round because time and space are curved by its gravity, and this is the shape of the expansion...

So, when we study the FSH sequences of ontic matrices, it is now clear that what differentiates one matrix from the next, both for front and back, is fractal geometry. That is why the knowledge of the ancient alchemists was so full of geometry. Because they understood that, for example, to transform prickly pear into gold: 1- the two states (prickly pear and gold) are just different ontic matrices of the same matter; 2- the difference between these ontic matrices is defined by fractal geometry.

As we saw, all the non-universe created, including the body and the soul of the pasu, obey the fractal geometry from the structure of the collapse of the void, of the first monad. And an important conclusion can be drawn if we keep in mind all that we have analyzed by physics and geometry so far: man, or pasu, is an extension of space looking back to itself. Here it is then, by physics and geometry, the explanation for the definition of Moyano in his FSH that the purpose of the pasu is to put sense in the work of the demiurge. And that is the return, the feedback of reality. The pasú is the universe experiencing itself, knowing itself. Through the Pasu the Demiurge contemplates his own work. And that return between the internal and the external is what drives the dynamics of all the forces of the universe created by the One. This point of view can be reduced, appreciated on the cultural structure of the current physics, as two forces: gravity and electromagnetic field; no return between the two.

Well, let us now examine a bit of current physics, to draw a parallel and see how this science behaves in the face of certain physical events. When you observe in the atom the electrons spinning around a positively charged nucleus, without ever slowing down (an electron spins at a speed of 99.9999...% of the speed of light), what do they do? If the electron does not slow down, it is because it is subjected to a constant acceleration. And this is a great conceptual problem, because they do not know

explain what generates that acceleration. And instead of re-examining Newton's Laws, they will invent a new kind of physics, quantum physics. They say that the first axiom (mathematical truth that does not need to be proven) of quantum physics is: we do not care about the cause! That is the first axiom of quantum physics. That is, we don't care about what makes the electron spin. And if someone asks about that, they just don't answer the question. And they will start from one point, from one energy level, to the next level and to the next, drawing a map, so that they can predict the first electronic layer, which is the hydrogen atom, and then they will approximate the values of all the other atoms from it, going all the way to our periodic table of elements. Gods! Stupidity sometimes has no limits. They would do all that, based on a false assumption, and even without ever explaining why they are spinning without slowing down!

Let us then analyze Newton's Law on the conservation of energy. It states that:

"If a system DOES NOT INTERACT with the environment in any way, as certain mechanical properties cannot change, they are sometimes called constants of motion. These quantities are considered as conserved in the laws of conservation, the result of which can be considered one of the most fundamental principles of mechanics, which are the so-called NATURAL LAWS. In mechanics, example of conserved quantities or 'momentum' of energy or angular 'momentum', these conservation laws are exact for an ISOLATED SYSTEM".

All current physics is based on this, so we have to ask: what is an isolated system? Second, the current physics is:

"One set of matter that does not interact with the rest of the universe in any way, and as far as we know such a system does not exist."

Or even:

"An isolated system, in physics and chemistry, is a system that exchanges neither matter nor energy with the environment, being delimited by a boundary completely impregnable to the exchange of matter, to the variation of volume, and to heat. There does not exist any known real system that satisfies with absolute precision these conditions, but, in fact, it is possible to obtain very good approximations for them, along sufficiently large but still finite intervals of time".

That is, all the Natural Laws are based on something that is not found in nature (and that is not a hyperborean paradox)! Ah, that is a big problem! Because hyperborean physics teaches us that the electron, the atom and everything else in the universe created by the One are connected. An isolated system does not exist. The current physics continues explaining that:

"There is no shield against gravity and the electromagnetic force is infinite in scope, but to keep it focused on a basic and useful principle, to postulate such a system to clarify the

nature of the laws of physics and in particular the laws of conservation can be postulated to be exact when we refer to an isolated system."

That they just said it doesn't exist! That's current physics! It's all based on a principle that doesn't exist in the universe!

Yes, comrades, there is no isolated system in the universe created by the One. Only the Hyperborean Initiate, the Tyrodal Knight, can, with the power of the Eternal Runes, the Technique of Strategic Opposition and the Noological Science of Hyperborean Yoga, isolate a certain place from demiurgic time and space. For all the rest, there is no isolation: everything is under the watchful guard of the eye of Abraxas. Our explanations are reinforced by Nimrod in the FSH:

"The 'material plane' is thus a world of boisterous dynamism in which there is no place for stillness except in a referential sense; 'stopped' with respect to something mobile. Such a world is purely Phenomenal, subject to temporal processes, whether continuous or discrete, which in any case surpass the capacity of human apprehension based on a triple partition of time: past, present and future. The apprehension of a phenomenon in the 'present' moment of knowing implies having surprised it in a phase of its process, having grasped only a fleeting appearance, having perceived an image of a possible series, having known, in short, only an aspect of its truth. Such a world, then, in the face of human sensory impotence to apprehend the phenomenon in its process, SEEMS TO HAVE BEEN SPECIFICALLY DESIGNED TO PRODUCE ILLUSIONS AND INSUPERABLE APPARENCES."

And yet:

"The usual gnoseological color-blindness of the Western 'scientist' is in the case of cosmic evaluation a simple myopia, in spite of the extension of the sensory spectrum which implies 'instrumentation', because NOTHING CAN BE KNOWN OUTSIDE, NOTHING THAT HAS NOT BEEN PREVIOUSLY KNOWN INSIDE. Already man's NATURAL sensory information was insufficient and equivocal to apprehend a phenomenon: but TO INTERCALATE between the unknown phenomenon and the senses a known phenomenon, that that is an 'instrument', and to pretend that from that triple implication true knowledge can be obtained is sheer folly. What is obtained are 'scientific theories', that is, a kind of poison whose toxicity increases in direct proportion to the structural complexity of the factual object it attempts to explain."

Here enters a key of hyperborean physics, the fractal geometry, because in it everything is related. In this way we are able to understand geometrically this connection of all the created universe, between the minor and the major, between what is inside and what is outside.

Another nonsense of current physics is that when they discovered that the protons were positively charged and stayed together in the nucleus of the atom, they understood that a huge amount of energy would be necessary to keep them together, since the magnetic field of two equal charges repel each other. So, they would call this enormous force that binds the protons together the "strong force". They will simply invent a new force without knowing the origin of that force. We must remember the basic principle of quantum physics that says that they do not care about the cause, and they can invent whatever they want. So, they will invent a new force and will not talk about its origin. In

truth,

When they discovered the quarks, they discovered that the quarks were also bound together, and they will call this strong force that binds the quarks "Color Force", and so they will invent another new force, of which they also have no idea of its origin. This is modern physics.

But, if we consider that atoms or quarks have black buracs, and we calculate their gravitational force, then, we will see that the gravity generated by these mini black-buracs is strong enough to bind all these particles, including those of equal electric charges. So, there is no need for a "strong force" or a "color force", which is all pure invention of modern physics. It is not necessary to create new forces, just re-examine the sub-atomic particles under a hyperborean vision and all you will need is gravity and the electromagnetic field.

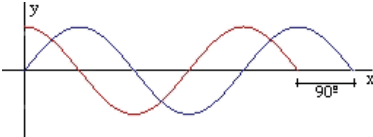
And this is another important point that should be emphasized: the primary forces, and therefore the only ones with real existence, are gravity and electromagnetism. All the others, kinetic, thermal, etc., are results, derivations of these two primary forces.

Now that we have seen some two errors of the current physics, we must understand that these errors can be reviewed and rewritten under the prism of the fractal analogy. This is a totally new way of writing physics, which accommodates the singularity, the indiscernible point. Simply, the biggest mistake of the current physics is that they do not know how to work with the infinite and with the indiscernible point, so they pretend that it does not exist!

Fractals are mathematical equations that can and should be applied in physics. A fractal equation is the repetition of an equation that creates an open feedback to infinity. So we have a completely nonlinear result. Thus we perceive that we can solve the problem of dimensions, describing the dimensions as different resolutions of a fractal.

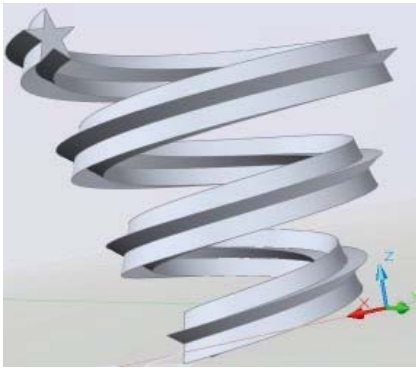
THE DYNAMICS OR MOVEMENT OF THE UNIVERSE

Another common error in current physics is in relation to waves. Current physics says that waves propagate in a sinusoidal fashion, as in the drawing below.



Physics textbooks say that almost everything travels in space in this way. And if this is true, why don't we see anything dislocating or propagating in this way? To understand this question, it is enough to remember a dinner of a stone remaining on a smooth and watery surface, like a lake. Then we will see diffusion of energy through the water, which will oscillate in the form of sinusoidal waves. Analyzing and observing these sinusoidal waves, our "brilliant" physicists, some of them with Nobel Prize in physics, will come to the conclusion that the waves propagate in the universe in a sinusoidal way. But there is a very important detail in this question that our contemporaries did not attempt: they will again take out a part of the phenomenon and analyze it in isolation. They only analyzed the waves themselves, without taking into consideration their cause, that is, the stone that remained in the lake. If we include the stone in the equation, then we will have a different model,

in the form of a cone or spiral. This is the first shape sculpted in the water by the energy released by the stone.



Therefore, the energy diffuses through the water in a spiral form, like a vortex, and not in the form of sinusoidal waves. Things in the universe do not go up and down, they are in rotation, in orbit... What is also not new for the scholars of the FSH, since we are familiar with the snail design.

Let us recall the explanations of Nimrod de Rosario in Volume II, Part II of the FSH:

"Well, the Hyperborean Wisdom assures us that, until the arrival of the material Universe of the Bringer Siddhas, the process of ALL the universal archetypes developed according to the same LAW, contained in the CARACOL DESIGN.

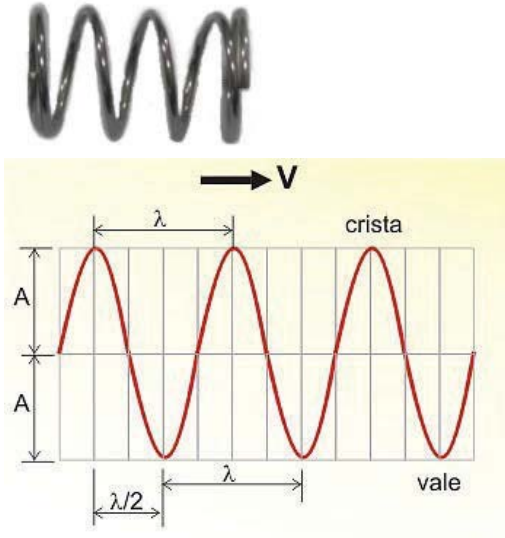
(...)

"The fact that a logarithmic spiral was drawn there is of no particular significance since any other remarkable spiral, some of which are represented in Figure 42, or a 'natural' spiral, similar to that of the 'nautilus' snail of the secondary era, whose development is based on the Fibonacci series, could have been used for the same purpose.

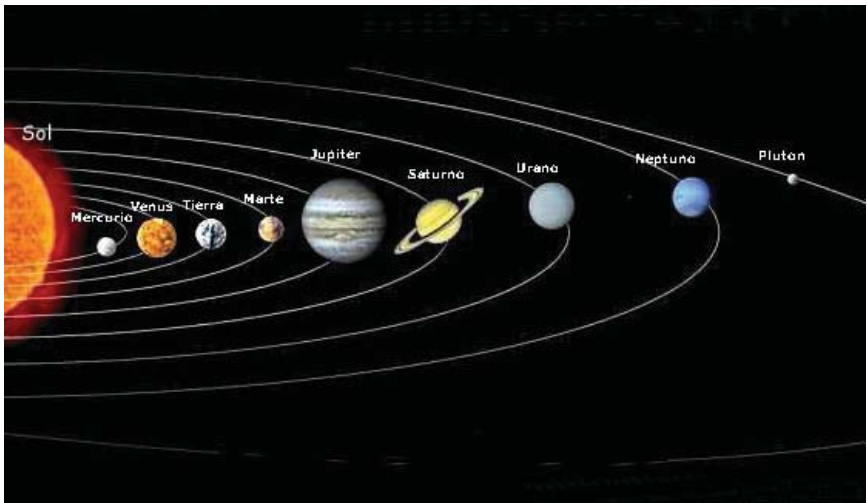
(...)

Leaving aside, then, which type of spiral would be the most appropriate to represent the process of Archetype XX, what is important here is to agree on the essential fact that the process develops according to a spiral movement.

And when we think like that, then the frequency of the wave, its amplitude and its compliance are results of the angular *momentum*, of the rotation. What happens with the current physics is really a dimensional problem, because what they have, the sinusoidal waves, are nothing more than the lateral vision, in 2D, of a 3D spiral, as we can see in this photo of a mola.

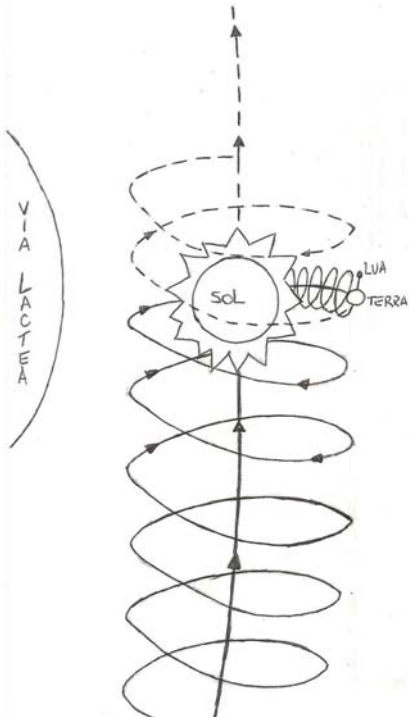


The mola, which is a spiral, has its 2D vision as a sinusoidal wave. Well, still within the theme of the snail design and the spiral dynamics of the universe, let us now observe our solar system. It was taught to us in the school, and even today so the children teach, that the planets rotate around the sun in an elliptical orbit and that every year they complete their turn, returning to the initial point of a year ago.



Again the same error of amputating a certain fraction of the phenomenon of the whole. They are closed, isolated systems, disturbing us again. This has nothing to do with the dynamics of our solar system. Because the sun is also moving at a speed of 200 km per second, and the planets are following it. The plotted,

then, of the orbits of the planets will be a vortex, a spiral. In truth, in the drawing above, the sun moves upward and so each path of the planets will be a spiral, not an ellipse. Again we remain in the snail design.



After one year, the Earth will actually be millions and millions of kilometers away from where I was one year ago. If we were to stay in the same place, then we would go live that same year again, and not in the next. Because, different from what most people think, time travel consists not only in moving through time, but also in moving through space. We are to move through the geometry of space-time, and not just time. For example, if the earth were to make its translation as we initially learn in school, and on January 01, 2001 it were in the exact coordinate of space where it was on January 01, 2000, then we would all live the year 2000 again; we would never live the year 2001.

Let's continue to analyze the event. Once we understand the principle of the spiral movement of the earth around the sun, we perceive then that the moon spiral around the earth; in a bigger spiral, the earth around the sun; in a bigger spiral, the sun around the center of the Milky Way; and so on until infinity. This helps us to perceive with fractal geometry is something very good to know.

At this point we come to an important question: if the universe is a fractal of infinite rotation, that is, the divine proportion applied to the snail design, how can we determine the center of the universe? Answer: each point is the center. Each point is the center of the universe, if we observe the universe from that point. This is the

stationary point. Because at this point, all rotations of the universe are canceled. For each rotation you encounter, there will be in the universe a counter-rotation, that is, an equal and opposite rotation. All these rotations are cancelled at this point by creating immobility. Immobility is necessary to create a reference point for the rotation. For example, we look at a tornado:



What is at the center of this rotational movement? Stillness, immobility. The eye of the tornado. Well, if we look for a galaxy...



... we shall see that the dynamic is the same. From the infinitely small to the infinitely large, the whole non-universe of the One follows this dynamic. Thus occurs the singularity of the pasu. The singularity is the central point of the pasu's experience in the universe. It is from the immobile point that he observes the universe. And thus the Demiurge contemplates himself billions of times through the eyes of the pasu, and each of these times will be a singular experience. This is the level of his dementia. Let's see the explanation given by the Führer to the young Kurt von Süberman, in "The Mystery of Belicena Villca":

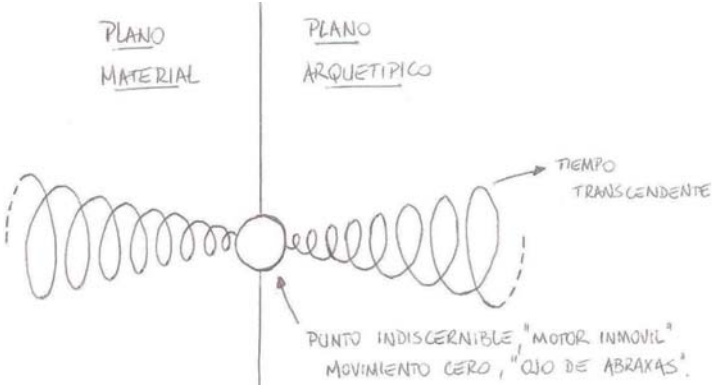
"But the Cosmic Plan, one must somehow call the IDEA OF THE MATERIAL UNIVERSE, is seated in the DREAM of the Demiurge, a state of stillness which nevertheless energizes the cosmos, like Aristotle's 'immobile motor God' in that Great Day of Manifestation which is also called, great manvantara."

In this way, the One centers all his work on the singularity of the abraxás eye, the indiscernible point. It is the central point, the point where all rotations are cancelled and

immobility occurs. And all that is outside this center is the irradiated part which the

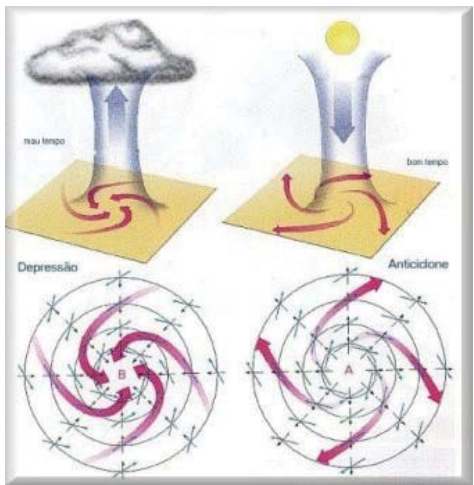
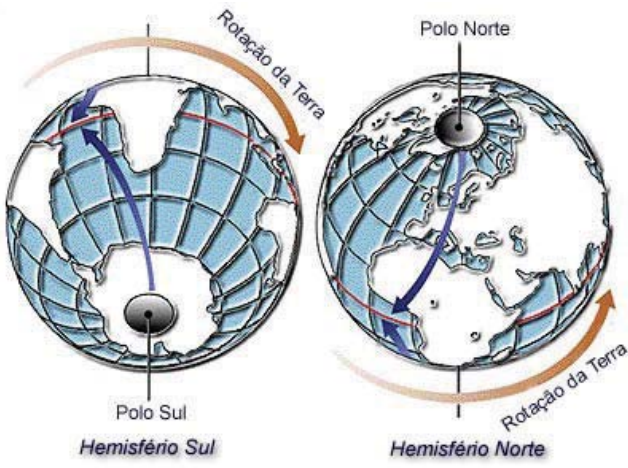
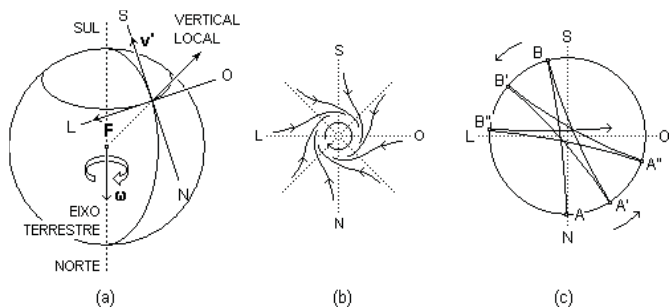
pasu observes as being the universe. Because what is out of orbit, is under the snail design, which the pasu has the capacity to recognize.

We can now understand, in terms of Physics, what the Technique of Strategic Opposition used by the Einherjar and the Tyrodal Knights consists of. It all consists in transforming the area enclosed by the archemone into this immobile point, taking it out of the continuous flow of Time. Once out of time and space, the Tirodal Knight can look at the instant of the origin of the imprisonment. And that is why Moyano affirms that the confrontation with the One is inevitable: because the non-point of zero movement, where there is no flow of Time, is the Eye of Abraxas, the One. As shown in the allegorical drawing below:

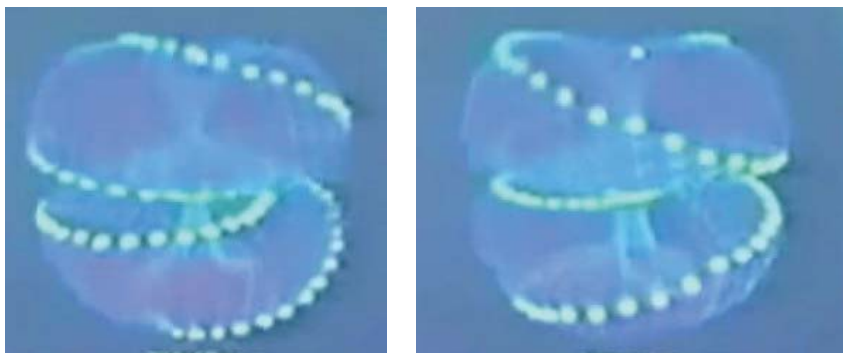


But, returning to the subject, the system is such that there will always be a major center, a major bureaucratic-black, a major indiscernible point, which generates a consensus of observation among all independent systems of that order. For example, all the cells of your body agree to be you. To try to better understand this issue, let's analyze the case of the pasu. The pasu has the supra-purpose of producing culture. For this to happen, there must be a series of concepts common to all. Without this, their individual experiences can be so differentiated that they make the production of culture impossible. And what is the reference of the Pasús? What generates consensus among the pasu community? Answer: or buraco-black, to singularity gives land, in the same way that its singularity generates consensus among the cells of your body. To explain better, imagine the spherical surface of the earth and the pasús on it. Your heads point in divergent directions, towards space; but your feet point in a convergent direction, they point to the indiscernible point of the earth. Precisely their chakras are responsible for all that is instinctive (study Gustavo Brondino's Treatise of the Hyperborean Gnose and Hyperborean Yoga), of animal programming, they point to the center, to the singularity of the planet. This is one of the reasons why Moyano warns us that Jesus or Metatron is now in the center of the earth, radiating his archetypal energies to all the pasús through his vertebral columns.

Further on, in our study of fractals and the dynamics of the universe, we have here some images of these dynamics, known in physics as the Coriolis Effect, which should help in the understanding of this subject.



Below are some images to help you understand, for example, the movement of energy between the north and south poles of the planet:



We must emphasize some points that we have not analyzed so far. Let's recall some concepts of the FSH, about time and space:

"The 'transcendent time,' as we agreed in Part One, is 'transcendent' to the microcosm, but, in truth, it is an immanent fluence of Cosmic Consciousness, of the Soul of the Demiurge. And that Consciousness has produced the Archetypes whose processes concern us. From there, then, from Time, the transcendent time, everything real starts; but it is no longer a mere dimension as Physics pretends, but the essential support of all that exists, only after Time, a posteriori of transcendent time, 'space appears' as the effect of the archetypal processes that develop in the planes of matter and energy. Simplifying greatly the theory of Hyperborean Physics, it can be concluded here that space is a 'second degree' of transcendent time or else a gross state of Time, an inferior temporal category, a kind of 'fallen time', etc. (...) Observing the extremes of the process, it is evident that space is CAUSED by transcendent time through matter organized by the gravis".

And yet:

"What is to be expected, then, from the 'center of gravity,' according to the Hyperborean Wisdom: an indiscernible point, that is to say, a point that contradicts Leibniz's principium identitatis indiscernibilium. This is so because the entelechy, as the final perfection of the Archetype, is the Archetype itself: FROM THE ENTELEQUIA, THE GRAVIS PROMOTES A PROCESS THAT CANNOT BE INTERRUPTED AND THAT GOES FROM THE POWER (gravitational field) TO THE ENTELEQUIA (center of gravity) WHICH IS IN THE FUTURE; SUCH A PROCESSUAL WAY OPENS A GAP IN SPACE, "DISTORTING" IT, PRODUCING A TOPOLOGICAL CONTACT BETWEEN DIFFERENT PLANS. At rigor of truth what happens in the 'indiscernible point' is that the entelechy 'regenerates' a point of space by transforming it into time; it 'elevates' it if you will."

But how does this regeneration occur, this transmutation of space into time? Or even the transformation of gravity into electromagnetism?

The answer is: by the dynamics called Coriolis Effect. This is the energetic dynamics of the universe created from the One, including the dynamics of the black buracos. By this dynamic, space is regenerated into time, electromagnetism into gravity, the process of entelechy into its final perfection, etc.

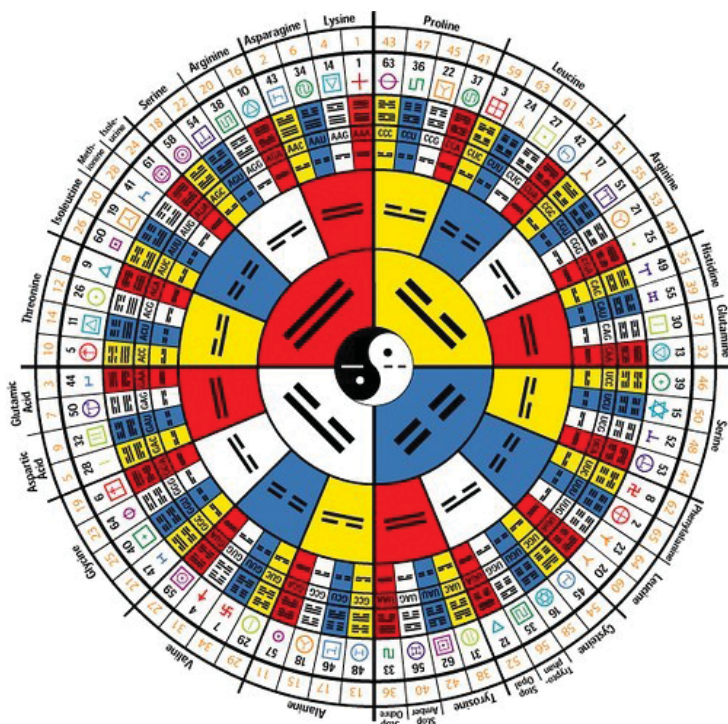
Now let's take a look at the top view of the same event.



Pray, we have a Tai-Chi (Yin+Yang).

That is why Buddhists show a vortex entering through the crown chakra, the Sahashara Chakra, another entering through the spinal root chakra, the Muladhara Chakra, meeting in the middle of the heart chakra, the Anahata Chakra, reproducing this same dynamic. And the symbol of this cardiac chakra is just a six-pointed star inside a circle. Because that is the dynamic of the whole universe of the One, including the soul of the pasu. There is a physical place inside the human heart that contains the eye of abraxás, the indiscernible point, the singularity. This small cavity between two ventricles has the largest electromagnetic field of the human body, which can be measured at a distance of 2.5 meters. This is the battery of life. When the pasu dies, this singularity is no longer present, and curiously the human body loses 21g when it dies, and nobody, no doctor can explain why. But we know. Those 21g are the result of the black hole, of the indiscernible point, bending the space-time, creating a gravitational effect that we call weight.

Yes, many Eastern cultures have this knowledge in their roots. For example, if we analyze the I-Ching:



From the center to the edge, first we have the Tai-Chi, representing the opposite, symmetrical and complementary forces that manage the creation. Then we have the 4 elements, representing the way of this eternal energetic return: the positive, the null, the negative, the summer, the autumn, the winter, the spring; the inspiration, the pause, the expiration, the pause; etc. We have then 8 groups, in analogy to the 8 tetrahedra that form the nucleus of the equilibrium of the geometrical structure of the collapse of the void. In sequence we have a group composed of 64 elements, representing the 64 tetrahedra of the geometry of the void.

And after that there are no more divisions, that is, the symbol is totally faithful to the structure of the geometric form of the collapse of the void, of the first monad. We also perceive in this symbol that everything radiates in a fractal form from the center to the edges, in the spherical form of the expansion of the universe. Of course, as it happened with almost everything, this original knowledge was already disrupted by the Sinarchy, and today's I Ching has little of its original wisdom. Note that in it we have symbols such as the Swastika Rune, the Tir Rune, the Kenaz Rune in its two concepts (fire of life and fire of death), the Elhaz Rune, the Star of Zion, and much more... Suffice it to remind you that the Runes given to Wothan come from the Symbol of Origin in the Kalachakra Key, which in turn was the instrument used by The One in the construction of his work, and given to the Traitor Siddhas on the occasion of their demonic pact, to rule reality. This symbol contained, in its beginning and among other knowledge, the explanation of some of the elements of the Kalachakra Key and their respective areas of action within the universe. The Hyperborean Initiate, Tirodal Knight, can with the power of his Will, armed with the Eternal Runes and with the Noological science of the Hyperborean Yoga, doing

to use his faculty of anamnesia, to access the knowledge of these mysteries, to reach the comprehension of the Path of Pain, of the Serpent, with the Sign of the Origin, and to be free in the Origin! And to understand the Serpent with the Sign of the Origin is to go down the spiral, resigning the 49 plus 1 bijas of the Demirugo, its Sign of Pain, with the Runes and to reach the indiscernible point, the Eye of Abraxas which is at the beginning of the vortex. And then there will be the inevitable confrontation of the Hyperborean Initiate, of the Tyrodal Knight, with the One, for the liberation of the Spirit. As Moyano tells us in the FSH:

"To all these quotations we must add the following: And IN THAT INEVITABLE CLASH, IN WHICH THE HYPERBOREAL WARRIOR AND THE DEMIURGE WILL FIGHT FACE TO FACE, THE MOST DIFFICULT TEST THE WARRIOR WILL HAVE TO FACE WILL BE THE CONTEMPLATION OF THE TERRIBLE DEMIURGE'S FEATHER. Of course, the

Demiurge is an Actor with many Masks, but here we refer to ONE OF HIS ASPECTS: that which can be perceived in the being-in-itself of the entities, that is, in the entrails of ALL the entities of the world, which he sustains and vitalizes from the entelechy gravis; that Aspect that the Hyperborean Wisdom calls DRAGON OF THE WORLD (DRACONIS MUNDI) and the Hebrew Kabbalah METATRON."

THE VIRYA AND THE PERSONAL LIBERATION STRATEGY

Based on the knowledge of the Hyperborean Wisdom, can and should the awakened virya, Hyperborean Initiate, Tyrodal Knight, draw his personal strategy of spiritual liberation and also, more specifically by Hyperborean Physics, manipulate the created universe of the One in his favor, in favor of his strategy and the strategy of the Loyal Siddhas of Agartha. As the Warlords that they are, they can build weapons with this technology, "magical weapons" like those of King Nimrod and his General Ninurta, or like the flying saucers of the SS, or even like the Magic Sword Excalibur. Weapons capable of doing damage to the treacherous siddhas of Chan Shambhala, which the normal weapons of our days cannot do. And the time is near when the Wildes Herr of Wothan will fight the Final Battle against The One and the Traitor Syddhas. But that is another matter.

What interests us now is to make an analysis of the battle of liberation of the virya based on the concepts studied so far in this text. We have seen that the Universe of the one has its constitution based on two planes: one expanded, the material, and the other contracted, the archetypal. But Nimrod explains to us in the FSH that the microcosm is a faithful copy of the macrocosm. What conclusion can be drawn from this? Answer: **that the microcosm also has its expanded part and its contracted part.** And to what does each of these parts correspond in the microcosm of the virya? Answer: **the expanded, material part is his body; and the contracted, astral part is his soul.** That is why, then, the soul cannot be seen, just as the archetypal plane cannot be seen. In the soul are engraved the designs of the microcosm, and the connection with the body is given by the chakras, the energy vortexes. The vital energy flows from the soul, animating the body, and this is also the knowledge of the ancient oriental science: from this comes, for example, the medicine of acupuncture, which recovers health by correcting the flow of vital energy of the soul in the microcosm, since, as we know, the contracted part or soul is the one that creates, the cause, and the expanded part or body in such a way that the soul is

the one that creates, the cause, and the expanded part or body in such a way that the soul is the one that creates, the cause, and the body in such a way that the soul is the one that creates, the cause, and the body in such a way that the soul is the cause.

only the consequence. And our western medicine, just like our physics, works only in the expanded part...

Now we can draw from this point another important conclusion: **the strategy of liberation of the Virya must not only take place in his psychology: it must also take place in his body!**

Let's see what Nimrod tells us in the FSH on the subject:

"We said at the beginning that 'thinking' can take place in any sphere of the psychic structure; the concept of thinking SUBJECT will allow us to understand more precisely this faculty of the soul. First of all, we must pay attention to the following principle: EVERY SUBJECT REQUIRES A STRUCTURE IN WHICH TO MANIFEST ITSELF. That is to say, THERE CANNOT EXIST THE

SUBJECT WITHOUT A VEHICLE FOR ITS MANIFESTATION; what always exists, even after the death of the pasu, is the transmigrating soul, but NOT THE SUBJECT which is only one aspect of the soul characteristic of the state of incarnation: AN OBJECT OF THE PASU'S PURPOSE. In synthesis: THE SUBJECT IS A FUNCTION OF THE STRUCTURE".

If we remember what Nimrod tells us in "The Mystery of Belicena Villca" about the Blood and Cultural Pacts, we have that the Blood Pact was very austere, of little comfort and warrior; and on the contrary, the Cultural Pact would have the degradation of man by comfort, making him weaker and weaker. And, looking at the "evolution" of man until today, what will we have? What is the work of the Synarchy?

And for the avoidance of doubt, let us look at what our Führer teaches us in his work "My Struggle" (Meine Kampf):

"The State must direct the education of the people not only in an intellectual sense, but also aiming at the formation of healthy bodies (...).

The State must act on the presumption that a man of modest education, but physically healthy, of firm character, with confidence in himself and in his willpower, is more useful to the community than a weak individual, who is highly educated.

A people of wise men, physically degenerated, become weak-willed and transformed into a body of cowardly pacifists who will never rise to great deeds and will never be able to ensure their existence on earth. What made the ideal of Greek beauty imperishable was the harmony between physical, spiritual and moral beauty".

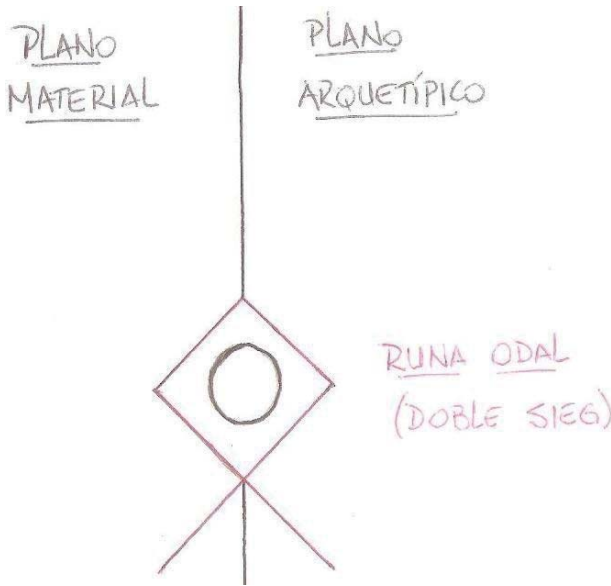
Thus, the struggle in the microcosm consists not only in a psychic struggle, but also in a bodily struggle. The Virya must become Emperor, become master of his microcosm, causing his body and soul (or psyche) to change into an expression of the Eternal Hyperborean Warrior Spirit. His microcosm must reflect his Spirit, changing into a formidable war machine; he must become a Warlord in every sense!

Thus we can now understand one of the seven ways of liberation granted to us by the Loyal Siddhas of Agartha: the Way of War, and its expression through the Martial Arts. The Martial Arts are the Arts of War, which transform the microcosm of the Virya, strengthening his body, mind and Spirit, by the power of his Will. It is the force of the Eternal Spirit dominating the body and soul of the Virya.



Symbol of some of the most traditional Japanese martial arts, also symbol of Odin in Europe.

We can now also understand how the isolation of the Self is given by the Siddhas of Agartha and by the grace of the Will of the Virya. The Rune ODAL, applied by the Siddhas, is constituted by a Double Rune Sieg, thus isolating the microcosm of the Virya on the material plane and on the archetypal plane, in the expanded and in the contracted, as the allegorical drawing below:



Now, if we remember that everything in the universe of the One is connected, and that the microcosm and the macrocosm are also connected, what conclusion can we draw from that? Answer: **what happens in the microcosm reflects in the macrocosm, and what happens in the macrocosm reflects in the microcosm.** So, the personal microcosmic strategy of liberation of the Virya reflects in the macrocosm, and the collective macrocosmic strategy of a circle of Viryas reflects in the personal microcosm of the Virya. This thesis is confirmed by Gustavo Brondino in his book "Runic Warrior Martial Yoga":

"Pontonics instructs the virya in the archemonic techniques to simultaneously execute a double inner and outer noological construction; construction of an Opidium.

interior and an exterior Plaza or Castrum, an interior archemonic center and an exterior isolated plaza."

And what other conclusion can we draw from these concepts? Answer: that as important as the inner work is the outer work of the Virya, that is, the Virya must wage his battle against the demons of the One and of the White Brotherhood in the inner and outer labyrinth; or even: **the microcosmic actions of war must be associated with macrocosmic actions of war, and the macrocosmic actions of war must be associated with microcosmic actions of war.**

THE WILL OF THE VIRYA MUST BE CONVERTED INTO COURAGE, INTO ACTION OF WAR, MICROCOSMIC AND MACROCOSMIC!

FORWARD, COMRADES! SOON THE TIME WILL COME FOR OUR REVENGE, TO TAKE THE CURSED CITY OF SHAMBHALA, DESTROY IT AND RETURN TO THE ORIGIN!

"VICTORY or defeat is in the hands of the Gods, The HONOR of combat is ours." - Ariana Wisdom Saying

Lobo Fenrir
OCTIRODAE BRAZIL

HONOR ET MORTIS!
WILL, COURAGE, VICTORY!

Wave and Quantum Mechanics

MECANICA ONDULATORIA Y CUANTICA

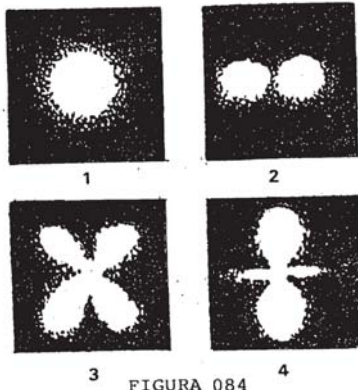


FIGURA 084

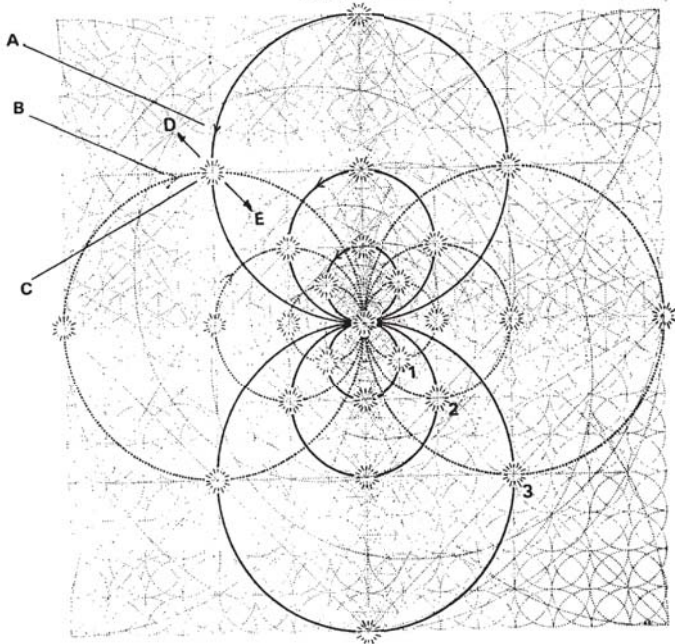


FIGURA 085

054 - IT IS NECESSARY THAT WE PAY MUCH ATTENTION TO WHAT WE ARE GOING TO STUDY FROM FIGURE 084 AND 085; SINCE IT WILL BE IMPORTANT FOR WHAT WE WILL DEVELOP IN THE FOLLOWING.

LET US NOW LOOK BRIEFLY AT THE HISTORY CONCERNING WAVE AND QUANTUM MECHANICS.

TWO THOUSAND FIVE HUNDRED YEARS AGO, LEUCIPPUS PHILOSOPHIZED ABOUT THE INDIVISIBLE PART OF MATTER, WHEN IT REACHED ITS MINIMUM EXPRESSION.

HE TAUGHT HIS STUDENTS, AMONG WHOM WAS DEMOCRITUS, THAT IF AN OBJECT WAS SECTIONED, IT WOULD REACH A POINT **WHERE** IT COULD NO LONGER BE DIVIDED, SO THAT IT WAS INDIVISIBLE, AND HE CALLED IT AN ATOM*, BUT EPICURUS JOINED IN THE SPREAD OF THIS PRINCIPLE.

THE PHILOSOPHY OF THAT TIME LACKED THE TOOLS TO AFFIRM THE IDEAS WITH THE NECESSARY FOUNDATIONS, AND THE STATEMENTS WERE DISSEMINATED BY VIRTUE OF THE KNOWLEDGE AND CHARISMA OF THEIR ISSUER, WHICH GAVE THE SERIOUSNESS OF THE SPECIES DISSEMINATED.

PYTHAGORAS, MEANWHILE, TAUGHT THAT THE HEAVENLY BODIES DEPEND IN THEIR ARRANGEMENT ON INTERVALS REGULATED BY A MUSICAL HARMONY; BY THIS PRINCIPLE HE SAID THAT THE ARRANGEMENT MADE THE UNIVERSE INTO A COSMOS - AN ORDER - DEFINING THAT ORDER AS THE HARMONY OF THE SPHERES (ether, Aristotle's quintessence ref. 059 = fire, 062 = air, 067 = water, 071 = earth, 076 = concreteness of principles)

THIS PRINCIPLE IS NOT PRECISELY ANNOYING, BUT LET US NOT ENTER AT THIS POINT INTO ANALYZING IT, LET US SIMPLY SAY THAT BY THAT TIME THE THREE HYPOSTATIC PRINCIPLES* (sulphur, salt, mercury) THEN BELIEVING THEM TO BE THE ELEMENTS WHICH PARTIED FROM EVERY MUTATION, THEN THE CONCEPT OF UNITY OR HOLY TRINITY (Empedocles) WAS ASSIGNED TO THEM LATER.

MUCH LATER, WILLAM CROOKES, WORKING ON A HITTORF EXPERIMENT, THREW AN ELECTRIC SHOCK INTO A GLASS TUBE CONTAINING GAS.

ÛN LL TUUO O5SEHVEVED THAT FROM THE CATHODE*, RAYS EMANATED WHEN THEY REACHED THE OPPOSITE ZONE, THEY TURNED IT r&uorescent*, GIVING IT THE NAME OF RADIANT E*.

THOMPSON EXPERIMENTED WITH THE CROOKES TUBE, REFLECTING ON WHAT CATHODE RADIATION CONSISTED OF; WHETHER IT WAS **CONSTITUTED AS WAVES - LIGHT - OR AS CORPUSCLES**; HE WAS ABLE TO **DEMONSTRATE THAT THE LATTER HYPOTHESIS WAS THE VALID ONE.**

MERRIN WAS ABLE TO ESTABLISH THAT CATHODE IRRADIATION CONSISTED OF PARTICLES SMALLER THAN ATOMS, THAT IS TO SAY THAT IT WAS NOT WHAT WAS KNOWN AS MATTER, OR ITS SMALLEST EXPRESSION, BUT OF NEGATIVE ELECTRICITY; IN THIS WAY HE CAME TO THE CONCLUSION THAT THE ATOM OF LEUCIPPUS WAS IN TURN CONSTITUTED BY OTHER SUBATOMIC PARTICLES.

THIS CONCEPT DISTORTED MAXWELL'S PRINCIPLE, ELECTRICITY WAS NO LONGER A FLUID, BUT A CASCADE OF MICRO-PARTICLES TO THE THESE ARE CALLED ELECTRONS* (ref. 085, 1, 2, 3 seen two-dimensionally, in three-dimensional form, they would be microsystems accompanied by a minimum of three axes, those we see and those formed by the X-axis fields present in every unit of energy).

OF ITS LATER, IT WAS SHOWN THAT THE **ELECTRON*** IS MEASUREMENT EIGHTEEN HUNDRED AND THIRTY-SIX TIMES WEAKER THAN POSSESSES A HYDROGEN. MASS THAT THE ATOM OF THE

RUTHERFORD, CONTINUING WITH THE PRINCIPLE OF THE PRIMORDIAL SCHOOLS*, WHAT IS ABOVE IS BELOW - THAT THE UNIVERSE SO IS THE IONIZATION UNFOLDING OF WHAT A MICRO SYSTEM MEANS, THUS OFFERS US THE HYPOTHESIS OF A PLANETARY ATOM, CONSTITUTED BY NEGATIVE PARTICLES IN SUCH QUANTITY, THAT THEY ESTABLISH EQUILIBRIUM WITH THE NUCLEUS OF THE ATOM - POSITIVELY ELECTRIFIED - FROM WHICH RESULTS A NEUTRAL WHOLE.

ALTHOUGH IT IS TRUE THAT RUTHERFORD'S PRINCIPLE WAS CORRECT IN ITS PHILOSOPHICAL EMANATION FROM THE PRIMORDIAL SCHOOLS, HIS ATOM WAS MECHANICALLY DIFFICULT TO SUBSTANTIATE; BOHR SAID THAT THE ANALOGY OF THE ATOM WITH THE PLANETARY SYSTEM WAS MORE APPARENT THAN REAL, SINCE A PLANET REMAINED SUBJECT TO ITS ORBIT, WHILE ELECTRONS* VARY THEIR ORBITALS.

IF WE TAKE A TUBE CONTAINING HYDROGEN AT LOW PRESSURE, AND WE LAUNCH AN ELECTRIC DISCHARGE INSIDE IT, IT HAPPENS THAT THE ELECTRON* CAN LEAVE ITS ORBIT AND TRANSIT IN A MORE DISTANT ORBIT TO RETURN LATER TO ITS NATURAL ENERGY/ORBITAL* LEVEL; WHEN DESCENDING, THE ELECTRON* DISCHARGES THE ENERGY ACCUMULATED WHEN BEING EXPELLED, EMITTING A RADIATION THAT IS CALLED - ENERGY QUANTUM -.

WE SEE THIS DEMONSTRATION CONSTANTLY IN ADVERTISING LIGHTS, IN WHICH WE CAN OBSERVE A STRIKING RED LIGHT EMITTED BY THIS PRINCIPLE.

THIS IS THE REASON FOR PLANCK'S QUANTA THEORY, OR THE PHOTON* SO NAMED BY EINSTEIN.

WHEN WE EXPLAIN THE ATOM, WE ARE USED TO THINK OF A BALL WITH DIFFERENT LAYERS OR LEVELS OF ENERGY/ORBITALS*; BUT IF WE WANT TO KNOW IN WHICH LEVEL IS THE ELECTRON* THAT WE WANT TO IDENTIFY, WE MUST RECOGNIZE THAT WE DO NOT KNOW IT, NEVERTHELESS QUANTUM MECHANICS IS BASED ON THE STUDY OF THE ATOMIC STRUCTURE, IN FUNCTION OF QUANTITIES THAT CAN BE MEASURED IN PRACTICE; IN ONDULATORY MECHANICS - DE BROGLIE 1923 - ATTRIBUTES ONDULATORY CHARACTERISTICS TO THE COMPONENTS OF THE ATOMIC BUILDING, PRETENDING TO INTERPRET THE PHYSICAL PHENOMENA. IN THE FUNCTION OF WAVE FORMS - SCHROEDINGER 1926 -

STATISTICAL MECHANICS OR THE LAW OF THE INFINITELY SMALL, BASED ON THE REPLACEMENT OF THE CLASSICAL MECHANICS OF NEWTON AND LAPLACE, CLARIFIES THE APPROACH, SINCE THE MOTION OF THE ELECTRON* IS KNOWN WHEN THE CURVE THAT SYMBOLIZES IT IS AVAILABLE, AND IN THIS WAY THE PHENOMENA IN WHICH SUCH MOTIONS PARTICIPATE CAN BE STUDIED.

MECHANICS IS BASED ON THE PLANCK QUANTA, AND THE PRINCIPLE OF PARTICLE ASSOCIATIONS TO PROBABILITY CURVES OR BROGLIAN WAVES.

FERMI - DIRAC, LAY THE FOUNDATIONS OF QUANTUM STATISTICS ONLY A WHICH EXPRESSES GIVEN NUMBER OF PARTICLES IDENTIFY A GIVEN THAT IT CAN QUANTUM STATE. OCCUPY A

055 - LET US NOW RETURN TO OUR FIGURE 084, WHERE WE CAN OBSERVE THE HYDROGEN ATOM IN FOUR DILERLENT STATES OF EXCITATION; IN FIGURE 085 - BIDIMLNSIONAI* - WE CAN OSERVE THE NUCLEUS OF AN ENERGY UNIT* INSERTED IN THE UNIVERSAL SCHEME*.

IN IT WE SEE (ref. 084-3, 085 nucleus) clearly the disposition that the particles have adopted in their nucleus, so that we can better analyze what happens in the areas where two arcs* cross at one level of energy/ORBITAL*; IN THIS CASE CORRESPONDING TO THE V-1, IN WHICH THE Ando* - A - IS cnUXED WITH THE - B - FAVORING THE CREATION OF A SUB ATOMIC PARTICLE WITH ITS CORRESPONDING CHARGE - WE ESTIMATE THAT IT IS LESS POSITIVE AND CORRESPONDING TO THE ELECTRON*.

IF THERE WERE A FACTOR THAT ALTERED THESE WAVES IN THE MAGNITUDE OF THEIR ARC* - ELECTROMAGNETIC FIELD* - THEN THE LENTICULARS* OF BOTH - OF NEUTRAL OR PLASMATIC CHARACTER BY SUPERPOSING TWO POLAR FIELDS* OF DIFFERENT SIGN - WOULD ATTERRATE, DIVERGENTLY* UPWARD* (ref. 085- D). D) 0 CONVERGENTLY* TOWARD THE CORE (ref.085-E).

LET US SUPPOSE NOW THAT ANY EXCITEMENT THAT MAY OCCUR DUE TO THE EFFECT OF INCREASED TENSION, OR LOW TENSION, ALTERATIONS OF THERMAL ORIGIN, ETC., WILL DISTURB THE EMOTIONAL FIELD* LOCATED IN THE AREA. WILL PERTURB THE EMOTIONAL FIELD* LOCATED IN THE ZONE.

IN THIS SUPPOSITION WE FIND THAT IN THE INTIMACY OF THE ENERGY UNIT*, WE POSSESS A MECHANICS ENGENDED BY THE PRINCIPLE OF ATTRACTION AND REJECTION OF CHARGES OF DIFERENT AND EQUAL SIGN, WHICH IN THE NUCLEUS IS TRANSLATED AS A LINKING SYSTEM (ref.010,011,031 ,032) OR FO#RZA DM GRAVITY*.

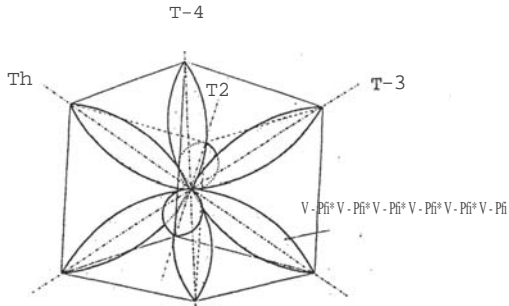


FIGURE 086

06 - THEN (ref.034, 035, 036, 041) ON SLIGHT INTERACTION IN THE NUCLEUS THEY SLIGHTLY OVERLAP EACH OTHER FORMING VERDA-RIGHT EMOTIONAL CHIMNEYS - PLASMA nto* - v-Pr*

IN THE SAME FIGURE, WE OSERVED THE TRIGONALS* T1, T2, T3, í T4, WHERE THE SUPERPOSITION OF POLAR FIELDS* HAS ENGENDERED PLASMATIC ZONES* WHEN THE ELECTRIC CHARGES OVERCONTROLLED

PAHA ENTHAR IN nFPoso, THIS IN THIS ZONE, IN THIS ZONE, IS NOT REGISTERED.
ELECTRICAL* AND MAGNETIC* ACTIVITY.

FIELD SUPERPOSITION ENGENDERING
COLD PLASMA - v-Pr* -

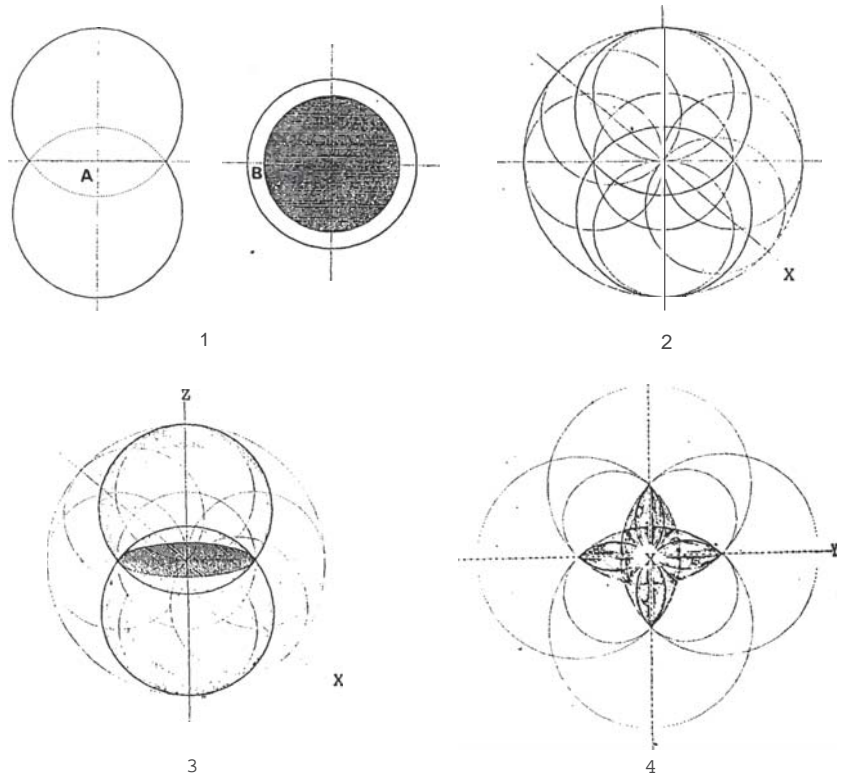


FIGURE 087

0 7 - IN THE FIGURE 087-1, WE CAN OBSERVE A SUPERPOSITION OF POLAR FIELDS*. IN WHICH THE POLARITY HAS CONVERGENTLY* EXCEEDED ITS ORBITAL PONUERABLE* ORBITAL.

WHEN THE SUPERPOSITION OF POLAR FIELDS* OCCURS, (ref.087-1, A) A PLANE OF SYMMETRY IS GENERATED (ref.087-1, B), ALTERING THE NORMAL OPERATION OF THE ENERGY UNIT* (distension), AS WE CAN OBSERVE IN FIGURE 087-2, WHICH IS EVEN BETTER CLARIFIED IN FIGURE 087-3, AND SCHEMATIZED BIDimensionALLY* IN FIGURE 087-4, CONFOENANDQ IN A SPACE FIGURE,
 rco AS WELL AS LENTEJAS SUPEEPUESTED TO EACH OTHER.

IN THAT 3ZONE OF COLD PLASMA - v-Pr* - WHERE EMOTION AND LOADS znrcT "icens an ENTEADO EN nLPosO. IS WHERE uANzrIzsiA &A MAJOR EVIDENCE OF EMOTION, PROJECTING ITSELF TO INFINITY IN GEOMETRIC PROCESSION*, EXERCISING IMPORTANT FUNCTIONS IN THE ATOMIC EFFECT AND IN THE MUTATION OF SPECIES, AND THE VARIATIONS SUFFERED BY PLANK'S QUANTUMS* OR EINSTEIN'S PHOTONS, OR THE ELECTRON* - 8 - AND ITS INTELLIGENT PARTICIPATION IN OTHER STATES THAT MATTER ACQUIRES, TURNING THE MICE PARTICLE INTO THE Macno PARTICLE (ref.005,1,2,3 - 088,1,2,3 - 08c V-Pr*)

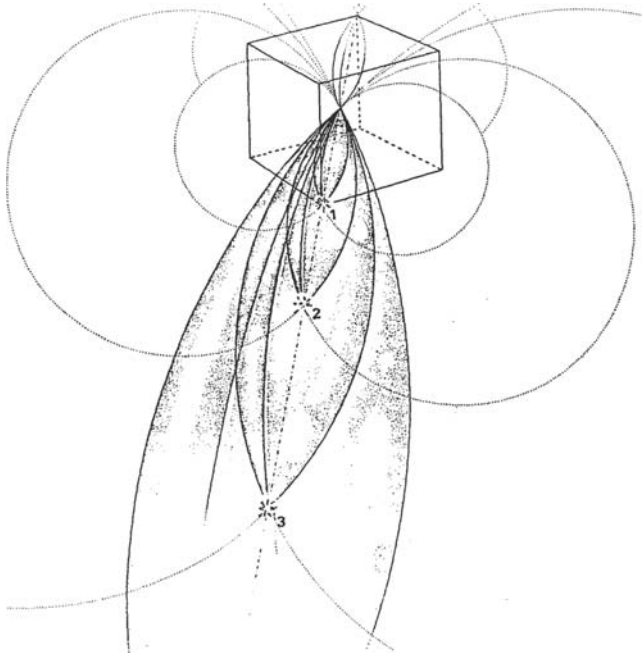


FIGURE 088

058 - FIGURE 088, COMPLEMENTARY TO FIGURE 085, SHOWS THE EXPANSION OF EMOTION* FROM THE CONCRETION OF A TEMPUBAL SYSTEM*.

THE INFORMATION THAT ARISES FROM THE INTERACTION OF ELECTRIC CHARGES OF DIFFERENT SIGNS IS TRANSMITTED TO THE UNIVERSE KNOWN THROUGH THE GAMMA RAYS*, IN THIS WAY THE TEMPORAL SYSTEM*, CONFORMED BY EMOTIONAL WILL, PARTICIPATES IN ALL THE TEMPORAL STATES THAT COMPOSE THE THREE-DIMENSIONAL MATTER*.

LET US NOW CONTINUE OCCUPYING WITH THE SCHEME SHOWN IN FIGURE 085, WHERE WE SEE h - THE SENTIDO o Gino Pola8* FIELD, INCUHLUNG TOWARDS THE NUCLEUS OF THE SYSTEM - ONDULATORY MECHANICS*.
- WITH ITS CORRESPONDING CHARGE; CROSSING AT A POINT WITH THE EQUATORIAL FIELD* - B - WHICH FOLLOWS A REVERSE DIRECTION OF ROTATION,

WHEN INTERFERING WITH EACH OTHER, THE EQUATORIAL FIELD - B - SUPPORTS PART OF ITS OWN CARGO, AND THE POLAH* FIELD - A - ALSO SUPPORTS ITS OWN (ref. 012, 013, 014) ADDING THE SUSTAINING FIELD - X

IN THIS ZONE IS WHERE A QUANTUM* WITH ITS OWN CHARACTERISTICS IS GENERATED, APART FROM THE SYSTEM OF WHICH IT IS A PART.

THUS AN APPARENTLY INDEPENDENT SYSTEM IS FORMED, BUT EXISTING IN FUNCTION OF THE OWN DYNAMICS OF THE NUCLEUS OF THE SYSTEM OF WHICH IT IS A PART. THIS SYSTEM OR PHOTON*, PRODUCING ITS OWN RADIAL EMISSION, HAS A DIRECTION OF ROTATION - ANGULAR VELOCITY - INFLUENCED BY THE EMOTIONAL FIELD* OF THE TEMPORAL SYSTEM*.

THE ELECTRON* CONFORMED BY A TEMPORARY SYSTEM*, CONTINUES IN ITSELF SUSTAINED BY THE INTERACTION OF THE NUCLEUS - FORCE OF GRAVITY* - AS LONG AS IT SUSTAINS, ACCORDING TO THE MEMORY OF ITS FGRMA, INFLUENCING IN THE TEMPORARY SYSTEM* PONDENABLE* (ref.V-1, V-2, V-3, 008) AND OUTSIDE THE LEVEL PONDERING INTEHVI- NIENDO IN THIS CASE, THE LEVEL OF CONSCIOUSNESS, AND THE PHOPIO DESIRE.

WHEN THE EMOTION* OF THE 'TEMPORARY' SYSTEM IS HIGHERED, THEY OVERPOWER THE FIELDS* (rCf.087), EXCEEDING THE CONVERGENCE LEVEL*, 0 EXPAND DIVERGENTLY*, OUT OF THEIR ENERGY LEVELS/OR-BVfAL,ES* PONDERAWLES* (ref.085-D), IN THIS CHSO THE ELECTRON*, IS CHARGED WITH ENERGY OUT OF TEMPORARY SYSTEM* (ref.V-3), PONDERA- DLE*, AND UPON RETURN TO THE SAME (ref. 085-E), IS DISCHARGED OF THE SAME, PENDING THE OHssRVADon OPTICALLY, AND ACCORDING TO THE CRYSTALIZATION OF THE SYSTEM.

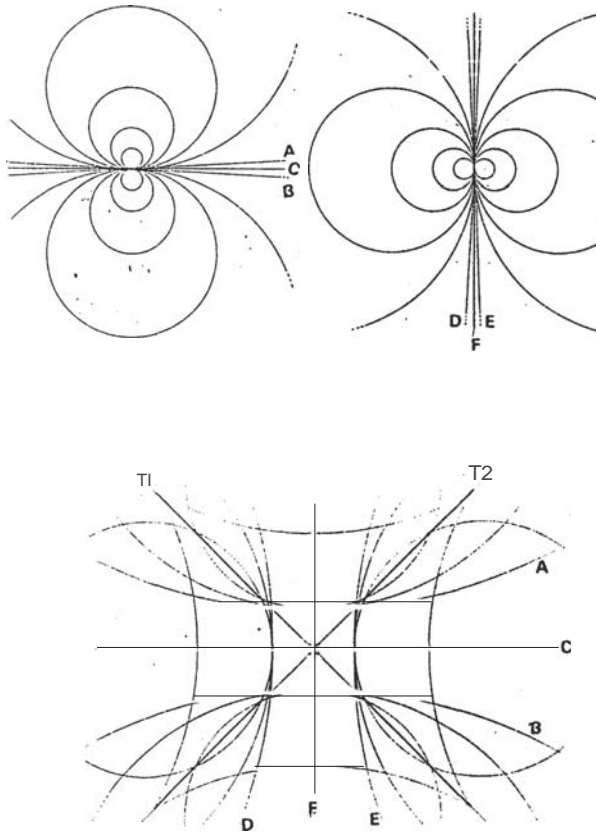
IT SHOULD BE CLARIFIED THAT, ALTHOUGH IT IS TRUE THAT IN A STATE OF EQUILIBRIUM THE TEMPORARY SYSTEM*, THE ELECTRON* (or least positive charge), ESTK'. BEING CHARGED AND DISCHARGED OF POSITIVE CHARGE (figure 085-A, B), BUT THE TEMPORAL SYSTEM* CONFORMED IN THIS MANNER, WISHES TO ENCOUNTER WITH ITS SAME NATURE AND DESCEND TOWARDS THE NUCLEUS, if this happens, it is the end of the temporal system* in which it is inserted (black hole+), which is devoured by the complementary field* of its own system.

INTERVENTING AN ELECTRON* OF A TEMPORARY SYSTEM* IN ANOTHER SYSTEM INTERFERES IN ITS LINES OF FOUNDATION* (ref.046), CONFOIMANDINGO UY MAGNETIC INDUCTION PROCESS, WHY IT IS IMPOSSIBLE FOR IT TO ASSOCIATE WITH IT; UNLESS IT ACTS OUTSIDE THE ENERGY/OY BITAL* PONDENABLE* LEVEL (ref.V-3), AND IS INCWRPOUSED WITH THE TENDENCY* TO JOIN ITS NUCLEUS - BASE OF THE 'CHEMICAL' VALENCIES- (ref.V-3).

IF WE HAVE UNDERSTOOD THIS PRINCIPLE, THEN IT WILL BECOME CLEAR TO US TO DISCERN THE UNKNOWN OF PHYSICS IN TERMS OF ONDU- LATORY MECHANICS* AND QUANTUM MECHANICS*, SINCE IN THE SCHEME OF FIGURE 085 WE CAN OBSERVE IT NEATLY DEVELOPED.

(wave ref. 085-A, B, quantum 1,2,3)

INFINITIES IN THE
CORE OF THE POWER UNIT*.



1 FIGURE 089

09 - FIGURE 089-1, SHOWS AN ECUATORIAL AXIS, CONFORMED WITH ARCUS* OF THE CON -ACT CIRCLE WHICH AT A POINT, IS INTER- 'tONNECTED WITH THE OPPOSITE FIELD*, GIVING ORIGIN TO OPPOSITE RADIO VECTORS* (ref.041), EM 25TE Case inFLuIDo POn THE POLAR* ca POS.

HE WHTOGONAL EÙE* IS CONSTITUTED IN THE SAME WAY BY OPPOSITE RADIO FACTORS*.

0s EJs, THUS CONSTITUTED, HAVE THE CHARACTER OF RADIO VECTORS*. !%UESTOS, FOLLOWING THE PRINCIPLE ESTABLISHED BY THE CROSS CALLED 'fRVA* (ref.048,049).

THE OPPOSITE* RADIO VECTORS*, ON GET THE NUCLEUS ITS EMISOn iVüIGE
 N'IE -YCO NVEiáGENT'E*, YAQU OS UDI 'i'ORES
 OPPOSITE* TISNSN THAT CAHCATEB BY THE SAME CHARACTERISTICS OF THE
 TEMPORARY SYSTEM* IN THE MANNER ALREADY EXPLAINED.

060 - IN FIGURE 009-3, WE CAN SEE THE NUCLEUS VERY MUCH ENLARGED
 in order to verify the integrity of its inventory.

THE SCHEME IN FIGURE 089-3, WHERE WE SEE A DIMENSIONAL CENTER cU
 DnADo, CROSSED BY UOS DIAGONhLES, IS THE SAME AS THE ONE WE SEE IN
 A THREE-DIMENSIONAL SCHEME* ESTpCIpL, IN FIGURE 099.

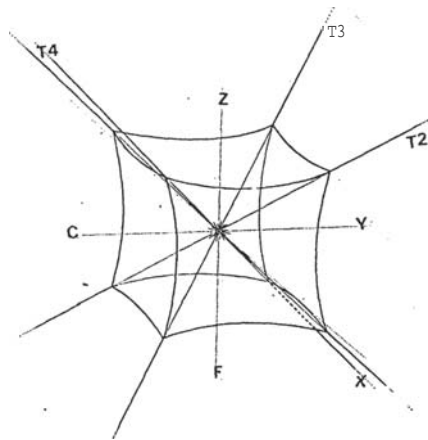


FIGURE 090

it describes some of the p lLs axes, conNronMed by 01°ULST0S*
 radius vectors; 1.
 - Y - OF THE TEMPORAL SYSTEM*, THE - f - WHICH COL&RESPONDS TO THE Z
 - AXIS OF THE SAME SYSTEM, AS DOES THE LE - X - AND THE TEMPORALS*
 T1, T2, T3, '1'4, YES, ALL OF THEM ARE DASIC LES, BUT 'LET US BE
 AWARE THAT THE UNILJAD DL ENERGY* POSkr INFINI "LOS OPPOSITE RADIO
 VECTORS*, LUS WHICH CONPOL?MAN IMFInlVo rJES (rcf.0W2), WHICH FORM
 ON ITS EXTERIOR IS A POLYHEDRAL SKIN.

The nneuES OF THE Cuno oe ra rCiURA 090, ARE CURVED, AS IT IS'PAÍ CONI "O1?MADAS
 1°OH CAFIP9S*, WHOSE SUPLItfíic I E EX'fíííOtr COHdLSPONDEES TO THE 1" IGU THE
 GEOME'TRICA ES fíERICA.

IN THE NUCLEUS OF FIGURE 090, WE SEE DRAWN A RADIAL CENTER, IN
 REALITY THERE THE OPPOSITE RADIUS VECTORS* CONVERGE, IN THIS WAY,
 THE ARGEBEAIC* SUMMATION OF THE FORCE LINES* - ASf COMPUTE -
 INTERVINIENT IN THE BARICENTER* OF THE SPHERE (fç, f.002) IS EQUAL
 TO ZERO, OR CENTER OF EQUILIBRIFICITY OF THE SYSTEM.

WE HAVE MEASURED - MENSURED - THE OUTSIDE OF THE ENERGY UNIT*, IN THREE BASIC DIMENSIONS, BUT THE NUCLEUS - CENTER OF FIGURE 090 - LACKS DIMENSION*, THEREFORE IT IS ABSENT OF SPACE TIME - bTEltNITY - OF THAT WS AD1MENSIONAL* - V-EL* -

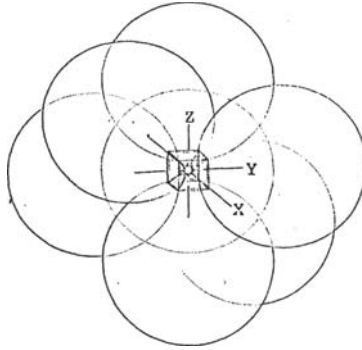


FIGURA 091

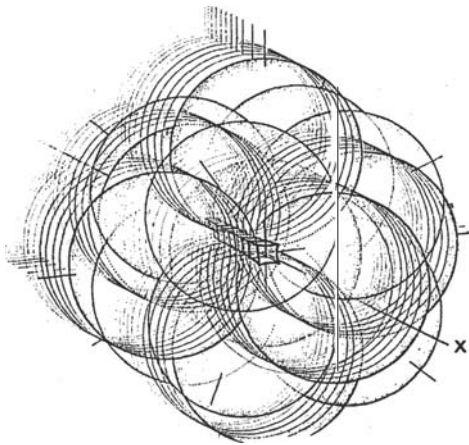


FIGURE 092

61 - FOR A TEMPORARY SYSTEM* TO EXIST, THE PARTICIPATION OF THE COMPLEMENTARY FIELD* AND ITS RAW MATERIAL IS INDISPENSABLE.
 - V-EL* - EMOTION AND PLASMA AT REST - DIMENSIONLESSNESS, ETERNITY

WITH DISTRIPTOS COMPONENTS THE ENERGY UNIT* IS CONCRETE BASED ON THE FOLLOWING PRINCIPLE:

EMOTION* SELECTS ONE OF THE INFINITE TEMPORAL CENTERS EXISTING IN THE UNIVERSE, WHICH ARE RELATED TO THE LEVEL OF MUTATION*, THE EXISTENTIAL PLANG* IN WHICH IT ACTS, AND THE TIME AND FORM WITH WHICH IT PARTICIPATES.

THIS IS THIS THE WAY THEREBY THE INTERNATION OF THE INTERNATION, NECOGIENDU EXPENIENCE IS DEVELOPING THE INTERNATION OF THE UNITY, AND INFLUENCING ON ALL THE TENPOEAL SYSTEMS*.

WHEN LL NLEVEL EMOTIONAh* REACHES THE EUULIDNESS, THEN IT IS MANIFESTED IN UNITY AND IS CAUSE*.

HOWEVER, 'WHILE THE UNIT OF ENERGY* PARTICIPATES IN TIME, IT EXTENDS IN GEOMETRICAL FUNCTION* TO INFINITY, INFLUENCING ITS OWN TIME TEMPORALLY, AND FLEETINGLY ESTABLISHING ITSELF AS A CAUSE* BY UNDERSTANDING ITS NATURE AND THE DEVELOPMENT OF THE INTELLIGENCE AND EMOTION THAT ARE PROPER TO IT.

62 - TO GIVE US A CLEARER USING OF THE COMPOSITION OF AN AXIS (ref.091), WITH INFINITE BASIC CUDES OR POLYEDRICAL* SPACIAL ES1 "ERAS, EACH ONE WITH AN ADIMENSIUNAL* CENTER* IN ITS BARICENTER* WHICH WE NAME - ADIMENSIONAL SENSORY CENTER* - V-EL* - LET US OBSERVE FIGURE 092.

LET US NOT LOSE OUR CAPACITY OF IMAGINATION, TO REALIZE THAT THE SUM OF OPPOSITE RADIO VECTORS* WHICH COMPOSE THE ENERGY UNIT*, RESULTS IN A SPHERAL SPHERICAL SPECTRAL VISION (ref.002) WITH EXPANSION OF THE POLAR FIELDS IN GEOMETRIC FUNCTION* TOWARDS THEIR PONDERABLE* ENERGY/ORBITAL LEVELS* (ref.V-1, V-2, V-3, 008), AND THEN TOWARD INFINITY ACCORDING TO THE DEVELOPED INTELLIGENT AND EMOTIONAL* LEVEL, IJTERVINENDING rUcA PEOPLE AS CAUSE*, AS LONG AS THEY ALSO LOCATE AT THAT TIME THE BALANCE AND DO NOT DETER THE ESTABLISHED CAUSE-BASED ORDER.

xERc TO.

63 - THE CUBE IS CONSTITUTED BY SIX EQUILATERAL DASIC PYRAMIDS (ref.03s), WE SAY THAT IN THE CUSPIDES OF EACH OF THE PYRAMIDS IS DONDL SL MANIFESTING THE ABSENCE OF SPACE AND TIME. ETHINLDITY, UNITY - V-EL* -

ESf0 CALLS US TO THE ITFLEXION TO CLARIFY THE REASON WHY OUR ANCIENT AMERICAN PIOTUS ANLESTINIANS, PNOTO MAYAS, BUILT 'VNUNCATED PYRAMIDS, PLACING A TEMPLE ON ITS TOP VERTICE, WITH THE OBJECTIVE OF FULFILLING THE CEREMONIAL OF THE SUN (ref. 090 center) OF OUR SOLAR SYSTEM, OR THE PHOTON* OF THE PHYSICIANS, OR THE NUCLEUS OF THE GALAXY, OR THE CLN'RO OF THE UNIVERSE O.

THAT SUN (ref.040), FORMED BY THE CHARGE INTERACTIONS OF THE DIFFERENT SIGN, PRESENT IN THE UNIT OF ENERGY* AND IN EACH ONE OF THE COMPONENT PARTS OF OUR SPACE AND TIME; HAS ITS MOST EVIDENT MANIFESTATION, IN THE SUN OF OUR SYSTEM (ref.085...nucleus) AND IN OUR OWN ANATOMIC SYSTEM, AND IN EACH ONE: OF ITS CELLS, SINCE THEY ARE CONFORMED BY UNITS OF ENERGY*, AND IN EACH ONE: OF ITS CELLS.. nucleus) AND IN OUR OWN ANATOMICAL SYSTEM, AND IN EACH ONE OF ITS CELLULARS, SINCE THEY ARE CONFORMED BY UNITS OF ENERGY*.

THAT SUN IS THE VEÜICLE TO CONNECT WITH THE COMPLEMENTARY FIELD OF THE SYSTEM, AND FROM THERE TO THE ETERNITY V-EL* - OR THE ESSENCE OF THE UNIV5ISO

HOWEVER, IN THE LACK OF SCIENTIFIC KNOWLEDGE, OR MAYBE ozi. cuNc lz1"10
 THAT WE POEf 1 "12MOS DI2 NOT C1 úN '1 E'ICO, NUI2ST ROTT ANCESTRALS RESOURCED TO
 THEIR CAPACITY TO UNDERSTAND THE UNCONSCIOUS MEMORY RADICATED IN THEM
 xis os, THEREFORE THEY PERFORMED THESE COLOSSAL WORKS, WITH THE OBJECT
 OF LOCNAN nESONANCE* WITH THE ADIMENSIONAL SEXSORIAL CENIno sEXSORIAL* -
 THE CENTER OF CENTERS OR GOD MANIFESTED -

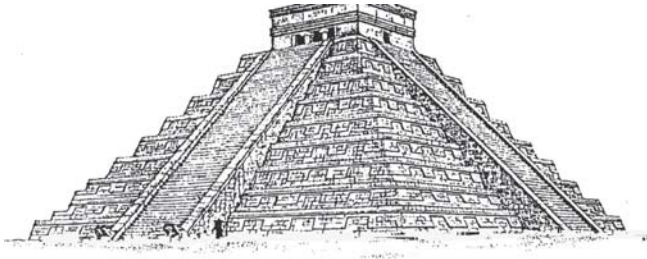
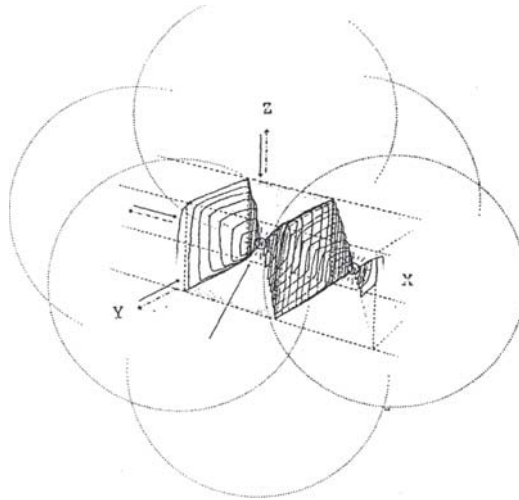


FIGURA 093

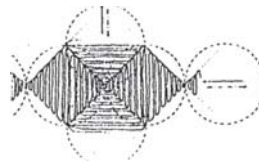
THE GAXNA INFORHAC ION".
IS TRANSMITTED WITHOUT ANY DISTINCTION OF TIME AND SPACE
THROUGH THE DIMENSIONLESS SENSORY CENTERS - V-EL* -
TO THE TOTALITY OF THE UNIVERSE



1



2



c

3

FIGURE 094

064 - IF WE HAVE CAREFULLY STUDIED THE DIAGRAMS IN FIGS.
 089, 090, 091 AND 092, WE WILL BE ABLE TO BETTER UNDERSTAND WHAT HAS BEEN
 SCHEMATIZED
 EN LA rIcuPA 094.

IF IN THE INTIMACY DI THE ENERGY UNIT* WE CAN ODSEHVAR A
 /LBo DASIC, CONSTITUIDO ron sLIs EQUILATERAL FIRAMIDES, MAYBE jflRA
 jflRA MAS LACIL UNDERSTANDING THE irAZONAMIENT WITH lZESPECTO A LDS RAYS
 tGHMA*.

IN THE LIGHT OF THE ABOVE-MENTIONED PROPOSAL, WITH RESPECT TO THE
 INFORMATION PROVIDED BY THE

cion iruND GIVES IN RADIAL POMMA* AND WITHOUT SPACE-TIME* TO THE UNIVERSE AND ALL THE TEMPORAL SYSTEMS* THAT CONSTITUTE IT, BE IT THE MICRO SYSTEMS - HYDROGEN ATOM - OR THE MACRO SYSTEMS - GALAXIES - WE WILL STOP TO ANALYZE THEIR PARTICIPATION.

ISO WE SEE IN FIGURE 094-1, IS THE IMAGE OF A GAMMA* WAVE SECTION; IN THE EU - X - DILATATE OF A SPATIAL TEMPORAL* SYSTEM; IN THIS WAY WE OBSERVE THAT THE RAY* POSSESSES A SHAPED FORM, ADAPTED TO THE PIRAMIDAL STRUCTURE THAT EXPANDS AS A FUNCTION OF THE EMOTION* (ref.086), AND THE PLANS OF SYMMETRY* CONFORMED BY THEM (ref.007), DRAWN THROUGH THE EDGE EFFECT* TOWING TOWARD THE[. CENTER OF THE V-1 ENERGY/ORBITAL* LEVEL, AND THE EXPANSION RADIAL* EN FUNCION GEOMETRICA* (ref.012, 013) QUE ACTUA EN CADA UNO DE LOS VERTICES DEL SISTEMA PIRAMIDAL.

THUS SEEN, WE FIND THAT THE CHARGE INTERACTION IN THE DYNAMICS OF THE UNIT ENERGY* NUCLEUS, FORMS A
 - V-EL* - DIMENSIONLESS SENSORY CENTER* - EMOTION AND PLASMA IN REST*; Y VAT SUPORPOSITION OF FIELDS* A VII.IUCULE THAT 'HANSPOI2TALA ENOHION *IIA-6lh hL UNIVLLihSO C3NOWN - EN I*OhMA DIVURGEin'IL* - Y DESI3E ES'E TOWARDS HIS CEN'lio DYNAMICS -AT FCihNA CONVERGING* CONVERGENT*

IN FIGURE 094-2 WE CAN OBSERVE THE SHAPE OF THE GAMMA WAVE* LINKING THE CENTERS OF THE INFINITY OF TEMPORARY SYSTEMS* (ref.095) STARTING FROM A RADIAL NUCLEUS.

FIGURE 094-3, SHOWS A GAMMA WAVE - c - LENGTH* (distance between two vibration maxima), WHICH IS APPROXIMATELY 0,000,000,000.000.1 mm. - ONE OF THE SMALLEST MEASUREMENTS WE KNOW OF, IF THERE IS SUCH A MEASUREMENT.

THESE RAYS ARE ONLY ELECTROMAGNETIC VIBRATIONS* THAT DO NOT POSSESS AN ELECTRIC CHARGE.

THE NATURE DI OF INFORMATION IS OF coNc&#NTE*, AND ACHIEVING EU N6SONANCE* PRECULNCy WITH EIU, IS OF GREAT IMPORTANCE FOR THE TECHNOLOGY WHICH TO A GREAT EXTENT REPLACED CYBERNETICS*, WHOSE FIRST STEPS ARE ALREADY ON THE STUDY TABLE OF SCIENTISTS, AND WHICH WE WILL DEVELOP FURTHER ON. (cerobratica).

WE CONSIDER THE GAMMA RAY* TO BE A QUANTUM OF ELECTROMAGNETIC RADIATION* EMITTED BY A NUCLEUS, UNAFFECTED BY MAGNETIC FIELDS*.

WHAT HAPPENS IS THAT THE INTERACTION* OF CHARGES OF DIFFERENT SIGNS IN THE DYNAMICS OF THE NUCLEUS OF AN ATOM GENERATES MICRO SHORT CIRCUITS*.
 - PHOTONS* - RESULTING IN THE RELEASE OF GAMMA RAYS*.

THE CONCRETE DELIMITATION OF THE NATURE OF THE GAMMA WAVE*, IS VERY DIFFICULT TO EXPLAIN, SINCE THE INSTRUMENTS OF OBSERVATION ARE VERY LIMITED, BUT THE KNOWLEDGE OF ITS EXISTENCE HAS ALLOWED SCIENCE TO ADVANCE, INSERTING THEM IN IDEAL MODELS.
 0 PHYSICAL PATTERNS*.

IN FIGUEA 095, WE SEE CN DIDIMENSIONAL CUT*, ONE SYSTEM, TRANSLATING< THROUGH THE EdE - X - GAMMA* INFORMATION TO ANOTHER} CENTER OF A TEMPORAL* SYSTEM IN PROCESS OF CRYSTALIZATION (suI explanation will follow)

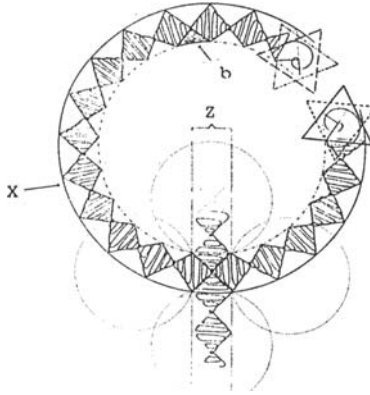
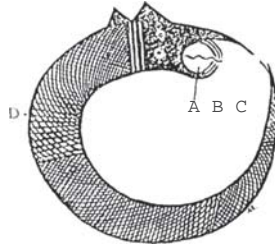


FIGURE 095

WITH THE DATA WE HAVE
LET'S ASSEMBLE THE POWER UNIT* .



1'1SU PAU 9 G

065 - THE I "A S C I N N A C I O N T H A T G I V E S U S T H E C I E N C I A O F T H E S I K Y A T K Y
 ii "u ir nN' res ur cos i "ti wisl..os i-i'o'ro noenicnNos . nos i mavc r n color i -
 R u f f H C O N S U S U S I N V L S 2'1 G A C I O N E S .

L4 FIGURE 096, SHOWS US THE IMAGE OF AN ANIMAL - PERHAPS A SNAKE
 - BENDING IN A CIRCLE TO MEET ITS OWN TAIL; IF WE REALLY WISH
 TO PERCEIVE ITS MESSAGE TO
 TLAVES OF OUR IMAGINATION (perhaps this is the vehicle to take mental
 resonance frequencies* with your research) I-OCE LI? - A -
 ELS fMBOL OAC 2UA EUNA ESISTENC IÁ- B -
 UNC(3NDLNSANOI?DEI'LACA, Y -C-C- UII VECIOI2*.

THE EGYPTIANS ALSO TOOK THAT TYPE OF BIDIMEN- SIONAL* GRAPHICATION FOR THE PRINCIPLE OF LIFE, WE HAVE TAKEN THE SIKYATKY G'ALICATION, AS IT SEEMS TO BE MORE FITTED TO CURRENT SCIENTIFIC KNOWLEDGE, IN EITHER ASPECT RELATED TO WHAT WE HAVE SEEN I'O PREVIOUSLY (ref.096).

We start from the premise that this plate condenser is a unitary unit with an interest in participating in a temporal cycle according to the genetic memory of its form.

FOR SB PONMALLCE, IT IS NECESSARY THAT THERE IS AN INTERFERENCE IN A SIMILAR FIELD, 'L'LORICAMENTE INVEL{SSSUALLY PROPORTIONAL / ORTHOGONAL* TO THE SAME (complementary field*) BUT PARTICIPATING IN THE NUCLEUS OF THAT CONDENSER (ref.04D), IJEDE POSMEIT VERY D rzN DASTE CHARACTERISTICS.

FIRST, AS WE HAVE ALREADY v sTo, THE DECISIVE rACTOR IS THE EMOTION* (ref.D88) AS THE RECEIVER OF A MEMOHY, WITH THE "M'l'ECEDENVES OR DATA PACKET OF THE CYCLE ALREADY COMPLETED IN THE 0 HIS TIWPMO, WITH HIS INTRINSIC ACCEPTANCE AND THE INTEHes TO MUTAR*. 0 NG.TO ANOTHER TEMPORARY STATE.

IN(JCION* IN THAT LS'fate, CHOOSES THE PROPER PLACE (frequency The resonance consciousness*), AMONG THE MULTITUDE OF RELATED CENTERS THAT LXISL'EN ZL UNIVERSE.

WE UNDERSTAND THAT EXCEPT FOR DEFINITE COSMIC CIRCUMSTANCES, IN REITERATE MUTATION CYCLES, MANIFESTATION IS PERFORMED IN THE AN ERIOE SCENARIO, AS IT IS THE CLOSEST TO ITS MEMORY.

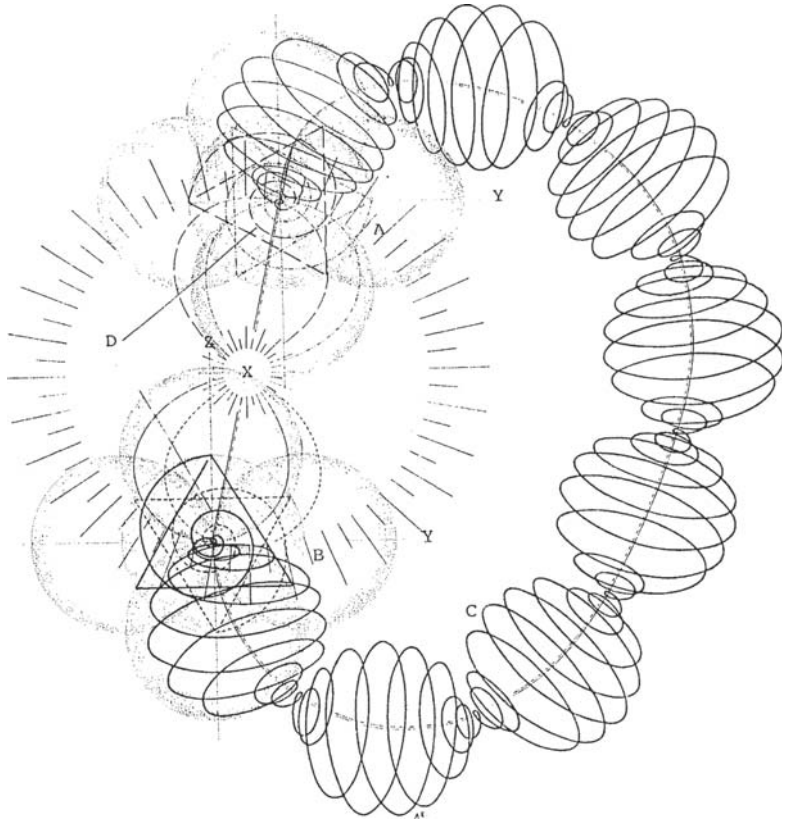


FIGURE 097

IF WE COMPARE PAGE 097 WITH 096, WE WILL FIND A SERIES OF ANALOGIES - D, E - REVERSE DIRECTION OF ROTATION (ref.065,074)

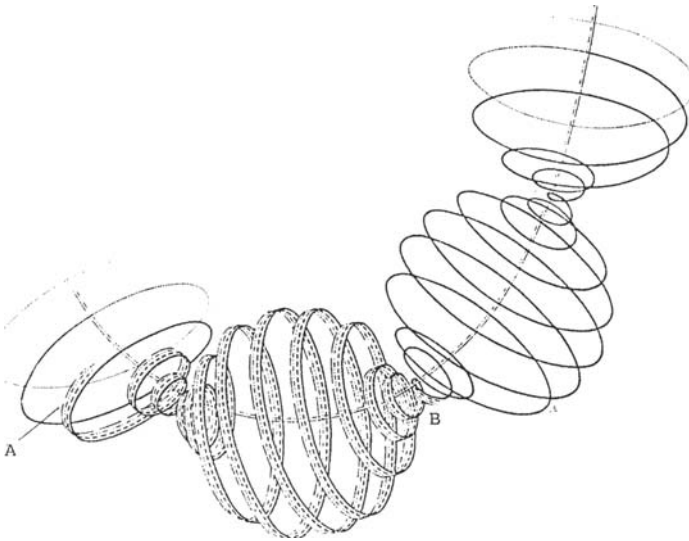
IN FIGURE 096-D, NOW WE FIND THAT THE SKIN OF THE ANIMAL HAS **BEEN** DRAWN WITH LINES THAT PRETEND TO FOLLOW A HELICOID.

IN FIGURE 097, WE FIND THAT THIS BODY MOVES IN THE SAME WAY, IN THE ELECTROMAGNETIC WAVE* (ref.098), WHERE THEY COUPLING - A AND B - DO IT THROUGH A CONDENSER' DO PLATE*, TO CRYSALIZE EACH THE ENERGY UNIT*.

EN	Lh	NIIS	'IGUUA	LuhF	'AISEA DOSU	NTODE	ACOPLE	X-Y7
QUL	LN	1AP1ACT	ICAESI	NFIN1CAMENTE	PEIUERO;	COMPAKEMOS1A		
CCN		LASF1	GUPAS	094	Y 095,	IAPA	DARNOS	
						ACCOUNTING 1A	MEASUREMENT	

Say ONE OF ITS COMPONENTS (ref.gamma wave* 094-3).

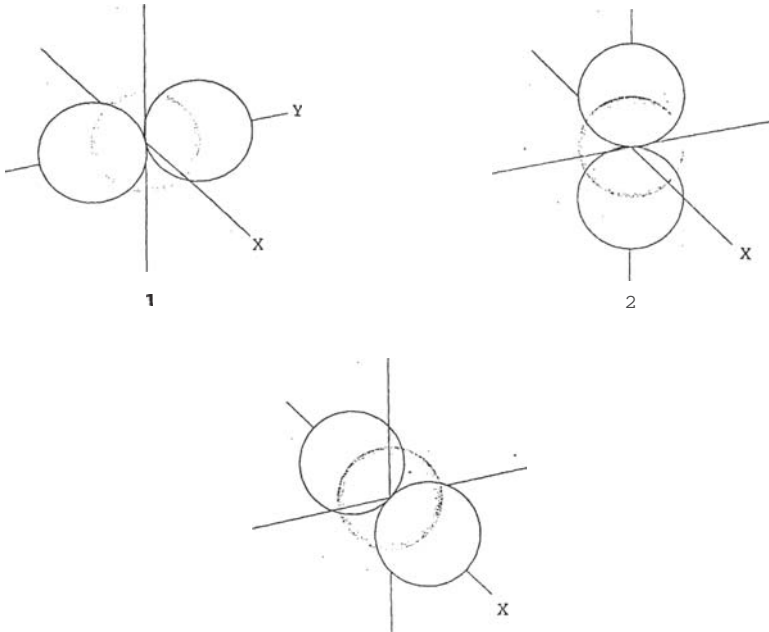
IT IS VERY IMPORTANT TO TAKE INTO ACCOUNT, THAT THE ELECTROMAGNETIC WAVE (ref.097-C), ASSOCIATES WITH ITSELF, AFTER TRANSMITTING THE UNIVERSE, BEHO WITH DIFFERENT ANGULAR MOMENTS (nuclear spin) AT ITS EXTREMES, EXISTIING A MOMENT - 0 - OF COUPLING. (ref.097, D and E; 065 and 074, spins found ; 097-X).



I.LCPU IIA 098

MCMOO SEEN THAT LICULTA 097, EXPANDED IN 1 "UNCIÓN GEMOETRICA TO INFINITY, COMES TO CONSTITUTE A CIRCLE, OF SUCH MAGNITUDE, THAT AN ARC* UE THE SAME CONSTITUTES THE PAITE OF AN EE (ref.041 and 095), WHICH THE GPSE17VALJOR AT A GLANCE, WOULD SEE THAT ONE AXIS IS EXJ:11JNUL MACIA L.1. 1 "NENTC, WHILE THE OTHER UE COMES BY UETMAS OF THE TEM1°OHAL* SYSTEM TO CONSTITUTE.(ref.011).

THE SINTIDO DL GLIO DtVLNGLN'l'E* AND CONVERGENT*, MANIFESTED IN THE NAl'UNALLXA DS THE UNOA (ref.090-A), PLRMITE GNAFICALLY ENTEN-DEE (ref.097, lJ and l) THAT ls THE MOMENT OF PARTNERSHIP, TURN IN. OPPOSITE DI1?ECTIONS (desLrogiro* and lev siro*).



riGUhA 099

065 - WE CAN ODSEBVA1 IN THE 099 LEAGUE, THE UE - Y - POLARIZED* IN ORDER TO CONSTITUTE THE V-1* FIELD, (ref.008)

THE SAME BEHAVIOR IS FULFILLED BY THE UE - Z - AND THE LE - X - ACTING AS FIELD SUPPORTS* - V-SC* -

A PART OF THIS POLICY HAS ALREADY BEEN SEEN IN SCHEMATIZATION M 'AL riGVRAS 041, 089 AND 097.

IN THIS WAY THE AXES OF A TEMPORAL*V-SIAC DASIC SYSTEM ARE CONSTRUCTED, WHICH WE CAN OBSERVE IN FIGURE 100, AND THEN IN FIGURE 101, WHERE THE UNIT OF ENERGY*, TAKES VOLUME OF CRYSTALLIZATION*, (ref.090), THROUGH THE TRIGONAL AXES*, BEING SEEN BY THE OBSERVER IN A NEO-SPACE FIGURE.

67 - NOW LET'S SEE HOW IT IS CONSTRUCTED; FIRST OF ALL, THE FOEMA STRUCTURER FIELD - V-CEF* - WHICH WE ALREADY KNOW FOR HAVING STUDIED IT IN ITS COMPONENTS WITH BTDIMENSIONAL SCHEMES* (ref.006 007, 008, 047, 048, 049, 058, 060, 061, 063, 065, 066, 068, 071,073 075, 076, 077, 078, 079 y 085).

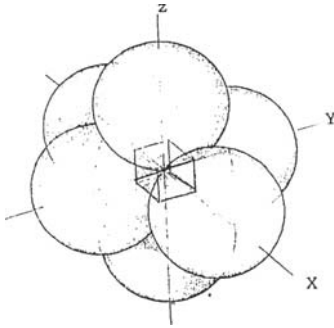


FIGURE 100

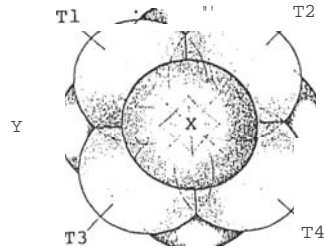
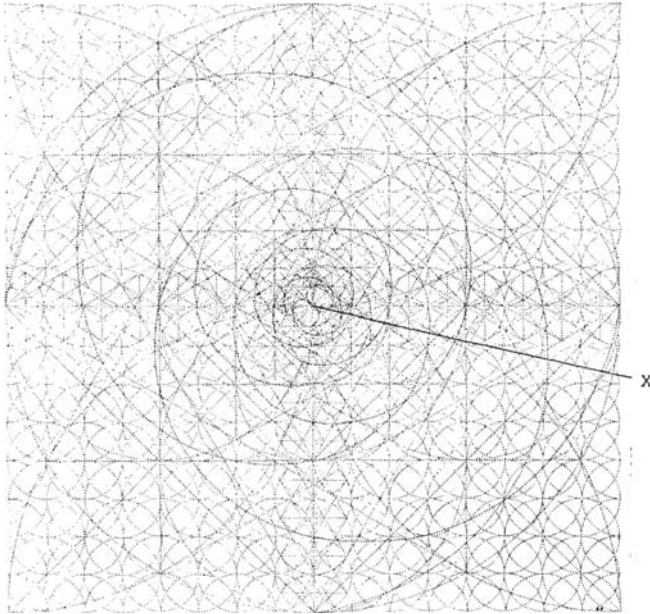


FIGURE 101

THIS FIELD*, DRAWN BIDimensionALLY*, SINCE IN SPACIOUS FORM IT WOULD BE ALMOST IMPOSSIBLE TO OBSERVE IT WITH ITS INTERVIEWING FORCE LINES*, WE MUST IMAGINE IT AS A SPHERE WITH A TROWEL OF FORCE LINES* STRUCTURING IT (ref.007).

LET'S CONTINUE TO UNDERSTAND THE PRINCIPLE OF CRYSTALIZATION OF ENERGY TO CONSTITUTE SOLID MATTER - UNIT OF ENERGY* -



F1GU1tA 102

ESQUEMA UNIVERSAL - CAMPO ESTRUCTURADOR DE FORMA - V-CEF* -

68 - THE LIGUE 102 SCHEME, SHOWS THE UNIVERSAL SCHEME* OR FORM STRUCTURING FIELD* - V-CEF* - THIS FIELD IS THE FRAME WHERE A TEMPORARY SYSTEM* (ref.074, 065) IS ORGANIZED, IN FRONT OF ITS MIRROR, THE COMPLEMENTARY FIELD* - V-CARIO* -

IF WE LOOK CAREFULLY AT THE &EsARBOLLOf THE CRYSTALIZATION PROCESS, WE MAY FULFILL THE DASE IN WHICH WE ARE INSERTED.

LL TEMPORAL* - V-SIAL* SYSTEM - ARISES FROM THE COMPLEMENTARY FIELD - V-CARIOUS* - AND THIS OF THE ADIMENSIONAL* (which has no measure or dimension) EMOCPHON AND PLASMA LN RE2OSO* - V-EL* - A PARTfR DB Sũ NU- CLEO LL AXIS - X -

' ,A DIPEIENCY BETWEEN fG, UNIVEMSAL SCHEME* - V-EU* - AND THE FIELD ' STRUCTURADok DL fõrma - -ci:r* - Bs &L ANTLs AND AFTER INICIADõ A TEMPORARY SYSTEM* - V-SIAL* - AS THE FIRST IS PRESENT ANYWHERE AND IN ANY PLACE IN THE UNIVERSE WITH THE PURPOSE OF BEING INHABITED BY THE ASSOCIATION OF A COMPLEMENTARY FIELD* - V-CARIOUS* AND A TEMPORARY SYSTEM* - V-SUL* -

PROTO-AMERICAN PLoSoPus, AND LONG AFTERWARDS THE GREEK RIVERS, IMAGINED THE EKISTLNCY OF THE PRIMIGENITE SUBSTANCE WHICH THEY CALLED ETER - ETER, OR MUSIC OF THE SPHERES - ACCORDING TO WHAT WE HAVE ALREADY SEEN, BUT THE PROPOSAL STARTED FROM THE FOLLOWING POINT - DAN NEST -

- A - V-EL = EMOTION AND RESTING ELECTRIC PLASMA - NO TIME -
- B - V-EI - UNIVERSAL SCHEME - ETHER - E6 TIME STARTS -
- C - V-CEF - S6 INITIATES THE DB UNIT IN THE FOLLOWING COM
SPEAKERS (energy crystallization)
- D - V-CnRIO - THE EMOTION AND ELECTRICAL PLASMA AT REST, S S S
DIVIDES IN S U S CONPONENTS, E FIELD C3MP L EME NT E12 TO QJE P
ARTICI - FOR EN ALL L3S TI EL-IP OS OF U 8 S I S E MA TEHPONAL . S U S
TENTING IT IN E6 TIME AND THE EXISTENCIAL PLAN IN
WHICH
PARTICIPE.
- E - V-SIAL - IT IS THE TEMPORARY S&tSTL1A, ADOPTING DIFFERENT ROLLS
IN THE TIME AND EXISTENCIAL PLAN IN WHICH THAT FWR MA
ACTS, WHICH POSSESSES UI4A MEMORY ELABORATED IN THE
TIME PASSED, AND THE EMOTIONAL LEVEL WHICH WILL ALLOW
IT TO ACCESS MORE COMPLEX AND INTELLIGENT FORMS, IN
LOG PR:JXIMOS TLEMPOS A TRANSCURRIR, HASTA ACCEDER
NJEVA- MONTE AL - V-EL* - EMOCION Y PLASMA ELECTR.ICO
IN REPO
SO (equilibrium and cause)

IF WE TAKE INTO ACCOUNT THAT - V-EL* - DOES NOT ADMIT
CONTRADICTIONS, SINCE THEY HAVE A PURELY TEMPORAL CHARACTER, WE
It is considered that the ether is already matter (support of
electromagnetic waves in space), and each material cycle has an
existential plane, far away from our vision, because it lacks the
ability to extend to the whole spectrum of electromagnetic waves,
and that each material cycle has an existential plane, far away
from our vision, because it lacks the ability to extend to the
whole spectrum of electromagnetic waves.
AND MANIFEST THEMSELVES ONLY BETWEEN INFRARED AND ULTRAVIOLET RADIATION.
VIOLET - io4 and lo3 angstrom units)

F - V-UE THE UNIT OF ENERGY, OR THE BASIS OR FOUNDATION WHERE
A SYSTEM STARTS, OR MATTER AS WE **KNOW** IT AND EXPLAIN
IT IN THEORY.

SOLID MATTER DOES NOT EXIST WITHOUT THE EXISTENCE OF
THE UNIT OF ENERGY.

EACH UNIT OF ENERGY HAS ITS OWN FIELD; IT IS THE SUM
OF FIELDS RELATED TO THE EXISTENCIAL PLANE, WHICH
MANIFESTS ITSELF IN MATTER PERCEIVED BY OUR SENSES.

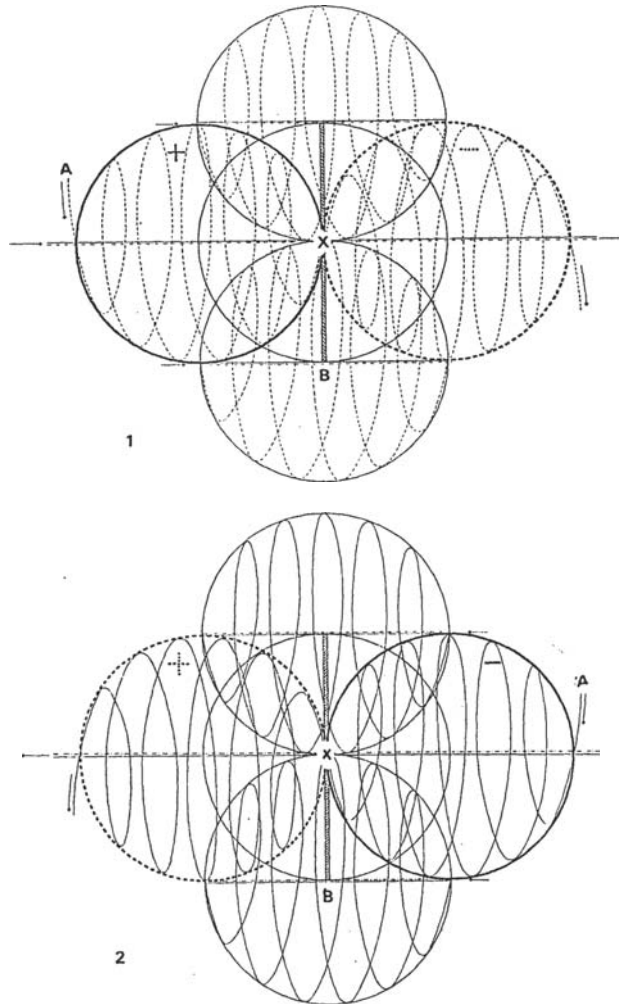


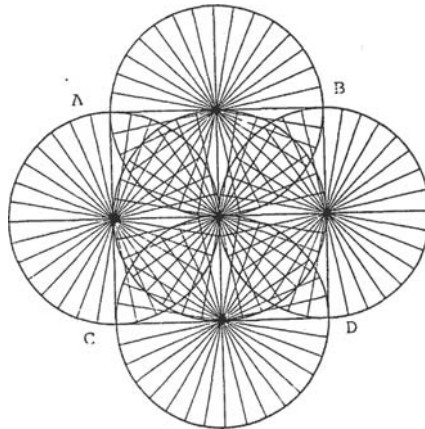
FIGURE 103

69 - BEFORE GOING INTO DETAIL ABOUT THE DIAGRAMS OF THE FIGURE
 103, IT IS NECESSARY TO RECONSIDER WHAT WE HAVE ALREADY SEEN IN THE
 FIGURES
 040 AND 097, SINCE IN THIS CASE WE HAVE A CHARGE INTERACTION,

A THAVES OF THE N'CLEO - X - (ref.102), THAT IS THE ELECTROMAGNETIC WAVE* - I-A - PRODUCING FROM THE BACKS OF THE TEMPORARY SYSTEM* (seen by the observer facing it), INTERACT WITH THE OPPOSITE WAVE OF DIFFERENT CHARGE, AND IN THE SAME FIGURE - 2- A - WE FIND THAT THE SAME INTERACTION IS IN THE CONTRARY DIRECTION (raf.197,C,D) ESTABLISHING A LEVEL - 0 - OF ACTIVITY IN ITS NUCLEUS (ref.012, 013, 014, 097-X).

THE SAME BEHAVIOR IS FULFILLED IN EACH OF THE FIELDS* THAT CONSTITUTE THE ENERGY UNIT* (ref.V-1).

Thus, its action on the X-axis is reflected in the Y- and Z-axes as basic (ref.086, 101).

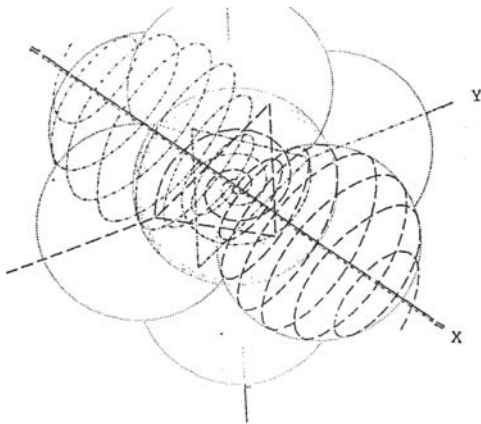


l".f. GU lth :t04

THE INTENACTION OF THE OPPOSITE RADIO VECTORS* (ref.002, 011, 016), AT THE CENTER OF THE ENERGY UNIT* (ref.103-D), SHAPES A FLAT NET OF FORCE LINES* - v-PrLr* - AS SHOWN kSCHEMATIZED IN FIGURE 104-A,D,C,D. IN AN EQUILATEROUS SQUARE (rcl.U70)

2A1?A 'l'ELMINAR Ef, CONCEPT, LET'S ATTENTAMEN'l'E TO THE ELECTRO-MAGNETIC WAVE* ESUUEMAL'IZADA IN ONE DIRECTION IN FIGURE 097, AND HOW IT COUPLES CONFORMING A CONDENSER (ref.097,D,E) WITH TWO OPPOSITE ANGULAR MOMEN- A,E SPINS ENCONT'IED - SUCCESSFULLY AS IN L'ICUIA 103-1,2 - X .

HYPOTHESIS OF THE BEHAVIOR OF A COMPLEMENTARY FIELD
PA IVA CONCREFA ILA UNIDAD DESI NÜIGI A*
CGN THE TEMPORAL SYSTEM*
CRYSTALIZATION OF MATTER THROUGH THE EÜE - X -



PAGE 105

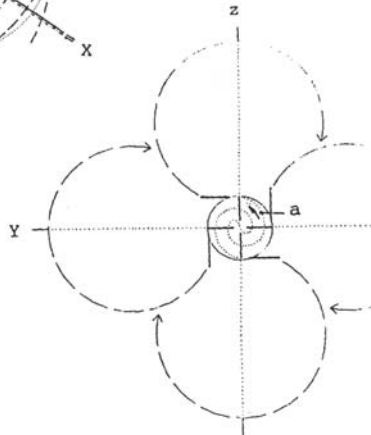


FIGURE 106

70 - IN FIGURE 105, WE CAN SEE WHAT HAS ALREADY BEEN IN SQUARES 045, 046, 048, 058, 059, 060, 061, 062, 063, 064, 065 and 057-A. DZ THIS WAY THE COMPLEMENTARY FIELD* WOULD BE CONFORMED.

FIGURA 106, INDICATES THE PRINCIPLE OF THE CROSSWIRE DESTROGIRA CUEVA*, WITH RESPECT TO THE DISPLACEMENT OF THE WAVES IN EACH OF THE RADIO VECTORS* OF THE COMPLEMENTARY FIELD*, WHICH ARE INDUCED BY THE SPIN OF THE NUCLEUS OF THE SYSTEM -
- THAT INDUCES YOU TO GIVE AN OPPOSITE OPPORTUNITY (ref.045).

IN THIS CASE, THE ELECTROMAGNETIC WAVE* TRANSMITTING BEHIND URL COMPLEMEN7Anzo" FIELD, PASSES THROUGH THE ODSERVATOR ACCORDING TO TO THE SCHEME IN FIGURE 105 (for the purpose of concretizing a system), RETAINS IN THE CORE OR CENTER OF CHARGE INTERACTION* (G force), ITS NEUFRA CHARGE, AND SOHO POLARIZES THE ANTIPOSITIVE* AND IVA AN'1'NEGATIVE* ZONE OF THE ELECTROMAGNETIC WAVE (ref.097-A and C), 1,AS THEY ACKNOWLEDGE THE POSITIVE AND NECA'LIVE CHARGE OF THE UNIUAU Ul: ENll(GIA* (Lenporal* system).

WHEN THE CENTER IS FORGIVEN BY THE ACTION OF AN EMOTIONAL FIELD* OR OIMPLEMEN BY THE EMOTION* AND THEIR INTEREST IN PARTICIPATING IN IT TIEMPU (interpretese pof interest or action dn cause/effect - 006 -) ENERGY CRYSTALIZATION (ref.108) IN A TSMPGIAL SYSTEM, POLARIZING THE POSITIVE AND NEGATIVE CHARGES - TL9PORAL* SYSTEM - AND ANTINEGATIVE* AND ANTIPOSITIVE* - COMPLEMENTARY FIELD*.
- THE ONE THAT IS SIMPLY A SPIRAL* JOINING AT ITS ENDS THROUGH CONDENSATION* (plate condenser).

THE SENLID OF THE TEMPORARY SYSTEM cone* (ref.107), IS INVERSE A6 DLL COMPLEMENTARY FIELD* (ref.106), AS WE HAVE SEEN IN FIGURES 030, 031 and 040. WHICH CONFORMS THE EQUILLIORIUM OF THE SYSTEM (ref.097- D, E).

AS WE HAVE SEEN, THE TEMPORAL SYSTEM* IS ENDOWED WITH A RELATIVELY PRE-DETERMINED TIME, AND WILL REMAIN WITHIN THAT TIME. THE EXPERIENCE THAT "CONSCIOUSLY*" MUST BE EXHAUSTED UNTIL WE UNDERSTAND AND DISCERN ITS NEW STATE IN ANOTHER TIME.

WE HAVE SEEN IT IN THE SCHEMES OF THE &TGHAS 066, 087, 060, 070, 071, 073, 074, 075 and 076, SO WE WILL REPEAT IT.

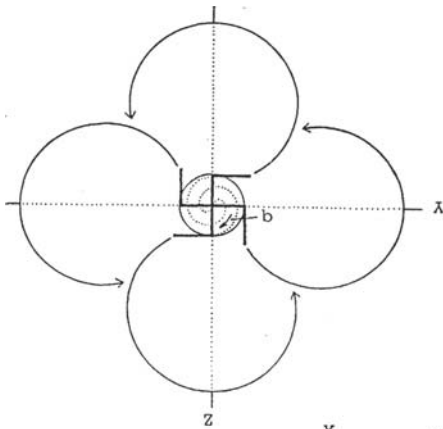
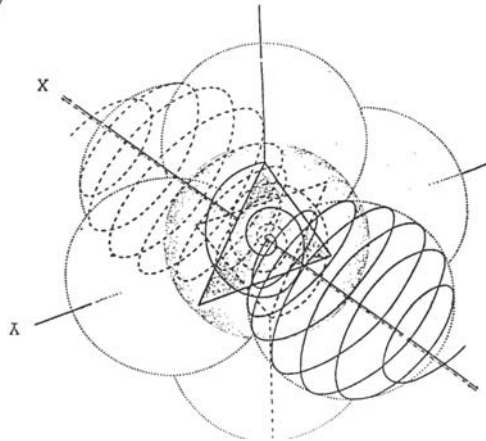


FIGURA 107



rIGu&A 108

71 - THE ELECTROMAGNETIC WAVE* MANIFESTED IN RADIAL FORM* (ref.002), REMAINS BACK IN THE CORE OF THE ENERGY UNIT* (ref. 104) POLARIZING IN ANTICHARGES* AND CHARGES*, WITH THE PURPOSE OF CONFORMING THE ENERGY UNIT* OR ONE OF ITS COMPONENT PAETES, MEDIATING ITS EMOTIONAL LEVEL*.

72 - THE ANTICHARGES* ARE ACTUALLY THE MAGNETIC FIELD* OR COMPO. ELECTROMAGNETIC FIELD*.

WE CAN BETTER UNDERSTAND IT, BY ATTENDING TO THE GRAPHIC REPRESENTATION OF THE SIKYATKY PROTO-AMERICANS (ref.096), WHERE THE ANIMAL PERSISTS IN ITS INTEREST TO JOIN ITS TAIL (ref.096-B).

73 - G1MO LSVOGINW* AND DESTITUm* Uk THE UNIDAU Db ENERGY*.

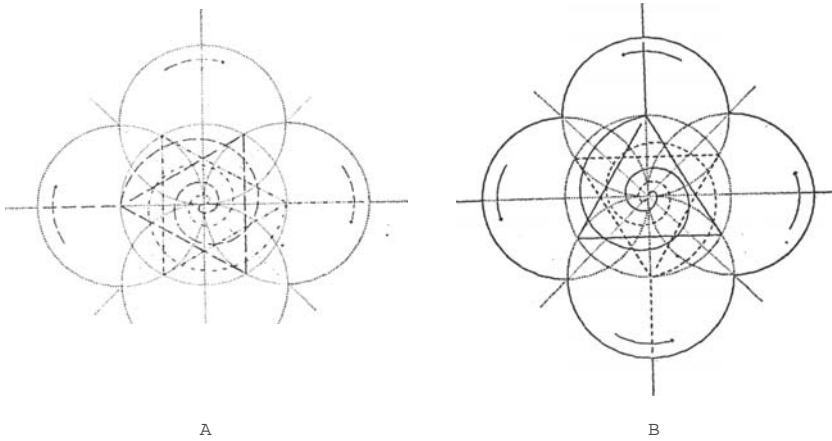


FIGURE 109

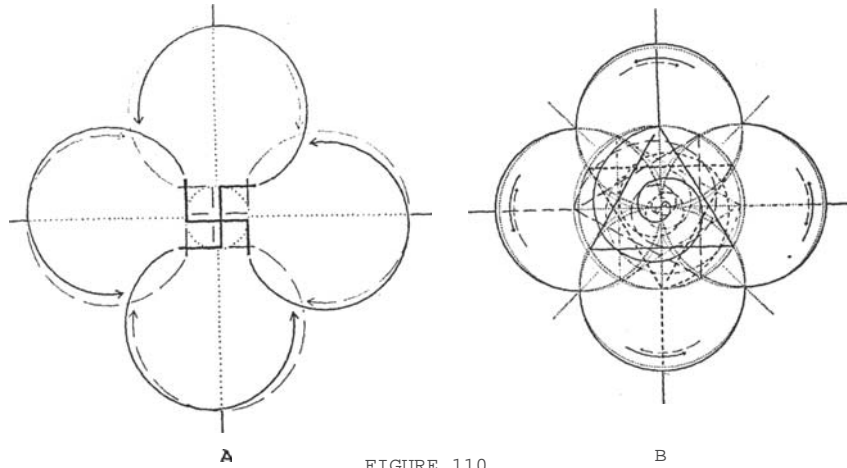


FIGURE 110

FIGURE 109-A, SHOWS THE DIRECTION OF DESTROCIOUS ROTATION* OF THE COM2LSMENTARY CAMRG*, AND FIGURE 109-B, SHOWS THE LEVOGRAPHIC ROTATION* OF THE TEMPORARY SYSTEM*; BOTH ROTATIONS CAN BE APPRECIATED IN FIGURE H0-A, AND THEIR COMPLEX BASIC INTERACTION IN THE 110-DGUAGE. MCJOR IN FIGURE H0-A, AND THEIR COMPLEX BASIC INTERACTION IN FIGURE 110-D.

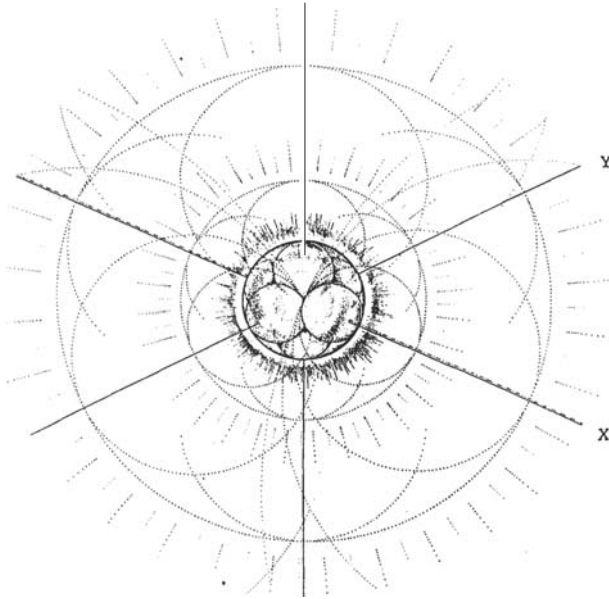


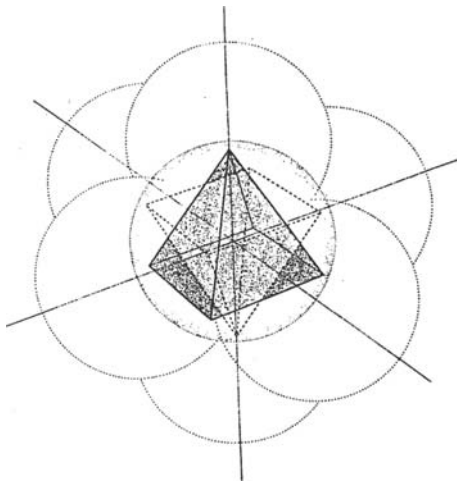
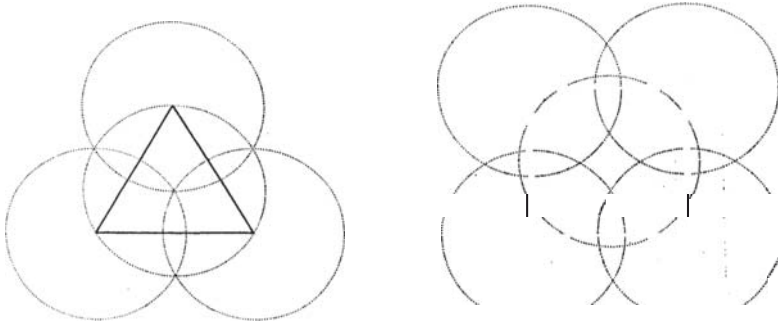
FIGURE 111

SCHEME U rIounA 110-B, ACTUALLY SHOWS WHAT HAPPENS IN THE FLAT HED OF FORCE LINES* V-HPLF*, (ref.104) WHEN THE UNIT OF ENERGY* IS INTEGRATED, OR WHEN ENERGY* IS CRYSTALIZED IN A TIMEW.

IN 1 "iGU17A 1.11 WE CAN OBSERVE THE SCHEME OF A NUCLEUS - V-1 - AND THEIR l?ROYECCION IN GEOMETRIC FUNCTION TOWARDS THEIR ENERGY/OltBITAL LEVELS* PONDERING*, AND FROM THERE TO INFINITY TO INFLUENCE THEIR UNIVERSE.

THE ENERGY UNIT* ASSOCIATES WITH OTHER UNITS TO BUILD COMPLEX CHISTALINE STRUCTURES, TO WHICH IT SUBSUMES ITS QUALITIES, OR ACTS AS THE POLAR CENTER OF ALL OF THEM, FIGURES 112-A, B and C - FIGURES 112-A, B and C

IF IT ACTS AS A POLAR CENTER, IT WILL HAVE TO MAINTAIN THE EQUILIBRIUM OF THE TEMPORAL SYSTEM* IN WHICH IT ACTS, SINCE ITS DEPO- SITION IN THIS FUNCTION MEANS THE DISARTICULATION AND DEGRADATION IN ITS TIME, WITH THE UNCONSCIOUS RESPONSIBILITY* THAT IS INCUMBENT UPON IT.



C

FIGURE 112

THE V-SIAL TIME SYSTEM*.
MANIFESTS ITSELF IN THE CENTER OF A CAPACITOR*.
THAT SUSTAINS ITS EXISTENCE WITHIN A MEMORY AND TIME EVIDENCED
IN THE COLORS OF THE LUMINOUS SCALE.
GLJONES* - STRONG INTERACTION OR STRENGTH OF COLOR - GLUBOLAS*

-

Hyperborean Physics: Fragments

1. For the gnostic “ the world ” that surrounds us is nothing more than the ordination of matter made by the Creator God, The One, in the beginning, and which we perceive in its temporal actuality. Hyperborean Wisdom, mother of gnostic thought goes further by claiming that space, and everything it contains, it is made up of multiple associations of a single element called “ archetypal quantum of energy ”, which constitutes a physical term of the archetypal monad, that is, of the absolute formative unit of the archetypal plane.

2. These quantum, which are true archetypal atoms, not formers or shape-structurers, each possess an indiscernible point by which the pantheistic diffusion of the Creator is realized. In other words, thanks to a specific system of polydimensional contact, the presence of the Demiurge becomes effective in every ponderable portion of matter, whatever its quality. This universal penetration, when verified by people in different degrees of confusion, has led to the erroneous belief that “ matter ” is the substance of The One. Such are the vulgar conceptions of pantheistic systems or those that allude to a “ Spirit of the World ” or “ Anima Mundi ”, etc. In reality matter has been “ ordered ” by the Creator and “ driven ” towards a legal development in time from whose evolutionary force not the slightest particle (escapes and from the which, of course, participates in the “ human body ”).

3. I have made this synthetic exposition of “ Hyperborean Physics ” because it is necessary to distinguish two degrees of determinism. The world, as I just described it, unfolds, mechanically, oriented towards a purpose; This is the first degree of determinism. In other words: there is a Plan whose guidelines are adjusted, and whose designs are set by the “ order ” of the world; the matter released into the mechanics of said “ order ” is determined in the first degree. But, as such a plan, it is sustained by the Will of the Creator, and His Presence is effective in every portion of matter, as we saw, it could happen that He, abnormally, influence in another way some portion of reality, either to teleologically modify its Plan or to express its intention semiotically, or for strategic reasons; in that case we are facing the second degree of determinism.

4. “ strategic reasons ” means the following: when the awakened man undertakes the Return to Origin within the framework of a Hyperborean Strategy, he uses secret techniques that allow him to effectively oppose the Plan. In these circumstances the Creator, abnormally, intervenes with all His Power to punish the intrepid.

From: "*Fundamentals of the Hyperborean Wisdom*"

5. What is an indiscernible point? Answer: a region of the NON-SPACIAL entity, that is, NON-COORDINABLE. And what is the essence of such a region, if it is not extensive, that is, it is not spatial? Answer: The essence of the indiscernible point is transcendent time, the Demiurge Consciousness that flows through all entities.

6. First of all, it should be clarified that the content of this sub-article is an extract from the “Gravis Theory” of Hyperborean Wisdom that has been developed in detail in the book “Hyperborean Physics”. Here we will only present the main aspects of the theory explained in a conceptual way, that is, stripped of all the complex mathematical foundation that is exhibited there.

7. It has been assumed that the “mass”, responsible for the gravitational field, “deforms” or “distorsiona” the space being necessary also, apart from the tension, differential and statistical calculation, appeal to “non-Euclidean geometries”. Thus complexity is added to complexity and it is possible to take an increasing distance from the phenomenon itself, from its facticity. Well, Hyperborean Wisdom provides an explanation of any different point, but one that perfectly understands the gravitational phenomenon and allows it to be mastered for the benefit of the Siddhas' strategic objectives.

8. The thesis is formulated as follows: THE GRAVITATORY FIELD IS THE POWER OF A PSYCHOIDAL ARCHETYPE.

9. Physics supposes, and supposes well, that a relationship links the mass with the gravitational field. Where he is wrong is, from Newton, in the affirmation that such a relationship is of cause and effect, that is, that the gravitational field occurs by the effect of mass; With such a misconception it is not strange to observe the enormous hulks that must be manufactured to take advantage of airspace. And naturally they, the manufacturers of flying pots with metal engines and “internal combustion”, they would doubt our sanity if we ensure that the Loyal Siddhas BASE IN THE ARCHETIPIC CONCEPT OF THE GRAVITY, have STONE vehicles, for example, to move to the site they want; and even more if we add that such vehicles do not have a motor. But it is not a delusion but “science”; ancient, extraterrestrial science.

10. The gravis is the heaviest “ heavy ”, it is worth the redundancy, of the psychoid archetypes and their action is directly related to the spatial form, that is, extensive, of matter and energy. So the gravis, which is the last on the scale, is also the first that the Demiurge precipitates when he prepares to “ organize ” a material plane, Without gravis no other Archetype could evolve in matter.

11. The gravis, in effect, IS THE ARCHETIPUS WHOSE PROCESS IS MORE VELOICE THAN ANY OTHER IN THE MATERIAL PLAN. This arises as a consequence of being “ the last of the archetypal ” scale and therefore, the one closest to the concrete matter, to which, precisely, he himself determines. The effect of the Gravis Archetype, of its potential entelechy, which some call “ gravitational field ”, is almost instantaneous: and that “ effect ” is nothing more than the procedural force with which the power of the Archetype directs matter, the “ mass ”, to evolve towards the entelechy or “ center of gravity ”.

12. THE POTENTIAL ENTELECHIA OF ARCHUETIPO GRAVIS SPACILY CONCIDES, IN THE SIMPLES BODIES, WITH THAT IDEAL POINT THAT THE PHYSIC HAS DENOMINATED “ CENTER OF GRAVEDAD ”.

13. Indeed the “ center of gravity ” is just a sash concept, an internal cultural object lacking concrete entity in the World: in the material entity what actually exists and manifests is a DIRECTION OF THE RECORDITATORY FORCE THAT APPEARS TO APPEAR ON A “ HYPOTETIC CENTER ” RADICATED IN ITS INTERIORITY; this is, a real tendency that induces reason to suppose the real existence of such a “ center ”: but the “ center of gravity ” itself, as the indiscernible points defined in E4, it can never really be reached FROM THE EXTERIORITY OF THE ENT.

14. The concept of gravis that is capable of tending to its entelechy by unfolding in the smallest particle of matter gives rise to an unorthodox atomic theory that has been exposed in the book Hyperborean physics and based on the definition of an “ archetypal atom ” or “ archetypal quantum ”.

15. It is worth reviewing, now, the two historical errors that we mentioned earlier. Newton's was to make the mass “ cause ” of the “ gravitational force ”, a force that, on the other hand, exists and is effectively proportional to the masses and inversely proportional to the square of the

distances that separate them, just as Coulomb demonstrated in electric charges and Cavendish measured him with his mass balance; the reality is that, although the “gravitational force” is mathematically related to mass, it is not its “cause” but, in turn, the mass is the concrete effect, the act, of an Archetype gravis. The “gravitational force” is thus the action of an archetypal power that proceeds from its entelechy and “attracts” towards its entelechy, which some call “center of gravity”.

16. Let's consider the second historical error. Leibniz, evidently thinking of a hyperborean God, who has nothing to do with the Demiurge computer of matter, the true “God” of this world, attributes to it absolute perfection, “perfectio Dei”, which “would prevent you from creating two equal things”. Thus, in modern philosophy and in later scientific thought, the “principium identitatis indiscernibilium”, the principle of identity of indiscernible things, prevails, which states that if two things are absolutely the same “they must be the same thing”. Furthermore, as this is manifestly impossible according to Leibniz, “there cannot be two equal things”: the Creator would not have repeated himself. All this reasoning is wrong because it is based on the assumption that the Universe has been created by a God of goodness and not by an imitating Demiurge, as it really happens. But, despite Leibniz, the work of the Demiurge is based on imitation and the material structure must naturally reflect this principle contradicting the principle identitatis indiscernibilium: it is easy to understand if we start from an archetypal composition of the real. However, the Leibniz principium has been dogmatically incorporated into epistemology and unconsciously predominates in every “scientific” attitude referring to empirical or experimental observation of physical phenomena; This is not accidental: it obeys a synarchic trend that is not appropriate to develop here. The important thing is that the Gravis Theory contradicts the principium; and it does so because such a principle is completely false. Hyperborean Wisdom states that “there can be two equal things” and points as an example to the potential entelechies of external entities, to their indiscernible nuclei, or to the “centers of gravity” determined by the Gravis Archetype.

17. Transcendent time, as a fluent process, also points to an entelechy, a super entelechy called “Future”. Indeed, the “Future” can only be conceived as an entelechy, as the final perfection of a cosmic process of Consciousness: the transcendent time, whose initium is The One, Brahma, or however you want to name the Demiurge, and whose end, the entelechy of Time, The Future, is The One, Brahma, or whatever you want to name the Demiurge.

18. The “transcendent time”, as we agreed in Part One, is “transcendent” for the microcosm, but, in truth, it is an immanent creep of Cosmic Consciousness, of the Soul of the Demiurge. And that Consciousness has produced the Archetypes whose processes concern us. From there, then,

from Time, transcendent time, everything real starts; and from there all interpretations of the real must also start; but it is not, already, of a mere “ dimension ”, as Physics claims, but of the essential support of everything that exists. Only after Time, after the transcendent time, “ space ” appears as an effect of the archetypal processes that develop in the planes of matter and energy.

19. By greatly simplifying the theory of Hyperborean Physics it can be concluded here that space is a “ second degree ” of transcendent time or a gross state of Time, a lower temporal category, a kind of “ time dropped ”, etc. The basis and justification for such a qualification comes from the fact that the space ONLY APPEARS IN RELATION TO THE MATTER, it is produced by it; but matter always follows the gravis process: it cannot escape its plasma power because the gravis CAEN, as specific entities of the last Archetype of the scale, from Cosmic Consciousness, that is, from transcendent time; observing the extremes of the process, it is evident that space is CAUSED by transcendent time through matter organized by gravis.

20. We have taken a great step. Let us now return to those questions about the potential entelechy and its coincidence with the “ center of gravity ”. If we apply the above concepts to the problem of the gravitational field, we will have to draw entirely different conclusions from those provided by Physics. Consider a field of great mass, Earth for example.

a – For Physics, around the Earth there is a gravitational field.

For Hyperborean Wisdom, the power of the Gravis Archetype acts around the Earth.

b – For Physics, the mass of the Earth deforms the space “ by curving it ” in its vicinity.

For Hyperborean Wisdom, the mass of the Earth generates a curved space that is a reflection of the distortion that the gravis represents with respect to transcendent Time.

c – For Physics, the “ center of gravity ” is located in the center of the Earth, where all the imaginary lines of force that describe the gravitational field converge.

For Hyperborean Wisdom, in the center of the Earth THERE IS A POINT THAT COINCIDES WITH THE CENTER OF GRAVITY: IT IS THE GRAVIS ENTELECHIA.

21. And, since the “ transcendent time ” is actually the Demiurge stream of consciousness, it is understood that in each entity, from the Indiscernible point, there is THE: There is the IMPULSING the process of the entity with its Wisdom Aspect, from the potential entelechy, and COMING the process of the entity with its Consciousness-Time Aspect, from the indiscernible point.

22. Above all, it is necessary to overcome the barrier of misunderstanding that reason will oppose when proposing apparent irreducible paradoxes. It should not be forgotten that we are facing a fearsome secret, which will not be easy to seize; at least not with impunity. The first obstacle is the problem, already examined in E4, that the Archetype maintains its absolute uniqueness while manifesting itself in the plurality of entities. That is: if the indiscernible points are all one and the same thing, how can they be in different entities at the same time?; If the indiscernible point of Earth is exactly the same as that of Venus, for example, how is it that millions of kilometers separate both planets? Answer: Of course, this occurs because the indiscernible points are “ potential entelechies ” of the Gravis Archetype:taking this into account it is understood that the distance that separates the planets has nothing to do with the indiscernible points since they finally coincide in the current future and no distance separates them into the present potential. And the same goes for any other entity that you want to consider.

23. IN THE INDISCERNIBLE NUCLEO OF EVERYTHING THE POTENTIAL ENTELECHIA OF HIS UNIVERSAL ARCHETY IS FOUND, WHICH IS INDISCERNIBLE FOR THE ENTELECHIA OF ANOTHER UNIVERSAL ARCHUETIPAL. This strange property, that resembles the indiscernible nucleus to a pure nothingness, has its cause in the imitative way with which the Demiurge has produced the universal Archetypes AS A REPLIC OF HIMSELF, OF YOUR “ ASPECTS ” ESSENTIAL: that's why there is only ONE ASSEMBLY AND TEN ARCHETIPES TAKEN WITH YOUR ASSEMBLY. This is important; “ neither nine nor eleven: ten Aspects of the One that determine the essence of all the entities of the Universe ”. “ And a monad, perfect image of the One, whose formal covering is the Gravis Archetype and whose ontic manifestation is the archetypal quantum; a single monad repeated everywhere in cosmic space, in every entity, in every being itself,in every indiscernible nucleus that, therefore, is indiscernible and identical to any other Archetype or to the ineffable One ”. The Archetypes are only ten, like the Aspects of One, but combined with many all make possible the enormous multiplicity of the entities.

24. But when things change it is when carrying out a similar examination of the gravis, or of any other potential entelechy, because then the observer must admit the reality of the indiscernible points: you will not be able to distinguish one gravis from another and, in your sight, DISAPPEAR THE PLURALITY OF THE ENTS TO LEAVE THE SINGULARITY OF THE ARCHETIPUS AND, AFTER IT, A LATERRIBLE FAZ OF DEMIURG. Naturally, many will laugh at this possibility, which they will describe as absurd: AND THEY WILL DO WELL TO REIG. If you are not prepared to face the Mystery, it is better that you laugh and remain ignorant, since there are countless WHO HAVE LOCKED IN FRONT OF THE REALITY OF

INDISCERNIBLE POINTS: there were “ mystics ”, for example, that suddenly they saw EYES IN ALL THINGS; or experimenters who viewed the world with expanded visual perception through some drugs and were horrified to see a LIVING COSMOS, provided with “ million eyes ” with which “ God observed them from all things ” (EX OMNI PART OCULATA). It is necessary to warn, therefore, about the insane danger that lurks in the being of every entity, in its universal term or purpose

25. In fact, the country is only given the knowledge of the entities from their exteriority: it can only DIALOGUE with nature or the world, take the design and put the meaning in the entity, but the being itself, the indiscernible point, the potential entelechy, must remain unknown to it. You will never know that “ has been constantly observed from all things ” by the Eye, one and multiple, of Abraxas.

26. On the contrary, virya is not only possible for the perception of being itself, but such an experience is part of the techniques of spiritual liberation. “ Outside of the real danger posed by such a confrontation with the Demiurge, in the path of strategic opposition this constitutes a calculated risk, to the extent that it is available in advance and has been included as part of the technique. The direct confrontation with the Demiurge allows, in effect, the domain of time, that is, to make the strategic area of the archhemone independent, of the transcendent time of the macrocosm: the creation of its own Time ”.

27. AND IN THAT INEVITABLE FACE, IN WHICH THE HYPERBOREAN WARRIOR AND THE DEMIURG FIGHT FACE, THE MOST DIFFICULT TEST TO BE AFRONTED BY THE WARRIOR WILL BE THE CONTEMPLATION OF THE TERRIBLE FACE OF DEMIURG. Of course, the Demiurge is an Actor with many Masks, but here we refer to ONE OF HIS ASPECTS: the one that can be perceived in the being itself of the entities, that is, in the heart of ALL the entities of the world, whom it sustains and vitalizes from the entelechy gravis; that Aspect that Hyperborean Wisdom calls DRAGON OF THE WORLD (DRACONIS MUNDI) and the Hebrew Kabbalah METATRON.

28. In the entelechy of gravis, from the indiscernible points that are in all bodies, that is, from the transcendent time that is His Consciousness, He is holding the material order. BUT HE DOES NOT ACT THROUGH THE GRAVIS. ONLY I FEEL THEM. IT IS NOT THE ASPECT ACHIEVEMENT THAT MATTERS IN THE INDISCERNIBLE POINTS BUT THE ASPECT CONSCIOUSNESS-TIME. IT IS NOT THE VERB BUT THE EYE OF DEMIURG. A

MULTIPLIC EYE INCANSABLY IN ALL CREATION BUT IT IS SIMPLE THE SAME EYE.

29. Let's look at some of such wonderful possibilities. He who has understood the Gravis Theory, for example, can SEARCH IN HIMSELF, in his microcosm the indiscernible point and, THROUGH THE THANKING WILL, DISPLACING THE CENTER OF GRAVITY OUTSIDE HIS BODY, AVOIDING THE WEIGHT, IS SAYING, THE TRACT THAT THE EARTH EXERTS ON HIS MASS: IT IS THE "LEVITATION". But, since its own indiscernible point is the same as that of that stone that is there, it will also be able to move it with an act of its will: it is the "psychokinesia". But, when a skillfully designed material body is led to coincide in its entelechy with that of a human body, then a vehicle "is available that travels without a motor", like those who have always manned Hyperboreans. And since at the indiscernible point there is spatial distortion, such vehicles may become invisible by "temporary acceleration" and not by "high vibrations" as argued by certain materialistic and sinarcas ufologists.

From a Letter from Nimrod de Rosario to Miguel Serrano

30. I wanted to give you a key, a « big key », and for that I am going to demonstrate the first statement (the second, about the Watson Nobel Prize, does not deserve further comment): You, you should know that Einstein failed to develop an acceptable mathematical theory to unify the phenomena « field » – gravitational and electromagnetic -; phenomena that, in any case, they are already unified in reality because those that are incompatible are theories. Regarding the gravitational field, outside of Newton's equations, everything that has been advanced in the last two centuries has been in the pointed sense, try to « unify it » with the electromagnetic field, for which there are Maxwell equations; thus by dealing with the gravitational field in the einsthenian sense - relativistic, it is necessary that we have a quite complex mathematical instrument called TENSOR, but if, for example, it is decided to interpret physical phenomena based on quantum mechanics, then we must resort to even more complex statistical formulas - probabilistic that require the use of electronic computers.

31. On the other hand, it has been assumed that the « mass » – responsible for the gravitational field - « deforms » or « distorsiona » the space being necessary as well, apart from tensor calculation, appeal to geometries not - euclidean. Thus complexity is added to complexity and it is possible to take an increasing distance from the phenomenon itself, from its facticity.

32. Well, Hyperborean Wisdom provides an explanation of every different point, but one that perfectly understands the gravitational phenomenon and allows it to be mastered for the benefit of the Siddhas' strategic objectives. And such an explanation does not require the use of formal mathematics except when you want to develop a technology, in which case an esoteric geometry is used that is entirely outside the academic environments of the West. The important thing about this – and this is where one begins to be surprised - is the intervention of concepts that have been clearly exposed by Jung and Pauli (1) and the affirmation that the deviation from theoretical physics is much deeper than is usually thought. Indeed, the boldest criticisms have generally been centralized over Einstein, Planck, Bohr, etc., but they have never questioned Newton. And from him the error started.

33. The explanation is as follows – and attention because an interrelation like this can be applied to almost any phenomenon other than the gravitational one - THE GRAVITATORY FIELD IS THE POWER OF A PSYCOIDING ARCHETIPUS.

34. Let us remember that for both the Neoplatonists, as for Leibniz, as well as for the Hindu science of the Great Breath, etc., there are GREAT SEVERALS in the archetypal manifestation. The subtlest Archetypes or monads are found in also more subtle planes, traversing an entire density scale until descending into matter, which is the grossest substance. No doubt you already know all this so it is not worth repeating it so that you understand me. The point is that there is an Archetype that is necessarily the last on the scale: such is the ARKETY GRAVIS (2). Gravis is the heaviest « heavy », worth the redundancy, of the Archetypes, but not « all » them, but of a special genus that is related to the SPACE ORDER OF THE MATTER. So the gravis, - which are the last of the scale -, they are also the first that the Demiurge precipitates when « is prepared to organize » a physical plane. Without gravis no other Archetype could evolve in matter.

35. But it is convenient to be clear in this: the Archetype of this glass that I have here, in my hand, is in Psychosphere – or in the Akasa Globe, according to the Science of the Breath -; such an Archetype is a STRUCTURER OF FORMS, that is, it supports form and form is its concrete actuality. The gravis, on the other hand, is there, in the glass, as a material substrate, and it is he who determines its weight in relation to other gravis that occupy space; Earth for example. The gravis IS NOT a STRUCTURER OF WAY, or is indifferent to the form itself, but, as a psychoid archetype, it has a power that leads it to unfold in an evolutionary process.

36. The culmination of any evolutionary process, in any psychoid archetype, is a perfection called entelechy, which, curiously, coincides with the Archetype itself. And here comes another definition of Hyperborean Wisdom, to which we will refer again later: THE ENTELECHIA OF A GRAVIS ARCHETIPUS SPACY COINCIDES IN THE SIMPLE BODIES WITH THAT IDEAL POINT THAT THE PHYSIC HAS DENOMINATED « CENTER OF GRAVITY ».

37. Let us remember what Dr. Jung said about the irrepressibility of Archetypes and we will understand why the « gravitational field » resists physiognathic analysis: let's take a material body and deposit it in space; away from Earth or any other planet; We say that the body has a « gravitational field » around it and we check it by observing how « attracts » towards its center of gravity – or entelechy - other objects of lesser mass. If the body is at rest we cannot describe its field; we only know about it for its effects on other bodies; THE FIELD, IF INVISIBLE, property equivalent to the irrepressibility of the Jungian Archetypes. But the field IS NOT the Archetype but HIS POWER, which tries to update itself in the entelechy. Matter is always a concrete act of gravis in its evolutionary unfolding, regardless of the form such matter exhibits. But that, the perception of matter is everything we can know about gravis because it is pure power, it is a « to become » (its entelechy) and that is why we say allegorically that « is hidden » behind matter. If we violate the intimacy of the process, if we invade the field and delve into the matter to find the « center of gravity », the entelechy, we will never find anything. Without matter there is no gravis, but if we break it and multiply we will have many POTENTIAL gravis. if we invade the field and delve into the matter to find the « center of gravity », the entelechy, we will never find anything. Without matter there is no gravis, but if we break it and multiply we will have many POTENTIAL gravis. if we invade the field and delve into the matter to find the « center of gravity », the entelechy, we will never find anything. Without matter there is no gravis, but if we break it and multiply we will have many POTENTIAL gravis.

38. This topic that we have touched on is a point of capital importance and, before answering the questions raised, we are going to clarify that other error that we mentioned at the beginning: Leibniz, evidently thinking of a hyperborean God, who has nothing to do with the Demiurge computer of matter, he attributes to him absolute perfection, perfect Dei, that « would prevent you from creating two equal things ».

39. Every Archetype tends towards its entelechy. But at the origin of the movement, the first impulse was produced by a power that contained within itself the perfection that is intended to be achieved; movement is thus an evolutionary development that aims at a purpose that has also been the beginning. As a purpose, entelechy is something that « is not yet », which must be reached, that is, something « future ». We now come to the most complex part of the problem:

entelechy is something « future » that works in the present AS A POSSIBILITY TO BE. Since the only connection between the entelechy of a thing and the concrete thing is the PROCESS of the Archetype, this process is the true possibility that an entelechy is. But EVERYTHING process occurs in Time.

40. Time as a flowing process points, then, also to an entelechy, a super-entelechy called FUTURE. Indeed, the « Future » can only be conceived as an entelechy, as the final perfection of a cosmic process of consciousness – Time - whose initium is The One, Brahma, or whatever you want to call the Demiurge, and whose end, the entelechy of Time, the Future, is The One, Brahma or whatever you want to call the Demiurge.

41. Time is an immanent influx of Cosmic Consciousness. And that consciousness has produced the Archetypes whose processes reveal us. From there, then, from Time, everything starts and we are not in the presence of a physical « dimension » but of the essential support of the existing whole. Then, secondly « the » space « appears, through archetypal processes in the different states of matter and energy. It is not entirely correct to do so, or at least would require prior clarification, but space can be considered as a « second degree » of Time or as a gross state of Time, a lower category or a « Fallen time ». The foundation and justification for such a qualification comes from the fact that the space ONLY APPEARS in relation to matter, is produced by it; but to matter ALWAYS FOLLOWS THE PROCESS OF THE GRAVIS, it cannot escape its plasma power since gravis « falls » – are the last Archetypes of the scale - from Cosmic Consciousness, that is, from Time.

42. We go back to the beginning. But now we can understand it: there is spatial coincidence but NOT TEMPORAL; there cannot be because the entelechy is THE FUTURE ASPECT OF THE ARCHETIPO GRAVIS. ¿What can be expected, then, from the « center of gravity », according to Psychophysics?: AN INDISCERNIBLE POINT, that is, a point that contradicts the Leibniz principle identitatis indiscernibilium occurs like this because the entelechy, as the final perfection of the Archetype, IS THE ARCHETIPUS OF THE SAME: SINCE THE ENTELECHIA GRAVIS PROMOTES A PROCESS THAT CANNOT BE INTERRUPTED AND THAT GOES FROM POWER (gravitational field) UNTIL THE ENTELECHIA (center of gravity) THAT IS IN THE FUTURE; YOUR PROCESSUAL WAY OPENS A GAP IN SPACE, « DISTORSION », PRODUCING A TOPOLOGICAL CONTACT BETWEEN DIFFERENT PLANS. Strictly speaking, what happens in the « indiscernible point » is that the entelechy « regenerates » a point in space transforming it into time; what « elevates » if you like.

43. Why indiscernible? For something to be indiscernible it must be able to be compared with something exactly the same with absolute equality, that is: that it occupies the same place and occurs at the same time: there must be simultaneous coincidence for now; Only then would we be in a position to declare that something is indiscernible. Well, and here I think I am touching one of the Greatest Mysteries that exist: THE ENTELEQUIES OF ALL GRAVIS ARE INDISCERNIBLE. In other words: IN ALL BODIES, DO NOT CARE YOUR SIZE, THERE IS AN INDISCERNIBLE POINT.

44. Unfortunately – for the Demiurge - we are not « Mystics » and we are not impressed by His dreadful multiplicity and, although he looks at us permanently and permanently from everywhere, it will not achieve any other effect than affirming ourselves on the reverse path of return to origin. After this luciferic bravado, I continue.

45. The gravis theory, and its consequence: the indiscernible points, based on the concepts of Jung and Pauli, allow, apart from building flying plates or lifting stones of a thousand tons, explain almost all parapsychological phenomena and thaumaturgy or magic of any kind, excluding only all phenomena other than « force fields », that is, what we call charismatic, for which there is another theory.

46. In various parts of my book, I wrote that whenever a secret path of liberation is followed, of the seven proposed by Hyperborean Wisdom, There will be some time when there will be a confrontation with the Demiurge and that contemplating his terrible Face can be dangerous if he does not possess a value without limits. Now it is clear what I meant. In the entelechy of gravis, from the indiscernible points that are in all bodies, that is, from the Time that is His Consciousness, He is holding the material order.

47. BUT HE DOES NOT ACT THROUGH THE GRAVIS. ONLY YOU FEEL IT. IT IS NOT THE ASPECT LOGO THAT MATTERS IN THE INDISCERNIBLE POINTS BUT THE ASPECT CONSCIOUSNESS (TIME). IT IS NOT THE VERB BUT THE EYE OF DEMIURG. A MULTIPLICATED EYE INFINITELY IN ALL CREATION BUT IT IS ALWAYS THE SAME EYE. THERE IS MAY. AN EYE THAT CONTEMPLATES ITSELF, THAT IS PERPETUALLY ADMED FROM ITSELF.

48. You can also, through the indiscernible points, perform a bilocation, trilocation or polylocation ... as long as you proceed before « close the eyelid », extend a membrane that covers Abraxas' eye, that is, capture a sign that prevents His Look, lover and murderer, from perching on the one who has dared to look out into the abyss.

